



Full wwPDB X-ray Structure Validation Report ⓘ

Jan 20, 2024 – 03:42 pm GMT

PDB ID : 6ZSR
Title : Crystal structure of the Cisplatin beta-Lactoglobulin adduct formed after 72 h of soaking
Authors : Balasco, N.; Ferraro, G.; Merlino, A.
Deposited on : 2020-07-16
Resolution : 2.00 Å(reported)

This is a Full wwPDB X-ray Structure Validation Report for a publicly released PDB entry.

We welcome your comments at validation@mail.wwpdb.org

A user guide is available at

<https://www.wwpdb.org/validation/2017/XrayValidationReportHelp>

with specific help available everywhere you see the ⓘ symbol.

The types of validation reports are described at

<http://www.wwpdb.org/validation/2017/FAQs#types>.

The following versions of software and data (see [references ⓘ](#)) were used in the production of this report:

MolProbity : 4.02b-467
Mogul : 1.8.4, CSD as541be (2020)
Xtriage (Phenix) : 1.13
EDS : 2.36
buster-report : 1.1.7 (2018)
Percentile statistics : 20191225.v01 (using entries in the PDB archive December 25th 2019)
Refmac : 5.8.0158
CCP4 : 7.0.044 (Gargrove)
Ideal geometry (proteins) : Engh & Huber (2001)
Ideal geometry (DNA, RNA) : Parkinson et al. (1996)
Validation Pipeline (wwPDB-VP) : 2.36

1 Overall quality at a glance

The following experimental techniques were used to determine the structure:

X-RAY DIFFRACTION

The reported resolution of this entry is 2.00 Å.

Percentile scores (ranging between 0-100) for global validation metrics of the entry are shown in the following graphic. The table shows the number of entries on which the scores are based.

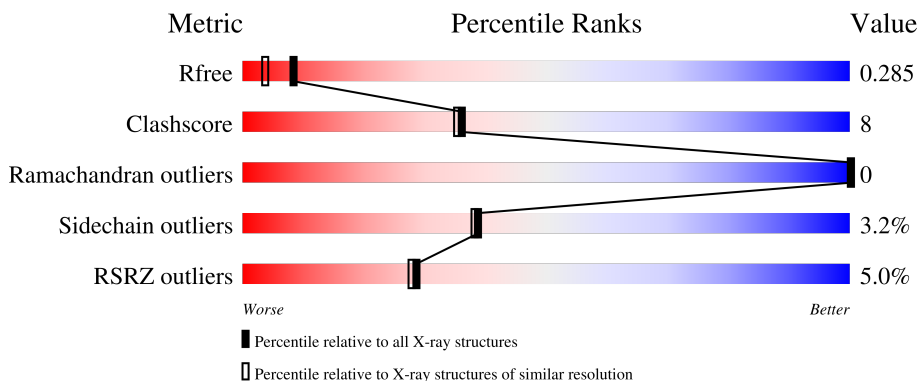

Metric	Whole archive (#Entries)	Similar resolution (#Entries, resolution range(Å))
R_{free}	130704	8085 (2.00-2.00)
Clashscore	141614	9178 (2.00-2.00)
Ramachandran outliers	138981	9054 (2.00-2.00)
Sidechain outliers	138945	9053 (2.00-2.00)
RSRZ outliers	127900	7900 (2.00-2.00)

The table below summarises the geometric issues observed across the polymeric chains and their fit to the electron density. The red, orange, yellow and green segments of the lower bar indicate the fraction of residues that contain outliers for ≥ 3 , 2, 1 and 0 types of geometric quality criteria respectively. A grey segment represents the fraction of residues that are not modelled. The numeric value for each fraction is indicated below the corresponding segment, with a dot representing fractions $\leq 5\%$. The upper red bar (where present) indicates the fraction of residues that have poor fit to the electron density. The numeric value is given above the bar.

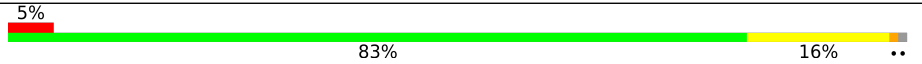
Mol	Chain	Length	Quality of chain
1	AAA	162	 5% 78% 21% .
1	BBB	162	 5% 83% 16% ..

2 Entry composition [i](#)

There are 5 unique types of molecules in this entry. The entry contains 2797 atoms, of which 0 are hydrogens and 0 are deuteriums.

In the tables below, the ZeroOcc column contains the number of atoms modelled with zero occupancy, the AltConf column contains the number of residues with at least one atom in alternate conformation and the Trace column contains the number of residues modelled with at most 2 atoms.

- Molecule 1 is a protein called Beta-lactoglobulin.

Mol	Chain	Residues	Atoms					ZeroOcc	AltConf	Trace
			Total	C	N	O	S			
1	AAA	162	1301	830	210	252	9	0	3	0
1	BBB	161	1287	819	208	251	9	0	2	0

- Molecule 2 is AMMONIA (three-letter code: NH3) (formula: H₃N) (labeled as "Ligand of Interest" by depositor).

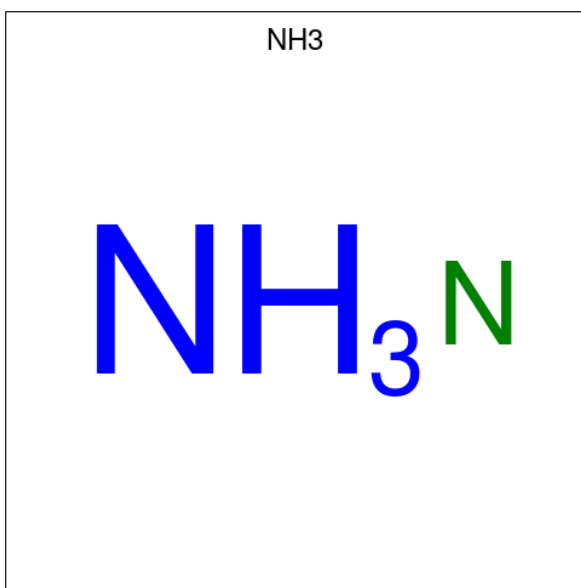

Mol	Chain	Residues	Atoms		ZeroOcc	AltConf
2	AAA	1	Total	N	0	0
			1	1		
2	BBB	1	Total	N	0	0
			1	1		

- Molecule 3 is PLATINUM (II) ION (three-letter code: PT) (formula: Pt) (labeled as "Ligand of Interest" by depositor).

Mol	Chain	Residues	Atoms		ZeroOcc	AltConf
3	AAA	2	Total	Pt	0	1
			2	2		
3	BBB	3	Total	Pt	0	2
			4	4		

- Molecule 4 is SULFATE ION (three-letter code: SO4) (formula: O₄S).



Mol	Chain	Residues	Atoms			ZeroOcc	AltConf
4	BBB	1	Total	O	S	0	0
			5	4	1		
4	BBB	1	Total	O	S	0	0
			5	4	1		

- Molecule 5 is water.

Mol	Chain	Residues	Atoms		ZeroOcc	AltConf
5	AAA	108	Total	O	0	5
			108	108		
5	BBB	83	Total	O	0	1
			83	83		

3 Residue-property plots [i](#)

These plots are drawn for all protein, RNA, DNA and oligosaccharide chains in the entry. The first graphic for a chain summarises the proportions of the various outlier classes displayed in the second graphic. The second graphic shows the sequence view annotated by issues in geometry and electron density. Residues are color-coded according to the number of geometric quality criteria for which they contain at least one outlier: green = 0, yellow = 1, orange = 2 and red = 3 or more. A red dot above a residue indicates a poor fit to the electron density ($RSRZ > 2$). Stretches of 2 or more consecutive residues without any outlier are shown as a green connector. Residues present in the sample, but not in the model, are shown in grey.

- Molecule 1: Beta-lactoglobulin

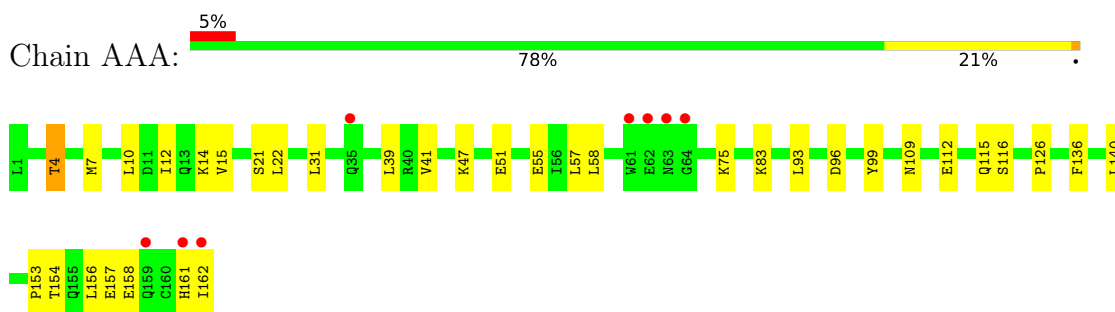

- Molecule 1: Beta-lactoglobulin

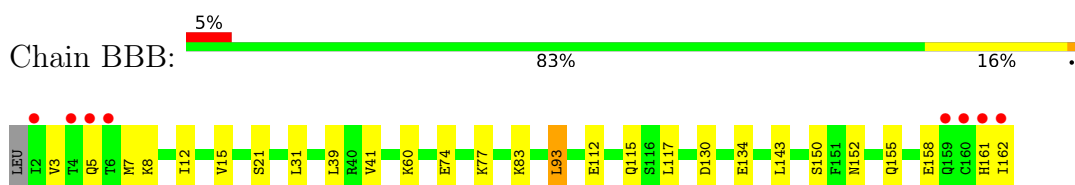

4 Data and refinement statistics

Property	Value	Source
Space group	P 1	Depositor
Cell constants a, b, c, α , β , γ	37.62Å 48.80Å 49.18Å 70.27° 68.49° 76.99°	Depositor
Resolution (Å)	23.30 – 2.00 23.28 – 2.00	Depositor EDS
% Data completeness (in resolution range)	76.6 (23.30-2.00) 76.7 (23.28-2.00)	Depositor EDS
R_{merge}	0.08	Depositor
R_{sym}	(Not available)	Depositor
$\langle I/\sigma(I) \rangle$ ¹	4.33 (at 2.01Å)	Xtrriage
Refinement program	REFMAC 5.8.0258	Depositor
R, R_{free}	0.198 , 0.283 0.201 , 0.285	Depositor DCC
R_{free} test set	782 reflections (5.00%)	wwPDB-VP
Wilson B-factor (Å ²)	18.6	Xtrriage
Anisotropy	0.259	Xtrriage
Bulk solvent k_{sol} (e/Å ³), B_{sol} (Å ²)	0.38 , 44.5	EDS
L-test for twinning ²	$\langle L \rangle = 0.46$, $\langle L^2 \rangle = 0.28$	Xtrriage
Estimated twinning fraction	No twinning to report.	Xtrriage
F_o, F_c correlation	0.93	EDS
Total number of atoms	2797	wwPDB-VP
Average B, all atoms (Å ²)	24.0	wwPDB-VP

Xtrriage's analysis on translational NCS is as follows: *The largest off-origin peak in the Patterson function is 10.09% of the height of the origin peak. No significant pseudotranslation is detected.*

¹Intensities estimated from amplitudes.

²Theoretical values of $\langle |L| \rangle$, $\langle L^2 \rangle$ for acentric reflections are 0.5, 0.333 respectively for untwinned datasets, and 0.375, 0.2 for perfectly twinned datasets.

5 Model quality

5.1 Standard geometry

Bond lengths and bond angles in the following residue types are not validated in this section: SO4, NH3, PT

The Z score for a bond length (or angle) is the number of standard deviations the observed value is removed from the expected value. A bond length (or angle) with $|Z| > 5$ is considered an outlier worth inspection. RMSZ is the root-mean-square of all Z scores of the bond lengths (or angles).

Mol	Chain	Bond lengths		Bond angles	
		RMSZ	# Z >5	RMSZ	# Z >5
1	AAA	0.69	0/1325	0.85	0/1791
1	BBB	0.70	0/1308	0.86	0/1769
All	All	0.69	0/2633	0.86	0/3560

There are no bond length outliers.

There are no bond angle outliers.

There are no chirality outliers.

There are no planarity outliers.

5.2 Too-close contacts

In the following table, the Non-H and H(model) columns list the number of non-hydrogen atoms and hydrogen atoms in the chain respectively. The H(added) column lists the number of hydrogen atoms added and optimized by MolProbity. The Clashes column lists the number of clashes within the asymmetric unit, whereas Symm-Clashes lists symmetry-related clashes.

Mol	Chain	Non-H	H(model)	H(added)	Clashes	Symm-Clashes
1	AAA	1301	0	1328	26	0
1	BBB	1287	0	1301	16	0
2	AAA	1	0	0	1	0
2	BBB	1	0	0	0	0
3	AAA	2	0	0	0	0
3	BBB	4	0	0	0	0
4	BBB	10	0	0	1	0
5	AAA	108	0	0	2	0
5	BBB	83	0	0	1	0
All	All	2797	0	2629	42	0

The all-atom clashscore is defined as the number of clashes found per 1000 atoms (including

hydrogen atoms). The all-atom clashscore for this structure is 8.

All (42) close contacts within the same asymmetric unit are listed below, sorted by their clash magnitude.

Atom-1	Atom-2	Interatomic distance (Å)	Clash overlap (Å)
1:AAA:154:THR:O	1:AAA:158:GLU:HG2	1.82	0.78
1:BBB:41:VAL:HG12	1:BBB:60:LYS:HD3	1.65	0.78
1:AAA:154:THR:O	1:AAA:158:GLU:CG	2.44	0.64
1:AAA:7:MET:CE	1:AAA:10:LEU:HD13	2.28	0.63
1:AAA:21:SER:O	1:AAA:161:HIS:HE1	1.83	0.61
1:AAA:7:MET:HE3	1:AAA:10:LEU:HB2	1.87	0.56
1:BBB:21:SER:O	1:BBB:161:HIS:HE1	1.90	0.55
1:AAA:14[B]:LYS:HB2	1:AAA:99:TYR:CD1	2.42	0.54
1:AAA:31:LEU:HD22	1:AAA:39:LEU:HD22	1.90	0.53
1:AAA:41:VAL:HB	1:AAA:58:LEU:HD13	1.90	0.52
1:AAA:47:LYS:HB2	1:AAA:55:GLU:HB2	1.91	0.52
1:AAA:109:ASN:N	1:AAA:116:SER:OG	2.39	0.51
1:AAA:12:ILE:O	1:AAA:15:VAL:HG22	2.10	0.51
1:BBB:155:GLN:O	1:BBB:161:HIS:HA	2.11	0.51
1:BBB:93:LEU:HD22	1:BBB:93:LEU:N	2.25	0.51
1:BBB:31:LEU:HD22	1:BBB:39:LEU:HD22	1.94	0.50
1:BBB:155:GLN:HA	1:BBB:162:ILE:CD1	2.42	0.49
1:AAA:158:GLU:HG3	1:AAA:162:ILE:HG23	1.95	0.49
1:AAA:161:HIS:O	1:AAA:162:ILE:CG1	2.61	0.48
1:BBB:3:VAL:HG22	1:BBB:143:LEU:HD22	1.95	0.48
1:BBB:161:HIS:O	5:BBB:301:HOH:O	2.20	0.48
1:BBB:41:VAL:CG1	1:BBB:60:LYS:HD3	2.41	0.48
1:AAA:126:PRO:HB2	1:AAA:157:GLU:HG2	1.97	0.46
1:AAA:153:PRO:HG3	5:AAA:361:HOH:O	2.15	0.46
1:AAA:7:MET:CE	1:AAA:10:LEU:CD1	2.94	0.46
1:AAA:161:HIS:O	1:AAA:162:ILE:HG12	2.15	0.46
1:AAA:112:GLU:OE1	1:AAA:112:GLU:HA	2.16	0.45
1:AAA:112:GLU:HG3	1:AAA:115[A]:GLN:HG2	1.98	0.45
1:AAA:4:THR:HA	5:AAA:317:HOH:O	2.17	0.45
1:AAA:136:PHE:CZ	1:AAA:140:LEU:HD21	2.52	0.44
1:AAA:22:LEU:HA	1:AAA:156:LEU:HD21	2.00	0.43
1:BBB:12:ILE:O	1:BBB:15:VAL:HG22	2.19	0.43
1:AAA:57:LEU:N	1:AAA:57:LEU:HD23	2.35	0.42
1:BBB:112:GLU:HG3	1:BBB:115:GLN:HB2	2.02	0.42
1:BBB:74:GLU:HB2	1:BBB:83:LYS:HG3	2.01	0.42
1:BBB:152:ASN:H	1:BBB:155:GLN:HE21	1.65	0.42
1:BBB:3:VAL:HG21	1:BBB:117:LEU:HD22	2.01	0.42
1:AAA:7:MET:HE1	1:AAA:10:LEU:CD1	2.50	0.42

Continued on next page...

Continued from previous page...

Atom-1	Atom-2	Interatomic distance (Å)	Clash overlap (Å)
1:AAA:96:ASP:OD1	2:AAA:201:NH3:N	2.53	0.41
1:AAA:51:GLU:O	1:AAA:75:LYS:NZ	2.41	0.41
1:BBB:130:ASP:O	1:BBB:134:GLU:HG3	2.20	0.41
1:BBB:77:LYS:N	4:BBB:203:SO4:O2	2.53	0.41

There are no symmetry-related clashes.

5.3 Torsion angles [i](#)

5.3.1 Protein backbone [i](#)

In the following table, the Percentiles column shows the percent Ramachandran outliers of the chain as a percentile score with respect to all X-ray entries followed by that with respect to entries of similar resolution.

The Analysed column shows the number of residues for which the backbone conformation was analysed, and the total number of residues.

Mol	Chain	Analysed	Favoured	Allowed	Outliers	Percentiles	
1	AAA	163/162 (101%)	152 (93%)	11 (7%)	0	100	100
1	BBB	161/162 (99%)	150 (93%)	11 (7%)	0	100	100
All	All	324/324 (100%)	302 (93%)	22 (7%)	0	100	100

There are no Ramachandran outliers to report.

5.3.2 Protein sidechains [i](#)

In the following table, the Percentiles column shows the percent sidechain outliers of the chain as a percentile score with respect to all X-ray entries followed by that with respect to entries of similar resolution.

The Analysed column shows the number of residues for which the sidechain conformation was analysed, and the total number of residues.

Mol	Chain	Analysed	Rotameric	Outliers	Percentiles	
1	AAA	146/143 (102%)	143 (98%)	3 (2%)	53	57
1	BBB	144/143 (101%)	137 (95%)	7 (5%)	25	21
All	All	290/286 (101%)	280 (97%)	10 (3%)	39	36

All (10) residues with a non-rotameric sidechain are listed below:

Mol	Chain	Res	Type
1	AAA	4	THR
1	AAA	83	LYS
1	AAA	93	LEU
1	BBB	5	GLN
1	BBB	7	MET
1	BBB	8	LYS
1	BBB	93	LEU
1	BBB	150[A]	SER
1	BBB	150[B]	SER
1	BBB	158	GLU

Sometimes sidechains can be flipped to improve hydrogen bonding and reduce clashes. There are no such sidechains identified.

5.3.3 RNA [i](#)

There are no RNA molecules in this entry.

5.4 Non-standard residues in protein, DNA, RNA chains [i](#)

There are no non-standard protein/DNA/RNA residues in this entry.

5.5 Carbohydrates [i](#)

There are no monosaccharides in this entry.

5.6 Ligand geometry [i](#)

Of 10 ligands modelled in this entry, 2 are modelled with single atom and 6 are monoatomic - leaving 2 for Mogul analysis.

In the following table, the Counts columns list the number of bonds (or angles) for which Mogul statistics could be retrieved, the number of bonds (or angles) that are observed in the model and the number of bonds (or angles) that are defined in the Chemical Component Dictionary. The Link column lists molecule types, if any, to which the group is linked. The Z score for a bond length (or angle) is the number of standard deviations the observed value is removed from the expected value. A bond length (or angle) with $|Z| > 2$ is considered an outlier worth inspection. RMSZ is the root-mean-square of all Z scores of the bond lengths (or angles).

Mol	Type	Chain	Res	Link	Bond lengths			Bond angles		
					Counts	RMSZ	# Z > 2	Counts	RMSZ	# Z > 2
4	SO4	BBB	202	-	4,4,4	0.37	0	6,6,6	0.20	0
4	SO4	BBB	203	-	4,4,4	0.36	0	6,6,6	0.12	0

There are no bond length outliers.

There are no bond angle outliers.

There are no chirality outliers.

There are no torsion outliers.

There are no ring outliers.

1 monomer is involved in 1 short contact:

Mol	Chain	Res	Type	Clashes	Symm-Clashes
4	BBB	203	SO4	1	0

5.7 Other polymers [i](#)

There are no such residues in this entry.

5.8 Polymer linkage issues [i](#)

There are no chain breaks in this entry.

6 Fit of model and data [i](#)

6.1 Protein, DNA and RNA chains [i](#)

In the following table, the column labelled ‘#RSRZ > 2’ contains the number (and percentage) of RSRZ outliers, followed by percent RSRZ outliers for the chain as percentile scores relative to all X-ray entries and entries of similar resolution. The OWAB column contains the minimum, median, 95th percentile and maximum values of the occupancy-weighted average B-factor per residue. The column labelled ‘Q < 0.9’ lists the number of (and percentage) of residues with an average occupancy less than 0.9.

Mol	Chain	Analysed	<RSRZ>	#RSRZ>2	OWAB(Å ²)	Q<0.9
1	AAA	162/162 (100%)	0.04	8 (4%) 29 28	8, 17, 53, 65	0
1	BBB	161/162 (99%)	0.15	8 (4%) 28 28	10, 21, 70, 96	0
All	All	323/324 (99%)	0.10	16 (4%) 28 28	8, 19, 60, 96	0

All (16) RSRZ outliers are listed below:

Mol	Chain	Res	Type	RSRZ
1	BBB	5	GLN	6.4
1	BBB	159	GLN	5.9
1	BBB	162	ILE	5.4
1	AAA	61	TRP	4.4
1	BBB	4	THR	3.8
1	BBB	161	HIS	3.4
1	AAA	63	ASN	3.3
1	AAA	62	GLU	3.2
1	AAA	162	ILE	3.2
1	AAA	161	HIS	3.0
1	BBB	2	ILE	2.8
1	BBB	160	CYS	2.8
1	AAA	64	GLY	2.6
1	AAA	35	GLN	2.4
1	BBB	6	THR	2.3
1	AAA	159	GLN	2.1

6.2 Non-standard residues in protein, DNA, RNA chains [i](#)

There are no non-standard protein/DNA/RNA residues in this entry.

6.3 Carbohydrates [i](#)

There are no monosaccharides in this entry.

6.4 Ligands [i](#)

In the following table, the Atoms column lists the number of modelled atoms in the group and the number defined in the chemical component dictionary. The B-factors column lists the minimum, median, 95th percentile and maximum values of B factors of atoms in the group. The column labelled 'Q< 0.9' lists the number of atoms with occupancy less than 0.9.

Mol	Type	Chain	Res	Atoms	RSCC	RSR	B-factors(Å ²)	Q<0.9
2	NH3	BBB	201	1/1	0.85	0.54	25,25,25,25	1
3	PT	BBB	204[A]	1/1	0.88	0.11	66,66,66,66	1
3	PT	BBB	204[B]	1/1	0.88	0.11	61,61,61,61	1
2	NH3	AAA	201	1/1	0.91	0.24	24,24,24,24	1
4	SO4	BBB	203	5/5	0.91	0.26	43,47,52,52	0
4	SO4	BBB	202	5/5	0.95	0.10	50,51,57,59	0
3	PT	BBB	205[A]	1/1	0.95	0.09	42,42,42,42	1
3	PT	AAA	203[A]	1/1	0.96	0.06	32,32,32,32	1
3	PT	AAA	202	1/1	0.99	0.03	36,36,36,36	1
3	PT	BBB	206	1/1	0.99	0.03	36,36,36,36	1

The following is a graphical depiction of the model fit to experimental electron density of all instances of the Ligand of Interest. In addition, ligands with molecular weight > 250 and outliers as shown on the geometry validation Tables will also be included. Each fit is shown from different orientation to approximate a three-dimensional view.

Electron density around NH3 BBB 201:

$2mF_o-DF_c$ (at 0.7 rmsd) in gray
 mF_o-DF_c (at 3 rmsd) in purple (negative)
and green (positive)

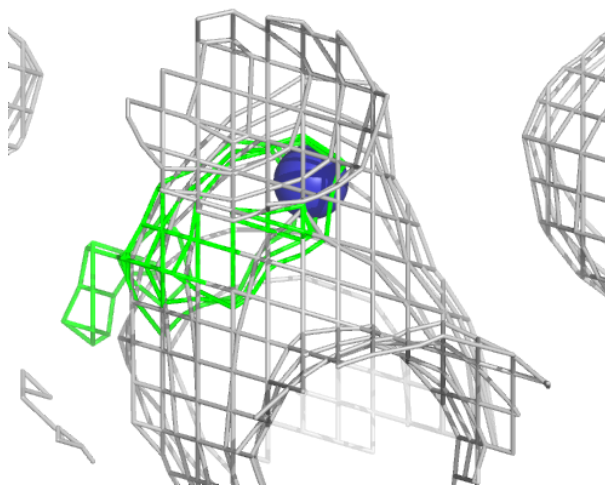
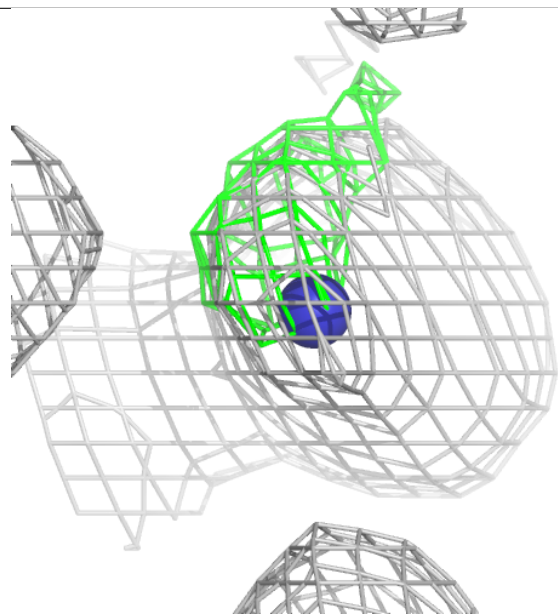
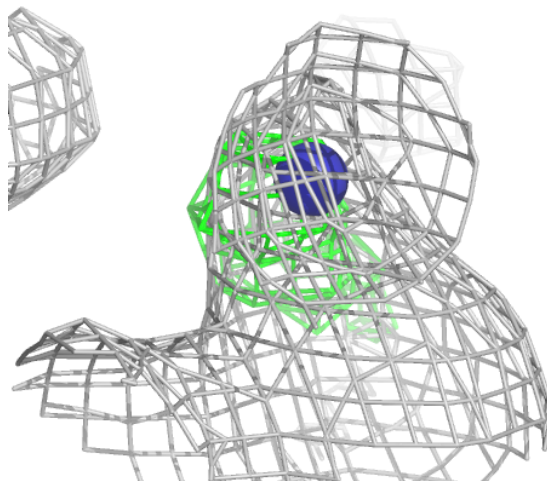

Electron density around PT BBB 204 (A):

$2mF_o-DF_c$ (at 0.7 rmsd) in gray
 mF_o-DF_c (at 3 rmsd) in purple (negative)
and green (positive)

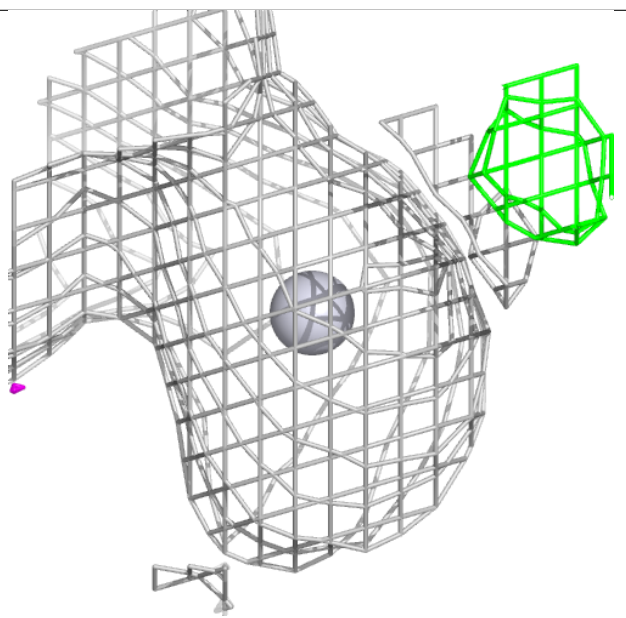
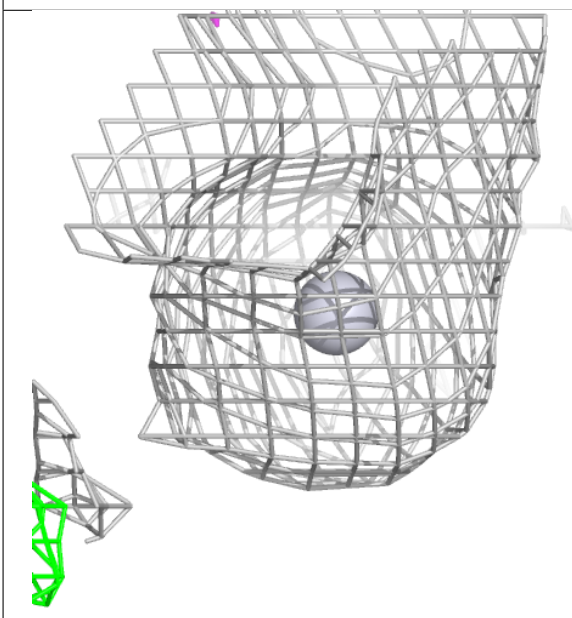
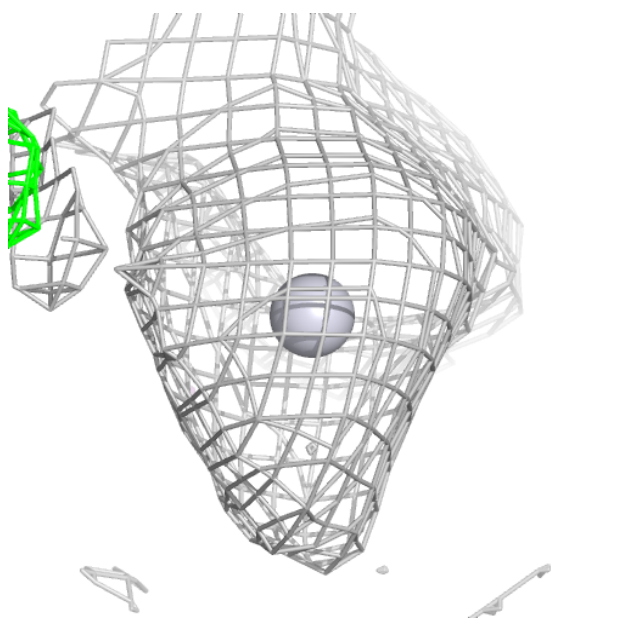

Electron density around PT BBB 204 (B):

$2mF_o-DF_c$ (at 0.7 rmsd) in gray
 mF_o-DF_c (at 3 rmsd) in purple (negative)
and green (positive)

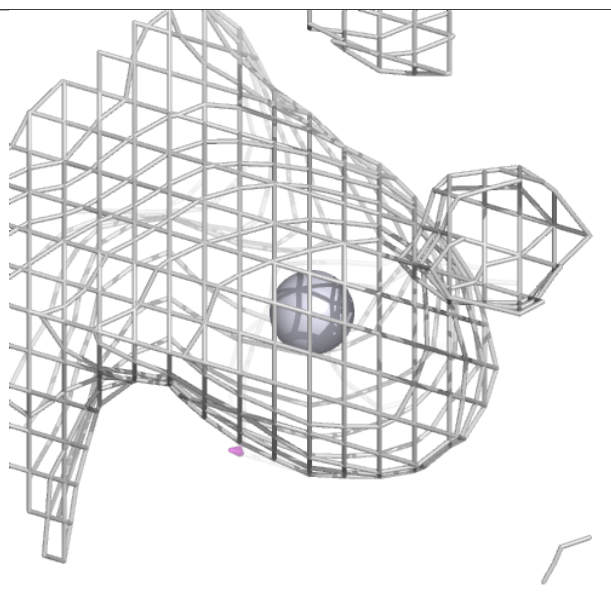
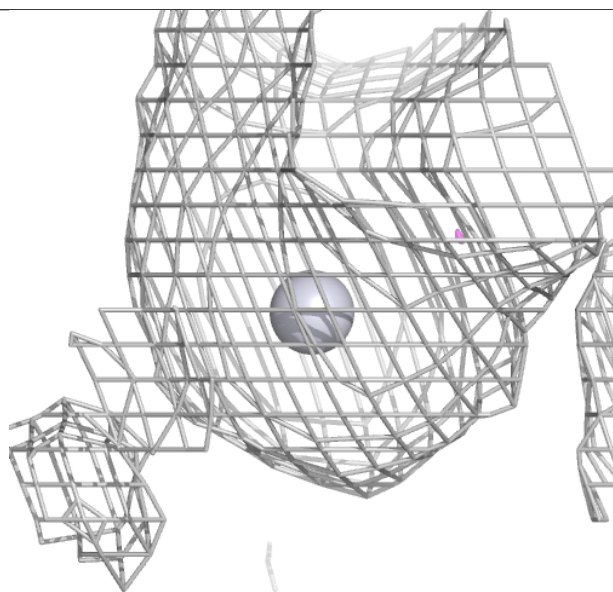
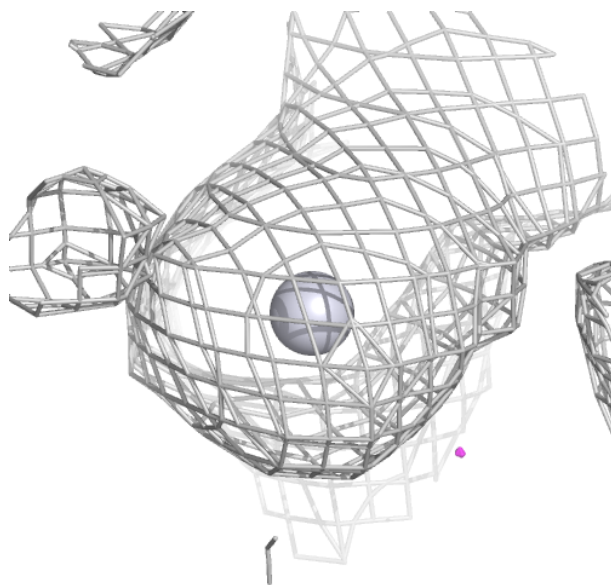

Electron density around NH3 AAA 201:

$2mF_o-DF_c$ (at 0.7 rmsd) in gray
 mF_o-DF_c (at 3 rmsd) in purple (negative)
and green (positive)

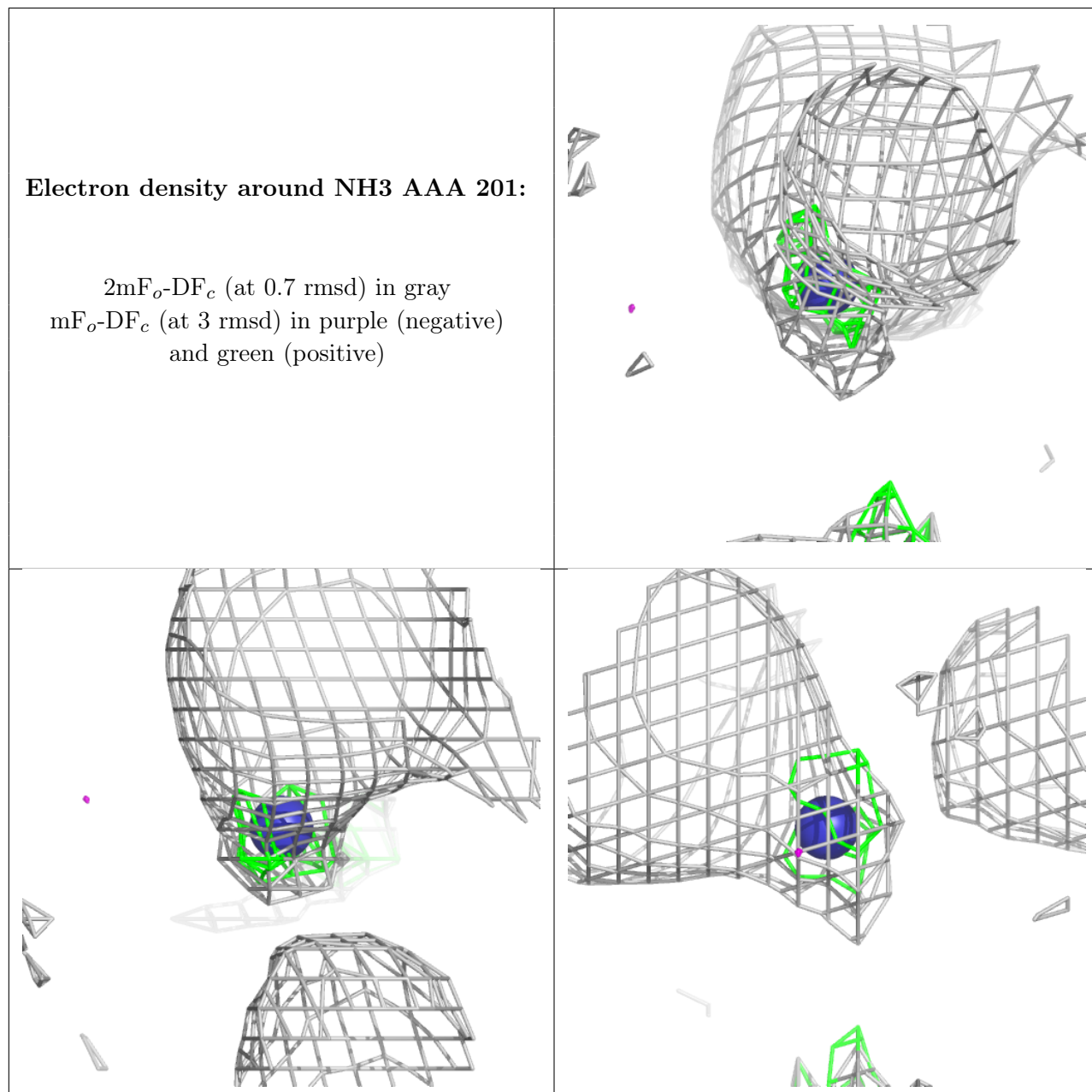

Electron density around PT BBB 205 (A):

$2mF_o-DF_c$ (at 0.7 rmsd) in gray
 mF_o-DF_c (at 3 rmsd) in purple (negative)
and green (positive)

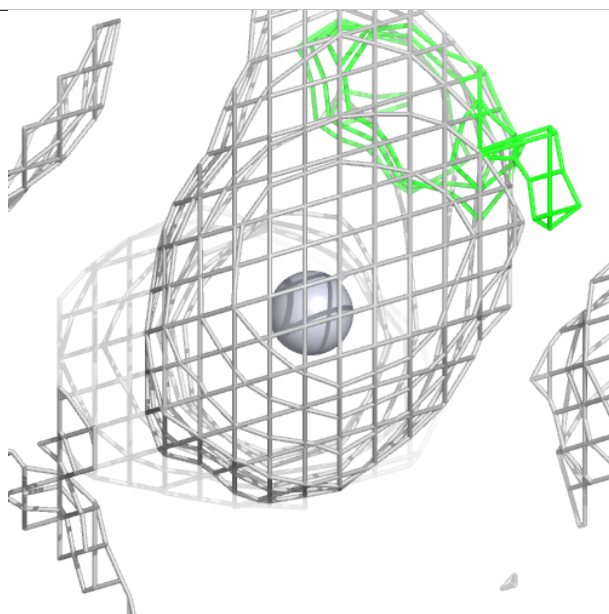
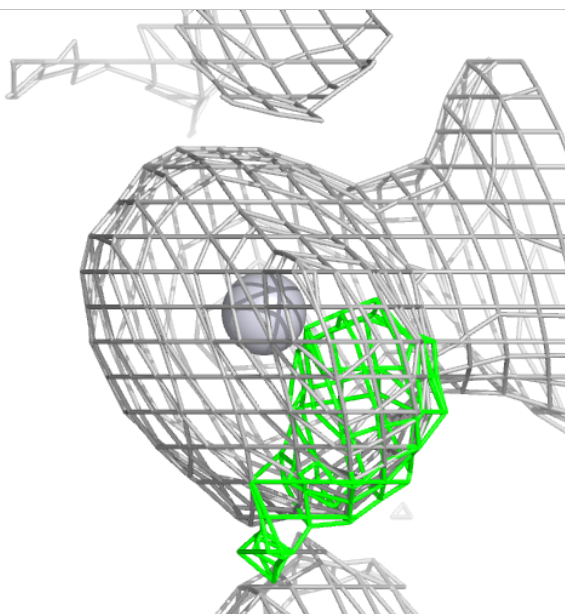
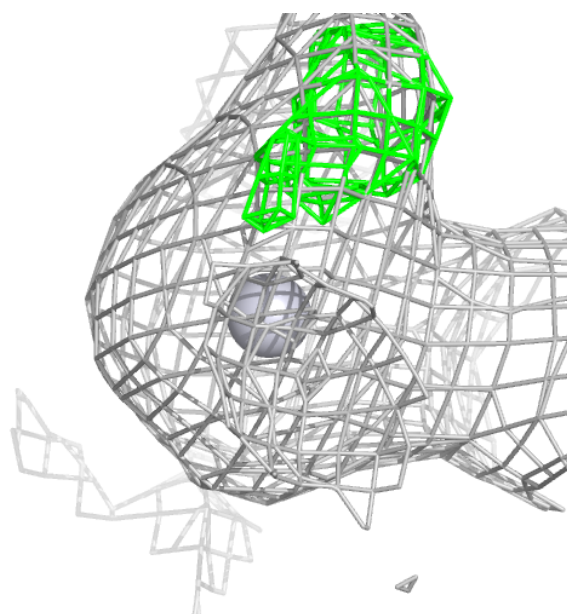

Electron density around PT AAA 203 (A):

$2mF_o-DF_c$ (at 0.7 rmsd) in gray
 mF_o-DF_c (at 3 rmsd) in purple (negative)
and green (positive)

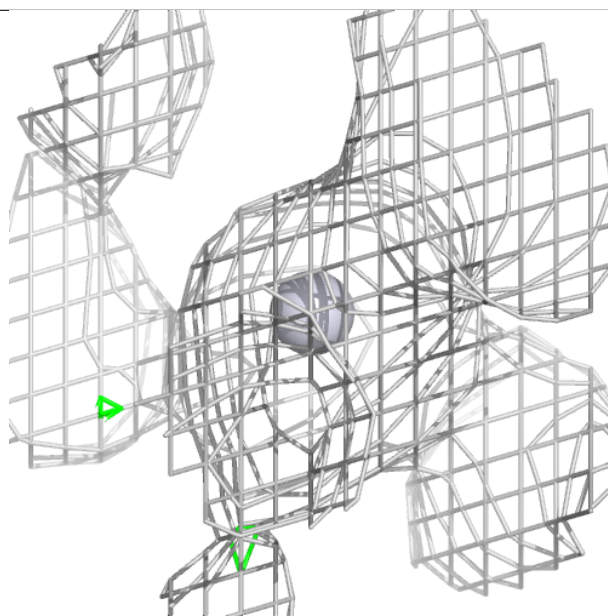
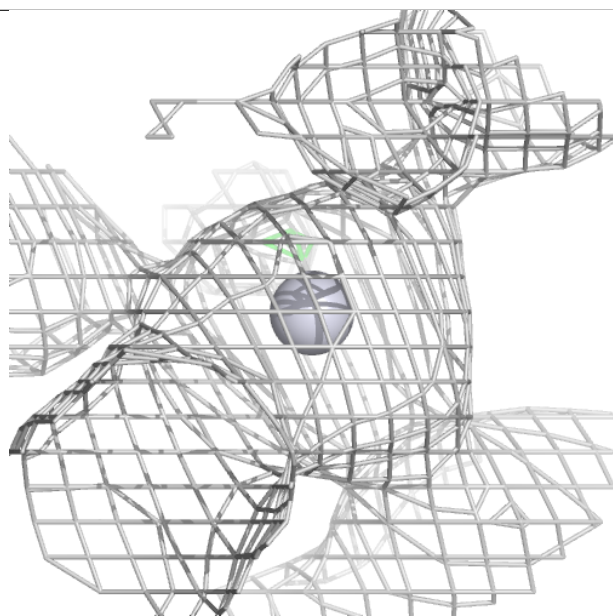
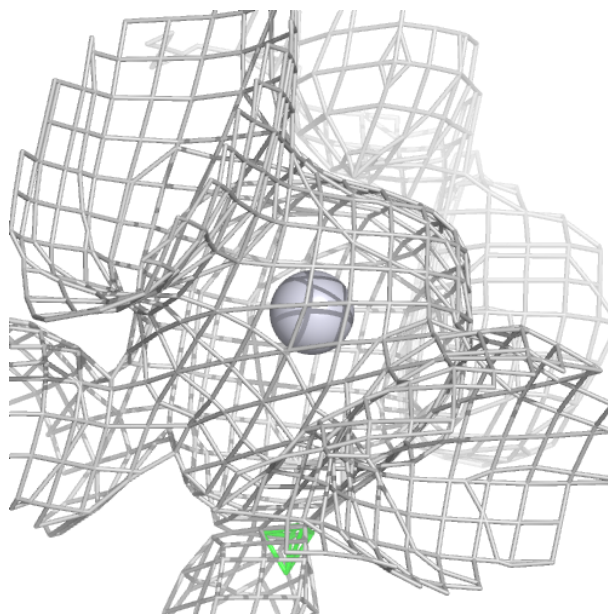

Electron density around PT AAA 202:

$2mF_o-DF_c$ (at 0.7 rmsd) in gray
 mF_o-DF_c (at 3 rmsd) in purple (negative)
and green (positive)

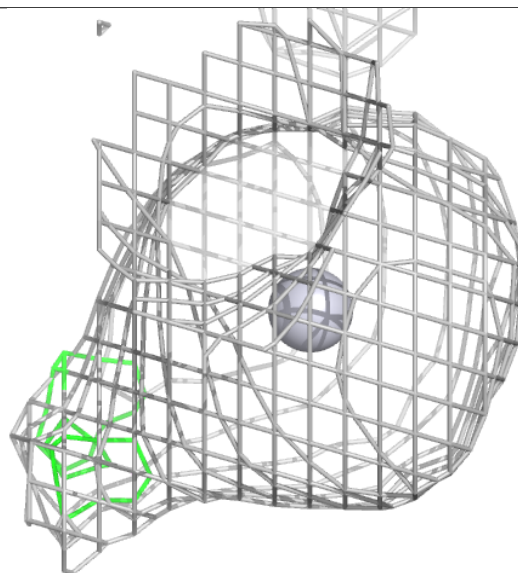
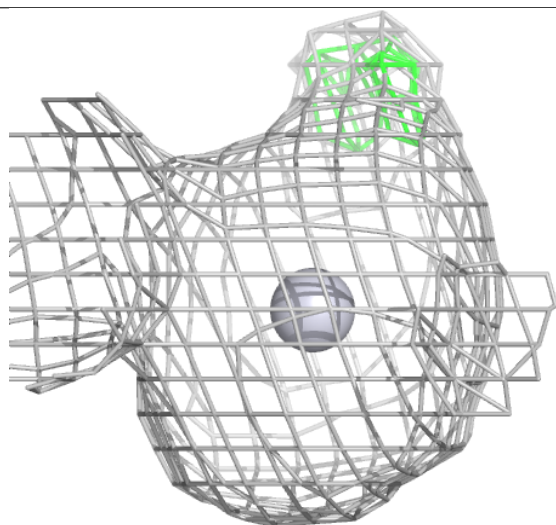
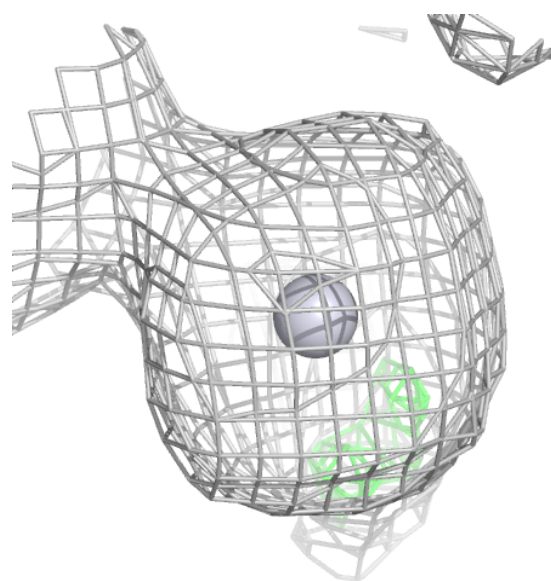

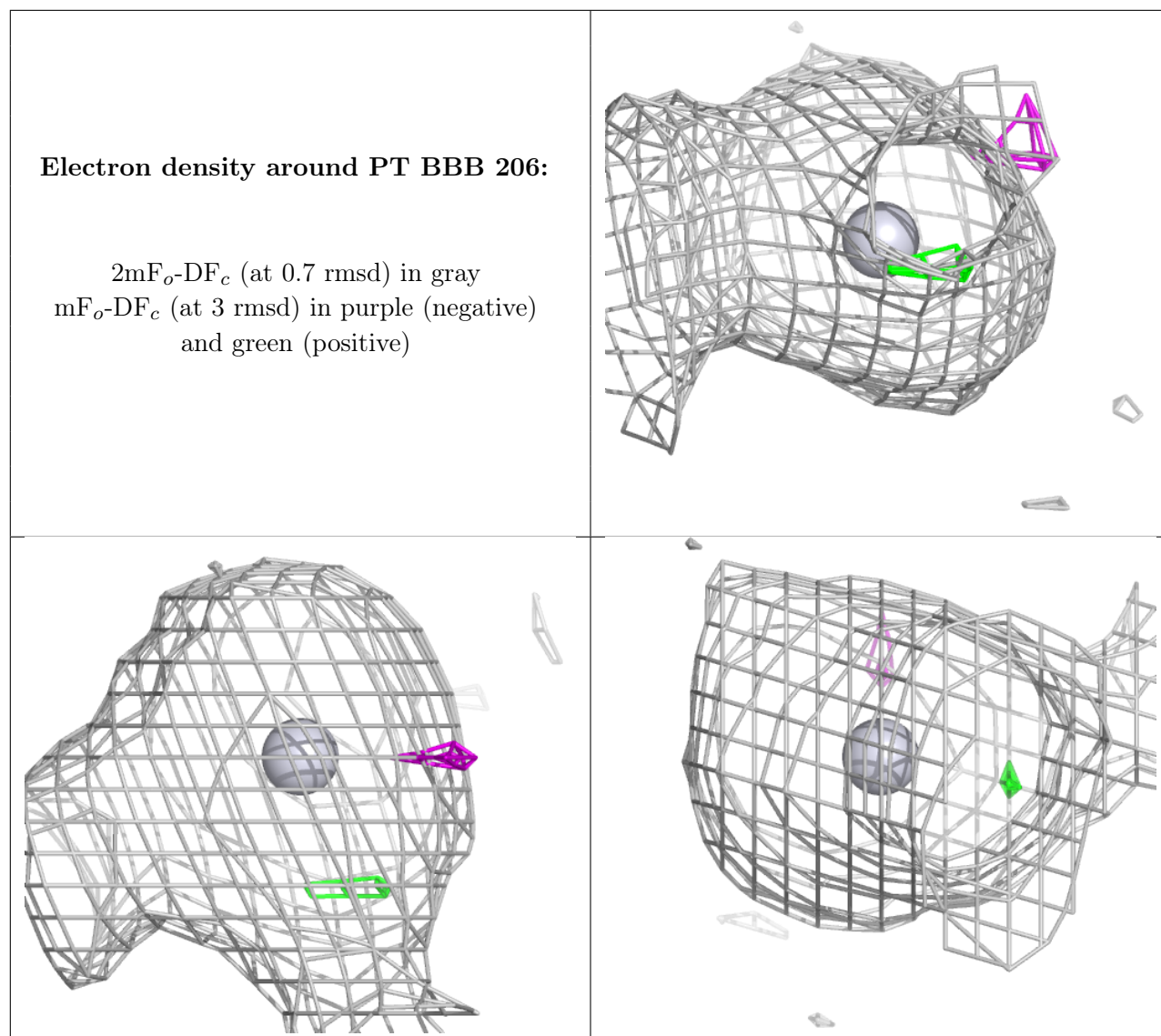

6.5 Other polymers [i](#)

There are no such residues in this entry.