



wwPDB X-ray Structure Validation Summary Report ⓘ

May 11, 2021 – 09:30 am BST

PDB ID : 6ZO6
Title : Minocycline binding to the deep binding pocket of AcrB-G619P
Authors : Tam, H.K.; Foong, W.E.; Pos, K.M.
Deposited on : 2020-07-07
Resolution : 2.35 Å(reported)

This is a wwPDB X-ray Structure Validation Summary Report for a publicly released PDB entry.

We welcome your comments at validation@mail.wwpdb.org

A user guide is available at

<https://www.wwpdb.org/validation/2017/XrayValidationReportHelp>

with specific help available everywhere you see the ⓘ symbol.

The following versions of software and data (see [references ⓘ](#)) were used in the production of this report:

MolProbity : 4.02b-467
Mogul : 1.8.5 (274361), CSD as541be (2020)
Xtriage (Phenix) : 1.13
EDS : 2.18
buster-report : 1.1.7 (2018)
Percentile statistics : 20191225.v01 (using entries in the PDB archive December 25th 2019)
Refmac : 5.8.0158
CCP4 : 7.0.044 (Gargrove)
Ideal geometry (proteins) : Engh & Huber (2001)
Ideal geometry (DNA, RNA) : Parkinson et al. (1996)
Validation Pipeline (wwPDB-VP) : 2.18

1 Overall quality at a glance

The following experimental techniques were used to determine the structure:

X-RAY DIFFRACTION

The reported resolution of this entry is 2.35 Å.

Percentile scores (ranging between 0-100) for global validation metrics of the entry are shown in the following graphic. The table shows the number of entries on which the scores are based.

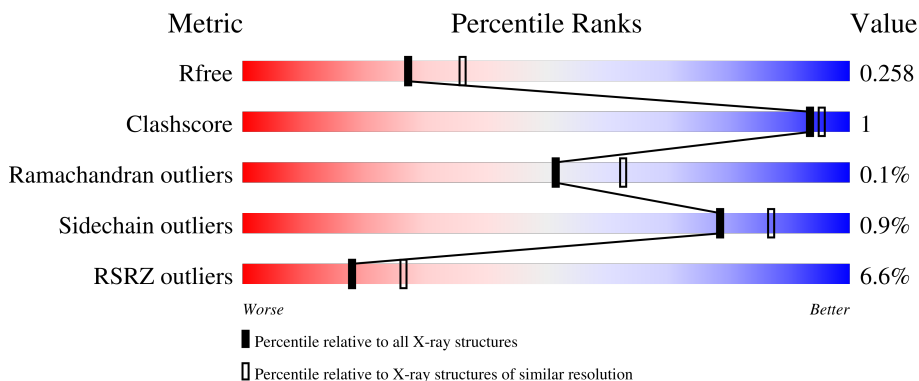

Metric	Whole archive (#Entries)	Similar resolution (#Entries, resolution range(Å))
R_{free}	130704	1164 (2.36-2.36)
Clashscore	141614	1232 (2.36-2.36)
Ramachandran outliers	138981	1211 (2.36-2.36)
Sidechain outliers	138945	1212 (2.36-2.36)
RSRZ outliers	127900	1150 (2.36-2.36)

The table below summarises the geometric issues observed across the polymeric chains and their fit to the electron density. The red, orange, yellow and green segments of the lower bar indicate the fraction of residues that contain outliers for ≥ 3 , 2, 1 and 0 types of geometric quality criteria respectively. A grey segment represents the fraction of residues that are not modelled. The numeric value for each fraction is indicated below the corresponding segment, with a dot representing fractions $\leq 5\%$. The upper red bar (where present) indicates the fraction of residues that have poor fit to the electron density. The numeric value is given above the bar.

Mol	Chain	Length	Quality of chain
1	A	1057	
1	B	1057	
1	C	1057	
2	D	169	
2	E	169	

The following table lists non-polymeric compounds, carbohydrate monomers and non-standard residues in protein, DNA, RNA chains that are outliers for geometric or electron-density-fit criteria:

Mol	Type	Chain	Res	Chirality	Geometry	Clashes	Electron density
23	1PE	C	1120	-	-	-	X
6	GOL	B	1113	-	-	-	X
9	EDO	C	1122	-	-	-	X

2 Entry composition [i](#)

There are 24 unique types of molecules in this entry. The entry contains 28139 atoms, of which 0 are hydrogens and 0 are deuteriums.

In the tables below, the ZeroOcc column contains the number of atoms modelled with zero occupancy, the AltConf column contains the number of residues with at least one atom in alternate conformation and the Trace column contains the number of residues modelled with at most 2 atoms.

- Molecule 1 is a protein called Multidrug efflux pump subunit AcrB.

Mol	Chain	Residues	Atoms					ZeroOcc	AltConf	Trace
			Total	C	N	O	S			
1	A	1042	7961	5119	1319	1479	44	0	4	0
1	B	1033	7883	5074	1301	1463	45	0	5	0
1	C	1034	7881	5071	1301	1465	44	0	3	0

There are 27 discrepancies between the modelled and reference sequences:

Chain	Residue	Modelled	Actual	Comment	Reference
A	619	PRO	GLY	engineered mutation	UNP P31224
A	1050	LEU	-	expression tag	UNP P31224
A	1051	GLU	-	expression tag	UNP P31224
A	1052	HIS	-	expression tag	UNP P31224
A	1053	HIS	-	expression tag	UNP P31224
A	1054	HIS	-	expression tag	UNP P31224
A	1055	HIS	-	expression tag	UNP P31224
A	1056	HIS	-	expression tag	UNP P31224
A	1057	HIS	-	expression tag	UNP P31224
B	619	PRO	GLY	engineered mutation	UNP P31224
B	1050	LEU	-	expression tag	UNP P31224
B	1051	GLU	-	expression tag	UNP P31224
B	1052	HIS	-	expression tag	UNP P31224
B	1053	HIS	-	expression tag	UNP P31224
B	1054	HIS	-	expression tag	UNP P31224
B	1055	HIS	-	expression tag	UNP P31224
B	1056	HIS	-	expression tag	UNP P31224
B	1057	HIS	-	expression tag	UNP P31224
C	619	PRO	GLY	engineered mutation	UNP P31224
C	1050	LEU	-	expression tag	UNP P31224
C	1051	GLU	-	expression tag	UNP P31224
C	1052	HIS	-	expression tag	UNP P31224
C	1053	HIS	-	expression tag	UNP P31224

Continued on next page...

Continued from previous page...

Chain	Residue	Modelled	Actual	Comment	Reference
C	1054	HIS	-	expression tag	UNP P31224
C	1055	HIS	-	expression tag	UNP P31224
C	1056	HIS	-	expression tag	UNP P31224
C	1057	HIS	-	expression tag	UNP P31224

- Molecule 2 is a protein called DARPIN.

Mol	Chain	Residues	Atoms					ZeroOcc	AltConf	Trace
			Total	C	N	O	S			
2	D	156	1177	741	206	229	1	0	0	0
2	E	154	1167	736	204	226	1	0	0	0

- Molecule 3 is DODECYL-BETA-D-MALTOSE (three-letter code: LMT) (formula: $C_{24}H_{46}O_{11}$).

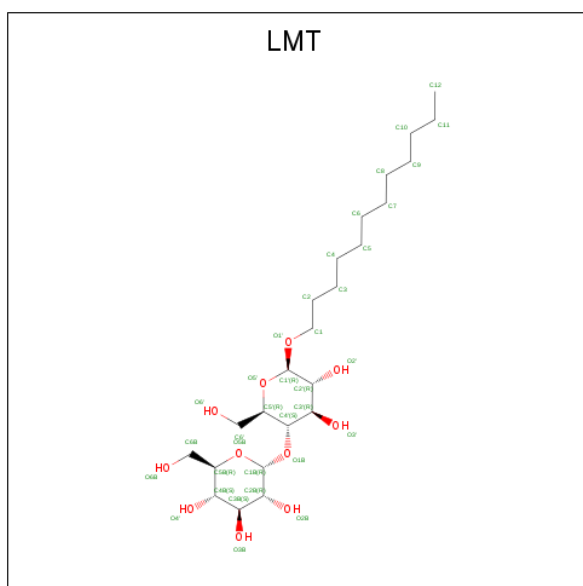

Mol	Chain	Residues	Atoms			ZeroOcc	AltConf
			Total	C	O		
3	A	1	35	24	11	0	0
3	A	1	35	24	11	0	0
3	A	1	35	24	11	0	0
3	B	1	35	24	11	0	0
3	B	1	35	24	11	0	0

Continued on next page...

Continued from previous page...

Mol	Chain	Residues	Atoms		ZeroOcc	AltConf
3	C	1	Total	C O	0	0
			35	24 11		

- Molecule 4 is N-OCTANE (three-letter code: OCT) (formula: C₈H₁₈).

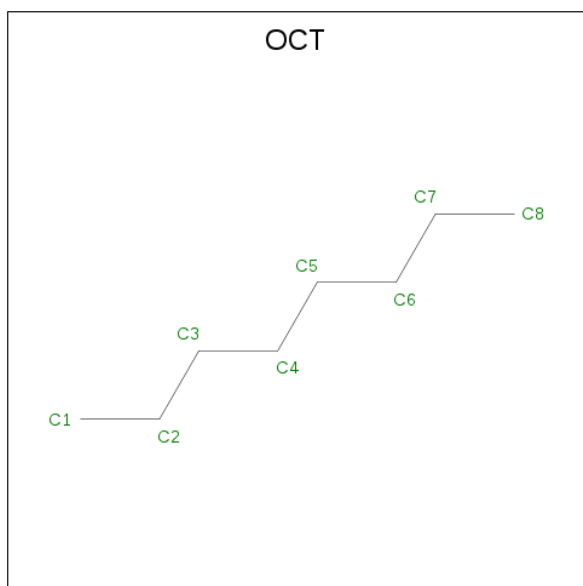

Mol	Chain	Residues	Atoms		ZeroOcc	AltConf
4	A	1	Total	C	0	0
			8	8		
4	C	1	Total	C	0	0
			8	8		
4	C	1	Total	C	0	0
			8	8		

- Molecule 5 is DECYLAMINE-N,N-DIMETHYL-N-OXIDE (three-letter code: DDQ) (formula: C₁₂H₂₇NO).

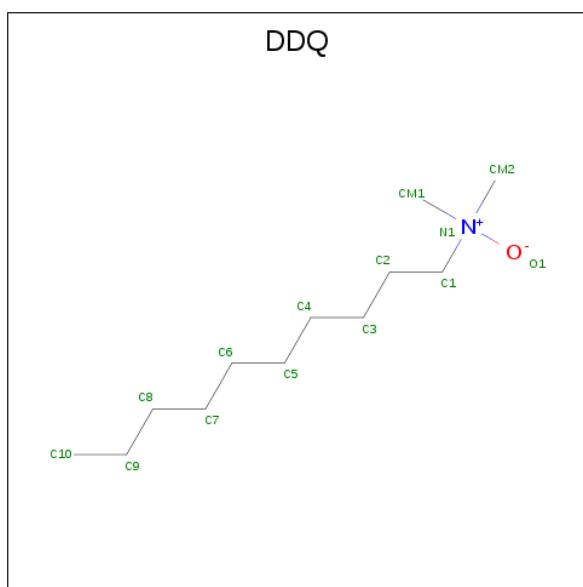

Mol	Chain	Residues	Atoms				ZeroOcc	AltConf
			Total	C	N	O		
5	A	1	Total	C	N	O	0	0
			14	12	1	1		
5	B	1	Total	C	N	O	0	0
			14	12	1	1		
5	B	1	Total	C	N	O	0	0
			14	12	1	1		
5	C	1	Total	C	N	O	0	0
			14	12	1	1		
5	C	1	Total	C	N	O	0	0
			14	12	1	1		

- Molecule 6 is GLYCEROL (three-letter code: GOL) (formula: C₃H₈O₃).

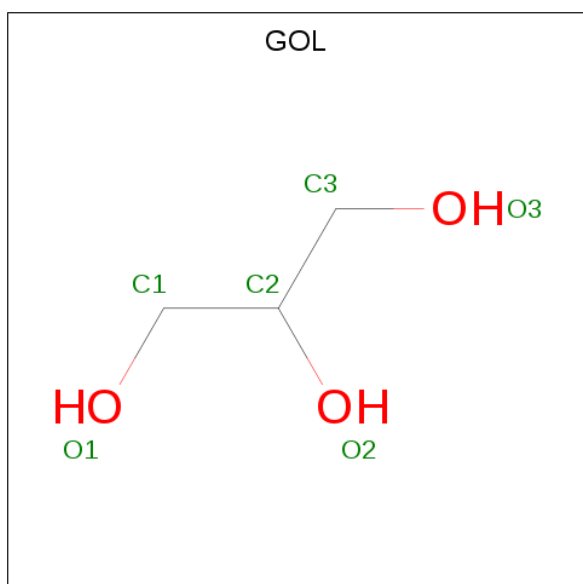

Mol	Chain	Residues	Atoms			ZeroOcc	AltConf
6	A	1	Total 6	C 3	O 3	0	0
6	A	1	Total 6	C 3	O 3	0	0
6	A	1	Total 6	C 3	O 3	0	0
6	A	1	Total 6	C 3	O 3	0	0
6	A	1	Total 6	C 3	O 3	0	0
6	A	1	Total 6	C 3	O 3	0	0
6	B	1	Total 6	C 3	O 3	0	0
6	B	1	Total 6	C 3	O 3	0	0
6	B	1	Total 6	C 3	O 3	0	0
6	B	1	Total 6	C 3	O 3	0	0
6	C	1	Total 6	C 3	O 3	0	0
6	C	1	Total 6	C 3	O 3	0	0
6	C	1	Total 6	C 3	O 3	0	0
6	E	1	Total 6	C 3	O 3	0	0

- Molecule 7 is DODECANE (three-letter code: D12) (formula: C₁₂H₂₆).

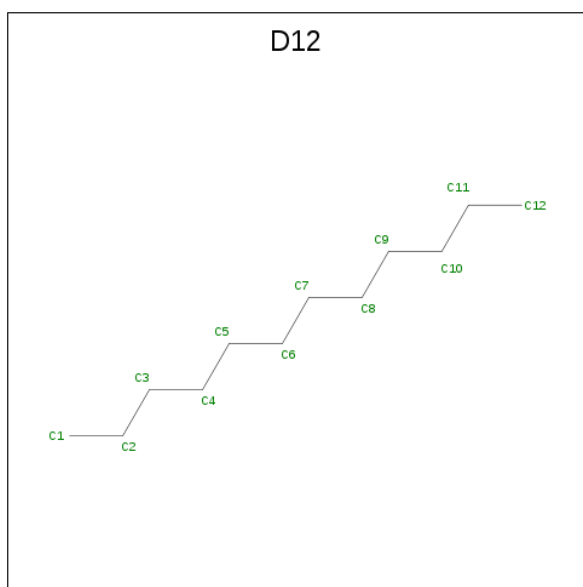

Mol	Chain	Residues	Atoms	ZeroOcc	AltConf
7	A	1	Total C 12 12	0	0
7	C	1	Total C 12 12	0	0
7	C	1	Total C 12 12	0	0

- Molecule 8 is HEXANE (three-letter code: HEX) (formula: C_6H_{14}).

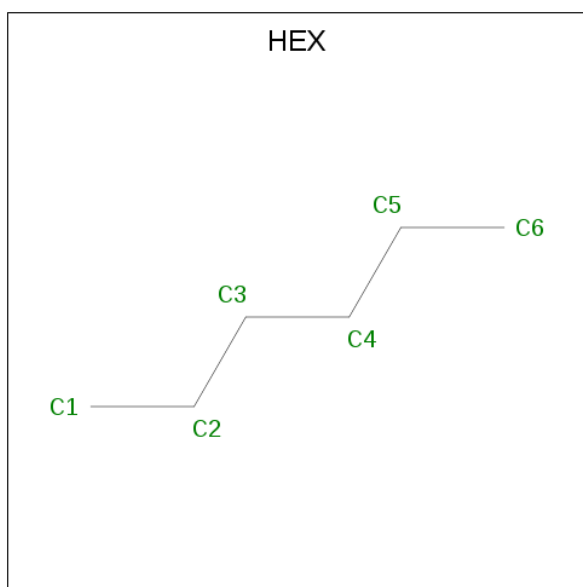

Mol	Chain	Residues	Atoms	ZeroOcc	AltConf
8	A	1	Total C 6 6	0	0

Continued on next page...

Continued from previous page...

Mol	Chain	Residues	Atoms	ZeroOcc	AltConf
8	B	1	Total C 6 6	0	0
8	B	1	Total C 6 6	0	0
8	B	1	Total C 6 6	0	0
8	C	1	Total C 6 6	0	0
8	C	1	Total C 6 6	0	0

- Molecule 9 is 1,2-ETHANEDIOL (three-letter code: EDO) (formula: C₂H₆O₂).

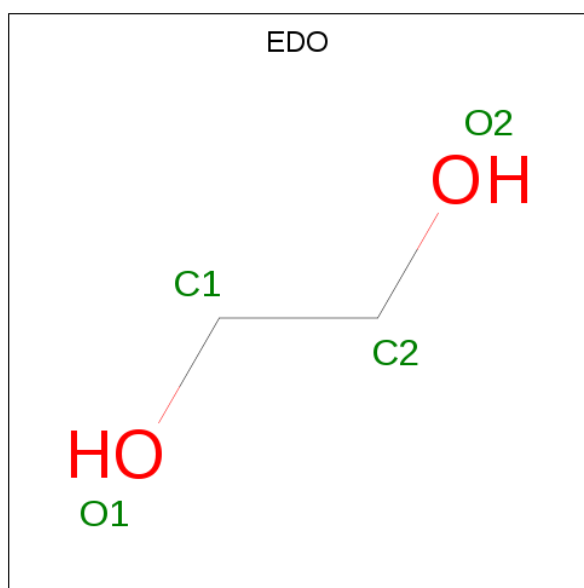

Mol	Chain	Residues	Atoms	ZeroOcc	AltConf
9	A	1	Total C O 4 2 2	0	0
9	A	1	Total C O 4 2 2	0	0
9	A	1	Total C O 4 2 2	0	0
9	B	1	Total C O 4 2 2	0	0
9	B	1	Total C O 4 2 2	0	0
9	B	1	Total C O 4 2 2	0	0

Continued on next page...

Continued from previous page...

Mol	Chain	Residues	Atoms			ZeroOcc	AltConf
9	B	1	Total 4	C 2	O 2	0	0
9	B	1	Total 4	C 2	O 2	0	0
9	B	1	Total 4	C 2	O 2	0	0
9	B	1	Total 4	C 2	O 2	0	0
9	B	1	Total 4	C 2	O 2	0	0
9	B	1	Total 4	C 2	O 2	0	0
9	B	1	Total 4	C 2	O 2	0	0
9	C	1	Total 4	C 2	O 2	0	0
9	C	1	Total 4	C 2	O 2	0	0
9	C	1	Total 4	C 2	O 2	0	0
9	C	1	Total 4	C 2	O 2	0	0
9	C	1	Total 4	C 2	O 2	0	0
9	C	1	Total 4	C 2	O 2	0	0
9	C	1	Total 4	C 2	O 2	0	0
9	C	1	Total 4	C 2	O 2	0	0
9	D	1	Total 4	C 2	O 2	0	0
9	D	1	Total 4	C 2	O 2	0	0
9	D	1	Total 4	C 2	O 2	0	0

- Molecule 10 is TRIETHYLENE GLYCOL (three-letter code: PGE) (formula: C₆H₁₄O₄).



Mol	Chain	Residues	Atoms			ZeroOcc	AltConf
10	A	1	Total	C	O	0	0
			10	6	4		
10	C	1	Total	C	O	0	0
			10	6	4		

- Molecule 11 is (4S,4AS,5AR,12AS)-4,7-BIS(DIMETHYLAMINO)-3,10,12,12A-TETRAHYDROXY-1,11-DIOXO-1,4,4A,5,5A,6,11,12A-OCTAHYDROTETRACENE-2-CARBOXAMIDE (three-letter code: MIY) (formula: C₂₃H₂₇N₃O₇) (labeled as "Ligand of Interest" by depositor).

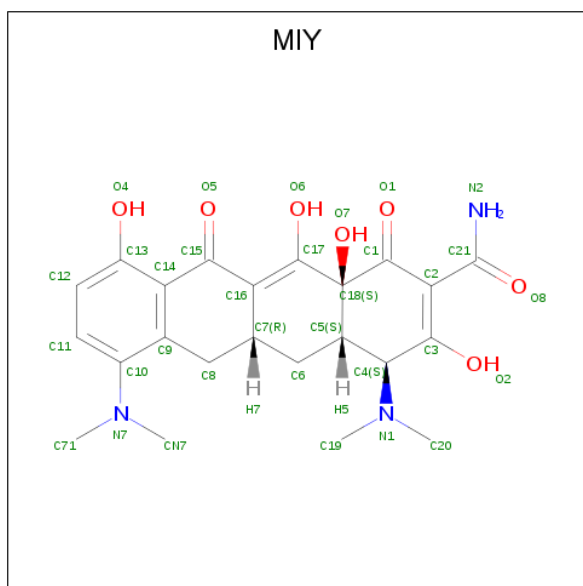

Mol	Chain	Residues	Atoms				ZeroOcc	AltConf
			Total	C	N	O		
11	B	1	33	23	3	7	0	0

- Molecule 12 is (2S)-3-hydroxypropane-1,2-diyl didecanoate (three-letter code: DDR) (formula: C₂₃H₄₄O₅).

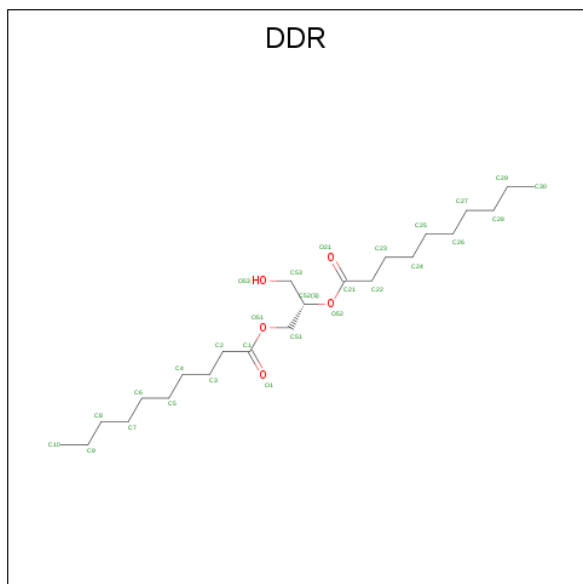

Mol	Chain	Residues	Atoms			ZeroOcc	AltConf
			Total	C	O		
12	B	1	28	23	5	0	0

- Molecule 13 is DECANE (three-letter code: D10) (formula: C₁₀H₂₂).

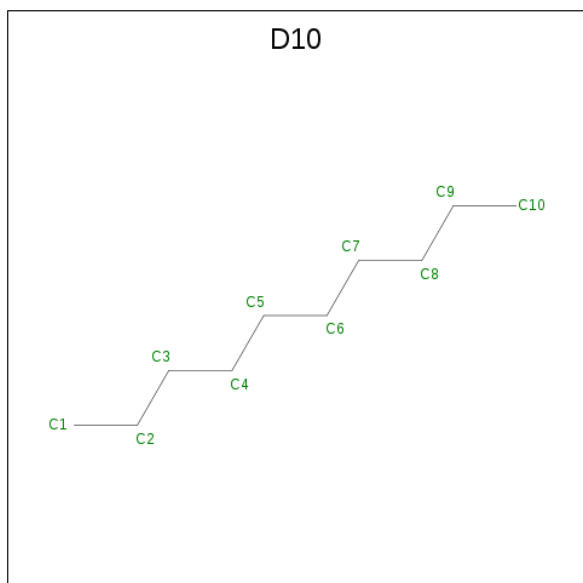

Mol	Chain	Residues	Atoms	ZeroOcc	AltConf
13	B	1	Total C 10 10	0	0
13	B	1	Total C 10 10	0	0
13	B	1	Total C 10 10	0	0
13	C	1	Total C 10 10	0	0
13	C	1	Total C 10 10	0	0

- Molecule 14 is CHLORIDE ION (three-letter code: CL) (formula: Cl).

Mol	Chain	Residues	Atoms	ZeroOcc	AltConf
14	B	1	Total Cl 1 1	0	0
14	C	2	Total Cl 2 2	0	0

- Molecule 15 is PENTADECANE (three-letter code: MYS) (formula: C₁₅H₃₂).

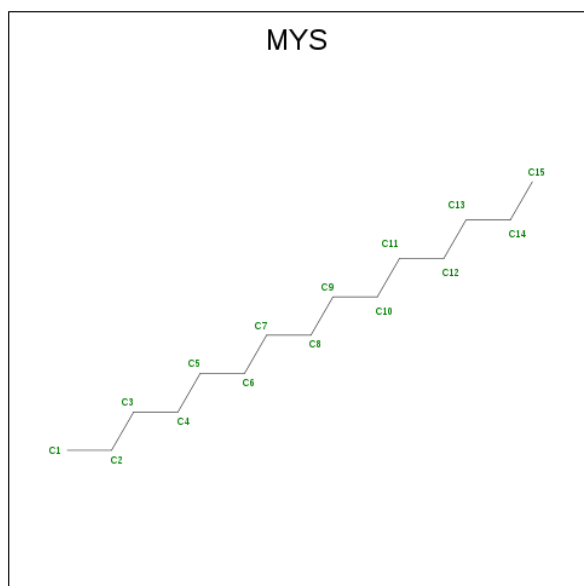

Mol	Chain	Residues	Atoms	ZeroOcc	AltConf
15	B	1	Total C 15 15	0	0
15	B	1	Total C 15 15	0	0

- Molecule 16 is TETRAETHYLENE GLYCOL (three-letter code: PG4) (formula: $C_8H_{18}O_5$).

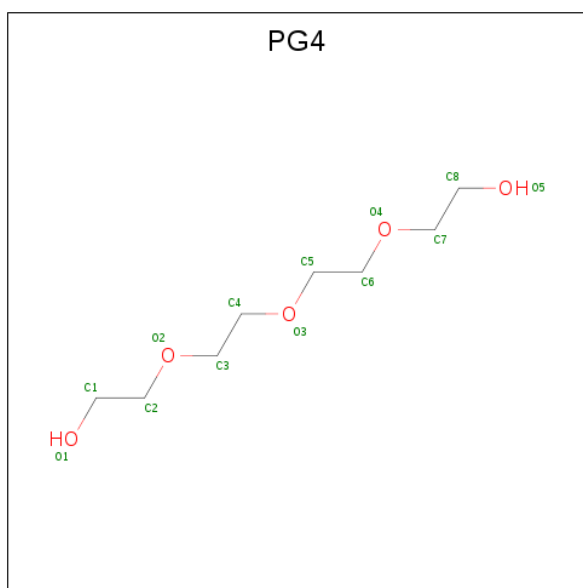

Mol	Chain	Residues	Atoms	ZeroOcc	AltConf
16	B	1	Total C O 13 8 5	0	0

- Molecule 17 is Octadecane (three-letter code: 8K6) (formula: $C_{18}H_{38}$).

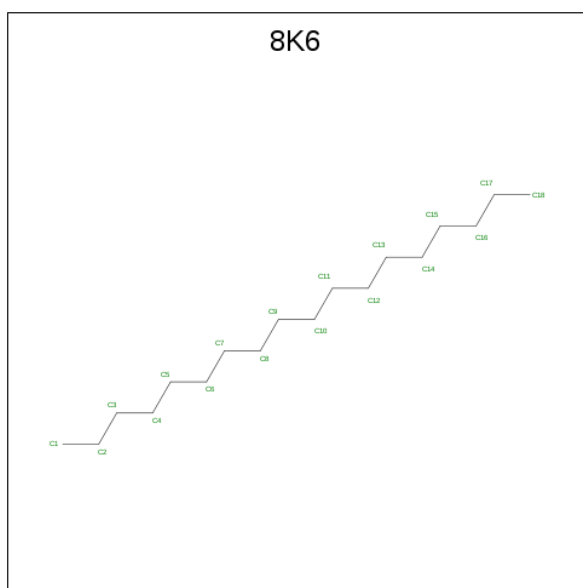

Mol	Chain	Residues	Atoms	ZeroOcc	AltConf
17	B	1	Total C 18 18	0	0

- Molecule 18 is HEXADECANE (three-letter code: R16) (formula: $C_{16}H_{34}$).

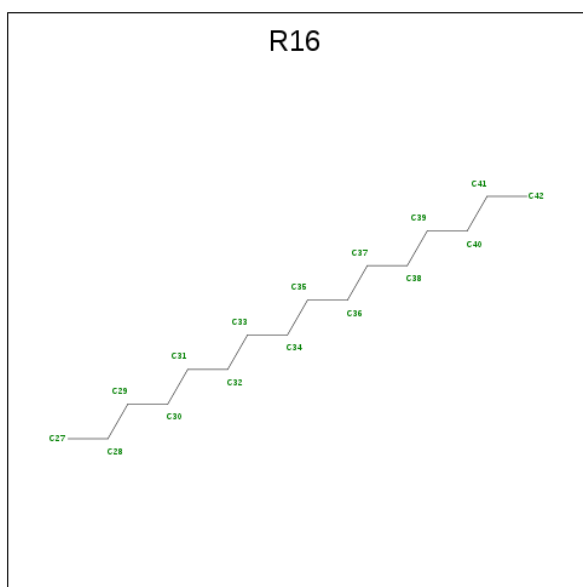

Mol	Chain	Residues	Atoms	ZeroOcc	AltConf
18	B	1	Total C 16 16	0	0

- Molecule 19 is SULFATE ION (three-letter code: SO4) (formula: O₄S).

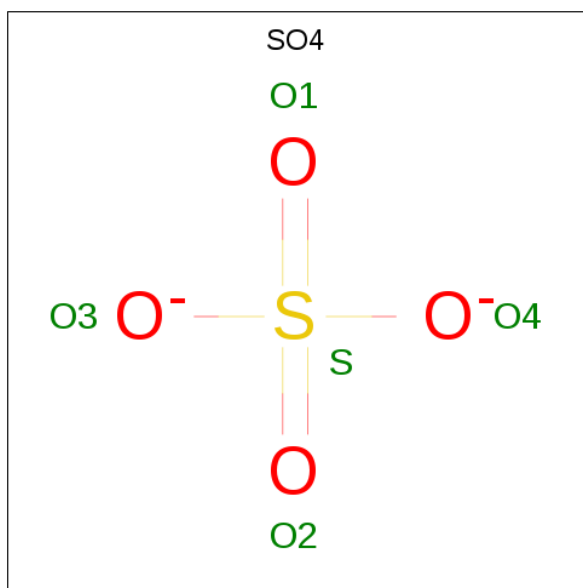

Mol	Chain	Residues	Atoms	ZeroOcc	AltConf
19	B	1	Total O S 5 4 1	0	0

- Molecule 20 is TETRADECANE (three-letter code: C14) (formula: C₁₄H₃₀).

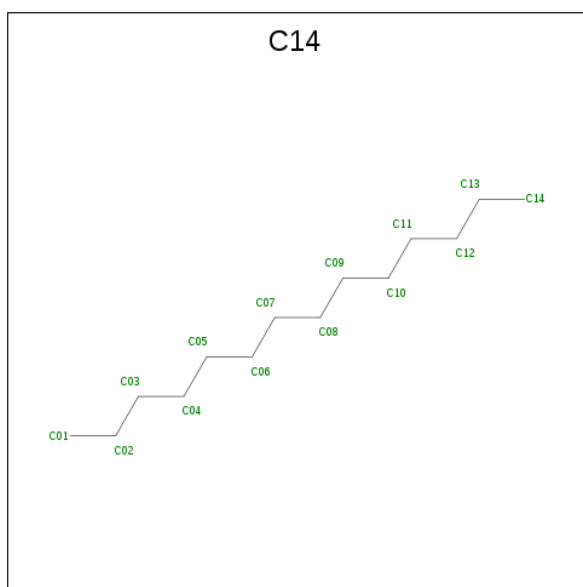

Mol	Chain	Residues	Atoms	ZeroOcc	AltConf
20	C	1	Total C 14 14	0	0

- Molecule 21 is PHOSPHATIDYLETHANOLAMINE (three-letter code: PTY) (formula: $C_{40}H_{80}NO_8P$).

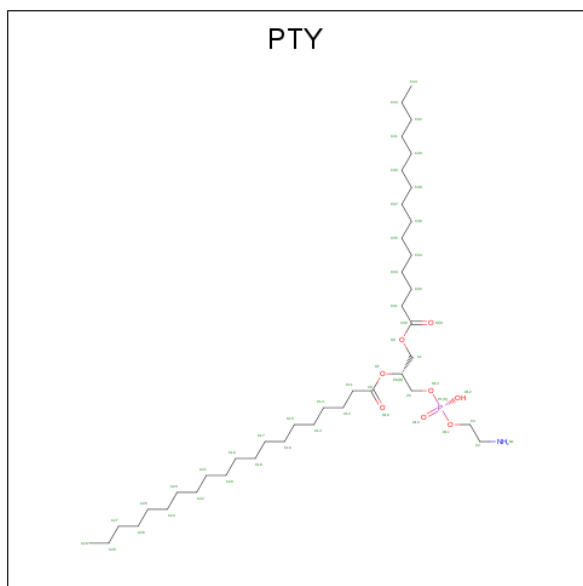

Mol	Chain	Residues	Atoms	ZeroOcc	AltConf
21	C	1	Total C N O P 50 40 1 8 1	0	0

- Molecule 22 is (2S)-3-{[(R)-(2-aminoethoxy)(hydroxy)phosphoryl]oxy}-2-hydroxypropyl hexadecanoate (three-letter code: LPX) (formula: $C_{21}H_{44}NO_7P$).

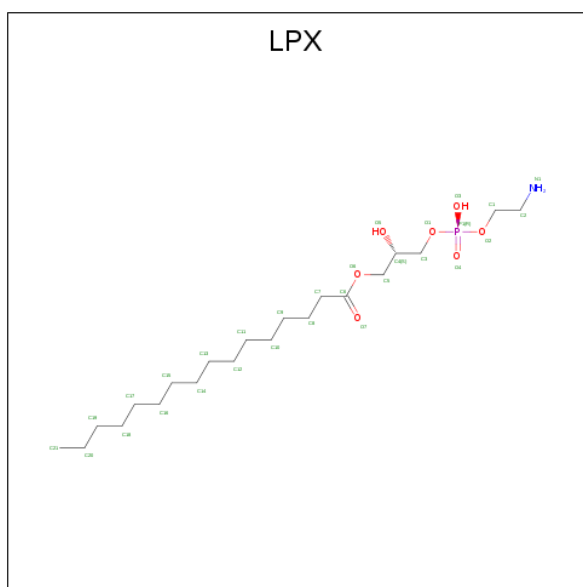

Mol	Chain	Residues	Atoms					ZeroOcc	AltConf
			Total	C	N	O	P		
22	C	1	30	21	1	7	1	0	0

- Molecule 23 is PENTAETHYLENE GLYCOL (three-letter code: 1PE) (formula: C₁₀H₂₂O₆).

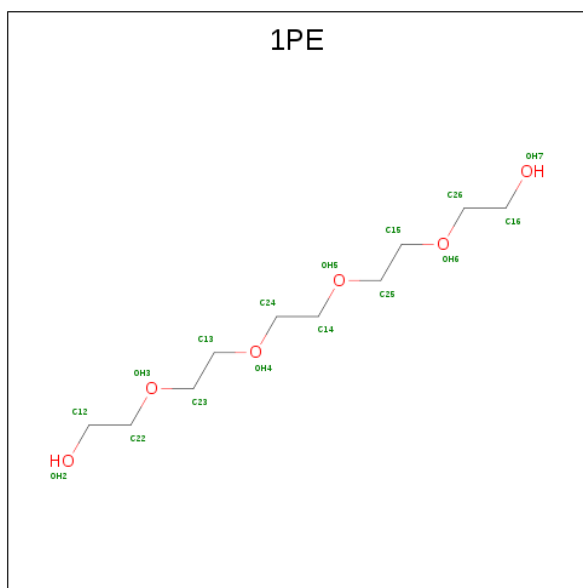

Mol	Chain	Residues	Atoms			ZeroOcc	AltConf
			Total	C	O		
23	C	1	16	10	6	0	0

- Molecule 24 is water.

Mol	Chain	Residues	Atoms		ZeroOcc	AltConf
24	A	380	Total 380	O 380	0	0
24	B	348	Total 348	O 348	0	0
24	C	401	Total 401	O 401	0	0
24	D	37	Total 37	O 37	0	0
24	E	22	Total 22	O 22	0	0

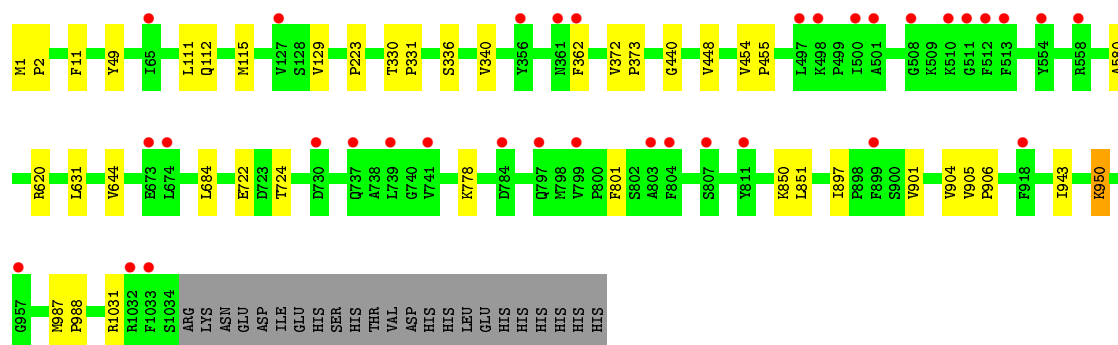

- Molecule 2: DARPIN

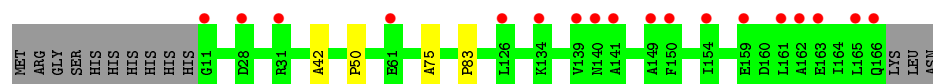
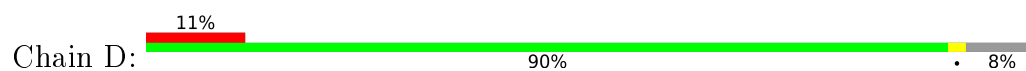

- Molecule 2: DARPIN

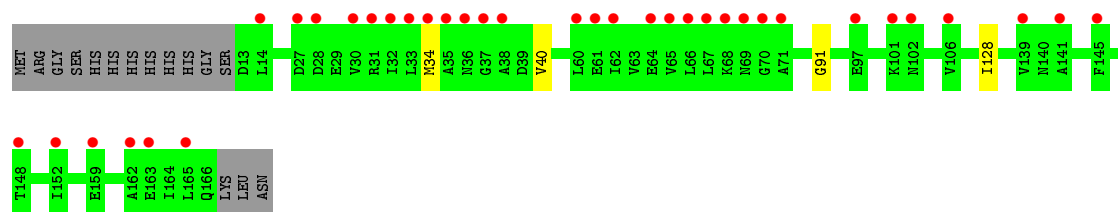
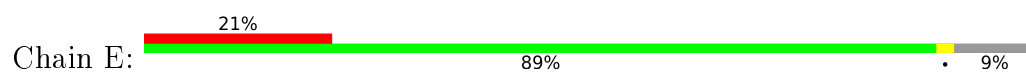

4 Data and refinement statistics

Property	Value	Source
Space group	P 21 21 21	Depositor
Cell constants a, b, c, α , β , γ	146.28Å 161.01Å 245.46Å 90.00° 90.00° 90.00°	Depositor
Resolution (Å)	49.36 – 2.35 49.36 – 2.35	Depositor EDS
% Data completeness (in resolution range)	100.0 (49.36-2.35) 100.0 (49.36-2.35)	Depositor EDS
R_{merge}	0.16	Depositor
R_{sym}	(Not available)	Depositor
$\langle I/\sigma(I) \rangle$ ¹	1.45 (at 2.34Å)	Xtrriage
Refinement program	REFMAC 5.8.0238	Depositor
R, R_{free}	0.231 , 0.257 0.233 , 0.258	Depositor DCC
R_{free} test set	12078 reflections (5.03%)	wwPDB-VP
Wilson B-factor (Å ²)	38.8	Xtrriage
Anisotropy	0.467	Xtrriage
Bulk solvent k_{sol} (e/Å ³), B_{sol} (Å ²)	0.35 , 41.2	EDS
L-test for twinning ²	$\langle L \rangle = 0.49$, $\langle L^2 \rangle = 0.32$	Xtrriage
Estimated twinning fraction	No twinning to report.	Xtrriage
F_o, F_c correlation	0.92	EDS
Total number of atoms	28139	wwPDB-VP
Average B, all atoms (Å ²)	47.0	wwPDB-VP

Xtrriage's analysis on translational NCS is as follows: *The largest off-origin peak in the Patterson function is 1.98% of the height of the origin peak. No significant pseudotranslation is detected.*

¹Intensities estimated from amplitudes.

²Theoretical values of $\langle |L| \rangle$, $\langle L^2 \rangle$ for acentric reflections are 0.5, 0.333 respectively for untwinned datasets, and 0.375, 0.2 for perfectly twinned datasets.

5 Model quality [i](#)

5.1 Standard geometry [i](#)

Bond lengths and bond angles in the following residue types are not validated in this section: DDQ, OCT, GOL, SO4, PGE, MIY, DDR, PTY, 1PE, D10, CL, C14, MYS, EDO, D12, PG4, LMT, HEX, R16, LPX, 8K6

The Z score for a bond length (or angle) is the number of standard deviations the observed value is removed from the expected value. A bond length (or angle) with $|Z| > 5$ is considered an outlier worth inspection. RMSZ is the root-mean-square of all Z scores of the bond lengths (or angles).

Mol	Chain	Bond lengths		Bond angles	
		RMSZ	# Z >5	RMSZ	# Z >5
1	A	0.67	0/8122	0.70	0/11027
1	B	0.67	0/8043	0.70	0/10923
1	C	0.67	0/8035	0.70	0/10912
2	D	0.68	0/1196	0.71	0/1626
2	E	0.68	0/1186	0.71	0/1613
All	All	0.67	0/26582	0.70	0/36101

There are no bond length outliers.

There are no bond angle outliers.

There are no chirality outliers.

There are no planarity outliers.

5.2 Too-close contacts [i](#)

In the following table, the Non-H and H(model) columns list the number of non-hydrogen atoms and hydrogen atoms in the chain respectively. The H(added) column lists the number of hydrogen atoms added and optimized by MolProbity. The Clashes column lists the number of clashes within the asymmetric unit, whereas Symm-Clashes lists symmetry-related clashes.

Mol	Chain	Non-H	H(model)	H(added)	Clashes	Symm-Clashes
1	A	7961	0	8115	30	0
1	B	7883	0	8043	28	0
1	C	7881	0	8032	21	0
2	D	1177	0	1159	2	0
2	E	1167	0	1151	2	0
3	A	105	0	138	0	0
3	B	70	0	92	1	0
3	C	35	0	46	0	0

Continued on next page...

Continued from previous page...

Mol	Chain	Non-H	H(model)	H(added)	Clashes	Symm-Clashes
4	A	8	0	18	0	0
4	C	16	0	36	0	0
5	A	14	0	27	0	0
5	B	28	0	54	0	0
5	C	28	0	54	0	0
6	A	36	0	48	0	0
6	B	24	0	32	0	0
6	C	18	0	24	0	0
6	E	6	0	8	0	0
7	A	12	0	26	0	0
7	C	24	0	52	0	0
8	A	6	0	14	0	0
8	B	18	0	42	0	0
8	C	12	0	28	0	0
9	A	12	0	18	0	0
9	B	40	0	60	0	0
9	C	32	0	48	0	0
9	D	12	0	18	0	0
10	A	10	0	14	0	0
10	C	10	0	14	0	0
11	B	33	0	24	0	0
12	B	28	0	44	0	0
13	B	30	0	66	0	0
13	C	20	0	44	0	0
14	B	1	0	0	0	0
14	C	2	0	0	0	0
15	B	30	0	64	0	0
16	B	13	0	18	3	0
17	B	18	0	38	0	0
18	B	16	0	34	0	0
19	B	5	0	0	0	0
20	C	14	0	30	1	0
21	C	50	0	79	0	0
22	C	30	0	43	0	0
23	C	16	0	22	0	0
24	A	380	0	0	0	0
24	B	348	0	0	0	0
24	C	401	0	0	0	0
24	D	37	0	0	0	0
24	E	22	0	0	0	0
All	All	28139	0	27917	79	0

The all-atom clashscore is defined as the number of clashes found per 1000 atoms (including

hydrogen atoms). The all-atom clashscore for this structure is 1.

The worst 5 of 79 close contacts within the same asymmetric unit are listed below, sorted by their clash magnitude.

Atom-1	Atom-2	Interatomic distance (Å)	Clash overlap (Å)
1:A:968:VAL:HG11	1:A:1023:PRO:HG3	1.80	0.62
1:A:367:ILE:HB	1:A:368:PRO:HD3	1.82	0.62
1:B:873:ALA:HB3	1:B:874:PRO:HD3	1.82	0.60
1:C:901:VAL:O	1:C:904:VAL:HG12	2.03	0.59
2:E:34:MET:SD	2:E:40:VAL:HG12	2.46	0.56

There are no symmetry-related clashes.

5.3 Torsion angles [i](#)

5.3.1 Protein backbone [i](#)

In the following table, the Percentiles column shows the percent Ramachandran outliers of the chain as a percentile score with respect to all X-ray entries followed by that with respect to entries of similar resolution.

The Analysed column shows the number of residues for which the backbone conformation was analysed, and the total number of residues.

Mol	Chain	Analysed	Favoured	Allowed	Outliers	Percentiles	
1	A	1044/1057 (99%)	1013 (97%)	28 (3%)	3 (0%)	41	47
1	B	1036/1057 (98%)	1013 (98%)	23 (2%)	0	100	100
1	C	1035/1057 (98%)	1012 (98%)	23 (2%)	0	100	100
2	D	154/169 (91%)	151 (98%)	3 (2%)	0	100	100
2	E	152/169 (90%)	149 (98%)	3 (2%)	0	100	100
All	All	3421/3509 (98%)	3338 (98%)	80 (2%)	3 (0%)	51	63

All (3) Ramachandran outliers are listed below:

Mol	Chain	Res	Type
1	A	1037	ASN
1	A	677	ALA
1	A	869	SER

5.3.2 Protein sidechains [i](#)

In the following table, the Percentiles column shows the percent sidechain outliers of the chain as a percentile score with respect to all X-ray entries followed by that with respect to entries of similar resolution.

The Analysed column shows the number of residues for which the sidechain conformation was analysed, and the total number of residues.

Mol	Chain	Analysed	Rotameric	Outliers	Percentiles	
1	A	853/864 (99%)	843 (99%)	10 (1%)	71	82
1	B	845/864 (98%)	837 (99%)	8 (1%)	78	87
1	C	844/864 (98%)	834 (99%)	10 (1%)	71	82
2	D	120/132 (91%)	120 (100%)	0	100	100
2	E	119/132 (90%)	119 (100%)	0	100	100
All	All	2781/2856 (97%)	2753 (99%)	28 (1%)	78	85

5 of 28 residues with a non-rotameric sidechain are listed below:

Mol	Chain	Res	Type
1	B	717	ARG
1	C	1031[B]	ARG
1	B	1032	ARG
1	C	850	LYS
1	B	1030	ARG

Sometimes sidechains can be flipped to improve hydrogen bonding and reduce clashes. There are no such sidechains identified.

5.3.3 RNA [i](#)

There are no RNA molecules in this entry.

5.4 Non-standard residues in protein, DNA, RNA chains [i](#)

There are no non-standard protein/DNA/RNA residues in this entry.

5.5 Carbohydrates [i](#)

There are no monosaccharides in this entry.

5.6 Ligand geometry [i](#)

Of 83 ligands modelled in this entry, 3 are monoatomic - leaving 80 for Mogul analysis.

In the following table, the Counts columns list the number of bonds (or angles) for which Mogul statistics could be retrieved, the number of bonds (or angles) that are observed in the model and the number of bonds (or angles) that are defined in the Chemical Component Dictionary. The Link column lists molecule types, if any, to which the group is linked. The Z score for a bond length (or angle) is the number of standard deviations the observed value is removed from the expected value. A bond length (or angle) with $|Z| > 2$ is considered an outlier worth inspection. RMSZ is the root-mean-square of all Z scores of the bond lengths (or angles).

Mol	Type	Chain	Res	Link	Bond lengths			Bond angles		
					Counts	RMSZ	# Z > 2	Counts	RMSZ	# Z > 2
4	OCT	C	1105	-	7,7,7	0.11	0	6,6,6	0.06	0
3	LMT	B	1103	-	36,36,36	0.49	0	47,47,47	0.84	2 (4%)
9	EDO	B	1127	-	3,3,3	0.06	0	2,2,2	0.19	0
6	GOL	B	1111	-	5,5,5	0.10	0	5,5,5	0.27	0
3	LMT	A	1102	-	36,36,36	0.46	0	47,47,47	0.66	0
10	PGE	C	1129	-	9,9,9	0.15	0	8,8,8	0.12	0
16	PG4	B	1120	-	12,12,12	0.16	0	11,11,11	0.10	0
9	EDO	B	1130	-	3,3,3	0.07	0	2,2,2	0.18	0
9	EDO	B	1121	-	3,3,3	0.05	0	2,2,2	0.16	0
8	HEX	B	1117	-	5,5,5	0.14	0	4,4,4	0.11	0
7	D12	A	1112	-	11,11,11	0.25	0	10,10,10	0.49	0
13	D10	C	1108	-	9,9,9	0.10	0	8,8,8	0.06	0
11	MIY	B	1101	-	35,36,36	1.15	2 (5%)	41,58,58	1.05	2 (4%)
9	EDO	A	1115	-	3,3,3	0.06	0	2,2,2	0.19	0
6	GOL	A	1106	-	5,5,5	0.08	0	5,5,5	0.25	0
8	HEX	A	1113	-	5,5,5	0.14	0	4,4,4	0.10	0
7	D12	C	1115	-	11,11,11	0.26	0	10,10,10	0.45	0
9	EDO	D	201	-	3,3,3	0.05	0	2,2,2	0.15	0
8	HEX	B	1116	-	5,5,5	0.14	0	4,4,4	0.10	0
6	GOL	E	201	-	5,5,5	0.09	0	5,5,5	0.27	0
6	GOL	B	1112	-	5,5,5	0.09	0	5,5,5	0.27	0
8	HEX	C	1117	-	5,5,5	0.14	0	4,4,4	0.11	0
6	GOL	A	1108	-	5,5,5	0.09	0	5,5,5	0.27	0
9	EDO	D	203	-	3,3,3	0.06	0	2,2,2	0.18	0
9	EDO	C	1125	-	3,3,3	0.06	0	2,2,2	0.17	0
9	EDO	B	1125	-	3,3,3	0.06	0	2,2,2	0.18	0
4	OCT	C	1104	-	7,7,7	0.12	0	6,6,6	0.09	0
6	GOL	B	1110	-	5,5,5	0.09	0	5,5,5	0.25	0
9	EDO	A	1114	-	3,3,3	0.07	0	2,2,2	0.17	0
18	R16	B	1132	-	15,15,15	0.08	0	14,14,14	0.07	0
3	LMT	A	1101	-	36,36,36	0.44	0	47,47,47	0.62	0
19	SO4	B	1133	-	4,4,4	0.39	0	6,6,6	0.05	0

Mol	Type	Chain	Res	Link	Bond lengths			Bond angles		
					Counts	RMSZ	# Z > 2	Counts	RMSZ	# Z > 2
21	PTY	C	1103	-	49,49,49	0.26	0	52,54,54	0.35	0
9	EDO	C	1126	-	3,3,3	0.06	0	2,2,2	0.17	0
5	DDQ	C	1107	-	10,13,13	2.25	1 (10%)	12,15,15	0.49	0
13	D10	B	1107	-	9,9,9	0.10	0	8,8,8	0.07	0
7	D12	C	1116	-	11,11,11	0.26	0	10,10,10	0.50	0
8	HEX	B	1115	-	5,5,5	0.14	0	4,4,4	0.13	0
9	EDO	C	1122	-	3,3,3	0.05	0	2,2,2	0.19	0
9	EDO	B	1128	-	3,3,3	0.06	0	2,2,2	0.17	0
9	EDO	C	1123	-	3,3,3	0.06	0	2,2,2	0.16	0
9	EDO	C	1128	-	3,3,3	0.07	0	2,2,2	0.19	0
13	D10	B	1109	-	9,9,9	0.11	0	8,8,8	0.06	0
17	8K6	B	1131	-	17,17,17	0.18	0	16,16,16	0.06	0
15	MYS	B	1119	-	14,14,14	0.25	0	13,13,13	0.52	0
9	EDO	B	1126	-	3,3,3	0.06	0	2,2,2	0.18	0
9	EDO	D	202	-	3,3,3	0.06	0	2,2,2	0.17	0
3	LMT	A	1103	-	36,36,36	0.46	0	47,47,47	0.60	0
22	LPX	C	1119	-	29,29,29	0.28	0	31,33,33	0.37	0
20	C14	C	1101	-	13,13,13	0.09	0	12,12,12	0.08	0
5	DDQ	C	1106	-	10,13,13	2.27	1 (10%)	12,15,15	0.44	0
4	OCT	A	1104	-	7,7,7	0.11	0	6,6,6	0.07	0
3	LMT	C	1102	-	36,36,36	0.43	0	47,47,47	0.47	0
9	EDO	B	1129	-	3,3,3	0.06	0	2,2,2	0.16	0
6	GOL	A	1111	-	5,5,5	0.09	0	5,5,5	0.26	0
9	EDO	B	1123	-	3,3,3	0.07	0	2,2,2	0.21	0
6	GOL	A	1109	-	5,5,5	0.09	0	5,5,5	0.26	0
6	GOL	C	1110	-	5,5,5	0.09	0	5,5,5	0.28	0
6	GOL	B	1113	-	5,5,5	0.10	0	5,5,5	0.29	0
13	D10	B	1108	-	9,9,9	0.10	0	8,8,8	0.06	0
15	MYS	B	1118	-	14,14,14	0.23	0	13,13,13	0.58	0
10	PGE	A	1117	-	9,9,9	0.15	0	8,8,8	0.13	0
8	HEX	C	1118	-	5,5,5	0.14	0	4,4,4	0.10	0
9	EDO	B	1124	-	3,3,3	0.06	0	2,2,2	0.20	0
9	EDO	C	1124	-	3,3,3	0.06	0	2,2,2	0.16	0
5	DDQ	B	1106	-	10,13,13	2.33	1 (10%)	12,15,15	0.36	0
3	LMT	B	1102	-	36,36,36	0.44	0	47,47,47	0.49	0
13	D10	C	1109	-	9,9,9	0.12	0	8,8,8	0.13	0
6	GOL	A	1110	-	5,5,5	0.09	0	5,5,5	0.27	0
9	EDO	C	1127	-	3,3,3	0.06	0	2,2,2	0.18	0
6	GOL	A	1107	-	5,5,5	0.09	0	5,5,5	0.27	0
12	DDR	B	1104	-	27,27,27	1.23	2 (7%)	29,29,29	1.08	2 (6%)
6	GOL	C	1111	-	5,5,5	0.10	0	5,5,5	0.28	0
6	GOL	C	1112	-	5,5,5	0.08	0	5,5,5	0.25	0

Mol	Type	Chain	Res	Link	Bond lengths			Bond angles		
					Counts	RMSZ	# Z > 2	Counts	RMSZ	# Z > 2
5	DDQ	B	1105	-	10,13,13	2.27	1 (10%)	12,15,15	0.58	0
9	EDO	B	1122	-	3,3,3	0.06	0	2,2,2	0.15	0
23	1PE	C	1120	-	15,15,15	0.49	0	14,14,14	0.25	0
9	EDO	A	1116	-	3,3,3	0.06	0	2,2,2	0.18	0
9	EDO	C	1121	-	3,3,3	0.06	0	2,2,2	0.17	0
5	DDQ	A	1105	-	10,13,13	2.28	1 (10%)	12,15,15	0.48	0

In the following table, the Chirals column lists the number of chiral outliers, the number of chiral centers analysed, the number of these observed in the model and the number defined in the Chemical Component Dictionary. Similar counts are reported in the Torsion and Rings columns. '-' means no outliers of that kind were identified.

Mol	Type	Chain	Res	Link	Chirals	Torsions	Rings
4	OCT	C	1105	-	-	3/5/5/5	-
3	LMT	B	1103	-	-	7/21/61/61	0/2/2/2
9	EDO	B	1127	-	-	0/1/1/1	-
6	GOL	B	1111	-	-	0/4/4/4	-
3	LMT	A	1102	-	-	12/21/61/61	0/2/2/2
10	PGE	C	1129	-	-	6/7/7/7	-
16	PG4	B	1120	-	-	5/10/10/10	-
9	EDO	B	1130	-	-	1/1/1/1	-
9	EDO	B	1121	-	-	1/1/1/1	-
8	HEX	B	1117	-	-	2/3/3/3	-
7	D12	A	1112	-	-	4/9/9/9	-
13	D10	C	1108	-	-	4/7/7/7	-
11	MIY	B	1101	-	-	2/12/70/70	0/4/4/4
9	EDO	A	1115	-	-	1/1/1/1	-
6	GOL	A	1106	-	-	2/4/4/4	-
8	HEX	A	1113	-	-	1/3/3/3	-
7	D12	C	1115	-	-	4/9/9/9	-
9	EDO	D	201	-	-	0/1/1/1	-
8	HEX	B	1116	-	-	2/3/3/3	-
6	GOL	E	201	-	-	0/4/4/4	-
6	GOL	B	1112	-	-	0/4/4/4	-
8	HEX	C	1117	-	-	1/3/3/3	-
6	GOL	A	1108	-	-	2/4/4/4	-
9	EDO	D	203	-	-	1/1/1/1	-
9	EDO	C	1125	-	-	0/1/1/1	-
9	EDO	B	1125	-	-	1/1/1/1	-

Continued on next page...

Continued from previous page...

Mol	Type	Chain	Res	Link	Chirals	Torsions	Rings
4	OCT	C	1104	-	-	4/5/5/5	-
6	GOL	B	1110	-	-	2/4/4/4	-
9	EDO	A	1114	-	-	1/1/1/1	-
18	R16	B	1132	-	-	9/13/13/13	-
3	LMT	A	1101	-	-	9/21/61/61	0/2/2/2
21	PTY	C	1103	-	-	24/53/53/53	-
9	EDO	C	1126	-	-	1/1/1/1	-
5	DDQ	C	1107	-	-	6/11/11/11	-
13	D10	B	1107	-	-	1/7/7/7	-
7	D12	C	1116	-	-	3/9/9/9	-
8	HEX	B	1115	-	-	1/3/3/3	-
9	EDO	C	1122	-	-	1/1/1/1	-
9	EDO	B	1128	-	-	1/1/1/1	-
9	EDO	C	1123	-	-	1/1/1/1	-
9	EDO	C	1128	-	-	0/1/1/1	-
13	D10	B	1109	-	-	4/7/7/7	-
17	8K6	B	1131	-	-	9/15/15/15	-
15	MYS	B	1119	-	-	3/12/12/12	-
9	EDO	B	1126	-	-	1/1/1/1	-
9	EDO	D	202	-	-	1/1/1/1	-
3	LMT	A	1103	-	-	14/21/61/61	0/2/2/2
22	LPX	C	1119	-	-	16/31/31/31	-
20	C14	C	1101	-	-	6/11/11/11	-
5	DDQ	C	1106	-	-	5/11/11/11	-
4	OCT	A	1104	-	-	2/5/5/5	-
3	LMT	C	1102	-	-	7/21/61/61	0/2/2/2
9	EDO	B	1129	-	-	0/1/1/1	-
6	GOL	A	1111	-	-	2/4/4/4	-
9	EDO	B	1123	-	-	1/1/1/1	-
6	GOL	A	1109	-	-	0/4/4/4	-
6	GOL	C	1110	-	-	0/4/4/4	-
6	GOL	B	1113	-	-	2/4/4/4	-
13	D10	B	1108	-	-	2/7/7/7	-
15	MYS	B	1118	-	-	2/12/12/12	-
10	PGE	A	1117	-	-	4/7/7/7	-
8	HEX	C	1118	-	-	1/3/3/3	-
9	EDO	B	1124	-	-	1/1/1/1	-

Continued on next page...

Continued from previous page...

Mol	Type	Chain	Res	Link	Chirals	Torsions	Rings
9	EDO	C	1124	-	-	1/1/1/1	-
5	DDQ	B	1106	-	-	9/11/11/11	-
3	LMT	B	1102	-	-	8/21/61/61	0/2/2/2
13	D10	C	1109	-	-	6/7/7/7	-
6	GOL	A	1110	-	-	1/4/4/4	-
9	EDO	C	1127	-	-	1/1/1/1	-
6	GOL	A	1107	-	-	2/4/4/4	-
12	DDR	B	1104	-	-	14/29/29/29	-
6	GOL	C	1111	-	-	3/4/4/4	-
6	GOL	C	1112	-	-	3/4/4/4	-
5	DDQ	B	1105	-	-	3/11/11/11	-
9	EDO	B	1122	-	-	1/1/1/1	-
23	1PE	C	1120	-	-	8/13/13/13	-
9	EDO	A	1116	-	-	1/1/1/1	-
9	EDO	C	1121	-	-	0/1/1/1	-
5	DDQ	A	1105	-	-	8/11/11/11	-

The worst 5 of 9 bond length outliers are listed below:

Mol	Chain	Res	Type	Atoms	Z	Observed(Å)	Ideal(Å)
5	B	1106	DDQ	O1-N1	-7.30	1.25	1.42
5	A	1105	DDQ	O1-N1	-7.15	1.25	1.42
5	C	1106	DDQ	O1-N1	-7.13	1.25	1.42
5	B	1105	DDQ	O1-N1	-7.12	1.25	1.42
5	C	1107	DDQ	O1-N1	-7.05	1.25	1.42

The worst 5 of 6 bond angle outliers are listed below:

Mol	Chain	Res	Type	Atoms	Z	Observed(°)	Ideal(°)
12	B	1104	DDR	O52-C21-C22	3.66	119.40	111.50
3	B	1103	LMT	O1B-C4'-C3'	3.09	115.50	107.28
11	B	1101	MIY	C15-C16-C17	2.57	120.83	118.80
12	B	1104	DDR	O51-C1-C2	2.51	119.78	111.91
3	B	1103	LMT	C1B-C2B-C3B	2.37	114.92	110.00

There are no chirality outliers.

5 of 278 torsion outliers are listed below:

Mol	Chain	Res	Type	Atoms
3	A	1101	LMT	C2'-C1'-O1'-C1
3	A	1101	LMT	O5'-C1'-O1'-C1
3	A	1102	LMT	C2'-C1'-O1'-C1
3	A	1102	LMT	O5'-C1'-O1'-C1
3	A	1103	LMT	C2'-C1'-O1'-C1

There are no ring outliers.

3 monomers are involved in 5 short contacts:

Mol	Chain	Res	Type	Clashes	Symm-Clashes
3	B	1103	LMT	1	0
16	B	1120	PG4	3	0
20	C	1101	C14	1	0

The following is a two-dimensional graphical depiction of Mogul quality analysis of bond lengths, bond angles, torsion angles, and ring geometry for all instances of the Ligand of Interest. In addition, ligands with molecular weight > 250 and outliers as shown on the validation Tables will also be included. For torsion angles, if less than 5% of the Mogul distribution of torsion angles is within 10 degrees of the torsion angle in question, then that torsion angle is considered an outlier. Any bond that is central to one or more torsion angles identified as an outlier by Mogul will be highlighted in the graph. For rings, the root-mean-square deviation (RMSD) between the ring in question and similar rings identified by Mogul is calculated over all ring torsion angles. If the average RMSD is greater than 60 degrees and the minimal RMSD between the ring in question and any Mogul-identified rings is also greater than 60 degrees, then that ring is considered an outlier. The outliers are highlighted in purple. The color gray indicates Mogul did not find sufficient equivalents in the CSD to analyse the geometry.

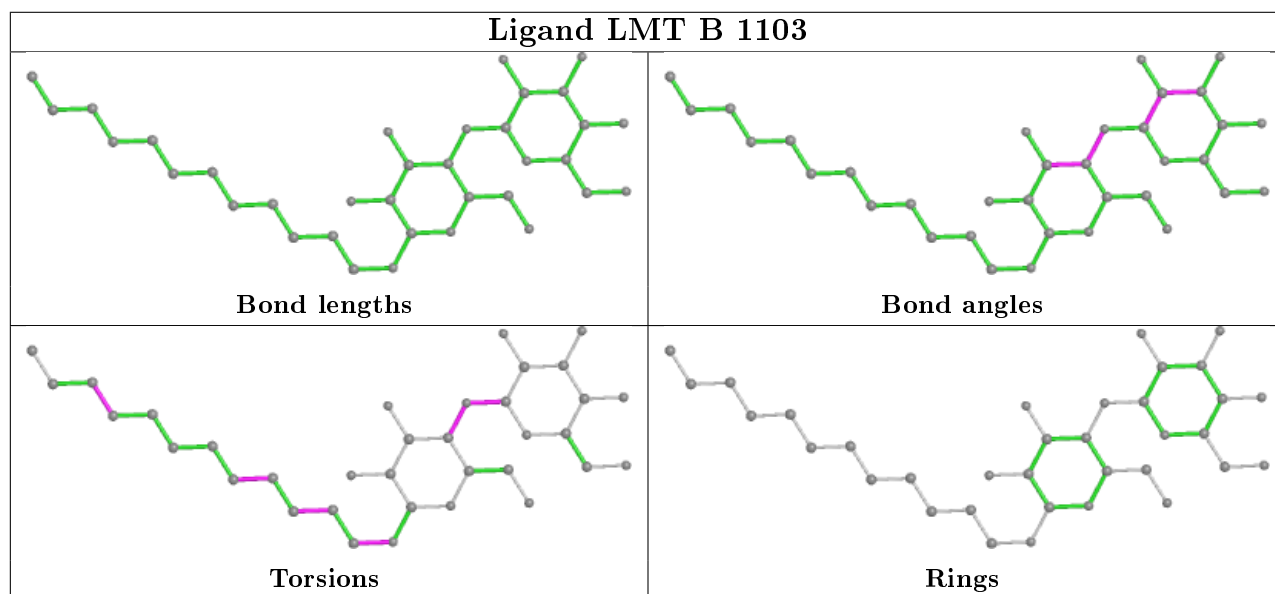

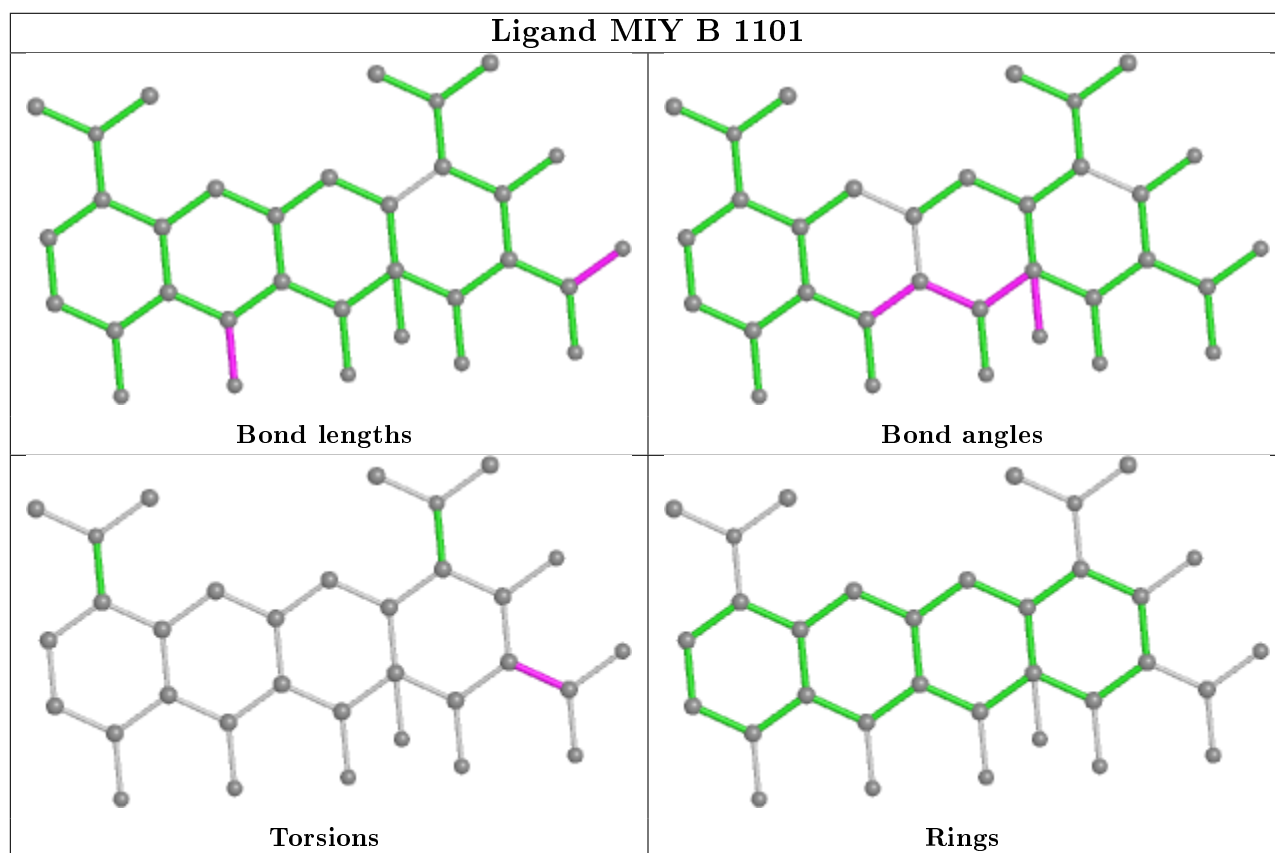
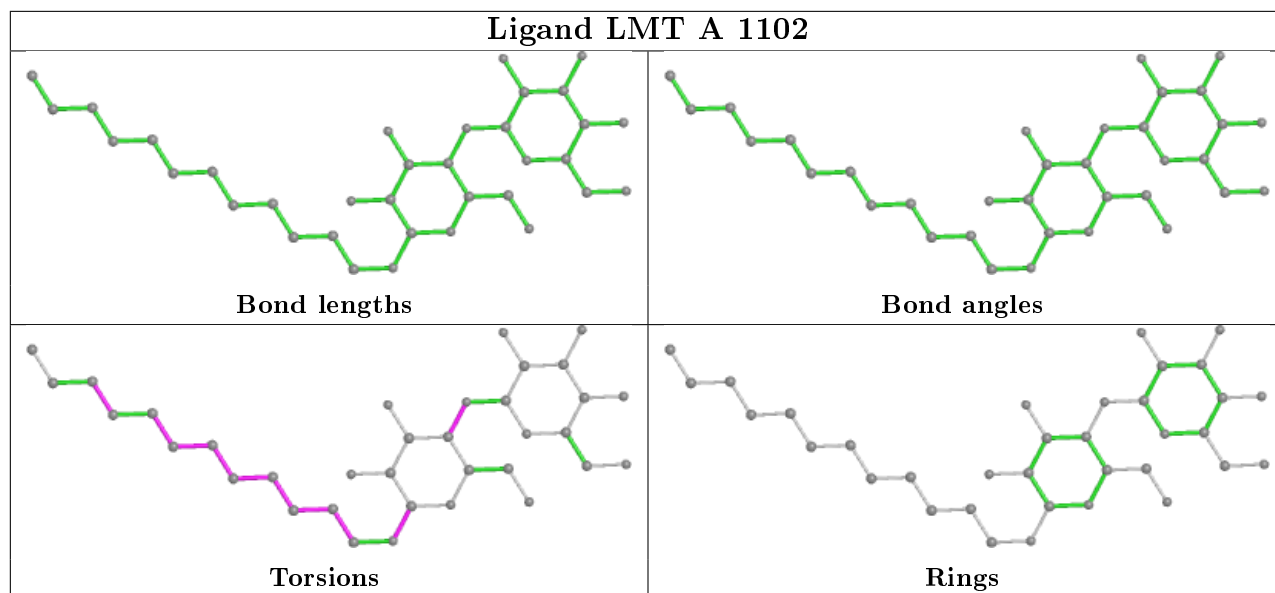

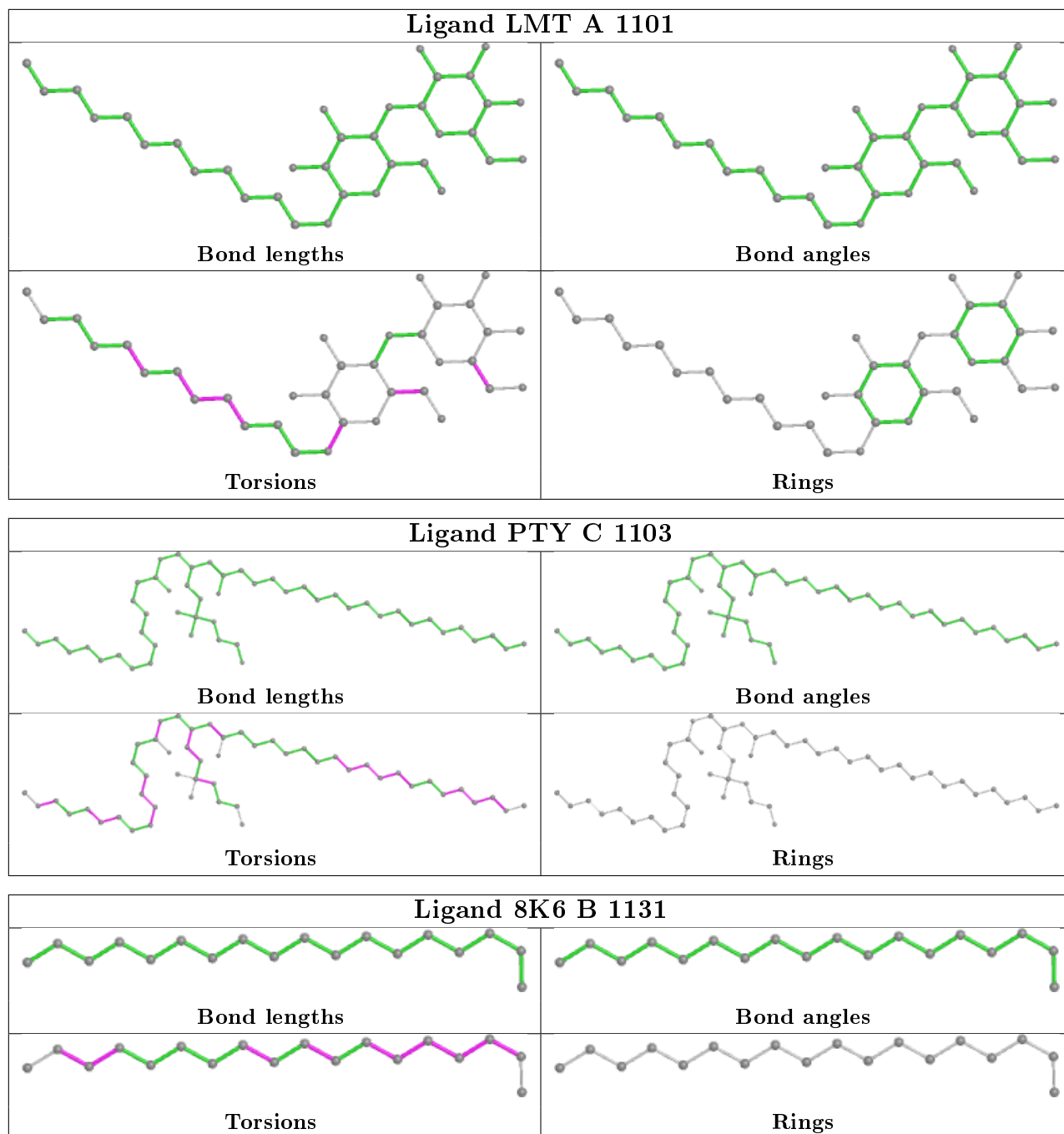

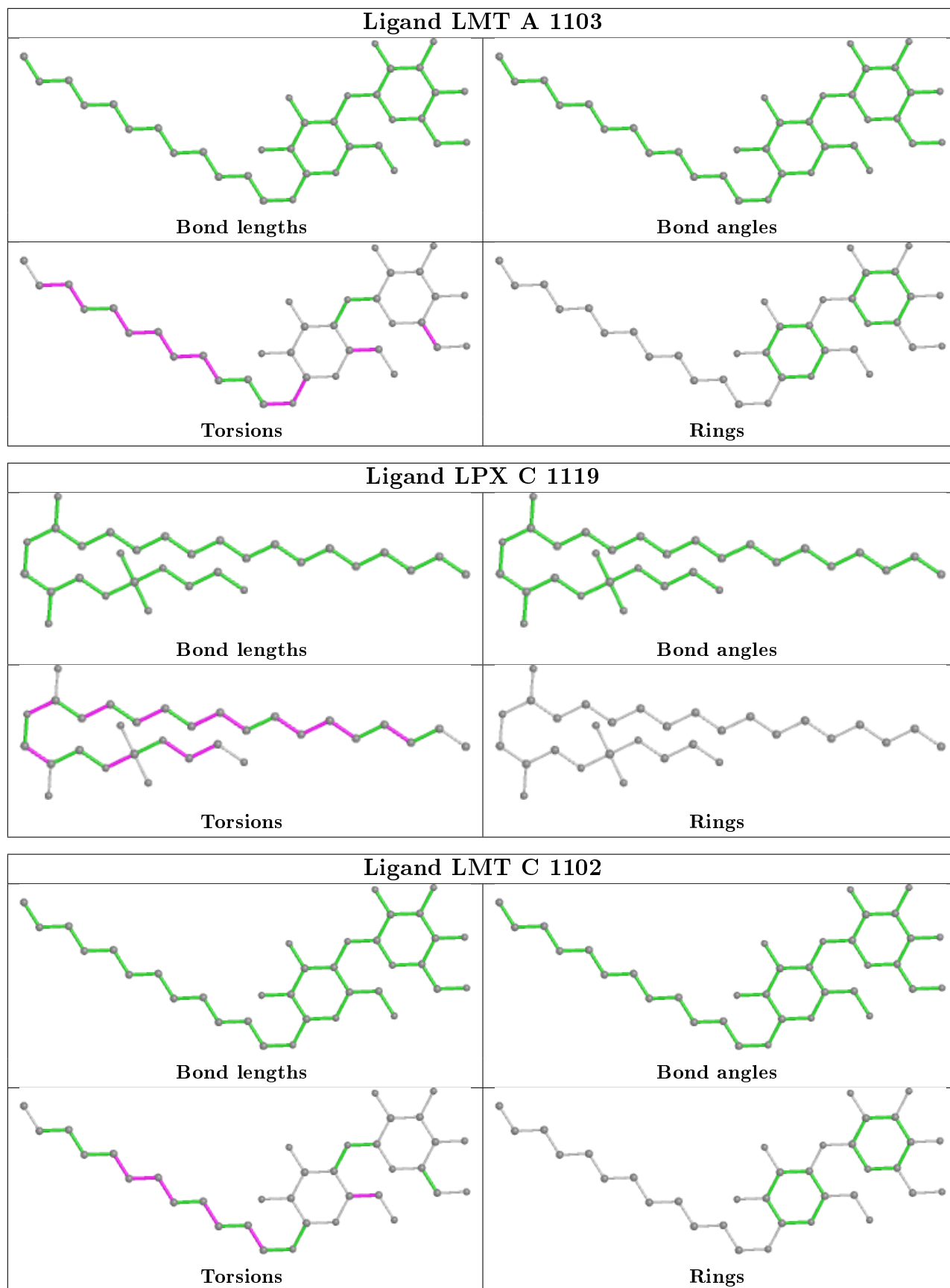

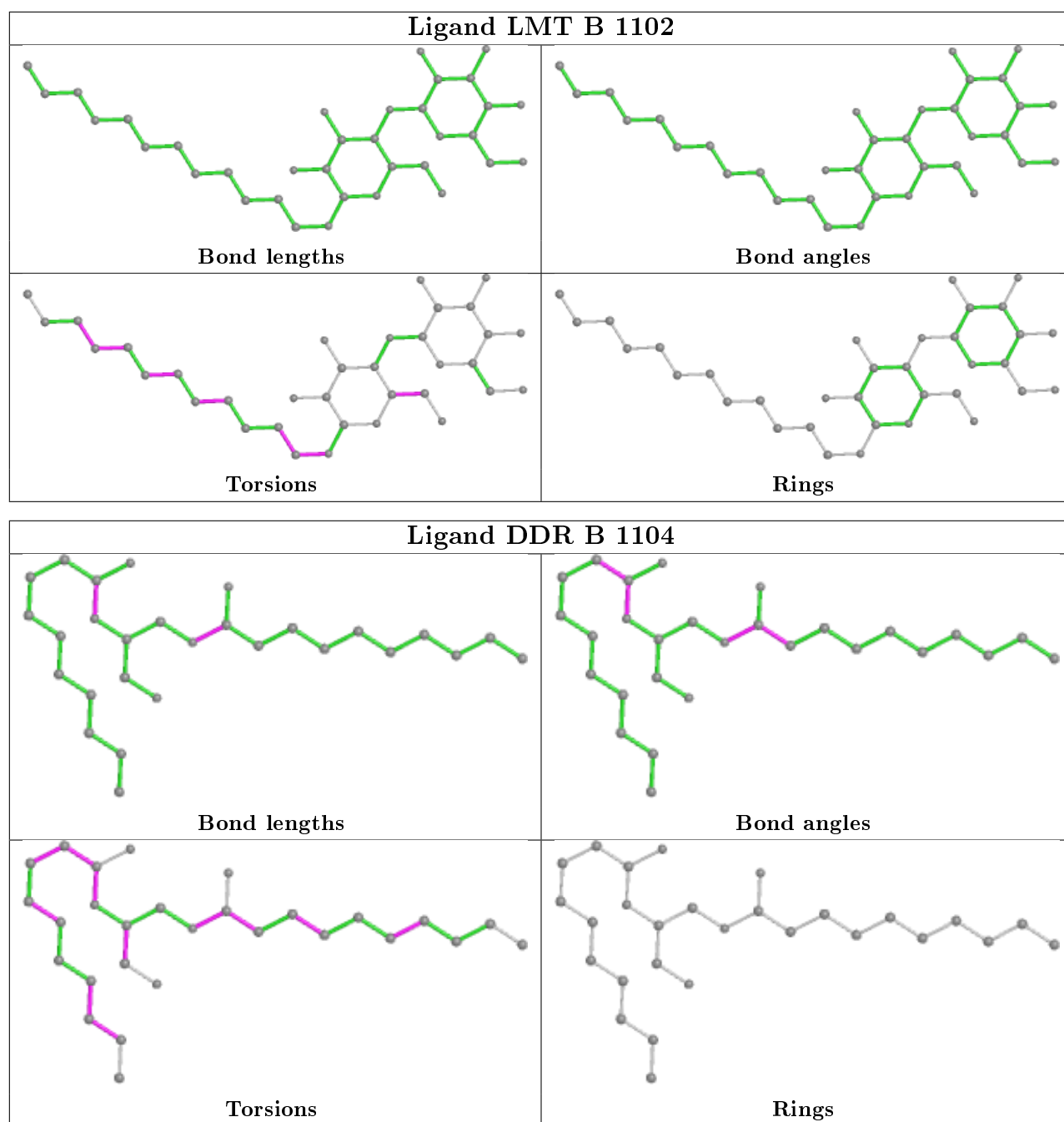

5.7 Other polymers [\(i\)](#)

There are no such residues in this entry.

5.8 Polymer linkage issues [\(i\)](#)

There are no chain breaks in this entry.

6 Fit of model and data [i](#)

6.1 Protein, DNA and RNA chains [i](#)

In the following table, the column labelled '#RSRZ > 2' contains the number (and percentage) of RSRZ outliers, followed by percent RSRZ outliers for the chain as percentile scores relative to all X-ray entries and entries of similar resolution. The OWAB column contains the minimum, median, 95th percentile and maximum values of the occupancy-weighted average B-factor per residue. The column labelled 'Q < 0.9' lists the number of (and percentage) of residues with an average occupancy less than 0.9.

Mol	Chain	Analysed	<RSRZ>	#RSRZ>2	OWAB(Å ²)	Q<0.9
1	A	1042/1057 (98%)	0.56	78 (7%) 14 21	27, 48, 79, 106	2 (0%)
1	B	1033/1057 (97%)	0.42	59 (5%) 23 34	28, 47, 66, 82	3 (0%)
1	C	1034/1057 (97%)	0.30	34 (3%) 46 59	29, 39, 55, 65	2 (0%)
2	D	156/169 (92%)	0.57	18 (11%) 4 7	38, 47, 67, 79	0
2	E	154/169 (91%)	1.19	36 (23%) 0 1	42, 58, 80, 82	0
All	All	3419/3509 (97%)	0.47	225 (6%) 18 26	27, 45, 71, 106	7 (0%)

The worst 5 of 225 RSRZ outliers are listed below:

Mol	Chain	Res	Type	RSRZ
2	E	34	MET	8.8
1	A	1040	ILE	7.8
1	A	868	LEU	7.1
1	B	677	ALA	6.9
1	B	617	PHE	6.3

6.2 Non-standard residues in protein, DNA, RNA chains [i](#)

There are no non-standard protein/DNA/RNA residues in this entry.

6.3 Carbohydrates [i](#)

There are no monosaccharides in this entry.

6.4 Ligands [i](#)

In the following table, the Atoms column lists the number of modelled atoms in the group and the number defined in the chemical component dictionary. The B-factors column lists the minimum,

median, 95th percentile and maximum values of B factors of atoms in the group. The column labelled 'Q< 0.9' lists the number of atoms with occupancy less than 0.9.

Mol	Type	Chain	Res	Atoms	RSCC	RSR	B-factors(Å ²)	Q<0.9
23	IPE	C	1120	16/16	0.60	0.53	71,71,72,72	0
5	DDQ	C	1107	14/14	0.66	0.23	50,51,53,53	0
10	PGE	A	1117	10/10	0.67	0.35	72,73,73,73	0
9	EDO	C	1122	4/4	0.69	0.55	68,68,68,68	0
6	GOL	B	1113	6/6	0.73	0.49	64,65,65,65	0
13	D10	B	1109	10/10	0.73	0.26	45,45,45,45	0
6	GOL	A	1109	6/6	0.73	0.18	73,74,74,74	0
3	LMT	A	1102	35/35	0.74	0.22	70,78,83,83	0
5	DDQ	B	1105	14/14	0.74	0.18	68,70,73,73	0
13	D10	C	1109	10/10	0.74	0.22	53,53,53,53	0
3	LMT	A	1101	35/35	0.74	0.29	73,81,85,86	0
9	EDO	A	1116	4/4	0.75	0.19	63,63,63,63	0
6	GOL	A	1110	6/6	0.75	0.30	65,65,65,65	0
21	PTY	C	1103	50/50	0.76	0.27	71,73,75,75	0
13	D10	C	1108	10/10	0.77	0.27	60,60,60,60	0
3	LMT	B	1103	35/35	0.77	0.31	105,107,109,109	0
8	HEX	C	1117	6/6	0.78	0.26	50,50,50,50	0
5	DDQ	C	1106	14/14	0.78	0.20	72,73,75,75	0
13	D10	B	1107	10/10	0.78	0.20	68,68,68,68	0
9	EDO	B	1126	4/4	0.78	0.40	67,67,67,67	0
20	C14	C	1101	14/14	0.79	0.16	47,47,48,48	0
15	MYS	B	1119	15/15	0.80	0.17	71,71,72,72	0
6	GOL	A	1108	6/6	0.80	0.33	70,70,70,70	0
8	HEX	B	1115	6/6	0.81	0.18	68,68,69,69	0
9	EDO	B	1127	4/4	0.81	0.19	63,64,64,64	0
9	EDO	B	1128	4/4	0.81	0.25	56,56,56,57	0
4	OCT	C	1105	8/8	0.81	0.19	46,47,47,47	0
17	8K6	B	1131	18/18	0.81	0.22	44,45,45,45	0
9	EDO	A	1114	4/4	0.81	0.23	59,59,59,59	0
11	MIY	B	1101	33/33	0.81	0.21	76,76,77,77	0
6	GOL	A	1106	6/6	0.81	0.22	46,47,47,47	0
9	EDO	B	1123	4/4	0.82	0.26	62,63,63,63	0
6	GOL	E	201	6/6	0.82	0.25	67,67,67,67	0
7	D12	C	1115	12/12	0.82	0.24	60,61,62,62	0
4	OCT	C	1104	8/8	0.82	0.28	46,46,46,46	0
12	DDR	B	1104	28/28	0.83	0.24	67,71,71,72	0
9	EDO	B	1122	4/4	0.84	0.29	68,68,68,69	0
6	GOL	A	1111	6/6	0.84	0.27	64,65,65,65	0
9	EDO	C	1124	4/4	0.84	0.23	67,67,67,67	0
9	EDO	C	1125	4/4	0.85	0.28	56,56,56,57	0
9	EDO	D	203	4/4	0.85	0.14	56,56,56,57	0

Continued on next page...

Continued from previous page...

Mol	Type	Chain	Res	Atoms	RSCC	RSR	B-factors(Å ²)	Q<0.9
8	HEX	C	1118	6/6	0.85	0.18	44,44,44,44	0
6	GOL	B	1111	6/6	0.85	0.34	76,76,76,77	0
5	DDQ	B	1106	14/14	0.85	0.32	50,51,52,52	0
8	HEX	B	1117	6/6	0.85	0.16	45,45,45,45	0
5	DDQ	A	1105	14/14	0.85	0.23	95,95,96,96	0
6	GOL	C	1112	6/6	0.86	0.18	65,65,65,65	0
8	HEX	A	1113	6/6	0.86	0.22	65,65,65,66	0
10	PGE	C	1129	10/10	0.86	0.26	65,65,66,66	0
22	LPX	C	1119	30/30	0.86	0.26	76,78,79,79	0
13	D10	B	1108	10/10	0.86	0.12	45,45,45,45	0
9	EDO	C	1127	4/4	0.87	0.20	62,62,62,62	0
7	D12	C	1116	12/12	0.87	0.37	43,43,43,43	0
8	HEX	B	1116	6/6	0.87	0.18	54,54,55,55	0
9	EDO	B	1129	4/4	0.87	0.27	56,56,56,56	0
16	PG4	B	1120	13/13	0.87	0.21	58,59,60,60	0
3	LMT	B	1102	35/35	0.88	0.28	69,71,78,78	0
6	GOL	A	1107	6/6	0.88	0.20	45,45,46,46	0
9	EDO	D	202	4/4	0.88	0.24	56,56,56,56	0
7	D12	A	1112	12/12	0.88	0.14	61,61,61,61	0
9	EDO	C	1128	4/4	0.89	0.16	58,58,58,58	0
6	GOL	B	1110	6/6	0.89	0.20	47,48,48,48	0
9	EDO	B	1125	4/4	0.89	0.11	65,65,65,65	0
18	R16	B	1132	16/16	0.89	0.12	42,43,44,44	0
15	MYS	B	1118	15/15	0.90	0.23	67,68,68,68	0
3	LMT	A	1103	35/35	0.90	0.24	83,84,88,88	0
9	EDO	A	1115	4/4	0.90	0.20	70,70,70,70	0
9	EDO	D	201	4/4	0.91	0.20	67,67,67,67	0
9	EDO	C	1123	4/4	0.91	0.30	57,57,57,58	0
6	GOL	B	1112	6/6	0.91	0.64	73,74,74,74	0
4	OCT	A	1104	8/8	0.91	0.17	76,76,76,76	0
9	EDO	C	1126	4/4	0.91	0.29	56,56,56,57	0
9	EDO	C	1121	4/4	0.91	0.19	60,60,61,61	0
3	LMT	C	1102	35/35	0.91	0.18	60,62,66,66	0
9	EDO	B	1130	4/4	0.92	0.14	54,54,54,54	0
9	EDO	B	1121	4/4	0.92	0.24	61,61,61,62	0
6	GOL	C	1111	6/6	0.92	0.20	50,50,50,51	0
9	EDO	B	1124	4/4	0.94	0.26	49,49,49,49	0
6	GOL	C	1110	6/6	0.94	0.17	33,33,33,33	0
14	CL	C	1114	1/1	0.96	0.11	65,65,65,65	0
14	CL	C	1113	1/1	0.97	0.12	57,57,57,57	0
19	SO4	B	1133	5/5	0.97	0.15	71,71,72,72	0
14	CL	B	1114	1/1	0.98	0.21	55,55,55,55	0

The following is a graphical depiction of the model fit to experimental electron density of all instances of the Ligand of Interest. In addition, ligands with molecular weight > 250 and outliers as shown on the geometry validation Tables will also be included. Each fit is shown from different orientation to approximate a three-dimensional view.

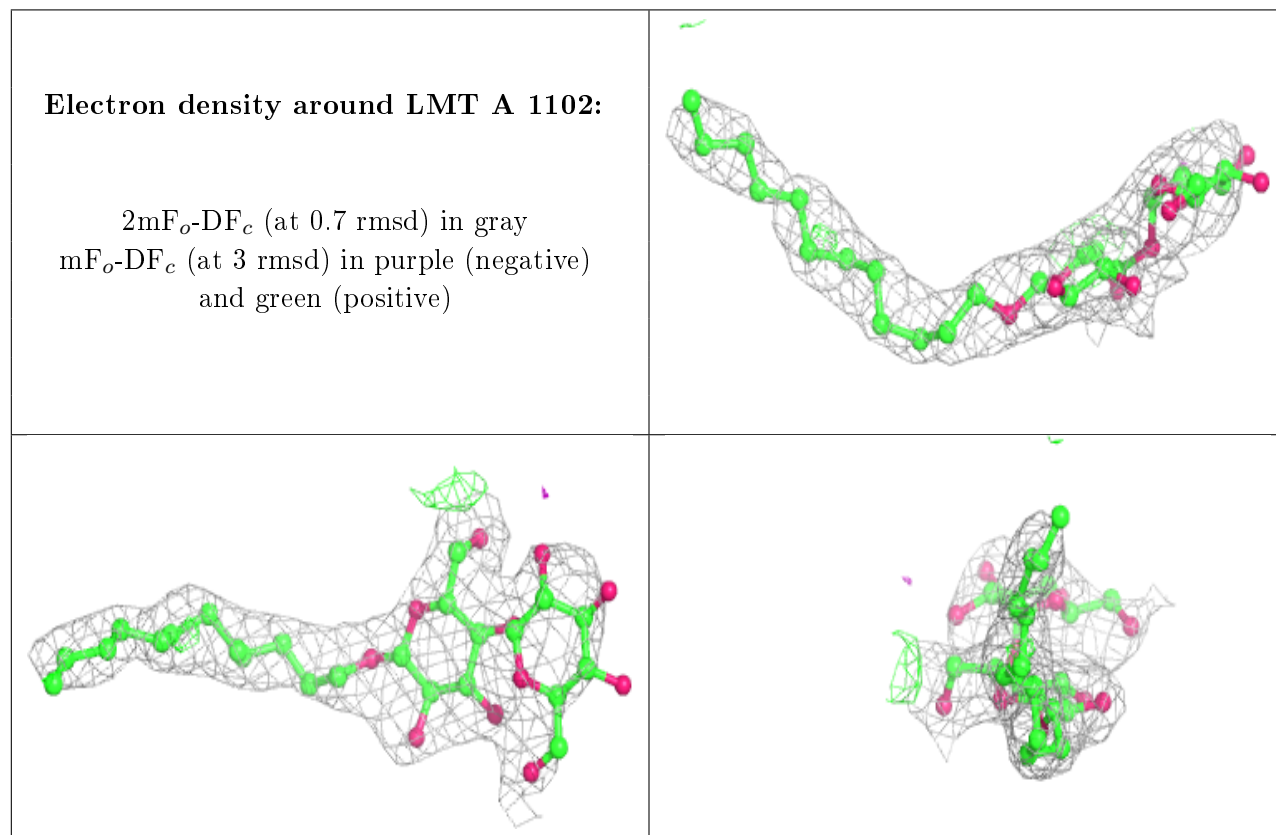

Electron density around LMT A 1101:

$2mF_o-DF_c$ (at 0.7 rmsd) in gray
 mF_o-DF_c (at 3 rmsd) in purple (negative)
and green (positive)

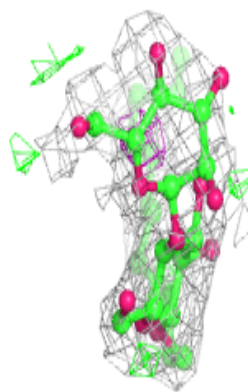
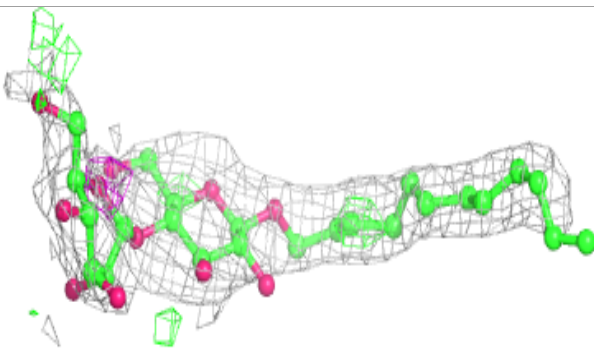
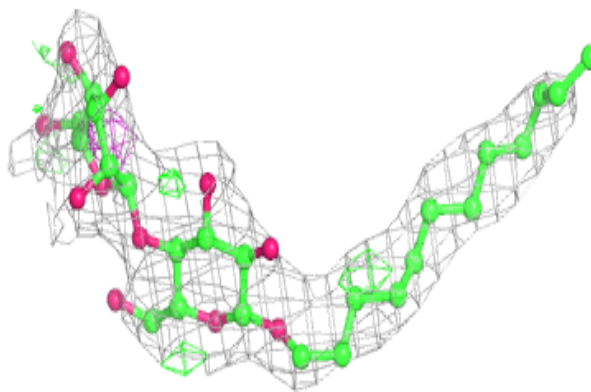
**Electron density around PTY C 1103:**

$2mF_o-DF_c$ (at 0.7 rmsd) in gray
 mF_o-DF_c (at 3 rmsd) in purple (negative)
and green (positive)

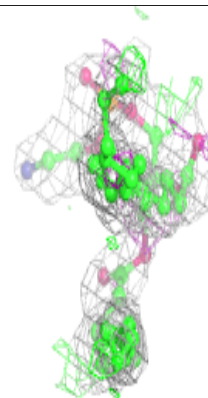
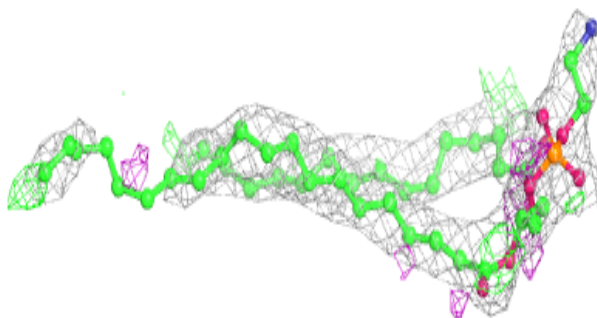
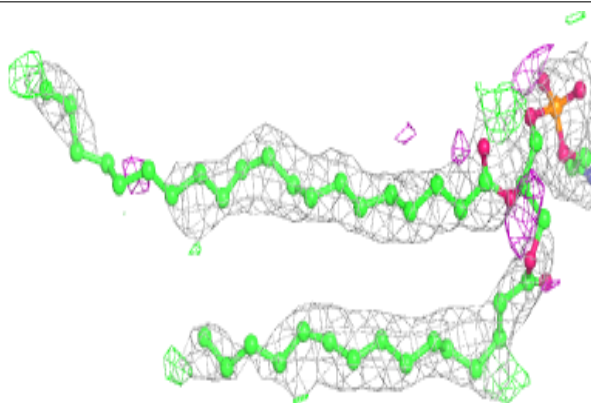

Electron density around LMT B 1103:

$2mF_o-DF_c$ (at 0.7 rmsd) in gray
 mF_o-DF_c (at 3 rmsd) in purple (negative)
and green (positive)

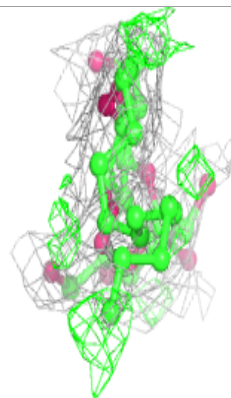
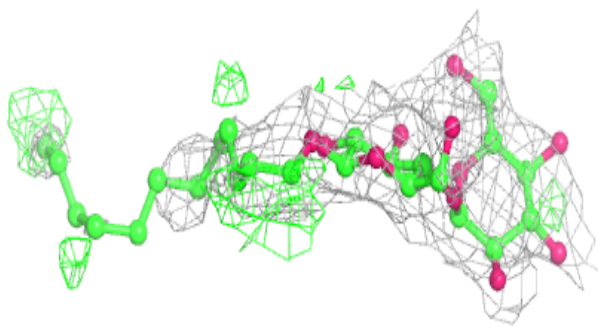
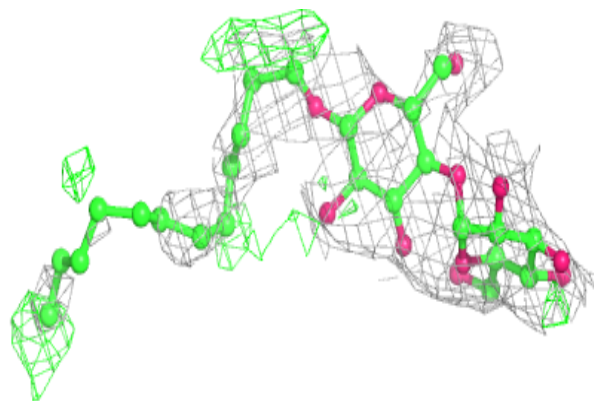
**Electron density around 8K6 B 1131:**

$2mF_o-DF_c$ (at 0.7 rmsd) in gray
 mF_o-DF_c (at 3 rmsd) in purple (negative)
and green (positive)

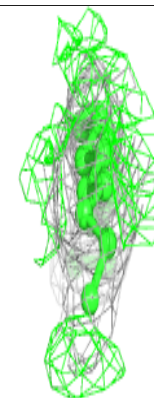
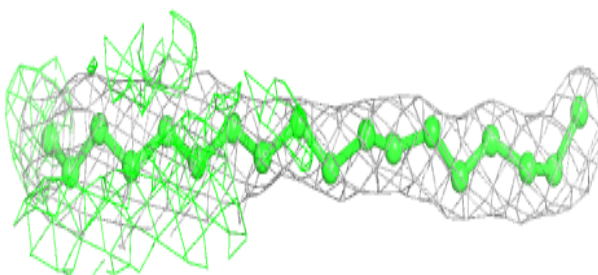
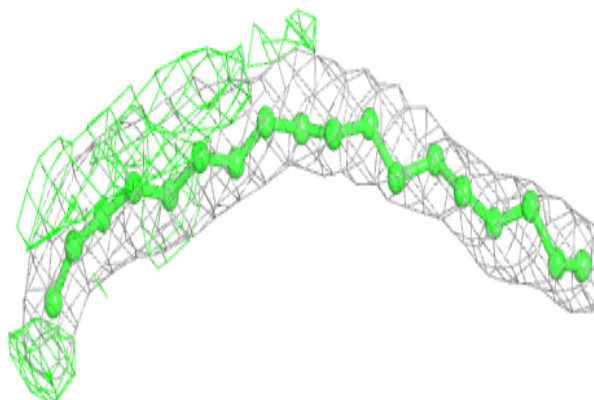

Electron density around MIY B 1101:

$2mF_o-DF_c$ (at 0.7 rmsd) in gray
 mF_o-DF_c (at 3 rmsd) in purple (negative)
and green (positive)

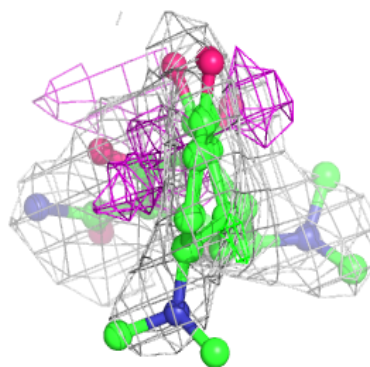
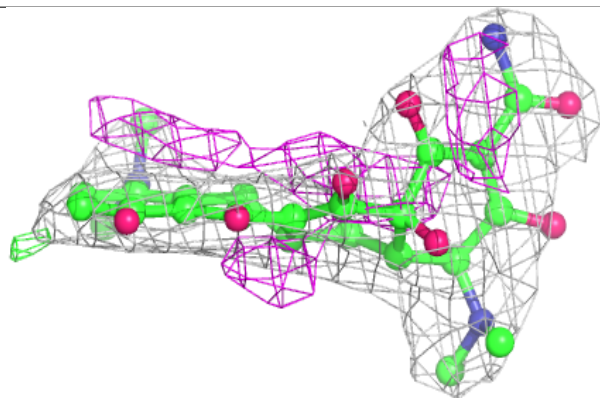
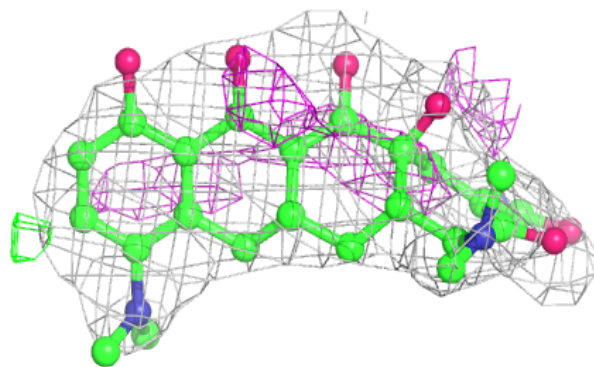
**Electron density around DDR B 1104:**

$2mF_o-DF_c$ (at 0.7 rmsd) in gray
 mF_o-DF_c (at 3 rmsd) in purple (negative)
and green (positive)

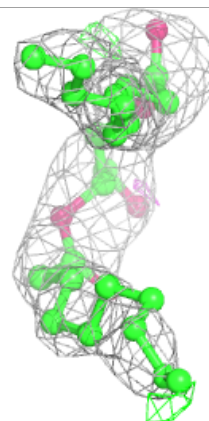
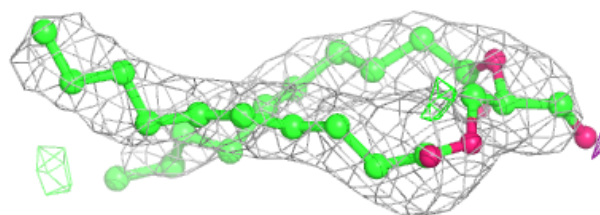
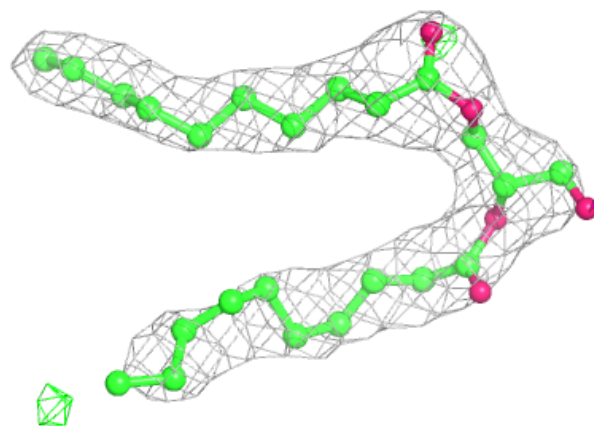

Electron density around LPX C 1119:

$2mF_o-DF_c$ (at 0.7 rmsd) in gray
 mF_o-DF_c (at 3 rmsd) in purple (negative)
and green (positive)

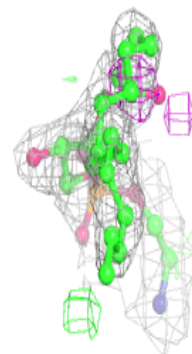
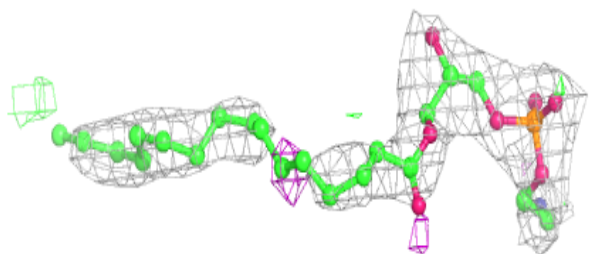
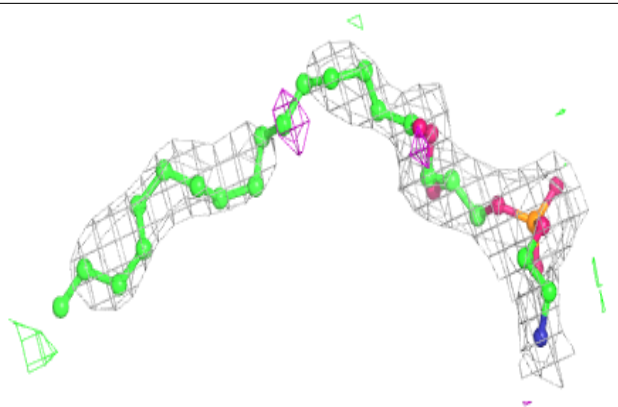
**Electron density around LMT B 1102:**

$2mF_o-DF_c$ (at 0.7 rmsd) in gray
 mF_o-DF_c (at 3 rmsd) in purple (negative)
and green (positive)

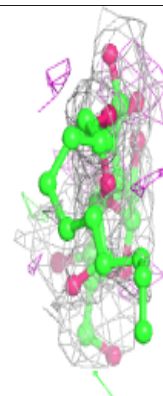
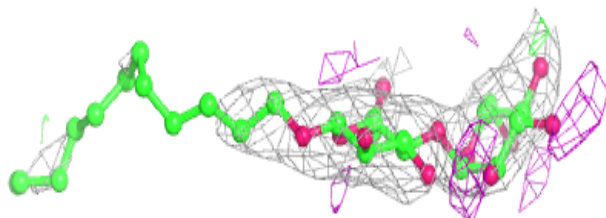
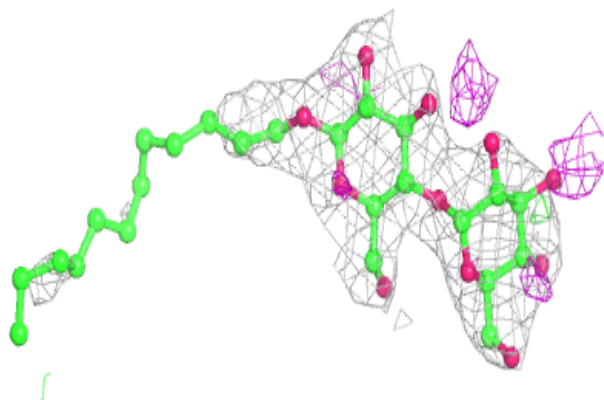

Electron density around LMT A 1103:

$2mF_o-DF_c$ (at 0.7 rmsd) in gray
 mF_o-DF_c (at 3 rmsd) in purple (negative)
and green (positive)

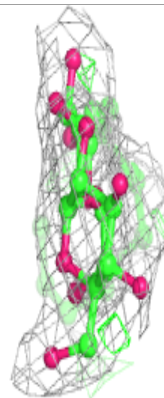
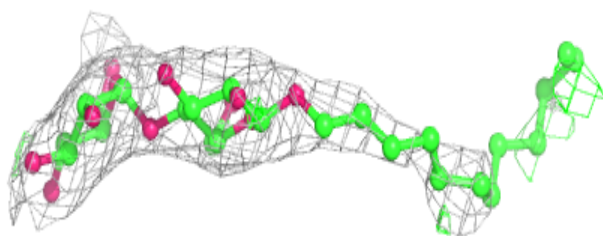
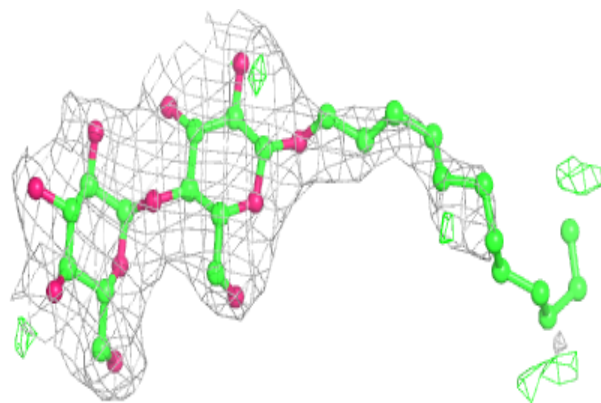
**Electron density around LMT C 1102:**

$2mF_o-DF_c$ (at 0.7 rmsd) in gray
 mF_o-DF_c (at 3 rmsd) in purple (negative)
and green (positive)

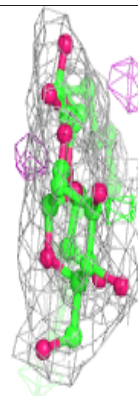
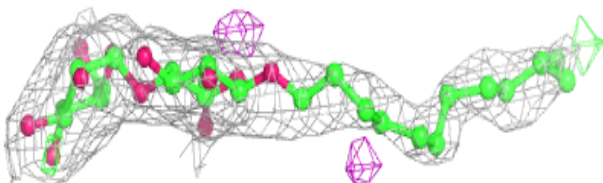
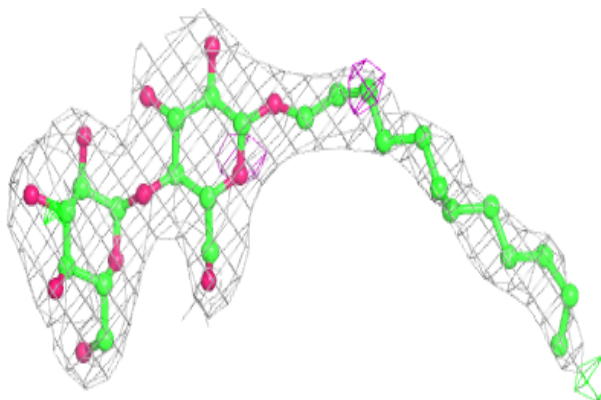

6.5 Other polymers

There are no such residues in this entry.