



wwPDB X-ray Structure Validation Summary Report ⓘ

Mar 10, 2021 – 02:22 am GMT

PDB ID : 6ZN9
Title : MaeB PTA domain apoprotein
Authors : Lovering, A.L.; Harding, C.J.
Deposited on : 2020-07-06
Resolution : 2.72 Å(reported)

This is a wwPDB X-ray Structure Validation Summary Report for a publicly released PDB entry.

We welcome your comments at validation@mail.wwpdb.org

A user guide is available at

<https://www.wwpdb.org/validation/2017/XrayValidationReportHelp>

with specific help available everywhere you see the ⓘ symbol.

The following versions of software and data (see [references ⓘ](#)) were used in the production of this report:

MolProbity : 4.02b-467
Xtriage (Phenix) : 1.13
EDS : 2.17.1
Percentile statistics : 20191225.v01 (using entries in the PDB archive December 25th 2019)
Refmac : 5.8.0158
CCP4 : 7.0.044 (Gargrove)
Ideal geometry (proteins) : Engh & Huber (2001)
Ideal geometry (DNA, RNA) : Parkinson et al. (1996)
Validation Pipeline (wwPDB-VP) : 2.17.1

1 Overall quality at a glance i

The following experimental techniques were used to determine the structure:
X-RAY DIFFRACTION

The reported resolution of this entry is 2.72 Å.

Percentile scores (ranging between 0-100) for global validation metrics of the entry are shown in the following graphic. The table shows the number of entries on which the scores are based.

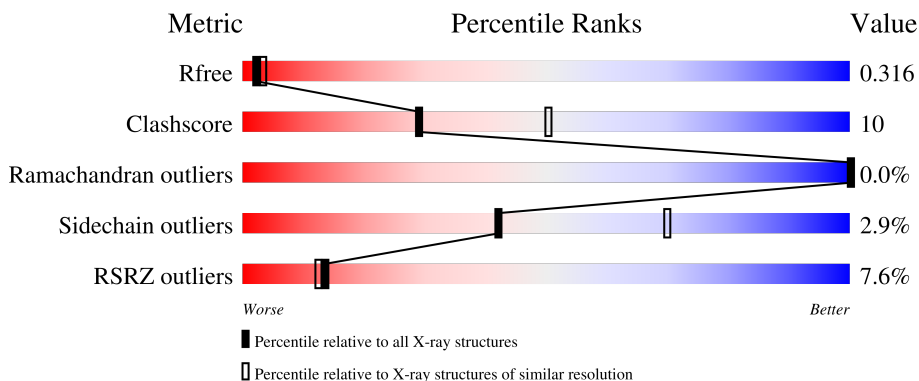



Metric	Whole archive (#Entries)	Similar resolution (#Entries, resolution range(Å))
R_{free}	130704	3359 (2.74-2.70)
Clashscore	141614	3686 (2.74-2.70)
Ramachandran outliers	138981	3622 (2.74-2.70)
Sidechain outliers	138945	3623 (2.74-2.70)
RSRZ outliers	127900	3276 (2.74-2.70)

The table below summarises the geometric issues observed across the polymeric chains and their fit to the electron density. The red, orange, yellow and green segments of the lower bar indicate the fraction of residues that contain outliers for ≥ 3 , 2, 1 and 0 types of geometric quality criteria respectively. A grey segment represents the fraction of residues that are not modelled. The numeric value for each fraction is indicated below the corresponding segment, with a dot representing fractions $\leq 5\%$. The upper red bar (where present) indicates the fraction of residues that have poor fit to the electron density. The numeric value is given above the bar.

Mol	Chain	Length	Quality of chain
1	A	362	 7% 77% 16% • 6%
1	B	362	 4% 70% 22% • 6%
1	C	362	 3% 75% 17% • 7%
1	D	362	 3% 71% 21% • 6%
1	E	362	 8% 76% 17% • 6%

Continued on next page...

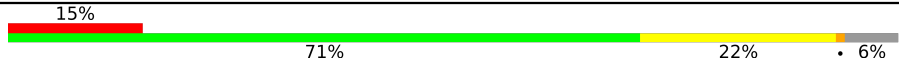
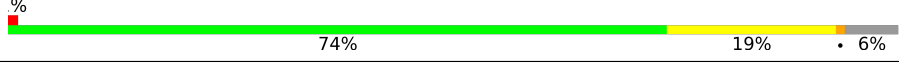
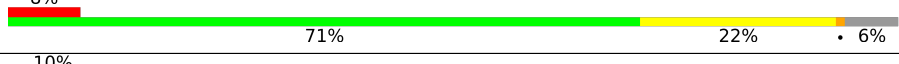
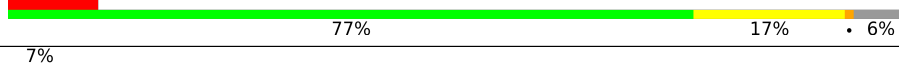
Continued from previous page...

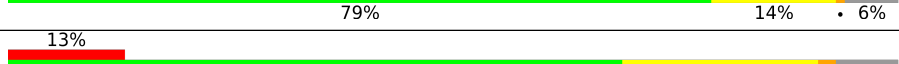
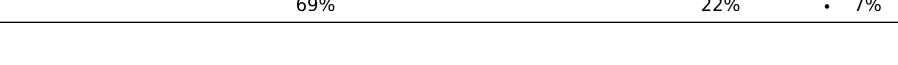
Mol	Chain	Length	Quality of chain
1	F	362	 <p>15% 71% 22% • 6%</p>
1	G	362	 <p>% 74% 19% • 6%</p>
1	H	362	 <p>8% 71% 22% • 6%</p>
1	I	362	 <p>10% 77% 17% • 6%</p>
1	J	362	 <p>7% 69% 24% • 7%</p>
1	K	362	 <p>7% 79% 14% • 6%</p>
1	L	362	 <p>13% 69% 22% • 7%</p>

2 Entry composition

There is only 1 type of molecule in this entry. The entry contains 31258 atoms, of which 0 are hydrogens and 0 are deuteriums.

In the tables below, the ZeroOcc column contains the number of atoms modelled with zero occupancy, the AltConf column contains the number of residues with at least one atom in alternate conformation and the Trace column contains the number of residues modelled with at most 2 atoms.

- Molecule 1 is a protein called Malate dehydrogenase.

Mol	Chain	Residues	Atoms					ZeroOcc	AltConf	Trace
			Total	C	N	O	S			
1	C	338	2598	1658	444	485	11	0	0	0
1	D	341	2611	1665	447	488	11	0	0	0
1	A	340	2606	1663	446	486	11	0	0	0
1	B	341	2610	1665	447	487	11	0	0	0
1	F	339	2602	1661	445	485	11	0	0	0
1	G	340	2607	1663	446	487	11	0	0	0
1	J	338	2598	1658	444	485	11	0	0	0
1	L	338	2598	1658	444	485	11	0	0	0
1	H	340	2607	1663	446	487	11	0	0	0
1	I	340	2607	1663	446	487	11	0	0	0
1	K	340	2607	1663	446	487	11	0	0	0
1	E	340	2607	1663	446	487	11	0	0	0

There are 240 discrepancies between the modelled and reference sequences:

Chain	Residue	Modelled	Actual	Comment	Reference
C	419	MET	-	initiating methionine	UNP Q6MM15
C	420	GLY	-	expression tag	UNP Q6MM15
C	421	SER	-	expression tag	UNP Q6MM15
C	422	SER	-	expression tag	UNP Q6MM15
C	423	HIS	-	expression tag	UNP Q6MM15

Continued on next page...

Continued from previous page...

Chain	Residue	Modelled	Actual	Comment	Reference
C	424	HIS	-	expression tag	UNP Q6MM15
C	425	HIS	-	expression tag	UNP Q6MM15
C	426	HIS	-	expression tag	UNP Q6MM15
C	427	HIS	-	expression tag	UNP Q6MM15
C	428	HIS	-	expression tag	UNP Q6MM15
C	429	SER	-	expression tag	UNP Q6MM15
C	430	SER	-	expression tag	UNP Q6MM15
C	431	GLY	-	expression tag	UNP Q6MM15
C	432	LEU	-	expression tag	UNP Q6MM15
C	433	VAL	-	expression tag	UNP Q6MM15
C	434	PRO	-	expression tag	UNP Q6MM15
C	435	ALA	-	expression tag	UNP Q6MM15
C	436	GLY	-	expression tag	UNP Q6MM15
C	437	SER	-	expression tag	UNP Q6MM15
C	438	HIS	-	expression tag	UNP Q6MM15
D	419	MET	-	initiating methionine	UNP Q6MM15
D	420	GLY	-	expression tag	UNP Q6MM15
D	421	SER	-	expression tag	UNP Q6MM15
D	422	SER	-	expression tag	UNP Q6MM15
D	423	HIS	-	expression tag	UNP Q6MM15
D	424	HIS	-	expression tag	UNP Q6MM15
D	425	HIS	-	expression tag	UNP Q6MM15
D	426	HIS	-	expression tag	UNP Q6MM15
D	427	HIS	-	expression tag	UNP Q6MM15
D	428	HIS	-	expression tag	UNP Q6MM15
D	429	SER	-	expression tag	UNP Q6MM15
D	430	SER	-	expression tag	UNP Q6MM15
D	431	GLY	-	expression tag	UNP Q6MM15
D	432	LEU	-	expression tag	UNP Q6MM15
D	433	VAL	-	expression tag	UNP Q6MM15
D	434	PRO	-	expression tag	UNP Q6MM15
D	435	ALA	-	expression tag	UNP Q6MM15
D	436	GLY	-	expression tag	UNP Q6MM15
D	437	SER	-	expression tag	UNP Q6MM15
D	438	HIS	-	expression tag	UNP Q6MM15
A	419	MET	-	initiating methionine	UNP Q6MM15
A	420	GLY	-	expression tag	UNP Q6MM15
A	421	SER	-	expression tag	UNP Q6MM15
A	422	SER	-	expression tag	UNP Q6MM15
A	423	HIS	-	expression tag	UNP Q6MM15
A	424	HIS	-	expression tag	UNP Q6MM15
A	425	HIS	-	expression tag	UNP Q6MM15

Continued on next page...

Continued from previous page...

Chain	Residue	Modelled	Actual	Comment	Reference
A	426	HIS	-	expression tag	UNP Q6MM15
A	427	HIS	-	expression tag	UNP Q6MM15
A	428	HIS	-	expression tag	UNP Q6MM15
A	429	SER	-	expression tag	UNP Q6MM15
A	430	SER	-	expression tag	UNP Q6MM15
A	431	GLY	-	expression tag	UNP Q6MM15
A	432	LEU	-	expression tag	UNP Q6MM15
A	433	VAL	-	expression tag	UNP Q6MM15
A	434	PRO	-	expression tag	UNP Q6MM15
A	435	ALA	-	expression tag	UNP Q6MM15
A	436	GLY	-	expression tag	UNP Q6MM15
A	437	SER	-	expression tag	UNP Q6MM15
A	438	HIS	-	expression tag	UNP Q6MM15
B	419	MET	-	initiating methionine	UNP Q6MM15
B	420	GLY	-	expression tag	UNP Q6MM15
B	421	SER	-	expression tag	UNP Q6MM15
B	422	SER	-	expression tag	UNP Q6MM15
B	423	HIS	-	expression tag	UNP Q6MM15
B	424	HIS	-	expression tag	UNP Q6MM15
B	425	HIS	-	expression tag	UNP Q6MM15
B	426	HIS	-	expression tag	UNP Q6MM15
B	427	HIS	-	expression tag	UNP Q6MM15
B	428	HIS	-	expression tag	UNP Q6MM15
B	429	SER	-	expression tag	UNP Q6MM15
B	430	SER	-	expression tag	UNP Q6MM15
B	431	GLY	-	expression tag	UNP Q6MM15
B	432	LEU	-	expression tag	UNP Q6MM15
B	433	VAL	-	expression tag	UNP Q6MM15
B	434	PRO	-	expression tag	UNP Q6MM15
B	435	ALA	-	expression tag	UNP Q6MM15
B	436	GLY	-	expression tag	UNP Q6MM15
B	437	SER	-	expression tag	UNP Q6MM15
B	438	HIS	-	expression tag	UNP Q6MM15
F	419	MET	-	initiating methionine	UNP Q6MM15
F	420	GLY	-	expression tag	UNP Q6MM15
F	421	SER	-	expression tag	UNP Q6MM15
F	422	SER	-	expression tag	UNP Q6MM15
F	423	HIS	-	expression tag	UNP Q6MM15
F	424	HIS	-	expression tag	UNP Q6MM15
F	425	HIS	-	expression tag	UNP Q6MM15
F	426	HIS	-	expression tag	UNP Q6MM15
F	427	HIS	-	expression tag	UNP Q6MM15

Continued on next page...

Continued from previous page...

Chain	Residue	Modelled	Actual	Comment	Reference
F	428	HIS	-	expression tag	UNP Q6MM15
F	429	SER	-	expression tag	UNP Q6MM15
F	430	SER	-	expression tag	UNP Q6MM15
F	431	GLY	-	expression tag	UNP Q6MM15
F	432	LEU	-	expression tag	UNP Q6MM15
F	433	VAL	-	expression tag	UNP Q6MM15
F	434	PRO	-	expression tag	UNP Q6MM15
F	435	ALA	-	expression tag	UNP Q6MM15
F	436	GLY	-	expression tag	UNP Q6MM15
F	437	SER	-	expression tag	UNP Q6MM15
F	438	HIS	-	expression tag	UNP Q6MM15
G	419	MET	-	initiating methionine	UNP Q6MM15
G	420	GLY	-	expression tag	UNP Q6MM15
G	421	SER	-	expression tag	UNP Q6MM15
G	422	SER	-	expression tag	UNP Q6MM15
G	423	HIS	-	expression tag	UNP Q6MM15
G	424	HIS	-	expression tag	UNP Q6MM15
G	425	HIS	-	expression tag	UNP Q6MM15
G	426	HIS	-	expression tag	UNP Q6MM15
G	427	HIS	-	expression tag	UNP Q6MM15
G	428	HIS	-	expression tag	UNP Q6MM15
G	429	SER	-	expression tag	UNP Q6MM15
G	430	SER	-	expression tag	UNP Q6MM15
G	431	GLY	-	expression tag	UNP Q6MM15
G	432	LEU	-	expression tag	UNP Q6MM15
G	433	VAL	-	expression tag	UNP Q6MM15
G	434	PRO	-	expression tag	UNP Q6MM15
G	435	ALA	-	expression tag	UNP Q6MM15
G	436	GLY	-	expression tag	UNP Q6MM15
G	437	SER	-	expression tag	UNP Q6MM15
G	438	HIS	-	expression tag	UNP Q6MM15
J	419	MET	-	initiating methionine	UNP Q6MM15
J	420	GLY	-	expression tag	UNP Q6MM15
J	421	SER	-	expression tag	UNP Q6MM15
J	422	SER	-	expression tag	UNP Q6MM15
J	423	HIS	-	expression tag	UNP Q6MM15
J	424	HIS	-	expression tag	UNP Q6MM15
J	425	HIS	-	expression tag	UNP Q6MM15
J	426	HIS	-	expression tag	UNP Q6MM15
J	427	HIS	-	expression tag	UNP Q6MM15
J	428	HIS	-	expression tag	UNP Q6MM15
J	429	SER	-	expression tag	UNP Q6MM15

Continued on next page...

Continued from previous page...

Chain	Residue	Modelled	Actual	Comment	Reference
J	430	SER	-	expression tag	UNP Q6MM15
J	431	GLY	-	expression tag	UNP Q6MM15
J	432	LEU	-	expression tag	UNP Q6MM15
J	433	VAL	-	expression tag	UNP Q6MM15
J	434	PRO	-	expression tag	UNP Q6MM15
J	435	ALA	-	expression tag	UNP Q6MM15
J	436	GLY	-	expression tag	UNP Q6MM15
J	437	SER	-	expression tag	UNP Q6MM15
J	438	HIS	-	expression tag	UNP Q6MM15
L	419	MET	-	initiating methionine	UNP Q6MM15
L	420	GLY	-	expression tag	UNP Q6MM15
L	421	SER	-	expression tag	UNP Q6MM15
L	422	SER	-	expression tag	UNP Q6MM15
L	423	HIS	-	expression tag	UNP Q6MM15
L	424	HIS	-	expression tag	UNP Q6MM15
L	425	HIS	-	expression tag	UNP Q6MM15
L	426	HIS	-	expression tag	UNP Q6MM15
L	427	HIS	-	expression tag	UNP Q6MM15
L	428	HIS	-	expression tag	UNP Q6MM15
L	429	SER	-	expression tag	UNP Q6MM15
L	430	SER	-	expression tag	UNP Q6MM15
L	431	GLY	-	expression tag	UNP Q6MM15
L	432	LEU	-	expression tag	UNP Q6MM15
L	433	VAL	-	expression tag	UNP Q6MM15
L	434	PRO	-	expression tag	UNP Q6MM15
L	435	ALA	-	expression tag	UNP Q6MM15
L	436	GLY	-	expression tag	UNP Q6MM15
L	437	SER	-	expression tag	UNP Q6MM15
L	438	HIS	-	expression tag	UNP Q6MM15
H	419	MET	-	initiating methionine	UNP Q6MM15
H	420	GLY	-	expression tag	UNP Q6MM15
H	421	SER	-	expression tag	UNP Q6MM15
H	422	SER	-	expression tag	UNP Q6MM15
H	423	HIS	-	expression tag	UNP Q6MM15
H	424	HIS	-	expression tag	UNP Q6MM15
H	425	HIS	-	expression tag	UNP Q6MM15
H	426	HIS	-	expression tag	UNP Q6MM15
H	427	HIS	-	expression tag	UNP Q6MM15
H	428	HIS	-	expression tag	UNP Q6MM15
H	429	SER	-	expression tag	UNP Q6MM15
H	430	SER	-	expression tag	UNP Q6MM15
H	431	GLY	-	expression tag	UNP Q6MM15

Continued on next page...

Continued from previous page...

Chain	Residue	Modelled	Actual	Comment	Reference
H	432	LEU	-	expression tag	UNP Q6MM15
H	433	VAL	-	expression tag	UNP Q6MM15
H	434	PRO	-	expression tag	UNP Q6MM15
H	435	ALA	-	expression tag	UNP Q6MM15
H	436	GLY	-	expression tag	UNP Q6MM15
H	437	SER	-	expression tag	UNP Q6MM15
H	438	HIS	-	expression tag	UNP Q6MM15
I	419	MET	-	initiating methionine	UNP Q6MM15
I	420	GLY	-	expression tag	UNP Q6MM15
I	421	SER	-	expression tag	UNP Q6MM15
I	422	SER	-	expression tag	UNP Q6MM15
I	423	HIS	-	expression tag	UNP Q6MM15
I	424	HIS	-	expression tag	UNP Q6MM15
I	425	HIS	-	expression tag	UNP Q6MM15
I	426	HIS	-	expression tag	UNP Q6MM15
I	427	HIS	-	expression tag	UNP Q6MM15
I	428	HIS	-	expression tag	UNP Q6MM15
I	429	SER	-	expression tag	UNP Q6MM15
I	430	SER	-	expression tag	UNP Q6MM15
I	431	GLY	-	expression tag	UNP Q6MM15
I	432	LEU	-	expression tag	UNP Q6MM15
I	433	VAL	-	expression tag	UNP Q6MM15
I	434	PRO	-	expression tag	UNP Q6MM15
I	435	ALA	-	expression tag	UNP Q6MM15
I	436	GLY	-	expression tag	UNP Q6MM15
I	437	SER	-	expression tag	UNP Q6MM15
I	438	HIS	-	expression tag	UNP Q6MM15
K	419	MET	-	initiating methionine	UNP Q6MM15
K	420	GLY	-	expression tag	UNP Q6MM15
K	421	SER	-	expression tag	UNP Q6MM15
K	422	SER	-	expression tag	UNP Q6MM15
K	423	HIS	-	expression tag	UNP Q6MM15
K	424	HIS	-	expression tag	UNP Q6MM15
K	425	HIS	-	expression tag	UNP Q6MM15
K	426	HIS	-	expression tag	UNP Q6MM15
K	427	HIS	-	expression tag	UNP Q6MM15
K	428	HIS	-	expression tag	UNP Q6MM15
K	429	SER	-	expression tag	UNP Q6MM15
K	430	SER	-	expression tag	UNP Q6MM15
K	431	GLY	-	expression tag	UNP Q6MM15
K	432	LEU	-	expression tag	UNP Q6MM15
K	433	VAL	-	expression tag	UNP Q6MM15

Continued on next page...

Continued from previous page...

Chain	Residue	Modelled	Actual	Comment	Reference
K	434	PRO	-	expression tag	UNP Q6MM15
K	435	ALA	-	expression tag	UNP Q6MM15
K	436	GLY	-	expression tag	UNP Q6MM15
K	437	SER	-	expression tag	UNP Q6MM15
K	438	HIS	-	expression tag	UNP Q6MM15
E	419	MET	-	initiating methionine	UNP Q6MM15
E	420	GLY	-	expression tag	UNP Q6MM15
E	421	SER	-	expression tag	UNP Q6MM15
E	422	SER	-	expression tag	UNP Q6MM15
E	423	HIS	-	expression tag	UNP Q6MM15
E	424	HIS	-	expression tag	UNP Q6MM15
E	425	HIS	-	expression tag	UNP Q6MM15
E	426	HIS	-	expression tag	UNP Q6MM15
E	427	HIS	-	expression tag	UNP Q6MM15
E	428	HIS	-	expression tag	UNP Q6MM15
E	429	SER	-	expression tag	UNP Q6MM15
E	430	SER	-	expression tag	UNP Q6MM15
E	431	GLY	-	expression tag	UNP Q6MM15
E	432	LEU	-	expression tag	UNP Q6MM15
E	433	VAL	-	expression tag	UNP Q6MM15
E	434	PRO	-	expression tag	UNP Q6MM15
E	435	ALA	-	expression tag	UNP Q6MM15
E	436	GLY	-	expression tag	UNP Q6MM15
E	437	SER	-	expression tag	UNP Q6MM15
E	438	HIS	-	expression tag	UNP Q6MM15

3 Residue-property plots [i](#)

These plots are drawn for all protein, RNA, DNA and oligosaccharide chains in the entry. The first graphic for a chain summarises the proportions of the various outlier classes displayed in the second graphic. The second graphic shows the sequence view annotated by issues in geometry and electron density. Residues are color-coded according to the number of geometric quality criteria for which they contain at least one outlier: green = 0, yellow = 1, orange = 2 and red = 3 or more. A red dot above a residue indicates a poor fit to the electron density ($RSRZ > 2$). Stretches of 2 or more consecutive residues without any outlier are shown as a green connector. Residues present in the sample, but not in the model, are shown in grey.

- Molecule 1: Malate dehydrogenase

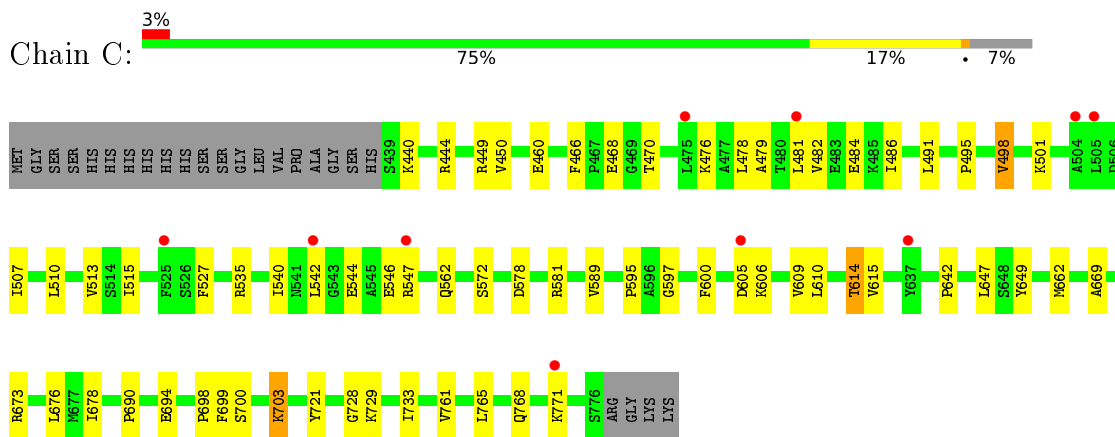

- Molecule 1: Malate dehydrogenase

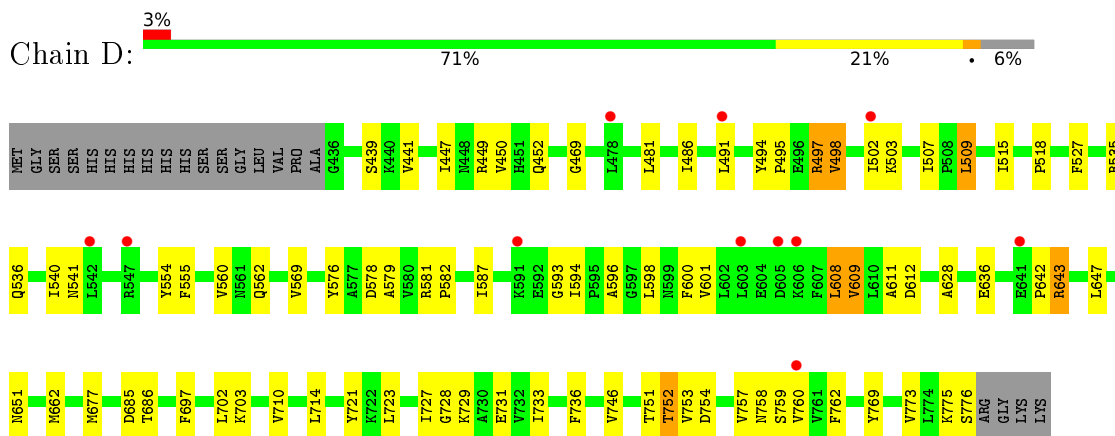

- Molecule 1: Malate dehydrogenase

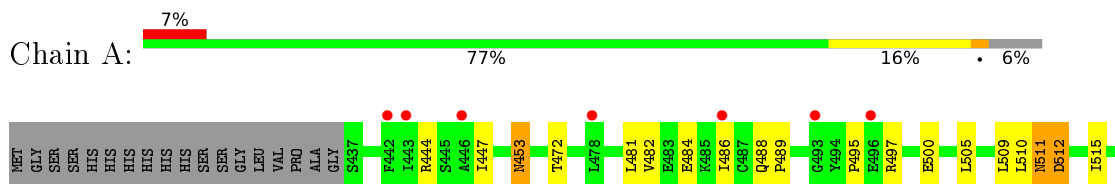

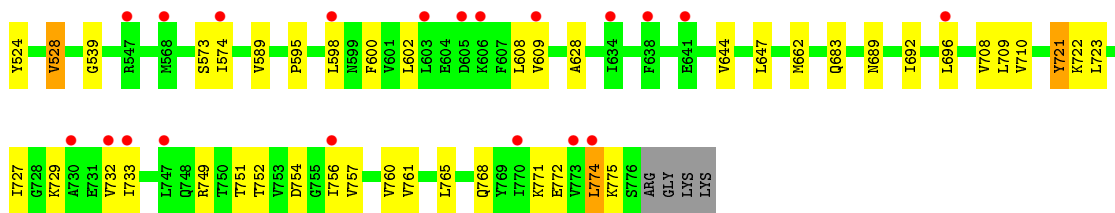

• Molecule 1: Malate dehydrogenase

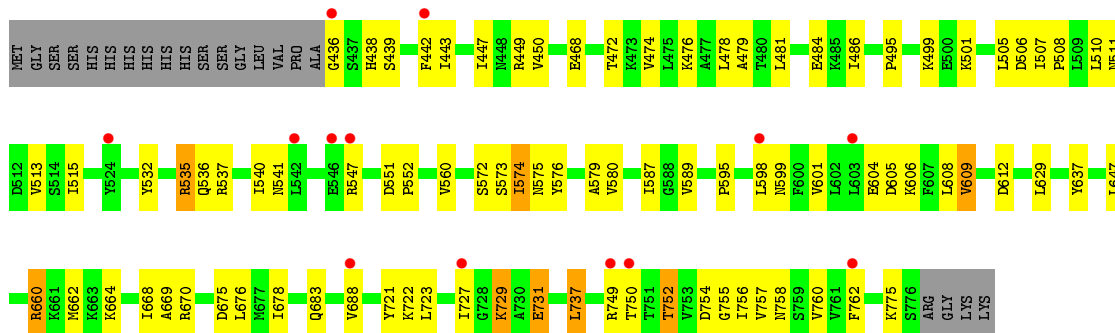

• Molecule 1: Malate dehydrogenase

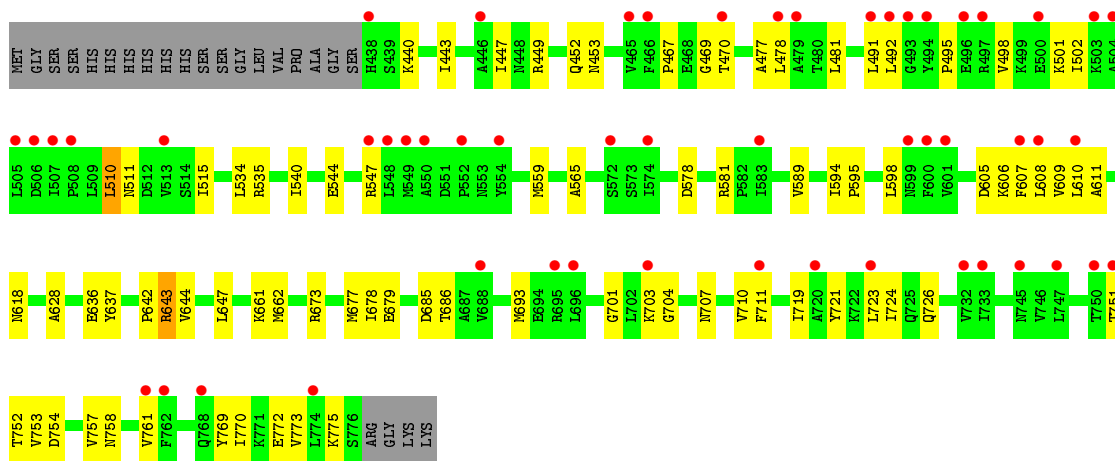

• Molecule 1: Malate dehydrogenase

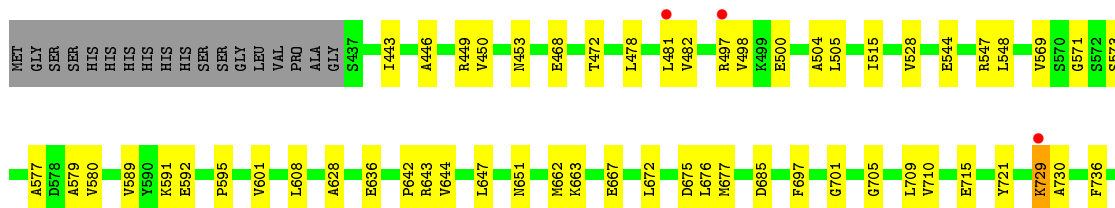
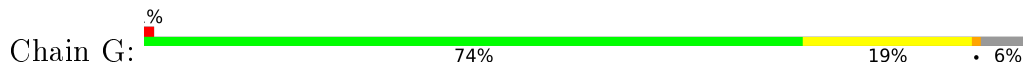

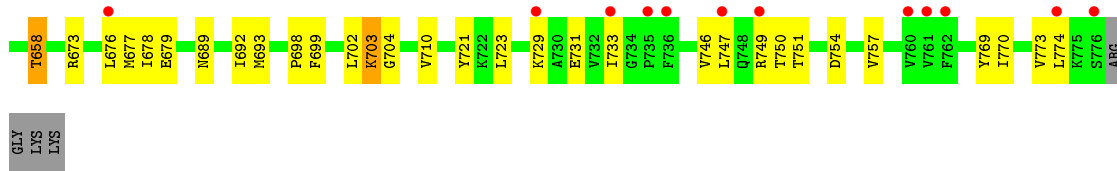

• Molecule 1: Malate dehydrogenase

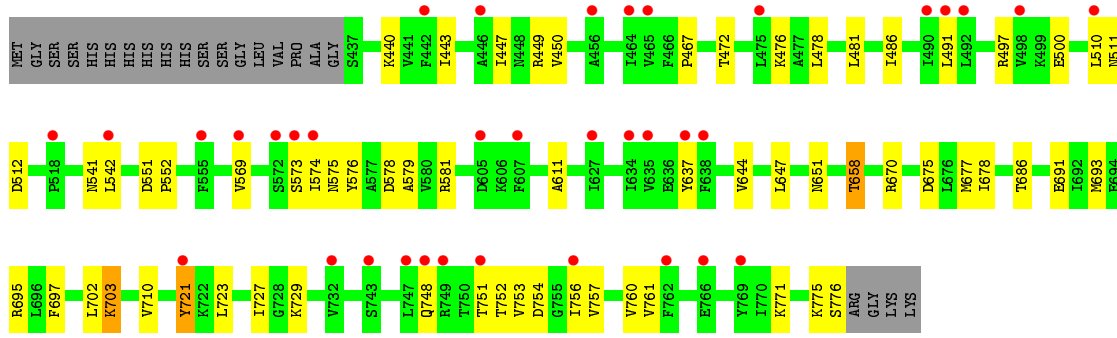
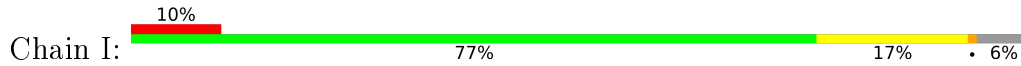

• Molecule 1: Malate dehydrogenase

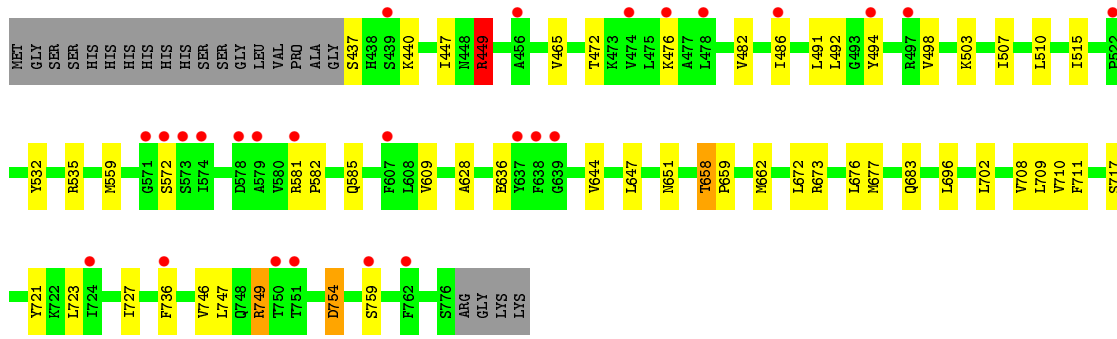
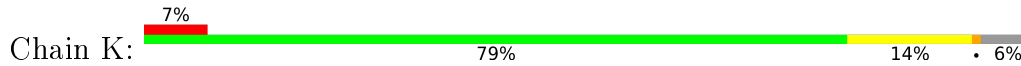

• Molecule 1: Malate dehydrogenase

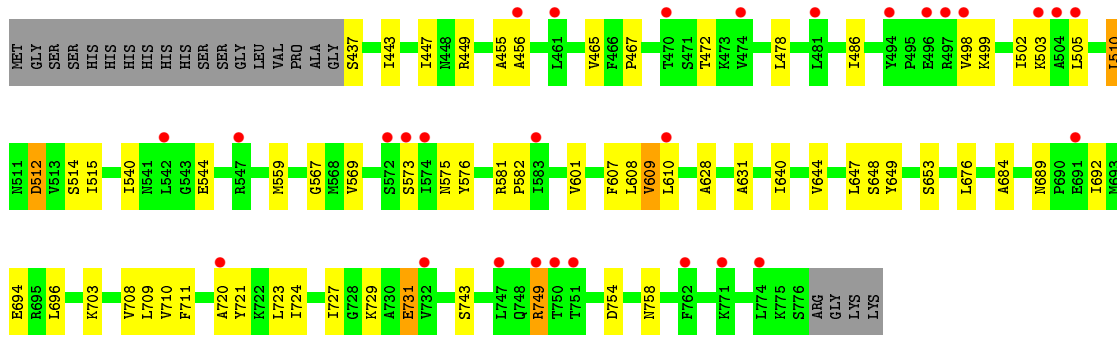
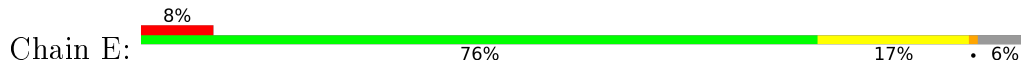

4 Data and refinement statistics

Property	Value	Source
Space group	P 21 21 21	Depositor
Cell constants a, b, c, α , β , γ	139.22Å 151.28Å 285.33Å 90.00° 90.00° 90.00°	Depositor
Resolution (Å)	99.64 – 2.72 125.12 – 2.72	Depositor EDS
% Data completeness (in resolution range)	100.0 (99.64-2.72) 95.9 (125.12-2.72)	Depositor EDS
R_{merge}	(Not available)	Depositor
R_{sym}	(Not available)	Depositor
$\langle I/\sigma(I) \rangle$ ¹	1.78 (at 2.73Å)	Xtrriage
Refinement program	PHENIX v1.0	Depositor
R, R_{free}	0.252 , 0.299 0.278 , 0.316	Depositor DCC
R_{free} test set	7485 reflections (4.81%)	wwPDB-VP
Wilson B-factor (Å ²)	67.1	Xtrriage
Anisotropy	0.292	Xtrriage
Bulk solvent k_{sol} (e/Å ³), B_{sol} (Å ²)	0.29 , 43.2	EDS
L-test for twinning ²	$\langle L \rangle = 0.52$, $\langle L^2 \rangle = 0.36$	Xtrriage
Estimated twinning fraction	No twinning to report.	Xtrriage
F_o, F_c correlation	0.89	EDS
Total number of atoms	31258	wwPDB-VP
Average B, all atoms (Å ²)	85.0	wwPDB-VP

Xtrriage's analysis on translational NCS is as follows: *The largest off-origin peak in the Patterson function is 18.58% of the height of the origin peak. No significant pseudotranslation is detected.*

¹Intensities estimated from amplitudes.

²Theoretical values of $\langle |L| \rangle$, $\langle L^2 \rangle$ for acentric reflections are 0.5, 0.333 respectively for untwinned datasets, and 0.375, 0.2 for perfectly twinned datasets.

5 Model quality

5.1 Standard geometry

The Z score for a bond length (or angle) is the number of standard deviations the observed value is removed from the expected value. A bond length (or angle) with $|Z| > 5$ is considered an outlier worth inspection. RMSZ is the root-mean-square of all Z scores of the bond lengths (or angles).

Mol	Chain	Bond lengths		Bond angles	
		RMSZ	# Z >5	RMSZ	# Z >5
1	A	0.51	0/2650	0.71	0/3587
1	B	0.56	0/2654	0.74	3/3592 (0.1%)
1	C	0.58	0/2642	0.73	1/3576 (0.0%)
1	D	0.58	0/2655	0.73	1/3593 (0.0%)
1	E	0.48	0/2651	0.66	2/3588 (0.1%)
1	F	0.44	0/2646	0.69	1/3582 (0.0%)
1	G	0.56	0/2651	0.73	1/3588 (0.0%)
1	H	0.55	0/2651	0.70	0/3588
1	I	0.57	0/2651	0.72	0/3588
1	J	0.57	1/2642 (0.0%)	0.71	1/3576 (0.0%)
1	K	0.52	0/2651	0.74	3/3588 (0.1%)
1	L	0.56	0/2642	0.72	0/3576
All	All	0.54	1/31786 (0.0%)	0.72	13/43022 (0.0%)

All (1) bond length outliers are listed below:

Mol	Chain	Res	Type	Atoms	Z	Observed(Å)	Ideal(Å)
1	J	560	VAL	CB-CG2	-5.10	1.42	1.52

The worst 5 of 13 bond angle outliers are listed below:

Mol	Chain	Res	Type	Atoms	Z	Observed(°)	Ideal(°)
1	K	749	ARG	NE-CZ-NH1	-10.37	115.11	120.30
1	B	737	LEU	CB-CG-CD1	-7.42	98.39	111.00
1	K	749	ARG	NE-CZ-NH2	7.20	123.90	120.30
1	G	481	LEU	CA-CB-CG	6.85	131.05	115.30
1	F	643	ARG	NE-CZ-NH1	-6.05	117.28	120.30

There are no chirality outliers.

There are no planarity outliers.

5.2 Too-close contacts [i](#)

In the following table, the Non-H and H(model) columns list the number of non-hydrogen atoms and hydrogen atoms in the chain respectively. The H(added) column lists the number of hydrogen atoms added and optimized by MolProbity. The Clashes column lists the number of clashes within the asymmetric unit, whereas Symm-Clashes lists symmetry-related clashes.

Mol	Chain	Non-H	H(model)	H(added)	Clashes	Symm-Clashes
1	A	2606	0	2675	51	0
1	B	2610	0	2678	64	0
1	C	2598	0	2675	44	0
1	D	2611	0	2681	56	0
1	E	2607	0	2678	43	0
1	F	2602	0	2674	68	0
1	G	2607	0	2678	52	0
1	H	2607	0	2678	70	0
1	I	2607	0	2678	49	0
1	J	2598	0	2675	61	0
1	K	2607	0	2678	45	0
1	L	2598	0	2675	56	0
All	All	31258	0	32123	607	0

The all-atom clashscore is defined as the number of clashes found per 1000 atoms (including hydrogen atoms). The all-atom clashscore for this structure is 10.

The worst 5 of 607 close contacts within the same asymmetric unit are listed below, sorted by their clash magnitude.

Atom-1	Atom-2	Interatomic distance (Å)	Clash overlap (Å)
1:A:453:ASN:CG	1:A:768:GLN:HE22	1.07	1.49
1:A:453:ASN:CG	1:A:768:GLN:NE2	1.75	1.38
1:A:453:ASN:ND2	1:A:768:GLN:NE2	2.05	1.05
1:A:453:ASN:OD1	1:A:768:GLN:NE2	1.80	0.98
1:B:439:SER:CB	1:B:731:GLU:OE1	2.13	0.97

There are no symmetry-related clashes.

5.3 Torsion angles [i](#)

5.3.1 Protein backbone [i](#)

In the following table, the Percentiles column shows the percent Ramachandran outliers of the chain as a percentile score with respect to all X-ray entries followed by that with respect to entries of similar resolution.

The Analysed column shows the number of residues for which the backbone conformation was analysed, and the total number of residues.

Mol	Chain	Analysed	Favoured	Allowed	Outliers	Percentiles	
1	A	338/362 (93%)	332 (98%)	6 (2%)	0	100	100
1	B	339/362 (94%)	336 (99%)	3 (1%)	0	100	100
1	C	336/362 (93%)	332 (99%)	4 (1%)	0	100	100
1	D	339/362 (94%)	334 (98%)	5 (2%)	0	100	100
1	E	338/362 (93%)	333 (98%)	5 (2%)	0	100	100
1	F	337/362 (93%)	331 (98%)	6 (2%)	0	100	100
1	G	338/362 (93%)	333 (98%)	5 (2%)	0	100	100
1	H	338/362 (93%)	335 (99%)	3 (1%)	0	100	100
1	I	338/362 (93%)	334 (99%)	4 (1%)	0	100	100
1	J	336/362 (93%)	331 (98%)	5 (2%)	0	100	100
1	K	338/362 (93%)	333 (98%)	5 (2%)	0	100	100
1	L	336/362 (93%)	332 (99%)	3 (1%)	1 (0%)	41	65
All	All	4051/4344 (93%)	3996 (99%)	54 (1%)	1 (0%)	100	100

All (1) Ramachandran outliers are listed below:

Mol	Chain	Res	Type
1	L	508	PRO

5.3.2 Protein sidechains [i](#)

In the following table, the Percentiles column shows the percent sidechain outliers of the chain as a percentile score with respect to all X-ray entries followed by that with respect to entries of similar resolution.

The Analysed column shows the number of residues for which the sidechain conformation was analysed, and the total number of residues.

Mol	Chain	Analysed	Rotameric	Outliers	Percentiles	
1	A	281/301 (93%)	268 (95%)	13 (5%)	27	52
1	B	281/301 (93%)	272 (97%)	9 (3%)	39	67
1	C	282/301 (94%)	274 (97%)	8 (3%)	43	71
1	D	282/301 (94%)	272 (96%)	10 (4%)	36	63
1	E	282/301 (94%)	273 (97%)	9 (3%)	39	67

Continued on next page...

Continued from previous page...

Mol	Chain	Analysed	Rotameric	Outliers	Percentiles	
1	F	281/301 (93%)	278 (99%)	3 (1%)	73	89
1	G	282/301 (94%)	275 (98%)	7 (2%)	47	75
1	H	282/301 (94%)	275 (98%)	7 (2%)	47	75
1	I	282/301 (94%)	277 (98%)	5 (2%)	59	82
1	J	282/301 (94%)	273 (97%)	9 (3%)	39	67
1	K	282/301 (94%)	276 (98%)	6 (2%)	53	79
1	L	282/301 (94%)	271 (96%)	11 (4%)	32	59
All	All	3381/3612 (94%)	3284 (97%)	97 (3%)	42	70

5 of 97 residues with a non-rotameric sidechain are listed below:

Mol	Chain	Res	Type
1	J	727	ILE
1	H	482	VAL
1	L	441	VAL
1	L	591	LYS
1	H	703	LYS

Sometimes sidechains can be flipped to improve hydrogen bonding and reduce clashes. 5 of 10 such sidechains are listed below:

Mol	Chain	Res	Type
1	I	517	HIS
1	I	748	GLN
1	E	758	ASN
1	F	758	ASN
1	L	562	GLN

5.3.3 RNA ⓘ

There are no RNA molecules in this entry.

5.4 Non-standard residues in protein, DNA, RNA chains ⓘ

There are no non-standard protein/DNA/RNA residues in this entry.

5.5 Carbohydrates [i](#)

There are no monosaccharides in this entry.

5.6 Ligand geometry [i](#)

There are no ligands in this entry.

5.7 Other polymers [i](#)

There are no such residues in this entry.

5.8 Polymer linkage issues [i](#)

There are no chain breaks in this entry.

6 Fit of model and data [i](#)

6.1 Protein, DNA and RNA chains [i](#)

In the following table, the column labelled '#RSRZ> 2' contains the number (and percentage) of RSRZ outliers, followed by percent RSRZ outliers for the chain as percentile scores relative to all X-ray entries and entries of similar resolution. The OWAB column contains the minimum, median, 95th percentile and maximum values of the occupancy-weighted average B-factor per residue. The column labelled 'Q< 0.9' lists the number of (and percentage) of residues with an average occupancy less than 0.9.

Mol	Chain	Analysed	<RSRZ>	#RSRZ>2	OWAB(Å ²)	Q<0.9
1	A	340/362 (93%)	0.55	27 (7%) 12 11	48, 81, 150, 174	0
1	B	341/362 (94%)	0.43	13 (3%) 40 40	42, 72, 131, 182	0
1	C	338/362 (93%)	0.40	10 (2%) 50 51	36, 63, 119, 183	0
1	D	341/362 (94%)	0.44	11 (3%) 47 48	33, 67, 123, 187	0
1	E	340/362 (93%)	0.68	29 (8%) 10 9	32, 89, 144, 202	0
1	F	339/362 (93%)	0.90	53 (15%) 2 1	61, 100, 154, 187	0
1	G	340/362 (93%)	0.43	5 (1%) 73 76	42, 69, 115, 178	0
1	H	340/362 (93%)	0.62	29 (8%) 10 9	32, 81, 139, 196	0
1	I	340/362 (93%)	0.83	36 (10%) 6 4	32, 87, 160, 241	0
1	J	338/362 (93%)	0.60	25 (7%) 14 13	32, 77, 121, 184	0
1	K	340/362 (93%)	0.60	26 (7%) 13 12	32, 75, 136, 222	0
1	L	338/362 (93%)	0.86	46 (13%) 3 2	36, 89, 171, 267	0
All	All	4075/4344 (93%)	0.61	310 (7%) 13 12	32, 79, 145, 267	0

The worst 5 of 310 RSRZ outliers are listed below:

Mol	Chain	Res	Type	RSRZ
1	K	572	SER	9.4
1	K	573	SER	7.3
1	A	774	LEU	6.6
1	E	749	ARG	6.5
1	F	601	VAL	6.2

6.2 Non-standard residues in protein, DNA, RNA chains [i](#)

There are no non-standard protein/DNA/RNA residues in this entry.

6.3 Carbohydrates [i](#)

There are no monosaccharides in this entry.

6.4 Ligands [i](#)

There are no ligands in this entry.

6.5 Other polymers [i](#)

There are no such residues in this entry.