



# Full wwPDB X-ray Structure Validation Report ⓘ

Nov 13, 2023 – 12:22 PM JST

PDB ID : 5X6Y  
Title : Crystal structure of Rice Dwarf Virus P5 in complex with S-adenosylmethionine  
Authors : Nakamichi, Y.; Higashiura, A.; Nakagawa, A.  
Deposited on : 2017-02-23  
Resolution : 2.10 Å(reported)

This is a Full wwPDB X-ray Structure Validation Report for a publicly released PDB entry.

We welcome your comments at [validation@mail.wwpdb.org](mailto:validation@mail.wwpdb.org)

A user guide is available at

<https://www.wwpdb.org/validation/2017/XrayValidationReportHelp>

with specific help available everywhere you see the ⓘ symbol.

The types of validation reports are described at

<http://www.wwpdb.org/validation/2017/FAQs#types>.

---

The following versions of software and data (see [references ⓘ](#)) were used in the production of this report:

MolProbity : 4.02b-467  
Mogul : 1.8.5 (274361), CSD as541be (2020)  
Xtriage (Phenix) : 1.13  
EDS : 2.36  
buster-report : 1.1.7 (2018)  
Percentile statistics : 20191225.v01 (using entries in the PDB archive December 25th 2019)  
Refmac : 5.8.0158  
CCP4 : 7.0.044 (Gargrove)  
Ideal geometry (proteins) : Engh & Huber (2001)  
Ideal geometry (DNA, RNA) : Parkinson et al. (1996)  
Validation Pipeline (wwPDB-VP) : 2.36

# 1 Overall quality at a glance

The following experimental techniques were used to determine the structure:

*X-RAY DIFFRACTION*

The reported resolution of this entry is 2.10 Å.

Percentile scores (ranging between 0-100) for global validation metrics of the entry are shown in the following graphic. The table shows the number of entries on which the scores are based.

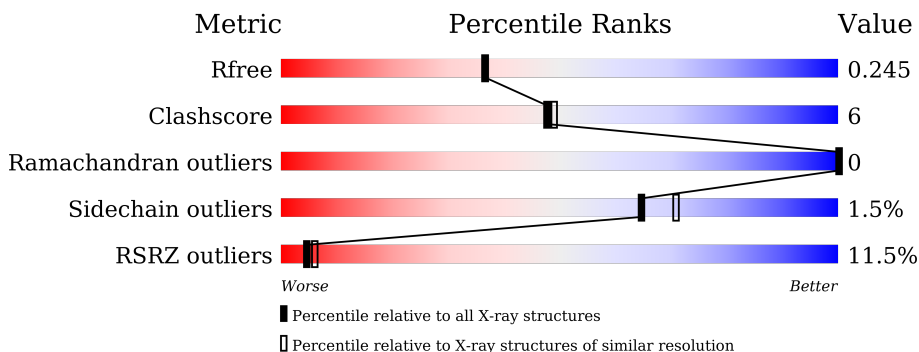

Metric	Whole archive (#Entries)	Similar resolution (#Entries, resolution range(Å))
$R_{free}$	130704	5197 (2.10-2.10)
Clashscore	141614	5710 (2.10-2.10)
Ramachandran outliers	138981	5647 (2.10-2.10)
Sidechain outliers	138945	5648 (2.10-2.10)
RSRZ outliers	127900	5083 (2.10-2.10)

The table below summarises the geometric issues observed across the polymeric chains and their fit to the electron density. The red, orange, yellow and green segments of the lower bar indicate the fraction of residues that contain outliers for  $\geq 3$ , 2, 1 and 0 types of geometric quality criteria respectively. A grey segment represents the fraction of residues that are not modelled. The numeric value for each fraction is indicated below the corresponding segment, with a dot representing fractions  $\leq 5\%$ . The upper red bar (where present) indicates the fraction of residues that have poor fit to the electron density. The numeric value is given above the bar.

Mol	Chain	Length	Quality of chain
1	A	804	 8% 86% 11%
1	B	804	 11% 75% 11% 14%
1	C	804	 5% 85% 11%
1	D	804	 18% 69% 19%

## 2 Entry composition [i](#)

There are 5 unique types of molecules in this entry. The entry contains 24230 atoms, of which 0 are hydrogens and 0 are deuteriums.

In the tables below, the ZeroOcc column contains the number of atoms modelled with zero occupancy, the AltConf column contains the number of residues with at least one atom in alternate conformation and the Trace column contains the number of residues modelled with at most 2 atoms.

- Molecule 1 is a protein called mRNA capping enzyme P5.

Mol	Chain	Residues	Atoms					ZeroOcc	AltConf	Trace
			Total	C	N	O	S			
1	A	779	Total 6208	C 3999	N 1028	O 1144	S 37	0	2	0
1	B	694	Total 5487	C 3538	N 914	O 1001	S 34	0	1	0
1	C	774	Total 6163	C 3973	N 1020	O 1133	S 37	0	2	0
1	D	713	Total 5640	C 3636	N 933	O 1034	S 37	0	0	0

- Molecule 2 is S-ADENOSYLMETHIONINE (three-letter code: SAM) (formula: C<sub>15</sub>H<sub>22</sub>N<sub>6</sub>O<sub>5</sub>S).

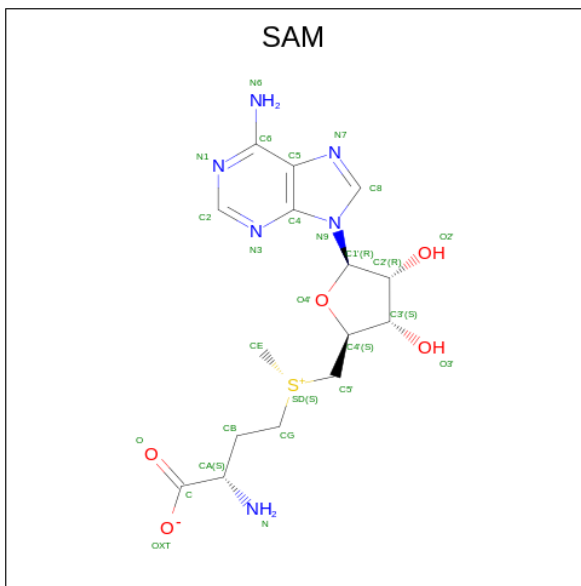

Mol	Chain	Residues	Atoms					ZeroOcc	AltConf
			Total	C	N	O	S		
2	A	1	Total 27	C 15	N 6	O 5	S 1	0	0
2	A	1	Total 27	C 15	N 6	O 5	S 1	0	0

*Continued on next page...*

Continued from previous page...

Mol	Chain	Residues	Atoms					ZeroOcc	AltConf
2	B	1	Total	C	N	O	S	0	0
			27	15	6	5	1		
2	C	1	Total	C	N	O	S	0	0
			27	15	6	5	1		
2	C	1	Total	C	N	O	S	0	0
			27	15	6	5	1		

- Molecule 3 is 1,2-ETHANEDIOL (three-letter code: EDO) (formula: C<sub>2</sub>H<sub>6</sub>O<sub>2</sub>).

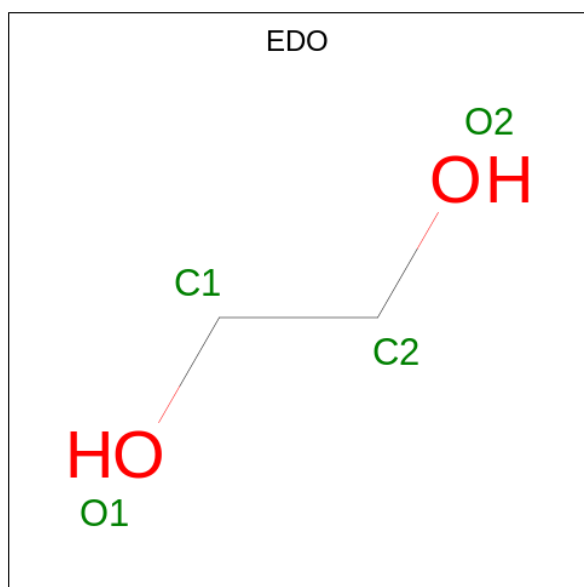

Mol	Chain	Residues	Atoms			ZeroOcc	AltConf
3	A	1	Total	C	O	0	0
			4	2	2		
3	A	1	Total	C	O	0	0
			4	2	2		
3	A	1	Total	C	O	0	0
			4	2	2		
3	B	1	Total	C	O	0	0
			4	2	2		
3	B	1	Total	C	O	0	0
			4	2	2		
3	B	1	Total	C	O	0	0
			4	2	2		
3	C	1	Total	C	O	0	0
			4	2	2		
3	D	1	Total	C	O	0	0
			4	2	2		

Continued on next page...

Continued from previous page...

Mol	Chain	Residues	Atoms			ZeroOcc	AltConf
3	D	1	Total	C	O	0	0
			4	2	2		

- Molecule 4 is CITRATE ANION (three-letter code: FLC) (formula:  $C_6H_5O_7$ ).

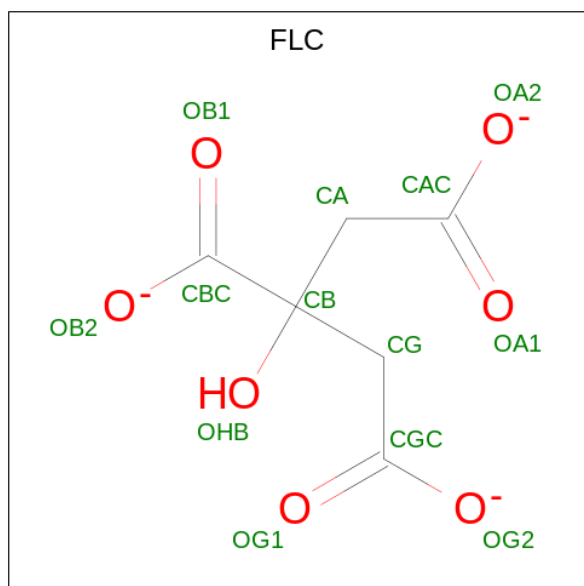

Mol	Chain	Residues	Atoms			ZeroOcc	AltConf
4	A	1	Total	C	O	0	0
			13	6	7		
4	B	1	Total	C	O	0	0
			13	6	7		
4	D	1	Total	C	O	0	0
			13	6	7		

- Molecule 5 is water.

Mol	Chain	Residues	Atoms		ZeroOcc	AltConf
5	A	181	Total	O	0	0
			181	181		
5	B	110	Total	O	0	0
			110	110		
5	C	165	Total	O	0	0
			165	165		
5	D	66	Total	O	0	0
			66	66		

### 3 Residue-property plots i

These plots are drawn for all protein, RNA, DNA and oligosaccharide chains in the entry. The first graphic for a chain summarises the proportions of the various outlier classes displayed in the second graphic. The second graphic shows the sequence view annotated by issues in geometry and electron density. Residues are color-coded according to the number of geometric quality criteria for which they contain at least one outlier: green = 0, yellow = 1, orange = 2 and red = 3 or more. A red dot above a residue indicates a poor fit to the electron density ( $RSRZ > 2$ ). Stretches of 2 or more consecutive residues without any outlier are shown as a green connector. Residues present in the sample, but not in the model, are shown in grey.

#### • Molecule 1: mRNA capping enzyme P5

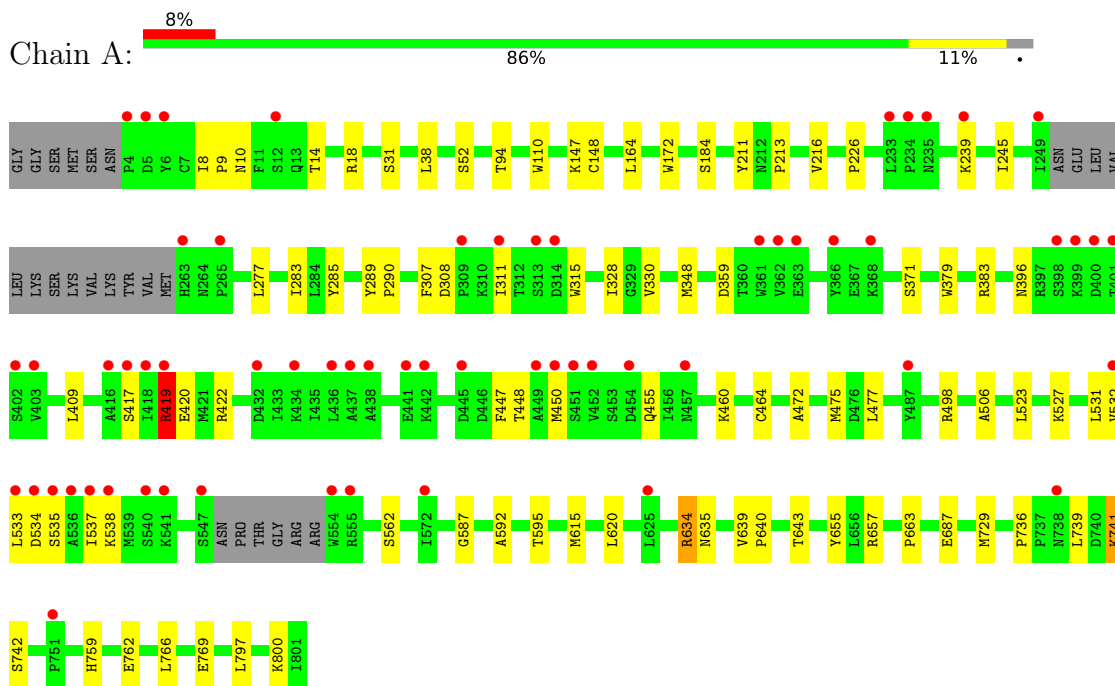

#### • Molecule 1: mRNA capping enzyme P5

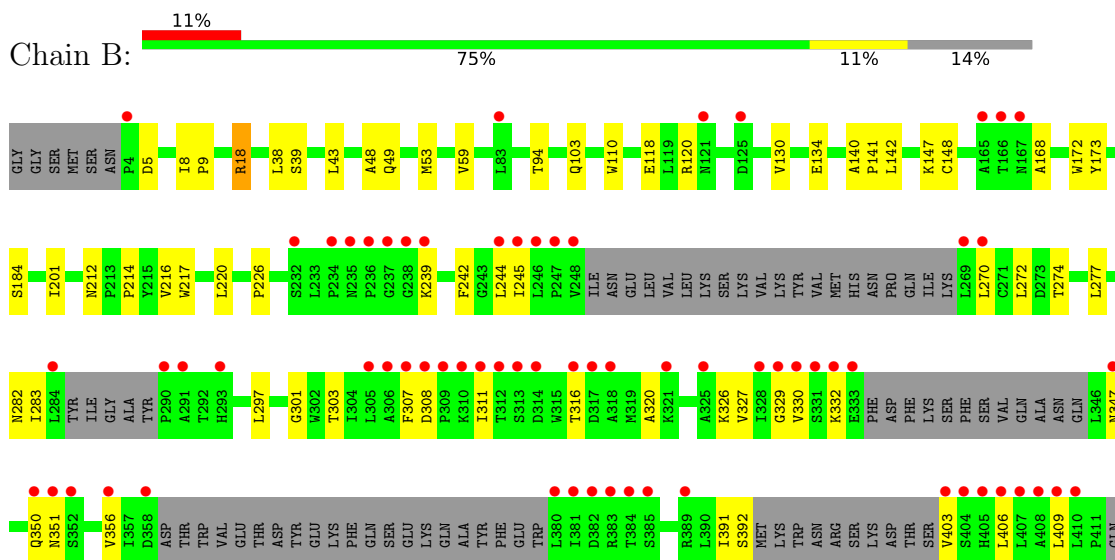

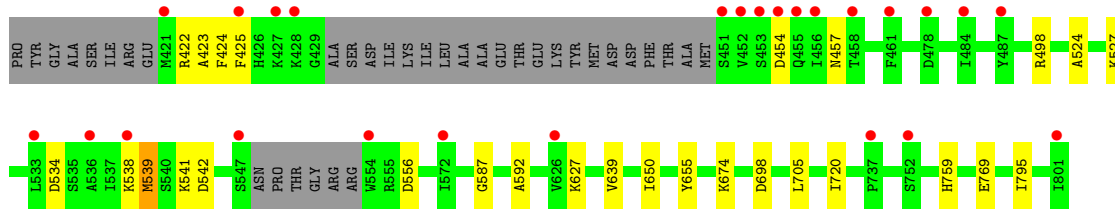

• Molecule 1: mRNA capping enzyme P5

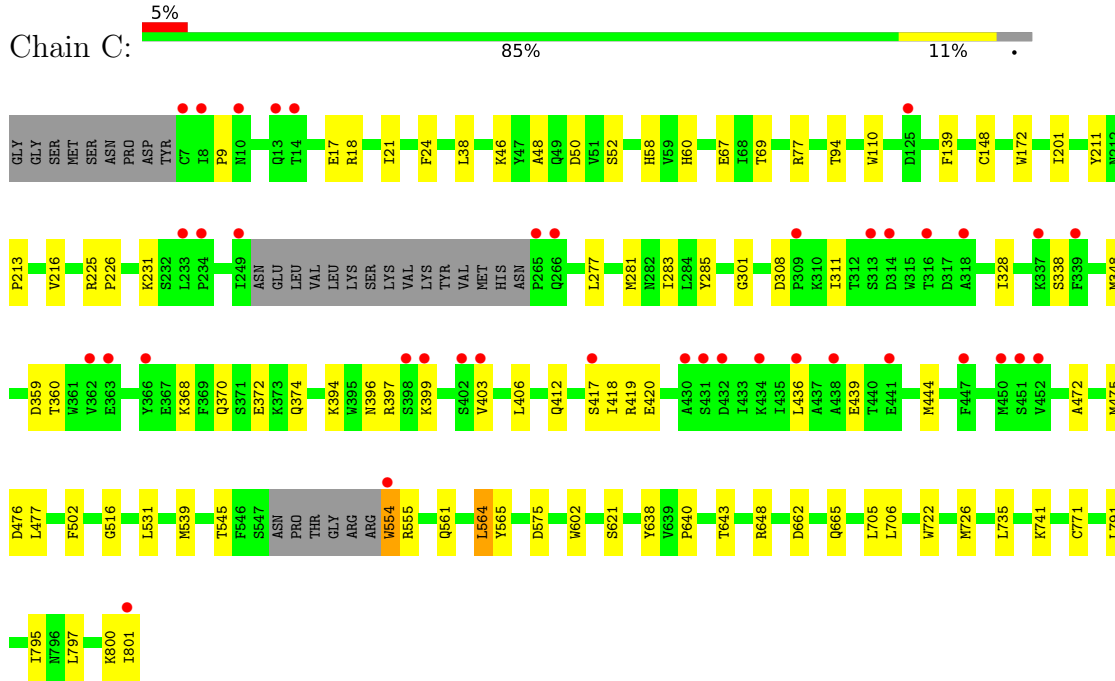

• Molecule 1: mRNA capping enzyme P5

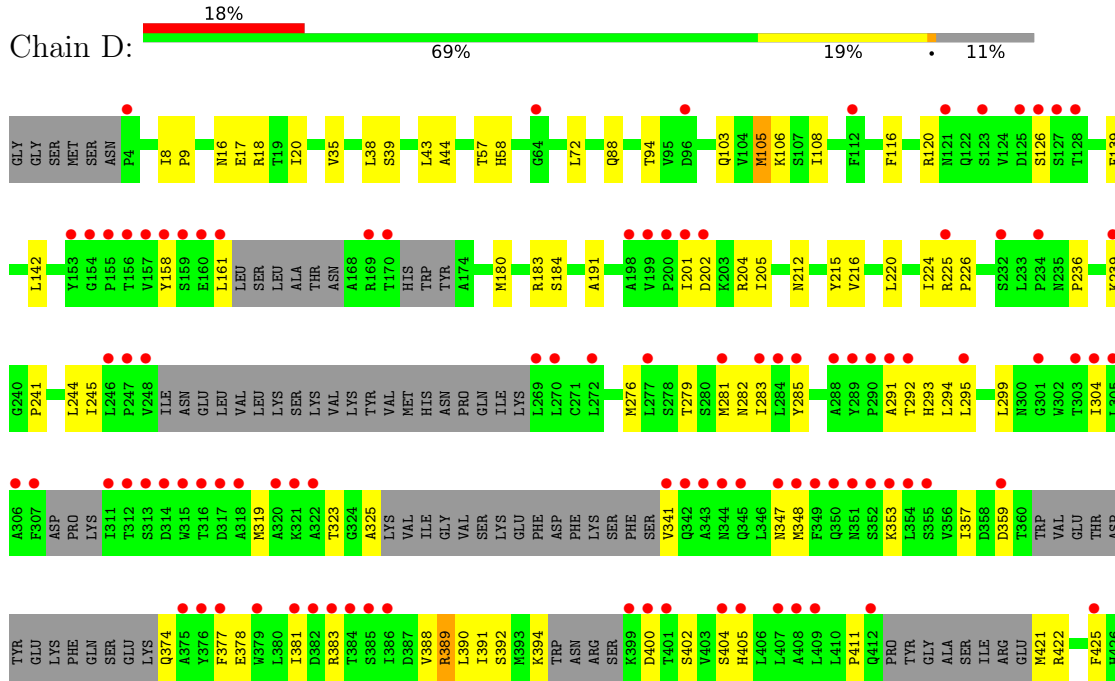

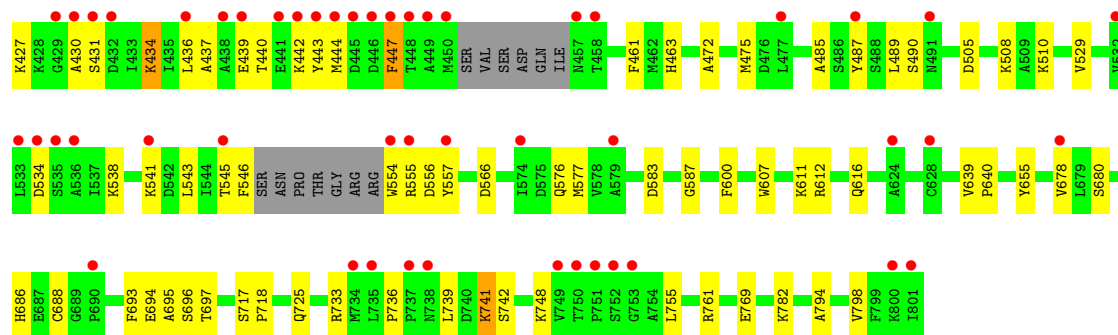



## 4 Data and refinement statistics

Property	Value	Source
Space group	P 1	Depositor
Cell constants a, b, c, $\alpha$ , $\beta$ , $\gamma$	60.18Å 122.78Å 129.26Å 73.80° 87.14° 86.08°	Depositor
Resolution (Å)	38.23 – 2.10 38.23 – 2.10	Depositor EDS
% Data completeness (in resolution range)	91.5 (38.23-2.10) 91.5 (38.23-2.10)	Depositor EDS
$R_{merge}$	0.04	Depositor
$R_{sym}$	(Not available)	Depositor
$\langle I/\sigma(I) \rangle$ <sup>1</sup>	2.66 (at 2.10Å)	Xtrriage
Refinement program	PHENIX (dev_2614: ???)	Depositor
R, $R_{free}$	0.202 , 0.245 0.202 , 0.245	Depositor DCC
$R_{free}$ test set	9512 reflections (5.03%)	wwPDB-VP
Wilson B-factor (Å <sup>2</sup> )	24.5	Xtrriage
Anisotropy	0.130	Xtrriage
Bulk solvent $k_{sol}$ (e/Å <sup>3</sup> ), $B_{sol}$ (Å <sup>2</sup> )	0.38 , 57.9	EDS
L-test for twinning <sup>2</sup>	$\langle  L  \rangle = 0.48$ , $\langle L^2 \rangle = 0.31$	Xtrriage
Estimated twinning fraction	No twinning to report.	Xtrriage
$F_o, F_c$ correlation	0.93	EDS
Total number of atoms	24230	wwPDB-VP
Average B, all atoms (Å <sup>2</sup> )	36.0	wwPDB-VP

Xtrriage's analysis on translational NCS is as follows: *The largest off-origin peak in the Patterson function is 3.24% of the height of the origin peak. No significant pseudotranslation is detected.*

<sup>1</sup>Intensities estimated from amplitudes.

<sup>2</sup>Theoretical values of  $\langle |L| \rangle$ ,  $\langle L^2 \rangle$  for acentric reflections are 0.5, 0.333 respectively for untwinned datasets, and 0.375, 0.2 for perfectly twinned datasets.

## 5 Model quality [i](#)

### 5.1 Standard geometry [i](#)

Bond lengths and bond angles in the following residue types are not validated in this section: EDO, SAM, FLC

The Z score for a bond length (or angle) is the number of standard deviations the observed value is removed from the expected value. A bond length (or angle) with  $|Z| > 5$  is considered an outlier worth inspection. RMSZ is the root-mean-square of all Z scores of the bond lengths (or angles).

Mol	Chain	Bond lengths		Bond angles	
		RMSZ	# Z  >5	RMSZ	# Z  >5
1	A	0.49	1/6359 (0.0%)	0.61	4/8630 (0.0%)
1	B	0.40	0/5611	0.54	0/7608
1	C	0.45	1/6311 (0.0%)	0.55	0/8562
1	D	0.36	0/5765	0.52	0/7812
All	All	0.43	2/24046 (0.0%)	0.56	4/32612 (0.0%)

All (2) bond length outliers are listed below:

Mol	Chain	Res	Type	Atoms	Z	Observed(Å)	Ideal(Å)
1	A	620	LEU	C-N	-5.87	1.20	1.34
1	C	771	CYS	CB-SG	-5.23	1.73	1.81

All (4) bond angle outliers are listed below:

Mol	Chain	Res	Type	Atoms	Z	Observed(°)	Ideal(°)
1	A	634	ARG	NE-CZ-NH2	-8.83	115.89	120.30
1	A	634	ARG	NE-CZ-NH1	7.83	124.22	120.30
1	A	419	ARG	NE-CZ-NH2	7.50	124.05	120.30
1	A	419	ARG	NE-CZ-NH1	-6.95	116.83	120.30

There are no chirality outliers.

There are no planarity outliers.

### 5.2 Too-close contacts [i](#)

In the following table, the Non-H and H(model) columns list the number of non-hydrogen atoms and hydrogen atoms in the chain respectively. The H(added) column lists the number of hydrogen atoms added and optimized by MolProbity. The Clashes column lists the number of clashes within the asymmetric unit, whereas Symm-Clashes lists symmetry-related clashes.

Mol	Chain	Non-H	H(model)	H(added)	Clashes	Symm-Clashes
1	A	6208	0	6194	65	0
1	B	5487	0	5526	66	0
1	C	6163	0	6172	57	0
1	D	5640	0	5653	112	0
2	A	54	0	44	2	0
2	B	27	0	22	0	0
2	C	54	0	44	3	0
3	A	12	0	18	0	0
3	B	12	0	18	2	0
3	C	4	0	6	0	0
3	D	8	0	12	0	0
4	A	13	0	5	2	0
4	B	13	0	5	1	0
4	D	13	0	5	1	0
5	A	181	0	0	0	0
5	B	110	0	0	2	0
5	C	165	0	0	2	0
5	D	66	0	0	0	0
All	All	24230	0	23724	290	0

The all-atom clashscore is defined as the number of clashes found per 1000 atoms (including hydrogen atoms). The all-atom clashscore for this structure is 6.

All (290) close contacts within the same asymmetric unit are listed below, sorted by their clash magnitude.

Atom-1	Atom-2	Interatomic distance (Å)	Clash overlap (Å)
1:D:205:ILE:CD1	1:D:225:ARG:HH11	1.08	1.64
1:D:205:ILE:HD11	1:D:225:ARG:NH1	1.12	1.38
1:D:205:ILE:CD1	1:D:225:ARG:NH1	1.82	1.07
1:C:705:LEU:HD21	1:C:791:LEU:HD21	1.54	0.89
1:A:417:SER:HA	1:A:448:THR:HG22	1.55	0.89
1:B:39:SER:OG	1:B:120:ARG:O	1.90	0.89
1:D:205:ILE:HD12	1:D:225:ARG:NH1	1.87	0.88
1:D:205:ILE:CD1	1:D:225:ARG:CZ	2.52	0.87
1:D:405:HIS:H	1:D:431:SER:HA	1.40	0.87
1:D:741:LYS:NZ	1:D:742:SER:OG	2.08	0.87
1:B:49:GLN:HB3	1:B:53:MET:HE2	1.59	0.83
1:C:545:THR:HG22	1:C:555:ARG:HG2	1.63	0.81
1:C:418:ILE:HG22	1:C:420:GLU:H	1.48	0.79
1:B:303:THR:HG22	1:B:326:LYS:HB2	1.69	0.75
1:D:359:ASP:HA	1:D:394:LYS:HD3	1.66	0.74
1:A:9:PRO:HB3	1:A:639:VAL:HG22	1.69	0.74

*Continued on next page...*

*Continued from previous page...*

Atom-1	Atom-2	Interatomic distance (Å)	Clash overlap (Å)
1:D:291:ALA:HB1	1:D:294:LEU:HD12	1.70	0.74
1:B:217:TRP:HD1	1:B:270:LEU:HD21	1.53	0.73
1:D:241:PRO:HD3	1:D:430:ALA:HB2	1.72	0.72
1:D:472:ALA:O	1:D:475:MET:HG2	1.89	0.71
1:A:18:ARG:HG3	1:B:18:ARG:HH11	1.56	0.71
1:D:276:MET:HE3	1:D:392:SER:HB2	1.72	0.71
1:A:797:LEU:HA	1:A:800:LYS:HG2	1.73	0.70
1:D:741:LYS:HD2	1:D:742:SER:N	2.06	0.70
1:D:545:THR:HG23	1:D:555:ARG:HG2	1.75	0.69
1:A:239:LYS:O	1:A:245:ILE:HG22	1.94	0.68
1:B:103:GLN:H	3:B:902:EDO:H12	1.58	0.68
1:B:130:VAL:O	1:B:134:GLU:HG3	1.95	0.67
1:C:201:ILE:HG21	1:C:301:GLY:HA3	1.76	0.66
1:D:205:ILE:CD1	1:D:225:ARG:NE	2.58	0.66
1:D:205:ILE:CD1	1:D:225:ARG:HE	2.09	0.65
1:B:239:LYS:HG3	1:B:245:ILE:CG2	2.27	0.64
1:C:359:ASP:OD1	2:C:902:SAM:N	2.32	0.63
1:B:282:ASN:OD1	1:B:303:THR:OG1	2.16	0.62
1:D:205:ILE:HD12	1:D:225:ARG:CZ	2.24	0.62
1:C:360:THR:O	1:C:394:LYS:NZ	2.33	0.61
1:C:403:VAL:HG21	1:C:406:LEU:HD22	1.81	0.61
1:D:741:LYS:HD2	1:D:741:LYS:C	2.20	0.61
1:D:205:ILE:HD11	1:D:225:ARG:CZ	2.12	0.61
1:A:533:LEU:HD12	1:A:535:SER:OG	2.01	0.60
1:A:460:LYS:HE3	1:A:464:CYS:HB3	1.83	0.60
1:D:680:SER:HA	1:D:695:ALA:HB2	1.83	0.60
1:C:308:ASP:HB3	1:C:311:ILE:HG13	1.84	0.60
1:D:39:SER:OG	1:D:120:ARG:O	2.13	0.60
1:D:607:TRP:HZ3	1:D:611:LYS:HD2	1.66	0.60
1:C:705:LEU:HD11	1:C:795:ILE:HG13	1.83	0.60
1:C:735:LEU:HD11	1:C:741:LYS:HD3	1.84	0.59
1:A:532:VAL:HG11	1:A:537:ILE:HB	1.85	0.59
1:A:277:LEU:HD23	1:A:283:ILE:HG13	1.85	0.58
1:A:447:PHE:HA	1:A:450:MET:SD	2.43	0.58
1:B:242:PHE:HB3	1:B:244:LEU:HD12	1.86	0.58
1:B:9:PRO:HB3	1:B:639:VAL:HG22	1.85	0.58
1:D:678:VAL:HG21	1:D:694:GLU:O	2.04	0.58
1:B:524:ALA:HA	1:B:539:MET:HE1	1.86	0.57
1:C:77:ARG:HG3	5:C:1062:HOH:O	2.04	0.57
1:D:505:ASP:HA	1:D:508:LYS:HE2	1.86	0.57
1:B:392:SER:HA	1:B:423:ALA:O	2.04	0.57

*Continued on next page...*

*Continued from previous page...*

Atom-1	Atom-2	Interatomic distance (Å)	Clash overlap (Å)
1:A:634:ARG:NH2	1:B:140:ALA:O	2.38	0.56
1:A:736:PRO:HG2	1:A:739:LEU:HD12	1.86	0.56
1:A:396:ASN:ND2	1:A:419:ARG:HG3	2.19	0.56
1:D:391:ILE:HB	1:D:425:PHE:HB2	1.88	0.56
1:D:411:PRO:HB2	1:D:447:PHE:CD1	2.40	0.56
1:A:687:GLU:OE2	1:A:800:LYS:NZ	2.33	0.56
1:C:419:ARG:HA	1:C:444:MET:HG2	1.87	0.56
1:A:239:LYS:C	1:A:245:ILE:HG22	2.27	0.55
1:A:308:ASP:HB3	1:A:311:ILE:HG12	1.88	0.55
1:A:359:ASP:OD2	2:A:902:SAM:N	2.39	0.55
1:C:231:LYS:HE2	2:C:901:SAM:C6	2.37	0.55
1:C:277:LEU:HD23	1:C:283:ILE:HG13	1.87	0.55
1:D:239:LYS:HB3	1:D:245:ILE:HB	1.89	0.55
1:D:341:VAL:HG11	1:D:383:ARG:HH21	1.71	0.55
1:D:353:LYS:HD3	1:D:389:ARG:HD2	1.89	0.55
1:A:635:ASN:HD22	1:B:141:PRO:HG3	1.72	0.55
1:B:48:ALA:CB	1:B:59:VAL:HG11	2.37	0.54
1:A:657:ARG:CZ	1:A:663:PRO:HG3	2.36	0.54
1:D:678:VAL:HG11	1:D:693:PHE:HB3	1.89	0.54
1:A:110:TRP:CD1	1:A:148:CYS:HA	2.43	0.54
1:A:533:LEU:O	1:A:534:ASP:HB3	2.08	0.54
1:B:239:LYS:HG3	1:B:245:ILE:HG22	1.90	0.54
1:B:403:VAL:HG21	1:B:406:LEU:HD22	1.90	0.54
1:D:686:HIS:HD2	1:D:688:CYS:H	1.54	0.54
1:C:640:PRO:HG2	1:D:161:LEU:HD22	1.90	0.53
1:B:356:VAL:HG22	1:B:391:ILE:HG12	1.91	0.53
1:B:330:VAL:HG23	1:B:332:LYS:H	1.73	0.53
1:B:49:GLN:HB3	1:B:53:MET:CE	2.33	0.53
1:B:277:LEU:HD23	1:B:283:ILE:HG13	1.90	0.53
1:A:164:LEU:HD11	1:B:650:ILE:CG1	2.39	0.53
1:D:400:ASP:OD1	1:D:400:ASP:N	2.42	0.53
1:B:409:LEU:HD12	1:B:423:ALA:HA	1.90	0.52
1:D:103:GLN:OE1	1:D:583:ASP:HA	2.09	0.52
1:D:205:ILE:HD13	1:D:225:ARG:HE	1.71	0.52
1:D:236:PRO:HB3	1:D:461:PHE:CE1	2.44	0.52
1:B:498:ARG:HG2	1:B:498:ARG:HH11	1.74	0.52
1:D:678:VAL:HG22	1:D:697:THR:O	2.09	0.52
1:D:688:CYS:O	1:D:761:ARG:NH2	2.42	0.52
1:B:347:ASN:HB2	1:B:350:GLN:CD	2.29	0.52
1:A:10:ASN:O	1:A:14:THR:OG1	2.26	0.52
1:A:447:PHE:CZ	1:A:455:GLN:HB2	2.46	0.51

*Continued on next page...*

*Continued from previous page...*

Atom-1	Atom-2	Interatomic distance (Å)	Clash overlap (Å)
1:A:31:SER:O	1:A:147:LYS:HE3	2.10	0.51
1:B:184:SER:OG	1:B:587:GLY:HA3	2.09	0.51
1:C:565:TYR:CZ	1:C:797:LEU:HD11	2.46	0.51
1:B:454:ASP:HA	1:B:457:ASN:ND2	2.25	0.51
1:C:370:GLN:HE21	1:C:397:ARG:HD3	1.76	0.51
1:C:545:THR:HA	1:C:554:TRP:O	2.10	0.51
1:A:741:LYS:HD2	1:A:742:SER:N	2.25	0.51
1:A:759:HIS:HE2	4:A:906:FLC:CGC	2.19	0.51
1:A:8:ILE:HA	1:A:9:PRO:C	2.31	0.51
1:C:800:LYS:O	1:C:801:ILE:HG13	2.11	0.51
1:A:759:HIS:NE2	4:A:906:FLC:OG2	2.29	0.51
1:C:67:GLU:OE1	1:C:69[A]:THR:HB	2.11	0.51
1:D:381:ILE:HD12	1:D:388:VAL:HG12	1.93	0.50
1:D:347:ASN:OD1	1:D:348:MET:N	2.44	0.50
1:C:58:HIS:CE1	1:D:58:HIS:CE1	3.00	0.50
1:A:477:LEU:HD13	1:A:506:ALA:HA	1.94	0.50
1:B:118:GLU:OE2	1:B:120:ARG:HB2	2.12	0.50
1:D:9:PRO:HB3	1:D:639:VAL:HG22	1.92	0.50
1:D:283:ILE:HG23	1:D:304:ILE:HG23	1.93	0.50
1:B:48:ALA:HB1	1:B:59:VAL:HG11	1.94	0.50
1:C:18:ARG:NH2	1:D:18:ARG:HG2	2.27	0.50
1:B:391:ILE:O	1:B:424:PHE:HA	2.11	0.50
1:C:638:TYR:HD1	1:D:142:LEU:HD21	1.76	0.50
1:D:212:ASN:HB3	1:D:215:TYR:HD2	1.77	0.50
1:B:705:LEU:HD11	1:B:795:ILE:HD13	1.94	0.49
1:D:202:ASP:HA	1:D:281:MET:HE3	1.93	0.49
1:C:412:GLN:NE2	1:C:420:GLU:HB3	2.27	0.49
1:D:534:ASP:HB3	1:D:538:LYS:HZ2	1.78	0.49
1:D:180:MET:HE2	1:D:183:ARG:HH21	1.78	0.49
1:D:323:THR:HG22	1:D:325:ALA:H	1.78	0.49
1:D:611:LYS:HE2	1:D:612:ARG:NH2	2.27	0.49
1:C:24:PHE:CG	1:C:531:LEU:HD22	2.48	0.49
1:C:67:GLU:OE1	1:C:69[B]:THR:OG1	2.27	0.49
1:D:276:MET:O	1:D:279:THR:HG22	2.13	0.48
1:C:412:GLN:HE21	1:C:420:GLU:HB3	1.78	0.48
1:D:357:ILE:HA	1:D:392:SER:HB3	1.96	0.48
1:D:733:ARG:O	1:D:755:LEU:N	2.42	0.48
1:D:487:TYR:HE1	1:D:600:PHE:CD2	2.31	0.48
1:A:417:SER:CA	1:A:448:THR:HG22	2.36	0.48
1:B:212:ASN:OD1	1:B:214:PRO:HD2	2.13	0.48
1:C:139:PHE:HA	1:D:640:PRO:HB3	1.96	0.48

*Continued on next page...*

*Continued from previous page...*

Atom-1	Atom-2	Interatomic distance (Å)	Clash overlap (Å)
1:A:527:LYS:NZ	1:A:527:LYS:HB3	2.29	0.48
1:D:191:ALA:HA	1:D:224:ILE:HD11	1.96	0.48
1:B:316:THR:HG23	1:B:327:VAL:HG13	1.96	0.48
1:A:172:TRP:HZ2	1:A:592:ALA:HB2	1.79	0.47
1:A:472:ALA:O	1:A:475:MET:HE2	2.15	0.47
1:D:201:ILE:HD12	1:D:204:ARG:HD2	1.96	0.47
1:A:533:LEU:O	1:A:533:LEU:HD13	2.14	0.47
1:A:245:ILE:HD12	1:A:409:LEU:HB3	1.95	0.47
1:D:434:LYS:HB3	1:D:434:LYS:HE3	1.52	0.47
1:C:705:LEU:CD2	1:C:791:LEU:HD21	2.37	0.47
1:D:38:LEU:O	1:D:94:THR:HA	2.15	0.47
1:A:216:VAL:HA	1:A:226:PRO:HG3	1.97	0.47
1:A:239:LYS:HB2	1:A:245:ILE:CG2	2.45	0.47
1:D:216:VAL:HG21	1:D:463:HIS:NE2	2.30	0.47
1:A:245:ILE:CD1	1:A:409:LEU:HB3	2.45	0.47
1:A:640:PRO:HG3	1:B:142:LEU:HD12	1.97	0.46
1:D:184:SER:OG	1:D:587:GLY:HA3	2.15	0.46
1:B:351:ASN:OD1	1:B:351:ASN:N	2.47	0.46
1:B:272:LEU:HD22	1:B:422:ARG:HD3	1.96	0.46
1:C:368:LYS:O	1:C:372:GLU:HG3	2.15	0.46
1:D:794:ALA:O	1:D:798:VAL:HG23	2.15	0.46
1:A:164:LEU:HD11	1:B:650:ILE:HG12	1.96	0.46
1:D:57:THR:HG21	1:D:88:GLN:OE1	2.16	0.46
1:D:283:ILE:O	1:D:304:ILE:HA	2.16	0.46
1:D:374:GLN:NE2	1:D:378:GLU:OE2	2.46	0.46
1:D:485:ALA:HB1	1:D:489:LEU:HD13	1.98	0.46
1:B:655:TYR:CE1	1:B:769:GLU:HB3	2.50	0.46
1:D:16:ASN:HA	1:D:782:LYS:HE2	1.97	0.46
1:D:17:GLU:OE1	1:D:782:LYS:HE3	2.15	0.46
1:C:225:ARG:NE	1:C:281:MET:SD	2.89	0.46
1:D:411:PRO:HG3	1:D:443:TYR:HE2	1.80	0.46
1:A:164:LEU:HD13	1:A:164:LEU:HA	1.60	0.46
1:D:543:LEU:HD12	1:D:557:TYR:CE1	2.51	0.46
1:B:38:LEU:O	1:B:94:THR:HA	2.15	0.46
1:C:516:GLY:HA3	1:C:602:TRP:CZ3	2.50	0.46
1:D:577:MET:HB2	1:D:577:MET:HE2	1.69	0.46
1:A:184:SER:OG	1:A:587:GLY:HA3	2.16	0.46
1:A:527:LYS:HE3	1:A:538:LYS:HA	1.96	0.46
1:B:173:TYR:HA	3:B:903:EDO:H21	1.97	0.45
1:D:447:PHE:HD2	1:D:447:PHE:O	1.98	0.45
1:B:347:ASN:HD22	1:B:350:GLN:NE2	2.15	0.45

*Continued on next page...*

*Continued from previous page...*

Atom-1	Atom-2	Interatomic distance (Å)	Clash overlap (Å)
1:D:35:VAL:HG11	1:D:105:MET:CE	2.46	0.45
1:D:436:LEU:HD22	1:D:439:GLU:HG3	1.98	0.45
1:B:217:TRP:CD1	1:B:270:LEU:HD21	2.42	0.45
1:C:648:ARG:HD2	1:C:706:LEU:CD1	2.47	0.45
1:D:220:LEU:HD13	1:D:220:LEU:HA	1.76	0.45
1:D:72:LEU:HD22	1:D:108:ILE:HD13	1.99	0.45
1:D:202:ASP:HA	1:D:281:MET:CE	2.47	0.45
1:D:205:ILE:HD12	1:D:225:ARG:NE	2.30	0.45
1:D:741:LYS:HZ1	1:D:742:SER:HG	1.51	0.45
1:A:328:ILE:HD13	1:A:348:MET:HE1	1.98	0.45
1:C:46:LYS:NZ	1:C:50:ASP:OD2	2.50	0.45
1:D:282:ASN:HB2	1:D:353:LYS:O	2.17	0.45
1:D:299:LEU:HD12	1:D:323:THR:HG23	1.97	0.45
1:D:381:ILE:HG13	1:D:427:LYS:HG2	1.99	0.45
1:A:643:THR:HG23	1:B:168:ALA:HB1	1.99	0.44
1:D:106:LYS:HB2	1:D:116:PHE:CE2	2.51	0.44
1:A:655:TYR:CE1	1:A:769:GLU:HB3	2.53	0.44
1:C:370:GLN:HB2	1:C:397:ARG:HD3	1.99	0.44
1:D:546:PHE:HB2	1:D:554:TRP:CE2	2.52	0.44
1:A:615:MET:HE1	1:A:729:MET:SD	2.57	0.44
1:B:110:TRP:CD1	1:B:148:CYS:HA	2.53	0.44
1:A:741:LYS:HD2	1:A:741:LYS:C	2.38	0.44
1:C:17:GLU:O	1:C:21:ILE:HG12	2.17	0.44
1:C:564:LEU:HD13	1:C:564:LEU:HA	1.78	0.44
2:C:902:SAM:HG2	2:C:902:SAM:H4'	1.76	0.44
1:D:748:LYS:HD3	1:D:748:LYS:HA	1.78	0.43
1:C:216:VAL:HA	1:C:226:PRO:HG3	1.99	0.43
1:D:616:GLN:HB2	1:D:725:GLN:CD	2.39	0.43
4:D:903:FLC:OA1	4:D:903:FLC:OHB	2.33	0.43
1:B:541:LYS:HB3	1:B:542:ASP:H	1.67	0.43
1:D:490:SER:OG	1:D:556:ASP:OD1	2.34	0.43
1:D:510:LYS:HA	1:D:607:TRP:CD1	2.53	0.43
1:A:172:TRP:CZ2	1:A:592:ALA:HB2	2.54	0.43
1:A:498:ARG:HG2	1:A:498:ARG:HH11	1.83	0.43
1:D:576:GLN:OE1	1:D:718:PRO:HB3	2.19	0.43
1:A:379:TRP:CZ2	1:A:383:ARG:HD2	2.54	0.43
1:C:60:HIS:NE2	5:C:1002:HOH:O	2.35	0.43
1:D:292:THR:O	1:D:295:LEU:HD23	2.18	0.43
1:D:299:LEU:HB2	1:D:323:THR:HG23	2.00	0.43
1:A:311:ILE:HD12	1:A:315:TRP:CE3	2.53	0.43
1:D:239:LYS:CB	1:D:245:ILE:HB	2.48	0.43

*Continued on next page...*



*Continued from previous page...*

Atom-1	Atom-2	Interatomic distance (Å)	Clash overlap (Å)
1:D:35:VAL:HG11	1:D:105:MET:HE3	2.00	0.43
1:B:216:VAL:HA	1:B:226:PRO:HG3	2.01	0.42
2:A:902:SAM:HG2	2:A:902:SAM:H4'	1.98	0.42
1:C:38:LEU:O	1:C:94:THR:HA	2.19	0.42
1:D:205:ILE:HD11	1:D:225:ARG:HH11	0.27	0.42
1:C:9:PRO:HG3	1:C:643:THR:HG21	2.00	0.42
1:A:615:MET:HE2	1:A:615:MET:HA	2.00	0.42
1:C:662:ASP:HB3	1:C:665:GLN:HG3	2.00	0.42
1:B:43:LEU:HD12	1:B:43:LEU:HA	1.77	0.42
1:B:220:LEU:HD13	1:B:220:LEU:HA	1.89	0.42
1:B:527:LYS:HD3	1:B:539:MET:HE2	2.01	0.42
1:C:370:GLN:HE22	1:C:396:ASN:H	1.68	0.42
1:B:320:ALA:HB2	1:B:327:VAL:HG12	2.01	0.42
1:A:307:PHE:CE2	1:A:330:VAL:HG11	2.55	0.42
1:B:347:ASN:HB2	1:B:350:GLN:CG	2.49	0.42
1:A:245:ILE:HG23	1:A:245:ILE:O	2.20	0.42
1:B:201:ILE:HG21	1:B:301:GLY:HA3	2.02	0.42
1:A:289:TYR:HA	1:A:290:PRO:HA	1.82	0.42
1:B:406:LEU:HD13	1:B:425:PHE:CE1	2.55	0.42
1:C:110:TRP:CD1	1:C:148:CYS:HA	2.55	0.42
1:C:554:TRP:CD2	1:C:555:ARG:HG3	2.55	0.42
1:A:762:GLU:O	1:A:766:LEU:HB2	2.20	0.41
1:C:48:ALA:O	1:C:52:SER:HB3	2.20	0.41
1:C:211:TYR:CZ	1:C:213:PRO:HG3	2.55	0.41
1:B:274:THR:HG22	1:B:297:LEU:HD11	2.02	0.41
1:C:374:GLN:NE2	1:C:403:VAL:HG12	2.35	0.41
1:C:539:MET:HB2	1:C:539:MET:HE2	1.93	0.41
1:D:20:ILE:HG21	1:D:529:VAL:HG11	2.02	0.41
1:D:319:MET:O	1:D:323:THR:HB	2.20	0.41
1:D:736:PRO:HG2	1:D:739:LEU:HD12	2.01	0.41
1:C:436:LEU:HB2	1:C:439:GLU:HG3	2.03	0.41
1:D:543:LEU:HD11	1:D:555:ARG:NH2	2.36	0.41
1:A:38:LEU:O	1:A:94:THR:HA	2.20	0.41
1:B:720:ILE:HD13	1:B:720:ILE:HA	1.87	0.41
1:A:419:ARG:HG2	1:A:420:GLU:N	2.36	0.41
1:B:534:ASP:OD1	1:B:538:LYS:HG2	2.21	0.41
1:C:472:ALA:HB1	1:C:475:MET:HE3	2.02	0.41
1:C:477:LEU:HD21	1:C:502:PHE:CE1	2.55	0.41
1:A:531:LEU:HD21	1:A:595:THR:HG21	2.02	0.41
1:B:627:LYS:HG3	5:B:1033:HOH:O	2.19	0.41
1:B:674:LYS:NZ	1:B:698:ASP:OD2	2.46	0.41

*Continued on next page...*

Continued from previous page...

Atom-1	Atom-2	Interatomic distance (Å)	Clash overlap (Å)
1:C:797:LEU:HD22	1:C:800:LYS:HD3	2.03	0.41
1:B:347:ASN:HB2	1:B:350:GLN:HG2	2.03	0.41
1:C:328:ILE:HD13	1:C:348:MET:HE1	2.02	0.41
1:D:377:PHE:HB3	1:D:391:ILE:HD12	2.03	0.41
1:D:437:ALA:HA	1:D:440:THR:HG23	2.03	0.41
1:A:211:TYR:CZ	1:A:213:PRO:HG3	2.56	0.41
1:A:766:LEU:HD23	1:A:766:LEU:HA	1.72	0.41
1:B:172:TRP:HZ2	1:B:592:ALA:HB2	1.86	0.41
1:C:172:TRP:CG	1:D:8:ILE:HG23	2.55	0.41
1:C:554:TRP:CE2	1:C:555:ARG:HG3	2.56	0.41
1:C:722:TRP:CZ2	1:C:726:MET:HE2	2.56	0.41
1:D:43:LEU:HD12	1:D:43:LEU:HA	1.88	0.41
1:D:421:MET:HG3	1:D:444:MET:SD	2.60	0.41
1:D:655:TYR:CE1	1:D:769:GLU:HB3	2.56	0.41
1:D:755:LEU:HD12	1:D:755:LEU:HA	1.86	0.41
1:D:236:PRO:HG2	1:D:244:LEU:HD12	2.03	0.41
1:D:402:SER:HA	1:D:434:LYS:HA	2.03	0.41
1:B:147:LYS:HE3	5:B:1064:HOH:O	2.21	0.40
1:B:311:ILE:HG21	1:B:329:GLY:HA3	2.03	0.40
1:B:356:VAL:CG2	1:B:391:ILE:HG23	2.51	0.40
1:A:472:ALA:HB1	1:A:475:MET:CE	2.51	0.40
1:A:523:LEU:O	1:A:527:LYS:HG3	2.22	0.40
1:B:8:ILE:HA	1:B:9:PRO:C	2.42	0.40
1:B:759:HIS:NE2	4:B:905:FLC:OA2	2.54	0.40
1:D:139:PHE:CZ	1:D:158:TYR:HB3	2.57	0.40
1:D:216:VAL:HA	1:D:226:PRO:HG3	2.04	0.40
1:D:353:LYS:CD	1:D:389:ARG:HD2	2.49	0.40
1:D:38:LEU:HD21	1:D:44:ALA:HB2	2.04	0.40

There are no symmetry-related clashes.

## 5.3 Torsion angles [\(i\)](#)

### 5.3.1 Protein backbone [\(i\)](#)

In the following table, the Percentiles column shows the percent Ramachandran outliers of the chain as a percentile score with respect to all X-ray entries followed by that with respect to entries of similar resolution.

The Analysed column shows the number of residues for which the backbone conformation was analysed, and the total number of residues.

Mol	Chain	Analysed	Favoured	Allowed	Outliers	Percentiles	
1	A	775/804 (96%)	752 (97%)	23 (3%)	0	100	100
1	B	677/804 (84%)	658 (97%)	19 (3%)	0	100	100
1	C	770/804 (96%)	750 (97%)	20 (3%)	0	100	100
1	D	691/804 (86%)	670 (97%)	21 (3%)	0	100	100
All	All	2913/3216 (91%)	2830 (97%)	83 (3%)	0	100	100

There are no Ramachandran outliers to report.

### 5.3.2 Protein sidechains [i](#)

In the following table, the Percentiles column shows the percent sidechain outliers of the chain as a percentile score with respect to all X-ray entries followed by that with respect to entries of similar resolution.

The Analysed column shows the number of residues for which the sidechain conformation was analysed, and the total number of residues.

Mol	Chain	Analysed	Rotameric	Outliers	Percentiles	
1	A	691/711 (97%)	684 (99%)	7 (1%)	76	82
1	B	615/711 (86%)	609 (99%)	6 (1%)	76	82
1	C	686/711 (96%)	676 (98%)	10 (2%)	65	71
1	D	627/711 (88%)	611 (97%)	16 (3%)	46	50
All	All	2619/2844 (92%)	2580 (98%)	39 (2%)	65	71

All (39) residues with a non-rotameric sidechain are listed below:

Mol	Chain	Res	Type
1	A	52	SER
1	A	285	TYR
1	A	371	SER
1	A	419	ARG
1	A	422	ARG
1	A	562	SER
1	A	741	LYS
1	B	5	ASP
1	B	18	ARG
1	B	307	PHE
1	B	308	ASP
1	B	539	MET
1	B	556	ASP

*Continued on next page...*

*Continued from previous page...*

Mol	Chain	Res	Type
1	C	285	TYR
1	C	338	SER
1	C	399	LYS
1	C	417	SER
1	C	476	ASP
1	C	554	TRP
1	C	561	GLN
1	C	564	LEU
1	C	575	ASP
1	C	621	SER
1	D	105	MET
1	D	126	SER
1	D	285	TYR
1	D	293	HIS
1	D	389	ARG
1	D	390	LEU
1	D	404	SER
1	D	422	ARG
1	D	434	LYS
1	D	442	LYS
1	D	447	PHE
1	D	541	LYS
1	D	566	ASP
1	D	696	SER
1	D	717	SER
1	D	741	LYS

Sometimes sidechains can be flipped to improve hydrogen bonding and reduce clashes. All (4) such sidechains are listed below:

Mol	Chain	Res	Type
1	A	635	ASN
1	B	350	GLN
1	C	370	GLN
1	D	665	GLN

### 5.3.3 RNA [i](#)

There are no RNA molecules in this entry.

## 5.4 Non-standard residues in protein, DNA, RNA chains [i](#)

There are no non-standard protein/DNA/RNA residues in this entry.

## 5.5 Carbohydrates [i](#)

There are no monosaccharides in this entry.

## 5.6 Ligand geometry [i](#)

17 ligands are modelled in this entry.

In the following table, the Counts columns list the number of bonds (or angles) for which Mogul statistics could be retrieved, the number of bonds (or angles) that are observed in the model and the number of bonds (or angles) that are defined in the Chemical Component Dictionary. The Link column lists molecule types, if any, to which the group is linked. The Z score for a bond length (or angle) is the number of standard deviations the observed value is removed from the expected value. A bond length (or angle) with  $|Z| > 2$  is considered an outlier worth inspection. RMSZ is the root-mean-square of all Z scores of the bond lengths (or angles).

Mol	Type	Chain	Res	Link	Bond lengths			Bond angles		
					Counts	RMSZ	# Z  > 2	Counts	RMSZ	# Z  > 2
3	EDO	A	905	-	3,3,3	0.62	0	2,2,2	0.49	0
3	EDO	C	903	-	3,3,3	0.38	0	2,2,2	0.33	0
3	EDO	D	901	-	3,3,3	0.45	0	2,2,2	0.31	0
3	EDO	B	902	-	3,3,3	0.58	0	2,2,2	0.21	0
4	FLC	D	903	-	12,12,12	1.07	0	17,17,17	1.42	2 (11%)
3	EDO	A	904	-	3,3,3	0.59	0	2,2,2	0.43	0
2	SAM	A	901	-	24,29,29	1.26	2 (8%)	23,42,42	1.57	3 (13%)
3	EDO	A	903	-	3,3,3	0.62	0	2,2,2	0.23	0
3	EDO	B	903	-	3,3,3	0.51	0	2,2,2	0.18	0
4	FLC	A	906	-	12,12,12	1.52	1 (8%)	17,17,17	1.84	6 (35%)
3	EDO	D	902	-	3,3,3	0.51	0	2,2,2	0.25	0
2	SAM	C	901	-	24,29,29	1.21	2 (8%)	23,42,42	1.58	3 (13%)
2	SAM	B	901	-	24,29,29	1.21	3 (12%)	23,42,42	1.56	3 (13%)
2	SAM	A	902	-	24,29,29	1.20	3 (12%)	23,42,42	1.78	5 (21%)
3	EDO	B	904	-	3,3,3	0.44	0	2,2,2	0.58	0
4	FLC	B	905	-	12,12,12	1.35	1 (8%)	17,17,17	1.80	3 (17%)
2	SAM	C	902	-	24,29,29	1.21	3 (12%)	23,42,42	1.68	4 (17%)

In the following table, the Chirals column lists the number of chiral outliers, the number of chiral centers analysed, the number of these observed in the model and the number defined in the

Chemical Component Dictionary. Similar counts are reported in the Torsion and Rings columns. '-' means no outliers of that kind were identified.

Mol	Type	Chain	Res	Link	Chirals	Torsions	Rings
3	EDO	A	905	-	-	0/1/1/1	-
3	EDO	C	903	-	-	0/1/1/1	-
3	EDO	D	901	-	-	0/1/1/1	-
3	EDO	B	902	-	-	0/1/1/1	-
4	FLC	D	903	-	-	1/16/16/16	-
3	EDO	A	904	-	-	1/1/1/1	-
2	SAM	A	901	-	-	6/12/33/33	0/3/3/3
3	EDO	A	903	-	-	0/1/1/1	-
3	EDO	B	903	-	-	1/1/1/1	-
4	FLC	A	906	-	-	7/16/16/16	-
3	EDO	D	902	-	-	1/1/1/1	-
2	SAM	C	901	-	-	5/12/33/33	0/3/3/3
2	SAM	B	901	-	-	3/12/33/33	0/3/3/3
2	SAM	A	902	-	-	3/12/33/33	0/3/3/3
3	EDO	B	904	-	-	0/1/1/1	-
4	FLC	B	905	-	-	7/16/16/16	-
2	SAM	C	902	-	-	3/12/33/33	0/3/3/3

All (15) bond length outliers are listed below:

Mol	Chain	Res	Type	Atoms	Z	Observed(Å)	Ideal(Å)
2	B	901	SAM	C2-N3	4.17	1.38	1.32
2	A	901	SAM	C2-N3	4.08	1.38	1.32
2	C	902	SAM	C2-N3	3.99	1.38	1.32
2	A	902	SAM	C2-N3	3.98	1.38	1.32
2	C	901	SAM	C2-N3	3.92	1.38	1.32
2	A	901	SAM	C2-N1	3.13	1.39	1.33
4	A	906	FLC	CB-CBC	2.51	1.56	1.53
2	B	901	SAM	C2-N1	2.48	1.38	1.33
2	C	901	SAM	C2-N1	2.44	1.38	1.33
2	C	902	SAM	C2-N1	2.37	1.38	1.33
2	A	902	SAM	C2-N1	2.24	1.38	1.33
2	C	902	SAM	OXT-C	-2.08	1.23	1.30
2	A	902	SAM	OXT-C	-2.06	1.23	1.30
2	B	901	SAM	OXT-C	-2.05	1.23	1.30
4	B	905	FLC	CA-CB	-2.04	1.51	1.53

All (29) bond angle outliers are listed below:

Mol	Chain	Res	Type	Atoms	Z	Observed(°)	Ideal(°)
2	C	902	SAM	N3-C2-N1	-6.09	119.16	128.68
2	A	902	SAM	N3-C2-N1	-5.93	119.42	128.68
2	C	901	SAM	N3-C2-N1	-5.47	120.12	128.68
2	B	901	SAM	N3-C2-N1	-5.36	120.30	128.68
2	A	901	SAM	N3-C2-N1	-5.30	120.40	128.68
4	B	905	FLC	CB-CA-CAC	-4.19	103.66	113.81
4	B	905	FLC	OB2-CBC-CB	3.86	119.75	113.05
4	A	906	FLC	CB-CG-CGC	-3.71	104.83	113.81
4	A	906	FLC	OB2-CBC-CB	3.46	119.05	113.05
4	D	903	FLC	OB2-CBC-CB	3.38	118.92	113.05
2	A	901	SAM	OXT-C-O	-3.28	116.64	124.09
2	A	902	SAM	OXT-C-O	-3.24	116.74	124.09
2	A	902	SAM	OXT-C-CA	2.92	123.34	113.38
2	B	901	SAM	OXT-C-O	-2.72	117.92	124.09
2	A	901	SAM	OXT-C-CA	2.55	122.08	113.38
2	C	901	SAM	OXT-C-O	-2.54	118.33	124.09
2	C	901	SAM	OXT-C-CA	2.51	121.92	113.38
4	A	906	FLC	OHB-CB-CBC	2.48	112.34	108.86
2	C	902	SAM	OXT-C-O	-2.35	118.75	124.09
2	C	902	SAM	OXT-C-CA	2.29	121.19	113.38
2	C	902	SAM	C4-C5-N7	-2.28	107.02	109.40
2	B	901	SAM	OXT-C-CA	2.25	121.06	113.38
4	A	906	FLC	OA2-CAC-CA	2.25	121.59	114.35
4	D	903	FLC	OB1-CBC-CB	-2.17	119.17	122.25
4	A	906	FLC	OA2-CAC-OA1	-2.08	118.13	123.30
4	A	906	FLC	OB2-CBC-OB1	-2.04	117.34	123.82
4	B	905	FLC	OG2-CGC-CG	2.03	120.88	114.35
2	A	902	SAM	C2'-C3'-C4'	2.02	106.57	102.64
2	A	902	SAM	C4-C5-N7	-2.00	107.31	109.40

There are no chirality outliers.

All (38) torsion outliers are listed below:

Mol	Chain	Res	Type	Atoms
2	A	901	SAM	N-CA-CB-CG
2	A	901	SAM	C-CA-CB-CG
2	A	901	SAM	CB-CG-SD-C5'
2	A	901	SAM	O4'-C4'-C5'-SD
2	A	901	SAM	C3'-C4'-C5'-SD
2	A	902	SAM	O4'-C4'-C5'-SD
2	A	902	SAM	C3'-C4'-C5'-SD
2	B	901	SAM	CA-CB-CG-SD
2	C	901	SAM	N-CA-CB-CG

*Continued on next page...*

*Continued from previous page...*

Mol	Chain	Res	Type	Atoms
2	C	901	SAM	C-CA-CB-CG
2	C	901	SAM	CA-CB-CG-SD
2	C	901	SAM	O4'-C4'-C5'-SD
2	C	901	SAM	C3'-C4'-C5'-SD
2	C	902	SAM	O4'-C4'-C5'-SD
2	C	902	SAM	C3'-C4'-C5'-SD
4	A	906	FLC	CAC-CA-CB-CBC
4	A	906	FLC	CAC-CA-CB-CG
4	A	906	FLC	CAC-CA-CB-OHB
4	A	906	FLC	CG-CB-CBC-OB1
4	A	906	FLC	CG-CB-CBC-OB2
4	A	906	FLC	OHB-CB-CBC-OB1
4	A	906	FLC	OHB-CB-CBC-OB2
4	B	905	FLC	CA-CB-CBC-OB1
4	B	905	FLC	CA-CB-CBC-OB2
4	B	905	FLC	OHB-CB-CBC-OB1
4	B	905	FLC	OHB-CB-CBC-OB2
4	B	905	FLC	CA-CB-CG-CGC
4	B	905	FLC	CBC-CB-CG-CGC
4	B	905	FLC	OHB-CB-CG-CGC
2	A	901	SAM	CB-CG-SD-CE
3	A	904	EDO	O1-C1-C2-O2
2	A	902	SAM	C4'-C5'-SD-CG
2	C	902	SAM	C4'-C5'-SD-CG
2	B	901	SAM	O-C-CA-CB
2	B	901	SAM	OXT-C-CA-CB
3	D	902	EDO	O1-C1-C2-O2
4	D	903	FLC	CAC-CA-CB-CG
3	B	903	EDO	O1-C1-C2-O2

There are no ring outliers.

8 monomers are involved in 11 short contacts:

Mol	Chain	Res	Type	Clashes	Symm-Clashes
3	B	902	EDO	1	0
4	D	903	FLC	1	0
3	B	903	EDO	1	0
4	A	906	FLC	2	0
2	C	901	SAM	1	0
2	A	902	SAM	2	0
4	B	905	FLC	1	0
2	C	902	SAM	2	0



The following is a two-dimensional graphical depiction of Mogul quality analysis of bond lengths, bond angles, torsion angles, and ring geometry for all instances of the Ligand of Interest. In addition, ligands with molecular weight > 250 and outliers as shown on the validation Tables will also be included. For torsion angles, if less than 5% of the Mogul distribution of torsion angles is within 10 degrees of the torsion angle in question, then that torsion angle is considered an outlier. Any bond that is central to one or more torsion angles identified as an outlier by Mogul will be highlighted in the graph. For rings, the root-mean-square deviation (RMSD) between the ring in question and similar rings identified by Mogul is calculated over all ring torsion angles. If the average RMSD is greater than 60 degrees and the minimal RMSD between the ring in question and any Mogul-identified rings is also greater than 60 degrees, then that ring is considered an outlier. The outliers are highlighted in purple. The color gray indicates Mogul did not find sufficient equivalents in the CSD to analyse the geometry.

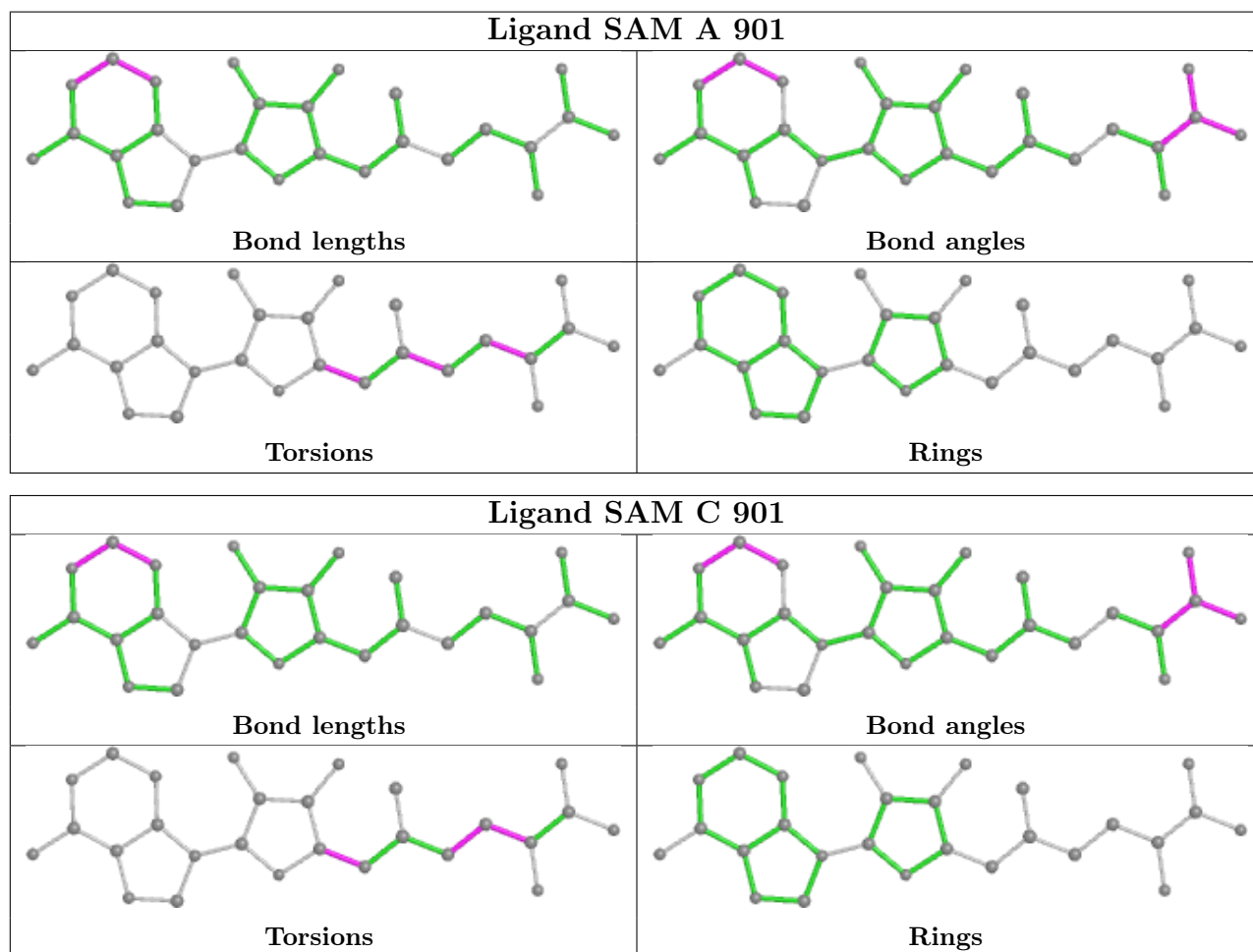

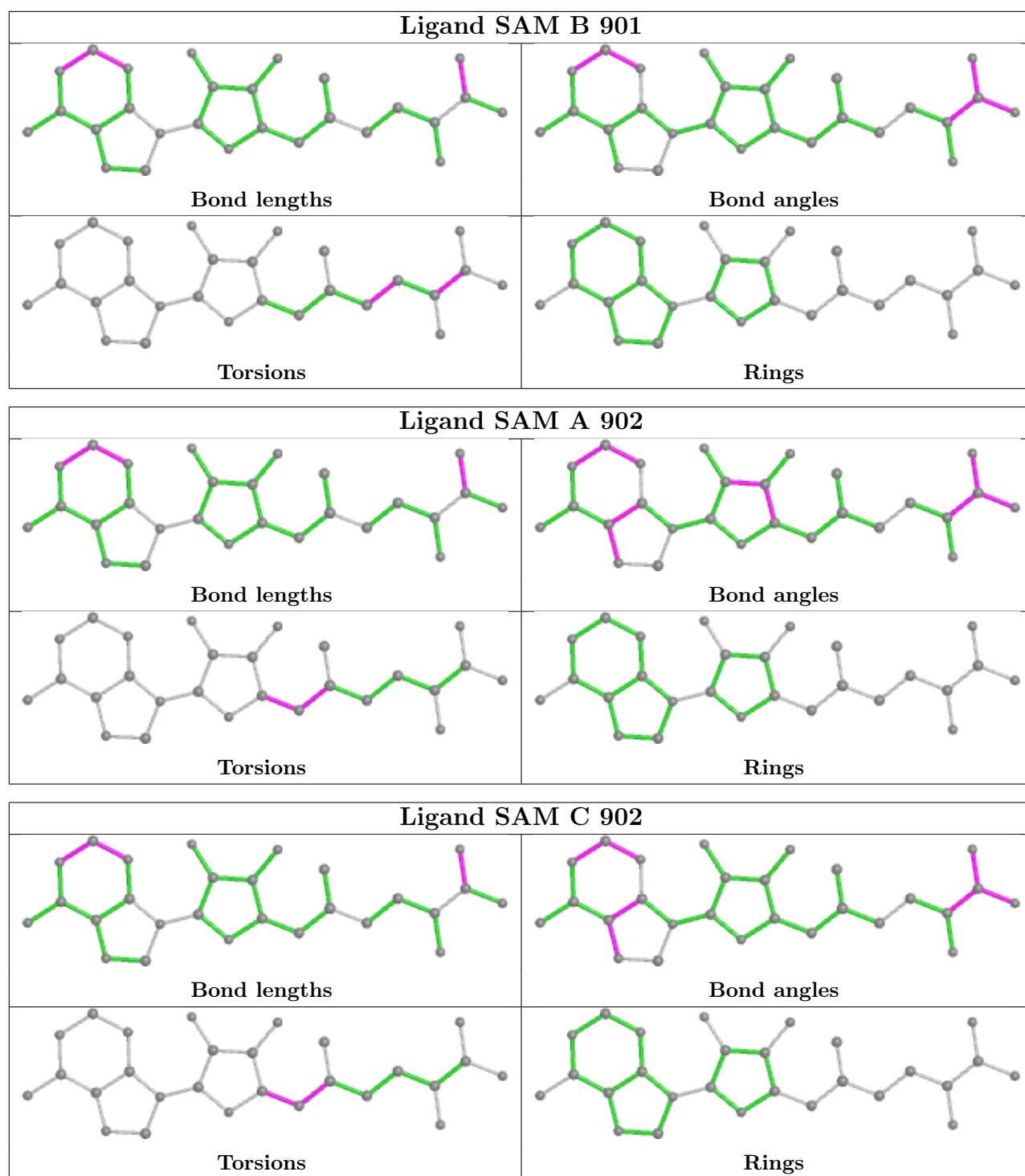

## 5.7 Other polymers [\(i\)](#)

There are no such residues in this entry.

## 5.8 Polymer linkage issues

There are no chain breaks in this entry.

## 6 Fit of model and data

### 6.1 Protein, DNA and RNA chains

In the following table, the column labelled ‘#RSRZ > 2’ contains the number (and percentage) of RSRZ outliers, followed by percent RSRZ outliers for the chain as percentile scores relative to all X-ray entries and entries of similar resolution. The OWAB column contains the minimum, median, 95<sup>th</sup> percentile and maximum values of the occupancy-weighted average B-factor per residue. The column labelled ‘Q < 0.9’ lists the number of (and percentage) of residues with an average occupancy less than 0.9.

Mol	Chain	Analysed	<RSRZ>	#RSRZ>2	OWAB(Å <sup>2</sup> )	Q<0.9
1	A	779/804 (96%)	0.34	61 (7%) 13 17	9, 23, 67, 83	0
1	B	694/804 (86%)	0.57	92 (13%) 3 4	12, 30, 83, 94	0
1	C	774/804 (96%)	0.17	39 (5%) 28 34	11, 27, 60, 83	0
1	D	713/804 (88%)	1.13	148 (20%) 1 0	16, 44, 87, 106	0
All	All	2960/3216 (92%)	0.54	340 (11%) 4 6	9, 31, 79, 106	0

All (340) RSRZ outliers are listed below:

Mol	Chain	Res	Type	RSRZ
1	A	533	LEU	9.5
1	A	416	ALA	9.3
1	D	554	TRP	8.4
1	D	450	MET	8.0
1	A	438	ALA	7.3
1	B	4	PRO	7.1
1	D	443	TYR	7.0
1	D	318	ALA	6.9
1	B	452	VAL	6.7
1	D	311	ILE	6.5
1	D	269	LEU	6.4
1	D	449	ALA	6.3
1	D	351	ASN	6.3
1	C	7	CYS	6.2
1	D	375	ALA	6.2
1	B	307	PHE	6.2
1	B	312	THR	6.1
1	A	362	VAL	6.0
1	D	158	TYR	6.0
1	D	384	THR	6.0
1	D	447	PHE	6.0

*Continued on next page...*

*Continued from previous page...*

<b>Mol</b>	<b>Chain</b>	<b>Res</b>	<b>Type</b>	<b>RSRZ</b>
1	D	347	ASN	5.9
1	B	309	PRO	5.9
1	D	487	TYR	5.8
1	D	442	LYS	5.8
1	B	269	LEU	5.6
1	D	234	PRO	5.6
1	D	289	TYR	5.6
1	D	352	SER	5.6
1	B	456	ILE	5.6
1	B	405	HIS	5.5
1	D	123	SER	5.4
1	D	322	ALA	5.3
1	D	341	VAL	5.3
1	B	425	PHE	5.3
1	B	318	ALA	5.3
1	D	386	ILE	5.2
1	D	155	PRO	5.2
1	B	328	ILE	5.1
1	A	5	ASP	5.0
1	D	432	ASP	5.0
1	A	547	SER	5.0
1	D	438	ALA	5.0
1	D	348	MET	5.0
1	B	407	LEU	4.9
1	D	385	SER	4.9
1	D	448	THR	4.9
1	D	533	LEU	4.8
1	C	234	PRO	4.8
1	A	451	SER	4.8
1	D	312	THR	4.8
1	B	384	THR	4.8
1	D	170	THR	4.8
1	D	753	GLY	4.8
1	D	316	THR	4.7
1	D	342	GLN	4.7
1	D	321	LYS	4.6
1	A	535	SER	4.6
1	B	453	SER	4.6
1	B	331	SER	4.6
1	B	308	ASP	4.6
1	D	405	HIS	4.5
1	A	436	LEU	4.5

*Continued on next page...*

*Continued from previous page...*

<b>Mol</b>	<b>Chain</b>	<b>Res</b>	<b>Type</b>	<b>RSRZ</b>
1	B	239	LYS	4.5
1	B	311	ILE	4.5
1	A	554	TRP	4.5
1	A	534	ASP	4.5
1	D	436	LEU	4.5
1	D	307	PHE	4.4
1	D	315	TRP	4.4
1	B	313	SER	4.4
1	B	332	LYS	4.4
1	D	198	ALA	4.4
1	D	350	GLN	4.4
1	B	554	TRP	4.4
1	B	403	VAL	4.3
1	B	381	ILE	4.3
1	D	313	SER	4.3
1	D	751	PRO	4.3
1	D	291	ALA	4.3
1	B	245	ILE	4.2
1	A	449	ALA	4.2
1	D	382	ASP	4.2
1	D	752	SER	4.2
1	D	801	ILE	4.2
1	D	349	PHE	4.2
1	B	234	PRO	4.2
1	D	306	ALA	4.2
1	B	314	ASP	4.2
1	A	434	LYS	4.1
1	D	270	LEU	4.1
1	C	10	ASN	4.0
1	D	200	PRO	4.0
1	B	421	MET	4.0
1	B	246	LEU	4.0
1	B	406	LEU	3.9
1	C	451	SER	3.9
1	D	343	ALA	3.9
1	D	735	LEU	3.9
1	B	382	ASP	3.8
1	A	418	ILE	3.8
1	A	437	ALA	3.8
1	B	270	LEU	3.8
1	B	166	THR	3.8
1	D	239	LYS	3.8

*Continued on next page...*

*Continued from previous page...*

<b>Mol</b>	<b>Chain</b>	<b>Res</b>	<b>Type</b>	<b>RSRZ</b>
1	C	554	TRP	3.8
1	B	306	ALA	3.8
1	A	6	TYR	3.7
1	D	159	SER	3.7
1	D	379	TRP	3.7
1	A	536	ALA	3.7
1	D	156	THR	3.7
1	B	235	ASN	3.6
1	B	409	LEU	3.6
1	B	317	ASP	3.6
1	C	436	LEU	3.6
1	D	157	VAL	3.6
1	B	410	LEU	3.6
1	D	345	GLN	3.6
1	B	451	SER	3.6
1	B	458	THR	3.5
1	B	330	VAL	3.5
1	B	389	ARG	3.5
1	D	344	ASN	3.5
1	D	246	LEU	3.5
1	A	454	ASP	3.5
1	D	401	THR	3.5
1	A	532	VAL	3.5
1	D	169	ARG	3.5
1	C	399	LYS	3.5
1	A	452	VAL	3.5
1	D	536	ALA	3.5
1	D	359	ASP	3.4
1	D	201	ILE	3.4
1	A	265	PRO	3.4
1	C	432	ASP	3.4
1	B	427	LYS	3.4
1	D	457	ASN	3.4
1	A	401	THR	3.4
1	D	399	LYS	3.4
1	D	320	ALA	3.4
1	A	399	LYS	3.3
1	B	248	VAL	3.3
1	D	557	TYR	3.3
1	B	284	LEU	3.3
1	D	161	LEU	3.3
1	D	439	GLU	3.3

*Continued on next page...*

*Continued from previous page...*

<b>Mol</b>	<b>Chain</b>	<b>Res</b>	<b>Type</b>	<b>RSRZ</b>
1	B	165	ALA	3.3
1	D	430	ALA	3.3
1	C	431	SER	3.3
1	D	407	LEU	3.3
1	A	400	ASP	3.3
1	C	801	ILE	3.3
1	A	751	PRO	3.3
1	D	690	PRO	3.3
1	B	305	LEU	3.2
1	B	310	LYS	3.2
1	B	454	ASP	3.2
1	B	455	GLN	3.2
1	A	402	SER	3.2
1	C	402	SER	3.2
1	D	304	ILE	3.2
1	B	380	LEU	3.2
1	D	532	VAL	3.2
1	B	351	ASN	3.2
1	B	244	LEU	3.1
1	D	317	ASP	3.1
1	D	444	MET	3.1
1	C	337	LYS	3.1
1	A	313	SER	3.1
1	C	398	SER	3.0
1	B	533	LEU	3.0
1	B	536	ALA	3.0
1	D	441	GLU	3.0
1	A	417	SER	3.0
1	D	458	THR	3.0
1	D	545	THR	3.0
1	D	738	ASN	3.0
1	C	265	PRO	3.0
1	B	325	ALA	3.0
1	D	290	PRO	3.0
1	B	356	VAL	3.0
1	A	419	ARG	3.0
1	D	284	LEU	3.0
1	C	447	PHE	3.0
1	B	408	ALA	3.0
1	C	438	ALA	3.0
1	D	305	LEU	2.9
1	A	4	PRO	2.9

*Continued on next page...*



*Continued from previous page...*

<b>Mol</b>	<b>Chain</b>	<b>Res</b>	<b>Type</b>	<b>RSRZ</b>
1	D	354	LEU	2.9
1	A	235	ASN	2.9
1	B	232	SER	2.9
1	D	383	ARG	2.9
1	B	487	TYR	2.9
1	B	547	SER	2.9
1	C	125	ASP	2.9
1	A	309	PRO	2.9
1	D	431	SER	2.8
1	B	383	ARG	2.8
1	C	363	GLU	2.8
1	A	366	TYR	2.8
1	D	376	TYR	2.8
1	D	295	LEU	2.8
1	A	625	LEU	2.8
1	D	624	ALA	2.8
1	A	361	TRP	2.8
1	B	461	PHE	2.8
1	D	734	MET	2.8
1	B	333	GLU	2.8
1	C	8	ILE	2.7
1	D	377	PHE	2.7
1	D	125	ASP	2.7
1	D	445	ASP	2.7
1	B	350	GLN	2.7
1	B	752	SER	2.7
1	D	446	ASP	2.7
1	A	441	GLU	2.7
1	B	321	LYS	2.7
1	D	800	LYS	2.7
1	C	13	GLN	2.7
1	B	290	PRO	2.7
1	C	441	GLU	2.7
1	D	160	GLU	2.7
1	B	247	PRO	2.7
1	A	398	SER	2.7
1	D	750	THR	2.7
1	D	248	VAL	2.6
1	C	434	LYS	2.6
1	D	121	ASN	2.6
1	D	283	ILE	2.6
1	C	14	THR	2.6

*Continued on next page...*

*Continued from previous page...*

<b>Mol</b>	<b>Chain</b>	<b>Res</b>	<b>Type</b>	<b>RSRZ</b>
1	A	738	ASN	2.6
1	D	285	TYR	2.6
1	A	249	ILE	2.6
1	D	128	THR	2.6
1	D	303	THR	2.6
1	B	329	GLY	2.6
1	A	487	TYR	2.6
1	D	153	TYR	2.6
1	B	428	LYS	2.6
1	D	127	SER	2.6
1	D	199	VAL	2.5
1	D	126	SER	2.5
1	D	400	ASP	2.5
1	B	404	SER	2.5
1	D	288	ALA	2.5
1	D	4	PRO	2.5
1	A	537	ILE	2.5
1	B	801	ILE	2.5
1	C	266	GLN	2.5
1	D	292	THR	2.5
1	C	417	SER	2.5
1	D	112	PHE	2.5
1	A	445	ASP	2.5
1	D	314	ASP	2.5
1	D	408	ALA	2.5
1	D	535	SER	2.4
1	A	239	LYS	2.4
1	B	237	GLY	2.4
1	D	574	ILE	2.4
1	C	339	PHE	2.4
1	A	263	HIS	2.4
1	A	432	ASP	2.4
1	D	749	VAL	2.4
1	B	167	ASN	2.4
1	D	96	ASP	2.4
1	C	313	SER	2.4
1	B	238	GLY	2.4
1	B	626	VAL	2.4
1	D	534	ASP	2.4
1	C	318	ALA	2.4
1	C	316	THR	2.4
1	D	232	SER	2.4

*Continued on next page...*

*Continued from previous page...*

<b>Mol</b>	<b>Chain</b>	<b>Res</b>	<b>Type</b>	<b>RSRZ</b>
1	B	478	ASP	2.4
1	D	477	LEU	2.4
1	D	737	PRO	2.4
1	D	353	LYS	2.4
1	D	381	ILE	2.4
1	C	366	TYR	2.4
1	D	247	PRO	2.3
1	B	291	ALA	2.3
1	C	450	MET	2.3
1	D	409	LEU	2.3
1	B	385	SER	2.3
1	D	429	GLY	2.3
1	C	430	ALA	2.3
1	B	572	ILE	2.3
1	C	309	PRO	2.3
1	A	538	LYS	2.3
1	D	404	SER	2.3
1	B	484	ILE	2.3
1	A	541	LYS	2.2
1	D	425	PHE	2.2
1	C	362	VAL	2.2
1	D	202	ASP	2.2
1	B	83	LEU	2.2
1	A	555	ARG	2.2
1	D	225	ARG	2.2
1	B	125	ASP	2.2
1	D	154	GLY	2.2
1	D	678	VAL	2.2
1	A	363	GLU	2.2
1	A	442	LYS	2.2
1	A	450	MET	2.2
1	D	281	MET	2.2
1	A	234	PRO	2.2
1	B	352	SER	2.2
1	C	403	VAL	2.2
1	A	314	ASP	2.2
1	B	236	PRO	2.2
1	B	358	ASP	2.2
1	D	355	SER	2.2
1	D	277	LEU	2.2
1	D	491	ASN	2.2
1	D	64	GLY	2.2

*Continued on next page...*

*Continued from previous page...*

Mol	Chain	Res	Type	RSRZ
1	D	412	GLN	2.1
1	D	555	ARG	2.2
1	C	452	VAL	2.1
1	D	628	CYS	2.1
1	A	572	ILE	2.1
1	A	368	LYS	2.1
1	D	579	ALA	2.1
1	A	403	VAL	2.1
1	C	314	ASP	2.1
1	C	233	LEU	2.1
1	D	272	LEU	2.1
1	B	293	HIS	2.1
1	A	233	LEU	2.1
1	D	541	LYS	2.1
1	A	12	SER	2.0
1	B	121	ASN	2.0
1	B	347	ASN	2.0
1	B	538	LYS	2.0
1	B	737	PRO	2.0
1	B	316	THR	2.0
1	A	457	ASN	2.0
1	A	540	SER	2.0
1	A	311	ILE	2.0
1	C	249	ILE	2.0
1	D	301	GLY	2.0

## 6.2 Non-standard residues in protein, DNA, RNA chains [i](#)

There are no non-standard protein/DNA/RNA residues in this entry.

## 6.3 Carbohydrates [i](#)

There are no monosaccharides in this entry.

## 6.4 Ligands [i](#)

In the following table, the Atoms column lists the number of modelled atoms in the group and the number defined in the chemical component dictionary. The B-factors column lists the minimum, median, 95<sup>th</sup> percentile and maximum values of B factors of atoms in the group. The column labelled 'Q < 0.9' lists the number of atoms with occupancy less than 0.9.

Mol	Type	Chain	Res	Atoms	RSCC	RSR	B-factors( $\text{\AA}^2$ )	Q<0.9
2	SAM	B	901	27/27	0.87	0.20	44,59,83,92	0
2	SAM	A	901	27/27	0.88	0.25	31,43,80,84	0
2	SAM	A	902	27/27	0.89	0.22	36,50,54,57	0
2	SAM	C	902	27/27	0.90	0.15	39,49,55,57	0
3	EDO	B	902	4/4	0.90	0.25	20,27,32,38	0
4	FLC	B	905	13/13	0.90	0.13	26,30,35,45	0
3	EDO	B	903	4/4	0.91	0.16	33,38,39,44	0
3	EDO	A	903	4/4	0.91	0.11	24,25,26,27	0
3	EDO	D	901	4/4	0.92	0.21	25,25,26,29	0
2	SAM	C	901	27/27	0.92	0.13	28,34,62,69	0
4	FLC	D	903	13/13	0.92	0.10	25,32,36,36	0
3	EDO	A	904	4/4	0.93	0.14	24,26,28,34	0
3	EDO	B	904	4/4	0.94	0.14	18,19,20,30	0
4	FLC	A	906	13/13	0.94	0.10	22,24,35,41	0
3	EDO	D	902	4/4	0.96	0.14	26,30,36,38	0
3	EDO	A	905	4/4	0.96	0.11	25,26,27,32	0
3	EDO	C	903	4/4	0.97	0.10	19,23,25,27	0

The following is a graphical depiction of the model fit to experimental electron density of all instances of the Ligand of Interest. In addition, ligands with molecular weight > 250 and outliers as shown on the geometry validation Tables will also be included. Each fit is shown from different orientation to approximate a three-dimensional view.

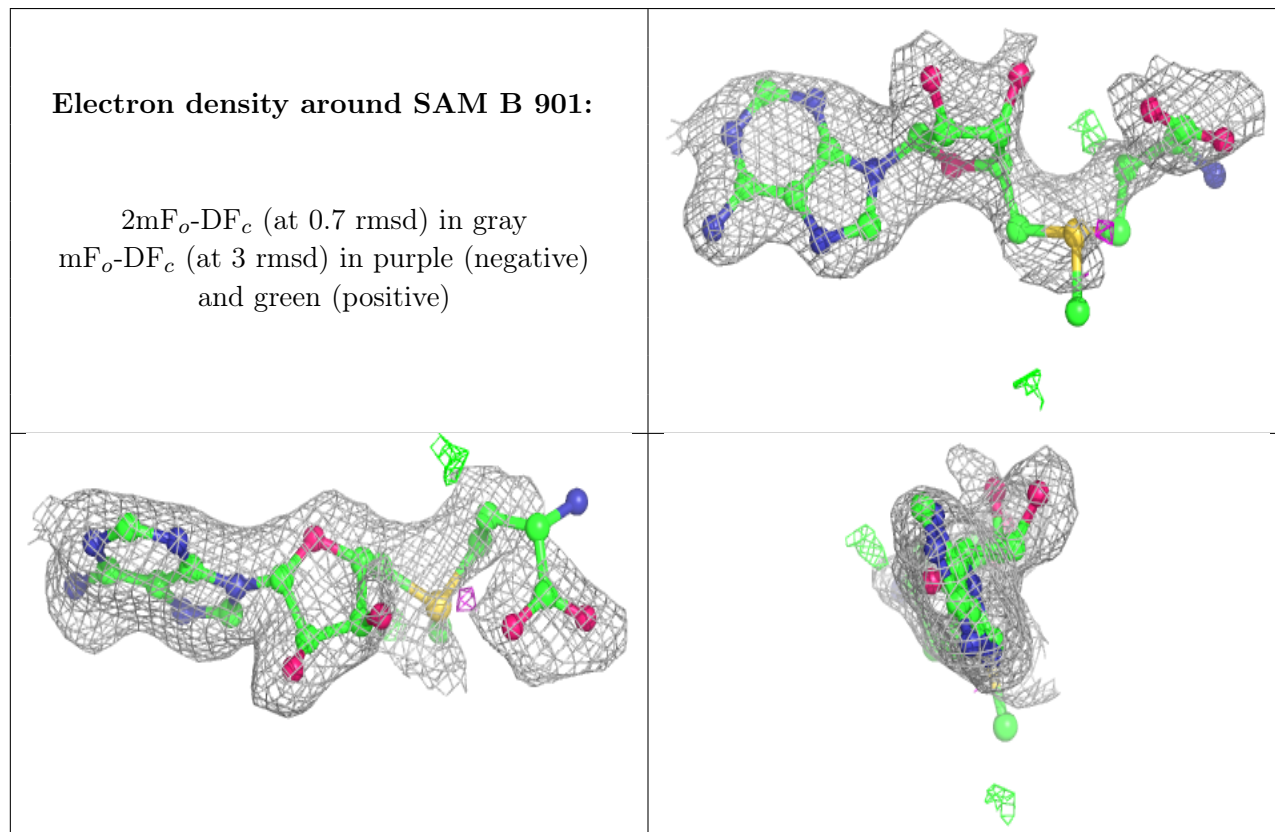

**Electron density around SAM A 901:**

$2mF_o-DF_c$  (at 0.7 rmsd) in gray  
 $mF_o-DF_c$  (at 3 rmsd) in purple (negative)  
and green (positive)

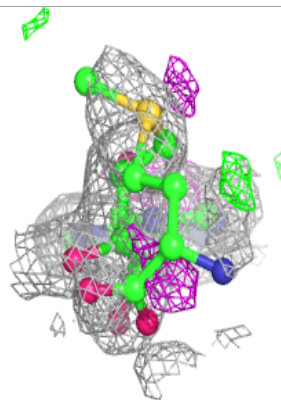
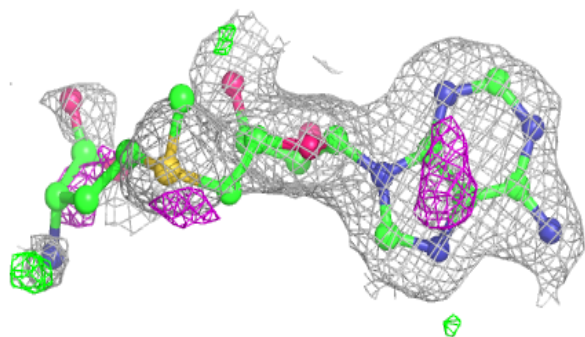
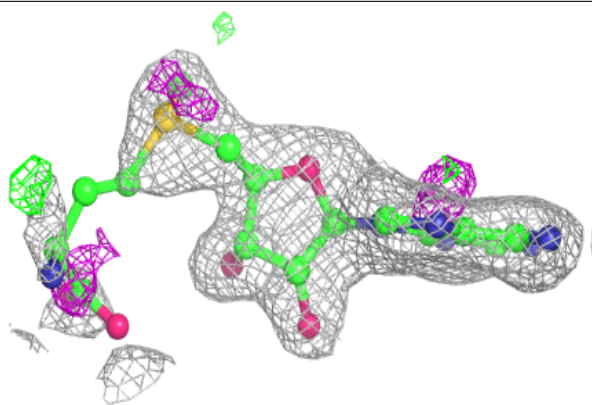
**Electron density around SAM A 902:**

$2mF_o-DF_c$  (at 0.7 rmsd) in gray  
 $mF_o-DF_c$  (at 3 rmsd) in purple (negative)  
and green (positive)

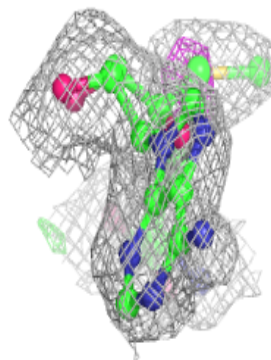
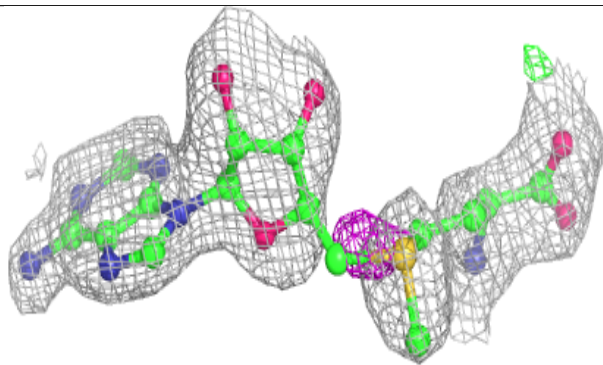
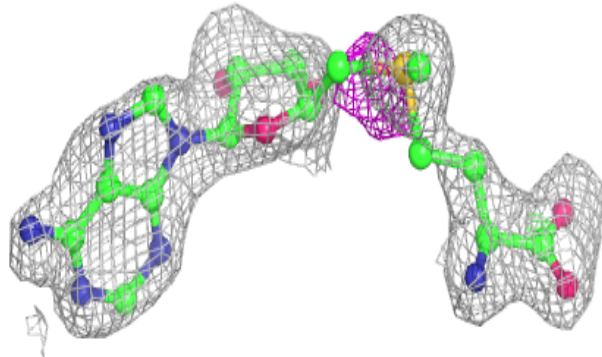



**Electron density around SAM C 902:**

$2mF_o-DF_c$  (at 0.7 rmsd) in gray  
 $mF_o-DF_c$  (at 3 rmsd) in purple (negative)  
and green (positive)

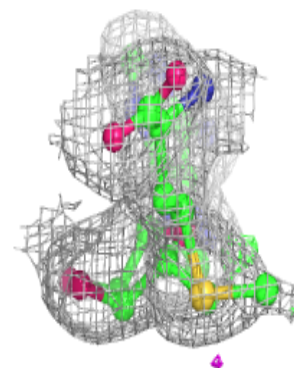
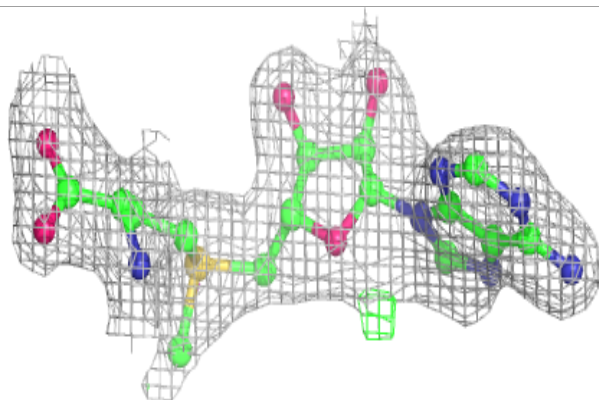
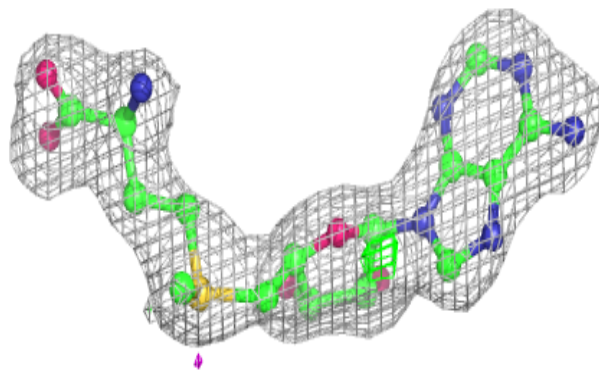
**Electron density around SAM C 901:**

$2mF_o-DF_c$  (at 0.7 rmsd) in gray  
 $mF_o-DF_c$  (at 3 rmsd) in purple (negative)  
and green (positive)

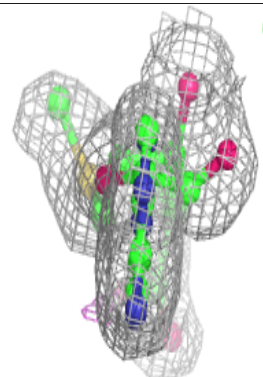
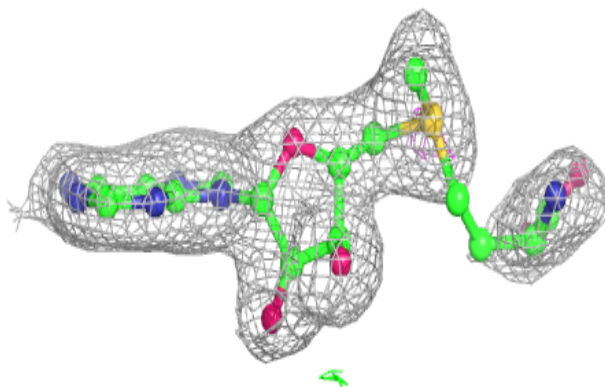
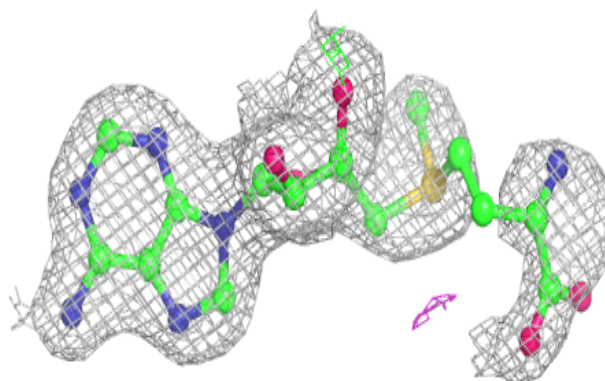

## 6.5 Other polymers [i](#)

There are no such residues in this entry.