



wwPDB X-ray Structure Validation Summary Report

Nov 16, 2020 – 02:52 PM EST

PDB ID : 6WXP
Title : De novo TIM barrel-ferredoxin fold fusion homodimer with 4-glutamate centre TFD-EE
Authors : Caldwell, S.J.; Zeymer, C.; Haydon, I.C.; Huang, P.; Hilvert, D.; Baker, D.
Deposited on : 2020-05-11
Resolution : 2.50 Å (reported)

This is a wwPDB X-ray Structure Validation Summary Report for a publicly released PDB entry.

We welcome your comments at validation@mail.wwpdb.org

A user guide is available at

<https://www.wwpdb.org/validation/2017/XrayValidationReportHelp>

with specific help available everywhere you see the  symbol.

The following versions of software and data (see [references](#) ) were used in the production of this report:

MolProbity : 4.02b-467
Mogul : 1.8.5 (274361), CSD as541be (2020)
Xtrriage (Phenix) : 1.13
EDS : 2.14.6
buster-report : 1.1.7 (2018)
Percentile statistics : 20191225.v01 (using entries in the PDB archive December 25th 2019)
Refmac : 5.8.0158
CCP4 : 7.0.044 (Gargrove)
Ideal geometry (proteins) : Engh & Huber (2001)
Ideal geometry (DNA, RNA) : Parkinson et al. (1996)
Validation Pipeline (wwPDB-VP) : 2.14.6

1 Overall quality at a glance

The following experimental techniques were used to determine the structure:

X-RAY DIFFRACTION

The reported resolution of this entry is 2.50 Å.

Percentile scores (ranging between 0-100) for global validation metrics of the entry are shown in the following graphic. The table shows the number of entries on which the scores are based.

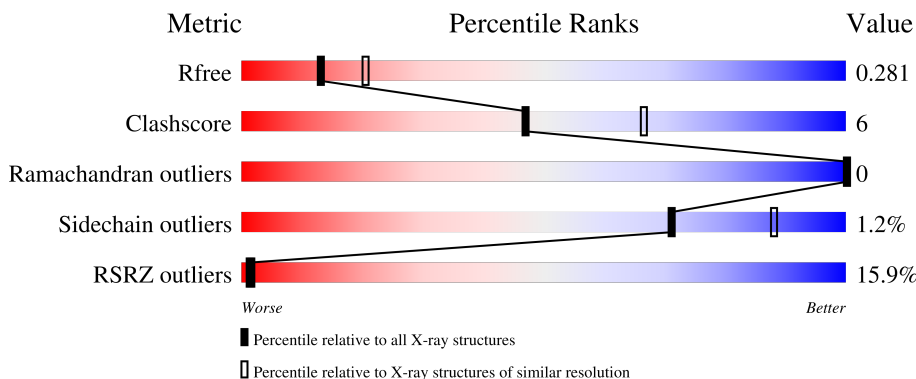

Metric	Whole archive (#Entries)	Similar resolution (#Entries, resolution range(Å))
R_{free}	130704	4661 (2.50-2.50)
Clashscore	141614	5346 (2.50-2.50)
Ramachandran outliers	138981	5231 (2.50-2.50)
Sidechain outliers	138945	5233 (2.50-2.50)
RSRZ outliers	127900	4559 (2.50-2.50)

The table below summarises the geometric issues observed across the polymeric chains and their fit to the electron density. The red, orange, yellow and green segments on the lower bar indicate the fraction of residues that contain outliers for ≥ 3 , 2, 1 and 0 types of geometric quality criteria respectively. A grey segment represents the fraction of residues that are not modelled. The numeric value for each fraction is indicated below the corresponding segment, with a dot representing fractions $\leq 5\%$. The upper red bar (where present) indicates the fraction of residues that have poor fit to the electron density. The numeric value is given above the bar.

Mol	Chain	Length	Quality of chain
1	A	172	
1	B	172	
1	C	172	
1	D	172	
1	E	172	

Continued on next page...

Continued from previous page...

Mol	Chain	Length	Quality of chain
1	F	172	 <p>A horizontal bar chart representing the quality of chain. The bar is divided into four segments: a red segment (34%), a green segment (65%), a yellow segment (19%), and a grey segment (16%). The percentages are labeled above or below the corresponding segments.</p>

2 Entry composition [i](#)

There are 4 unique types of molecules in this entry. The entry contains 7308 atoms, of which 0 are hydrogens and 0 are deuteriums.

In the tables below, the ZeroOcc column contains the number of atoms modelled with zero occupancy, the AltConf column contains the number of residues with at least one atom in alternate conformation and the Trace column contains the number of residues modelled with at most 2 atoms.

- Molecule 1 is a protein called TFD-EE.

Mol	Chain	Residues	Atoms					ZeroOcc	AltConf	Trace
			Total	C	N	O	S			
1	A	167	1286	808	225	248	5	0	0	0
1	B	165	1270	797	223	246	4	0	0	0
1	C	154	1183	745	207	226	5	0	0	0
1	D	160	1247	786	218	239	4	0	0	0
1	E	141	1097	697	186	211	3	0	0	0
1	F	144	1117	705	193	215	4	0	0	0

- Molecule 2 is CALCIUM ION (three-letter code: CA) (formula: Ca) (labeled as "Ligand of Interest" by author).

Mol	Chain	Residues	Atoms		ZeroOcc	AltConf
2	A	1	Total 1	Ca 1	0	0
2	D	1	Total 1	Ca 1	0	0
2	E	1	Total 1	Ca 1	0	0

- Molecule 3 is 1,2-ETHANEDIOL (three-letter code: EDO) (formula: C₂H₆O₂).



Mol	Chain	Residues	Atoms	ZeroOcc	AltConf
3	A	1	Total C O 4 2 2	0	0
3	A	1	Total C O 4 2 2	0	0
3	A	1	Total C O 4 2 2	0	0
3	A	1	Total C O 4 2 2	0	0
3	A	1	Total C O 4 2 2	0	0
3	B	1	Total C O 4 2 2	0	0
3	B	1	Total C O 4 2 2	0	0
3	B	1	Total C O 4 2 2	0	0
3	B	1	Total C O 4 2 2	0	0
3	B	1	Total C O 4 2 2	0	0
3	C	1	Total C O 4 2 2	0	0
3	D	1	Total C O 4 2 2	0	0

- Molecule 4 is water.

Mol	Chain	Residues	Atoms		ZeroOcc	AltConf
4	A	25	Total 25	O 25	0	0
4	B	17	Total 17	O 17	0	0
4	C	8	Total 8	O 8	0	0
4	D	7	Total 7	O 7	0	0

3 Residue-property plots [i](#)

These plots are drawn for all protein, RNA, DNA and oligosaccharide chains in the entry. The first graphic for a chain summarises the proportions of the various outlier classes displayed in the second graphic. The second graphic shows the sequence view annotated by issues in geometry and electron density. Residues are color-coded according to the number of geometric quality criteria for which they contain at least one outlier: green = 0, yellow = 1, orange = 2 and red = 3 or more. A red dot above a residue indicates a poor fit to the electron density ($RSRZ > 2$). Stretches of 2 or more consecutive residues without any outlier are shown as a green connector. Residues present in the sample, but not in the model, are shown in grey.

- Molecule 1: TFD-EE

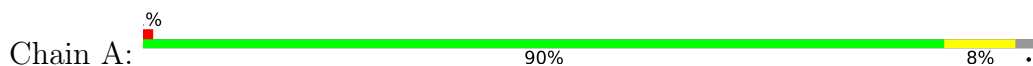

- Molecule 1: TFD-EE

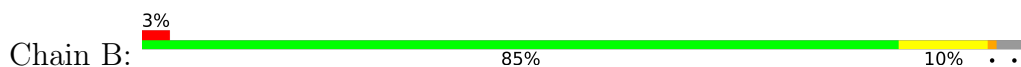

- Molecule 1: TFD-EE

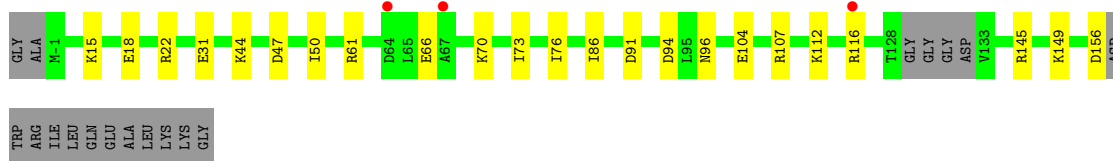
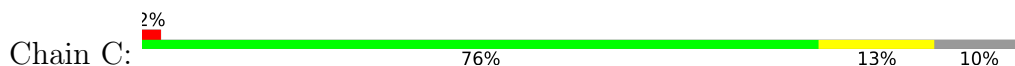

- Molecule 1: TFD-EE

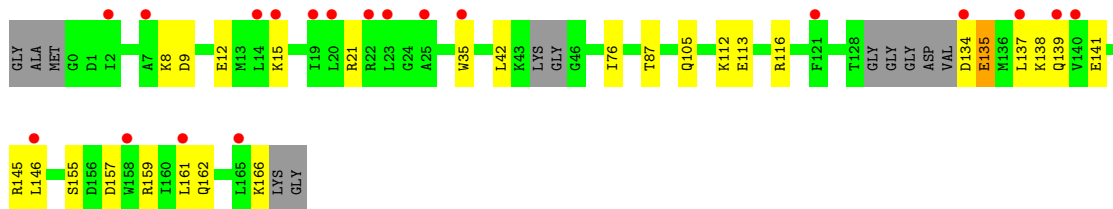
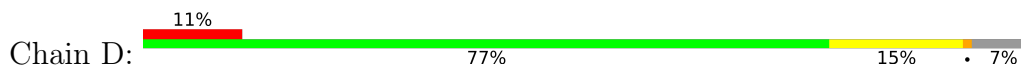

- Molecule 1: TFD-EE



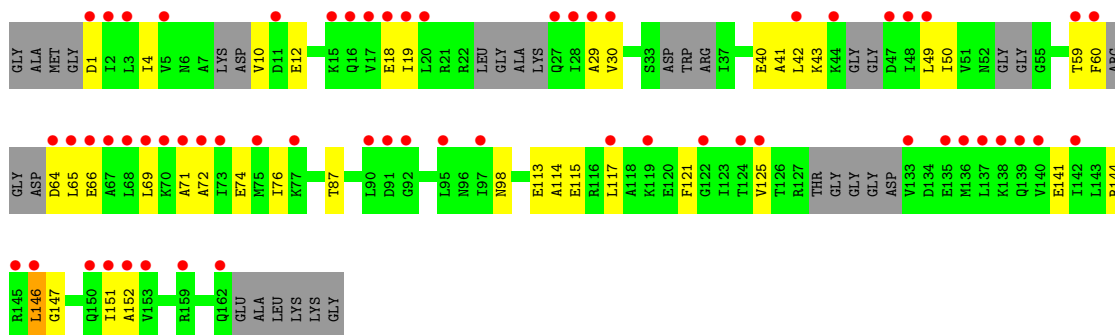

- Molecule 1: TFD-EE

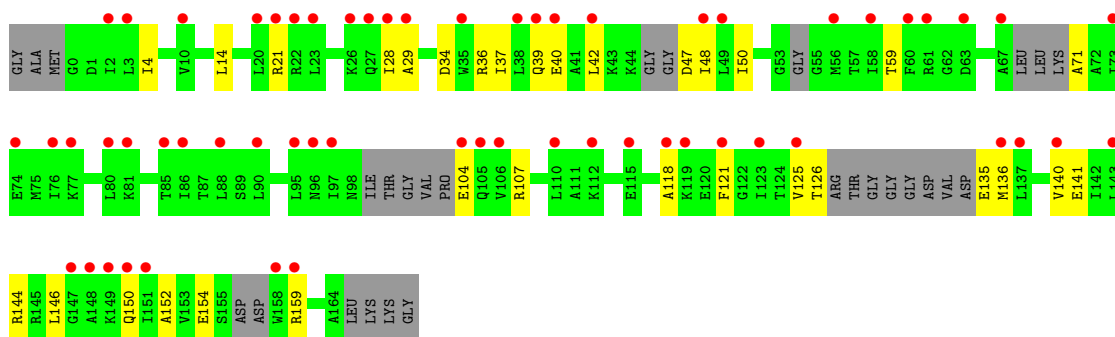

4 Data and refinement statistics

Property	Value	Source
Space group	P 1 21 1	Depositor
Cell constants a, b, c, α , β , γ	43.91Å 101.16Å 117.73Å 90.00° 95.50° 90.00°	Depositor
Resolution (Å)	46.44 – 2.50 46.44 – 2.50	Depositor EDS
% Data completeness (in resolution range)	97.9 (46.44-2.50) 97.9 (46.44-2.50)	Depositor EDS
R_{merge}	0.05	Depositor
R_{sym}	(Not available)	Depositor
$\langle I/\sigma(I) \rangle$ ¹	2.04 (at 2.51Å)	Xtrriage
Refinement program	PHENIX 1.18rc2_3793	Depositor
R, R_{free}	0.227 , 0.281 0.228 , 0.281	Depositor DCC
R_{free} test set	1739 reflections (5.00%)	wwPDB-VP
Wilson B-factor (Å ²)	56.3	Xtrriage
Anisotropy	0.159	Xtrriage
Bulk solvent k_{sol} (e/Å ³), B_{sol} (Å ²)	0.36 , 66.6	EDS
L-test for twinning ²	$\langle L \rangle = 0.50$, $\langle L^2 \rangle = 0.34$	Xtrriage
Estimated twinning fraction	No twinning to report.	Xtrriage
F_o, F_c correlation	0.93	EDS
Total number of atoms	7308	wwPDB-VP
Average B, all atoms (Å ²)	85.0	wwPDB-VP

Xtrriage's analysis on translational NCS is as follows: *The largest off-origin peak in the Patterson function is 6.74% of the height of the origin peak. No significant pseudotranslation is detected.*

¹Intensities estimated from amplitudes.

²Theoretical values of $\langle |L| \rangle$, $\langle L^2 \rangle$ for acentric reflections are 0.5, 0.333 respectively for untwinned datasets, and 0.375, 0.2 for perfectly twinned datasets.

5 Model quality [i](#)

5.1 Standard geometry [i](#)

Bond lengths and bond angles in the following residue types are not validated in this section: CA, EDO

The Z score for a bond length (or angle) is the number of standard deviations the observed value is removed from the expected value. A bond length (or angle) with $|Z| > 5$ is considered an outlier worth inspection. RMSZ is the root-mean-square of all Z scores of the bond lengths (or angles).

Mol	Chain	Bond lengths		Bond angles	
		RMSZ	# Z >5	RMSZ	# Z >5
1	A	0.24	0/1293	0.43	0/1735
1	B	0.24	0/1277	0.44	0/1714
1	C	0.24	0/1187	0.42	0/1590
1	D	0.24	0/1252	0.42	0/1678
1	E	0.23	0/1095	0.41	0/1465
1	F	0.24	0/1117	0.43	0/1492
All	All	0.24	0/7221	0.43	0/9674

There are no bond length outliers.

There are no bond angle outliers.

There are no chirality outliers.

There are no planarity outliers.

5.2 Too-close contacts [i](#)

In the following table, the Non-H and H(model) columns list the number of non-hydrogen atoms and hydrogen atoms in the chain respectively. The H(added) column lists the number of hydrogen atoms added and optimized by MolProbity. The Clashes column lists the number of clashes within the asymmetric unit, whereas Symm-Clashes lists symmetry related clashes.

Mol	Chain	Non-H	H(model)	H(added)	Clashes	Symm-Clashes
1	A	1286	0	1352	8	0
1	B	1270	0	1329	13	0
1	C	1183	0	1257	15	0
1	D	1247	0	1316	19	0
1	E	1097	0	1154	23	0
1	F	1117	0	1158	21	0
2	A	1	0	0	0	0

Continued on next page...

Continued from previous page...

Mol	Chain	Non-H	H(model)	H(added)	Clashes	Symm-Clashes
2	D	1	0	0	0	0
2	E	1	0	0	0	0
3	A	20	0	30	1	0
3	B	20	0	30	0	0
3	C	4	0	6	0	0
3	D	4	0	6	0	0
4	A	25	0	0	0	0
4	B	17	0	0	0	0
4	C	8	0	0	1	0
4	D	7	0	0	2	0
All	All	7308	0	7638	92	0

The all-atom clashscore is defined as the number of clashes found per 1000 atoms (including hydrogen atoms). The all-atom clashscore for this structure is 6.

The worst 5 of 92 close contacts within the same asymmetric unit are listed below, sorted by their clash magnitude.

Atom-1	Atom-2	Interatomic distance (Å)	Clash overlap (Å)
1:C:18:GLU:HB2	1:C:44:LYS:HE2	1.75	0.69
1:E:74:GLU:HB3	1:E:117:LEU:HD21	1.75	0.69
1:D:113:GLU:OE1	1:D:116:ARG:NH1	2.27	0.68
1:F:159:ARG:O	1:F:159:ARG:NH1	2.29	0.66
1:E:50:ILE:HG12	1:E:152:ALA:HB3	1.77	0.64

There are no symmetry-related clashes.

5.3 Torsion angles [i](#)

5.3.1 Protein backbone [i](#)

In the following table, the Percentiles column shows the percent Ramachandran outliers of the chain as a percentile score with respect to all X-ray entries followed by that with respect to entries of similar resolution.

The Analysed column shows the number of residues for which the backbone conformation was analysed, and the total number of residues.

Mol	Chain	Analysed	Favoured	Allowed	Outliers	Percentiles	
1	A	165/172 (96%)	162 (98%)	3 (2%)	0	100	100
1	B	163/172 (95%)	161 (99%)	2 (1%)	0	100	100

Continued on next page...

Continued from previous page...

Mol	Chain	Analysed	Favoured	Allowed	Outliers	Percentiles	
1	C	150/172 (87%)	148 (99%)	2 (1%)	0	100	100
1	D	154/172 (90%)	151 (98%)	3 (2%)	0	100	100
1	E	125/172 (73%)	116 (93%)	9 (7%)	0	100	100
1	F	130/172 (76%)	123 (95%)	7 (5%)	0	100	100
All	All	887/1032 (86%)	861 (97%)	26 (3%)	0	100	100

There are no Ramachandran outliers to report.

5.3.2 Protein sidechains [i](#)

In the following table, the Percentiles column shows the percent sidechain outliers of the chain as a percentile score with respect to all X-ray entries followed by that with respect to entries of similar resolution.

The Analysed column shows the number of residues for which the sidechain conformation was analysed, and the total number of residues.

Mol	Chain	Analysed	Rotameric	Outliers	Percentiles	
1	A	136/138 (99%)	135 (99%)	1 (1%)	84	94
1	B	134/138 (97%)	132 (98%)	2 (2%)	65	85
1	C	126/138 (91%)	125 (99%)	1 (1%)	81	93
1	D	133/138 (96%)	130 (98%)	3 (2%)	50	76
1	E	119/138 (86%)	117 (98%)	2 (2%)	60	82
1	F	117/138 (85%)	117 (100%)	0	100	100
All	All	765/828 (92%)	756 (99%)	9 (1%)	71	88

5 of 9 residues with a non-rotameric sidechain are listed below:

Mol	Chain	Res	Type
1	D	105	GLN
1	E	146	LEU
1	D	139	GLN
1	B	126	THR
1	D	135	GLU

Some sidechains can be flipped to improve hydrogen bonding and reduce clashes. There are no such sidechains identified.

5.3.3 RNA [i](#)

There are no RNA molecules in this entry.

5.4 Non-standard residues in protein, DNA, RNA chains [i](#)

There are no non-standard protein/DNA/RNA residues in this entry.

5.5 Carbohydrates [i](#)

There are no monosaccharides in this entry.

5.6 Ligand geometry [i](#)

Of 15 ligands modelled in this entry, 3 are monoatomic - leaving 12 for Mogul analysis.

In the following table, the Counts columns list the number of bonds (or angles) for which Mogul statistics could be retrieved, the number of bonds (or angles) that are observed in the model and the number of bonds (or angles) that are defined in the Chemical Component Dictionary. The Link column lists molecule types, if any, to which the group is linked. The Z score for a bond length (or angle) is the number of standard deviations the observed value is removed from the expected value. A bond length (or angle) with $|Z| > 2$ is considered an outlier worth inspection. RMSZ is the root-mean-square of all Z scores of the bond lengths (or angles).

Mol	Type	Chain	Res	Link	Bond lengths			Bond angles		
					Counts	RMSZ	$\# Z > 2$	Counts	RMSZ	$\# Z > 2$
3	EDO	B	201	-	3,3,3	0.45	0	2,2,2	0.33	0
3	EDO	B	204	-	3,3,3	0.45	0	2,2,2	0.36	0
3	EDO	A	204	-	3,3,3	0.43	0	2,2,2	0.47	0
3	EDO	B	205	-	3,3,3	0.46	0	2,2,2	0.34	0
3	EDO	A	203	-	3,3,3	0.47	0	2,2,2	0.29	0
3	EDO	A	202	-	3,3,3	0.42	0	2,2,2	0.47	0
3	EDO	B	202	-	3,3,3	0.44	0	2,2,2	0.36	0
3	EDO	A	206	-	3,3,3	0.44	0	2,2,2	0.43	0
3	EDO	D	202	-	3,3,3	0.46	0	2,2,2	0.35	0
3	EDO	C	201	-	3,3,3	0.47	0	2,2,2	0.30	0
3	EDO	B	203	-	3,3,3	0.45	0	2,2,2	0.27	0
3	EDO	A	205	-	3,3,3	0.46	0	2,2,2	0.34	0

In the following table, the Chirals column lists the number of chiral outliers, the number of chiral centers analysed, the number of these observed in the model and the number defined in the Chemical Component Dictionary. Similar counts are reported in the Torsion and Rings columns. '-' means no outliers of that kind were identified.

Mol	Type	Chain	Res	Link	Chirals	Torsions	Rings
3	EDO	B	201	-	-	0/1/1/1	-
3	EDO	B	204	-	-	0/1/1/1	-
3	EDO	A	204	-	-	0/1/1/1	-
3	EDO	B	205	-	-	0/1/1/1	-
3	EDO	A	203	-	-	0/1/1/1	-
3	EDO	A	202	-	-	0/1/1/1	-
3	EDO	B	202	-	-	0/1/1/1	-
3	EDO	A	206	-	-	0/1/1/1	-
3	EDO	D	202	-	-	0/1/1/1	-
3	EDO	C	201	-	-	0/1/1/1	-
3	EDO	B	203	-	-	0/1/1/1	-
3	EDO	A	205	-	-	0/1/1/1	-

There are no bond length outliers.

There are no bond angle outliers.

There are no chirality outliers.

There are no torsion outliers.

There are no ring outliers.

1 monomer is involved in 1 short contact:

Mol	Chain	Res	Type	Clashes	Symm-Clashes
3	A	206	EDO	1	0

5.7 Other polymers [i](#)

There are no such residues in this entry.

5.8 Polymer linkage issues [i](#)

There are no chain breaks in this entry.

6 Fit of model and data [i](#)

6.1 Protein, DNA and RNA chains [i](#)

In the following table, the column labelled ‘#RSRZ> 2’ contains the number (and percentage) of RSRZ outliers, followed by percent RSRZ outliers for the chain as percentile scores relative to all X-ray entries and entries of similar resolution. The OWAB column contains the minimum, median, 95th percentile and maximum values of the occupancy-weighted average B-factor per residue. The column labelled ‘Q< 0.9’ lists the number of (and percentage) of residues with an average occupancy less than 0.9.

Mol	Chain	Analysed	<RSRZ>	#RSRZ>2	OWAB(Å ²)	Q<0.9
1	A	167/172 (97%)	0.32	2 (1%) 79 80	38, 57, 88, 113	0
1	B	165/172 (95%)	0.41	5 (3%) 50 53	36, 60, 99, 114	0
1	C	154/172 (89%)	0.35	3 (1%) 66 69	44, 66, 99, 124	0
1	D	160/172 (93%)	0.70	19 (11%) 4 4	45, 75, 117, 182	0
1	E	141/172 (81%)	1.97	60 (42%) 0 0	76, 122, 159, 200	0
1	F	144/172 (83%)	1.93	59 (40%) 0 0	86, 121, 149, 229	0
All	All	931/1032 (90%)	0.91	148 (15%) 1 1	36, 80, 144, 229	0

The worst 5 of 148 RSRZ outliers are listed below:

Mol	Chain	Res	Type	RSRZ
1	F	147	GLY	14.1
1	E	48	ILE	11.5
1	F	67	ALA	10.5
1	E	151	ILE	7.7
1	D	139	GLN	7.4

6.2 Non-standard residues in protein, DNA, RNA chains [i](#)

There are no non-standard protein/DNA/RNA residues in this entry.

6.3 Carbohydrates [i](#)

There are no monosaccharides in this entry.

6.4 Ligands

In the following table, the Atoms column lists the number of modelled atoms in the group and the number defined in the chemical component dictionary. The B-factors column lists the minimum, median, 95th percentile and maximum values of B factors of atoms in the group. The column labelled 'Q< 0.9' lists the number of atoms with occupancy less than 0.9.

Mol	Type	Chain	Res	Atoms	RSCC	RSR	B-factors(Å ²)	Q<0.9
2	CA	E	201	1/1	0.58	0.15	123,123,123,123	0
3	EDO	D	202	4/4	0.71	0.33	66,67,81,89	0
2	CA	A	201	1/1	0.72	0.12	75,75,75,75	0
3	EDO	A	205	4/4	0.72	0.34	67,72,86,101	0
2	CA	D	201	1/1	0.77	0.06	89,89,89,89	0
3	EDO	B	204	4/4	0.86	0.36	73,76,81,88	0
3	EDO	C	201	4/4	0.91	0.24	66,72,74,89	0
3	EDO	A	206	4/4	0.92	0.22	60,63,63,63	0
3	EDO	B	201	4/4	0.92	0.24	43,44,45,50	0
3	EDO	B	205	4/4	0.93	0.17	58,71,71,77	0
3	EDO	B	203	4/4	0.94	0.24	45,46,47,50	0
3	EDO	B	202	4/4	0.94	0.23	45,50,51,51	0
3	EDO	A	202	4/4	0.95	0.27	50,58,58,61	0
3	EDO	A	204	4/4	0.97	0.20	38,39,42,50	0
3	EDO	A	203	4/4	0.97	0.16	45,51,51,52	0

The following is a graphical depiction of the model fit to experimental electron density of all instances of the Ligand of Interest. In addition, ligands with molecular weight > 250 and outliers as shown on the geometry validation Tables will also be included. Each fit is shown from different orientation to approximate a three-dimensional view.

Electron density around CA E 201:

$2mF_o-DF_c$ (at 0.7 rmsd) in gray
 mF_o-DF_c (at 3 rmsd) in purple (negative)
and green (positive)

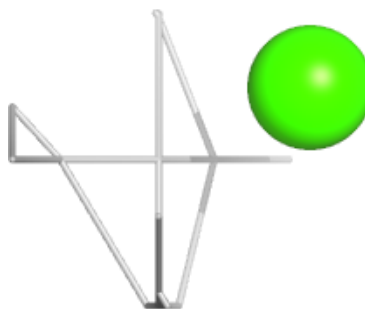
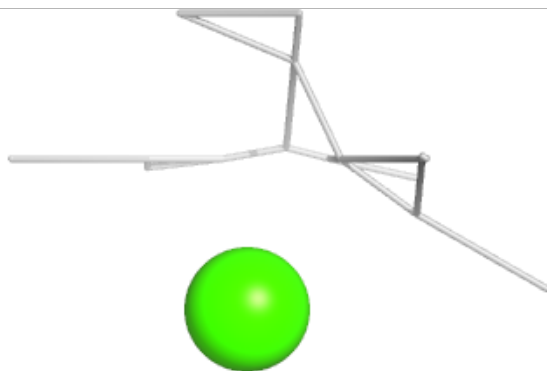
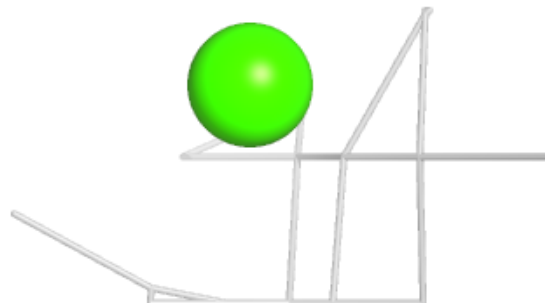

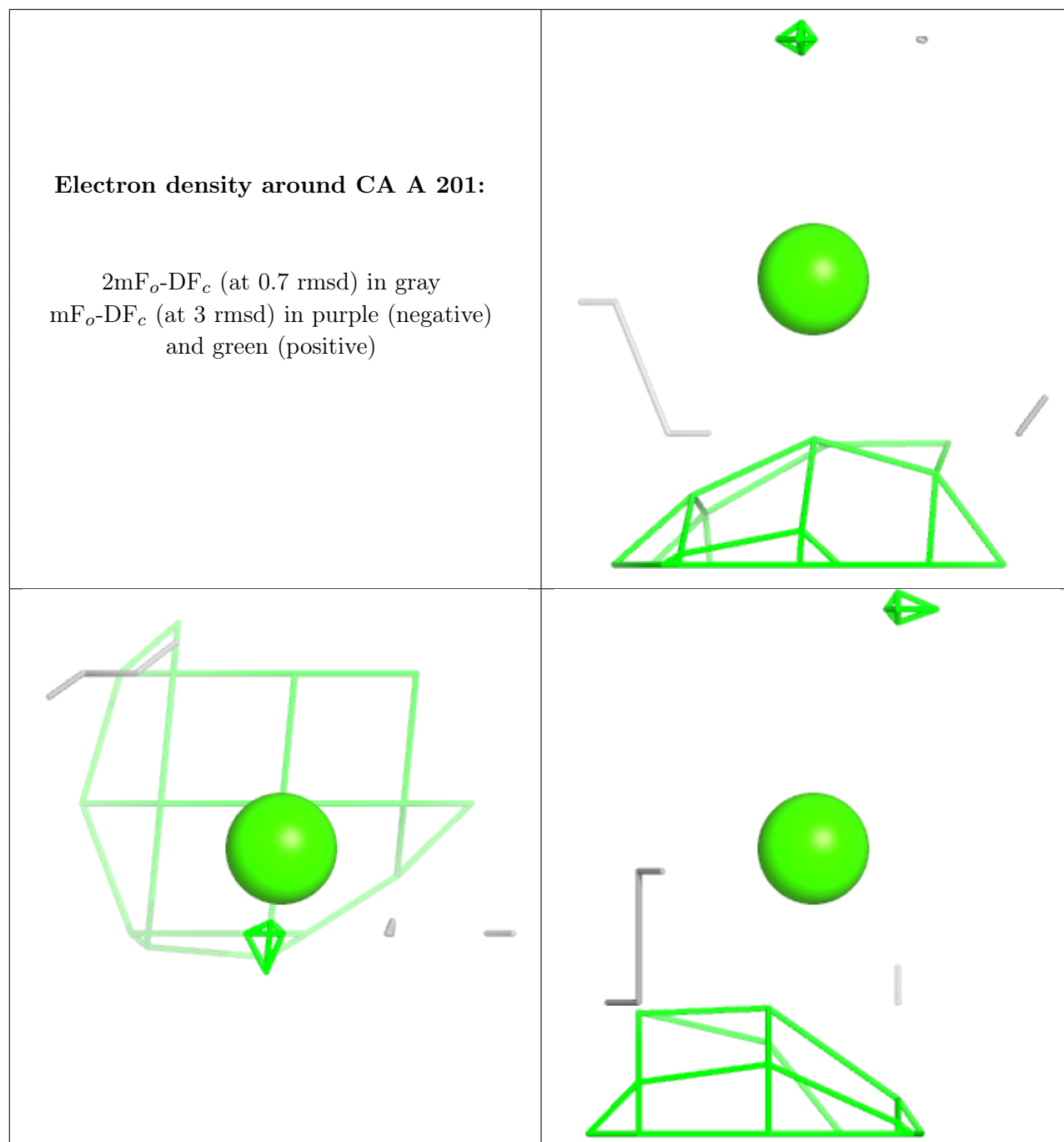

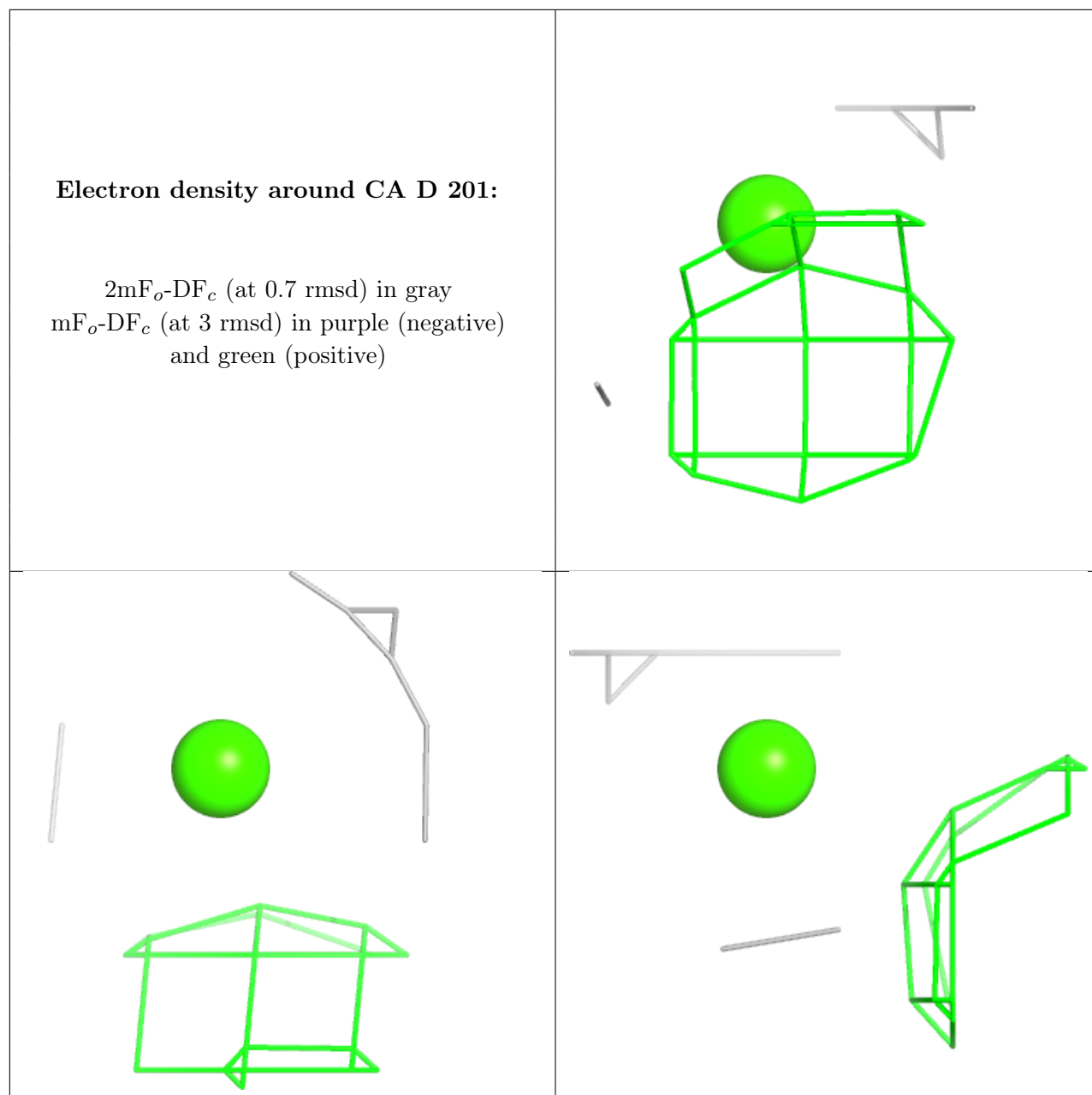

6.5 Other polymers [i](#)

There are no such residues in this entry.