



Full wwPDB EM Validation Report ⓘ

Nov 29, 2022 – 06:40 PM JST

PDB ID : 7WS5
EMDB ID : EMD-32744
Title : Structures of Omicron Spike complexes illuminate broad-spectrum neutralizing antibody development
Authors : Guo, H.; Gao, Y.; Ji, X.; Yang, H.
Deposited on : 2022-01-28
Resolution : 3.70 Å(reported)

This is a Full wwPDB EM Validation Report for a publicly released PDB entry.

We welcome your comments at validation@mail.wwpdb.org

A user guide is available at

<https://www.wwpdb.org/validation/2017/EMValidationReportHelp>

with specific help available everywhere you see the ⓘ symbol.

The types of validation reports are described at

<http://www.wwpdb.org/validation/2017/FAQs#types>.

The following versions of software and data (see [references ⓘ](#)) were used in the production of this report:

EMDB validation analysis : 0.0.1.dev43
Mogul : 1.8.5 (274361), CSD as541be (2020)
MolProbity : 4.02b-467
buster-report : 1.1.7 (2018)
Percentile statistics : 20191225.v01 (using entries in the PDB archive December 25th 2019)
MapQ : 1.9.9
Ideal geometry (proteins) : Engh & Huber (2001)
Ideal geometry (DNA, RNA) : Parkinson et al. (1996)
Validation Pipeline (wwPDB-VP) : 2.31.3

1 Overall quality at a glance i

The following experimental techniques were used to determine the structure:

ELECTRON MICROSCOPY

The reported resolution of this entry is 3.70 Å.

Percentile scores (ranging between 0-100) for global validation metrics of the entry are shown in the following graphic. The table shows the number of entries on which the scores are based.

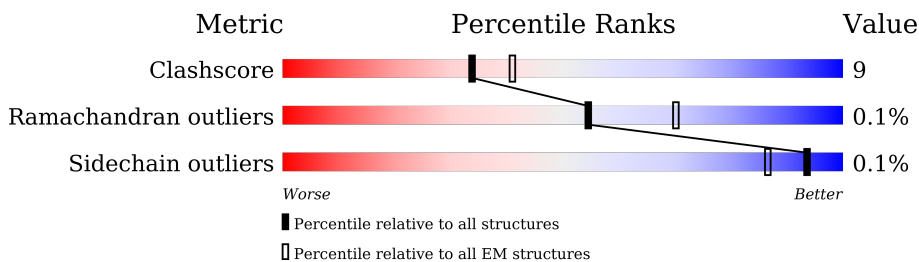

Metric	Whole archive (#Entries)	EM structures (#Entries)
Clashscore	158937	4297
Ramachandran outliers	154571	4023
Sidechain outliers	154315	3826

The table below summarises the geometric issues observed across the polymeric chains and their fit to the map. The red, orange, yellow and green segments of the bar indicate the fraction of residues that contain outliers for ≥ 3 , 2, 1 and 0 types of geometric quality criteria respectively. A grey segment represents the fraction of residues that are not modelled. The numeric value for each fraction is indicated below the corresponding segment, with a dot representing fractions $\leq 5\%$. The upper red bar (where present) indicates the fraction of residues that have poor fit to the EM map (all-atom inclusion $< 40\%$). The numeric value is given above the bar.

Mol	Chain	Length	Quality of chain
1	A	1205	 67% 19% 14%
1	B	1205	 71% 15% 14%
1	C	1205	 70% 16% 14%
2	D	108	 69% 31%
2	F	108	 69% 31%
2	H	108	 62% 38%
3	E	123	 66% 34%
3	G	123	 67% 33%

Continued on next page...

Continued from previous page...

Mol	Chain	Length	Quality of chain
3	I	123	 71% 29%
4	J	2	 100%
4	K	2	 100%
4	L	2	 100%
4	M	2	 100%
4	N	2	 100%
4	O	2	 50% 50%
4	P	2	 100%
4	Q	2	 50% 50%
4	R	2	 50% 50%
4	S	2	 50% 50%
4	T	2	 100%
4	U	2	 100%
4	V	2	 50% 50%
4	W	2	 100%

2 Entry composition i

There are 5 unique types of molecules in this entry. The entry contains 30228 atoms, of which 0 are hydrogens and 0 are deuteriums.

In the tables below, the AltConf column contains the number of residues with at least one atom in alternate conformation and the Trace column contains the number of residues modelled with at most 2 atoms.

- Molecule 1 is a protein called Spike glycoprotein.

Mol	Chain	Residues	Atoms					AltConf	Trace
			Total	C	N	O	S		
1	A	1035	8112	5197	1349	1529	37	0	0
1	B	1036	8135	5212	1355	1531	37	0	0
1	C	1036	8130	5209	1353	1531	37	0	0

There are 144 discrepancies between the modelled and reference sequences:

Chain	Residue	Modelled	Actual	Comment	Reference
A	67	VAL	ALA	variant	UNP P0DTC2
A	?	-	HIS	deletion	UNP P0DTC2
A	?	-	VAL	deletion	UNP P0DTC2
A	95	ILE	THR	variant	UNP P0DTC2
A	142	ASP	GLY	variant	UNP P0DTC2
A	?	-	VAL	deletion	UNP P0DTC2
A	?	-	TYR	deletion	UNP P0DTC2
A	?	-	TYR	deletion	UNP P0DTC2
A	?	-	ASN	deletion	UNP P0DTC2
A	211	ILE	LEU	variant	UNP P0DTC2
A	214	GLU	-	insertion	UNP P0DTC2
A	214A	PRO	-	insertion	UNP P0DTC2
A	214B	GLU	-	insertion	UNP P0DTC2
A	339	ASP	GLY	variant	UNP P0DTC2
A	371	LEU	SER	variant	UNP P0DTC2
A	373	PRO	SER	variant	UNP P0DTC2
A	375	PHE	SER	variant	UNP P0DTC2
A	417	ASN	LYS	variant	UNP P0DTC2
A	440	LYS	ASN	variant	UNP P0DTC2
A	446	SER	GLY	variant	UNP P0DTC2
A	477	ASN	SER	variant	UNP P0DTC2
A	478	LYS	THR	variant	UNP P0DTC2
A	484	ALA	GLU	variant	UNP P0DTC2
A	493	ARG	GLN	variant	UNP P0DTC2

Continued on next page...

Continued from previous page...

Chain	Residue	Modelled	Actual	Comment	Reference
A	496	SER	GLY	variant	UNP P0DTC2
A	498	ARG	GLN	variant	UNP P0DTC2
A	501	TYR	ASN	variant	UNP P0DTC2
A	505	HIS	TYR	variant	UNP P0DTC2
A	547	LYS	THR	variant	UNP P0DTC2
A	614	GLY	ASP	variant	UNP P0DTC2
A	655	TYR	HIS	variant	UNP P0DTC2
A	679	LYS	ASN	variant	UNP P0DTC2
A	681	HIS	PRO	variant	UNP P0DTC2
A	682	GLY	ARG	engineered mutation	UNP P0DTC2
A	683	SER	ARG	engineered mutation	UNP P0DTC2
A	685	SER	ARG	engineered mutation	UNP P0DTC2
A	764	LYS	ASN	variant	UNP P0DTC2
A	796	TYR	ASP	variant	UNP P0DTC2
A	817	PRO	PHE	engineered mutation	UNP P0DTC2
A	856	LYS	ASN	variant	UNP P0DTC2
A	892	PRO	ALA	engineered mutation	UNP P0DTC2
A	899	PRO	ALA	engineered mutation	UNP P0DTC2
A	942	PRO	ALA	engineered mutation	UNP P0DTC2
A	954	HIS	GLN	variant	UNP P0DTC2
A	969	LYS	ASN	variant	UNP P0DTC2
A	981	PHE	LEU	variant	UNP P0DTC2
A	986	PRO	LYS	engineered mutation	UNP P0DTC2
A	987	PRO	VAL	engineered mutation	UNP P0DTC2
B	67	VAL	ALA	variant	UNP P0DTC2
B	?	-	HIS	deletion	UNP P0DTC2
B	?	-	VAL	deletion	UNP P0DTC2
B	95	ILE	THR	variant	UNP P0DTC2
B	142	ASP	GLY	variant	UNP P0DTC2
B	?	-	VAL	deletion	UNP P0DTC2
B	?	-	TYR	deletion	UNP P0DTC2
B	?	-	TYR	deletion	UNP P0DTC2
B	?	-	ASN	deletion	UNP P0DTC2
B	211	ILE	LEU	variant	UNP P0DTC2
B	214	GLU	-	insertion	UNP P0DTC2
B	214A	PRO	-	insertion	UNP P0DTC2
B	214B	GLU	-	insertion	UNP P0DTC2
B	339	ASP	GLY	variant	UNP P0DTC2
B	371	LEU	SER	variant	UNP P0DTC2
B	373	PRO	SER	variant	UNP P0DTC2
B	375	PHE	SER	variant	UNP P0DTC2
B	417	ASN	LYS	variant	UNP P0DTC2

Continued on next page...

Continued from previous page...

Chain	Residue	Modelled	Actual	Comment	Reference
B	440	LYS	ASN	variant	UNP P0DTC2
B	446	SER	GLY	variant	UNP P0DTC2
B	477	ASN	SER	variant	UNP P0DTC2
B	478	LYS	THR	variant	UNP P0DTC2
B	484	ALA	GLU	variant	UNP P0DTC2
B	493	ARG	GLN	variant	UNP P0DTC2
B	496	SER	GLY	variant	UNP P0DTC2
B	498	ARG	GLN	variant	UNP P0DTC2
B	501	TYR	ASN	variant	UNP P0DTC2
B	505	HIS	TYR	variant	UNP P0DTC2
B	547	LYS	THR	variant	UNP P0DTC2
B	614	GLY	ASP	variant	UNP P0DTC2
B	655	TYR	HIS	variant	UNP P0DTC2
B	679	LYS	ASN	variant	UNP P0DTC2
B	681	HIS	PRO	variant	UNP P0DTC2
B	682	GLY	ARG	engineered mutation	UNP P0DTC2
B	683	SER	ARG	engineered mutation	UNP P0DTC2
B	685	SER	ARG	engineered mutation	UNP P0DTC2
B	764	LYS	ASN	variant	UNP P0DTC2
B	796	TYR	ASP	variant	UNP P0DTC2
B	817	PRO	PHE	engineered mutation	UNP P0DTC2
B	856	LYS	ASN	variant	UNP P0DTC2
B	892	PRO	ALA	engineered mutation	UNP P0DTC2
B	899	PRO	ALA	engineered mutation	UNP P0DTC2
B	942	PRO	ALA	engineered mutation	UNP P0DTC2
B	954	HIS	GLN	variant	UNP P0DTC2
B	969	LYS	ASN	variant	UNP P0DTC2
B	981	PHE	LEU	variant	UNP P0DTC2
B	986	PRO	LYS	engineered mutation	UNP P0DTC2
B	987	PRO	VAL	engineered mutation	UNP P0DTC2
C	67	VAL	ALA	variant	UNP P0DTC2
C	?	-	HIS	deletion	UNP P0DTC2
C	?	-	VAL	deletion	UNP P0DTC2
C	95	ILE	THR	variant	UNP P0DTC2
C	142	ASP	GLY	variant	UNP P0DTC2
C	?	-	VAL	deletion	UNP P0DTC2
C	?	-	TYR	deletion	UNP P0DTC2
C	?	-	TYR	deletion	UNP P0DTC2
C	?	-	ASN	deletion	UNP P0DTC2
C	211	ILE	LEU	variant	UNP P0DTC2
C	214	GLU	-	insertion	UNP P0DTC2
C	214A	PRO	-	insertion	UNP P0DTC2

Continued on next page...

Continued from previous page...

Chain	Residue	Modelled	Actual	Comment	Reference
C	214B	GLU	-	insertion	UNP P0DTC2
C	339	ASP	GLY	variant	UNP P0DTC2
C	371	LEU	SER	variant	UNP P0DTC2
C	373	PRO	SER	variant	UNP P0DTC2
C	375	PHE	SER	variant	UNP P0DTC2
C	417	ASN	LYS	variant	UNP P0DTC2
C	440	LYS	ASN	variant	UNP P0DTC2
C	446	SER	GLY	variant	UNP P0DTC2
C	477	ASN	SER	variant	UNP P0DTC2
C	478	LYS	THR	variant	UNP P0DTC2
C	484	ALA	GLU	variant	UNP P0DTC2
C	493	ARG	GLN	variant	UNP P0DTC2
C	496	SER	GLY	variant	UNP P0DTC2
C	498	ARG	GLN	variant	UNP P0DTC2
C	501	TYR	ASN	variant	UNP P0DTC2
C	505	HIS	TYR	variant	UNP P0DTC2
C	547	LYS	THR	variant	UNP P0DTC2
C	614	GLY	ASP	variant	UNP P0DTC2
C	655	TYR	HIS	variant	UNP P0DTC2
C	679	LYS	ASN	variant	UNP P0DTC2
C	681	HIS	PRO	variant	UNP P0DTC2
C	682	GLY	ARG	engineered mutation	UNP P0DTC2
C	683	SER	ARG	engineered mutation	UNP P0DTC2
C	685	SER	ARG	engineered mutation	UNP P0DTC2
C	764	LYS	ASN	variant	UNP P0DTC2
C	796	TYR	ASP	variant	UNP P0DTC2
C	817	PRO	PHE	engineered mutation	UNP P0DTC2
C	856	LYS	ASN	variant	UNP P0DTC2
C	892	PRO	ALA	engineered mutation	UNP P0DTC2
C	899	PRO	ALA	engineered mutation	UNP P0DTC2
C	942	PRO	ALA	engineered mutation	UNP P0DTC2
C	954	HIS	GLN	variant	UNP P0DTC2
C	969	LYS	ASN	variant	UNP P0DTC2
C	981	PHE	LEU	variant	UNP P0DTC2
C	986	PRO	LYS	engineered mutation	UNP P0DTC2
C	987	PRO	VAL	engineered mutation	UNP P0DTC2

- Molecule 2 is a protein called 510A5 light chain.

Mol	Chain	Residues	Atoms				AltConf	Trace	
			Total	C	N	O	S		
2	D	108	817	514	134	166	3	0	0

Continued on next page...

Continued from previous page...

Mol	Chain	Residues	Atoms					AltConf	Trace
2	F	108	Total	C	N	O	S	0	0
			817	514	134	166	3		
2	H	108	Total	C	N	O	S	0	0
			817	514	134	166	3		

- Molecule 3 is a protein called 510A5 heavy chain.

Mol	Chain	Residues	Atoms					AltConf	Trace
3	E	123	Total	C	N	O	S	0	0
			956	601	163	188	4		
3	G	123	Total	C	N	O	S	0	0
			956	601	163	188	4		
3	I	123	Total	C	N	O	S	0	0
			956	601	163	188	4		

- Molecule 4 is an oligosaccharide called 2-acetamido-2-deoxy-beta-D-glucopyranose-(1-4)-2-acetamido-2-deoxy-beta-D-glucopyranose.



Mol	Chain	Residues	Atoms				AltConf	Trace
4	O	2	Total	C	N	O	0	0
			28	16	2	10		
4	J	2	Total	C	N	O	0	0
			28	16	2	10		
4	K	2	Total	C	N	O	0	0
			28	16	2	10		
4	L	2	Total	C	N	O	0	0
			28	16	2	10		
4	M	2	Total	C	N	O	0	0
			28	16	2	10		
4	N	2	Total	C	N	O	0	0
			28	16	2	10		
4	P	2	Total	C	N	O	0	0
			28	16	2	10		
4	Q	2	Total	C	N	O	0	0
			28	16	2	10		
4	R	2	Total	C	N	O	0	0
			28	16	2	10		

Continued on next page...

Continued from previous page...

Mol	Chain	Residues	Atoms				AltConf	Trace
			Total	C	N	O		
4	S	2	Total 28	C 16	N 2	O 10	0	0
4	T	2	Total 28	C 16	N 2	O 10	0	0
4	U	2	Total 28	C 16	N 2	O 10	0	0
4	V	2	Total 28	C 16	N 2	O 10	0	0
4	W	2	Total 28	C 16	N 2	O 10	0	0

- Molecule 5 is 2-acetamido-2-deoxy-beta-D-glucopyranose (three-letter code: NAG) (formula: $C_8H_{15}NO_6$) (labeled as "Ligand of Interest" by depositor).

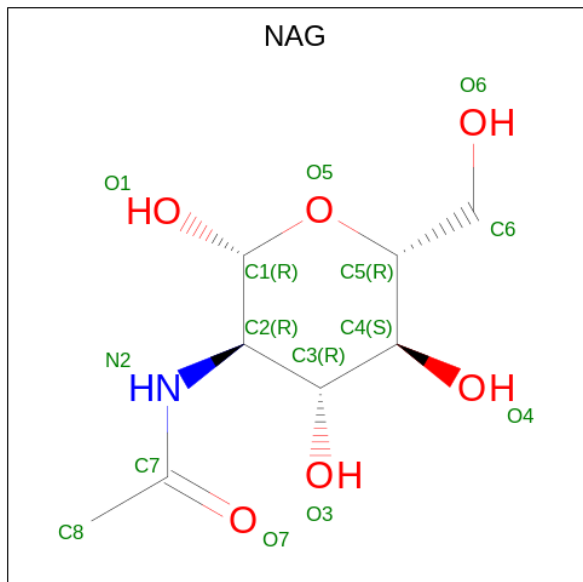

Mol	Chain	Residues	Atoms				AltConf
			Total	C	N	O	
5	A	1	Total 42	C 24	N 3	O 15	0
5	A	1	Total 42	C 24	N 3	O 15	0
5	A	1	Total 42	C 24	N 3	O 15	0
5	B	1	Total 42	C 24	N 3	O 15	0
5	B	1	Total 42	C 24	N 3	O 15	0
5	B	1	Total 42	C 24	N 3	O 15	0

Continued on next page...

Continued from previous page...

Mol	Chain	Residues	Atoms				AltConf
			Total	C	N	O	
5	C	1	Total 56	C 32	N 4	O 20	0
5	C	1	Total 56	C 32	N 4	O 20	0
5	C	1	Total 56	C 32	N 4	O 20	0
5	C	1	Total 56	C 32	N 4	O 20	0

3 Residue-property plots [i](#)

These plots are drawn for all protein, RNA, DNA and oligosaccharide chains in the entry. The first graphic for a chain summarises the proportions of the various outlier classes displayed in the second graphic. The second graphic shows the sequence view annotated by issues in geometry and atom inclusion in map density. Residues are color-coded according to the number of geometric quality criteria for which they contain at least one outlier: green = 0, yellow = 1, orange = 2 and red = 3 or more. A red diamond above a residue indicates a poor fit to the EM map for this residue (all-atom inclusion < 40%). Stretches of 2 or more consecutive residues without any outlier are shown as a green connector. Residues present in the sample, but not in the model, are shown in grey.

- Molecule 1: Spike glycoprotein

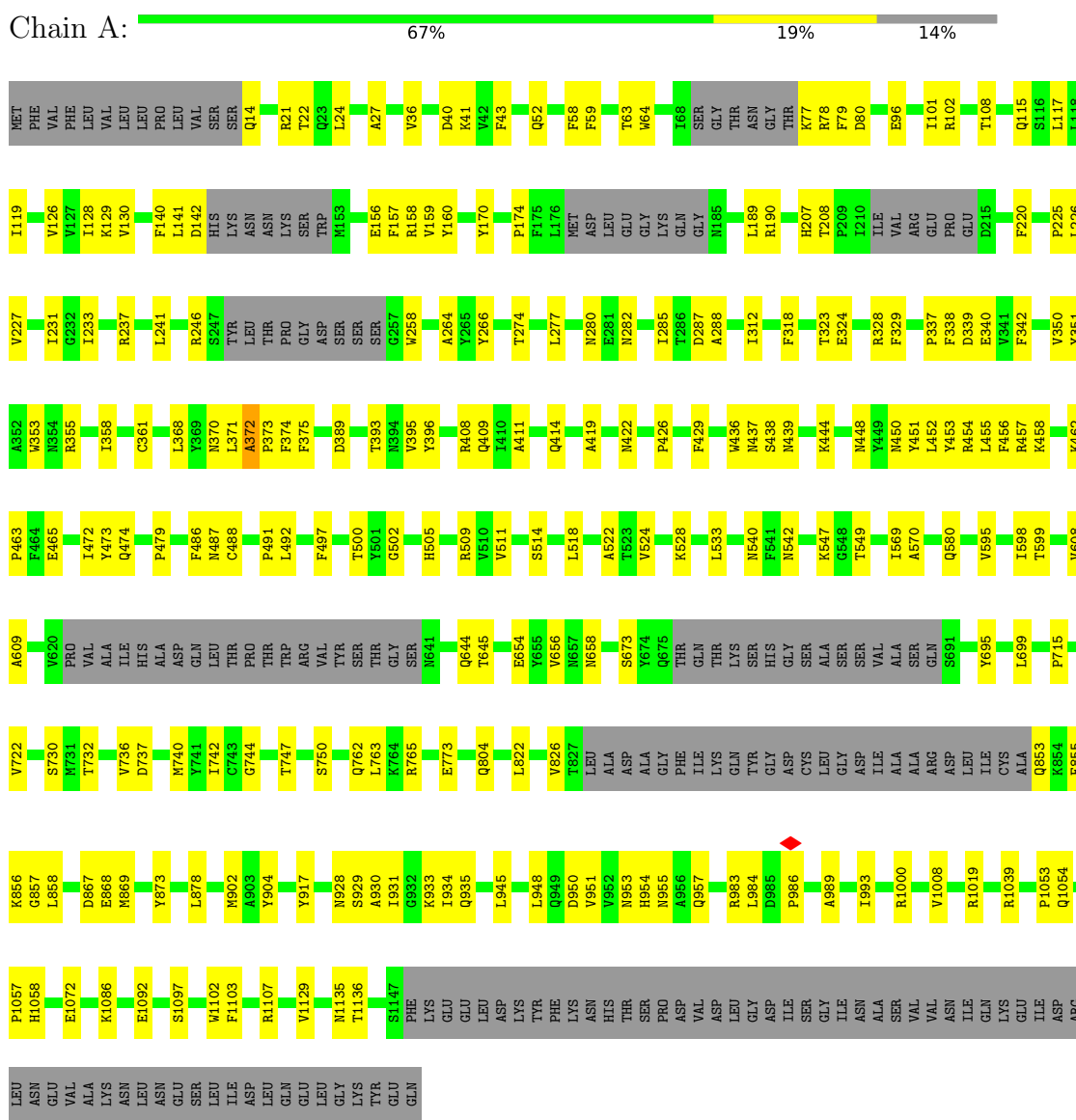

- Molecule 1: Spike glycoprotein

Chain B:

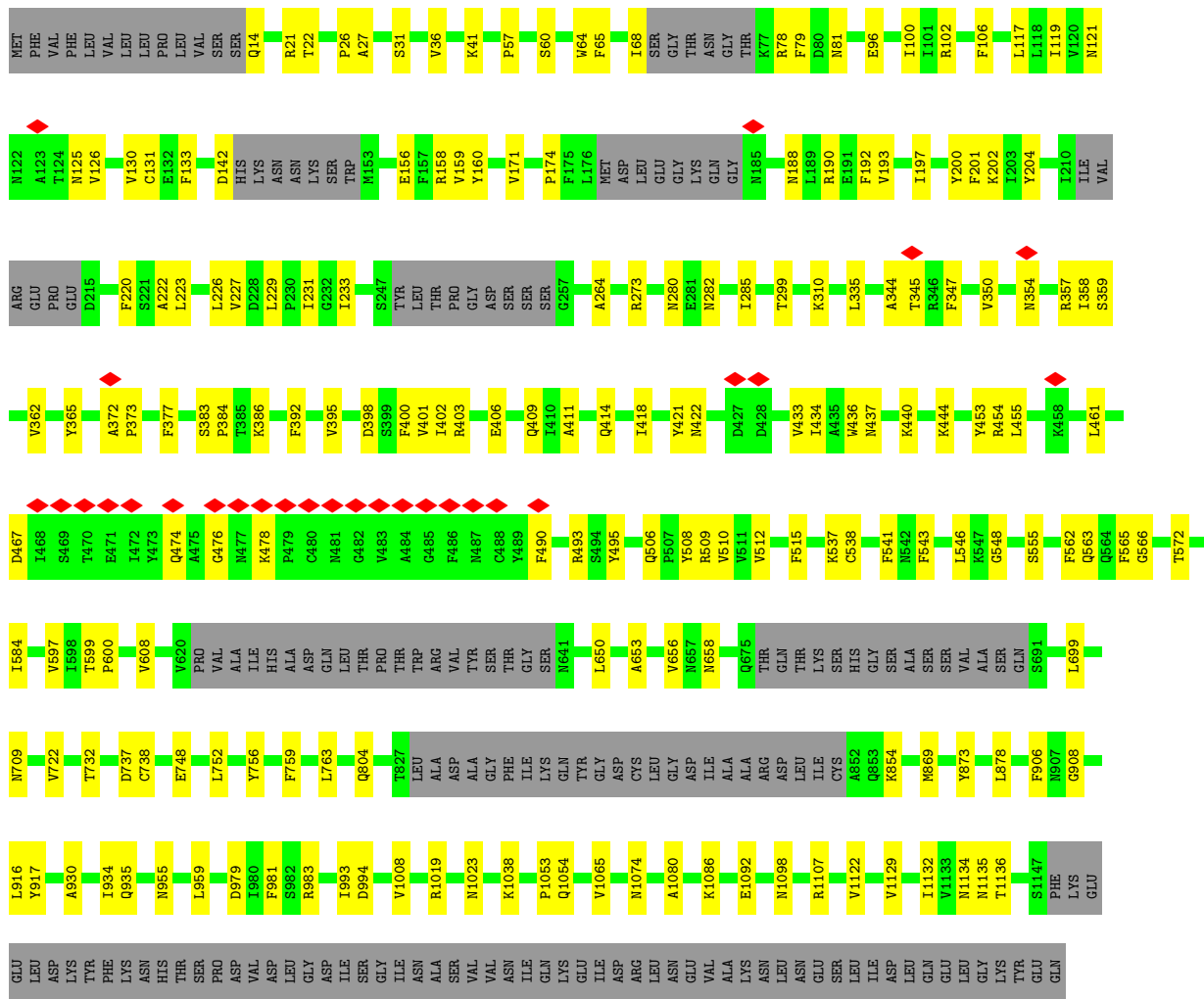

● Molecule 1: Spike glycoprotein

Chain C:

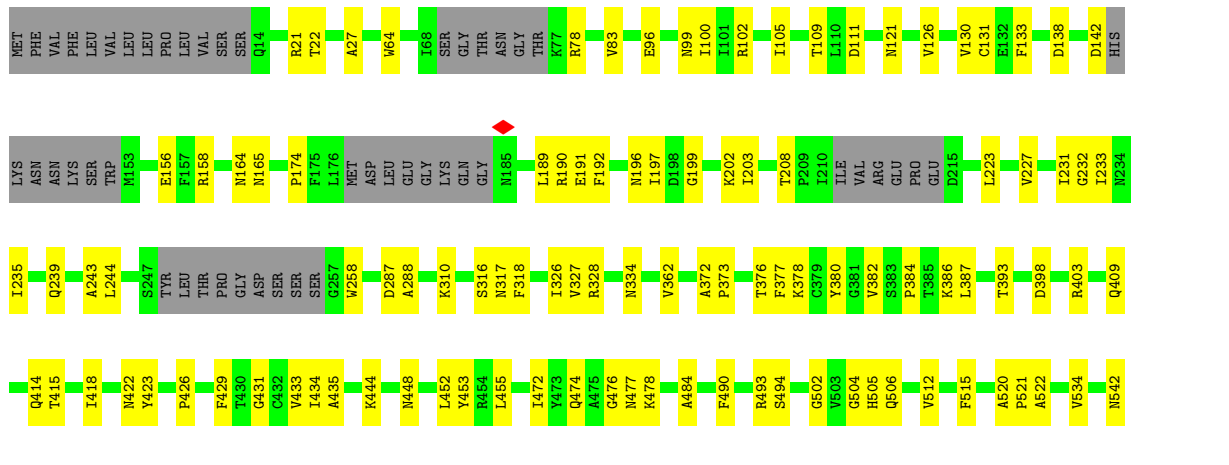

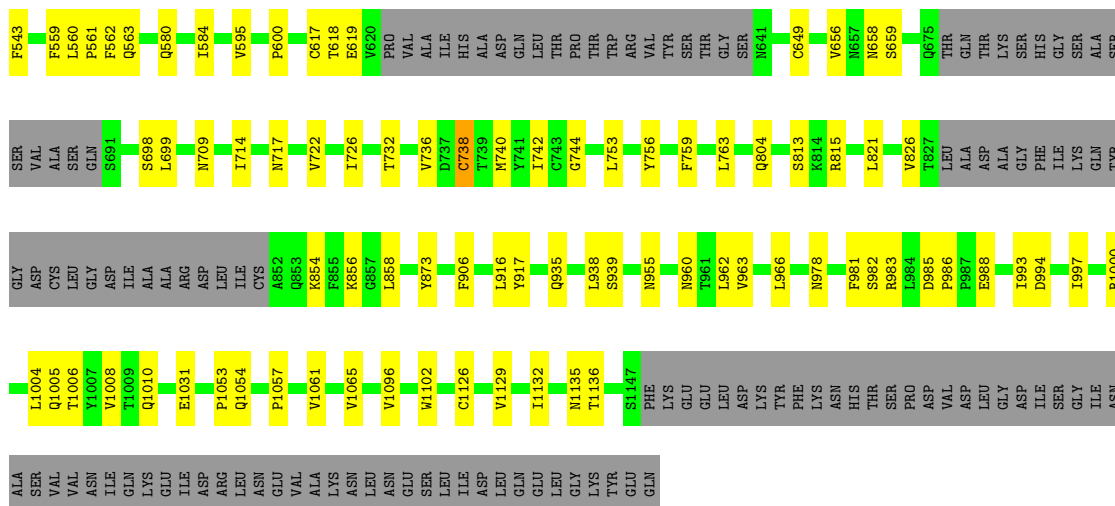

• Molecule 2: 510A5 light chain

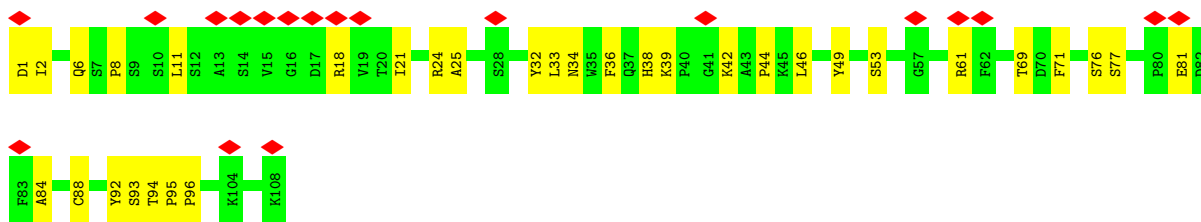

• Molecule 2: 510A5 light chain

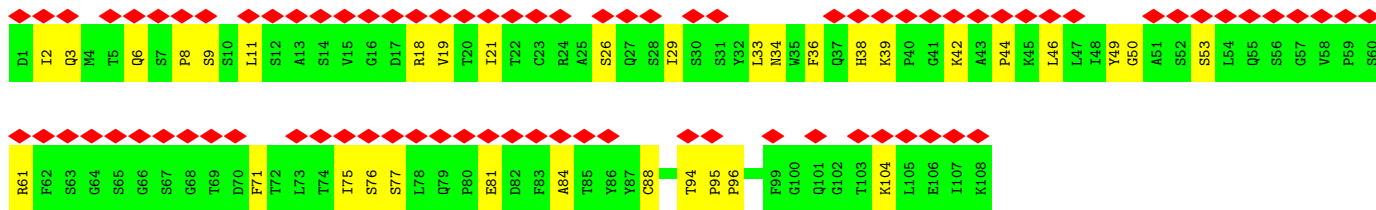
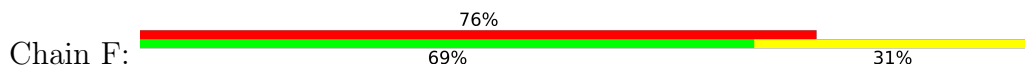

• Molecule 2: 510A5 light chain

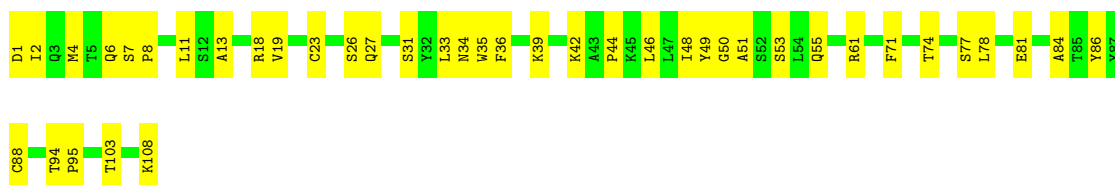

• Molecule 3: 510A5 heavy chain

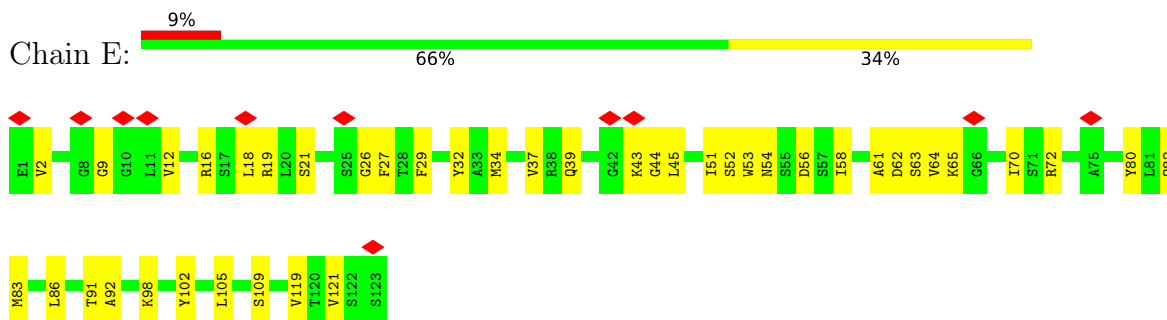

- Molecule 3: 510A5 heavy chain

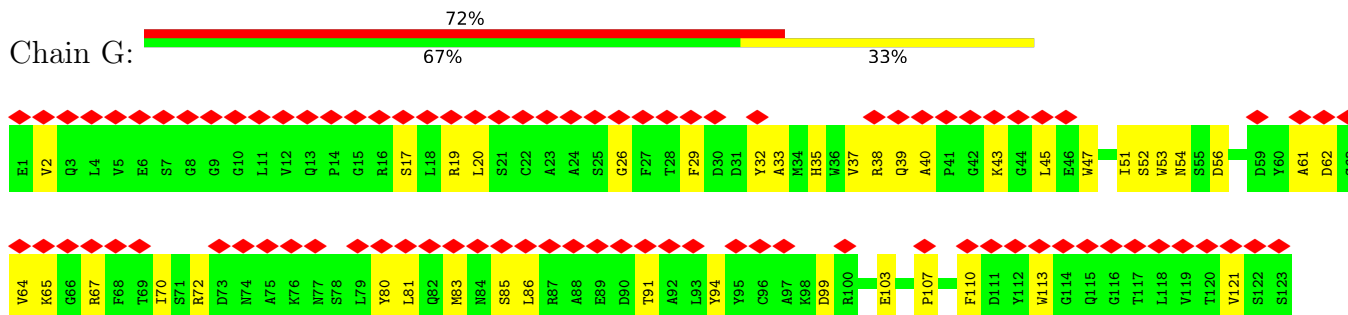

- Molecule 3: 510A5 heavy chain

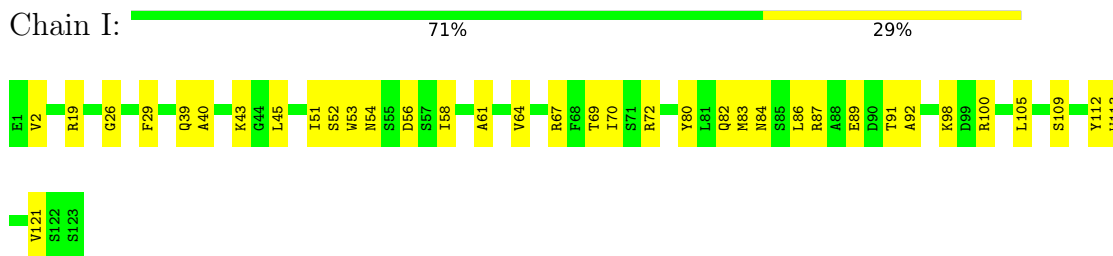

- Molecule 4: 2-acetamido-2-deoxy-beta-D-glucopyranose-(1-4)-2-acetamido-2-deoxy-beta-D-glucopyranose



- Molecule 4: 2-acetamido-2-deoxy-beta-D-glucopyranose-(1-4)-2-acetamido-2-deoxy-beta-D-glucopyranose

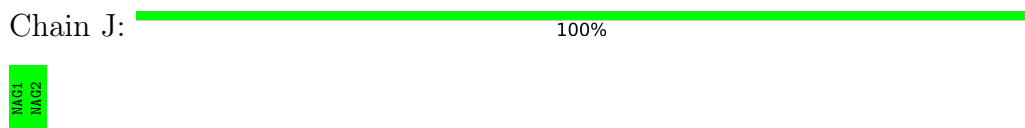

- Molecule 4: 2-acetamido-2-deoxy-beta-D-glucopyranose-(1-4)-2-acetamido-2-deoxy-beta-D-glucopyranose





- Molecule 4: 2-acetamido-2-deoxy-beta-D-glucopyranose-(1-4)-2-acetamido-2-deoxy-beta-D-glucopyranose

Chain L:  100%



- Molecule 4: 2-acetamido-2-deoxy-beta-D-glucopyranose-(1-4)-2-acetamido-2-deoxy-beta-D-glucopyranose

Chain M:  100%



- Molecule 4: 2-acetamido-2-deoxy-beta-D-glucopyranose-(1-4)-2-acetamido-2-deoxy-beta-D-glucopyranose

Chain N:  100%



- Molecule 4: 2-acetamido-2-deoxy-beta-D-glucopyranose-(1-4)-2-acetamido-2-deoxy-beta-D-glucopyranose

Chain P:  100%



- Molecule 4: 2-acetamido-2-deoxy-beta-D-glucopyranose-(1-4)-2-acetamido-2-deoxy-beta-D-glucopyranose

Chain Q:  50% 50%



- Molecule 4: 2-acetamido-2-deoxy-beta-D-glucopyranose-(1-4)-2-acetamido-2-deoxy-beta-D-glucopyranose

Chain R: 50% 50%



- Molecule 4: 2-acetamido-2-deoxy-beta-D-glucopyranose-(1-4)-2-acetamido-2-deoxy-beta-D-glucopyranose

Chain S:  50% 50%



- Molecule 4: 2-acetamido-2-deoxy-beta-D-glucopyranose-(1-4)-2-acetamido-2-deoxy-beta-D-glucopyranose

Chain T:  100%



- Molecule 4: 2-acetamido-2-deoxy-beta-D-glucopyranose-(1-4)-2-acetamido-2-deoxy-beta-D-glucopyranose

Chain U:  100%



- Molecule 4: 2-acetamido-2-deoxy-beta-D-glucopyranose-(1-4)-2-acetamido-2-deoxy-beta-D-glucopyranose

Chain V:  50% 50%



- Molecule 4: 2-acetamido-2-deoxy-beta-D-glucopyranose-(1-4)-2-acetamido-2-deoxy-beta-D-glucopyranose

Chain W:  100%



4 Experimental information

Property	Value	Source
EM reconstruction method	SINGLE PARTICLE	Depositor
Imposed symmetry	POINT, Not provided	
Number of particles used	108540	Depositor
Resolution determination method	FSC 0.143 CUT-OFF	Depositor
CTF correction method	PHASE FLIPPING AND AMPLITUDE CORRECTION	Depositor
Microscope	FEI TITAN KRIOS	Depositor
Voltage (kV)	300	Depositor
Electron dose ($e^-/\text{\AA}^2$)	60	Depositor
Minimum defocus (nm)	1200	Depositor
Maximum defocus (nm)	2800	Depositor
Magnification	Not provided	
Image detector	GATAN K3 (6k x 4k)	Depositor
Maximum map value	1.719	Depositor
Minimum map value	-0.614	Depositor
Average map value	0.001	Depositor
Map value standard deviation	0.040	Depositor
Recommended contour level	0.2036	Depositor
Map size (Å)	425.984, 425.984, 425.984	wwPDB
Map dimensions	512, 512, 512	wwPDB
Map angles (°)	90.0, 90.0, 90.0	wwPDB
Pixel spacing (Å)	0.832, 0.832, 0.832	Depositor

5 Model quality [i](#)

5.1 Standard geometry [i](#)

Bond lengths and bond angles in the following residue types are not validated in this section: NAG

The Z score for a bond length (or angle) is the number of standard deviations the observed value is removed from the expected value. A bond length (or angle) with $|Z| > 5$ is considered an outlier worth inspection. RMSZ is the root-mean-square of all Z scores of the bond lengths (or angles).

Mol	Chain	Bond lengths		Bond angles	
		RMSZ	# Z >5	RMSZ	# Z >5
1	A	0.27	0/8302	0.48	1/11294 (0.0%)
1	B	0.27	0/8327	0.48	0/11327
1	C	0.27	0/8321	0.48	0/11319
2	D	0.25	0/837	0.48	0/1137
2	F	0.25	0/837	0.47	0/1137
2	H	0.26	0/837	0.50	0/1137
3	E	0.25	0/978	0.53	0/1326
3	G	0.24	0/978	0.51	0/1326
3	I	0.24	0/978	0.53	0/1326
All	All	0.26	0/30395	0.49	1/41329 (0.0%)

There are no bond length outliers.

All (1) bond angle outliers are listed below:

Mol	Chain	Res	Type	Atoms	Z	Observed($^{\circ}$)	Ideal($^{\circ}$)
1	A	339	ASP	CB-CG-OD2	5.17	122.96	118.30

There are no chirality outliers.

There are no planarity outliers.

5.2 Too-close contacts [i](#)

In the following table, the Non-H and H(model) columns list the number of non-hydrogen atoms and hydrogen atoms in the chain respectively. The H(added) column lists the number of hydrogen atoms added and optimized by MolProbity. The Clashes column lists the number of clashes within the asymmetric unit, whereas Symm-Clashes lists symmetry-related clashes.

Mol	Chain	Non-H	H(model)	H(added)	Clashes	Symm-Clashes
1	A	8112	0	7937	159	0

Continued on next page...

Continued from previous page...

Mol	Chain	Non-H	H(model)	H(added)	Clashes	Symm-Clashes
1	B	8135	0	7965	140	0
1	C	8130	0	7960	129	0
2	D	817	0	786	28	0
2	F	817	0	786	24	0
2	H	817	0	786	26	0
3	E	956	0	908	32	0
3	G	956	0	908	25	0
3	I	956	0	908	22	0
4	J	28	0	25	0	0
4	K	28	0	25	0	0
4	L	28	0	25	0	0
4	M	28	0	25	0	0
4	N	28	0	25	0	0
4	O	28	0	25	1	0
4	P	28	0	25	0	0
4	Q	28	0	25	1	0
4	R	28	0	25	1	0
4	S	28	0	25	1	0
4	T	28	0	25	0	0
4	U	28	0	25	0	0
4	V	28	0	25	2	0
4	W	28	0	25	0	0
5	A	42	0	39	0	0
5	B	42	0	39	1	0
5	C	56	0	52	1	0
All	All	30228	0	29424	538	0

The all-atom clashscore is defined as the number of clashes found per 1000 atoms (including hydrogen atoms). The all-atom clashscore for this structure is 9.

All (538) close contacts within the same asymmetric unit are listed below, sorted by their clash magnitude.

Atom-1	Atom-2	Interatomic distance (Å)	Clash overlap (Å)
3:E:19:ARG:HH12	3:E:21:SER:HB3	1.46	0.81
3:I:83:MET:HB3	3:I:86:LEU:HD21	1.63	0.80
1:A:452:LEU:HD13	1:A:492:LEU:HD21	1.64	0.79
1:B:41:LYS:HE3	1:C:562:PHE:HZ	1.46	0.78
1:A:115:GLN:HE21	1:A:130:VAL:HG12	1.49	0.78
1:A:502:GLY:HA3	1:A:505:HIS:HD2	1.50	0.77
1:A:474:GLN:HE22	1:A:479:PRO:HA	1.51	0.75
2:D:24:ARG:HH22	2:D:69:THR:HB	1.53	0.74

Continued on next page...

Continued from previous page...

Atom-1	Atom-2	Interatomic distance (Å)	Clash overlap (Å)
1:B:437:ASN:HA	1:B:508:TYR:HD1	1.53	0.74
1:A:422:ASN:HD21	1:A:454:ARG:H	1.36	0.74
1:C:384:PRO:HA	1:C:387:LEU:HD23	1.71	0.73
1:A:1103:PHE:HZ	4:V:1:NAG:H62	1.53	0.72
2:D:39:LYS:HD3	2:D:84:ALA:HB2	1.72	0.72
1:B:1134:ASN:OD1	4:S:1:NAG:N2	2.24	0.71
1:B:64:TRP:HE1	1:B:264:ALA:HB1	1.55	0.71
1:B:41:LYS:HD2	1:C:520:ALA:HA	1.71	0.71
1:B:358:ILE:HB	1:B:395:VAL:HB	1.73	0.71
3:E:29:PHE:O	3:E:72:ARG:NH2	2.24	0.71
1:C:763:LEU:HD22	1:C:1008:VAL:HG21	1.74	0.70
2:H:6:GLN:NE2	2:H:88:CYS:SG	2.65	0.70
3:I:91:THR:HG22	3:I:121:VAL:H	1.55	0.70
1:A:372:ALA:N	1:A:373:PRO:HD2	2.07	0.69
1:B:650:LEU:HD21	1:B:653:ALA:HB3	1.74	0.69
1:A:983:ARG:HE	1:A:984:LEU:HG	1.56	0.69
1:C:328:ARG:HH21	1:C:580:GLN:HB2	1.58	0.69
2:F:18:ARG:HG2	2:F:76:SER:HA	1.73	0.69
1:B:22:THR:O	1:B:78:ARG:NH1	2.26	0.69
2:D:39:LYS:NZ	2:D:81:GLU:O	2.25	0.68
1:A:142:ASP:HB2	1:A:156:GLU:HB3	1.74	0.68
1:B:156:GLU:OE2	1:B:158:ARG:NH1	2.27	0.68
1:B:763:LEU:HD23	1:B:1008:VAL:HG21	1.74	0.68
3:E:83:MET:HB3	3:E:86:LEU:HD21	1.74	0.68
1:B:1098:ASN:OD1	4:R:1:NAG:N2	2.27	0.68
2:H:8:PRO:HB2	2:H:11:LEU:HD11	1.76	0.67
3:G:29:PHE:O	3:G:72:ARG:NH2	2.26	0.67
1:C:142:ASP:HB2	1:C:156:GLU:HB3	1.77	0.67
1:A:570:ALA:HB3	1:C:856:LYS:HZ2	1.59	0.66
1:B:26:PRO:HB3	1:B:65:PHE:HE1	1.60	0.66
2:F:6:GLN:NE2	2:F:88:CYS:SG	2.69	0.66
1:C:126:VAL:HG13	1:C:174:PRO:HA	1.77	0.65
1:A:77:LYS:HG2	1:A:79:PHE:CZ	2.32	0.65
1:A:570:ALA:HB1	1:C:966:LEU:HD11	1.78	0.65
1:A:27:ALA:HB3	1:A:64:TRP:HB3	1.77	0.65
1:B:197:ILE:HB	1:B:202:LYS:HZ1	1.61	0.65
2:D:18:ARG:HG2	2:D:76:SER:HA	1.79	0.65
1:A:804:GLN:NE2	1:A:935:GLN:OE1	2.29	0.65
1:C:156:GLU:OE2	1:C:158:ARG:NH1	2.30	0.65
3:E:91:THR:HG22	3:E:121:VAL:H	1.61	0.65
1:A:342:PHE:HE1	1:A:511:VAL:HG11	1.60	0.64

Continued on next page...

Continued from previous page...

Atom-1	Atom-2	Interatomic distance (Å)	Clash overlap (Å)
1:A:547:LYS:O	1:C:978:ASN:ND2	2.29	0.64
3:I:40:ALA:HB3	3:I:43:LYS:HB2	1.79	0.64
3:I:98:LYS:HD3	3:I:112:TYR:HB2	1.79	0.64
2:H:31:SER:HB2	2:H:51:ALA:HB2	1.79	0.64
1:B:345:THR:HG21	3:G:32:TYR:HE1	1.62	0.64
1:B:142:ASP:HB2	1:B:156:GLU:HB3	1.79	0.64
1:B:555:SER:HB3	1:B:584:ILE:HG23	1.79	0.63
2:D:8:PRO:HB2	2:D:11:LEU:HD11	1.80	0.63
1:C:717:ASN:OD1	4:O:1:NAG:N2	2.31	0.63
1:A:371:LEU:C	1:A:373:PRO:HD2	2.19	0.63
1:B:96:GLU:O	1:B:188:ASN:HB2	1.99	0.63
1:A:1053:PRO:O	1:A:1054:GLN:NE2	2.28	0.63
1:A:762:GLN:OE1	1:A:765:ARG:NH1	2.32	0.62
1:B:126:VAL:HG13	1:B:174:PRO:HA	1.81	0.62
1:B:226:LEU:HG	1:B:227:VAL:HG23	1.80	0.62
1:A:763:LEU:HD22	1:A:1008:VAL:HG21	1.82	0.62
1:B:31:SER:HB3	1:B:60:SER:H	1.65	0.62
1:C:742:ILE:HG21	1:C:753:LEU:HD11	1.81	0.62
1:B:869:MET:HG2	1:C:699:LEU:HD11	1.81	0.62
1:C:804:GLN:NE2	1:C:935:GLN:OE1	2.24	0.62
2:F:39:LYS:HD3	2:F:84:ALA:HB2	1.80	0.62
1:A:226:LEU:HG	1:A:227:VAL:HG23	1.82	0.62
1:B:27:ALA:HB3	1:B:64:TRP:HB3	1.82	0.62
1:C:191:GLU:HG2	1:C:223:LEU:HD21	1.82	0.62
1:C:858:LEU:HD11	1:C:962:LEU:HD22	1.81	0.62
1:A:14:GLN:HG3	1:A:158:ARG:HG2	1.82	0.62
1:A:156:GLU:OE2	1:A:158:ARG:NH1	2.33	0.62
3:I:2:VAL:HA	3:I:26:GLY:HA3	1.81	0.61
2:F:8:PRO:HB2	2:F:11:LEU:HD11	1.81	0.61
2:D:6:GLN:NE2	2:D:88:CYS:SG	2.70	0.61
1:A:323:THR:OG1	1:A:324:GLU:OE1	2.17	0.61
1:A:950:ASP:HA	1:A:953:ASN:HB2	1.82	0.61
3:G:52:SER:O	3:G:72:ARG:NH1	2.33	0.61
1:C:418:ILE:HA	1:C:422:ASN:HD22	1.65	0.61
1:B:201:PHE:HB3	1:B:229:LEU:HB2	1.82	0.61
1:A:358:ILE:HB	1:A:395:VAL:HB	1.83	0.61
1:B:1019:ARG:NH1	1:B:1023:ASN:OD1	2.34	0.61
3:G:39:GLN:HB2	3:G:45:LEU:HD23	1.82	0.61
3:E:62:ASP:OD1	3:E:63:SER:N	2.33	0.61
3:I:87:ARG:NH1	3:I:89:GLU:OE2	2.34	0.61
1:A:917:TYR:HB3	1:B:1129:VAL:HG12	1.81	0.61

Continued on next page...

Continued from previous page...

Atom-1	Atom-2	Interatomic distance (Å)	Clash overlap (Å)
1:B:804:GLN:NE2	1:B:935:GLN:OE1	2.27	0.61
1:C:27:ALA:HB3	1:C:64:TRP:HB3	1.82	0.60
1:B:437:ASN:ND2	1:B:508:TYR:HE1	1.99	0.60
1:A:450:ASN:HD22	3:E:102:TYR:HE2	1.46	0.60
1:A:52:GLN:HB2	1:A:274:THR:HG22	1.83	0.60
1:B:1135:ASN:OD1	1:B:1136:THR:N	2.34	0.60
1:B:401:VAL:HG22	1:B:509:ARG:HD3	1.84	0.60
1:C:393:THR:HA	1:C:522:ALA:HA	1.83	0.60
2:D:34:ASN:HD22	2:D:49:TYR:HA	1.66	0.60
1:C:1126:CYS:HB2	1:C:1132:ILE:HD13	1.84	0.60
3:G:17:SER:HA	3:G:83:MET:O	2.01	0.60
1:C:327:VAL:HG12	1:C:542:ASN:HB3	1.83	0.59
1:B:756:TYR:OH	1:B:994:ASP:OD1	2.20	0.59
1:A:372:ALA:N	1:A:373:PRO:CD	2.66	0.59
2:H:39:LYS:HD3	2:H:84:ALA:HB2	1.85	0.59
1:C:190:ARG:HB3	1:C:192:PHE:HE1	1.68	0.59
1:A:454:ARG:HD3	1:A:457:ARG:HB2	1.83	0.59
1:A:43:PHE:N	1:B:565:PHE:O	2.32	0.58
1:B:41:LYS:HE2	1:C:520:ALA:HB1	1.84	0.58
1:B:14:GLN:HB3	1:B:158:ARG:HE	1.69	0.58
1:C:109:THR:OG1	1:C:111:ASP:OD1	2.21	0.58
3:E:27:PHE:HZ	3:E:34:MET:HE1	1.68	0.58
1:A:547:LYS:HG3	1:C:978:ASN:HD21	1.68	0.57
1:B:1053:PRO:O	1:B:1054:GLN:NE2	2.29	0.57
3:G:91:THR:HG22	3:G:121:VAL:H	1.69	0.57
3:I:29:PHE:O	3:I:72:ARG:NH2	2.37	0.57
1:A:371:LEU:HB3	1:A:373:PRO:HD2	1.86	0.57
1:A:954:HIS:O	1:A:957:GLN:HG3	2.04	0.57
1:C:102:ARG:NH1	1:C:121:ASN:O	2.38	0.57
3:E:54:ASN:ND2	3:E:56:ASP:OD2	2.37	0.57
1:A:22:THR:O	1:A:78:ARG:NH1	2.38	0.57
1:A:454:ARG:HG3	1:A:491:PRO:HB2	1.85	0.57
1:B:383:SER:HB3	1:B:386:LYS:HG2	1.86	0.57
1:C:199:GLY:HA2	1:C:232:GLY:HA2	1.86	0.57
3:E:12:VAL:HB	3:E:16:ARG:HD2	1.86	0.57
1:C:742:ILE:O	1:C:1000:ARG:NH1	2.37	0.56
1:A:409:GLN:HB3	1:A:419:ALA:HB2	1.88	0.56
2:D:39:LYS:HB2	2:D:42:LYS:HG2	1.87	0.56
1:A:329:PHE:HE2	1:A:528:LYS:HB2	1.70	0.56
3:E:37:VAL:HB	3:E:45:LEU:HD21	1.86	0.56
1:B:131:CYS:HB2	1:B:133:PHE:CD1	2.41	0.56

Continued on next page...

Continued from previous page...

Atom-1	Atom-2	Interatomic distance (Å)	Clash overlap (Å)
3:E:2:VAL:HA	3:E:26:GLY:HA3	1.88	0.56
3:G:83:MET:HB3	3:G:86:LEU:HD21	1.88	0.56
2:D:94:THR:HG23	2:D:95:PRO:HD3	1.88	0.56
1:A:656:VAL:HG12	1:A:658:ASN:H	1.71	0.56
1:C:656:VAL:HG12	1:C:658:ASN:H	1.71	0.56
1:B:36:VAL:HG23	1:B:222:ALA:HA	1.87	0.55
1:C:1053:PRO:O	1:C:1054:GLN:NE2	2.29	0.55
1:B:344:ALA:HB3	1:B:347:PHE:HE1	1.71	0.55
1:B:437:ASN:HD22	1:B:508:TYR:HE1	1.55	0.55
1:C:378:LYS:NZ	1:C:380:TYR:OH	2.39	0.55
1:B:656:VAL:HG12	1:B:658:ASN:H	1.71	0.55
1:B:130:VAL:HG21	1:B:231:ILE:HD12	1.89	0.55
1:A:853:GLN:HB2	1:A:855:PHE:CZ	2.41	0.55
1:B:357:ARG:NH1	1:B:359:SER:OG	2.40	0.55
1:B:474:GLN:NE2	1:B:478:LYS:O	2.40	0.55
1:B:759:PHE:O	1:B:763:LEU:HD12	2.07	0.55
1:A:426:PRO:HG2	1:A:429:PHE:HB2	1.87	0.55
1:A:599:THR:HB	1:A:608:VAL:HG12	1.89	0.55
1:C:732:THR:HB	1:C:955:ASN:HD22	1.72	0.55
1:C:22:THR:O	1:C:78:ARG:NH1	2.40	0.54
1:A:411:ALA:HB3	1:A:414:GLN:HG3	1.89	0.54
1:C:326:ILE:HD12	1:C:534:VAL:H	1.72	0.54
1:A:826:VAL:HB	1:A:1057:PRO:HG2	1.90	0.54
1:B:732:THR:HB	1:B:955:ASN:ND2	2.23	0.54
1:B:474:GLN:NE2	1:B:476:GLY:O	2.37	0.54
1:C:985:ASP:OD1	1:C:986:PRO:HD2	2.07	0.54
1:A:989:ALA:O	1:A:993:ILE:HG12	2.08	0.54
2:D:1:ASP:OD1	2:D:2:ILE:N	2.41	0.54
1:B:131:CYS:HB2	1:B:133:PHE:HD1	1.72	0.54
1:C:906:PHE:CD2	1:C:916:LEU:HB2	2.42	0.54
1:A:64:TRP:HE1	1:A:264:ALA:HB1	1.72	0.54
1:B:418:ILE:HA	1:B:422:ASN:HB2	1.90	0.54
1:B:453:TYR:HE2	1:B:455:LEU:HD13	1.72	0.54
1:C:403:ARG:NH1	1:C:504:GLY:O	2.41	0.53
1:B:906:PHE:CD2	1:B:916:LEU:HB2	2.42	0.53
1:B:1074:ASN:HB2	4:Q:1:NAG:N2	2.23	0.53
1:C:490:PHE:HB3	1:C:493:ARG:HH22	1.73	0.53
3:I:52:SER:O	3:I:72:ARG:NH1	2.42	0.53
1:A:96:GLU:OE1	1:A:190:ARG:NH1	2.41	0.53
1:B:437:ASN:ND2	1:B:506:GLN:OE1	2.37	0.53
2:D:24:ARG:NH2	2:D:69:THR:HB	2.22	0.53

Continued on next page...

Continued from previous page...

Atom-1	Atom-2	Interatomic distance (Å)	Clash overlap (Å)
1:A:328:ARG:HH21	1:A:580:GLN:HB2	1.74	0.53
1:B:41:LYS:HE3	1:C:562:PHE:CZ	2.36	0.53
1:B:299:THR:OG1	1:B:597:VAL:HG21	2.09	0.53
1:A:422:ASN:HD21	1:A:454:ARG:N	2.04	0.53
1:A:1092:GLU:O	1:A:1107:ARG:NH1	2.42	0.53
1:A:1103:PHE:CZ	4:V:1:NAG:H62	2.40	0.53
1:B:737:ASP:OD1	1:C:317:ASN:ND2	2.42	0.53
2:F:39:LYS:HB2	2:F:42:LYS:HG2	1.90	0.53
3:E:51:ILE:HB	3:E:70:ILE:HD12	1.91	0.53
1:A:502:GLY:HA3	1:A:505:HIS:CD2	2.38	0.52
2:D:24:ARG:NH2	2:D:25:ALA:O	2.36	0.52
2:D:96:PRO:HB3	3:E:105:LEU:HD11	1.91	0.52
1:B:732:THR:HB	1:B:955:ASN:HD22	1.75	0.52
1:B:106:PHE:HD2	1:B:117:LEU:HD22	1.73	0.52
1:B:722:VAL:HG22	1:B:1065:VAL:HG22	1.91	0.52
1:B:908:GLY:O	1:B:1038:LYS:NZ	2.43	0.52
1:B:1092:GLU:O	1:B:1107:ARG:NE	2.43	0.52
1:C:714:ILE:HD11	1:C:1096:VAL:HG11	1.92	0.52
3:G:61:ALA:HB3	3:G:64:VAL:HG22	1.91	0.52
3:I:100:ARG:HH12	3:I:109:SER:H	1.57	0.52
1:A:699:LEU:HD22	1:C:873:TYR:CZ	2.45	0.52
1:B:26:PRO:HB3	1:B:65:PHE:CE1	2.44	0.52
1:A:337:PRO:HB2	1:A:340:GLU:OE1	2.10	0.52
1:A:448:ASN:HB3	1:A:497:PHE:HB2	1.91	0.52
1:C:858:LEU:HD21	1:C:962:LEU:HD22	1.91	0.52
1:A:873:TYR:CE1	1:B:699:LEU:HD12	2.45	0.52
1:A:950:ASP:O	1:A:954:HIS:N	2.40	0.52
1:B:159:VAL:HG23	1:B:160:TYR:HD1	1.75	0.52
1:B:873:TYR:CE1	1:C:699:LEU:HD12	2.44	0.52
1:A:986:PRO:HA	1:A:989:ALA:HB3	1.92	0.52
1:C:736:VAL:HG23	1:C:858:LEU:HD23	1.91	0.52
3:G:40:ALA:HB3	3:G:43:LYS:HB2	1.92	0.52
2:H:39:LYS:HB2	2:H:42:LYS:HG2	1.91	0.52
3:G:37:VAL:HG12	3:G:47:TRP:HA	1.91	0.51
1:B:21:ARG:HH21	1:B:81:ASN:HB2	1.75	0.51
1:C:559:PHE:CD2	1:C:584:ILE:HD12	2.44	0.51
1:C:618:THR:OG1	1:C:619:GLU:OE1	2.24	0.51
2:D:33:LEU:HD13	2:D:71:PHE:HD2	1.74	0.51
3:I:67:ARG:HH22	3:I:87:ARG:HH21	1.57	0.51
1:A:1129:VAL:HG12	1:C:917:TYR:HB3	1.92	0.51
3:I:61:ALA:HB3	3:I:64:VAL:HG22	1.92	0.51

Continued on next page...

Continued from previous page...

Atom-1	Atom-2	Interatomic distance (Å)	Clash overlap (Å)
1:B:125:ASN:HD22	1:B:171:VAL:HG13	1.75	0.51
1:C:377:PHE:HD1	1:C:434:ILE:HG12	1.74	0.51
1:C:472:ILE:HD12	1:C:484:ALA:HB2	1.92	0.51
2:H:2:ILE:HD12	2:H:26:SER:HB3	1.92	0.51
1:B:490:PHE:HB3	1:B:493:ARG:HH21	1.75	0.51
1:C:444:LYS:HD3	1:C:448:ASN:HA	1.91	0.51
1:B:280:ASN:HD21	1:B:282:ASN:HB2	1.76	0.51
1:C:287:ASP:OD1	1:C:288:ALA:N	2.44	0.51
3:E:18:LEU:HG	3:E:83:MET:HB2	1.91	0.51
1:B:229:LEU:HB3	1:B:231:ILE:HG12	1.94	0.50
1:A:141:LEU:HD22	1:A:157:PHE:CD1	2.46	0.50
1:B:444:LYS:HD2	3:G:103:GLU:HG3	1.93	0.50
1:C:21:ARG:NH2	1:C:138:ASP:OD2	2.43	0.50
3:E:52:SER:O	3:E:72:ARG:NH1	2.44	0.50
1:A:867:ASP:OD1	1:A:868:GLU:N	2.45	0.50
2:F:34:ASN:ND2	2:F:50:GLY:H	2.08	0.50
1:A:439:ASN:ND2	2:D:32:TYR:OH	2.44	0.50
2:H:61:ARG:HD2	2:H:77:SER:HB2	1.92	0.50
1:B:392:PHE:HD2	1:B:515:PHE:HB3	1.75	0.50
1:C:1135:ASN:OD1	1:C:1136:THR:N	2.44	0.50
2:H:34:ASN:HD22	2:H:50:GLY:H	1.60	0.50
3:E:9:GLY:HA2	3:E:119:VAL:HG12	1.94	0.50
1:B:41:LYS:O	1:C:563:GLN:HG2	2.12	0.50
1:B:599:THR:HB	1:B:608:VAL:HG12	1.94	0.50
2:F:2:ILE:HG22	2:F:95:PRO:HG2	1.92	0.50
2:H:1:ASP:O	2:H:27:GLN:NE2	2.45	0.50
1:A:40:ASP:OD1	1:A:40:ASP:N	2.42	0.49
1:A:462:LYS:HG2	1:A:463:PRO:HD2	1.94	0.49
1:A:570:ALA:HB3	1:C:856:LYS:NZ	2.27	0.49
1:A:654:GLU:N	1:A:654:GLU:OE1	2.45	0.49
1:A:822:LEU:HD22	1:A:945:LEU:HD21	1.94	0.49
1:C:105:ILE:HB	1:C:239:GLN:HB2	1.93	0.49
1:C:813:SER:OG	1:C:815:ARG:NH1	2.45	0.49
1:A:375:PHE:HE2	1:A:437:ASN:H	1.61	0.49
1:B:41:LYS:HE2	1:C:520:ALA:CB	2.41	0.49
1:B:335:LEU:HD13	1:B:362:VAL:HG13	1.93	0.49
1:B:433:VAL:HG12	1:B:512:VAL:HG22	1.95	0.49
3:I:39:GLN:HB2	3:I:45:LEU:HD23	1.93	0.49
1:A:396:TYR:HB2	1:A:514:SER:OG	2.13	0.49
1:B:930:ALA:O	1:B:934:ILE:HG12	2.11	0.49
2:D:33:LEU:HD11	2:D:88:CYS:HB2	1.95	0.49

Continued on next page...

Continued from previous page...

Atom-1	Atom-2	Interatomic distance (Å)	Clash overlap (Å)
3:G:33:ALA:HB3	3:G:99:ASP:HB3	1.93	0.49
1:B:392:PHE:CD2	1:B:515:PHE:HB3	2.47	0.49
1:B:406:GLU:HA	1:B:409:GLN:HG3	1.94	0.49
1:C:560:LEU:HD12	1:C:561:PRO:HD2	1.94	0.49
3:E:18:LEU:O	3:E:82:GLN:NE2	2.45	0.49
1:A:126:VAL:HG23	1:A:174:PRO:HA	1.95	0.49
1:C:433:VAL:HG12	1:C:512:VAL:HG22	1.94	0.49
2:F:34:ASN:HD22	2:F:49:TYR:HA	1.77	0.49
1:B:347:PHE:CD2	1:B:509:ARG:HD2	2.48	0.49
1:C:96:GLU:OE2	1:C:100:ILE:N	2.36	0.49
1:C:376:THR:HB	1:C:435:ALA:O	2.13	0.49
1:A:540:ASN:HB3	1:A:549:THR:HG22	1.94	0.49
1:C:203:ILE:HB	1:C:227:VAL:HG12	1.95	0.49
1:C:244:LEU:HD13	1:C:258:TRP:CD1	2.48	0.49
1:B:402:ILE:HD11	1:B:510:VAL:HG21	1.94	0.49
1:B:709:ASN:ND2	5:B:1303:NAG:O7	2.46	0.49
3:E:61:ALA:HB3	3:E:64:VAL:HG22	1.93	0.49
3:G:35:HIS:CD2	3:G:99:ASP:HB2	2.48	0.48
1:A:129:LYS:NZ	1:A:160:TYR:OH	2.46	0.48
1:A:374:PHE:HA	1:A:436:TRP:HB3	1.95	0.48
1:A:43:PHE:HB3	1:B:566:GLY:HA2	1.94	0.48
1:A:78:ARG:NH2	1:A:80:ASP:OD1	2.46	0.48
1:A:108:THR:O	1:A:237:ARG:NH1	2.47	0.48
1:A:736:VAL:HG23	1:A:858:LEU:HD22	1.95	0.48
1:B:41:LYS:HE2	1:C:521:PRO:HD2	1.95	0.48
1:A:598:ILE:HG13	1:A:609:ALA:HB3	1.95	0.48
1:A:732:THR:HB	1:A:955:ASN:ND2	2.29	0.48
1:B:981:PHE:O	1:C:386:LYS:HE3	2.13	0.48
1:A:644:GLN:NE2	1:A:645:THR:O	2.45	0.48
1:A:929:SER:O	1:A:933:LYS:HG2	2.13	0.48
1:C:1006:THR:O	1:C:1010:GLN:HG2	2.13	0.48
1:A:930:ALA:O	1:A:934:ILE:HG12	2.13	0.48
1:B:193:VAL:HG23	1:B:223:LEU:HD22	1.95	0.48
1:B:461:LEU:HD21	1:B:467:ASP:HB2	1.94	0.48
1:C:740:MET:HA	1:C:744:GLY:HA2	1.96	0.48
1:C:756:TYR:OH	1:C:994:ASP:OD1	2.31	0.48
1:A:486:PHE:O	1:A:487:ASN:HB3	2.14	0.48
1:C:474:GLN:HE21	1:C:476:GLY:H	1.62	0.48
2:D:38:HIS:HB2	2:D:44:PRO:HB3	1.96	0.48
1:A:389:ASP:HB3	1:A:528:LYS:HE3	1.96	0.48
1:A:328:ARG:HH11	1:A:533:LEU:HB3	1.78	0.47

Continued on next page...

Continued from previous page...

Atom-1	Atom-2	Interatomic distance (Å)	Clash overlap (Å)
1:C:164:ASN:OD1	1:C:165:ASN:N	2.47	0.47
1:C:993:ILE:O	1:C:997:ILE:HG12	2.13	0.47
1:A:453:TYR:CE2	1:A:455:LEU:HD11	2.50	0.47
2:H:18:ARG:HE	2:H:74:THR:HG21	1.79	0.47
1:B:437:ASN:HA	1:B:508:TYR:CD1	2.41	0.47
1:A:24:LEU:HD13	1:A:78:ARG:HD3	1.95	0.47
1:A:983:ARG:NE	1:A:984:LEU:HG	2.27	0.47
1:B:917:TYR:HB3	1:C:1129:VAL:HG12	1.97	0.47
1:A:128:ILE:HB	1:A:170:TYR:HB3	1.96	0.47
1:A:948:LEU:O	1:A:951:VAL:HB	2.14	0.47
1:A:732:THR:HB	1:A:955:ASN:HD22	1.80	0.47
1:A:740:MET:O	1:A:744:GLY:N	2.38	0.47
1:C:453:TYR:HE2	1:C:455:LEU:HD13	1.80	0.47
1:B:354:ASN:O	1:B:398:ASP:HA	2.15	0.47
2:H:36:PHE:CZ	2:H:46:LEU:HD12	2.50	0.47
2:H:94:THR:OG1	2:H:95:PRO:HD3	2.14	0.47
3:I:54:ASN:ND2	3:I:56:ASP:OD2	2.48	0.47
1:C:732:THR:HB	1:C:955:ASN:ND2	2.29	0.47
1:A:159:VAL:HG23	1:A:160:TYR:CD1	2.50	0.47
2:H:49:TYR:O	2:H:53:SER:HB2	2.15	0.47
1:A:773:GLU:OE2	1:A:1019:ARG:NH1	2.48	0.47
2:F:44:PRO:HG2	3:G:113:TRP:CE3	2.50	0.47
1:B:193:VAL:HB	1:B:204:TYR:HB2	1.97	0.46
2:F:9:SER:O	2:F:104:LYS:N	2.48	0.46
3:E:39:GLN:OE1	3:E:45:LEU:HB2	2.15	0.46
1:A:1135:ASN:OD1	1:A:1136:THR:N	2.48	0.46
2:F:61:ARG:HD2	2:F:77:SER:HB2	1.97	0.46
1:A:353:TRP:HZ3	1:A:355:ARG:HH11	1.61	0.46
1:B:350:VAL:HA	1:B:400:PHE:HB2	1.97	0.46
1:A:673:SER:OG	1:A:695:TYR:OH	2.26	0.46
1:B:68:ILE:HG22	1:B:78:ARG:HB2	1.97	0.46
1:B:190:ARG:HB3	1:B:192:PHE:HE1	1.81	0.46
1:C:197:ILE:HB	1:C:202:LYS:HZ1	1.79	0.46
1:C:960:ASN:O	1:C:963:VAL:HG12	2.15	0.46
3:E:39:GLN:NE2	3:E:43:LYS:O	2.48	0.46
1:B:395:VAL:HG13	1:B:515:PHE:CE1	2.51	0.46
2:F:33:LEU:HD13	2:F:71:PHE:CD2	2.51	0.46
3:G:51:ILE:HB	3:G:70:ILE:HD12	1.97	0.46
1:A:280:ASN:HD21	1:A:282:ASN:HB2	1.81	0.46
1:A:370:ASN:OD1	1:A:371:LEU:N	2.49	0.46
1:C:826:VAL:HB	1:C:1057:PRO:HG2	1.97	0.46

Continued on next page...

Continued from previous page...

Atom-1	Atom-2	Interatomic distance (Å)	Clash overlap (Å)
1:B:21:ARG:HG2	1:B:79:PHE:HB2	1.98	0.46
1:B:200:TYR:HB2	1:B:202:LYS:HZ2	1.80	0.46
1:C:130:VAL:HG21	1:C:231:ILE:HD12	1.97	0.46
1:C:196:ASN:ND2	1:C:235:ILE:HD12	2.31	0.46
1:C:617:CYS:HB3	1:C:649:CYS:HB3	1.78	0.46
1:A:472:ILE:HG13	1:A:488:CYS:HB3	1.98	0.46
1:C:722:VAL:HG22	1:C:1065:VAL:HG22	1.98	0.46
3:I:52:SER:OG	3:I:53:TRP:N	2.49	0.46
1:B:403:ARG:HE	1:B:495:TYR:HE1	1.64	0.46
1:B:537:LYS:HD3	1:B:538:CYS:N	2.31	0.46
2:F:8:PRO:HG2	2:F:21:ILE:HG23	1.98	0.45
1:A:41:LYS:NZ	1:B:562:PHE:HB2	2.31	0.45
1:A:361:CYS:HB2	1:A:524:VAL:HG13	1.98	0.45
1:A:869:MET:HB3	1:B:699:LEU:HD11	1.97	0.45
1:B:41:LYS:HG2	1:C:562:PHE:CE2	2.51	0.45
1:B:411:ALA:HB3	1:B:414:GLN:HG3	1.98	0.45
1:A:456:PHE:H	1:A:491:PRO:HA	1.81	0.45
2:H:44:PRO:HG2	3:I:113:TRP:CE3	2.51	0.45
2:H:86:TYR:O	2:H:103:THR:OG1	2.27	0.45
1:B:979:ASP:HB3	1:B:983:ARG:NH2	2.32	0.45
1:C:444:LYS:HA	3:I:105:LEU:O	2.17	0.45
1:C:659:SER:HB3	1:C:698:SER:HB3	1.97	0.45
1:A:58:PHE:HB3	1:A:59:PHE:CD2	2.52	0.45
3:E:43:LYS:HG3	3:E:44:GLY:H	1.81	0.45
3:G:54:ASN:ND2	3:G:56:ASP:OD2	2.50	0.45
1:B:383:SER:H	1:B:386:LYS:HE3	1.81	0.45
1:C:414:GLN:NE2	1:C:415:THR:O	2.48	0.45
1:C:906:PHE:HD2	1:C:916:LEU:HB2	1.80	0.45
1:C:490:PHE:HB3	1:C:493:ARG:NH2	2.32	0.45
2:F:94:THR:OG1	2:F:95:PRO:HD3	2.17	0.45
1:A:1039:ARG:NH2	1:C:1031:GLU:OE2	2.49	0.45
1:B:231:ILE:HG22	1:B:233:ILE:HG23	1.98	0.45
1:A:77:LYS:HE2	1:A:79:PHE:CZ	2.52	0.44
1:A:570:ALA:H	1:C:854:LYS:NZ	2.15	0.44
1:C:189:LEU:HB3	1:C:208:THR:HB	1.98	0.44
2:D:61:ARG:HD2	2:D:77:SER:HB2	1.99	0.44
2:H:19:VAL:HG12	2:H:78:LEU:HD21	1.98	0.44
1:A:451:TYR:HH	3:E:102:TYR:HH	1.59	0.44
1:C:409:GLN:HB2	1:C:418:ILE:HD11	2.00	0.44
1:A:737:ASP:HB3	1:A:857:GLY:HA2	2.00	0.44
1:B:748:GLU:HB2	1:B:981:PHE:CZ	2.53	0.44

Continued on next page...

Continued from previous page...

Atom-1	Atom-2	Interatomic distance (Å)	Clash overlap (Å)
2:F:3:GLN:HB2	2:F:26:SER:HB2	2.00	0.44
2:H:34:ASN:ND2	2:H:50:GLY:H	2.16	0.44
3:I:58:ILE:HG13	3:I:70:ILE:HD11	2.00	0.44
1:A:408:ARG:NH2	1:A:414:GLN:OE1	2.51	0.44
1:A:722:VAL:O	1:A:934:ILE:HD11	2.17	0.44
1:A:747:THR:O	1:A:750:SER:OG	2.28	0.44
2:D:33:LEU:HD21	2:D:88:CYS:HB2	1.99	0.44
3:I:51:ILE:HB	3:I:70:ILE:HD12	1.98	0.44
1:A:231:ILE:HG22	1:A:233:ILE:HG23	2.00	0.44
1:B:57:PRO:HB3	1:B:273:ARG:NH1	2.32	0.44
3:E:65:LYS:HB3	3:E:65:LYS:HE3	1.90	0.44
3:G:62:ASP:HA	3:G:65:LYS:HG3	2.00	0.44
1:B:377:PHE:HD1	1:B:434:ILE:HG12	1.82	0.44
1:C:316:SER:OG	1:C:317:ASN:N	2.51	0.44
3:E:32:TYR:O	3:E:72:ARG:NH1	2.42	0.44
1:C:99:ASN:HB3	1:C:102:ARG:NH2	2.32	0.44
1:C:403:ARG:HD2	1:C:505:HIS:HA	1.99	0.44
1:A:312:ILE:HB	1:A:598:ILE:HG22	1.99	0.44
1:B:159:VAL:HG23	1:B:160:TYR:CD1	2.53	0.44
1:C:982:SER:OG	1:C:983:ARG:NH2	2.51	0.44
1:C:1102:TRP:HB2	1:C:1135:ASN:ND2	2.33	0.44
2:D:33:LEU:HD13	2:D:71:PHE:CD2	2.53	0.43
3:E:52:SER:OG	3:E:53:TRP:N	2.50	0.43
3:G:20:LEU:HD13	3:G:81:LEU:HD23	2.00	0.43
1:A:21:ARG:HG2	1:A:79:PHE:HB2	1.99	0.43
1:A:438:SER:HB2	1:A:509:ARG:HG3	2.00	0.43
1:A:878:LEU:HD11	1:A:1054:GLN:HE22	1.82	0.43
1:B:190:ARG:HB3	1:B:192:PHE:CE1	2.53	0.43
1:B:377:PHE:HE2	1:B:384:PRO:HB3	1.83	0.43
1:B:440:LYS:HA	3:G:107:PRO:HB2	1.99	0.43
1:B:878:LEU:HD11	1:B:1054:GLN:HE22	1.83	0.43
1:A:500:THR:HB	2:D:92:TYR:CE1	2.52	0.43
1:A:904:TYR:CE2	1:B:1107:ARG:HG2	2.53	0.43
1:C:477:ASN:OD1	1:C:478:LYS:N	2.51	0.43
2:D:36:PHE:CZ	2:D:46:LEU:HD12	2.53	0.43
1:A:117:LEU:HD12	1:A:231:ILE:HG21	1.99	0.43
1:A:287:ASP:OD1	1:A:288:ALA:N	2.52	0.43
2:H:49:TYR:HE1	2:H:55:GLN:HA	1.84	0.43
1:A:41:LYS:NZ	1:A:225:PRO:HG2	2.33	0.43
1:A:742:ILE:O	1:A:1000:ARG:NH1	2.41	0.43
1:B:433:VAL:HG12	1:B:512:VAL:HG13	1.99	0.43

Continued on next page...

Continued from previous page...

Atom-1	Atom-2	Interatomic distance (Å)	Clash overlap (Å)
1:C:102:ARG:HG3	1:C:243:ALA:HB2	2.00	0.43
1:C:726:ILE:HG13	1:C:1061:VAL:HG22	1.99	0.43
1:B:220:PHE:HE2	1:B:285:ILE:HG22	1.84	0.43
1:C:821:LEU:HD11	1:C:939:SER:HB3	1.99	0.43
1:C:856:LYS:HE3	1:C:856:LYS:HB2	1.87	0.43
3:G:99:ASP:HA	3:G:110:PHE:HA	2.00	0.43
1:A:338:PHE:O	1:A:342:PHE:HB2	2.19	0.43
1:A:389:ASP:HB3	1:A:528:LYS:CE	2.48	0.43
1:A:462:LYS:O	1:A:465:GLU:HG2	2.18	0.43
1:A:542:ASN:HA	1:A:547:LYS:HA	2.01	0.43
1:B:102:ARG:NH2	1:B:121:ASN:O	2.52	0.43
1:B:983:ARG:HG2	1:C:382:VAL:HG22	2.01	0.43
2:H:7:SER:HB3	2:H:8:PRO:HD3	2.01	0.43
1:A:63:THR:O	1:A:266:TYR:HA	2.18	0.43
1:A:101:ILE:HD12	1:A:241:LEU:O	2.18	0.43
2:F:36:PHE:CZ	2:F:46:LEU:HD12	2.53	0.43
1:A:393:THR:HA	1:A:522:ALA:HA	2.01	0.43
1:A:902:MET:HB2	1:A:902:MET:HE2	1.56	0.43
1:A:1097:SER:HB2	1:A:1102:TRP:CD2	2.53	0.43
3:E:32:TYR:HE2	3:E:98:LYS:HZ3	1.66	0.43
1:A:351:TYR:HE1	1:A:452:LEU:HB2	1.84	0.42
1:A:730:SER:O	1:A:1058:HIS:HB3	2.18	0.42
1:B:96:GLU:OE1	1:B:100:ILE:HG22	2.19	0.42
2:D:49:TYR:O	2:D:53:SER:HB2	2.19	0.42
1:A:36:VAL:HG11	1:A:220:PHE:CZ	2.53	0.42
1:A:277:LEU:HD12	1:A:285:ILE:HD13	2.01	0.42
1:B:854:LYS:HZ3	1:B:959:LEU:HD13	1.84	0.42
1:C:409:GLN:HA	1:C:414:GLN:HG2	2.01	0.42
1:C:502:GLY:O	1:C:506:GLN:HG3	2.19	0.42
3:E:19:ARG:NH1	3:E:80:TYR:HD1	2.17	0.42
2:H:6:GLN:NE2	2:H:23:CYS:SG	2.87	0.42
3:I:67:ARG:O	3:I:84:ASN:HB2	2.19	0.42
1:A:458:LYS:HD2	1:A:473:TYR:HD1	1.84	0.42
1:B:117:LEU:HD21	1:B:119:ILE:HD11	2.02	0.42
1:B:372:ALA:N	1:B:373:PRO:HD2	2.34	0.42
3:G:38:ARG:HD3	3:G:94:TYR:CZ	2.55	0.42
1:A:190:ARG:HG2	1:A:207:HIS:ND1	2.34	0.42
1:A:1086:LYS:HB2	1:A:1086:LYS:HE2	1.88	0.42
1:A:102:ARG:HA	1:A:102:ARG:HD2	1.81	0.42
2:F:38:HIS:HB2	2:F:44:PRO:HB3	2.01	0.42
2:F:39:LYS:NZ	2:F:81:GLU:O	2.42	0.42

Continued on next page...

Continued from previous page...

Atom-1	Atom-2	Interatomic distance (Å)	Clash overlap (Å)
2:D:34:ASN:OD1	3:E:109:SER:OG	2.23	0.42
1:A:318:PHE:HD1	1:A:595:VAL:HG23	1.84	0.42
1:B:436:TRP:CE2	1:B:509:ARG:HB2	2.54	0.42
1:C:310:LYS:HG3	1:C:600:PRO:HA	2.01	0.42
2:D:2:ILE:HG22	2:D:95:PRO:HG2	2.01	0.42
2:D:93:SER:OG	2:D:95:PRO:HD2	2.20	0.42
3:G:19:ARG:HH21	3:G:80:TYR:HB3	1.85	0.42
1:A:715:PRO:HA	1:A:1072:GLU:HA	2.02	0.42
1:B:1107:ARG:H	1:B:1107:ARG:HD2	1.84	0.42
1:A:368:LEU:HD13	1:A:374:PHE:CE2	2.55	0.42
1:A:856:LYS:HD2	1:B:572:THR:HG21	2.01	0.42
2:D:95:PRO:HA	2:D:96:PRO:HD3	1.88	0.42
3:E:39:GLN:O	3:E:92:ALA:HB1	2.20	0.42
2:H:81:GLU:OE2	2:H:81:GLU:N	2.48	0.41
1:C:372:ALA:N	1:C:373:PRO:HD2	2.36	0.41
1:C:938:LEU:HD12	1:C:938:LEU:HA	1.91	0.41
1:C:1004:LEU:HD12	1:C:1004:LEU:HA	1.91	0.41
2:H:13:ALA:O	2:H:108:LYS:N	2.35	0.41
2:H:33:LEU:HD13	2:H:71:PHE:CD2	2.55	0.41
2:H:33:LEU:HD23	2:H:34:ASN:N	2.35	0.41
1:C:398:ASP:OD2	1:C:423:TYR:OH	2.30	0.41
1:C:426:PRO:HG2	1:C:429:PHE:HB2	2.01	0.41
1:C:753:LEU:HD22	1:C:759:PHE:HZ	1.85	0.41
2:F:29:ILE:HD11	2:F:33:LEU:HB2	2.03	0.41
2:F:49:TYR:O	2:F:53:SER:HB2	2.20	0.41
1:A:140:PHE:O	1:A:141:LEU:HD23	2.20	0.41
1:A:928:ASN:O	1:A:931:ILE:HG22	2.21	0.41
1:B:1086:LYS:HD2	1:B:1122:VAL:HG11	2.02	0.41
1:C:763:LEU:HD21	1:C:1005:GLN:OE1	2.20	0.41
3:I:19:ARG:NH1	3:I:80:TYR:HB3	2.36	0.41
1:A:569:ILE:HD12	1:A:569:ILE:H	1.85	0.41
1:B:280:ASN:ND2	1:B:282:ASN:HB2	2.35	0.41
1:C:709:ASN:HD22	5:C:1304:NAG:C7	2.33	0.41
3:I:39:GLN:O	3:I:92:ALA:HB1	2.21	0.41
1:C:99:ASN:HB3	1:C:102:ARG:HH21	1.85	0.41
1:C:981:PHE:HE1	1:C:993:ILE:HG13	1.85	0.41
1:A:393:THR:HG21	1:A:518:LEU:HB2	2.02	0.41
1:C:190:ARG:HB3	1:C:192:PHE:CE1	2.52	0.41
2:F:33:LEU:HD11	2:F:88:CYS:HB2	2.03	0.41
1:A:117:LEU:HD21	1:A:119:ILE:HD11	2.02	0.41
1:A:444:LYS:HA	3:E:105:LEU:O	2.21	0.41

Continued on next page...

Continued from previous page...

Atom-1	Atom-2	Interatomic distance (Å)	Clash overlap (Å)
1:B:418:ILE:HA	1:B:422:ASN:HD22	1.86	0.41
1:B:490:PHE:HB3	1:B:493:ARG:NH2	2.35	0.41
1:B:543:PHE:O	1:B:546:LEU:HB2	2.21	0.41
1:C:231:ILE:HG22	1:C:233:ILE:HG23	2.02	0.41
1:C:318:PHE:HD1	1:C:595:VAL:HG23	1.86	0.41
1:C:988:GLU:OE1	1:C:988:GLU:N	2.54	0.41
3:E:19:ARG:HH11	3:E:80:TYR:HD1	1.67	0.41
2:F:19:VAL:HG12	2:F:75:ILE:HB	2.03	0.41
3:G:2:VAL:HA	3:G:26:GLY:HA3	2.02	0.41
3:G:67:ARG:HD2	3:G:85:SER:HB2	2.03	0.41
1:A:1102:TRP:HB2	1:A:1135:ASN:ND2	2.35	0.41
1:B:365:TYR:HE2	1:B:515:PHE:CZ	2.39	0.41
1:A:246:ARG:HD3	1:A:258:TRP:HB3	2.03	0.40
1:B:1080:ALA:O	1:B:1132:ILE:HG13	2.22	0.40
1:C:328:ARG:HB2	1:C:543:PHE:CE1	2.56	0.40
1:C:334:ASN:O	1:C:362:VAL:HG12	2.21	0.40
1:C:431:GLY:HA2	1:C:515:PHE:CD2	2.56	0.40
2:D:8:PRO:HG2	2:D:21:ILE:HG23	2.03	0.40
2:F:33:LEU:HD21	2:F:88:CYS:HB2	2.03	0.40
3:G:52:SER:OG	3:G:53:TRP:N	2.54	0.40
2:H:35:TRP:HB2	2:H:48:ILE:HB	2.01	0.40
1:B:421:TYR:HB3	1:B:454:ARG:HG2	2.02	0.40
2:F:95:PRO:HA	2:F:96:PRO:HD3	1.85	0.40
1:A:569:ILE:HD13	1:C:854:LYS:HD2	2.03	0.40
1:B:310:LYS:HG3	1:B:600:PRO:HA	2.04	0.40
1:B:752:LEU:HD23	1:B:993:ILE:HG22	2.03	0.40
1:C:83:VAL:HA	1:C:239:GLN:OE1	2.21	0.40
1:C:452:LEU:HG	1:C:494:SER:HA	2.03	0.40
1:A:43:PHE:HA	1:B:563:GLN:NE2	2.37	0.40
1:A:350:VAL:HG12	1:A:422:ASN:HB3	2.03	0.40
1:B:722:VAL:O	1:B:934:ILE:HD11	2.21	0.40
3:E:58:ILE:HG13	3:E:70:ILE:HD11	2.03	0.40
1:A:41:LYS:HZ1	1:B:562:PHE:HB2	1.87	0.40
1:A:189:LEU:HB3	1:A:208:THR:OG1	2.21	0.40
1:B:541:PHE:CZ	1:B:548:GLY:HA3	2.57	0.40
1:C:131:CYS:HB2	1:C:133:PHE:CZ	2.57	0.40
2:H:4:MET:SD	2:H:4:MET:N	2.95	0.40
3:I:69:THR:CG2	3:I:82:GLN:HB3	2.52	0.40

There are no symmetry-related clashes.

5.3 Torsion angles [i](#)

5.3.1 Protein backbone [i](#)

In the following table, the Percentiles column shows the percent Ramachandran outliers of the chain as a percentile score with respect to all PDB entries followed by that with respect to all EM entries.

The Analysed column shows the number of residues for which the backbone conformation was analysed, and the total number of residues.

Mol	Chain	Analysed	Favoured	Allowed	Outliers	Percentiles	
1	A	1017/1205 (84%)	985 (97%)	31 (3%)	1 (0%)	51	83
1	B	1018/1205 (84%)	998 (98%)	20 (2%)	0	100	100
1	C	1018/1205 (84%)	994 (98%)	23 (2%)	1 (0%)	51	83
2	D	106/108 (98%)	100 (94%)	6 (6%)	0	100	100
2	F	106/108 (98%)	102 (96%)	4 (4%)	0	100	100
2	H	106/108 (98%)	103 (97%)	3 (3%)	0	100	100
3	E	121/123 (98%)	119 (98%)	2 (2%)	0	100	100
3	G	121/123 (98%)	119 (98%)	2 (2%)	0	100	100
3	I	121/123 (98%)	119 (98%)	2 (2%)	0	100	100
All	All	3734/4308 (87%)	3639 (98%)	93 (2%)	2 (0%)	54	83

All (2) Ramachandran outliers are listed below:

Mol	Chain	Res	Type
1	C	738	CYS
1	A	372	ALA

5.3.2 Protein sidechains [i](#)

In the following table, the Percentiles column shows the percent sidechain outliers of the chain as a percentile score with respect to all PDB entries followed by that with respect to all EM entries.

The Analysed column shows the number of residues for which the sidechain conformation was analysed, and the total number of residues.

Mol	Chain	Analysed	Rotameric	Outliers	Percentiles	
1	A	907/1056 (86%)	907 (100%)	0	100	100
1	B	910/1056 (86%)	909 (100%)	1 (0%)	93	98

Continued on next page...

Continued from previous page...

Mol	Chain	Analysed	Rotameric	Outliers	Percentiles	
1	C	909/1056 (86%)	908 (100%)	1 (0%)	93	98
2	D	93/94 (99%)	93 (100%)	0	100	100
2	F	93/94 (99%)	93 (100%)	0	100	100
2	H	93/94 (99%)	93 (100%)	0	100	100
3	E	101/101 (100%)	101 (100%)	0	100	100
3	G	101/101 (100%)	101 (100%)	0	100	100
3	I	101/101 (100%)	101 (100%)	0	100	100
All	All	3308/3753 (88%)	3306 (100%)	2 (0%)	93	98

All (2) residues with a non-rotameric sidechain are listed below:

Mol	Chain	Res	Type
1	B	738	CYS
1	C	738	CYS

Sometimes sidechains can be flipped to improve hydrogen bonding and reduce clashes. All (7) such sidechains are listed below:

Mol	Chain	Res	Type
1	A	115	GLN
1	A	422	ASN
1	A	450	ASN
1	A	505	HIS
1	A	955	ASN
1	C	978	ASN
3	I	35	HIS

5.3.3 RNA [i](#)

There are no RNA molecules in this entry.

5.4 Non-standard residues in protein, DNA, RNA chains [i](#)

There are no non-standard protein/DNA/RNA residues in this entry.

5.5 Carbohydrates [i](#)

28 monosaccharides are modelled in this entry.

In the following table, the Counts columns list the number of bonds (or angles) for which Mogul statistics could be retrieved, the number of bonds (or angles) that are observed in the model and the number of bonds (or angles) that are defined in the Chemical Component Dictionary. The Link column lists molecule types, if any, to which the group is linked. The Z score for a bond length (or angle) is the number of standard deviations the observed value is removed from the expected value. A bond length (or angle) with $|Z| > 2$ is considered an outlier worth inspection. RMSZ is the root-mean-square of all Z scores of the bond lengths (or angles).

Mol	Type	Chain	Res	Link	Bond lengths			Bond angles		
					Counts	RMSZ	$\# Z > 2$	Counts	RMSZ	$\# Z > 2$
4	NAG	J	1	1,4	14,14,15	0.19	0	17,19,21	0.65	0
4	NAG	J	2	4	14,14,15	0.24	0	17,19,21	0.41	0
4	NAG	K	1	1,4	14,14,15	0.36	0	17,19,21	0.57	0
4	NAG	K	2	4	14,14,15	0.25	0	17,19,21	0.40	0
4	NAG	L	1	1,4	14,14,15	0.26	0	17,19,21	0.42	0
4	NAG	L	2	4	14,14,15	0.23	0	17,19,21	0.40	0
4	NAG	M	1	1,4	14,14,15	0.14	0	17,19,21	0.42	0
4	NAG	M	2	4	14,14,15	0.24	0	17,19,21	0.47	0
4	NAG	N	1	1,4	14,14,15	0.23	0	17,19,21	0.45	0
4	NAG	N	2	4	14,14,15	0.21	0	17,19,21	0.39	0
4	NAG	O	1	1,4	14,14,15	0.48	0	17,19,21	0.55	0
4	NAG	O	2	4	14,14,15	0.19	0	17,19,21	0.42	0
4	NAG	P	1	1,4	14,14,15	0.23	0	17,19,21	0.56	0
4	NAG	P	2	4	14,14,15	0.23	0	17,19,21	0.42	0
4	NAG	Q	1	1,4	14,14,15	0.55	0	17,19,21	0.71	0
4	NAG	Q	2	4	14,14,15	0.20	0	17,19,21	0.49	0
4	NAG	R	1	1,4	14,14,15	0.59	0	17,19,21	0.90	1 (5%)
4	NAG	R	2	4	14,14,15	0.21	0	17,19,21	0.50	0
4	NAG	S	1	1,4	14,14,15	0.69	1 (7%)	17,19,21	0.78	1 (5%)
4	NAG	S	2	4	14,14,15	0.23	0	17,19,21	0.58	0
4	NAG	T	1	1,4	14,14,15	0.29	0	17,19,21	0.45	0
4	NAG	T	2	4	14,14,15	0.30	0	17,19,21	0.41	0
4	NAG	U	1	1,4	14,14,15	0.50	0	17,19,21	0.63	0
4	NAG	U	2	4	14,14,15	0.25	0	17,19,21	0.55	0
4	NAG	V	1	1,4	14,14,15	0.31	0	17,19,21	0.61	0
4	NAG	V	2	4	14,14,15	0.28	0	17,19,21	0.45	0
4	NAG	W	1	1,4	14,14,15	0.19	0	17,19,21	0.43	0
4	NAG	W	2	4	14,14,15	0.23	0	17,19,21	0.41	0

In the following table, the Chirals column lists the number of chiral outliers, the number of chiral centers analysed, the number of these observed in the model and the number defined in the Chemical Component Dictionary. Similar counts are reported in the Torsion and Rings columns. '-' means no outliers of that kind were identified.

Mol	Type	Chain	Res	Link	Chirals	Torsions	Rings
4	NAG	J	1	1,4	-	3/6/23/26	0/1/1/1
4	NAG	J	2	4	-	2/6/23/26	0/1/1/1
4	NAG	K	1	1,4	-	2/6/23/26	0/1/1/1
4	NAG	K	2	4	-	2/6/23/26	0/1/1/1
4	NAG	L	1	1,4	-	0/6/23/26	0/1/1/1
4	NAG	L	2	4	-	0/6/23/26	0/1/1/1
4	NAG	M	1	1,4	-	0/6/23/26	0/1/1/1
4	NAG	M	2	4	-	0/6/23/26	0/1/1/1
4	NAG	N	1	1,4	-	2/6/23/26	0/1/1/1
4	NAG	N	2	4	-	2/6/23/26	0/1/1/1
4	NAG	O	1	1,4	-	2/6/23/26	0/1/1/1
4	NAG	O	2	4	-	0/6/23/26	0/1/1/1
4	NAG	P	1	1,4	-	3/6/23/26	0/1/1/1
4	NAG	P	2	4	-	2/6/23/26	0/1/1/1
4	NAG	Q	1	1,4	-	0/6/23/26	0/1/1/1
4	NAG	Q	2	4	-	2/6/23/26	0/1/1/1
4	NAG	R	1	1,4	-	2/6/23/26	0/1/1/1
4	NAG	R	2	4	-	2/6/23/26	0/1/1/1
4	NAG	S	1	1,4	-	1/6/23/26	0/1/1/1
4	NAG	S	2	4	-	2/6/23/26	0/1/1/1
4	NAG	T	1	1,4	-	2/6/23/26	0/1/1/1
4	NAG	T	2	4	-	0/6/23/26	0/1/1/1
4	NAG	U	1	1,4	-	3/6/23/26	0/1/1/1
4	NAG	U	2	4	-	2/6/23/26	0/1/1/1
4	NAG	V	1	1,4	-	2/6/23/26	0/1/1/1
4	NAG	V	2	4	-	2/6/23/26	0/1/1/1
4	NAG	W	1	1,4	-	2/6/23/26	0/1/1/1
4	NAG	W	2	4	-	0/6/23/26	0/1/1/1

All (1) bond length outliers are listed below:

Mol	Chain	Res	Type	Atoms	Z	Observed(Å)	Ideal(Å)
4	S	1	NAG	C1-C2	2.27	1.55	1.52

All (2) bond angle outliers are listed below:

Mol	Chain	Res	Type	Atoms	Z	Observed(°)	Ideal(°)
4	R	1	NAG	C1-O5-C5	3.15	116.45	112.19
4	S	1	NAG	C1-O5-C5	2.73	115.89	112.19

There are no chirality outliers.

All (42) torsion outliers are listed below:

Mol	Chain	Res	Type	Atoms
4	N	2	NAG	O5-C5-C6-O6
4	O	1	NAG	O5-C5-C6-O6
4	J	1	NAG	O5-C5-C6-O6
4	K	2	NAG	C4-C5-C6-O6
4	V	2	NAG	C4-C5-C6-O6
4	Q	2	NAG	C4-C5-C6-O6
4	P	2	NAG	O5-C5-C6-O6
4	W	1	NAG	O5-C5-C6-O6
4	P	1	NAG	O5-C5-C6-O6
4	T	1	NAG	O5-C5-C6-O6
4	U	1	NAG	O5-C5-C6-O6
4	O	1	NAG	C4-C5-C6-O6
4	N	2	NAG	C4-C5-C6-O6
4	P	2	NAG	C4-C5-C6-O6
4	K	1	NAG	O5-C5-C6-O6
4	N	1	NAG	O5-C5-C6-O6
4	P	1	NAG	C4-C5-C6-O6
4	U	1	NAG	C4-C5-C6-O6
4	J	1	NAG	C4-C5-C6-O6
4	K	1	NAG	C4-C5-C6-O6
4	T	1	NAG	C4-C5-C6-O6
4	K	2	NAG	O5-C5-C6-O6
4	V	2	NAG	O5-C5-C6-O6
4	N	1	NAG	C4-C5-C6-O6
4	W	1	NAG	C4-C5-C6-O6
4	Q	2	NAG	O5-C5-C6-O6
4	J	2	NAG	O5-C5-C6-O6
4	S	2	NAG	O5-C5-C6-O6
4	S	2	NAG	C4-C5-C6-O6
4	J	2	NAG	C4-C5-C6-O6
4	U	2	NAG	C4-C5-C6-O6
4	U	2	NAG	O5-C5-C6-O6
4	R	1	NAG	C4-C5-C6-O6
4	V	1	NAG	C4-C5-C6-O6
4	R	1	NAG	O5-C5-C6-O6
4	R	2	NAG	C4-C5-C6-O6
4	S	1	NAG	C1-C2-N2-C7
4	J	1	NAG	C3-C2-N2-C7
4	P	1	NAG	C3-C2-N2-C7
4	U	1	NAG	C3-C2-N2-C7

Continued on next page...

Continued from previous page...

Mol	Chain	Res	Type	Atoms
4	V	1	NAG	O5-C5-C6-O6
4	R	2	NAG	O5-C5-C6-O6

There are no ring outliers.

5 monomers are involved in 6 short contacts:

Mol	Chain	Res	Type	Clashes	Symm-Clashes
4	R	1	NAG	1	0
4	O	1	NAG	1	0
4	V	1	NAG	2	0
4	S	1	NAG	1	0
4	Q	1	NAG	1	0

The following is a two-dimensional graphical depiction of Mogul quality analysis of bond lengths, bond angles, torsion angles, and ring geometry for oligosaccharide.

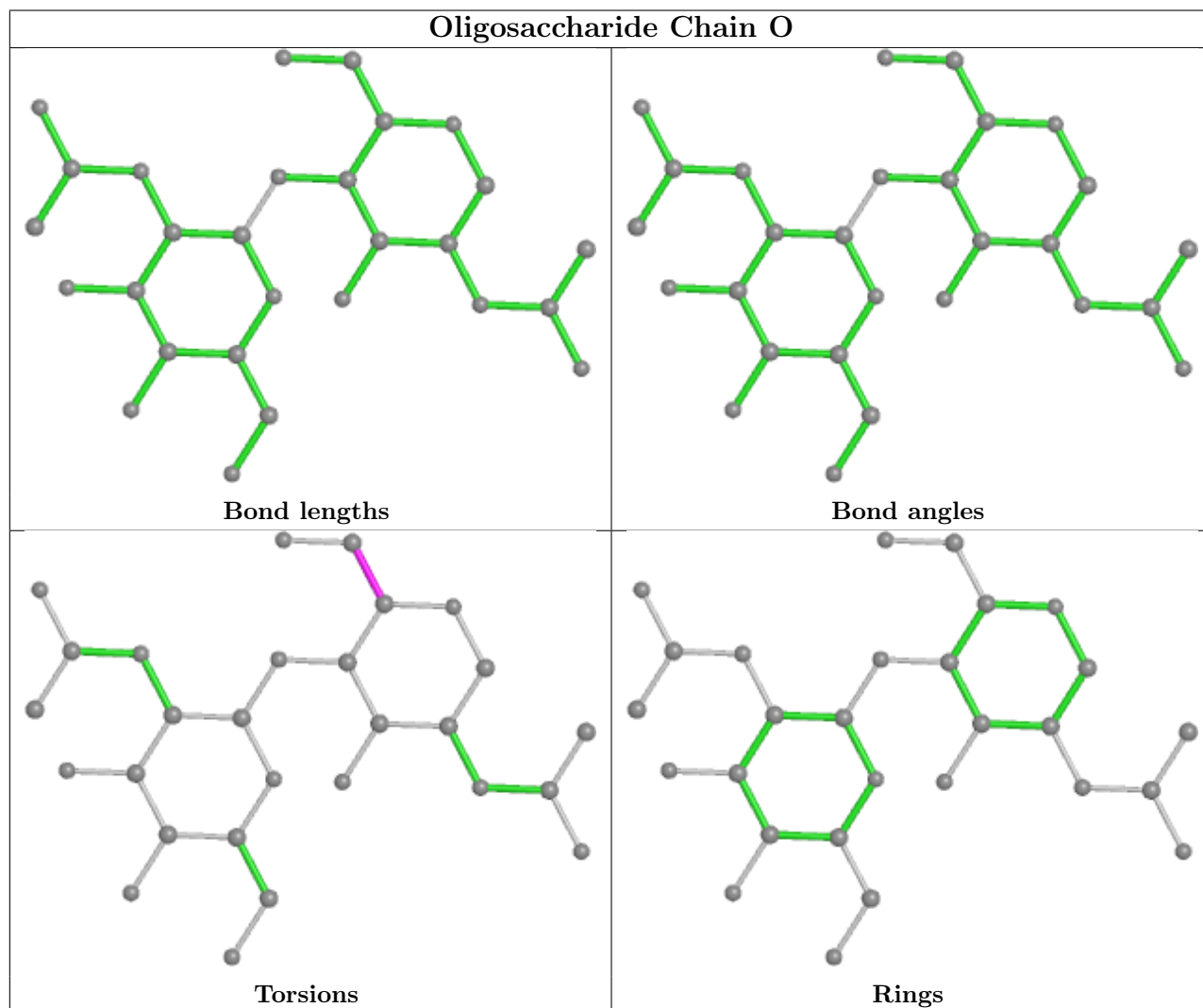

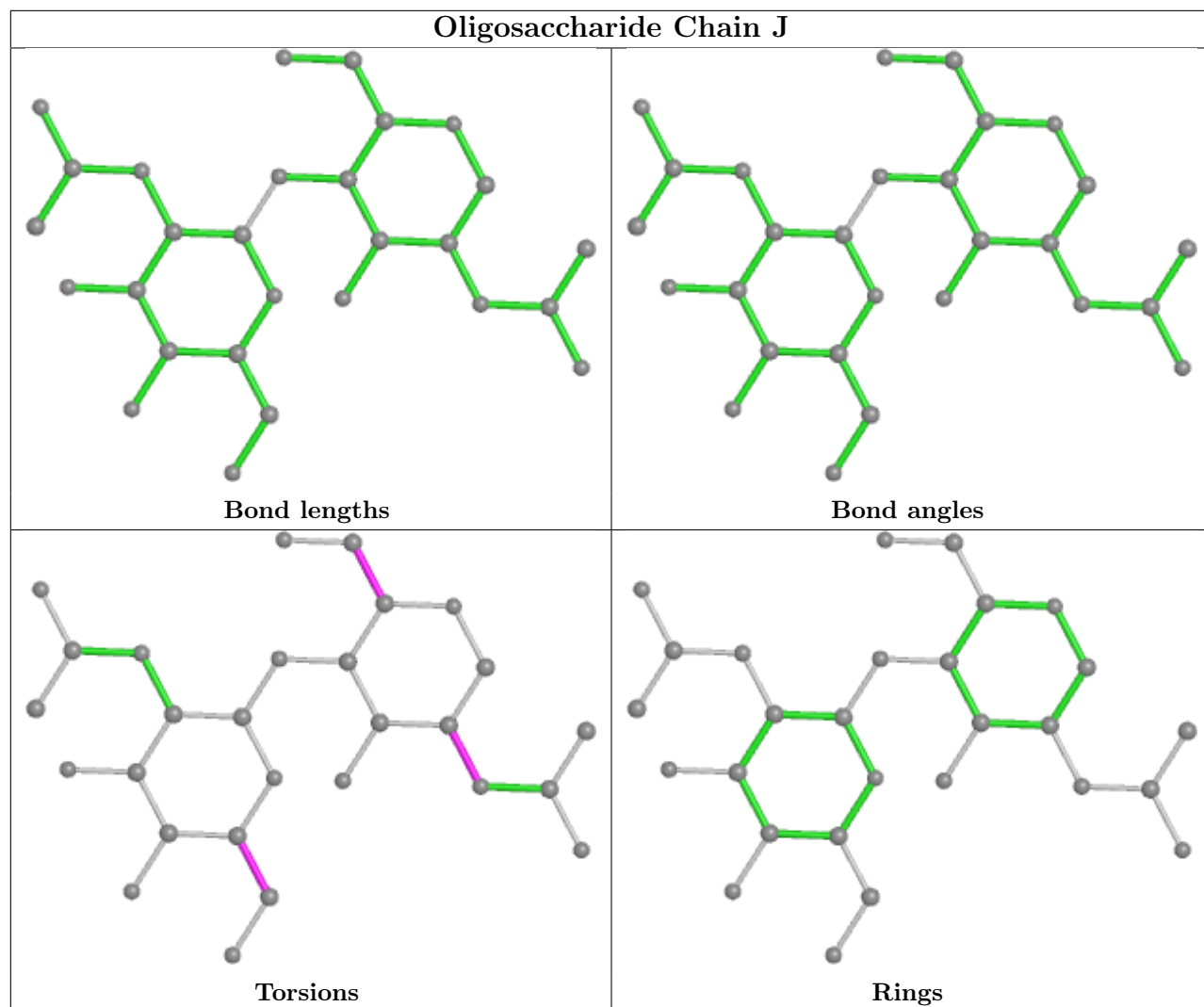

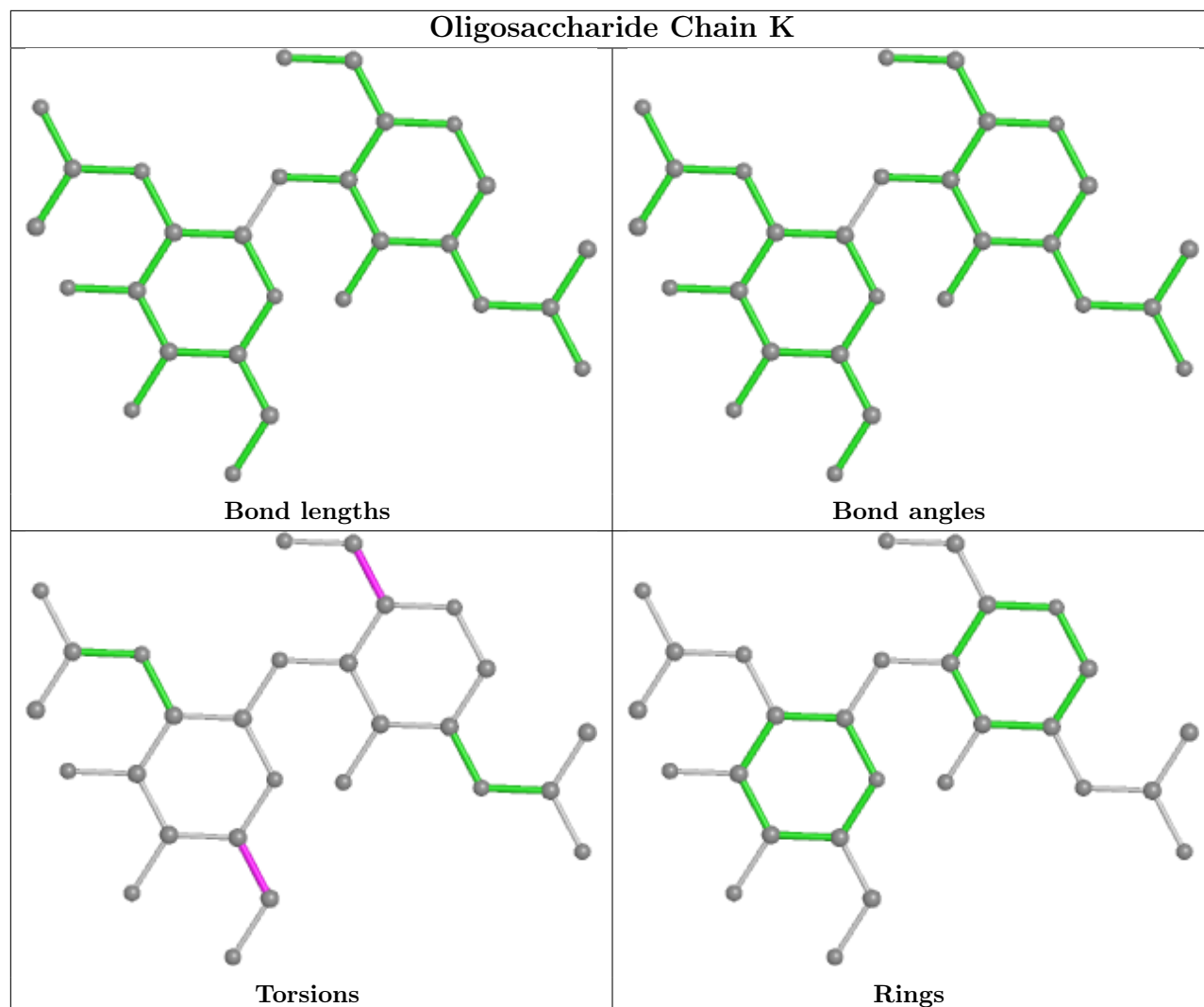

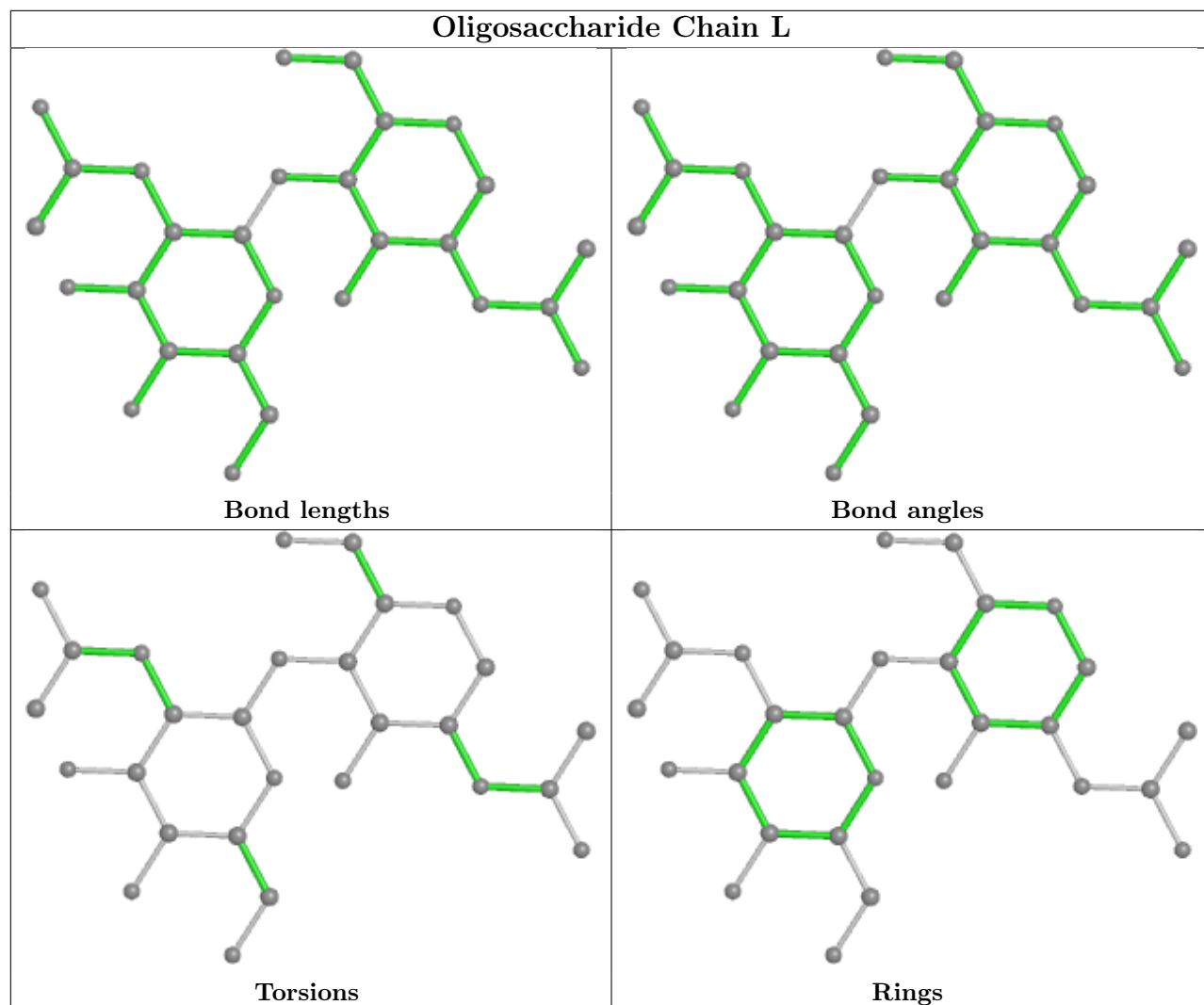

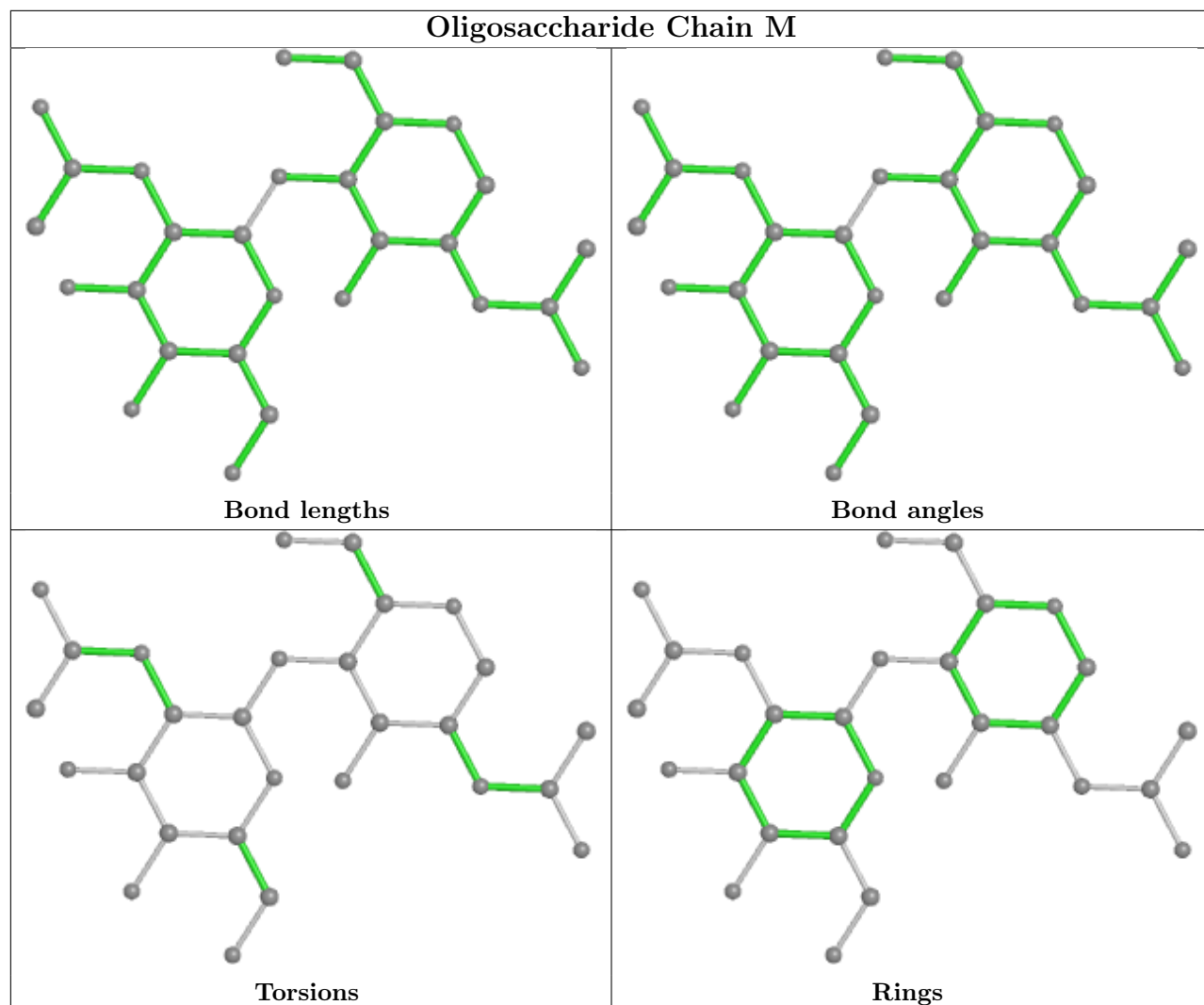

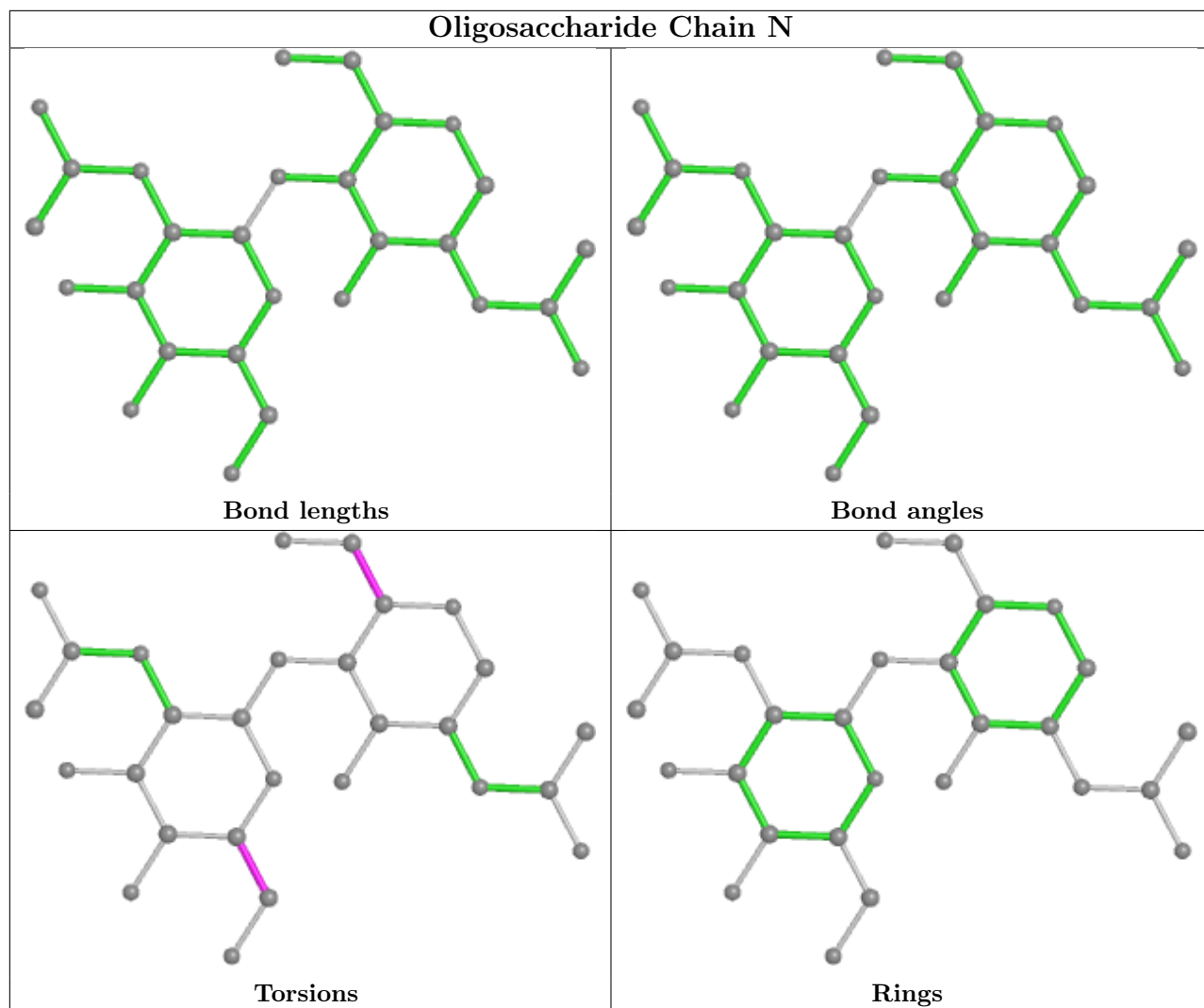

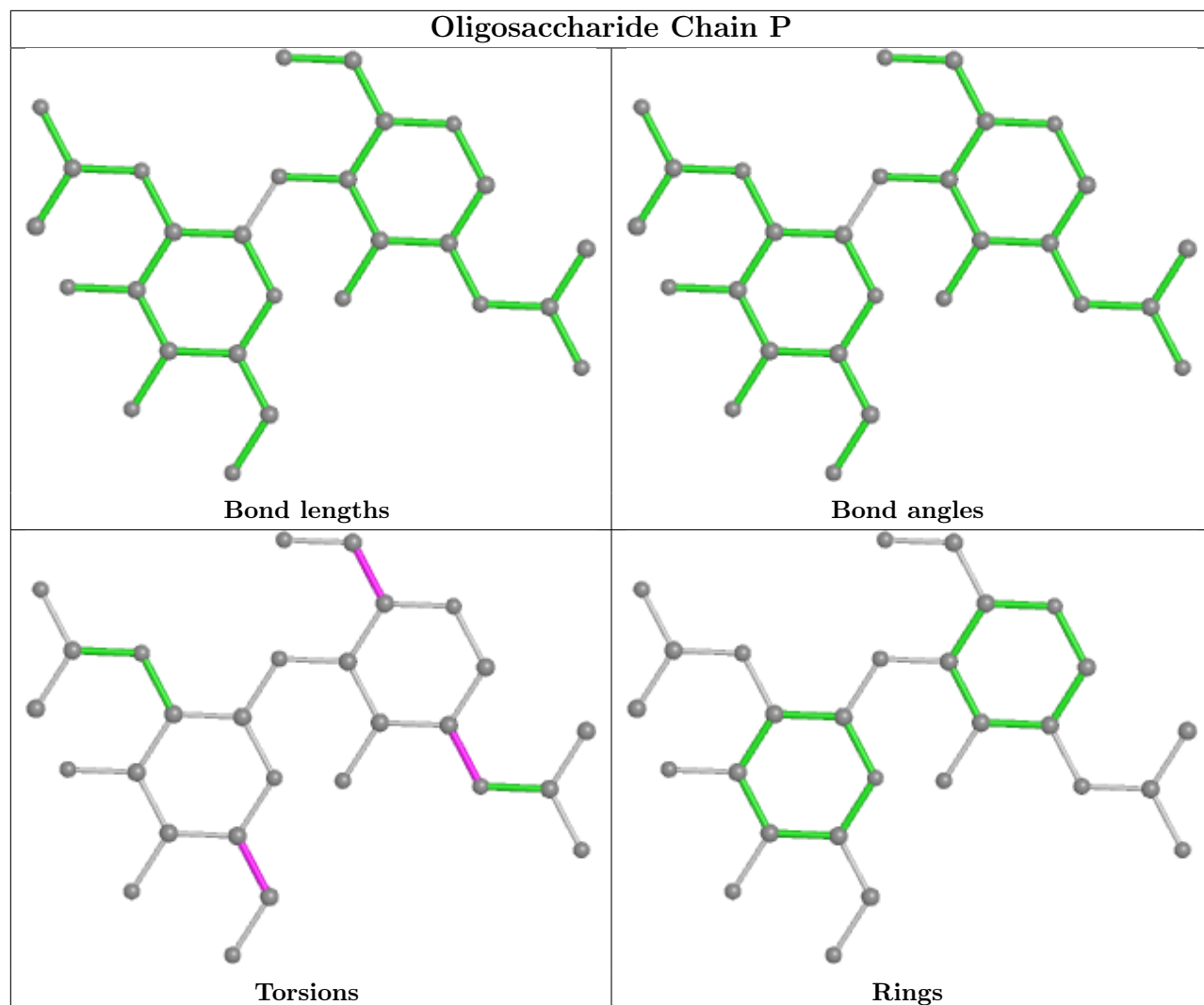

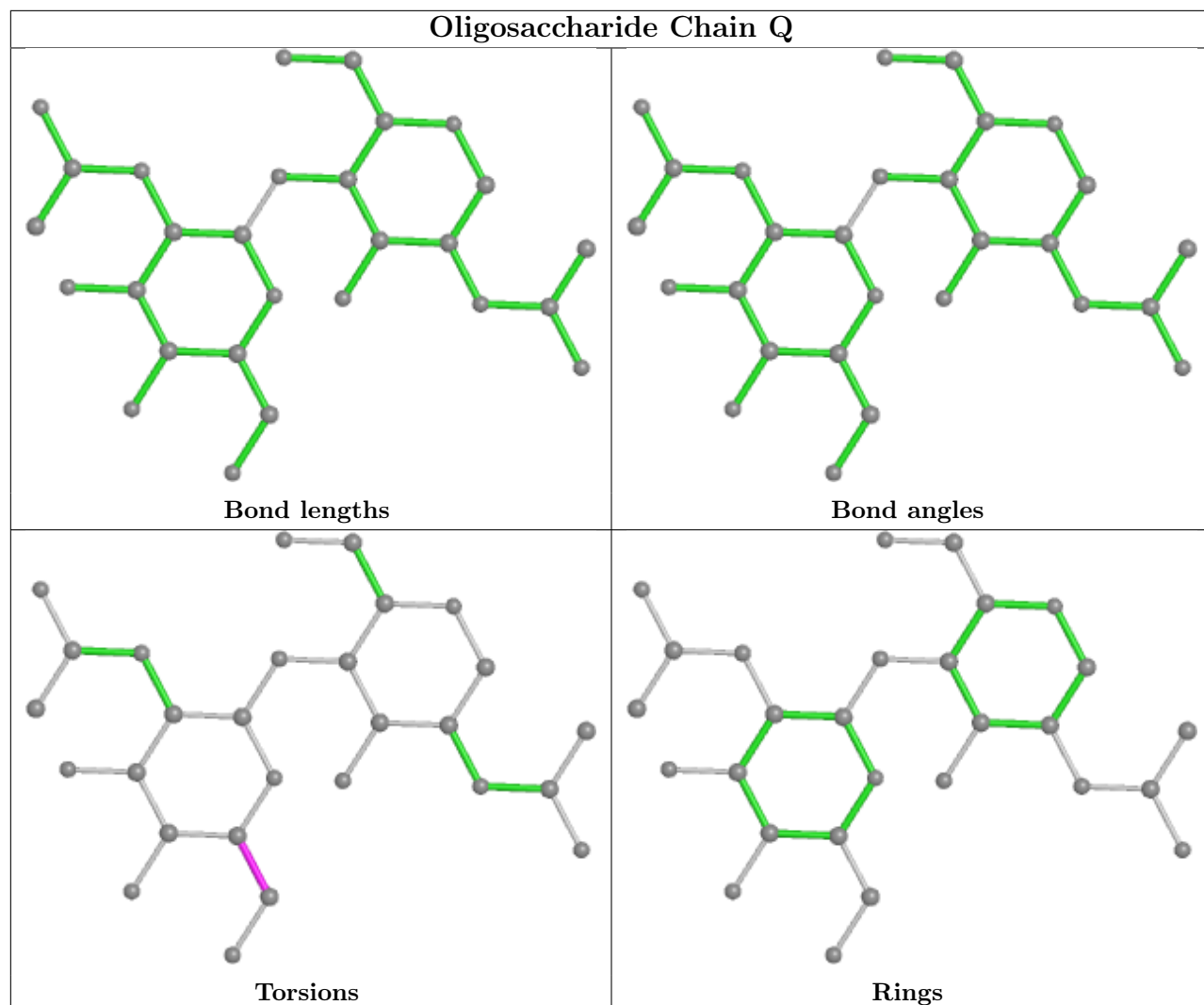

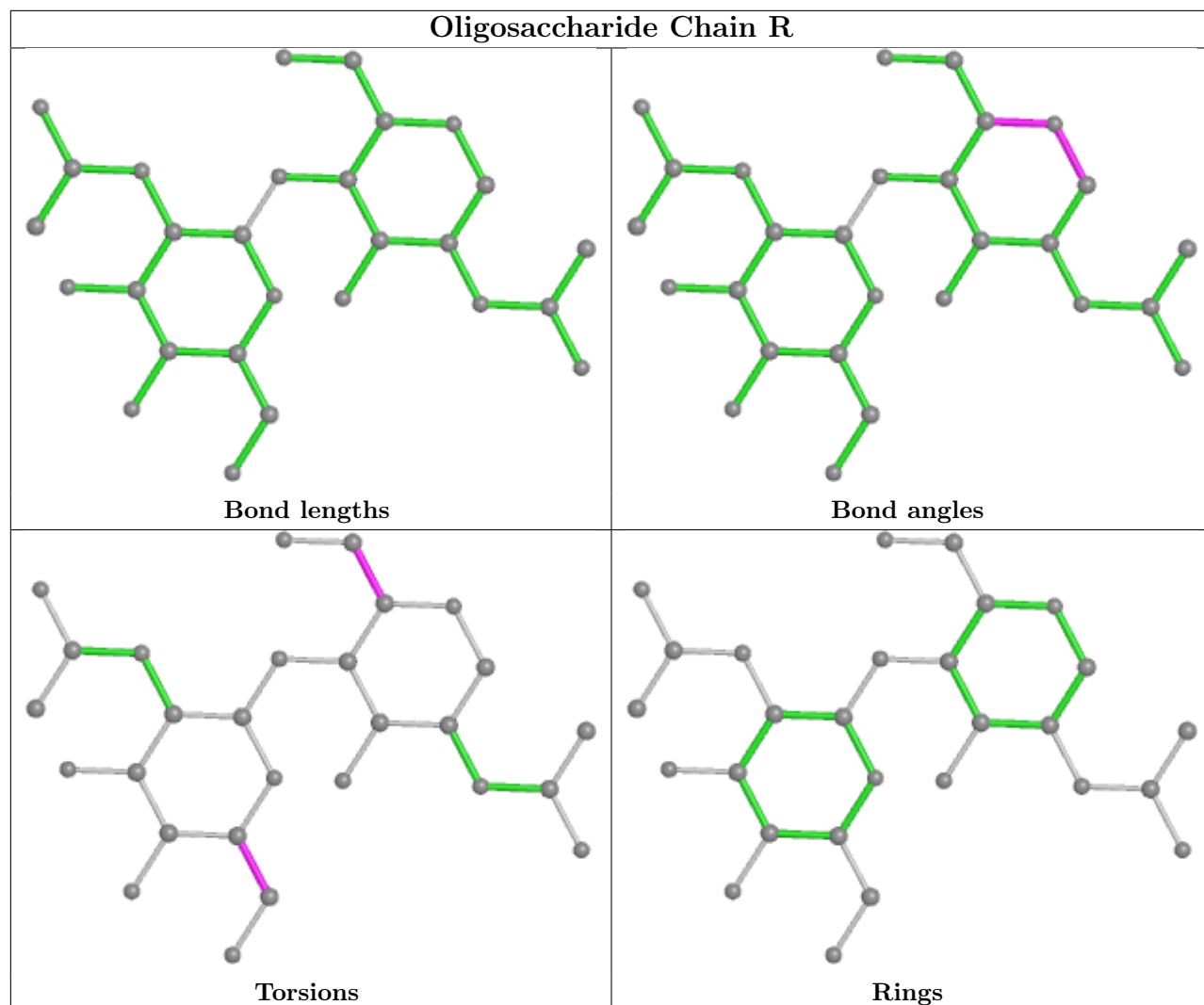

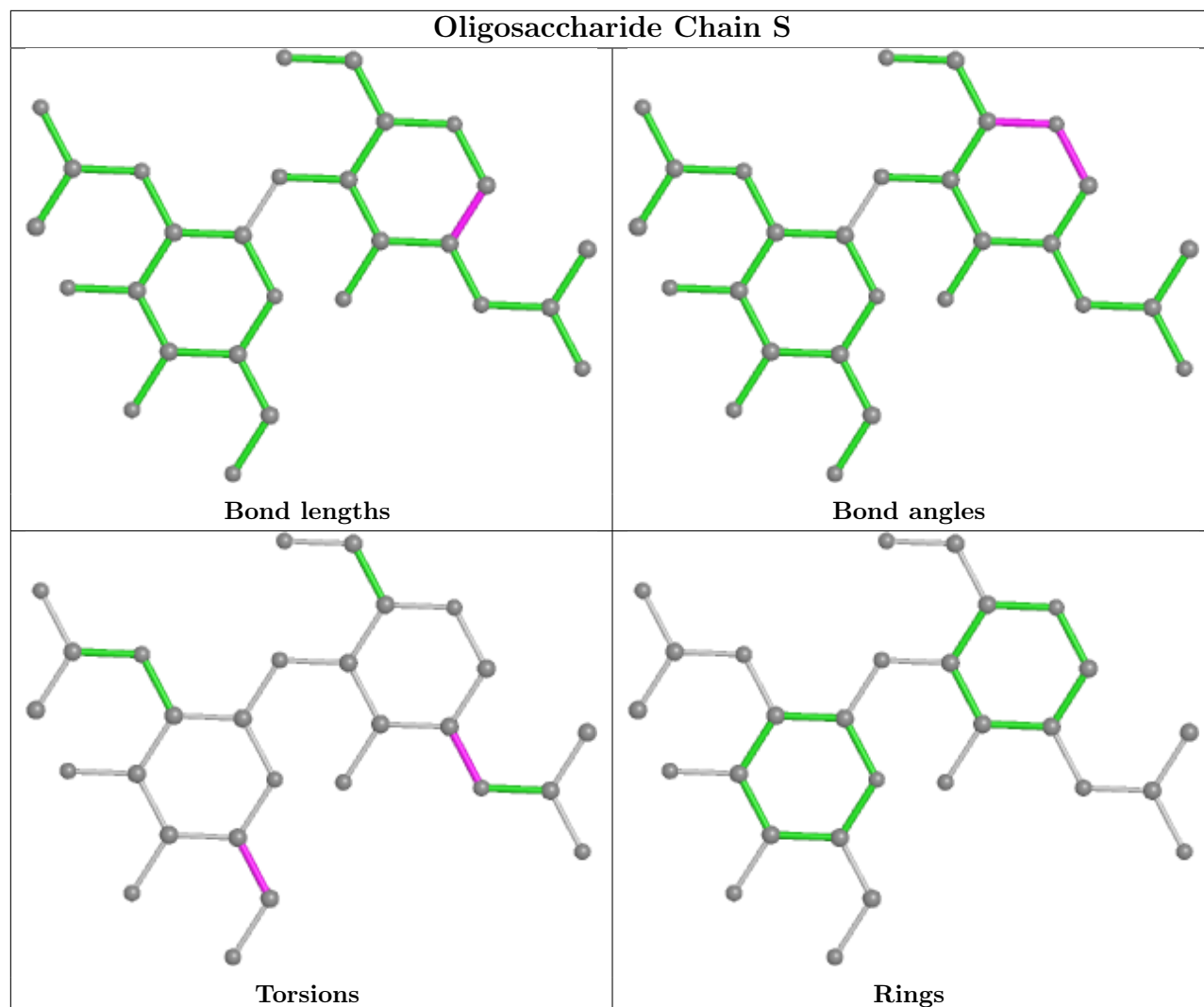

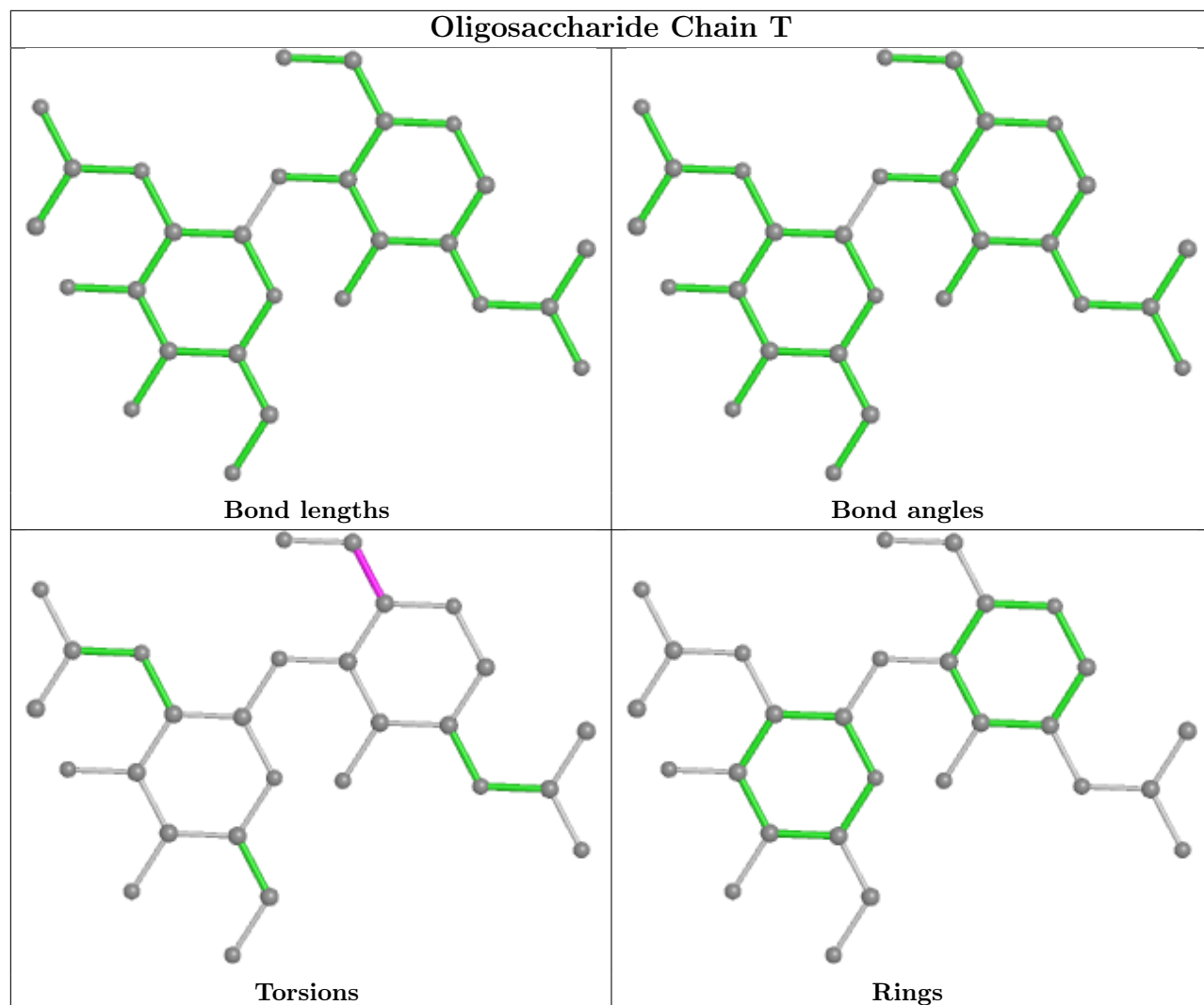

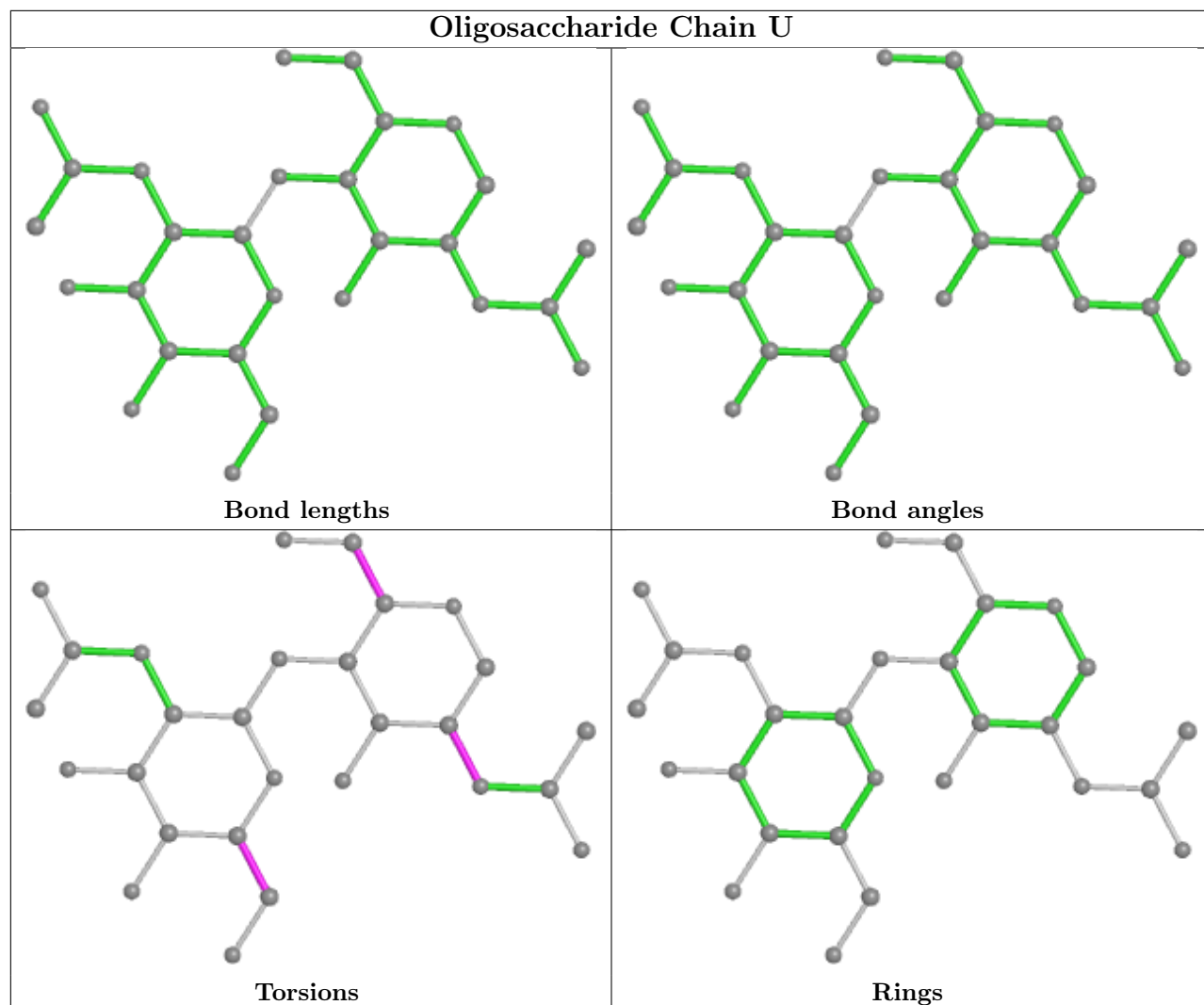

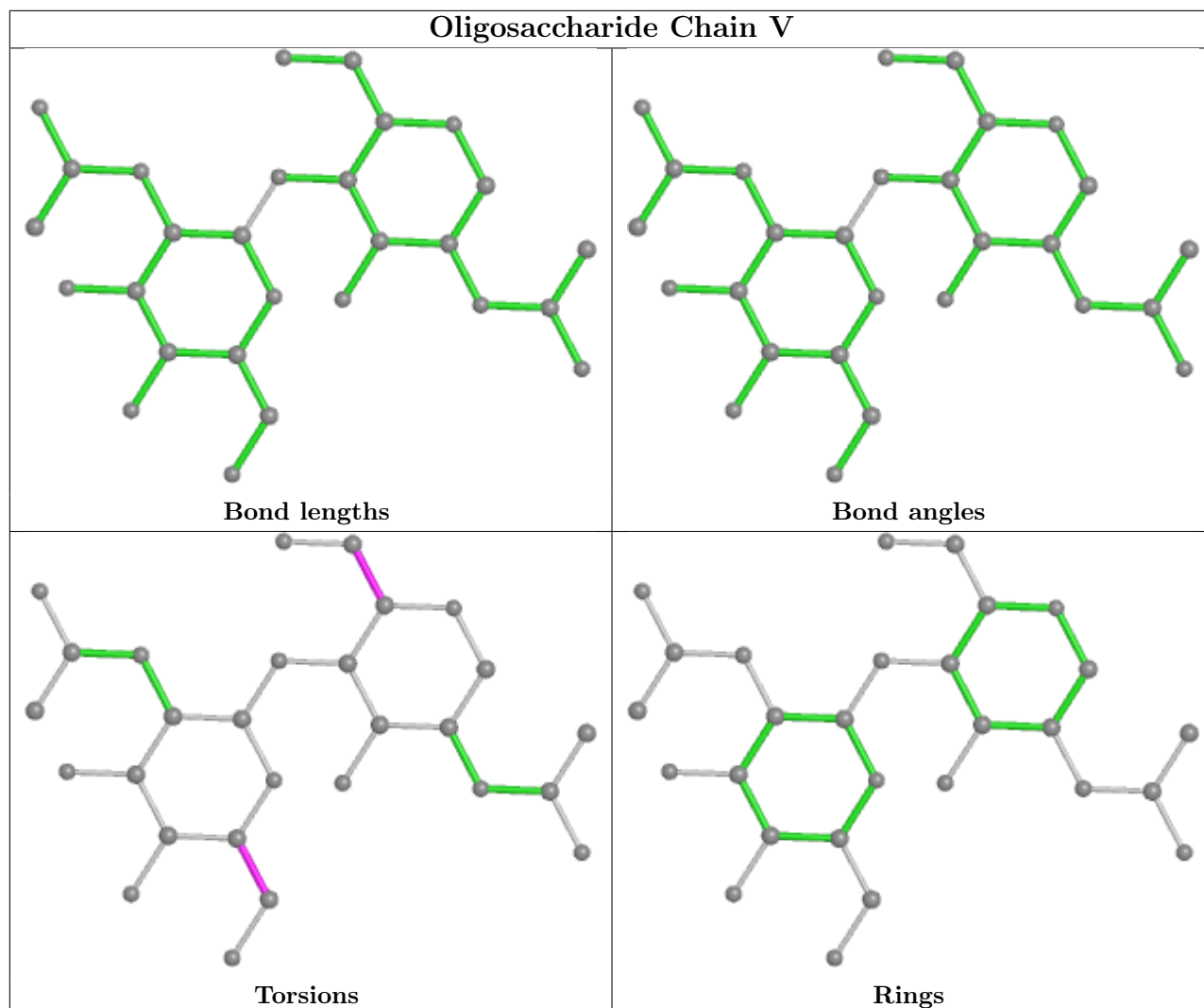

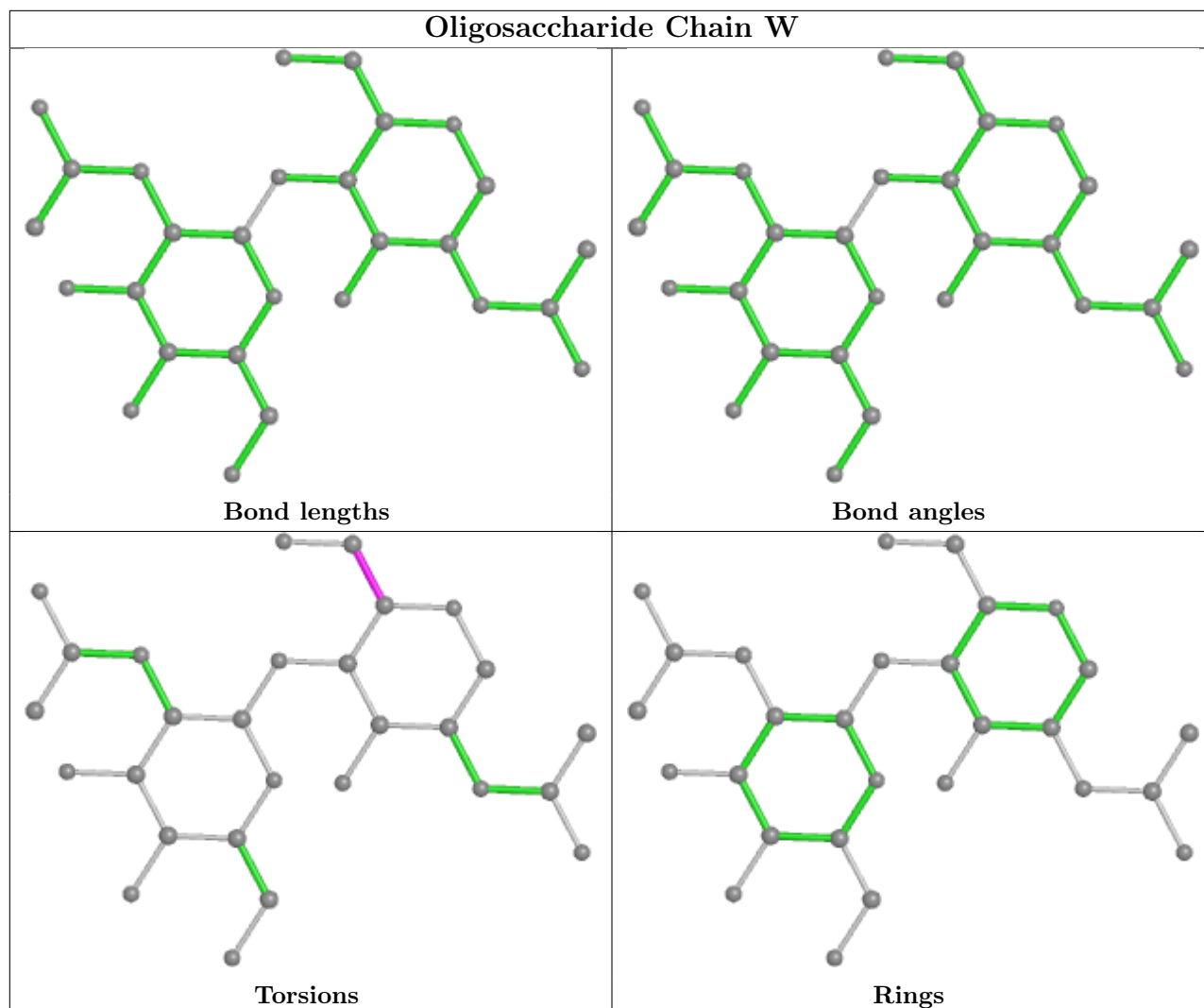

5.6 Ligand geometry [i](#)

10 ligands are modelled in this entry.

In the following table, the Counts columns list the number of bonds (or angles) for which Mogul statistics could be retrieved, the number of bonds (or angles) that are observed in the model and the number of bonds (or angles) that are defined in the Chemical Component Dictionary. The Link column lists molecule types, if any, to which the group is linked. The Z score for a bond length (or angle) is the number of standard deviations the observed value is removed from the expected value. A bond length (or angle) with $|Z| > 2$ is considered an outlier worth inspection. RMSZ is the root-mean-square of all Z scores of the bond lengths (or angles).

Mol	Type	Chain	Res	Link	Bond lengths			Bond angles		
					Counts	RMSZ	$\# Z > 2$	Counts	RMSZ	$\# Z > 2$
5	NAG	C	1302	1	14,14,15	0.15	0	17,19,21	0.53	0
5	NAG	A	1301	1	14,14,15	0.48	0	17,19,21	0.48	0
5	NAG	A	1302	1	14,14,15	0.17	0	17,19,21	0.50	0
5	NAG	A	1303	1	14,14,15	0.29	0	17,19,21	0.36	0

Mol	Type	Chain	Res	Link	Bond lengths			Bond angles		
					Counts	RMSZ	# Z > 2	Counts	RMSZ	# Z > 2
5	NAG	B	1301	1	14,14,15	0.35	0	17,19,21	0.45	0
5	NAG	B	1302	1	14,14,15	0.28	0	17,19,21	0.47	0
5	NAG	C	1301	1	14,14,15	0.29	0	17,19,21	0.46	0
5	NAG	C	1304	1	14,14,15	0.36	0	17,19,21	0.65	1 (5%)
5	NAG	C	1303	1	14,14,15	0.23	0	17,19,21	0.31	0
5	NAG	B	1303	1	14,14,15	0.25	0	17,19,21	0.66	1 (5%)

In the following table, the Chirals column lists the number of chiral outliers, the number of chiral centers analysed, the number of these observed in the model and the number defined in the Chemical Component Dictionary. Similar counts are reported in the Torsion and Rings columns. '-' means no outliers of that kind were identified.

Mol	Type	Chain	Res	Link	Chirals	Torsions	Rings
5	NAG	C	1302	1	-	2/6/23/26	0/1/1/1
5	NAG	A	1301	1	-	1/6/23/26	0/1/1/1
5	NAG	A	1302	1	-	2/6/23/26	0/1/1/1
5	NAG	A	1303	1	-	2/6/23/26	0/1/1/1
5	NAG	B	1301	1	-	0/6/23/26	0/1/1/1
5	NAG	B	1302	1	-	0/6/23/26	0/1/1/1
5	NAG	C	1301	1	-	2/6/23/26	0/1/1/1
5	NAG	C	1304	1	-	2/6/23/26	0/1/1/1
5	NAG	C	1303	1	-	2/6/23/26	0/1/1/1
5	NAG	B	1303	1	-	2/6/23/26	0/1/1/1

There are no bond length outliers.

All (2) bond angle outliers are listed below:

Mol	Chain	Res	Type	Atoms	Z	Observed(°)	Ideal(°)
5	C	1304	NAG	C1-O5-C5	2.23	115.21	112.19
5	B	1303	NAG	C1-O5-C5	2.07	114.99	112.19

There are no chirality outliers.

All (15) torsion outliers are listed below:

Mol	Chain	Res	Type	Atoms
5	C	1304	NAG	O5-C5-C6-O6
5	A	1302	NAG	O5-C5-C6-O6
5	C	1301	NAG	O5-C5-C6-O6
5	B	1303	NAG	O5-C5-C6-O6

Continued on next page...

Continued from previous page...

Mol	Chain	Res	Type	Atoms
5	C	1302	NAG	C4-C5-C6-O6
5	C	1304	NAG	C4-C5-C6-O6
5	B	1303	NAG	C4-C5-C6-O6
5	C	1301	NAG	C4-C5-C6-O6
5	A	1302	NAG	C4-C5-C6-O6
5	C	1302	NAG	O5-C5-C6-O6
5	C	1303	NAG	C4-C5-C6-O6
5	C	1303	NAG	O5-C5-C6-O6
5	A	1303	NAG	O5-C5-C6-O6
5	A	1301	NAG	C1-C2-N2-C7
5	A	1303	NAG	C4-C5-C6-O6

There are no ring outliers.

2 monomers are involved in 2 short contacts:

Mol	Chain	Res	Type	Clashes	Symm-Clashes
5	C	1304	NAG	1	0
5	B	1303	NAG	1	0

The following is a two-dimensional graphical depiction of Mogul quality analysis of bond lengths, bond angles, torsion angles, and ring geometry for all instances of the Ligand of Interest. In addition, ligands with molecular weight > 250 and outliers as shown on the validation Tables will also be included. For torsion angles, if less than 5% of the Mogul distribution of torsion angles is within 10 degrees of the torsion angle in question, then that torsion angle is considered an outlier. Any bond that is central to one or more torsion angles identified as an outlier by Mogul will be highlighted in the graph. For rings, the root-mean-square deviation (RMSD) between the ring in question and similar rings identified by Mogul is calculated over all ring torsion angles. If the average RMSD is greater than 60 degrees and the minimal RMSD between the ring in question and any Mogul-identified rings is also greater than 60 degrees, then that ring is considered an outlier. The outliers are highlighted in purple. The color gray indicates Mogul did not find sufficient equivalents in the CSD to analyse the geometry.

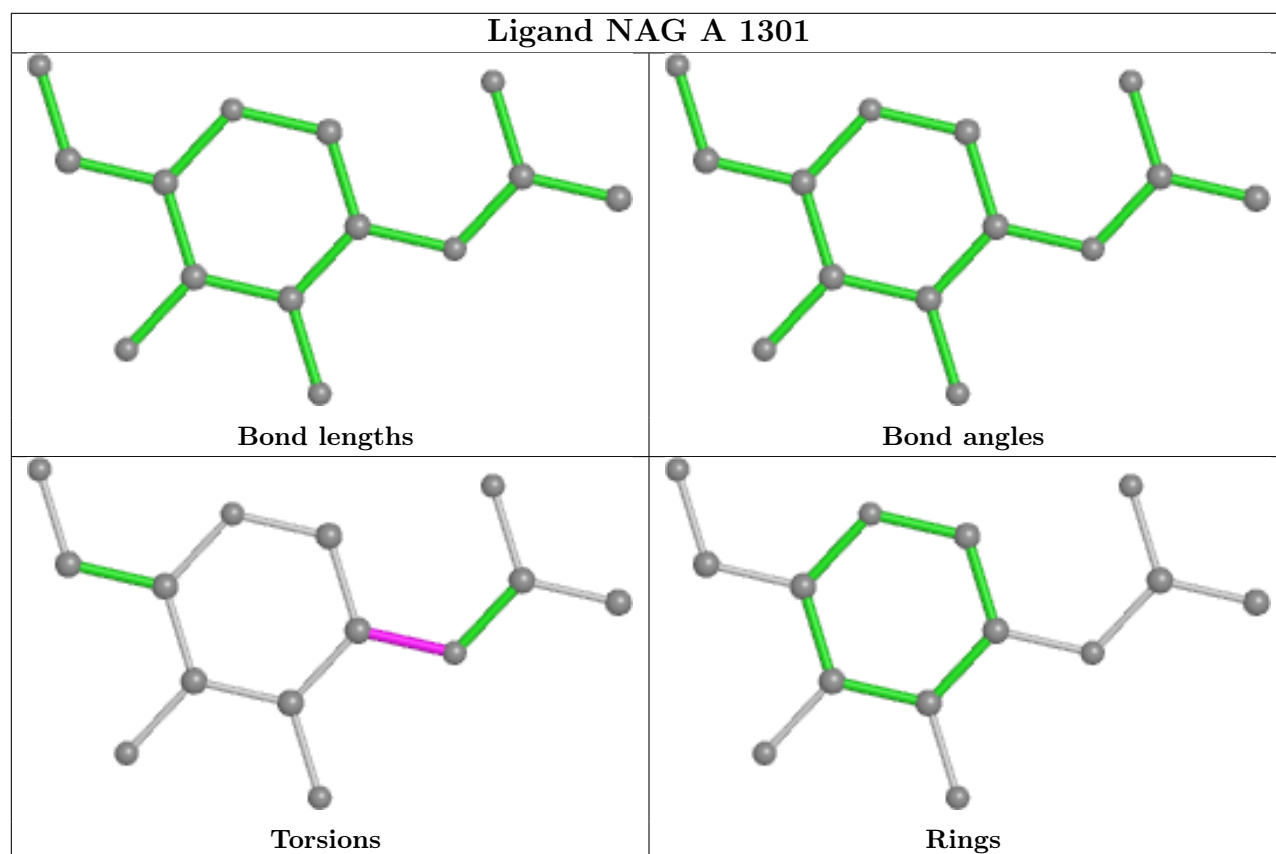
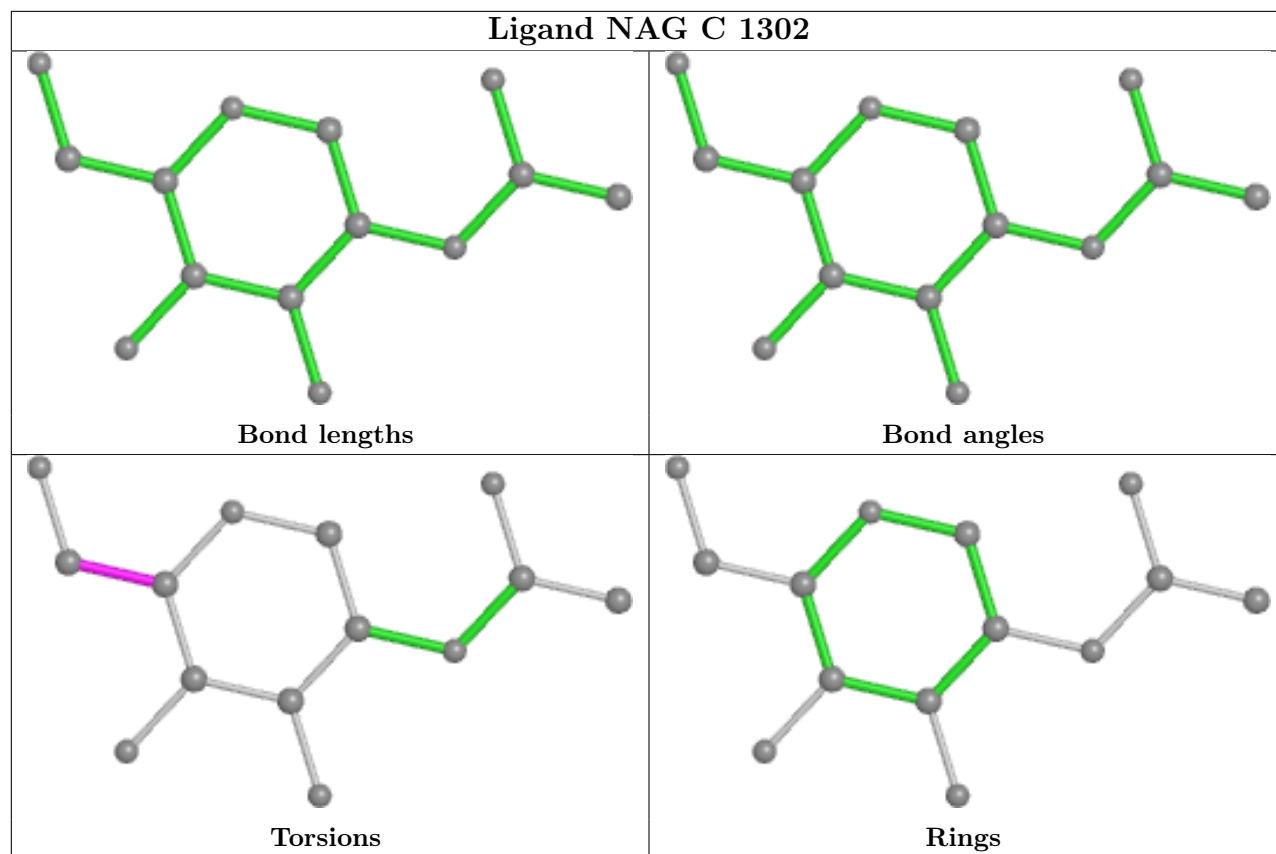

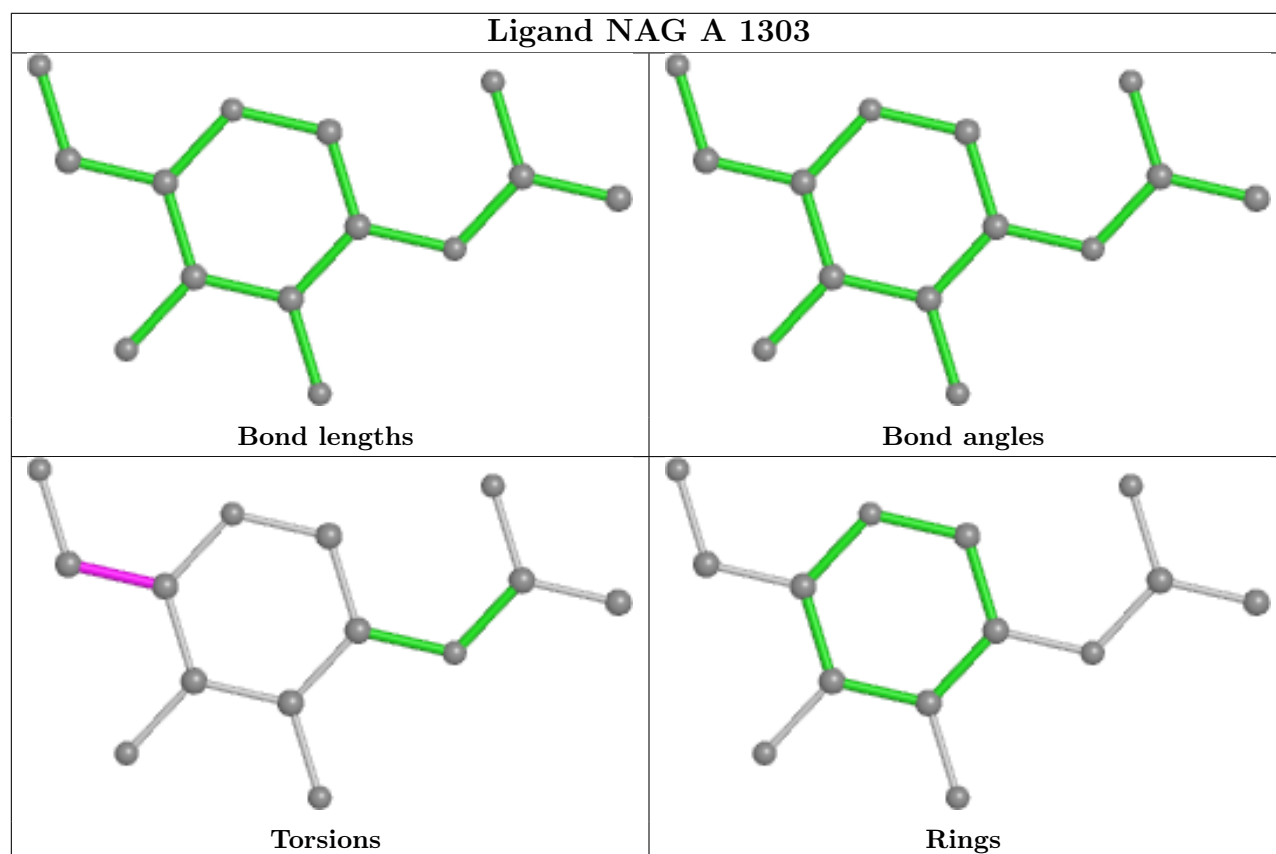
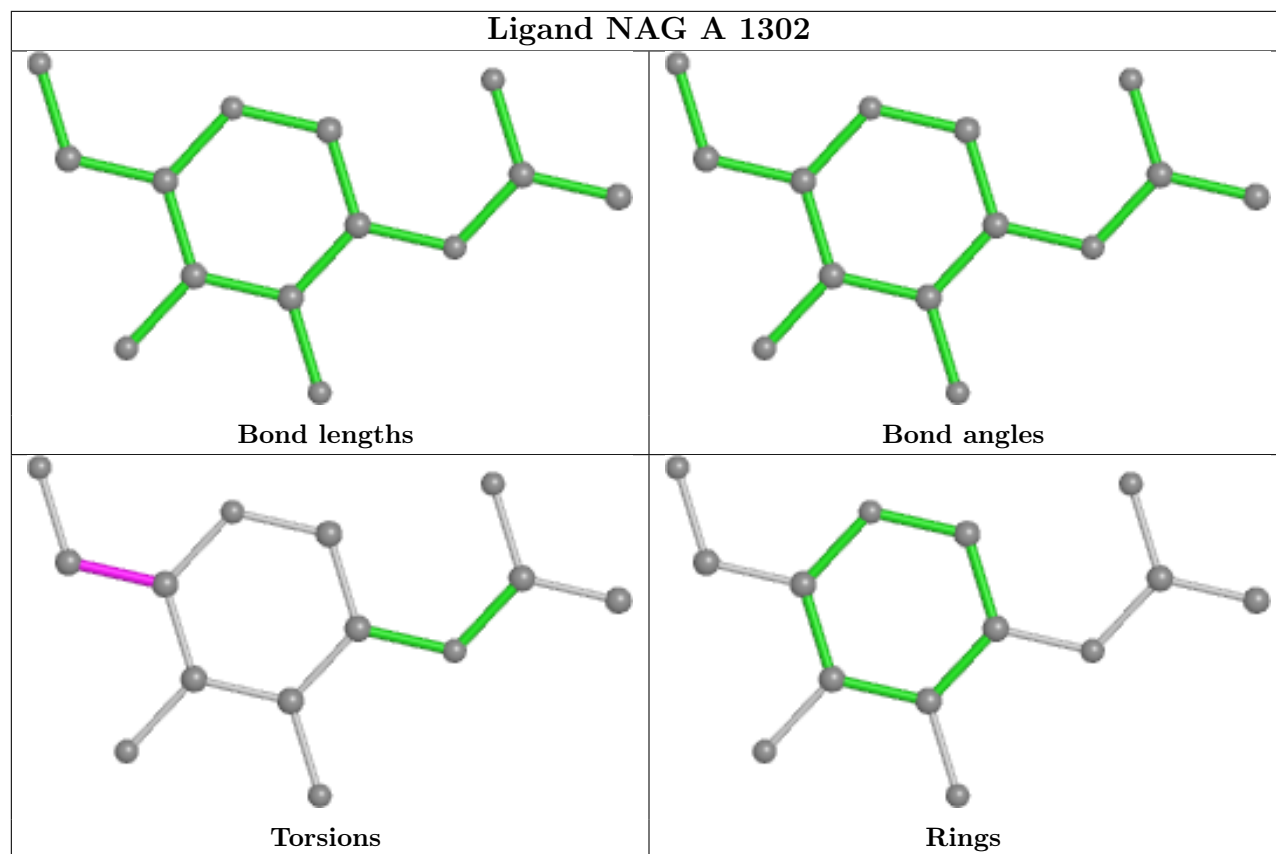

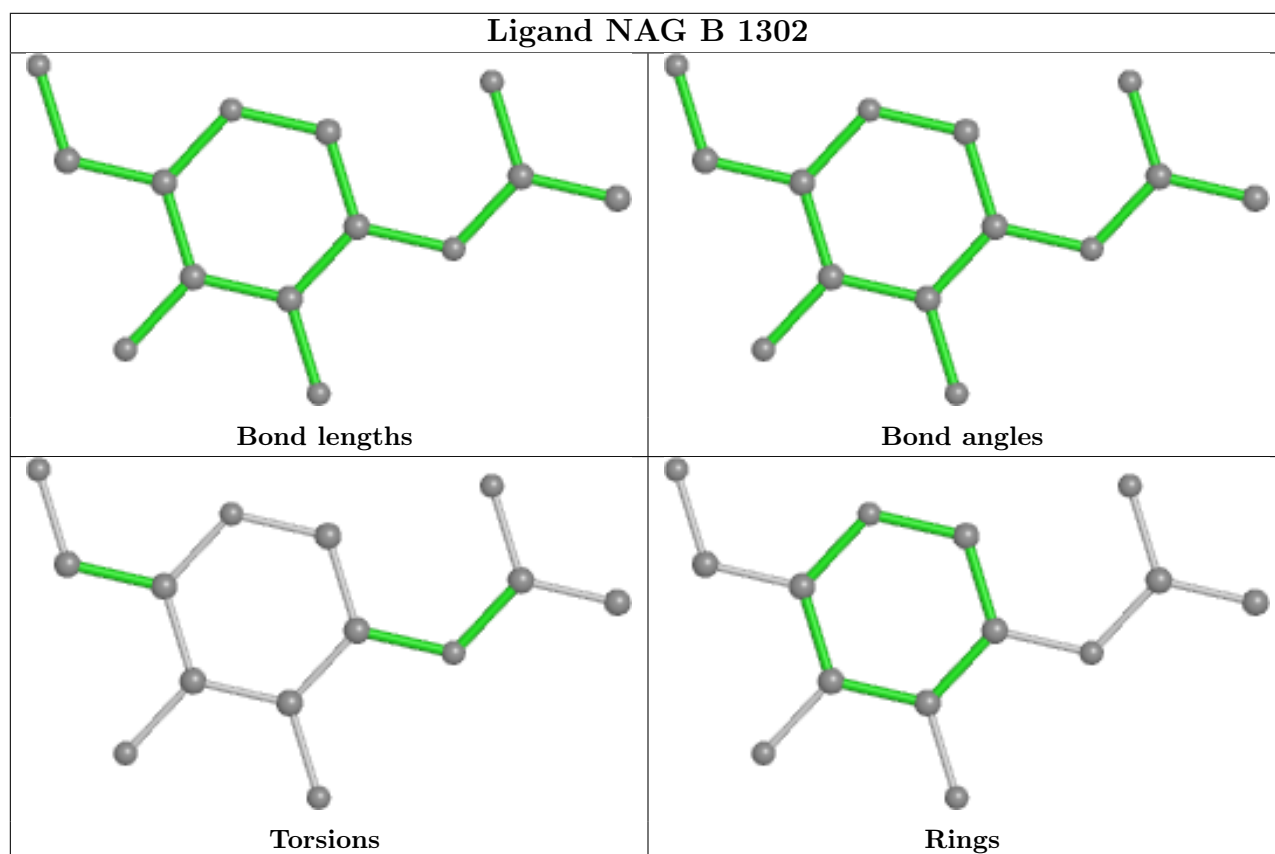
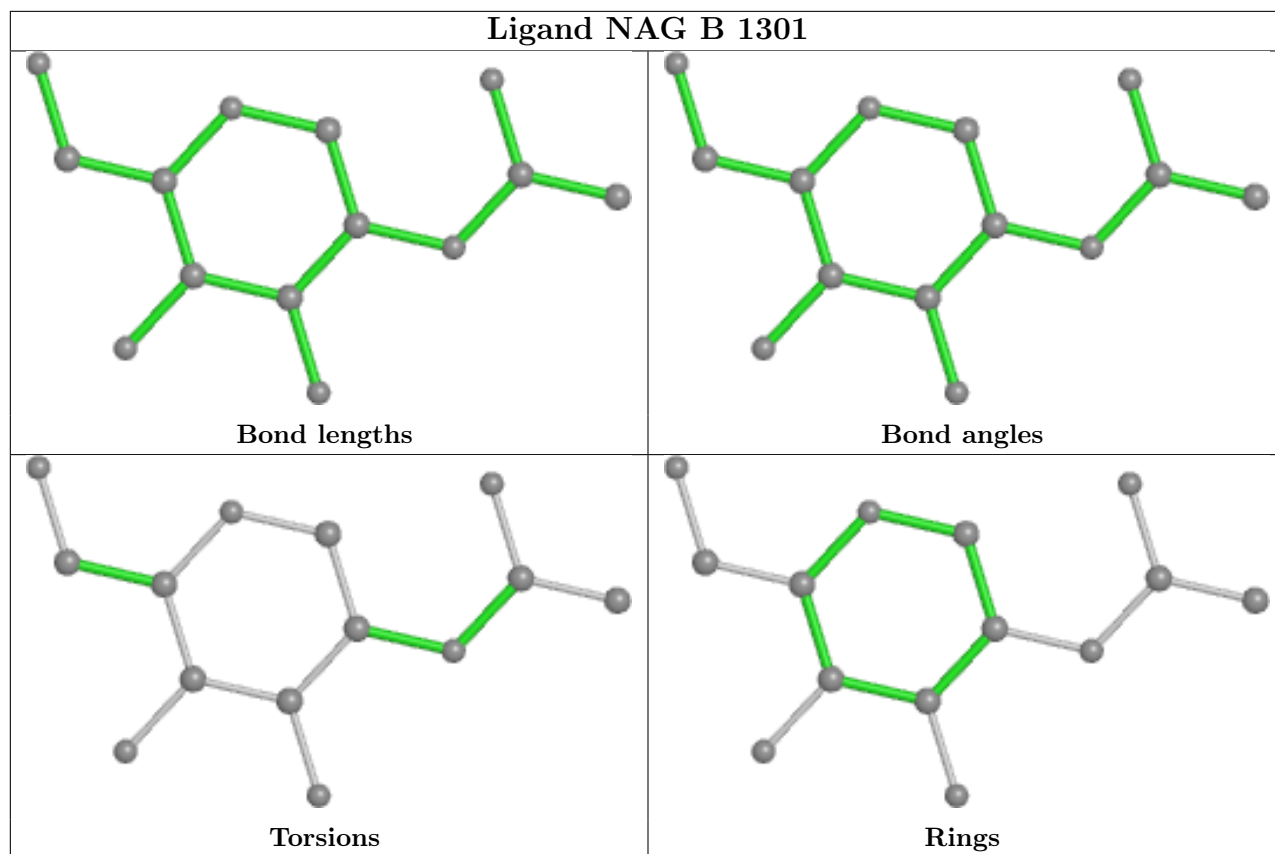

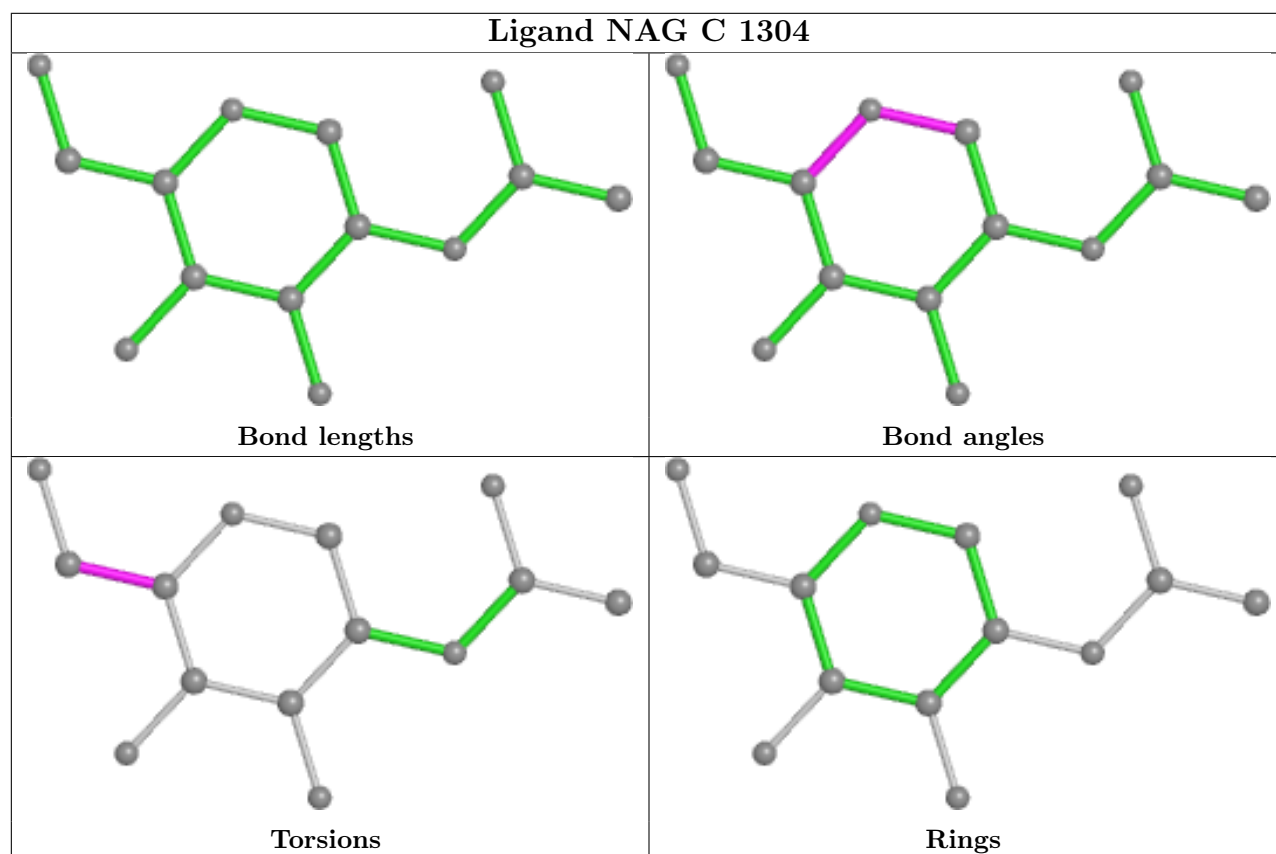
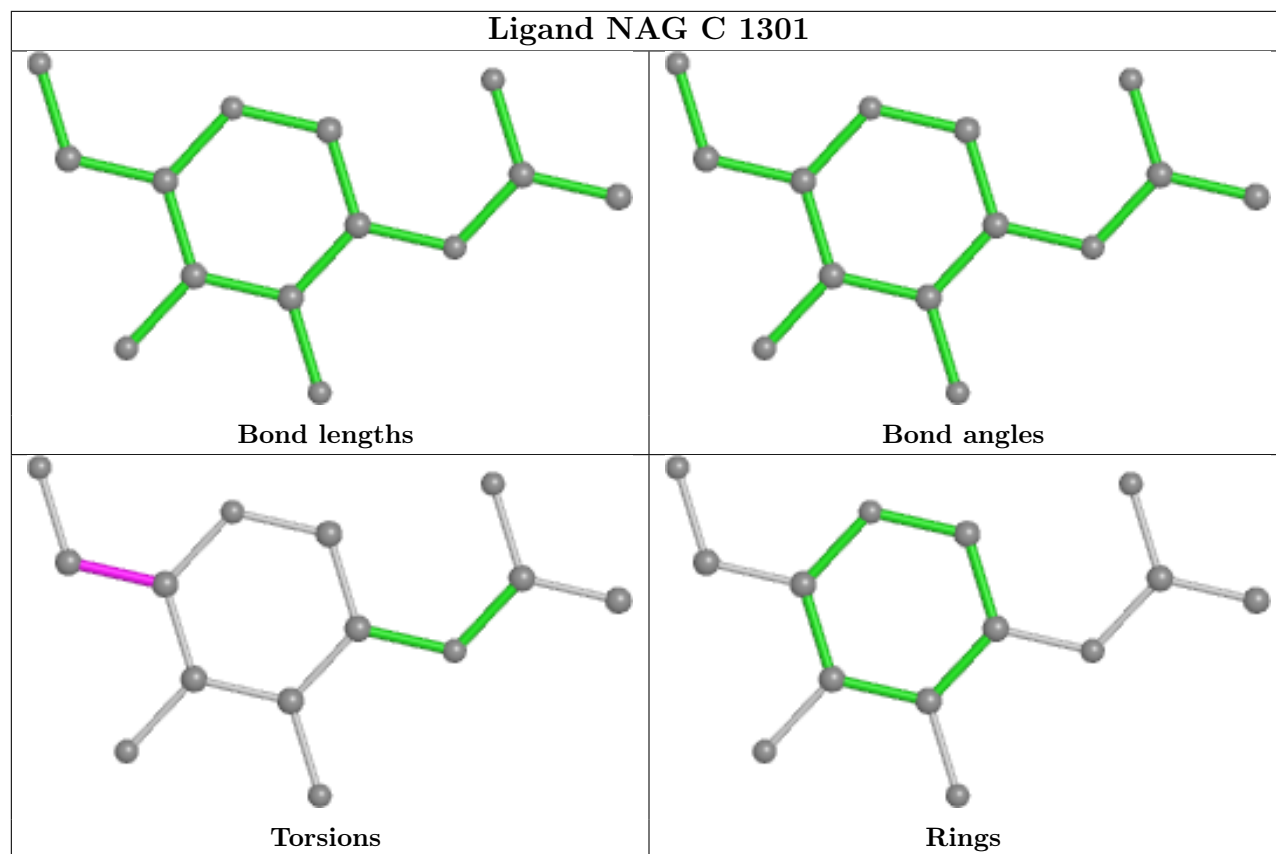

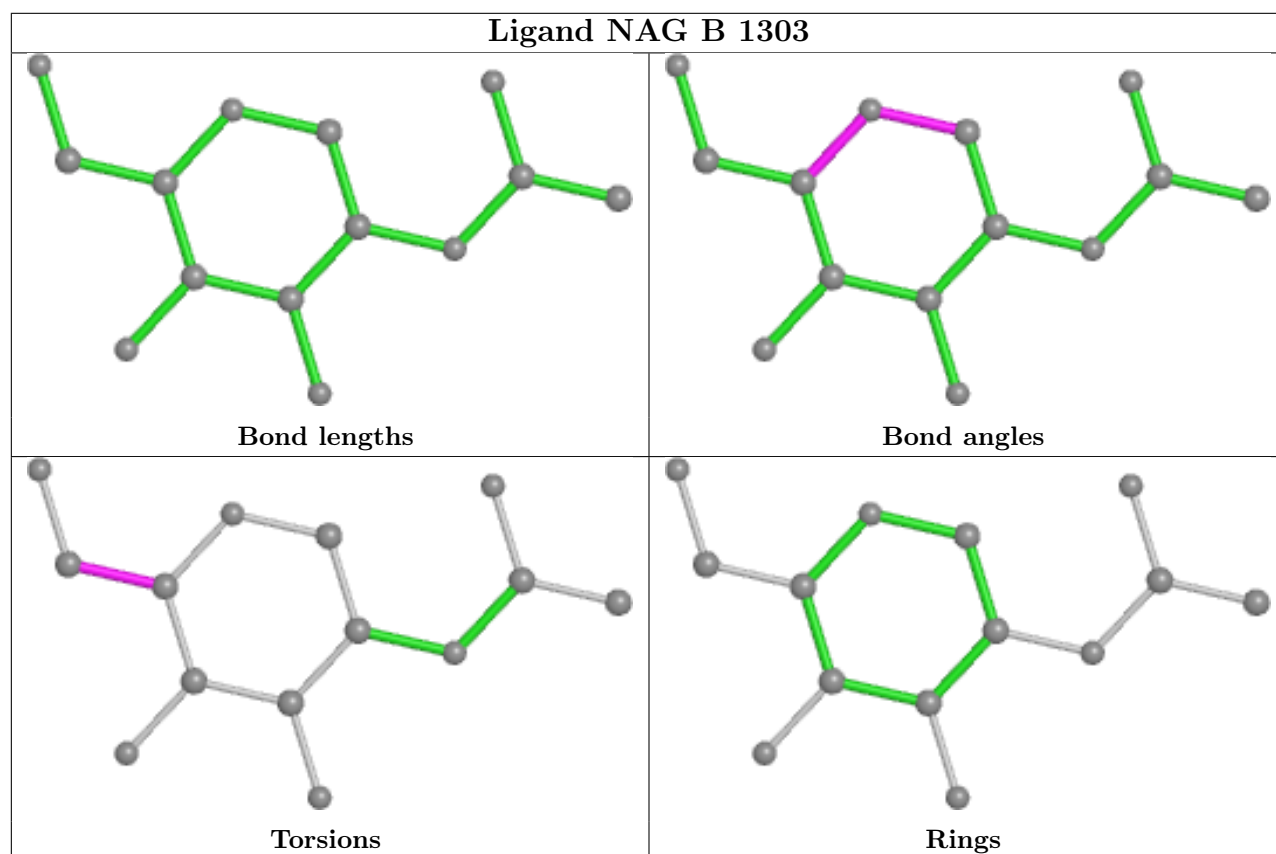
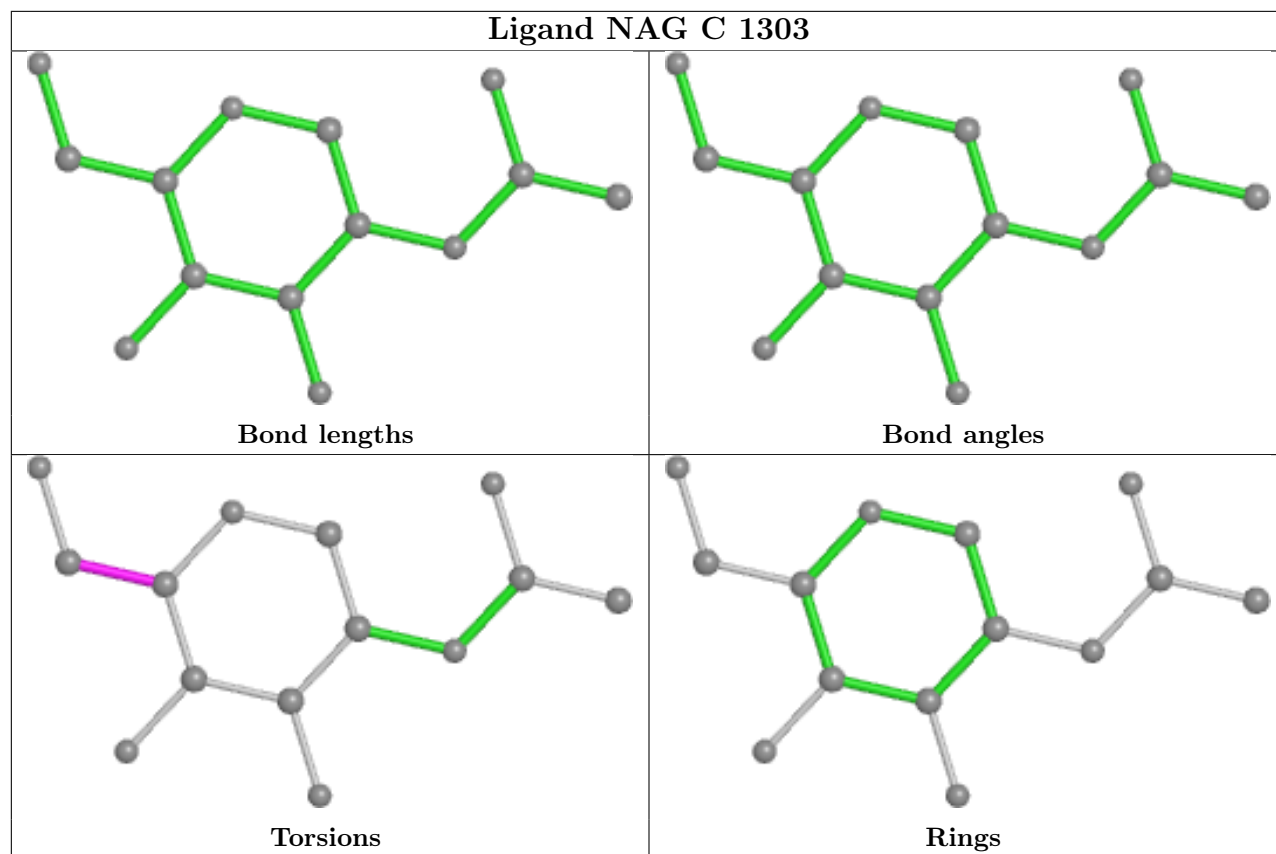

5.7 Other polymers [i](#)

There are no such residues in this entry.

5.8 Polymer linkage issues [i](#)

There are no chain breaks in this entry.

6 Map visualisation [i](#)

This section contains visualisations of the EMDB entry EMD-32744. These allow visual inspection of the internal detail of the map and identification of artifacts.

No raw map or half-maps were deposited for this entry and therefore no images, graphs, etc. pertaining to the raw map can be shown.

6.1 Orthogonal projections [i](#)

6.1.1 Primary map

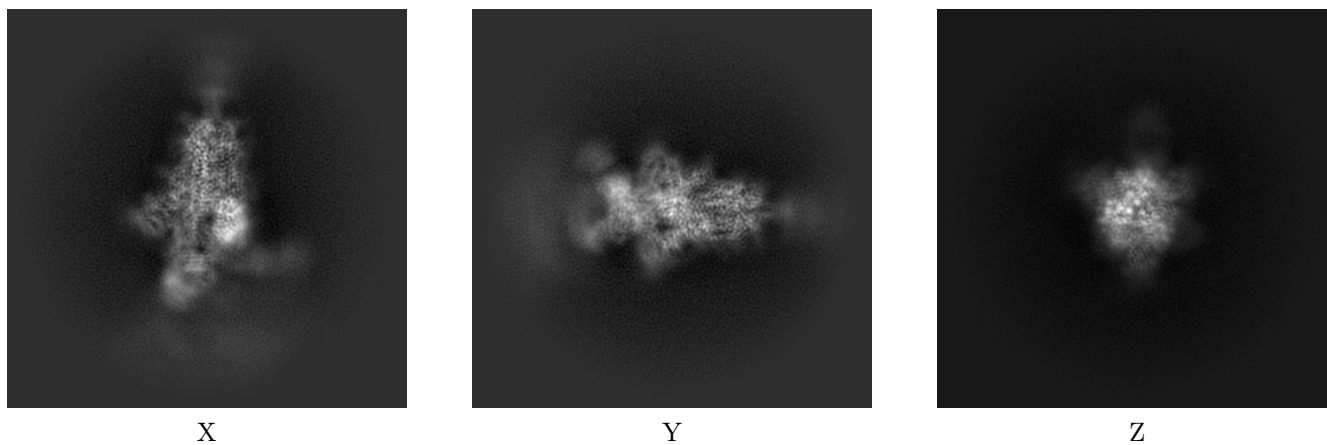

The images above show the map projected in three orthogonal directions.

6.2 Central slices [i](#)

6.2.1 Primary map

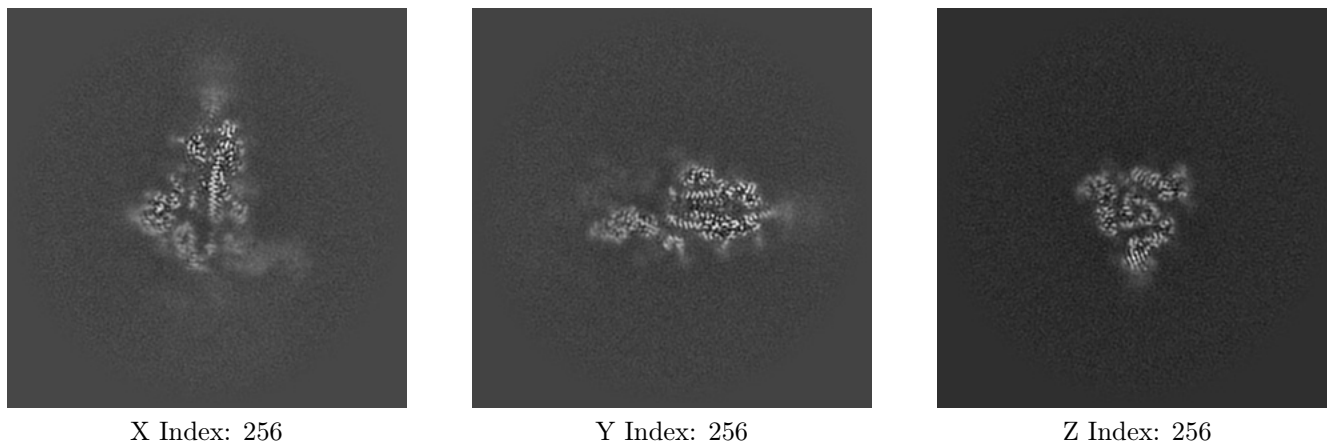

The images above show central slices of the map in three orthogonal directions.

6.3 Largest variance slices [i](#)

6.3.1 Primary map

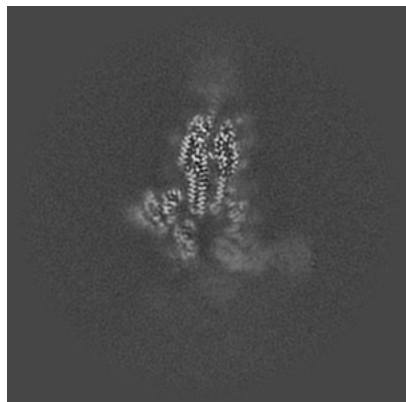

X Index: 265

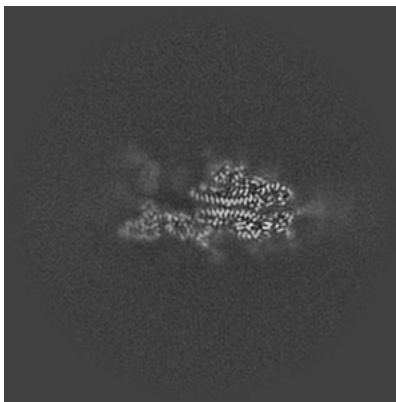

Y Index: 251

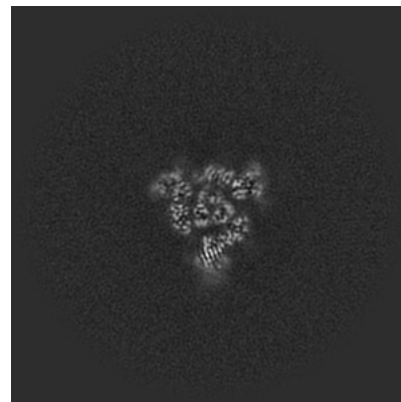

Z Index: 255

The images above show the largest variance slices of the map in three orthogonal directions.

6.4 Orthogonal surface views [i](#)

6.4.1 Primary map



X

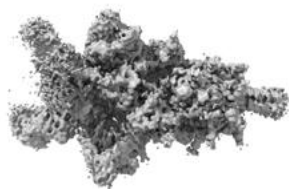

Y



Z

The images above show the 3D surface view of the map at the recommended contour level 0.2036. These images, in conjunction with the slice images, may facilitate assessment of whether an appropriate contour level has been provided.

6.5 Mask visualisation

This section was not generated. No masks/segmentation were deposited.

7 Map analysis [i](#)

This section contains the results of statistical analysis of the map.

7.1 Map-value distribution [i](#)

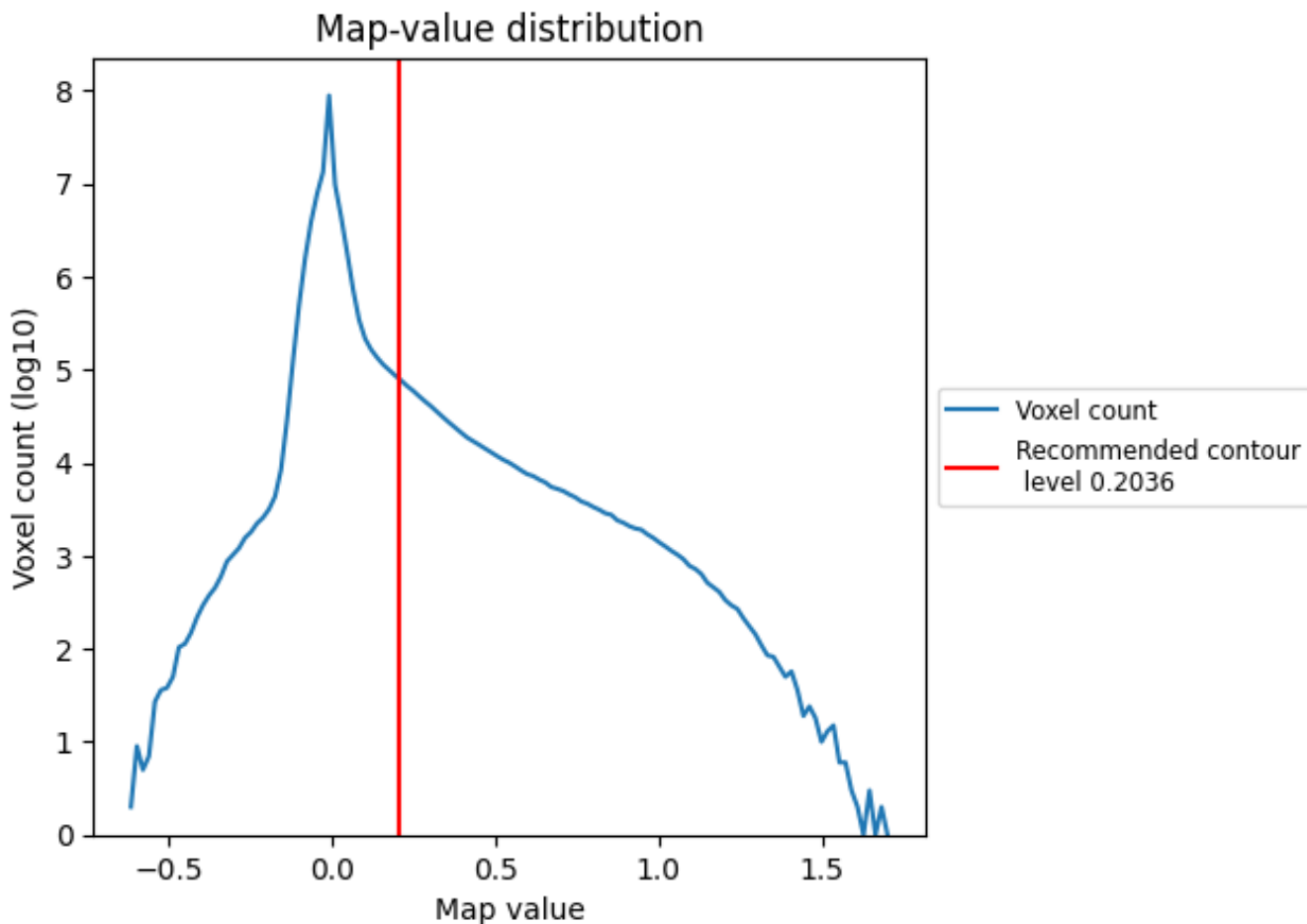

The map-value distribution is plotted in 128 intervals along the x-axis. The y-axis is logarithmic. A spike in this graph at zero usually indicates that the volume has been masked.

7.2 Volume estimate [i](#)

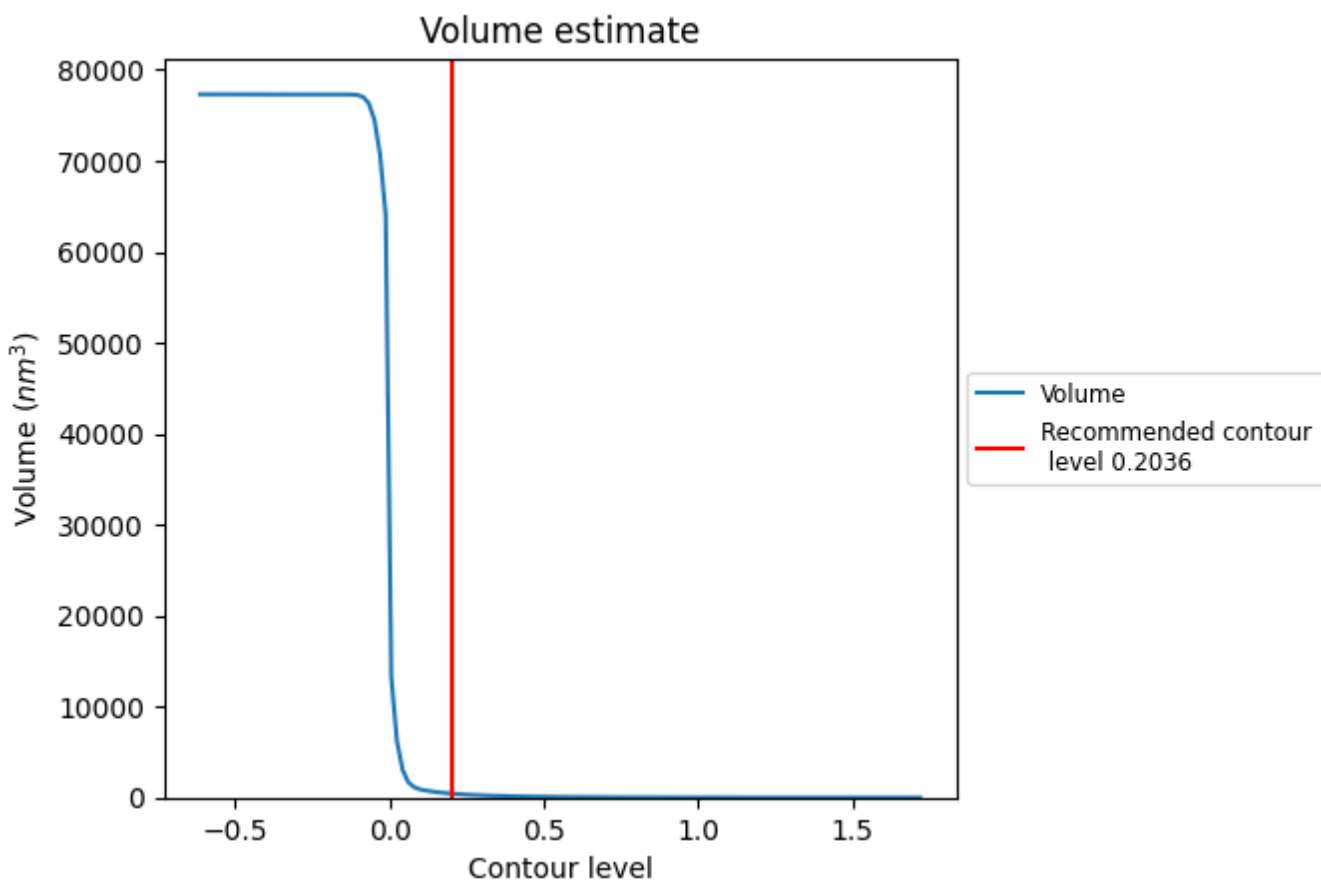

The volume at the recommended contour level is 428 nm³; this corresponds to an approximate mass of 387 kDa.

The volume estimate graph shows how the enclosed volume varies with the contour level. The recommended contour level is shown as a vertical line and the intersection between the line and the curve gives the volume of the enclosed surface at the given level.

7.3 Rotationally averaged power spectrum [\(i\)](#)

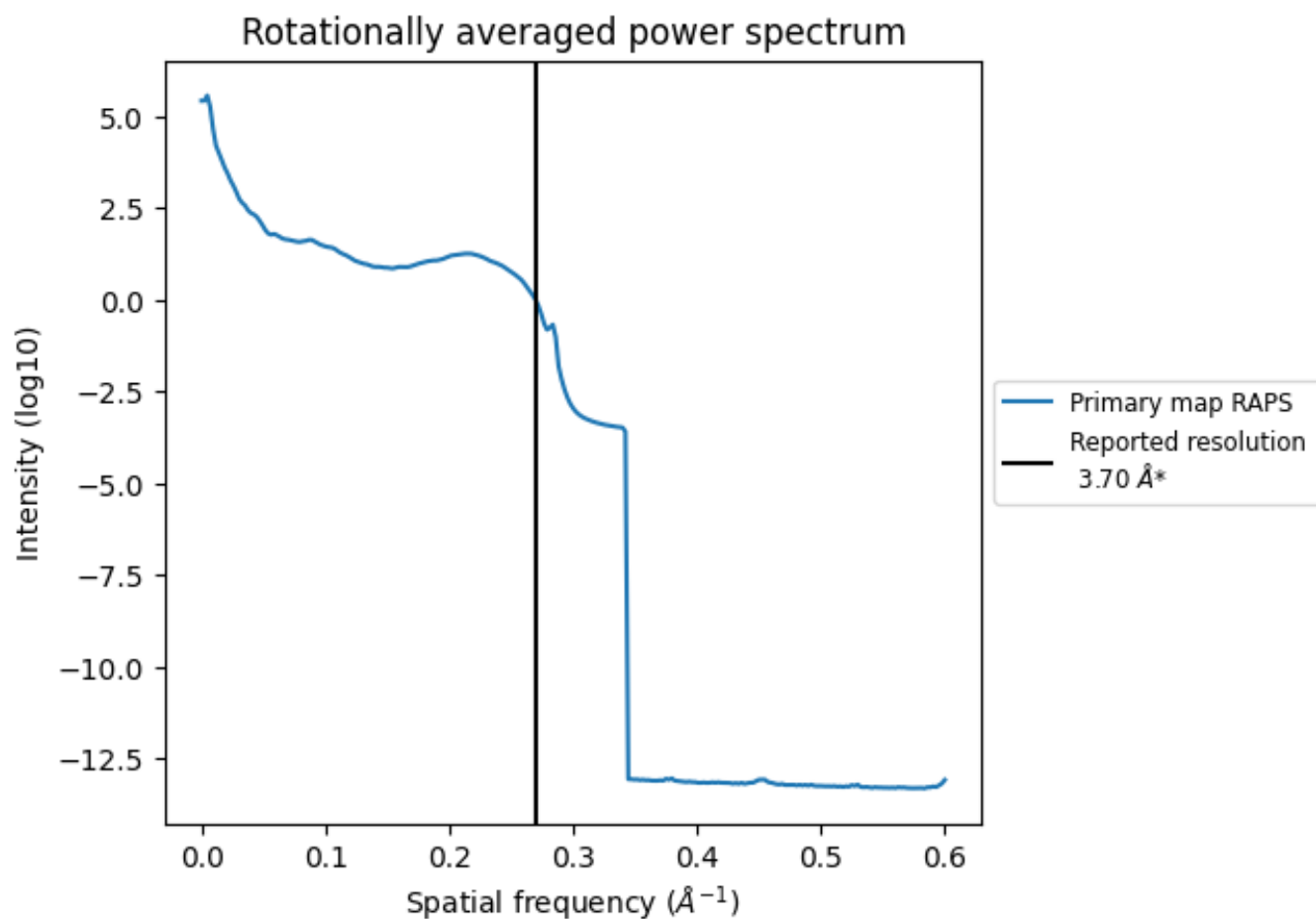

*Reported resolution corresponds to spatial frequency of 0.270 Å⁻¹

8 Fourier-Shell correlation

This section was not generated. No FSC curve or half-maps provided.

9 Map-model fit [i](#)

This section contains information regarding the fit between EMDB map EMD-32744 and PDB model 7WS5. Per-residue inclusion information can be found in section 3 on page 11.

9.1 Map-model overlay [i](#)

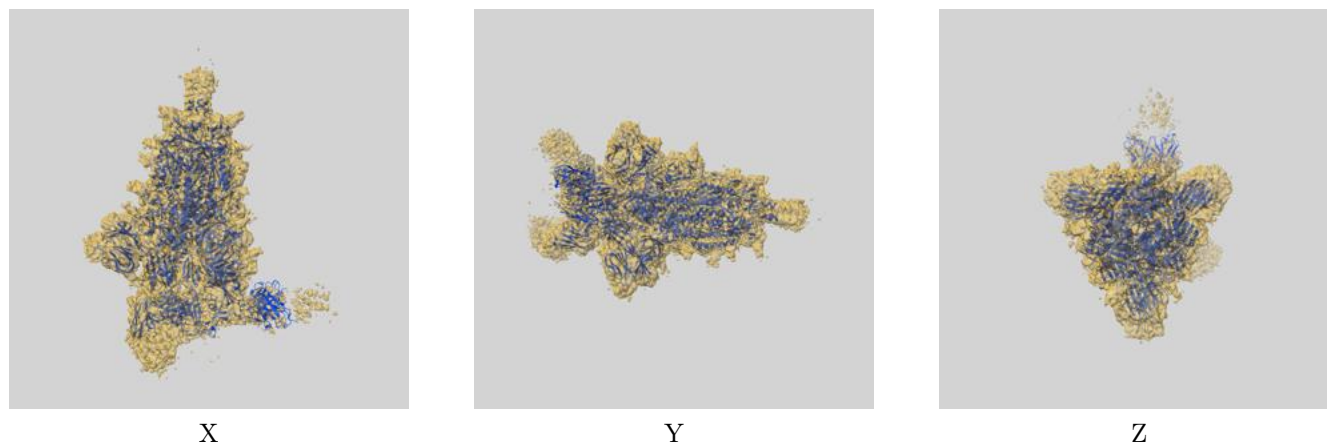

The images above show the 3D surface view of the map at the recommended contour level 0.2036 at 50% transparency in yellow overlaid with a ribbon representation of the model coloured in blue. These images allow for the visual assessment of the quality of fit between the atomic model and the map.

9.2 Q-score mapped to coordinate model [i](#)

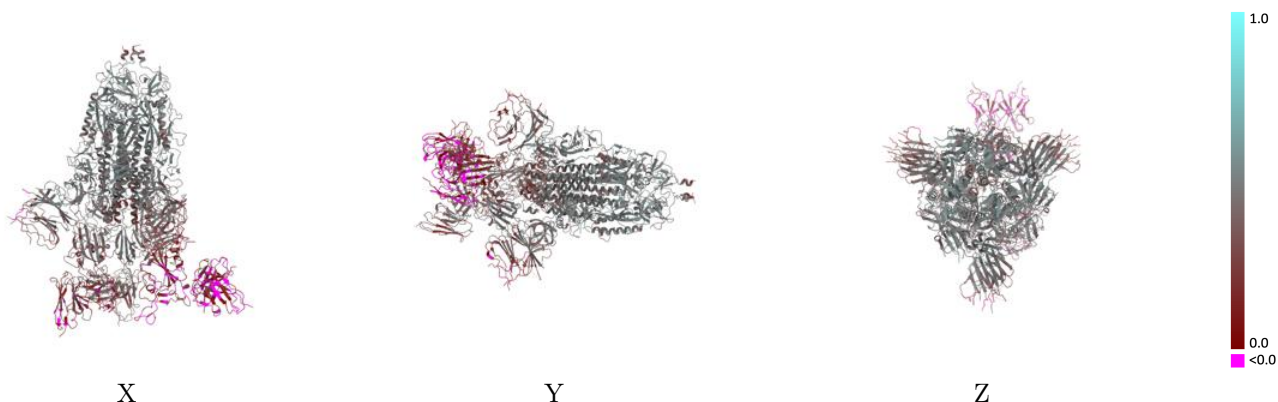

The images above show the model with each residue coloured according its Q-score. This shows their resolvability in the map with higher Q-score values reflecting better resolvability. Please note: Q-score is calculating the resolvability of atoms, and thus high values are only expected at resolutions at which atoms can be resolved. Low Q-score values may therefore be expected for many entries.

9.3 Atom inclusion mapped to coordinate model [i](#)

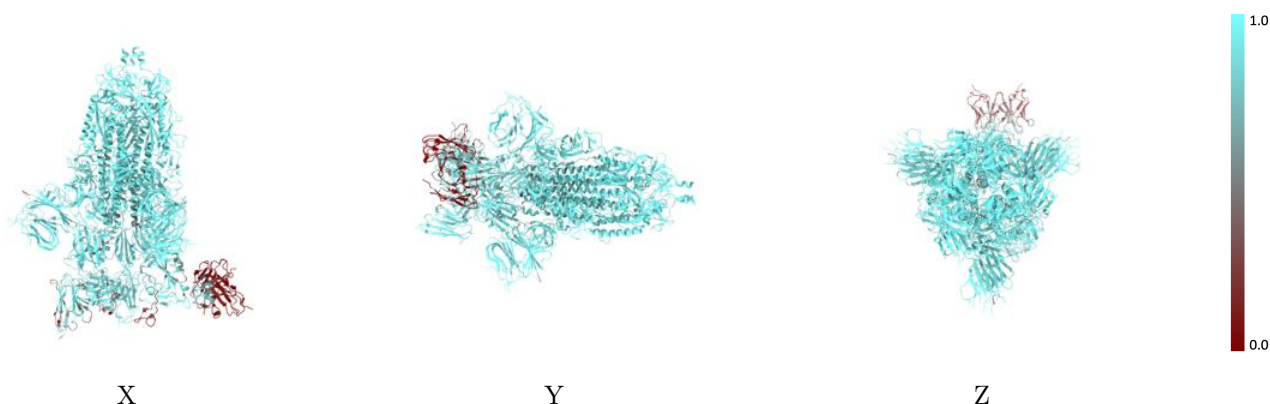

The images above show the model with each residue coloured according to its atom inclusion. This shows to what extent they are inside the map at the recommended contour level (0.2036).



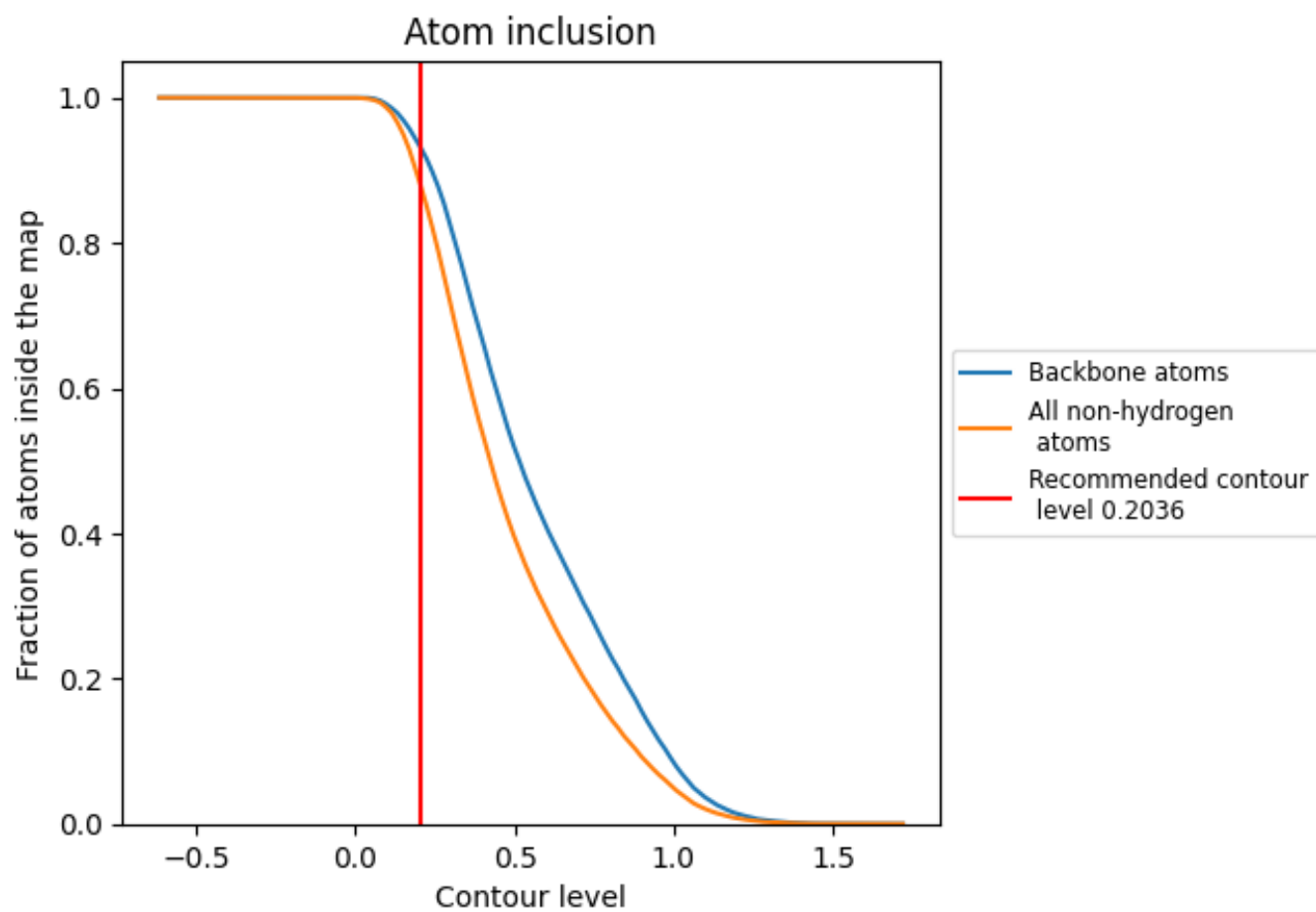













































9.4 Atom inclusion [i](#)



At the recommended contour level, 93% of all backbone atoms, 88% of all non-hydrogen atoms, are inside the map.

9.5 Map-model fit summary

The table lists the average atom inclusion at the recommended contour level (0.2036) and Q-score for the entire model and for each chain.

Chain	Atom inclusion	Q-score
All	 0.8820	 0.3780
A	 0.9469	 0.4270
B	 0.9132	 0.3730
C	 0.9519	 0.4380
D	 0.6878	 0.2090
E	 0.7508	 0.2400
F	 0.2351	 0.0610
G	 0.2395	 0.0700
H	 0.9030	 0.3650
I	 0.9237	 0.3490
J	 0.9286	 0.4130
K	 0.6786	 0.3520
L	 0.8571	 0.3550
M	 0.9286	 0.4180
N	 1.0000	 0.5090
O	 0.9286	 0.4810
P	 0.9286	 0.4150
Q	 0.7857	 0.4230
R	 0.8571	 0.3990
S	 0.9286	 0.4350
T	 1.0000	 0.4700
U	 0.9286	 0.4220
V	 0.8571	 0.3600
W	 0.9286	 0.3450

