



wwPDB EM Validation Summary Report ⓘ

Aug 24, 2024 – 02:20 PM EDT

PDB ID : 8W2F
EMDB ID : EMD-43746
Title : Plasmodium falciparum 20S proteasome bound to an inhibitor
Authors : Han, Y.; Deng, X.; Ray, S.; Chen, Z.; Phillips, M.
Deposited on : 2024-02-20
Resolution : 3.10 Å (reported)
Based on initial model : 5FMG

This is a wwPDB EM Validation Summary Report for a publicly released PDB entry.

We welcome your comments at validation@mail.wwpdb.org

A user guide is available at

<https://www.wwpdb.org/validation/2017/EMValidationReportHelp>

with specific help available everywhere you see the ⓘ symbol.

The types of validation reports are described at

<http://www.wwpdb.org/validation/2017/FAQs#types>.

The following versions of software and data (see [references ⓘ](#)) were used in the production of this report:

EMDB validation analysis : 0.0.1.dev112
Mogul : 2022.3.0, CSD as543be (2022)
MolProbity : 4.02b-467
buster-report : 1.1.7 (2018)
Percentile statistics : 20231227.v01 (using entries in the PDB archive December 27th 2023)
MapQ : 1.9.13
Ideal geometry (proteins) : Engh & Huber (2001)
Ideal geometry (DNA, RNA) : Parkinson et al. (1996)
Validation Pipeline (wwPDB-VP) : 2.38.2

1 Overall quality at a glance i

The following experimental techniques were used to determine the structure:

ELECTRON MICROSCOPY

The reported resolution of this entry is 3.10 Å.

Percentile scores (ranging between 0-100) for global validation metrics of the entry are shown in the following graphic. The table shows the number of entries on which the scores are based.

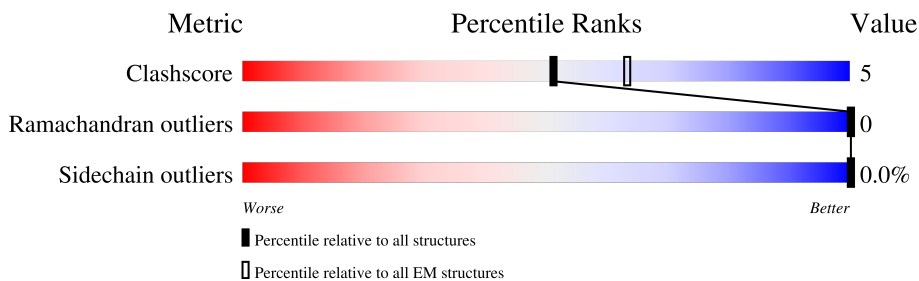

Metric	Whole archive (#Entries)	EM structures (#Entries)
Clashscore	210492	15764
Ramachandran outliers	207382	16835
Sidechain outliers	206894	16415

The table below summarises the geometric issues observed across the polymeric chains and their fit to the map. The red, orange, yellow and green segments of the bar indicate the fraction of residues that contain outliers for ≥ 3 , 2, 1 and 0 types of geometric quality criteria respectively. A grey segment represents the fraction of residues that are not modelled. The numeric value for each fraction is indicated below the corresponding segment, with a dot representing fractions $\leq 5\%$. The upper red bar (where present) indicates the fraction of residues that have poor fit to the EM map (all-atom inclusion $< 40\%$). The numeric value is given above the bar.

Mol	Chain	Length	Quality of chain
1	A	260	
1	O	260	
2	B	235	
2	P	235	
3	C	242	
3	Q	242	
4	D	241	
4	R	241	

Continued on next page...

Continued from previous page...

Mol	Chain	Length	Quality of chain
5	E	256	23% 75% 14% 11%
5	S	256	23% 82% 7% 11%
6	F	254	19% 80% 10% 10%
6	T	254	17% 79% 10% 11%
7	G	252	16% 81% 8% 11%
7	U	252	18% 84% 10% 7%
8	H	252	6% 72% 13% 14%
8	V	252	6% 76% 10% 14%
9	I	229	8% 79% 13% 8%
9	W	229	8% 78% 14% 8%
10	J	218	5% 84% 11% 6%
10	X	218	• 86% 9% 6%
11	K	195	• 84% 16%
11	Y	195	• 87% 13%
12	L	211	• 91% 9%
12	Z	211	• 91% 9%
13	N	284	• 71% 10% 19%
13	b	284	• 81% 19%
14	M	240	• 76% 12% 12%
14	a	240	• 88% 12%

2 Entry composition [i](#)

There are 15 unique types of molecules in this entry. The entry contains 49043 atoms, of which 0 are hydrogens and 0 are deuteriums.

In the tables below, the AltConf column contains the number of residues with at least one atom in alternate conformation and the Trace column contains the number of residues modelled with at most 2 atoms.

- Molecule 1 is a protein called Proteasome endopeptidase complex.

Mol	Chain	Residues	Atoms					AltConf	Trace
			Total	C	N	O	S		
1	A	232	Total	C	N	O	S	0	0
			1828	1153	304	357	14		
1	O	237	Total	C	N	O	S	0	0
			1869	1176	312	367	14		

- Molecule 2 is a protein called Proteasome endopeptidase complex.

Mol	Chain	Residues	Atoms					AltConf	Trace
			Total	C	N	O	S		
2	B	213	Total	C	N	O	S	0	0
			1696	1092	280	318	6		
2	P	216	Total	C	N	O	S	0	0
			1722	1112	282	322	6		

- Molecule 3 is a protein called Proteasome subunit alpha type.

Mol	Chain	Residues	Atoms					AltConf	Trace
			Total	C	N	O	S		
3	C	235	Total	C	N	O	S	0	0
			1878	1200	305	369	4		
3	Q	229	Total	C	N	O	S	0	0
			1832	1173	296	360	3		

- Molecule 4 is a protein called Proteasome subunit alpha type.

Mol	Chain	Residues	Atoms					AltConf	Trace
			Total	C	N	O	S		
4	D	233	Total	C	N	O	S	0	0
			1845	1178	312	347	8		
4	R	222	Total	C	N	O	S	0	0
			1755	1124	297	327	7		

- Molecule 5 is a protein called Proteasome subunit alpha type.

Mol	Chain	Residues	Atoms					AltConf	Trace
5	E	229	Total	C	N	O	S	0	0
			1764	1112	291	350	11		
5	S	229	Total	C	N	O	S	0	0
			1764	1112	291	350	11		

- Molecule 6 is a protein called Proteasome endopeptidase complex.

Mol	Chain	Residues	Atoms					AltConf	Trace
6	F	229	Total	C	N	O	S	0	0
			1820	1162	299	349	10		
6	T	227	Total	C	N	O	S	0	0
			1803	1153	296	344	10		

- Molecule 7 is a protein called Proteasome subunit alpha type-3, putative.

Mol	Chain	Residues	Atoms					AltConf	Trace
7	G	225	Total	C	N	O	S	0	0
			1849	1182	307	348	12		
7	U	235	Total	C	N	O	S	0	0
			1925	1227	323	363	12		

- Molecule 8 is a protein called Proteasome subunit beta type-6, putative.

Mol	Chain	Residues	Atoms					AltConf	Trace
8	H	216	Total	C	N	O	S	0	0
			1747	1112	302	321	12		
8	V	216	Total	C	N	O	S	0	0
			1747	1112	302	321	12		

- Molecule 9 is a protein called Proteasome subunit beta.

Mol	Chain	Residues	Atoms					AltConf	Trace
9	I	211	Total	C	N	O	S	0	0
			1602	1011	275	303	13		
9	W	211	Total	C	N	O	S	0	0
			1602	1011	275	303	13		

- Molecule 10 is a protein called Proteasome subunit beta.

Mol	Chain	Residues	Atoms					AltConf	Trace
10	J	206	Total	C	N	O	S	0	0
			1618	1032	262	310	14		

Continued on next page...

Continued from previous page...

Mol	Chain	Residues	Atoms					AltConf	Trace
			Total	C	N	O	S		
10	X	206	1618	1032	262	310	14	0	0

- Molecule 11 is a protein called Proteasome subunit beta.

Mol	Chain	Residues	Atoms					AltConf	Trace
			Total	C	N	O	S		
11	K	195	1614	1042	266	298	8	0	0
11	Y	195	1614	1042	266	298	8	0	0

- Molecule 12 is a protein called Proteasome subunit beta type.

Mol	Chain	Residues	Atoms					AltConf	Trace
			Total	C	N	O	S		
12	L	211	1662	1060	275	319	8	0	0
12	Z	211	1662	1060	275	319	8	0	0

- Molecule 13 is a protein called Proteasome subunit beta.

Mol	Chain	Residues	Atoms					AltConf	Trace
			Total	C	N	O	S		
13	N	230	1893	1208	320	357	8	0	0
13	b	230	1893	1208	320	357	8	0	0

There are 38 discrepancies between the modelled and reference sequences:

Chain	Residue	Modelled	Actual	Comment	Reference
N	266	GLY	-	expression tag	UNP Q7K6A9
N	267	SER	-	expression tag	UNP Q7K6A9
N	268	GLY	-	expression tag	UNP Q7K6A9
N	269	SER	-	expression tag	UNP Q7K6A9
N	270	GLU	-	expression tag	UNP Q7K6A9
N	271	ASN	-	expression tag	UNP Q7K6A9
N	272	LEU	-	expression tag	UNP Q7K6A9
N	273	TYR	-	expression tag	UNP Q7K6A9
N	274	PHE	-	expression tag	UNP Q7K6A9
N	275	GLN	-	expression tag	UNP Q7K6A9
N	276	GLY	-	expression tag	UNP Q7K6A9
N	277	HIS	-	expression tag	UNP Q7K6A9

Continued on next page...

Continued from previous page...

Chain	Residue	Modelled	Actual	Comment	Reference
N	278	HIS	-	expression tag	UNP Q7K6A9
N	279	HIS	-	expression tag	UNP Q7K6A9
N	280	HIS	-	expression tag	UNP Q7K6A9
N	281	HIS	-	expression tag	UNP Q7K6A9
N	282	HIS	-	expression tag	UNP Q7K6A9
N	283	HIS	-	expression tag	UNP Q7K6A9
N	284	HIS	-	expression tag	UNP Q7K6A9
b	266	GLY	-	expression tag	UNP Q7K6A9
b	267	SER	-	expression tag	UNP Q7K6A9
b	268	GLY	-	expression tag	UNP Q7K6A9
b	269	SER	-	expression tag	UNP Q7K6A9
b	270	GLU	-	expression tag	UNP Q7K6A9
b	271	ASN	-	expression tag	UNP Q7K6A9
b	272	LEU	-	expression tag	UNP Q7K6A9
b	273	TYR	-	expression tag	UNP Q7K6A9
b	274	PHE	-	expression tag	UNP Q7K6A9
b	275	GLN	-	expression tag	UNP Q7K6A9
b	276	GLY	-	expression tag	UNP Q7K6A9
b	277	HIS	-	expression tag	UNP Q7K6A9
b	278	HIS	-	expression tag	UNP Q7K6A9
b	279	HIS	-	expression tag	UNP Q7K6A9
b	280	HIS	-	expression tag	UNP Q7K6A9
b	281	HIS	-	expression tag	UNP Q7K6A9
b	282	HIS	-	expression tag	UNP Q7K6A9
b	283	HIS	-	expression tag	UNP Q7K6A9
b	284	HIS	-	expression tag	UNP Q7K6A9

- Molecule 14 is a protein called Proteasome subunit beta.

Mol	Chain	Residues	Atoms					AltConf	Trace
14	M	212	Total	C	N	O	S	0	0
			1687	1079	281	320	7		
14	a	211	Total	C	N	O	S	0	0
			1676	1073	277	319	7		

- Molecule 15 is (3S)-1-[(2-fluoroethoxy)acetyl]-N-[[[(4P)-4-(6-methylpyridin-3-yl)-1,3-thiazol-2-yl]methyl]piperidine-3-carboxamide (three-letter code: A1AE6) (formula: C₂₀H₂₅FN₄O₃S) (labeled as "Ligand of Interest" by depositor).

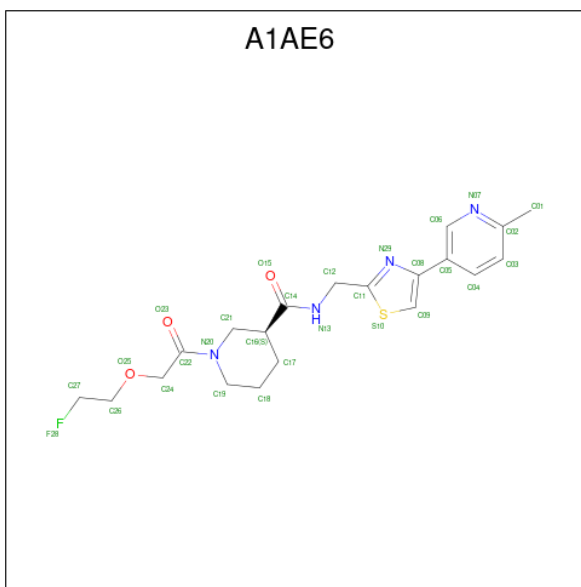

Mol	Chain	Residues	Atoms					AltConf	
			Total	C	F	N	O		S
15	M	1	29	20	1	4	3	1	0
15	a	1	29	20	1	4	3	1	0

3 Residue-property plots [i](#)

These plots are drawn for all protein, RNA, DNA and oligosaccharide chains in the entry. The first graphic for a chain summarises the proportions of the various outlier classes displayed in the second graphic. The second graphic shows the sequence view annotated by issues in geometry and atom inclusion in map density. Residues are color-coded according to the number of geometric quality criteria for which they contain at least one outlier: green = 0, yellow = 1, orange = 2 and red = 3 or more. A red diamond above a residue indicates a poor fit to the EM map for this residue (all-atom inclusion < 40%). Stretches of 2 or more consecutive residues without any outlier are shown as a green connector. Residues present in the sample, but not in the model, are shown in grey.

- Molecule 1: Proteasome endopeptidase complex

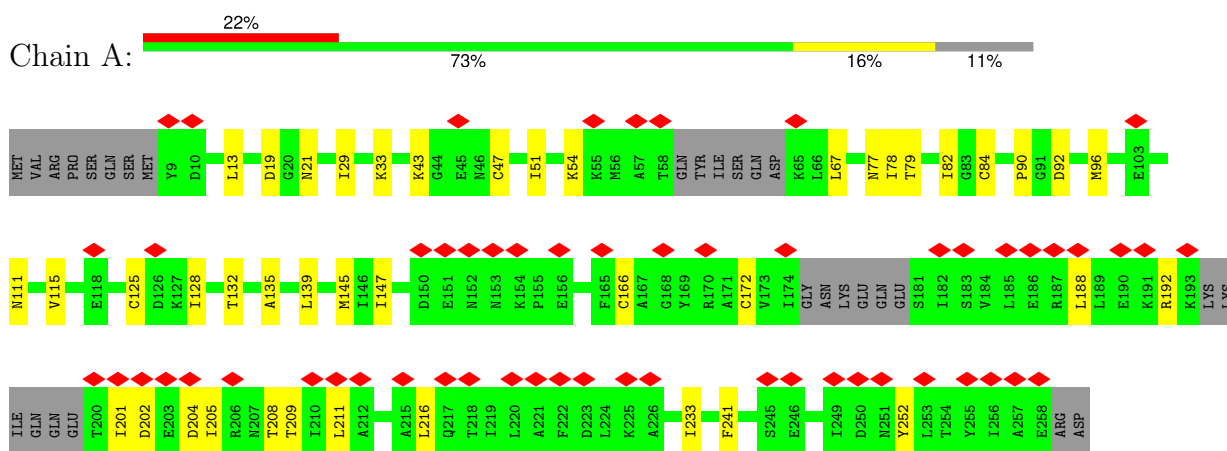

- Molecule 1: Proteasome endopeptidase complex

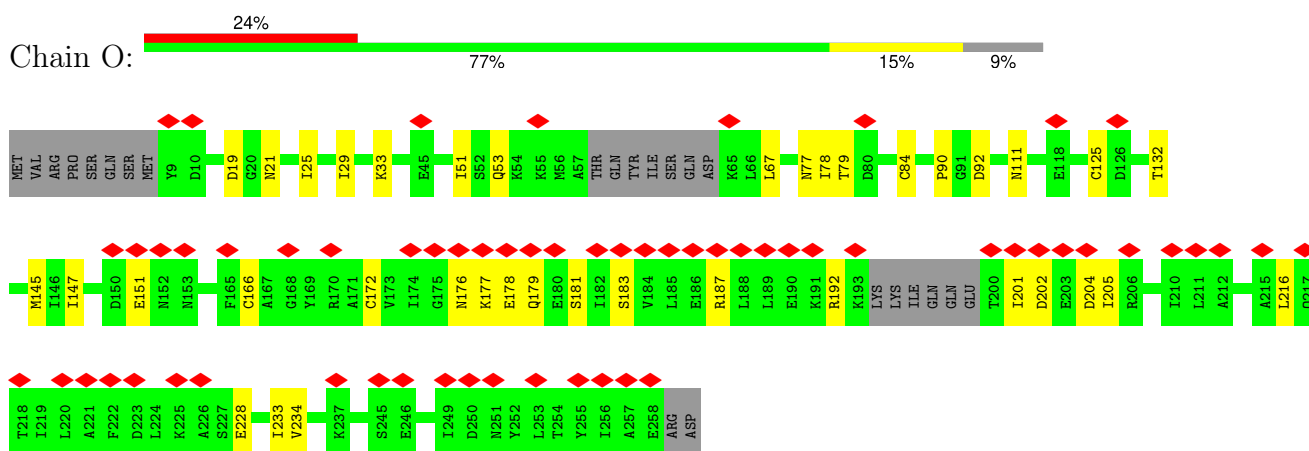

- Molecule 2: Proteasome endopeptidase complex

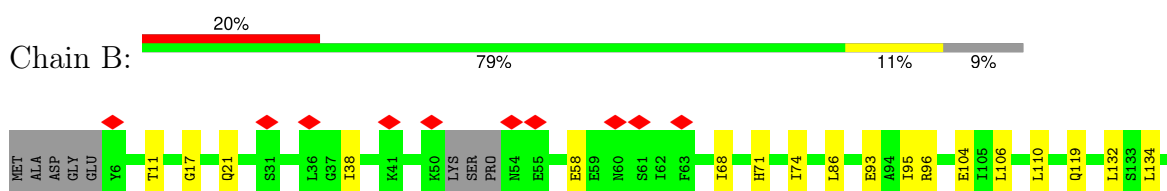

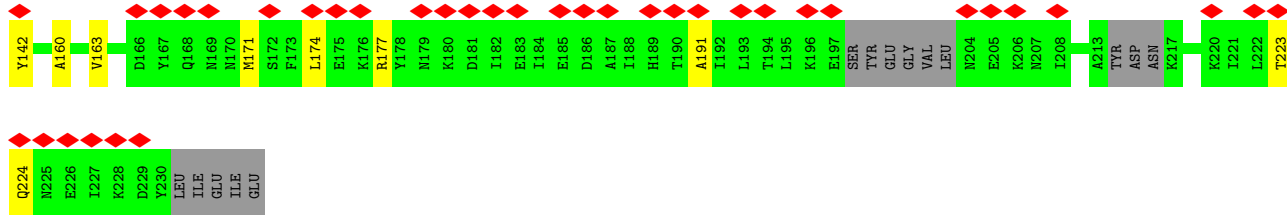

• Molecule 2: Proteasome endopeptidase complex

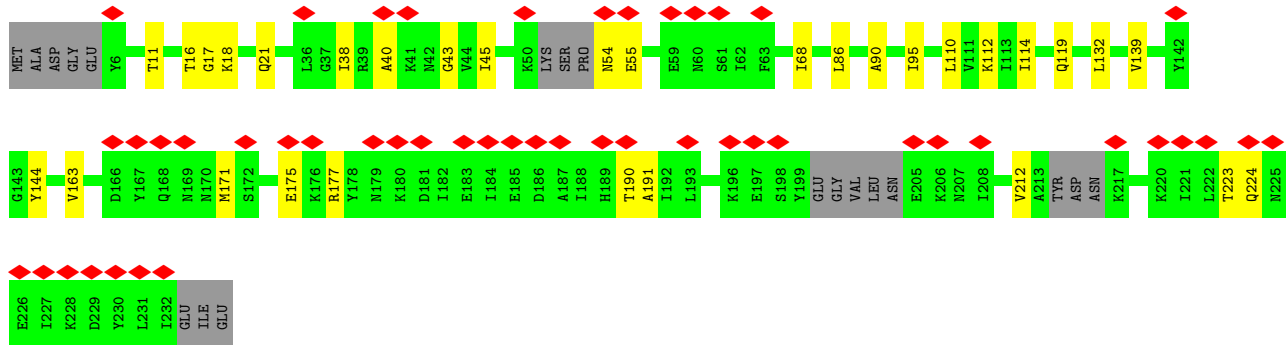
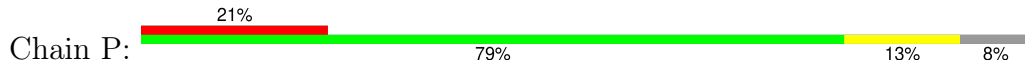

• Molecule 3: Proteasome subunit alpha type

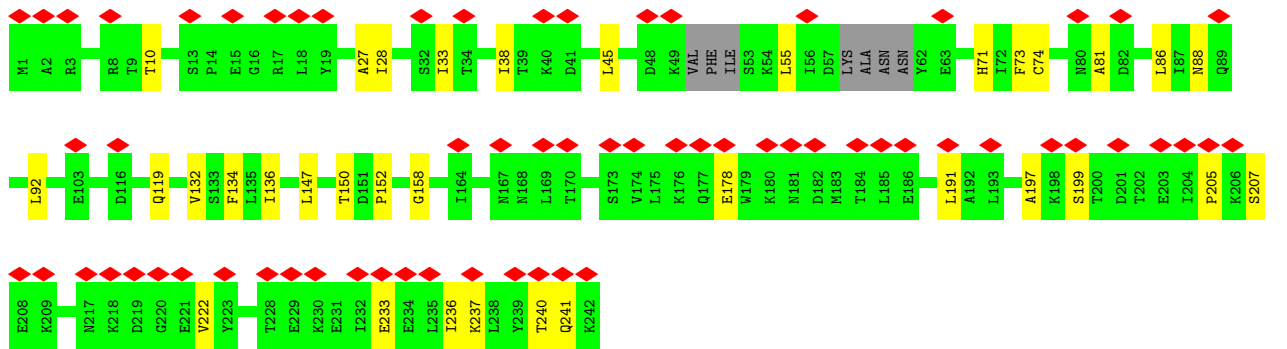
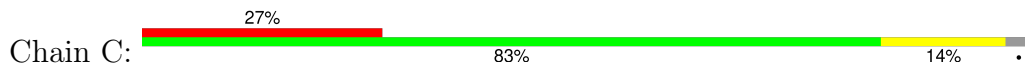

• Molecule 3: Proteasome subunit alpha type

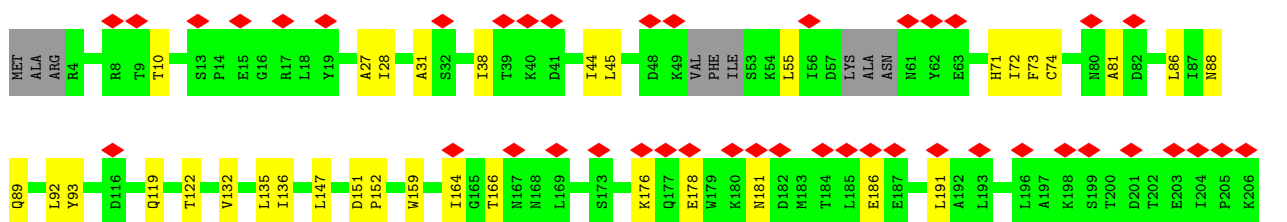
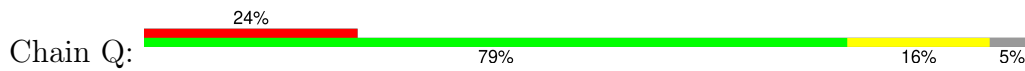

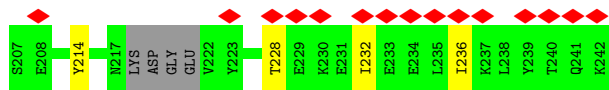

• Molecule 4: Proteasome subunit alpha type

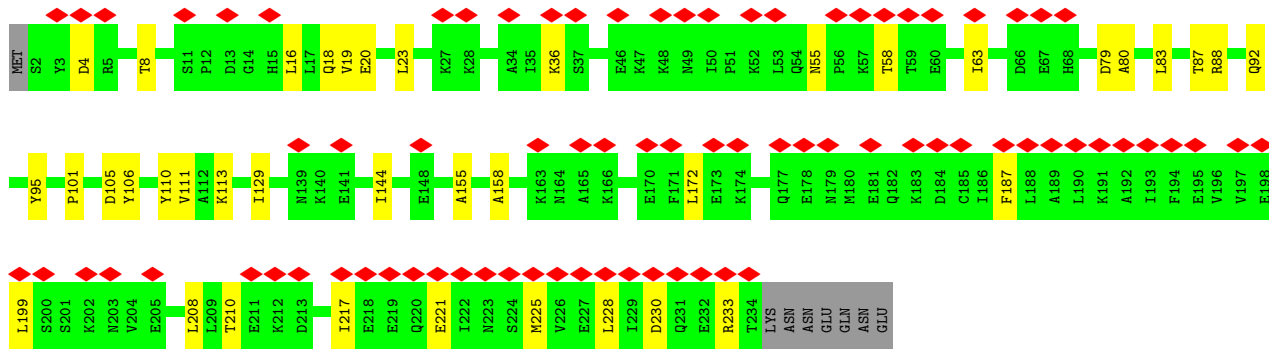
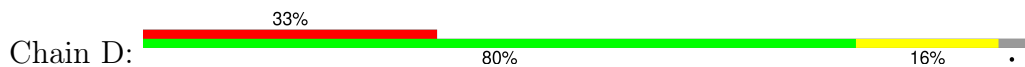

• Molecule 4: Proteasome subunit alpha type

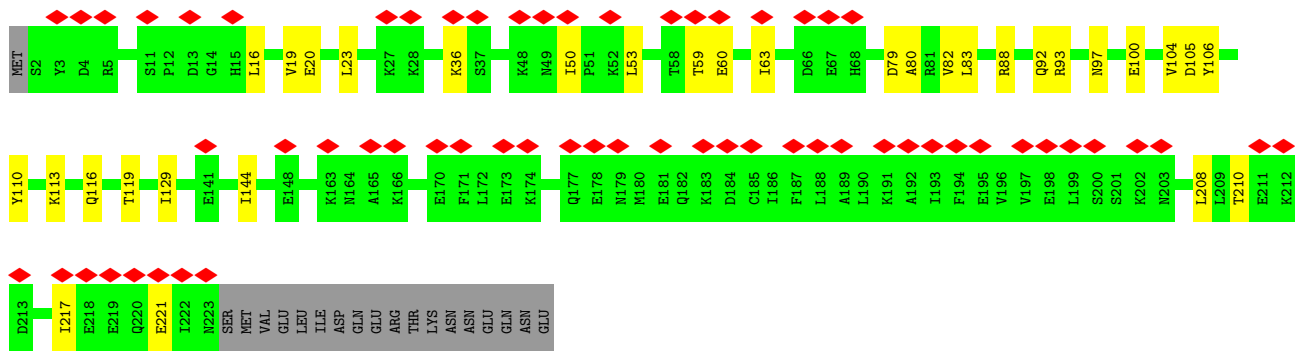
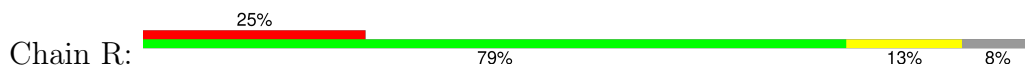

• Molecule 5: Proteasome subunit alpha type

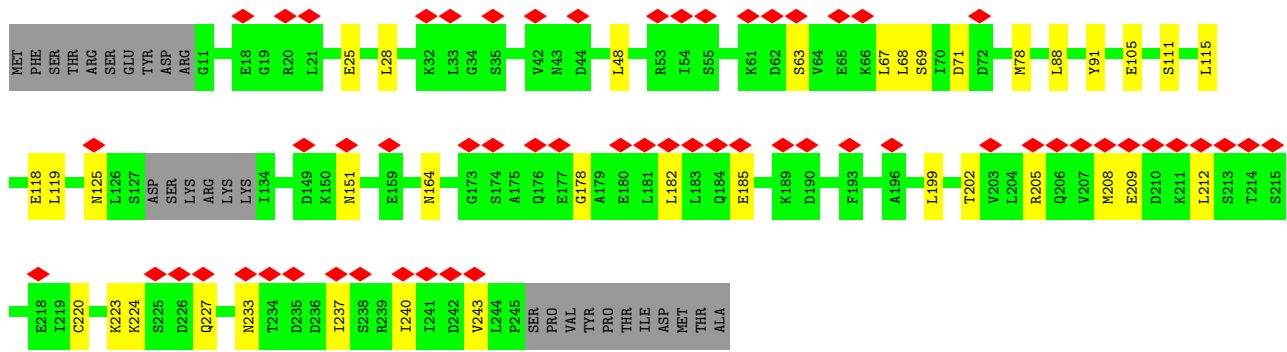
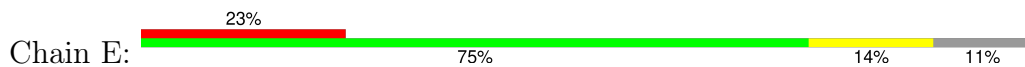

• Molecule 5: Proteasome subunit alpha type

Chain S:

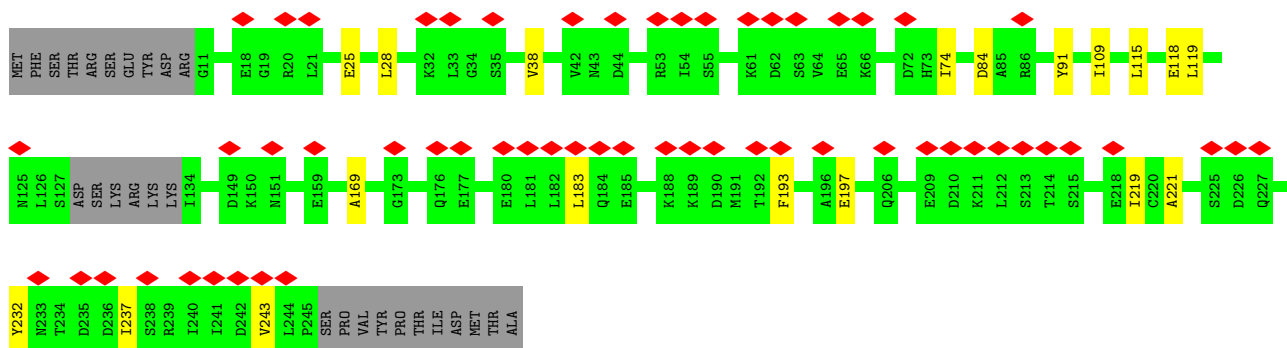

- Molecule 6: Proteasome endopeptidase complex

Chain F:

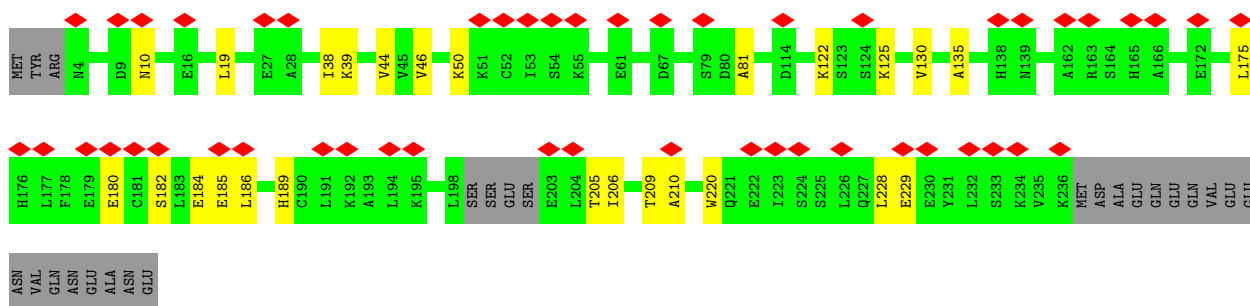

- Molecule 6: Proteasome endopeptidase complex

Chain T:

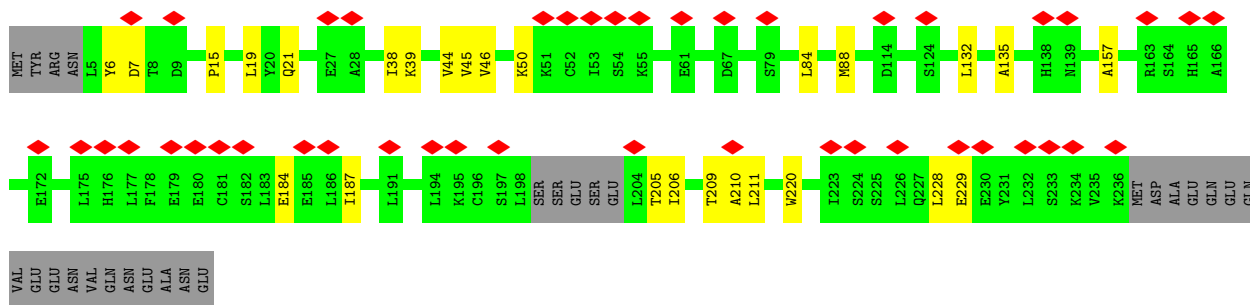

- Molecule 7: Proteasome subunit alpha type-3, putative

Chain G:

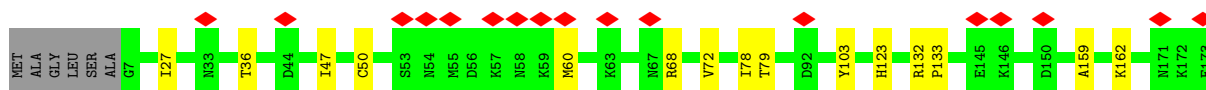

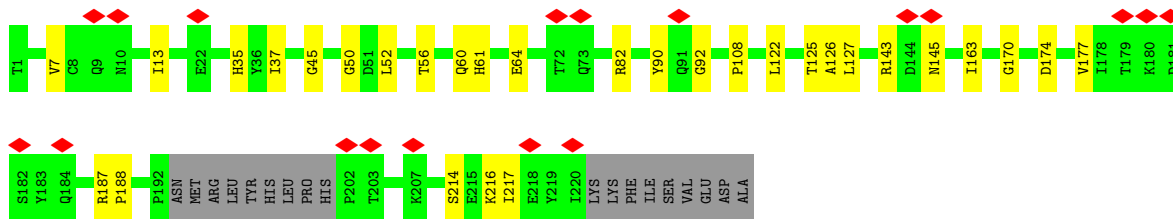

• Molecule 9: Proteasome subunit beta

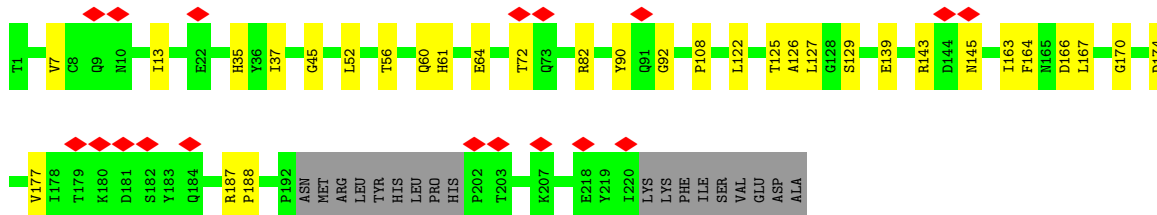
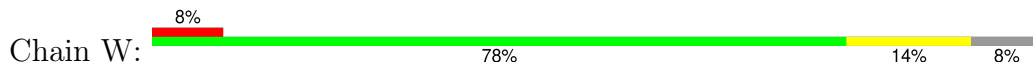

• Molecule 10: Proteasome subunit beta

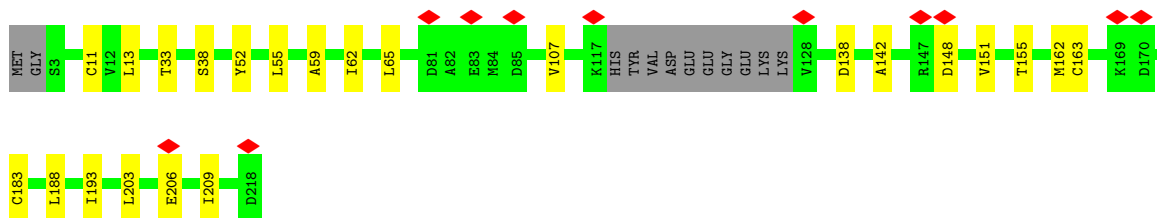
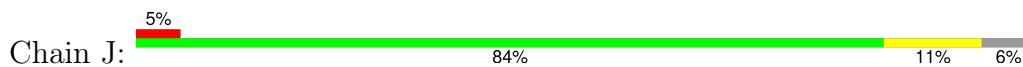

• Molecule 10: Proteasome subunit beta

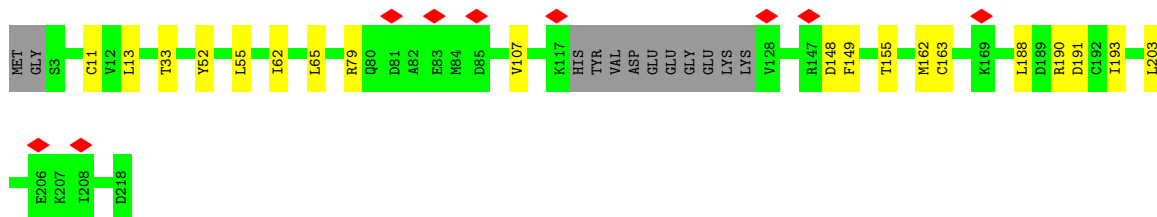
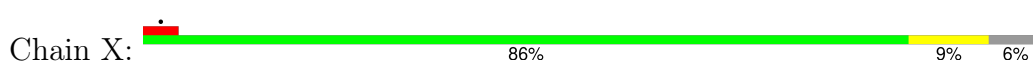

• Molecule 11: Proteasome subunit beta

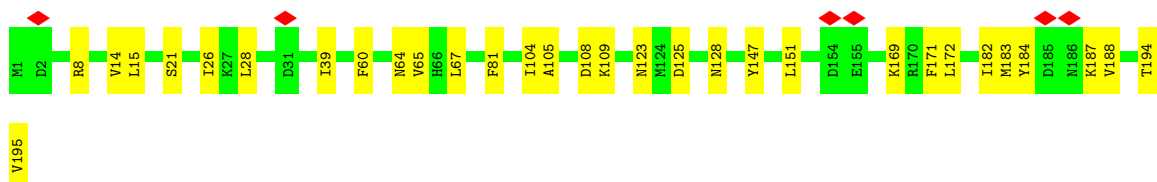
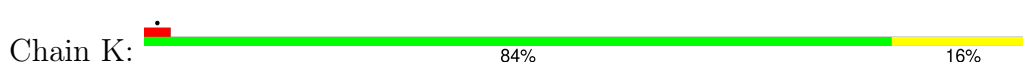

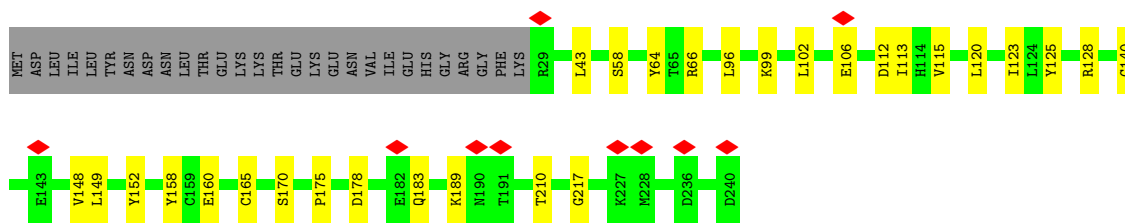

• Molecule 14: Proteasome subunit beta

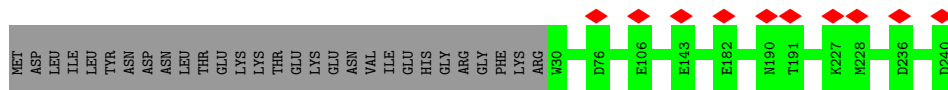
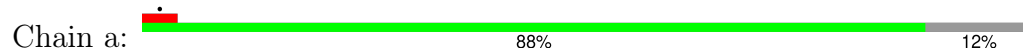

4 Experimental information

Property	Value	Source
EM reconstruction method	SINGLE PARTICLE	Depositor
Imposed symmetry	POINT, C2	Depositor
Number of particles used	20317	Depositor
Resolution determination method	FSC 0.143 CUT-OFF	Depositor
CTF correction method	PHASE FLIPPING AND AMPLITUDE CORRECTION	Depositor
Microscope	FEI TITAN KRIOS	Depositor
Voltage (kV)	300	Depositor
Electron dose ($e^-/\text{\AA}^2$)	60	Depositor
Minimum defocus (nm)	900	Depositor
Maximum defocus (nm)	2200	Depositor
Magnification	105000	Depositor
Image detector	GATAN K3 BIOQUANTUM (6k x 4k)	Depositor
Maximum map value	0.079	Depositor
Minimum map value	-0.039	Depositor
Average map value	0.000	Depositor
Map value standard deviation	0.005	Depositor
Recommended contour level	0.022	Depositor
Map size (Å)	298.8, 298.8, 298.8	wwPDB
Map dimensions	360, 360, 360	wwPDB
Map angles (°)	90.0, 90.0, 90.0	wwPDB
Pixel spacing (Å)	0.83, 0.83, 0.83	Depositor

5 Model quality [i](#)

5.1 Standard geometry [i](#)

Bond lengths and bond angles in the following residue types are not validated in this section: A1AE6

The Z score for a bond length (or angle) is the number of standard deviations the observed value is removed from the expected value. A bond length (or angle) with $|Z| > 5$ is considered an outlier worth inspection. RMSZ is the root-mean-square of all Z scores of the bond lengths (or angles).

Mol	Chain	Bond lengths		Bond angles	
		RMSZ	# Z >5	RMSZ	# Z >5
1	A	0.27	0/1851	0.48	0/2496
1	O	0.26	0/1893	0.48	0/2552
2	B	0.27	0/1724	0.48	0/2322
2	P	0.27	0/1751	0.48	0/2359
3	C	0.28	0/1910	0.49	0/2582
3	Q	0.28	0/1863	0.47	0/2520
4	D	0.27	0/1875	0.48	0/2530
4	R	0.27	0/1785	0.47	0/2409
5	E	0.27	0/1787	0.49	0/2414
5	S	0.26	0/1787	0.48	0/2414
6	F	0.28	0/1853	0.46	0/2495
6	T	0.28	0/1836	0.45	0/2472
7	G	0.28	0/1890	0.47	0/2554
7	U	0.28	0/1966	0.47	0/2656
8	H	0.29	0/1776	0.50	0/2381
8	V	0.28	0/1776	0.49	0/2381
9	I	0.27	0/1633	0.49	0/2218
9	W	0.27	0/1633	0.49	0/2218
10	J	0.29	0/1644	0.50	0/2219
10	X	0.29	0/1644	0.50	0/2219
11	K	0.29	0/1649	0.49	0/2223
11	Y	0.29	0/1649	0.49	0/2223
12	L	0.29	0/1696	0.47	0/2286
12	Z	0.29	0/1696	0.47	0/2286
13	N	0.28	0/1932	0.50	0/2608
13	b	0.28	0/1932	0.50	0/2608
14	M	0.30	0/1719	0.52	0/2328
14	a	0.30	0/1708	0.51	0/2314
All	All	0.28	0/49858	0.48	0/67287

There are no bond length outliers.

There are no bond angle outliers.

There are no chirality outliers.

There are no planarity outliers.

5.2 Too-close contacts [i](#)

In the following table, the Non-H and H(model) columns list the number of non-hydrogen atoms and hydrogen atoms in the chain respectively. The H(added) column lists the number of hydrogen atoms added and optimized by MolProbity. The Clashes column lists the number of clashes within the asymmetric unit, whereas Symm-Clashes lists symmetry-related clashes.

Mol	Chain	Non-H	H(model)	H(added)	Clashes	Symm-Clashes
1	A	1828	0	1825	28	0
1	O	1869	0	1861	23	0
2	B	1696	0	1720	20	0
2	P	1722	0	1750	22	0
3	C	1878	0	1874	28	0
3	Q	1832	0	1823	32	0
4	D	1845	0	1878	28	0
4	R	1755	0	1789	26	0
5	E	1764	0	1767	25	0
5	S	1764	0	1767	12	0
6	F	1820	0	1825	20	0
6	T	1803	0	1813	21	0
7	G	1849	0	1802	17	0
7	U	1925	0	1882	19	0
8	H	1747	0	1761	22	0
8	V	1747	0	1761	15	0
9	I	1602	0	1605	20	0
9	W	1602	0	1605	22	0
10	J	1618	0	1613	20	0
10	X	1618	0	1613	14	0
11	K	1614	0	1584	20	0
11	Y	1614	0	1584	18	0
12	L	1662	0	1618	12	0
12	Z	1662	0	1618	11	0
13	N	1893	0	1859	25	0
13	b	1893	0	1859	0	0
14	M	1687	0	1694	25	0
14	a	1676	0	1681	0	0
15	M	29	0	0	0	0
15	a	29	0	0	0	0
All	All	49043	0	48831	481	0

The all-atom clashscore is defined as the number of clashes found per 1000 atoms (including hydrogen atoms). The all-atom clashscore for this structure is 5.

The worst 5 of 481 close contacts within the same asymmetric unit are listed below, sorted by their clash magnitude.

Atom-1	Atom-2	Interatomic distance (Å)	Clash overlap (Å)
10:X:65:LEU:HD22	10:X:107:VAL:HG21	1.66	0.78
10:J:65:LEU:HD22	10:J:107:VAL:HG21	1.67	0.75
6:F:209:THR:HG23	6:F:228:LEU:HD21	1.69	0.75
6:T:209:THR:HG23	6:T:228:LEU:HD21	1.70	0.74
2:B:11:THR:HG22	2:B:21:GLN:HB2	1.71	0.73

There are no symmetry-related clashes.

5.3 Torsion angles [i](#)

5.3.1 Protein backbone [i](#)

In the following table, the Percentiles column shows the percent Ramachandran outliers of the chain as a percentile score with respect to all PDB entries followed by that with respect to all EM entries.

The Analysed column shows the number of residues for which the backbone conformation was analysed, and the total number of residues.

Mol	Chain	Analysed	Favoured	Allowed	Outliers	Percentiles	
1	A	224/260 (86%)	222 (99%)	2 (1%)	0	100	100
1	O	231/260 (89%)	228 (99%)	3 (1%)	0	100	100
2	B	205/235 (87%)	203 (99%)	2 (1%)	0	100	100
2	P	208/235 (88%)	206 (99%)	2 (1%)	0	100	100
3	C	229/242 (95%)	227 (99%)	2 (1%)	0	100	100
3	Q	221/242 (91%)	215 (97%)	6 (3%)	0	100	100
4	D	231/241 (96%)	225 (97%)	6 (3%)	0	100	100
4	R	220/241 (91%)	213 (97%)	7 (3%)	0	100	100
5	E	225/256 (88%)	220 (98%)	5 (2%)	0	100	100
5	S	225/256 (88%)	222 (99%)	3 (1%)	0	100	100
6	F	225/254 (89%)	221 (98%)	4 (2%)	0	100	100
6	T	223/254 (88%)	219 (98%)	4 (2%)	0	100	100

Continued on next page...

Continued from previous page...

Mol	Chain	Analysed	Favoured	Allowed	Outliers	Percentiles	
7	G	221/252 (88%)	215 (97%)	6 (3%)	0	100	100
7	U	231/252 (92%)	224 (97%)	7 (3%)	0	100	100
8	H	210/252 (83%)	201 (96%)	9 (4%)	0	100	100
8	V	210/252 (83%)	200 (95%)	10 (5%)	0	100	100
9	I	207/229 (90%)	199 (96%)	8 (4%)	0	100	100
9	W	207/229 (90%)	199 (96%)	8 (4%)	0	100	100
10	J	202/218 (93%)	195 (96%)	7 (4%)	0	100	100
10	X	202/218 (93%)	197 (98%)	5 (2%)	0	100	100
11	K	193/195 (99%)	186 (96%)	7 (4%)	0	100	100
11	Y	193/195 (99%)	188 (97%)	5 (3%)	0	100	100
12	L	209/211 (99%)	206 (99%)	3 (1%)	0	100	100
12	Z	209/211 (99%)	205 (98%)	4 (2%)	0	100	100
13	N	226/284 (80%)	218 (96%)	8 (4%)	0	100	100
13	b	226/284 (80%)	218 (96%)	8 (4%)	0	100	100
14	M	210/240 (88%)	203 (97%)	7 (3%)	0	100	100
14	a	209/240 (87%)	202 (97%)	7 (3%)	0	100	100
All	All	6032/6738 (90%)	5877 (97%)	155 (3%)	0	100	100

There are no Ramachandran outliers to report.

5.3.2 Protein sidechains [i](#)

In the following table, the Percentiles column shows the percent sidechain outliers of the chain as a percentile score with respect to all PDB entries followed by that with respect to all EM entries.

The Analysed column shows the number of residues for which the sidechain conformation was analysed, and the total number of residues.

Mol	Chain	Analysed	Rotameric	Outliers	Percentiles	
1	A	204/231 (88%)	204 (100%)	0	100	100
1	O	208/231 (90%)	208 (100%)	0	100	100
2	B	186/205 (91%)	186 (100%)	0	100	100
2	P	189/205 (92%)	189 (100%)	0	100	100
3	C	203/209 (97%)	203 (100%)	0	100	100

Continued on next page...

Continued from previous page...

Mol	Chain	Analysed	Rotameric	Outliers	Percentiles	
3	Q	199/209 (95%)	199 (100%)	0	100	100
4	D	199/207 (96%)	199 (100%)	0	100	100
4	R	188/207 (91%)	188 (100%)	0	100	100
5	E	197/223 (88%)	197 (100%)	0	100	100
5	S	197/223 (88%)	197 (100%)	0	100	100
6	F	204/227 (90%)	204 (100%)	0	100	100
6	T	202/227 (89%)	202 (100%)	0	100	100
7	G	206/229 (90%)	206 (100%)	0	100	100
7	U	215/229 (94%)	215 (100%)	0	100	100
8	H	197/231 (85%)	197 (100%)	0	100	100
8	V	197/231 (85%)	196 (100%)	1 (0%)	86	92
9	I	177/194 (91%)	177 (100%)	0	100	100
9	W	177/194 (91%)	177 (100%)	0	100	100
10	J	181/191 (95%)	181 (100%)	0	100	100
10	X	181/191 (95%)	181 (100%)	0	100	100
11	K	174/174 (100%)	174 (100%)	0	100	100
11	Y	174/174 (100%)	174 (100%)	0	100	100
12	L	176/176 (100%)	176 (100%)	0	100	100
12	Z	176/176 (100%)	176 (100%)	0	100	100
13	N	207/255 (81%)	207 (100%)	0	100	100
13	b	207/255 (81%)	207 (100%)	0	100	100
14	M	190/216 (88%)	190 (100%)	0	100	100
14	a	189/216 (88%)	189 (100%)	0	100	100
All	All	5400/5936 (91%)	5399 (100%)	1 (0%)	100	100

All (1) residues with a non-rotameric sidechain are listed below:

Mol	Chain	Res	Type
8	V	137	LYS

Sometimes sidechains can be flipped to improve hydrogen bonding and reduce clashes. 5 of 8 such sidechains are listed below:

Mol	Chain	Res	Type
13	b	89	GLN
8	V	245	ASN
13	N	89	GLN
8	H	245	ASN
6	T	100	ASN

5.3.3 RNA [i](#)

There are no RNA molecules in this entry.

5.4 Non-standard residues in protein, DNA, RNA chains [i](#)

There are no non-standard protein/DNA/RNA residues in this entry.

5.5 Carbohydrates [i](#)

There are no oligosaccharides in this entry.

5.6 Ligand geometry [i](#)

2 ligands are modelled in this entry.

In the following table, the Counts columns list the number of bonds (or angles) for which Mogul statistics could be retrieved, the number of bonds (or angles) that are observed in the model and the number of bonds (or angles) that are defined in the Chemical Component Dictionary. The Link column lists molecule types, if any, to which the group is linked. The Z score for a bond length (or angle) is the number of standard deviations the observed value is removed from the expected value. A bond length (or angle) with $|Z| > 2$ is considered an outlier worth inspection. RMSZ is the root-mean-square of all Z scores of the bond lengths (or angles).

Mol	Type	Chain	Res	Link	Bond lengths			Bond angles		
					Counts	RMSZ	# $ Z > 2$	Counts	RMSZ	# $ Z > 2$
15	A1AE6	M	301	-	28,31,31	2.31	10 (35%)	34,41,41	2.02	9 (26%)
15	A1AE6	a	301	-	28,31,31	2.31	10 (35%)	34,41,41	2.04	9 (26%)

In the following table, the Chirals column lists the number of chiral outliers, the number of chiral centers analysed, the number of these observed in the model and the number defined in the Chemical Component Dictionary. Similar counts are reported in the Torsion and Rings columns. '-' means no outliers of that kind were identified.

Mol	Type	Chain	Res	Link	Chirals	Torsions	Rings
15	A1AE6	M	301	-	-	4/20/32/32	0/3/3/3
15	A1AE6	a	301	-	-	4/20/32/32	0/3/3/3

The worst 5 of 20 bond length outliers are listed below:

Mol	Chain	Res	Type	Atoms	Z	Observed(Å)	Ideal(Å)
15	M	301	A1AE6	C05-C08	-6.39	1.39	1.49
15	a	301	A1AE6	C05-C08	-6.36	1.39	1.49
15	M	301	A1AE6	C22-N20	5.51	1.45	1.35
15	a	301	A1AE6	C22-N20	5.47	1.45	1.35
15	a	301	A1AE6	C14-N13	4.88	1.45	1.33

The worst 5 of 18 bond angle outliers are listed below:

Mol	Chain	Res	Type	Atoms	Z	Observed(°)	Ideal(°)
15	a	301	A1AE6	C08-C09-S10	-6.06	104.35	111.79
15	M	301	A1AE6	C08-C09-S10	-6.03	104.38	111.79
15	a	301	A1AE6	C09-C08-C05	-4.88	122.66	129.44
15	M	301	A1AE6	C09-C08-C05	-4.75	122.83	129.44
15	a	301	A1AE6	C06-N07-C02	3.39	121.53	117.53

There are no chirality outliers.

5 of 8 torsion outliers are listed below:

Mol	Chain	Res	Type	Atoms
15	M	301	A1AE6	O25-C26-C27-F28
15	a	301	A1AE6	O25-C26-C27-F28
15	a	301	A1AE6	N20-C22-C24-O25
15	M	301	A1AE6	N20-C22-C24-O25
15	a	301	A1AE6	O23-C22-C24-O25

There are no ring outliers.

No monomer is involved in short contacts.

The following is a two-dimensional graphical depiction of Mogul quality analysis of bond lengths, bond angles, torsion angles, and ring geometry for all instances of the Ligand of Interest. In addition, ligands with molecular weight > 250 and outliers as shown on the validation Tables will also be included. For torsion angles, if less than 5% of the Mogul distribution of torsion angles is within 10 degrees of the torsion angle in question, then that torsion angle is considered an outlier. Any bond that is central to one or more torsion angles identified as an outlier by Mogul will be highlighted in the graph. For rings, the root-mean-square deviation (RMSD) between the ring in question and similar rings identified by Mogul is calculated over all ring torsion angles. If the

average RMSD is greater than 60 degrees and the minimal RMSD between the ring in question and any Mogul-identified rings is also greater than 60 degrees, then that ring is considered an outlier. The outliers are highlighted in purple. The color gray indicates Mogul did not find sufficient equivalents in the CSD to analyse the geometry.

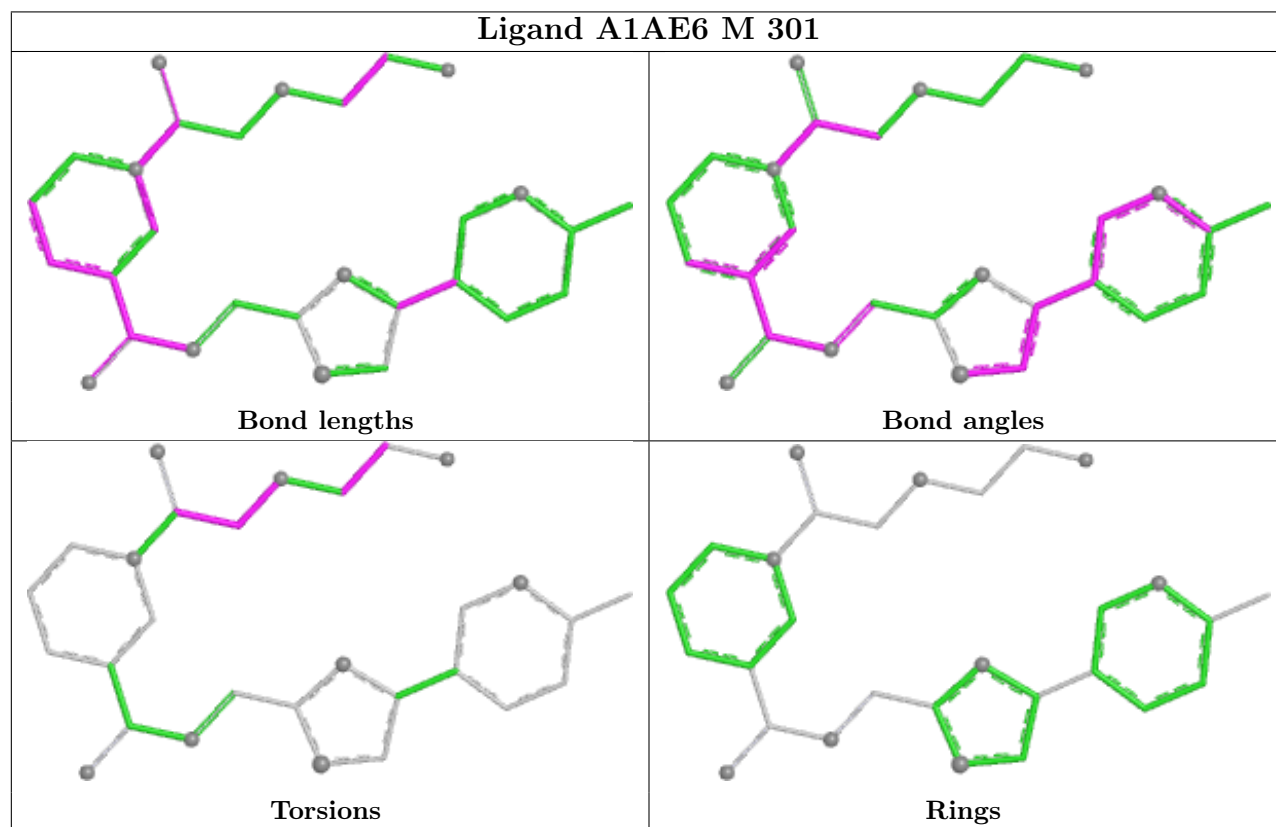

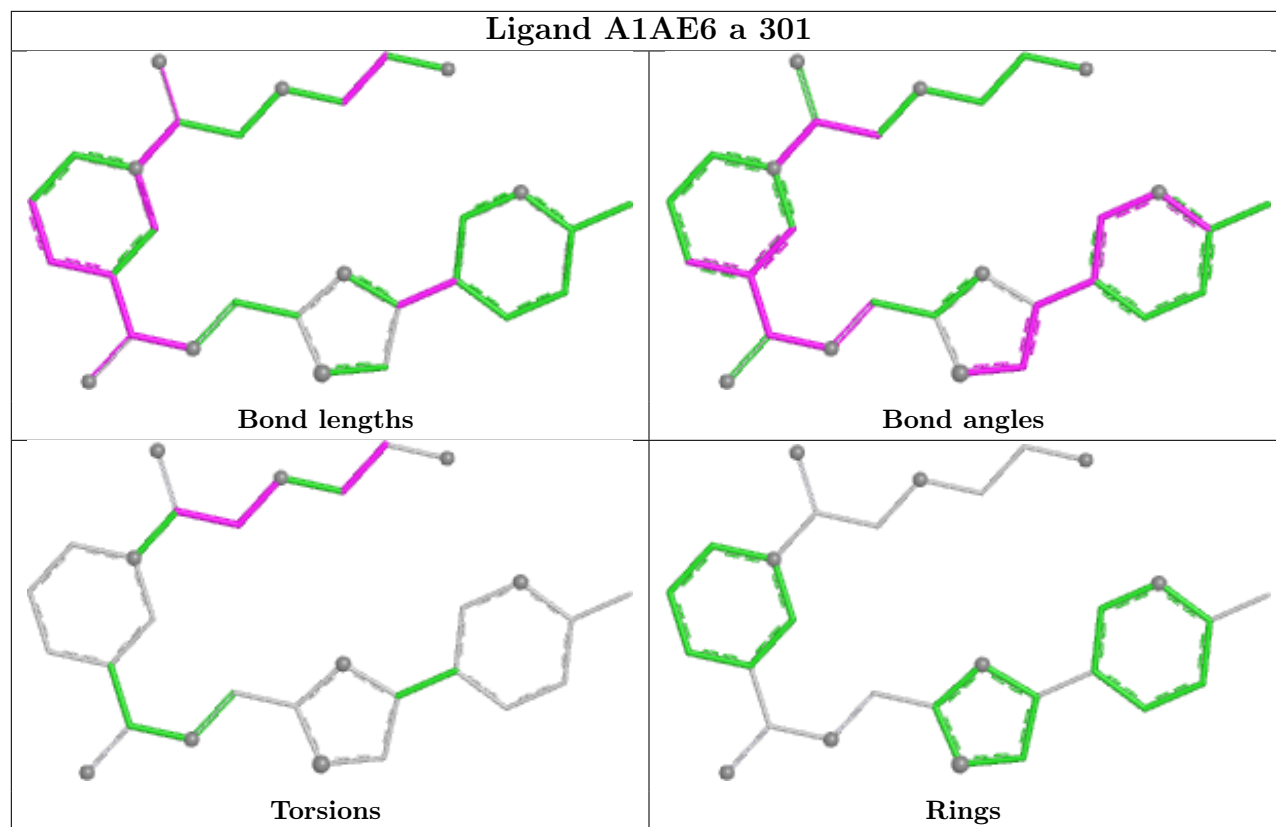

5.7 Other polymers [i](#)

There are no such residues in this entry.

5.8 Polymer linkage issues [i](#)

There are no chain breaks in this entry.

6 Map visualisation [i](#)

This section contains visualisations of the EMDB entry EMD-43746. These allow visual inspection of the internal detail of the map and identification of artifacts.

Images derived from a raw map, generated by summing the deposited half-maps, are presented below the corresponding image components of the primary map to allow further visual inspection and comparison with those of the primary map.

6.1 Orthogonal projections [i](#)

6.1.1 Primary map

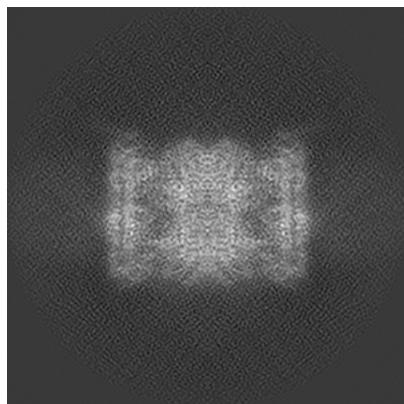

X

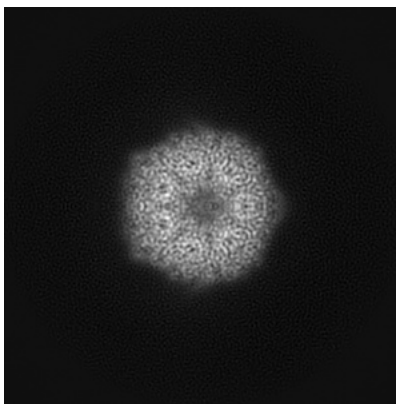

Y

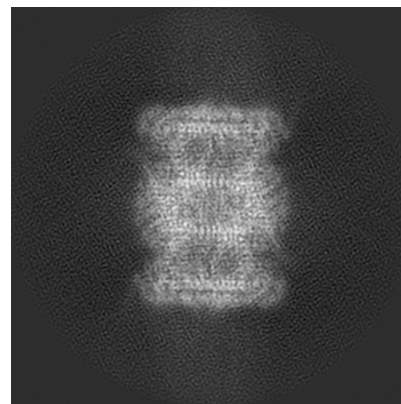

Z

6.1.2 Raw map

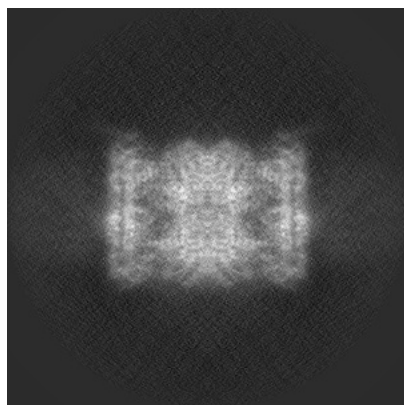

X

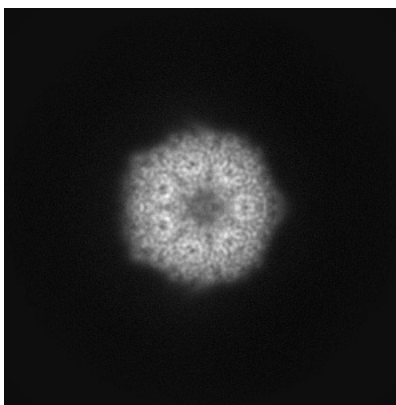

Y

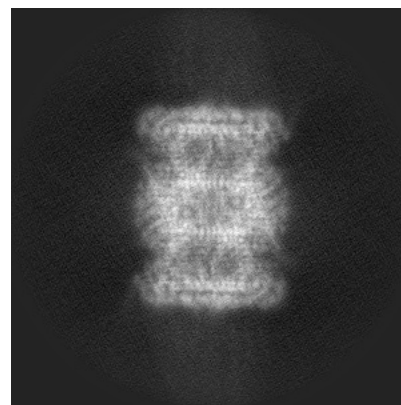

Z

The images above show the map projected in three orthogonal directions.

6.2 Central slices [i](#)

6.2.1 Primary map

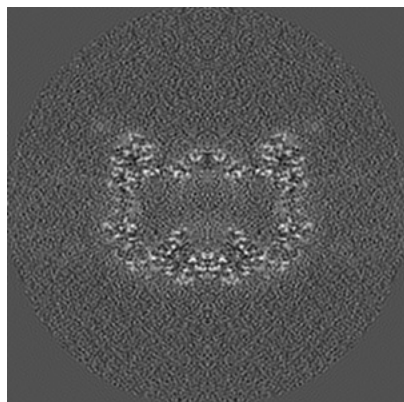

X Index: 180

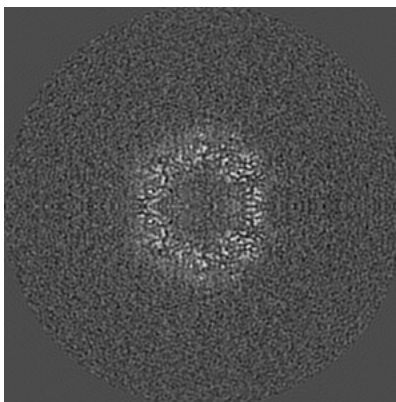

Y Index: 180

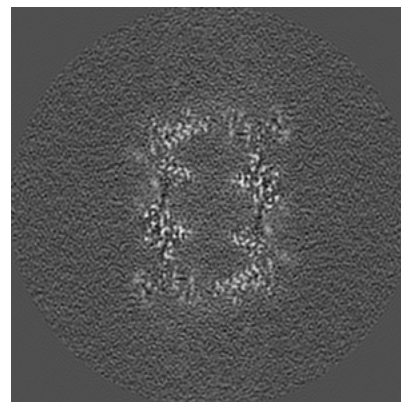

Z Index: 180

6.2.2 Raw map

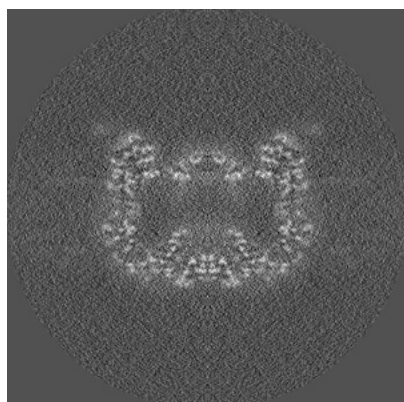

X Index: 180

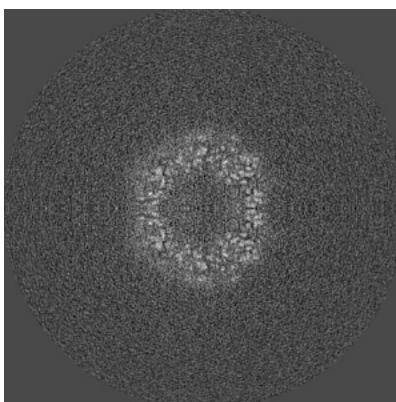

Y Index: 180

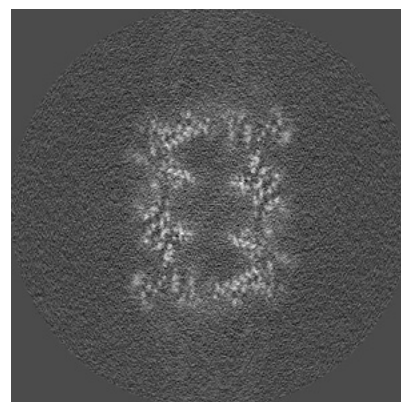

Z Index: 180

The images above show central slices of the map in three orthogonal directions.

6.3 Largest variance slices [i](#)

6.3.1 Primary map

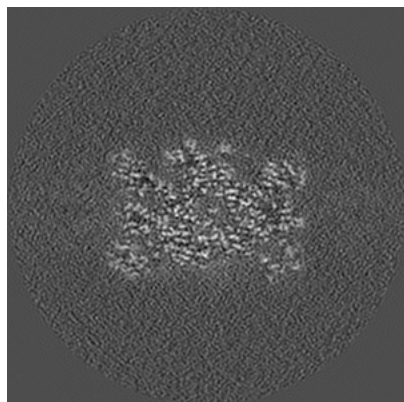

X Index: 146

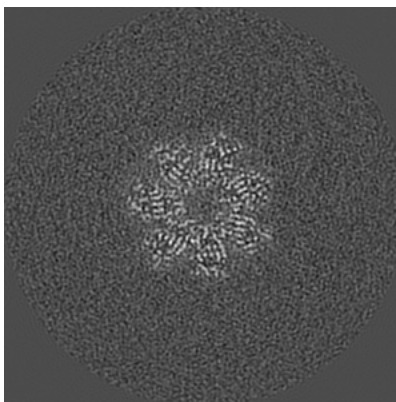

Y Index: 158

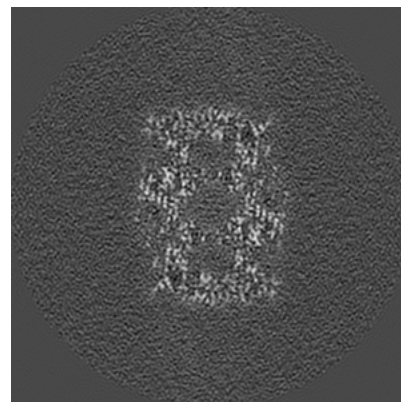

Z Index: 199

6.3.2 Raw map

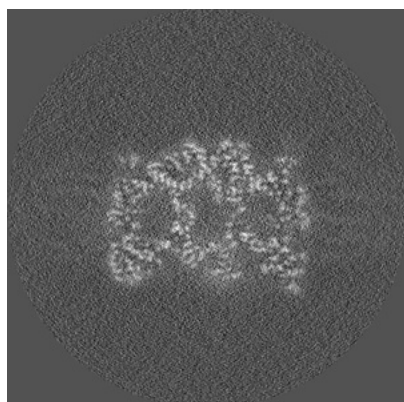

X Index: 157

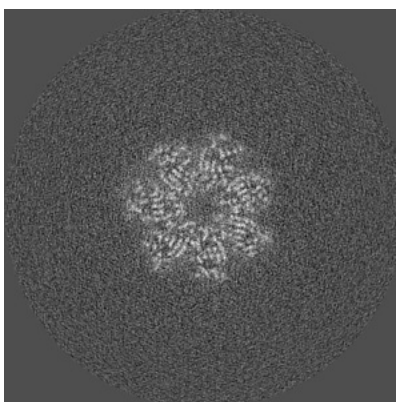

Y Index: 158

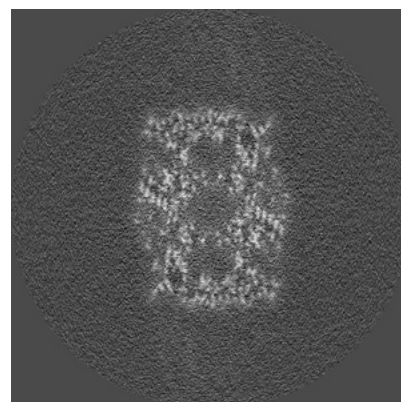

Z Index: 199

The images above show the largest variance slices of the map in three orthogonal directions.

6.4 Orthogonal standard-deviation projections (False-color) [i](#)

6.4.1 Primary map

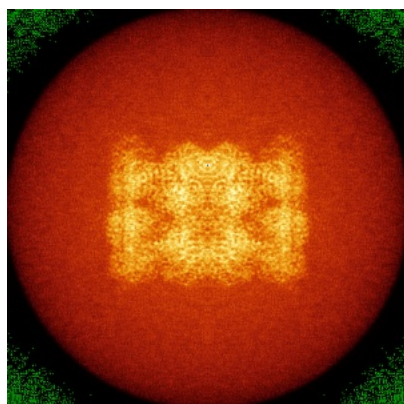

X

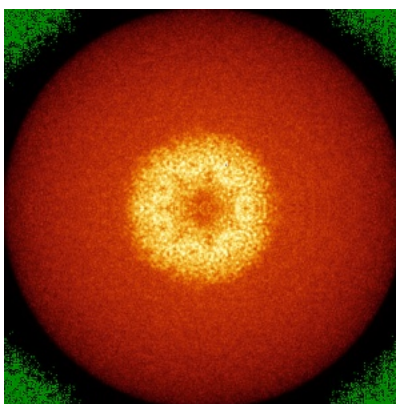

Y

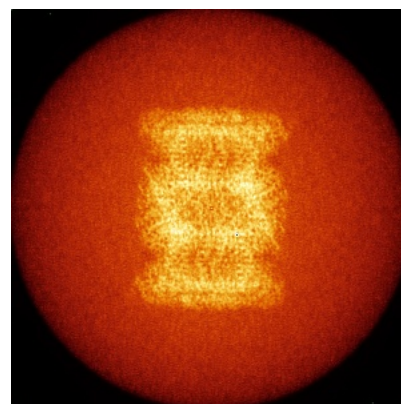

Z

6.4.2 Raw map

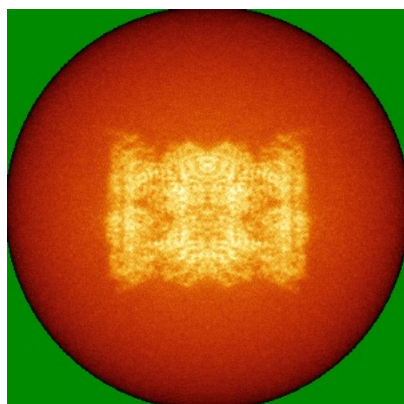

X

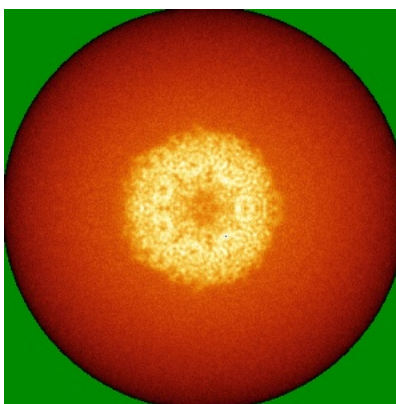

Y

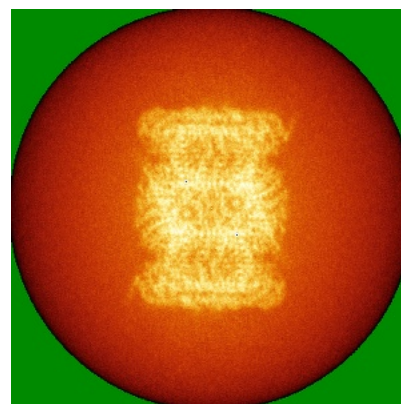

Z

The images above show the map standard deviation projections with false color in three orthogonal directions. Minimum values are shown in green, max in blue, and dark to light orange shades represent small to large values respectively.

6.5 Orthogonal surface views [i](#)

6.5.1 Primary map

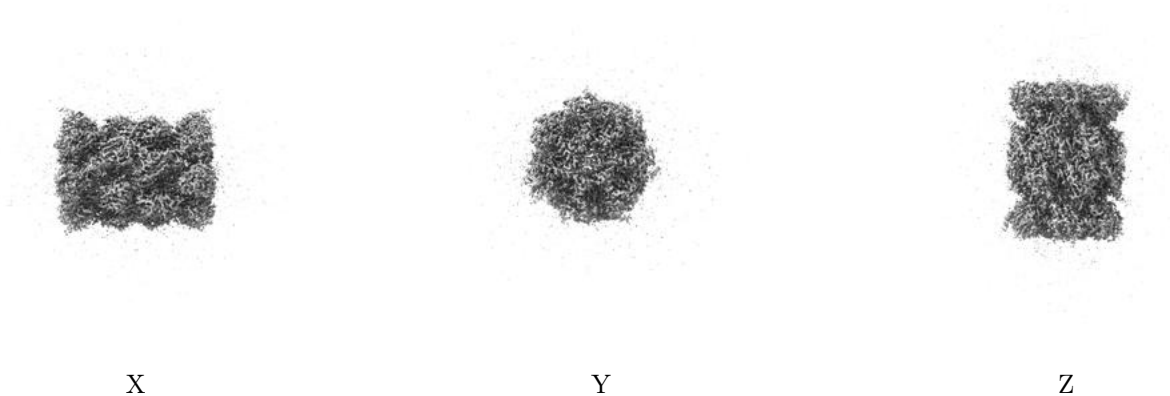

The images above show the 3D surface view of the map at the recommended contour level 0.022. These images, in conjunction with the slice images, may facilitate assessment of whether an appropriate contour level has been provided.

6.5.2 Raw map

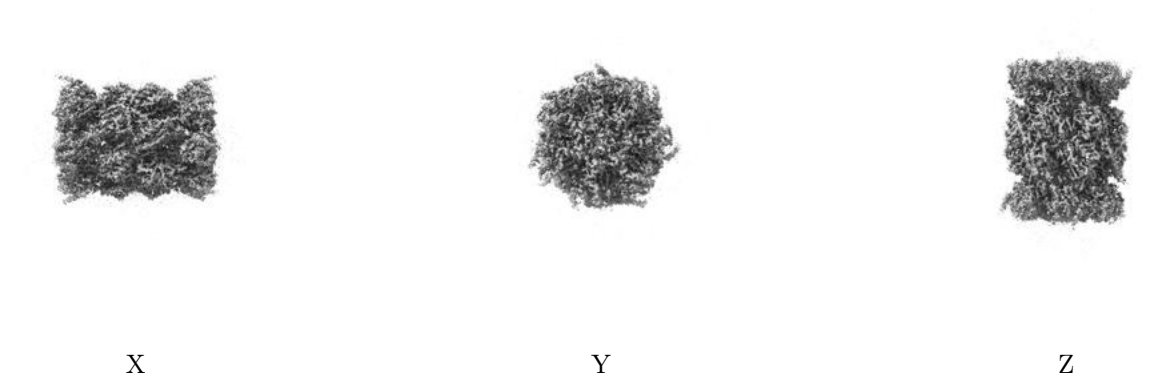

These images show the 3D surface of the raw map. The raw map's contour level was selected so that its surface encloses the same volume as the primary map does at its recommended contour level.

6.6 Mask visualisation [i](#)

This section was not generated. No masks/segmentation were deposited.

7 Map analysis [i](#)

This section contains the results of statistical analysis of the map.

7.1 Map-value distribution [i](#)

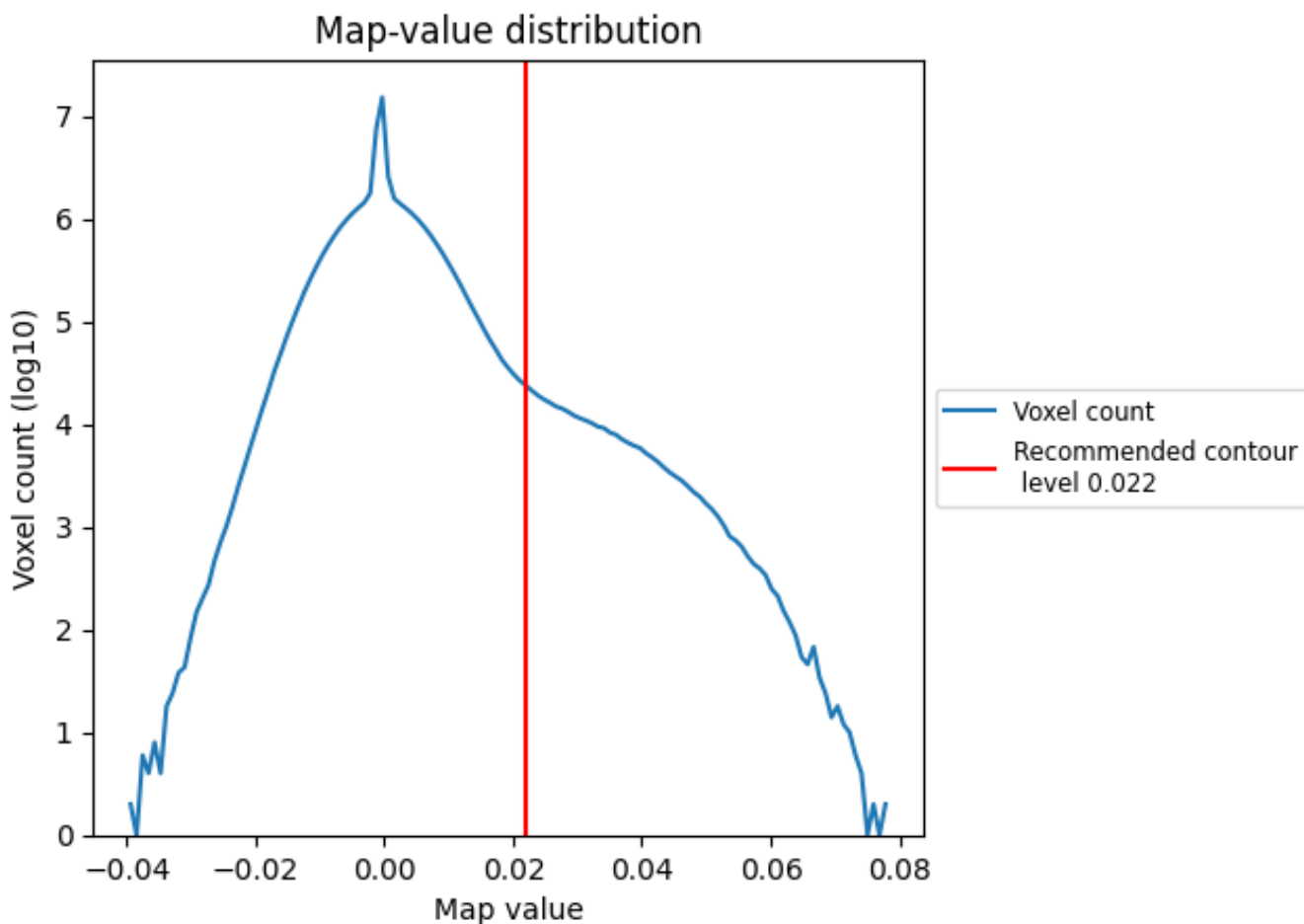

The map-value distribution is plotted in 128 intervals along the x-axis. The y-axis is logarithmic. A spike in this graph at zero usually indicates that the volume has been masked.

7.2 Volume estimate [i](#)

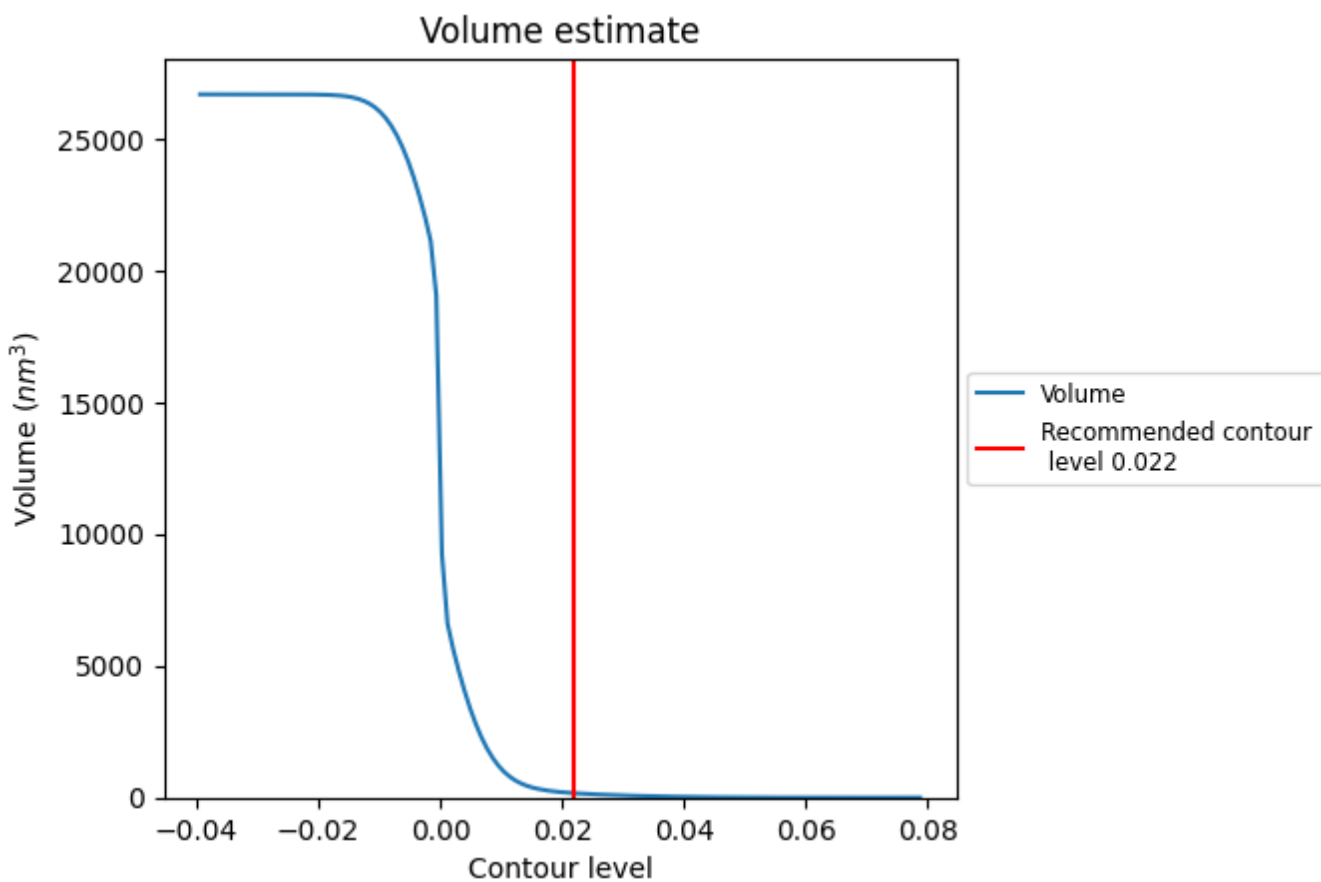

The volume at the recommended contour level is 166 nm^3 ; this corresponds to an approximate mass of 150 kDa.

The volume estimate graph shows how the enclosed volume varies with the contour level. The recommended contour level is shown as a vertical line and the intersection between the line and the curve gives the volume of the enclosed surface at the given level.

7.3 Rotationally averaged power spectrum [i](#)

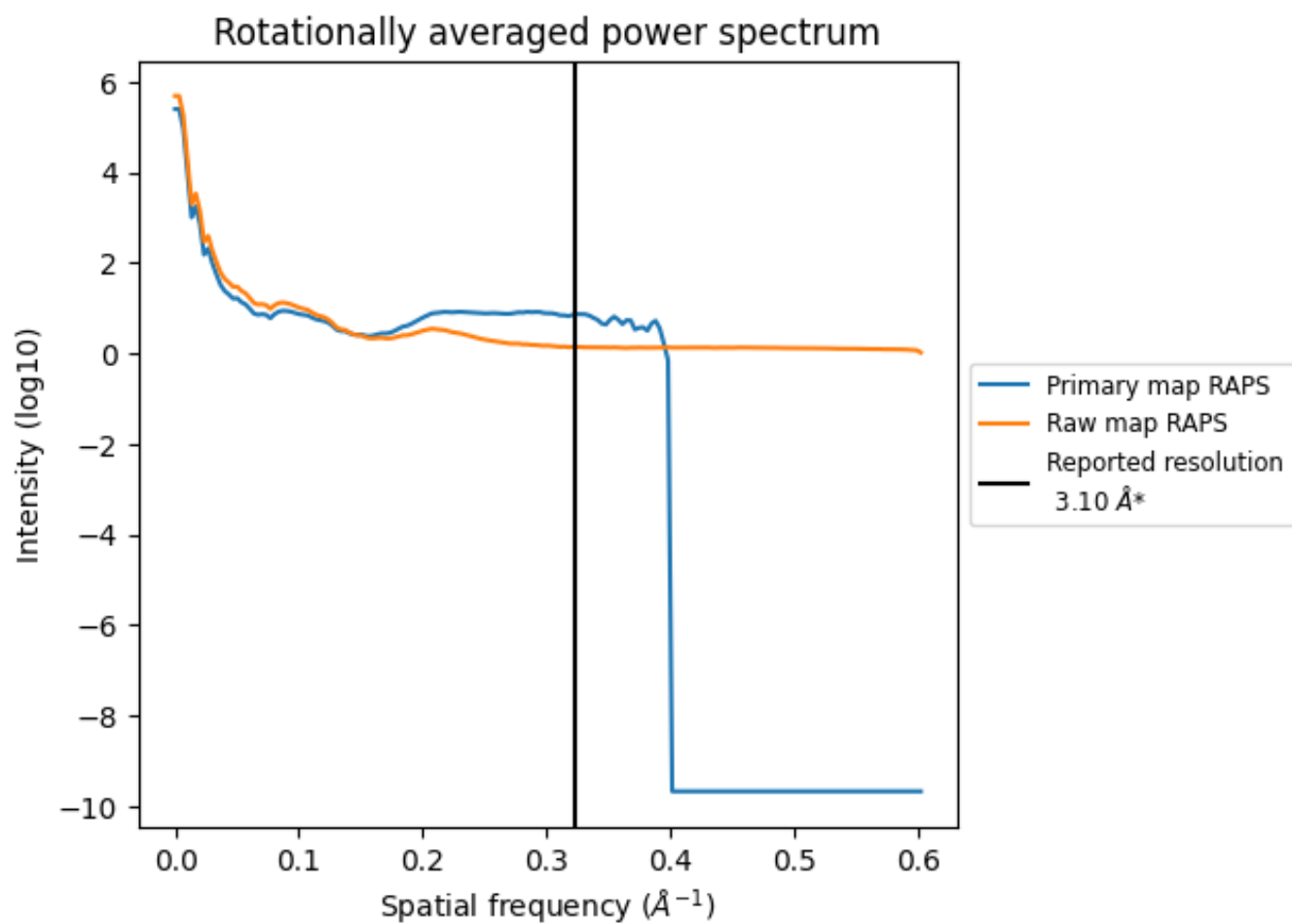

*Reported resolution corresponds to spatial frequency of 0.323 Å⁻¹

8 Fourier-Shell correlation [i](#)

Fourier-Shell Correlation (FSC) is the most commonly used method to estimate the resolution of single-particle and subtomogram-averaged maps. The shape of the curve depends on the imposed symmetry, mask and whether or not the two 3D reconstructions used were processed from a common reference. The reported resolution is shown as a black line. A curve is displayed for the half-bit criterion in addition to lines showing the 0.143 gold standard cut-off and 0.5 cut-off.

8.1 FSC [i](#)

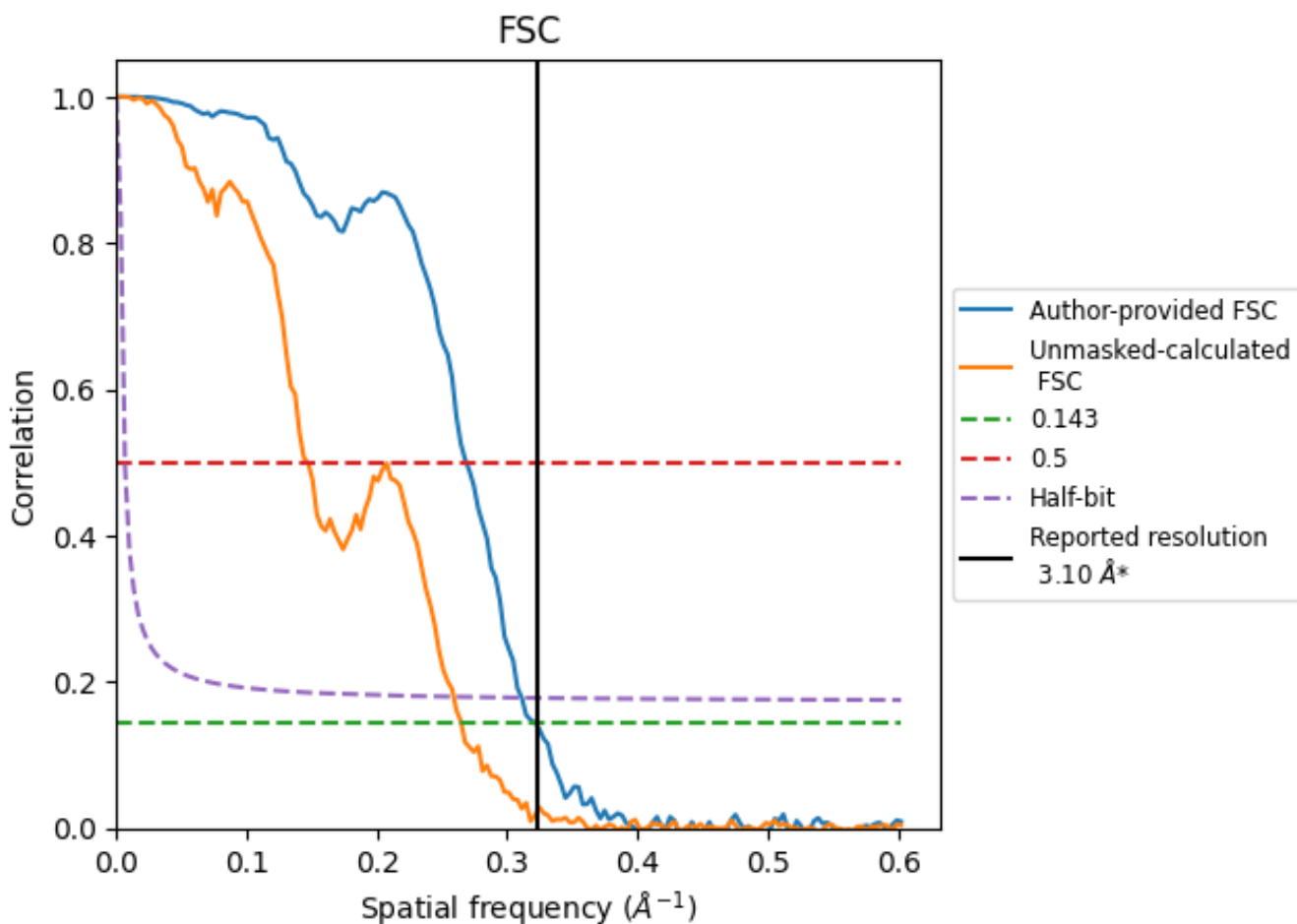

*Reported resolution corresponds to spatial frequency of 0.323 Å⁻¹

8.2 Resolution estimates [i](#)

Resolution estimate (Å)	Estimation criterion (FSC cut-off)		
	0.143	0.5	Half-bit
Reported by author	3.10	-	-
Author-provided FSC curve	3.11	3.72	3.21
Unmasked-calculated*	3.78	6.82	3.86

*Resolution estimate based on FSC curve calculated by comparison of deposited half-maps. The value from deposited half-maps intersecting FSC 0.143 CUT-OFF 3.78 differs from the reported value 3.1 by more than 10 %

9 Map-model fit [i](#)

This section contains information regarding the fit between EMDB map EMD-43746 and PDB model 8W2F. Per-residue inclusion information can be found in section 3 on page 9.

9.1 Map-model overlay [i](#)

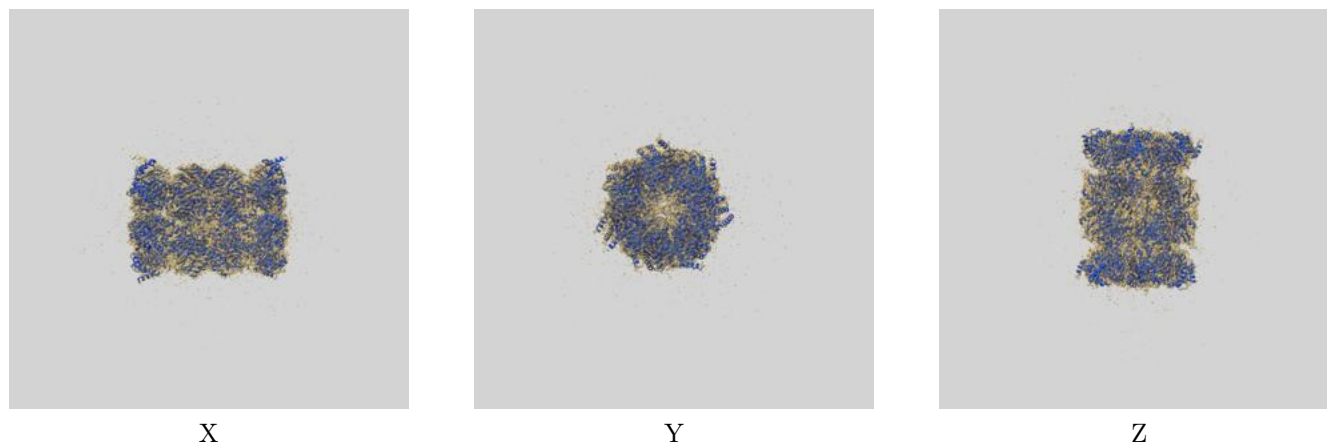

The images above show the 3D surface view of the map at the recommended contour level 0.022 at 50% transparency in yellow overlaid with a ribbon representation of the model coloured in blue. These images allow for the visual assessment of the quality of fit between the atomic model and the map.

9.2 Q-score mapped to coordinate model [i](#)

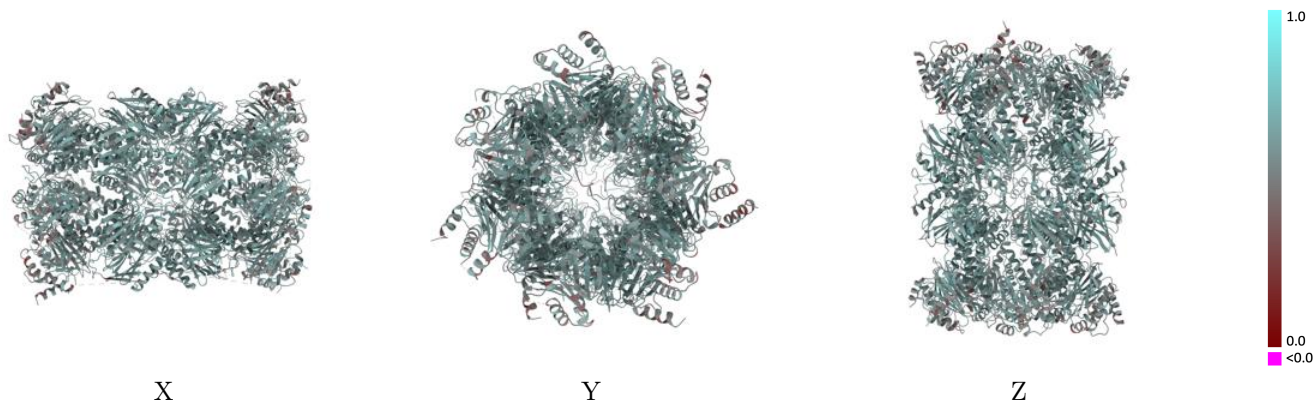

The images above show the model with each residue coloured according to its Q-score. This shows their resolvability in the map with higher Q-score values reflecting better resolvability. Please note: Q-score is calculating the resolvability of atoms, and thus high values are only expected at resolutions at which atoms can be resolved. Low Q-score values may therefore be expected for many entries.

9.3 Atom inclusion mapped to coordinate model [i](#)

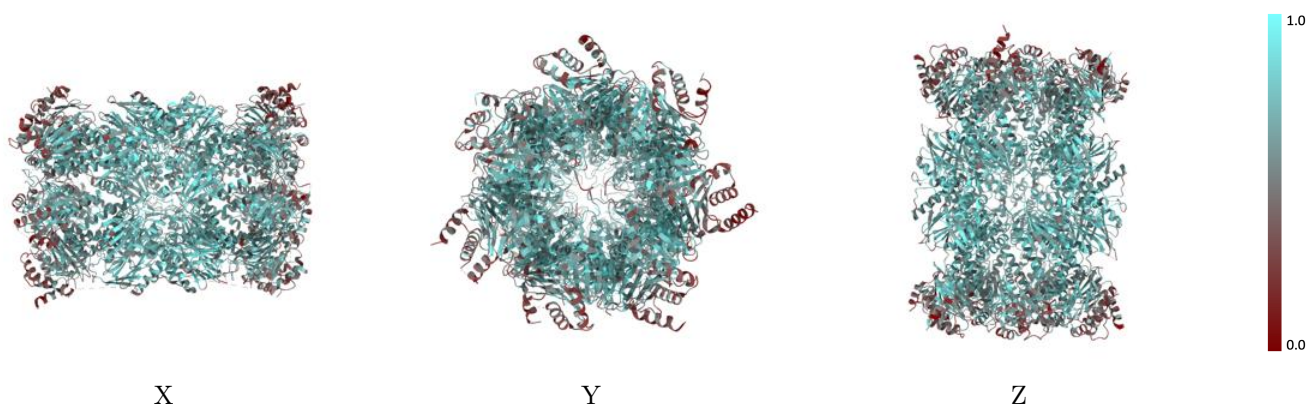

The images above show the model with each residue coloured according to its atom inclusion. This shows to what extent they are inside the map at the recommended contour level (0.022).



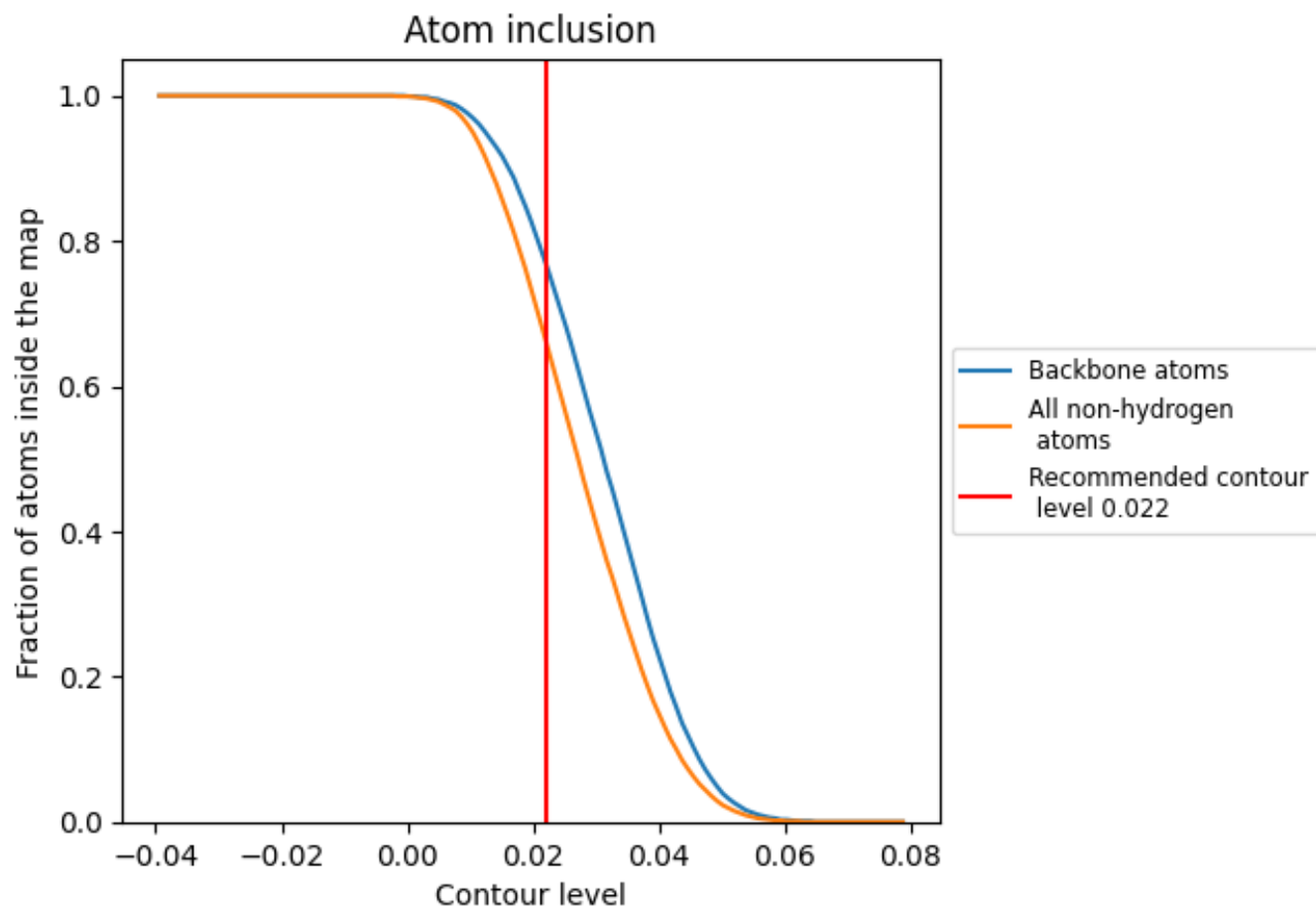























































9.4 Atom inclusion [i](#)



At the recommended contour level, 77% of all backbone atoms, 66% of all non-hydrogen atoms, are inside the map.

9.5 Map-model fit summary

The table lists the average atom inclusion at the recommended contour level (0.022) and Q-score for the entire model and for each chain.

Chain	Atom inclusion	Q-score
All	 0.6630	 0.5760
A	 0.5780	 0.5580
B	 0.5860	 0.5510
C	 0.5690	 0.5460
D	 0.5160	 0.5360
E	 0.5530	 0.5530
F	 0.6040	 0.5670
G	 0.6410	 0.5670
H	 0.7310	 0.5910
I	 0.7240	 0.5860
J	 0.7780	 0.6030
K	 0.7580	 0.6000
L	 0.7790	 0.6080
M	 0.7560	 0.5990
N	 0.7470	 0.6010
O	 0.5700	 0.5510
P	 0.5770	 0.5540
Q	 0.5820	 0.5480
R	 0.5390	 0.5500
S	 0.5590	 0.5560
T	 0.6070	 0.5680
U	 0.6250	 0.5640
V	 0.7310	 0.5870
W	 0.7230	 0.5860
X	 0.7800	 0.6050
Y	 0.7590	 0.5980
Z	 0.7770	 0.6070
a	 0.7610	 0.5990
b	 0.7470	 0.6000

