



wwPDB EM Validation Summary Report ⓘ

Sep 28, 2022 – 04:03 AM JST

PDB ID : 7VRT
EMDB ID : EMD-32103
Title : The unexpanded head structure of phage T4
Authors : Fang, Q.; Tang, W.; Fokine, A.; Mahalingam, M.; Shao, Q.; Rossmann, M.G.;
Rao, V.B.
Deposited on : 2021-10-24
Resolution : 5.10 Å(reported)

This is a wwPDB EM Validation Summary Report for a publicly released PDB entry.

We welcome your comments at validation@mail.wwpdb.org

A user guide is available at

<https://www.wwpdb.org/validation/2017/EMValidationReportHelp>

with specific help available everywhere you see the ⓘ symbol.

The types of validation reports are described at

<http://www.wwpdb.org/validation/2017/FAQs#types>.

The following versions of software and data (see [references ⓘ](#)) were used in the production of this report:

EMDB validation analysis : 0.0.1.dev43
MolProbity : 4.02b-467
Percentile statistics : 20191225.v01 (using entries in the PDB archive December 25th 2019)
MapQ : 1.9.9
Ideal geometry (proteins) : Engh & Huber (2001)
Ideal geometry (DNA, RNA) : Parkinson et al. (1996)
Validation Pipeline (wwPDB-VP) : 2.31.2

1 Overall quality at a glance

The following experimental techniques were used to determine the structure:
ELECTRON MICROSCOPY

The reported resolution of this entry is 5.10 Å.

Percentile scores (ranging between 0-100) for global validation metrics of the entry are shown in the following graphic. The table shows the number of entries on which the scores are based.

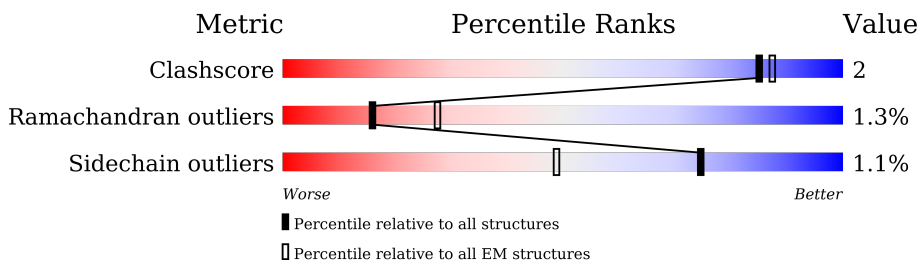

Metric	Whole archive (#Entries)	EM structures (#Entries)
Clashscore	158937	4297
Ramachandran outliers	154571	4023
Sidechain outliers	154315	3826

The table below summarises the geometric issues observed across the polymeric chains and their fit to the map. The red, orange, yellow and green segments of the bar indicate the fraction of residues that contain outliers for ≥ 3 , 2, 1 and 0 types of geometric quality criteria respectively. A grey segment represents the fraction of residues that are not modelled. The numeric value for each fraction is indicated below the corresponding segment, with a dot representing fractions $\leq 5\%$. The upper red bar (where present) indicates the fraction of residues that have poor fit to the EM map (all-atom inclusion $< 40\%$). The numeric value is given above the bar.

Mol	Chain	Length	Quality of chain
1	aa	521	
1	ab	521	
1	ac	521	
1	ad	521	
1	ae	521	
1	af	521	
1	ag	521	
1	ah	521	

Continued on next page...

Continued from previous page...

Mol	Chain	Length	Quality of chain		
1	ai	521	12%	70%	29%
1	aj	521	11%	70%	29%
1	ak	521	15%	69%	29%
1	al	521	15%	70%	29%
1	am	521	9%	69%	29%
1	an	521	13%	69%	29%
1	ao	521	12%	70%	29%
1	ap	521	9%	69%	29%
1	aq	521	14%	69%	29%
1	ar	521	15%	70%	29%
1	as	521	6%	70%	29%
1	at	521	9%	69%	29%
1	au	521	11%	70%	29%
1	av	521	8%	69%	29%
1	aw	521	10%	69%	30%
1	ax	521	8%	69%	29%
1	ay	521	13%	69%	29%
1	az	521	13%	70%	29%
1	ba	521	9%	69%	29%
1	bb	521	9%	69%	29%
1	bc	521	11%	69%	29%
1	bd	521	12%	69%	29%
1	be	521	14%	69%	29%
1	bf	521	7%	69%	30%
1	bg	521	9%	70%	29%

Continued on next page...

Continued from previous page...

Mol	Chain	Length	Quality of chain	
1	bh	521	10%	69% 29%
1	bi	521	9%	69% 29%
1	bj	521	12%	70% 29%
1	bk	521	10%	69% 30%
1	bl	521	13%	69% 30%
1	bm	521	17%	70% 29%
1	bn	521	12%	69% 29%
1	bo	521	12%	69% 29%
1	bp	521	10%	69% 29%
1	bq	521	9%	70% 29%
1	br	521	9%	69% 30%
1	bs	521	12%	69% 30%
1	bt	521	10%	69% 30%
1	bu	521	13%	69% 29%
1	bv	521	9%	70% 29%
1	bw	521	7%	69% 29%
1	bx	521	7%	69% 29%
1	by	521	8%	69% 30%
1	bz	521	10%	69% 29%
1	ca	521	8%	69% 29%
1	cb	521	9%	69% 30%
1	cc	521	9%	69% 29%
1	cd	521	12%	70% 29%
1	ce	521	7%	69% 29%
1	cf	521	12%	70% 29%

Continued on next page...

Continued from previous page...

Mol	Chain	Length	Quality of chain		
1	cg	521	15%	69%	29%
1	ch	521	10%	69%	29%
1	ci	521	11%	70%	29%
1	cj	521	12%	69%	29%
1	ck	521	9%	69%	29%
1	cl	521	9%	70%	29%
1	cm	521	10%	69%	29%
1	cn	521	10%	70%	29%
1	co	521	12%	69%	29%
1	cp	521	9%	69%	29%
1	cq	521	7%	69%	29%
1	cr	521	10%	69%	29%
1	cs	521	12%	69%	29%
1	ct	521	12%	69%	29%
1	cu	521	9%	68%	30%
1	cv	521	9%	69%	29%
1	cw	521	8%	69%	29%
1	cx	521	10%	69%	29%
1	cy	521	10%	69%	29%
1	cz	521	10%	69%	29%
1	da	521	10%	69%	29%
1	db	521	10%	69%	29%
1	dc	521	9%	69%	29%
1	dd	521	10%	69%	29%
1	de	521	10%	69%	29%

Continued on next page...

Continued from previous page...

Mol	Chain	Length	Quality of chain		
1	df	521	9%	70%	29%
1	dg	521	12%	69%	29%
1	dh	521	12%	69%	29%
1	di	521	12%	69%	29%
1	dj	521	16%	69%	29%
1	dk	521	10%	69%	29%
1	dl	521	9%	69%	29%
1	dm	521	6%	70%	29%
1	dn	521	7%	69%	29%
1	do	521	6%	70%	29%
1	dp	521	10%	70%	29%
1	dq	521	7%	69%	29%
1	dr	521	7%	69%	29%
1	dy	521	31%	70%	29%
1	dz	521	24%	70%	29%
1	ea	521	21%	70%	29%
1	eb	521	20%	70%	29%
1	ec	521	25%	69%	29%
1	ed	521	33%	70%	29%
1	ee	521	16%	69%	29%
1	ef	521	17%	69%	29%
1	eg	521	19%	70%	29%
1	eh	521	17%	70%	29%
1	ei	521	17%	69%	29%
1	ej	521	23%	70%	29%

Continued on next page...

Continued from previous page...

Mol	Chain	Length	Quality of chain		
1	ek	521	12%	69%	29%
1	el	521	14%	69%	29%
1	em	521	17%	70%	29%
1	en	521	13%	69%	29%
1	eo	521	12%	69%	29%
1	ep	521	15%	70%	29%
1	eq	521	22%	69%	29%
1	er	521	20%	69%	29%
1	es	521	14%	69%	29%
1	et	521	15%	69%	29%
1	eu	521	18%	70%	29%
1	ev	521	22%	69%	29%
1	ew	521	21%	70%	29%
1	ex	521	15%	69%	30%
1	ey	521	13%	70%	29%
1	ez	521	12%	70%	29%
1	fa	521	12%	69%	29%
1	fb	521	17%	70%	29%
1	fc	521	15%	68%	30%
1	fd	521	15%	70%	30%
1	fe	521	15%	69%	29%
1	ff	521	10%	70%	29%
1	fg	521	17%	69%	29%
1	fh	521	16%	70%	29%
1	fi	521	12%	69%	29%

Continued on next page...

Continued from previous page...

Mol	Chain	Length	Quality of chain	
1	fj	521	13%	69% 30%
1	fk	521	17%	69% 29%
1	fl	521	20%	69% 30%
1	fm	521	20%	69% 29%
1	fn	521	14%	70% 29%
1	fo	521	11%	69% 29%
1	fp	521	12%	69% 29%
1	fq	521	12%	69% 29%
1	fr	521	14%	69% 29%
1	fs	521	10%	69% 29%
1	ft	521	11%	69% 30%
1	fu	521	14%	69% 29%
1	fv	521	14%	69% 29%
1	fw	521	10%	69% 29%
1	fx	521	16%	69% 29%
1	fy	521	26%	69% 29%
1	fz	521	21%	69% 29%
1	ga	521	13%	70% 29%
1	gb	521	11%	69% 29%
1	gc	521	10%	69% 29%
1	gd	521	8%	69% 29%
1	ge	521	9%	69% 29%
1	gf	521	12%	69% 29%
1	gg	521	9%	70% 29%
1	gh	521	7%	69% 29%

Continued on next page...

Continued from previous page...

Mol	Chain	Length	Quality of chain	
1	gi	521	8%	69% 29%
1	gj	521	9%	70% 29%
1	gk	521	11%	69% 29%
1	gl	521	8%	69% 29%
1	gm	521	8%	70% 29%
1	gn	521	10%	69% 29%
1	go	521	8%	69% 29%
1	gp	521	10%	69% 29%
1	gq	521	10%	69% 29%
1	gr	521	7%	70% 29%
1	gs	521	13%	69% 29%
1	gt	521	10%	69% 29%
1	gu	521	11%	69% 29%
1	gv	521	12%	69% 29%
1	gw	521	11%	69% 29%
1	gx	521	12%	69% 29%
1	gy	521	8%	69% 29%
1	gz	521	9%	69% 29%
1	ha	521	7%	70% 29%
1	hb	521	11%	69% 29%
1	hc	521	9%	69% 29%
1	hd	521	7%	70% 29%
2	he	427	12%	87% 11%
2	hf	427	15%	88% 11%
2	hg	427	14%	87% 11%

Continued on next page...

Continued from previous page...

Mol	Chain	Length	Quality of chain
2	hh	427	
2	hi	427	
2	hj	427	
2	hk	427	
2	hl	427	
2	hm	427	
2	hn	427	
2	ho	427	

2 Entry composition [i](#)

There are 2 unique types of molecules in this entry. The entry contains 541225 atoms, of which 0 are hydrogens and 0 are deuteriums.

In the tables below, the AltConf column contains the number of residues with at least one atom in alternate conformation and the Trace column contains the number of residues modelled with at most 2 atoms.

- Molecule 1 is a protein called Major capsid protein.

Mol	Chain	Residues	Atoms					AltConf	Trace
			Total	C	N	O	S		
1	aa	370	2832	1805	475	542	10	0	0
1	ab	370	2832	1805	475	542	10	0	0
1	ac	370	2832	1805	475	542	10	0	0
1	ad	370	2832	1805	475	542	10	0	0
1	ae	370	2832	1805	475	542	10	0	0
1	af	367	2811	1790	472	539	10	0	0
1	ag	370	2832	1805	475	542	10	0	0
1	ah	370	2832	1805	475	542	10	0	0
1	ai	370	2832	1805	475	542	10	0	0
1	aj	370	2832	1805	475	542	10	0	0
1	ak	370	2832	1805	475	542	10	0	0
1	al	369	2824	1799	474	541	10	0	0
1	am	370	2832	1805	475	542	10	0	0
1	an	370	2832	1805	475	542	10	0	0
1	ao	370	2832	1805	475	542	10	0	0
1	ap	369	2824	1799	474	541	10	0	0
1	aq	370	2832	1805	475	542	10	0	0

Continued on next page...

Continued from previous page...

Mol	Chain	Residues	Atoms					AltConf	Trace
			Total	C	N	O	S		
1	ar	370	2832	1805	475	542	10	0	0
1	as	370	2832	1805	475	542	10	0	0
1	at	369	2824	1799	474	541	10	0	0
1	au	370	2832	1805	475	542	10	0	0
1	av	370	2832	1805	475	542	10	0	0
1	aw	367	2811	1790	472	539	10	0	0
1	ax	369	2824	1799	474	541	10	0	0
1	ay	370	2832	1805	475	542	10	0	0
1	az	370	2832	1805	475	542	10	0	0
1	ba	369	2824	1799	474	541	10	0	0
1	bb	369	2824	1799	474	541	10	0	0
1	bc	370	2832	1805	475	542	10	0	0
1	bd	369	2824	1799	474	541	10	0	0
1	be	370	2832	1805	475	542	10	0	0
1	bf	367	2811	1790	472	539	10	0	0
1	bg	370	2832	1805	475	542	10	0	0
1	bh	370	2832	1805	475	542	10	0	0
1	bi	370	2832	1805	475	542	10	0	0
1	bj	371	2840	1809	477	544	10	0	0
1	bk	367	2811	1790	472	539	10	0	0
1	bl	367	2811	1790	472	539	10	0	0

Continued on next page...

Continued from previous page...

Mol	Chain	Residues	Atoms					AltConf	Trace
1	bm	369	Total	C	N	O	S	0	0
			2824	1799	474	541	10		
1	bn	369	Total	C	N	O	S	0	0
			2824	1799	474	541	10		
1	bo	369	Total	C	N	O	S	0	0
			2824	1799	474	541	10		
1	bp	370	Total	C	N	O	S	0	0
			2832	1805	475	542	10		
1	bq	371	Total	C	N	O	S	0	0
			2840	1809	477	544	10		
1	br	367	Total	C	N	O	S	0	0
			2811	1790	472	539	10		
1	bs	367	Total	C	N	O	S	0	0
			2811	1790	472	539	10		
1	bt	367	Total	C	N	O	S	0	0
			2811	1790	472	539	10		
1	bu	370	Total	C	N	O	S	0	0
			2832	1805	475	542	10		
1	bv	370	Total	C	N	O	S	0	0
			2832	1805	475	542	10		
1	bw	370	Total	C	N	O	S	0	0
			2832	1805	475	542	10		
1	bx	370	Total	C	N	O	S	0	0
			2832	1805	475	542	10		
1	by	367	Total	C	N	O	S	0	0
			2811	1790	472	539	10		
1	bz	369	Total	C	N	O	S	0	0
			2824	1799	474	541	10		
1	ca	369	Total	C	N	O	S	0	0
			2824	1799	474	541	10		
1	cb	367	Total	C	N	O	S	0	0
			2811	1790	472	539	10		
1	cc	369	Total	C	N	O	S	0	0
			2824	1799	474	541	10		
1	cd	371	Total	C	N	O	S	0	0
			2840	1809	477	544	10		
1	ce	369	Total	C	N	O	S	0	0
			2824	1799	474	541	10		
1	cf	368	Total	C	N	O	S	0	0
			2816	1793	473	540	10		
1	cg	368	Total	C	N	O	S	0	0
			2816	1793	473	540	10		

Continued on next page...

Continued from previous page...

Mol	Chain	Residues	Atoms					AltConf	Trace
			Total	C	N	O	S		
1	ch	369	2824	1799	474	541	10	0	0
1	ci	371	2840	1809	477	544	10	0	0
1	cj	369	2824	1799	474	541	10	0	0
1	ck	370	2832	1805	475	542	10	0	0
1	cl	370	2832	1805	475	542	10	0	0
1	cm	370	2832	1805	475	542	10	0	0
1	cn	369	2824	1799	474	541	10	0	0
1	co	370	2832	1805	475	542	10	0	0
1	cp	369	2824	1799	474	541	10	0	0
1	cq	369	2824	1799	474	541	10	0	0
1	cr	369	2824	1799	474	541	10	0	0
1	cs	369	2824	1799	474	541	10	0	0
1	ct	369	2824	1799	474	541	10	0	0
1	cu	367	2811	1790	472	539	10	0	0
1	cv	370	2832	1805	475	542	10	0	0
1	cw	371	2840	1809	477	544	10	0	0
1	cx	369	2824	1799	474	541	10	0	0
1	cy	370	2832	1805	475	542	10	0	0
1	cz	369	2824	1799	474	541	10	0	0
1	da	369	2824	1799	474	541	10	0	0
1	db	369	2824	1799	474	541	10	0	0

Continued on next page...

Continued from previous page...

Mol	Chain	Residues	Atoms					AltConf	Trace
1	dc	369	Total	C	N	O	S	0	0
			2824	1799	474	541	10		
1	dd	369	Total	C	N	O	S	0	0
			2824	1799	474	541	10		
1	de	369	Total	C	N	O	S	0	0
			2824	1799	474	541	10		
1	df	370	Total	C	N	O	S	0	0
			2832	1805	475	542	10		
1	dg	369	Total	C	N	O	S	0	0
			2824	1799	474	541	10		
1	dh	369	Total	C	N	O	S	0	0
			2824	1799	474	541	10		
1	di	369	Total	C	N	O	S	0	0
			2824	1799	474	541	10		
1	dj	369	Total	C	N	O	S	0	0
			2824	1799	474	541	10		
1	dk	369	Total	C	N	O	S	0	0
			2824	1799	474	541	10		
1	dl	369	Total	C	N	O	S	0	0
			2824	1799	474	541	10		
1	dm	369	Total	C	N	O	S	0	0
			2824	1799	474	541	10		
1	dn	368	Total	C	N	O	S	0	0
			2816	1793	473	540	10		
1	do	369	Total	C	N	O	S	0	0
			2824	1799	474	541	10		
1	dp	368	Total	C	N	O	S	0	0
			2816	1793	473	540	10		
1	dq	369	Total	C	N	O	S	0	0
			2824	1799	474	541	10		
1	dr	370	Total	C	N	O	S	0	0
			2832	1805	475	542	10		
1	dy	370	Total	C	N	O	S	0	0
			2832	1805	475	542	10		
1	dz	370	Total	C	N	O	S	0	0
			2832	1805	475	542	10		
1	ea	370	Total	C	N	O	S	0	0
			2832	1805	475	542	10		
1	eb	370	Total	C	N	O	S	0	0
			2832	1805	475	542	10		
1	ec	370	Total	C	N	O	S	0	0
			2832	1805	475	542	10		

Continued on next page...

Continued from previous page...

Mol	Chain	Residues	Atoms					AltConf	Trace
1	ed	369	Total	C	N	O	S	0	0
			2824	1799	474	541	10		
1	ee	370	Total	C	N	O	S	0	0
			2832	1805	475	542	10		
1	ef	370	Total	C	N	O	S	0	0
			2832	1805	475	542	10		
1	eg	370	Total	C	N	O	S	0	0
			2832	1805	475	542	10		
1	eh	369	Total	C	N	O	S	0	0
			2824	1799	474	541	10		
1	ei	370	Total	C	N	O	S	0	0
			2832	1805	475	542	10		
1	ej	370	Total	C	N	O	S	0	0
			2832	1805	475	542	10		
1	ek	370	Total	C	N	O	S	0	0
			2832	1805	475	542	10		
1	el	369	Total	C	N	O	S	0	0
			2824	1799	474	541	10		
1	em	370	Total	C	N	O	S	0	0
			2832	1805	475	542	10		
1	en	370	Total	C	N	O	S	0	0
			2832	1805	475	542	10		
1	eo	368	Total	C	N	O	S	0	0
			2816	1793	473	540	10		
1	ep	369	Total	C	N	O	S	0	0
			2824	1799	474	541	10		
1	eq	370	Total	C	N	O	S	0	0
			2832	1805	475	542	10		
1	er	370	Total	C	N	O	S	0	0
			2832	1805	475	542	10		
1	es	369	Total	C	N	O	S	0	0
			2824	1799	474	541	10		
1	et	369	Total	C	N	O	S	0	0
			2824	1799	474	541	10		
1	eu	370	Total	C	N	O	S	0	0
			2832	1805	475	542	10		
1	ev	369	Total	C	N	O	S	0	0
			2824	1799	474	541	10		
1	ew	370	Total	C	N	O	S	0	0
			2832	1805	475	542	10		
1	ex	367	Total	C	N	O	S	0	0
			2811	1790	472	539	10		

Continued on next page...

Continued from previous page...

Mol	Chain	Residues	Atoms					AltConf	Trace
			Total	C	N	O	S		
1	ey	370	2832	1805	475	542	10	0	0
1	ez	370	2832	1805	475	542	10	0	0
1	fa	370	2832	1805	475	542	10	0	0
1	fb	371	2840	1809	477	544	10	0	0
1	fc	367	2811	1790	472	539	10	0	0
1	fd	367	2811	1790	472	539	10	0	0
1	fe	369	2824	1799	474	541	10	0	0
1	ff	369	2824	1799	474	541	10	0	0
1	fg	369	2824	1799	474	541	10	0	0
1	fh	370	2832	1805	475	542	10	0	0
1	fi	371	2840	1809	477	544	10	0	0
1	fj	367	2811	1790	472	539	10	0	0
1	fk	370	2832	1805	475	542	10	0	0
1	fl	367	2811	1790	472	539	10	0	0
1	fm	370	2832	1805	475	542	10	0	0
1	fn	370	2832	1805	475	542	10	0	0
1	fo	370	2832	1805	475	542	10	0	0
1	fp	370	2832	1805	475	542	10	0	0
1	fq	369	2824	1799	474	541	10	0	0
1	fr	369	2824	1799	474	541	10	0	0
1	fs	369	2824	1799	474	541	10	0	0

Continued on next page...

Continued from previous page...

Mol	Chain	Residues	Atoms					AltConf	Trace
1	ft	367	Total	C	N	O	S	0	0
			2811	1790	472	539	10		
1	fu	369	Total	C	N	O	S	0	0
			2824	1799	474	541	10		
1	fv	371	Total	C	N	O	S	0	0
			2840	1809	477	544	10		
1	fw	369	Total	C	N	O	S	0	0
			2824	1799	474	541	10		
1	fx	368	Total	C	N	O	S	0	0
			2816	1793	473	540	10		
1	fy	368	Total	C	N	O	S	0	0
			2816	1793	473	540	10		
1	fz	369	Total	C	N	O	S	0	0
			2824	1799	474	541	10		
1	ga	371	Total	C	N	O	S	0	0
			2840	1809	477	544	10		
1	gb	369	Total	C	N	O	S	0	0
			2824	1799	474	541	10		
1	gc	370	Total	C	N	O	S	0	0
			2832	1805	475	542	10		
1	gd	370	Total	C	N	O	S	0	0
			2832	1805	475	542	10		
1	ge	370	Total	C	N	O	S	0	0
			2832	1805	475	542	10		
1	gf	369	Total	C	N	O	S	0	0
			2824	1799	474	541	10		
1	gg	370	Total	C	N	O	S	0	0
			2832	1805	475	542	10		
1	gh	369	Total	C	N	O	S	0	0
			2824	1799	474	541	10		
1	gi	369	Total	C	N	O	S	0	0
			2824	1799	474	541	10		
1	gj	369	Total	C	N	O	S	0	0
			2824	1799	474	541	10		
1	gk	369	Total	C	N	O	S	0	0
			2824	1799	474	541	10		
1	gl	369	Total	C	N	O	S	0	0
			2824	1799	474	541	10		
1	gm	369	Total	C	N	O	S	0	0
			2824	1799	474	541	10		
1	gn	369	Total	C	N	O	S	0	0
			2824	1799	474	541	10		

Continued on next page...

Continued from previous page...

Mol	Chain	Residues	Atoms					AltConf	Trace
1	go	369	Total	C	N	O	S	0	0
			2824	1799	474	541	10		
1	gp	369	Total	C	N	O	S	0	0
			2824	1799	474	541	10		
1	gq	369	Total	C	N	O	S	0	0
			2824	1799	474	541	10		
1	gr	370	Total	C	N	O	S	0	0
			2832	1805	475	542	10		
1	gs	369	Total	C	N	O	S	0	0
			2824	1799	474	541	10		
1	gt	369	Total	C	N	O	S	0	0
			2824	1799	474	541	10		
1	gu	369	Total	C	N	O	S	0	0
			2824	1799	474	541	10		
1	gv	369	Total	C	N	O	S	0	0
			2824	1799	474	541	10		
1	gw	369	Total	C	N	O	S	0	0
			2824	1799	474	541	10		
1	gx	369	Total	C	N	O	S	0	0
			2824	1799	474	541	10		
1	gy	369	Total	C	N	O	S	0	0
			2824	1799	474	541	10		
1	gz	368	Total	C	N	O	S	0	0
			2816	1793	473	540	10		
1	ha	369	Total	C	N	O	S	0	0
			2824	1799	474	541	10		
1	hb	368	Total	C	N	O	S	0	0
			2816	1793	473	540	10		
1	hc	369	Total	C	N	O	S	0	0
			2824	1799	474	541	10		
1	hd	370	Total	C	N	O	S	0	0
			2832	1805	475	542	10		

- Molecule 2 is a protein called Capsid vertex protein.

Mol	Chain	Residues	Atoms					AltConf	Trace
2	he	381	Total	C	N	O	S	0	0
			2954	1882	481	583	8		
2	hf	381	Total	C	N	O	S	0	0
			2954	1882	481	583	8		
2	hg	381	Total	C	N	O	S	0	0
			2954	1882	481	583	8		

Continued on next page...

Continued from previous page...

Mol	Chain	Residues	Atoms					AltConf	Trace
2	hh	381	Total	C	N	O	S	0	0
			2954	1882	481	583	8		
2	hi	381	Total	C	N	O	S	0	0
			2954	1882	481	583	8		
2	hj	381	Total	C	N	O	S	0	0
			2954	1882	481	583	8		
2	hk	381	Total	C	N	O	S	0	0
			2954	1882	481	583	8		
2	hl	381	Total	C	N	O	S	0	0
			2954	1882	481	583	8		
2	hm	381	Total	C	N	O	S	0	0
			2954	1882	481	583	8		
2	hn	381	Total	C	N	O	S	0	0
			2954	1882	481	583	8		
2	ho	381	Total	C	N	O	S	0	0
			2954	1882	481	583	8		

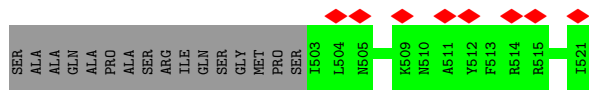

• Molecule 1: Major capsid protein

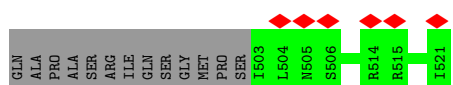
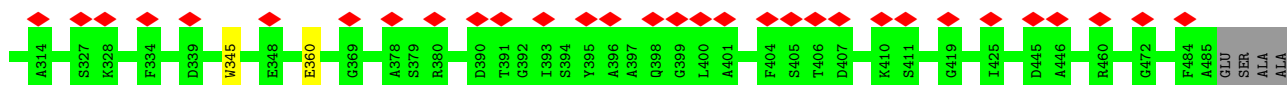
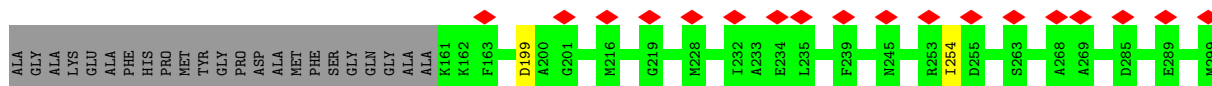
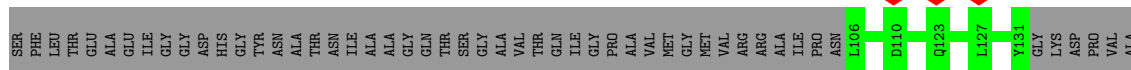
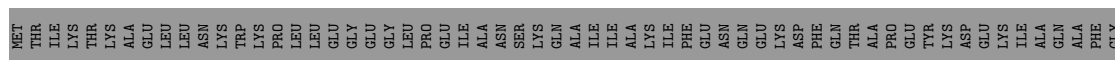

• Molecule 1: Major capsid protein

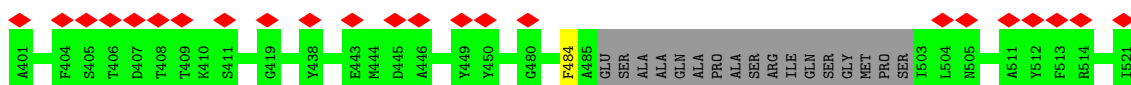
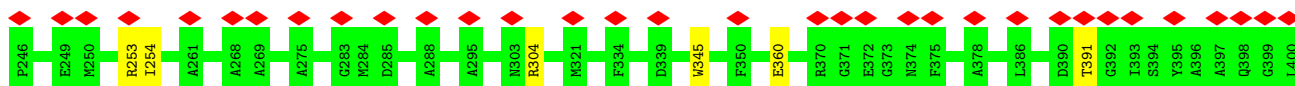
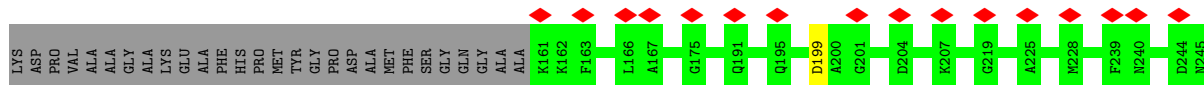
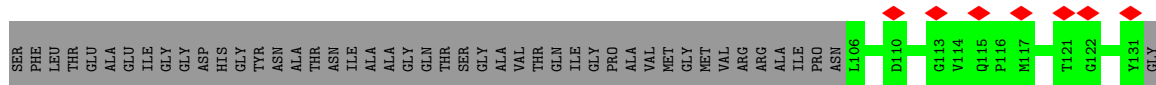
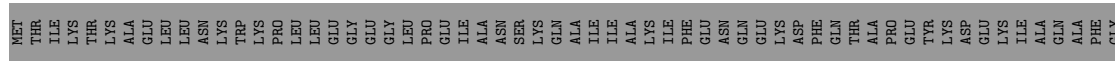

• Molecule 1: Major capsid protein



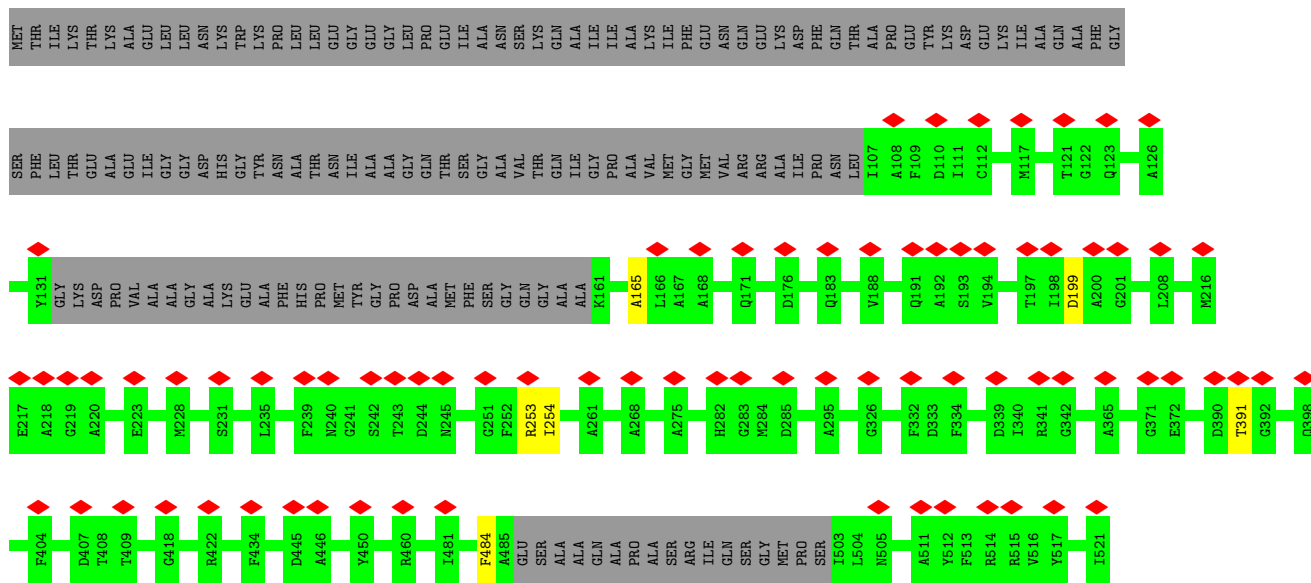

• Molecule 1: Major capsid protein

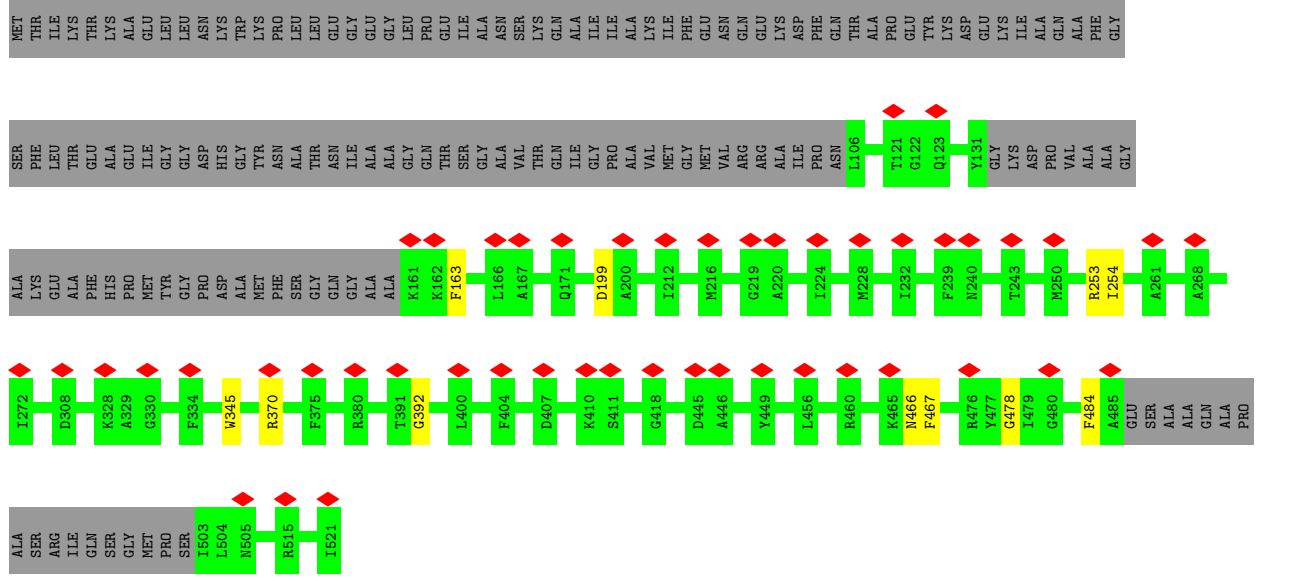
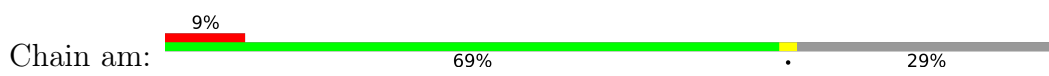

• Molecule 1: Major capsid protein

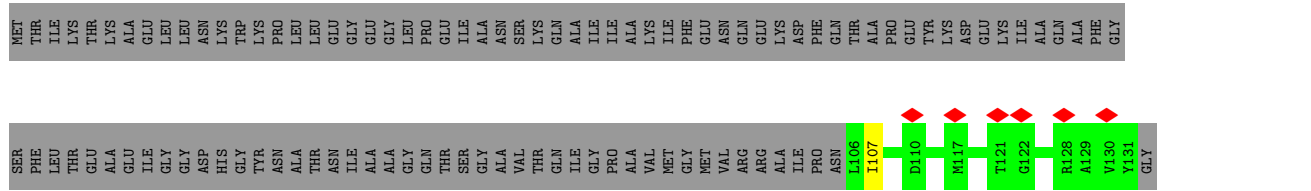

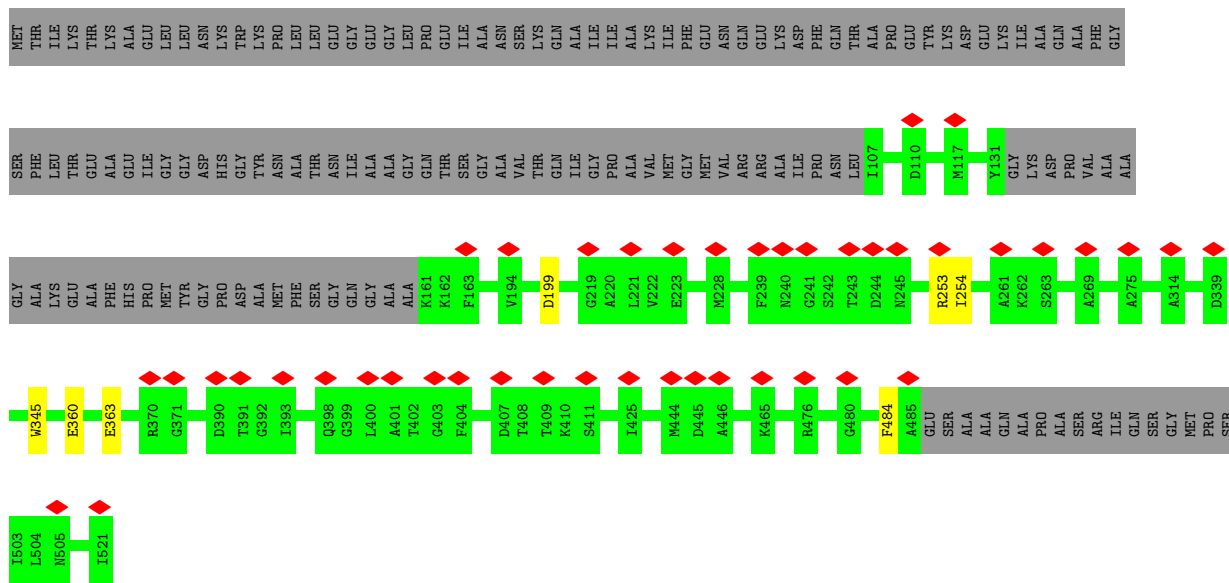

• Molecule 1: Major capsid protein

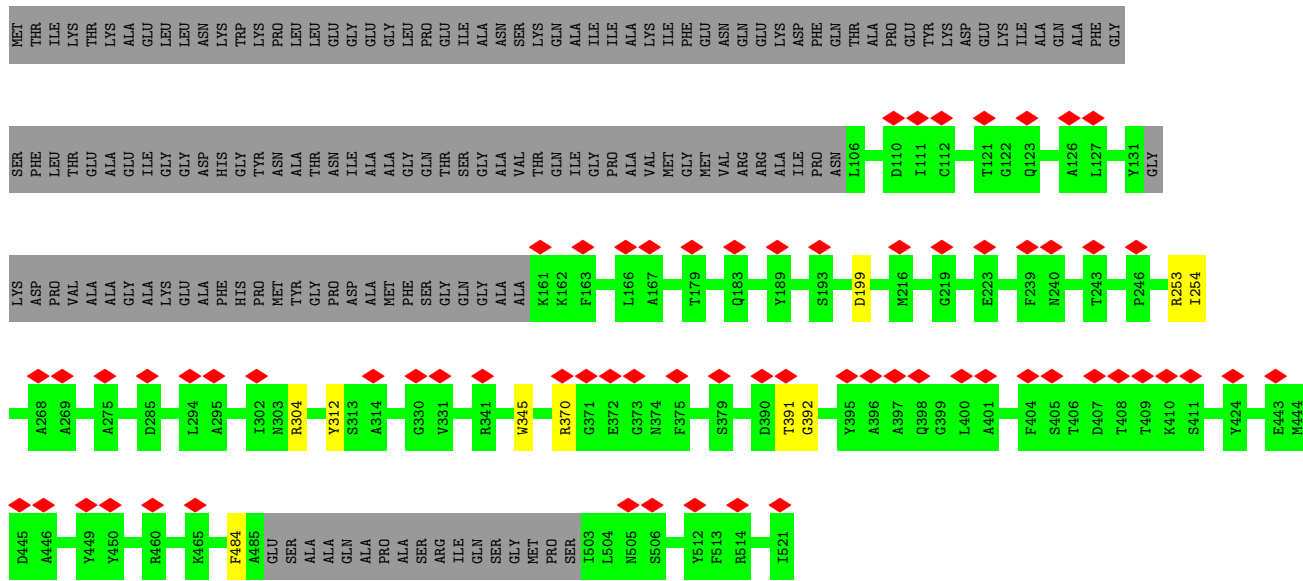

• Molecule 1: Major capsid protein



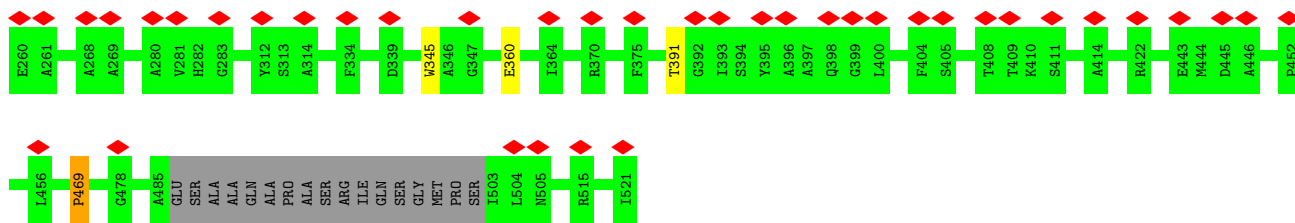

• Molecule 1: Major capsid protein

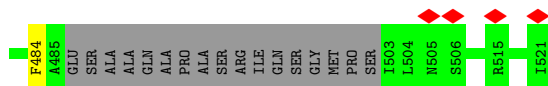
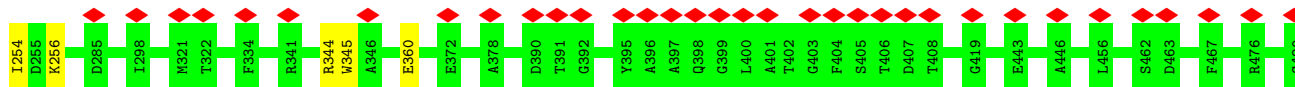
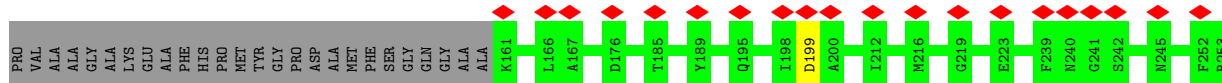
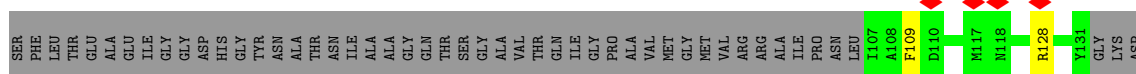
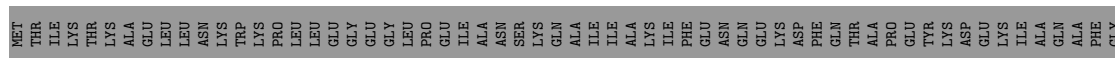

• Molecule 1: Major capsid protein

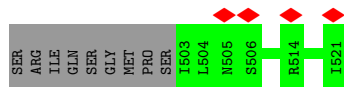
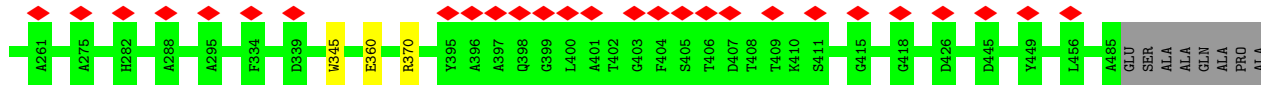
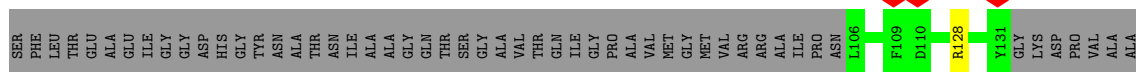

• Molecule 1: Major capsid protein

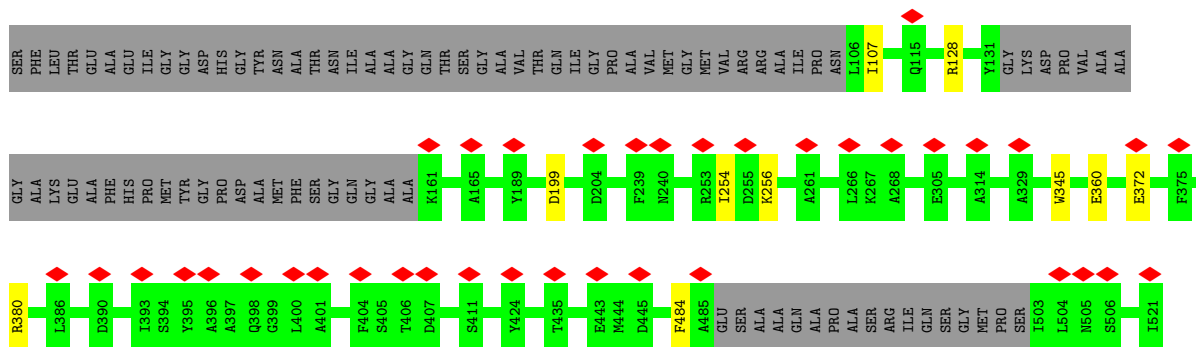

• Molecule 1: Major capsid protein

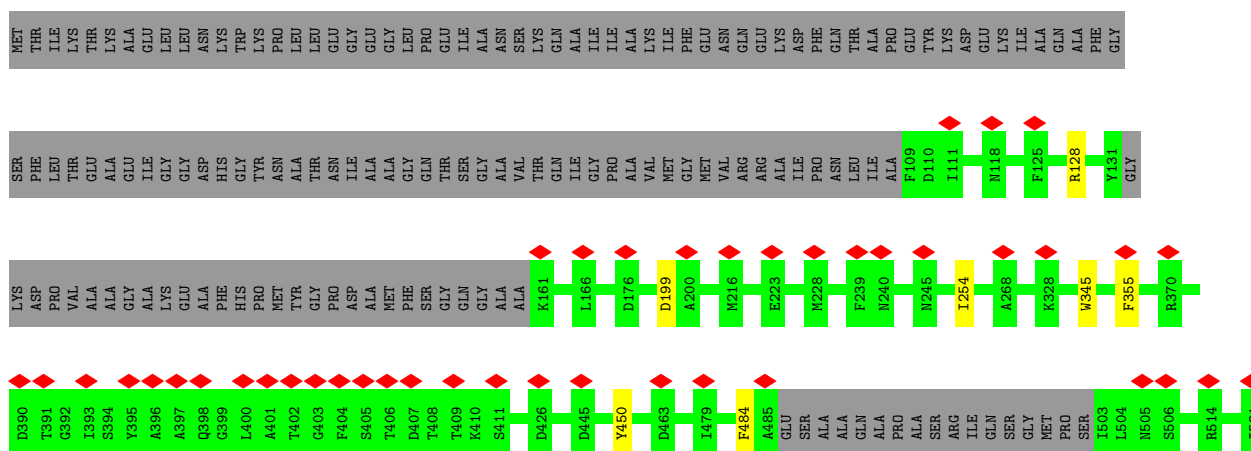

• Molecule 1: Major capsid protein

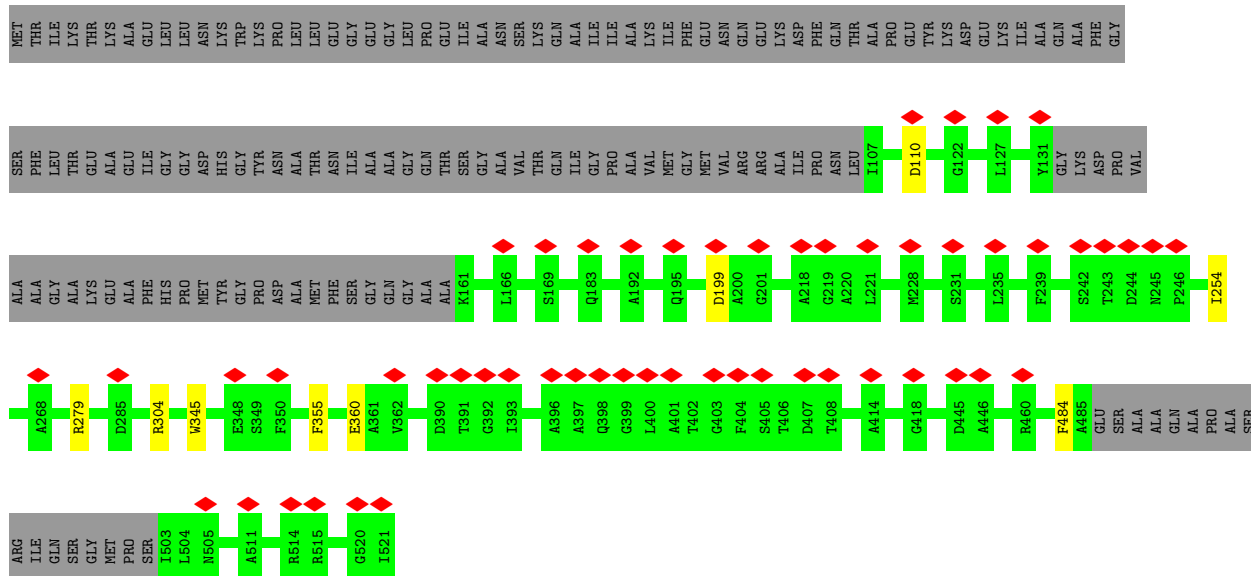

• Molecule 1: Major capsid protein

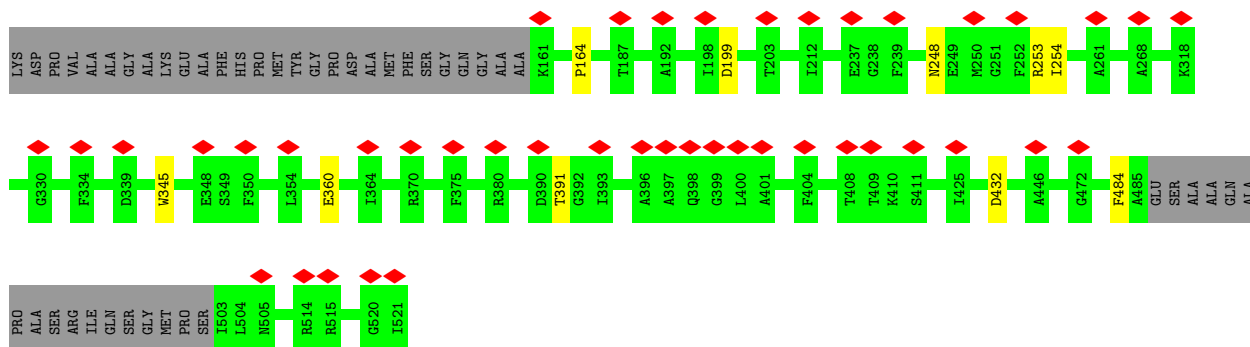

• Molecule 1: Major capsid protein

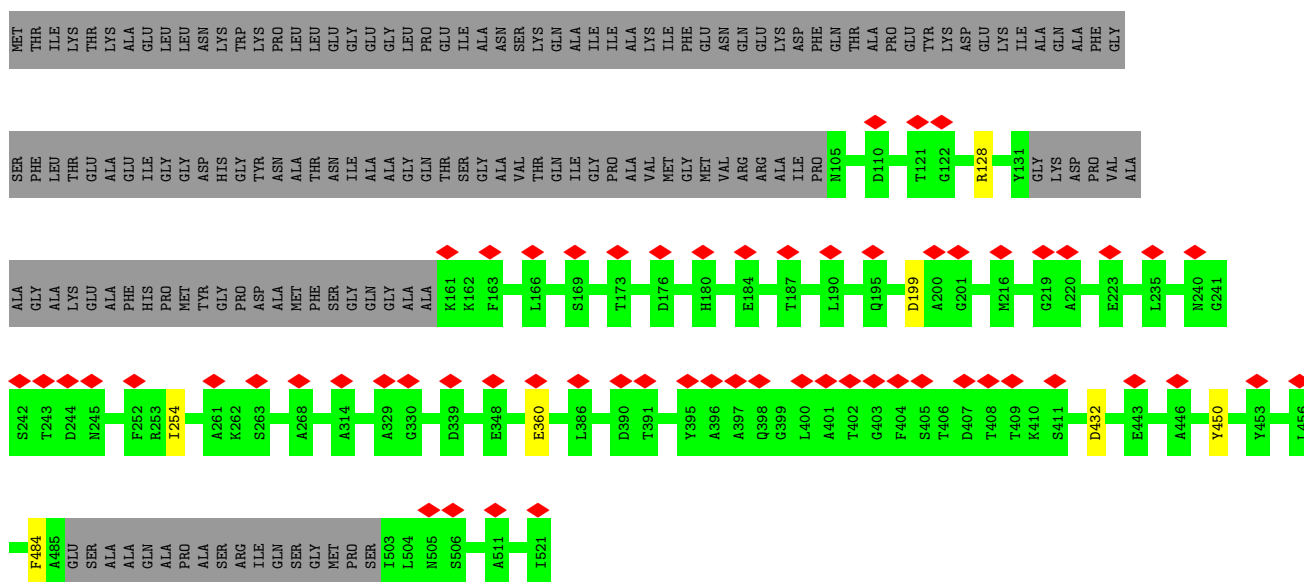

• Molecule 1: Major capsid protein

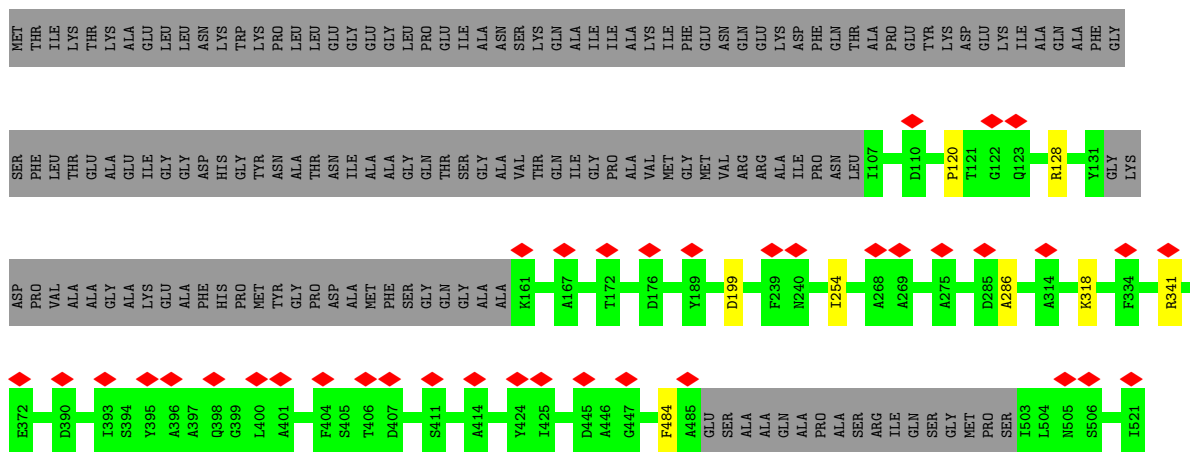

• Molecule 1: Major capsid protein

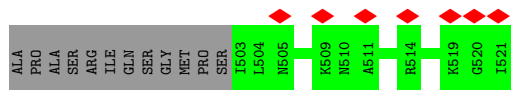

• Molecule 1: Major capsid protein

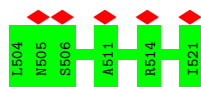
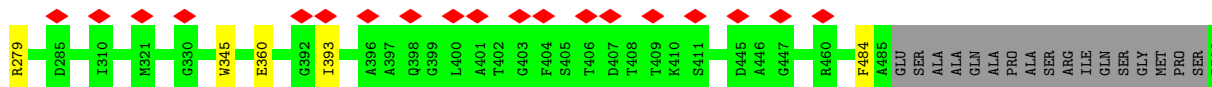
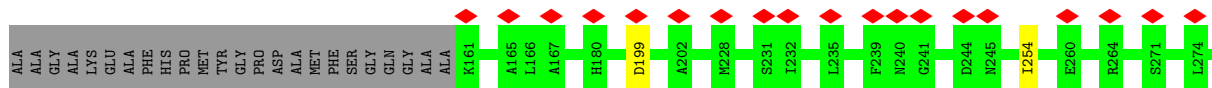
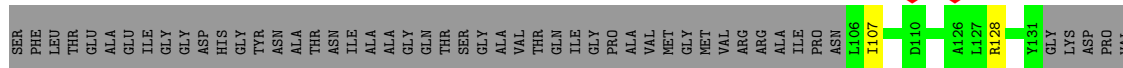
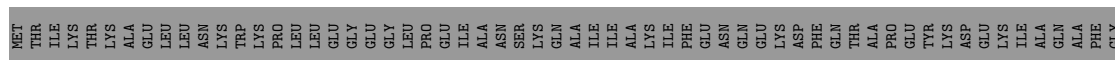

• Molecule 1: Major capsid protein

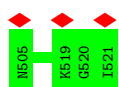
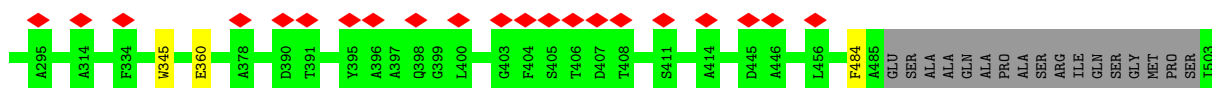
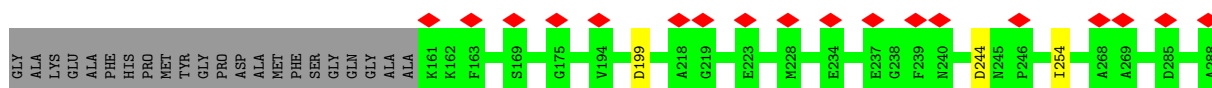
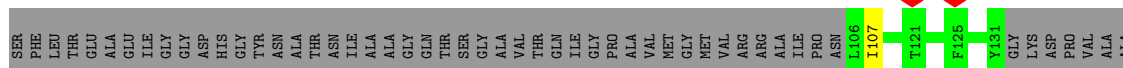

• Molecule 1: Major capsid protein



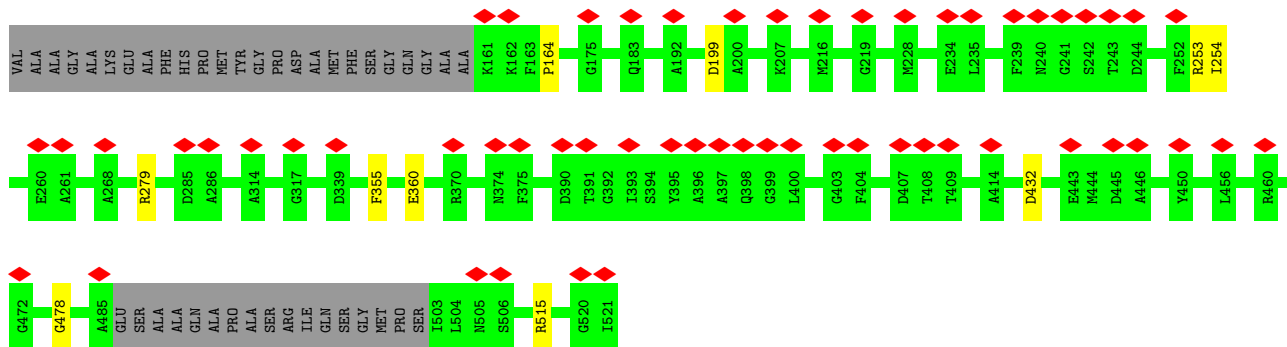

• Molecule 1: Major capsid protein

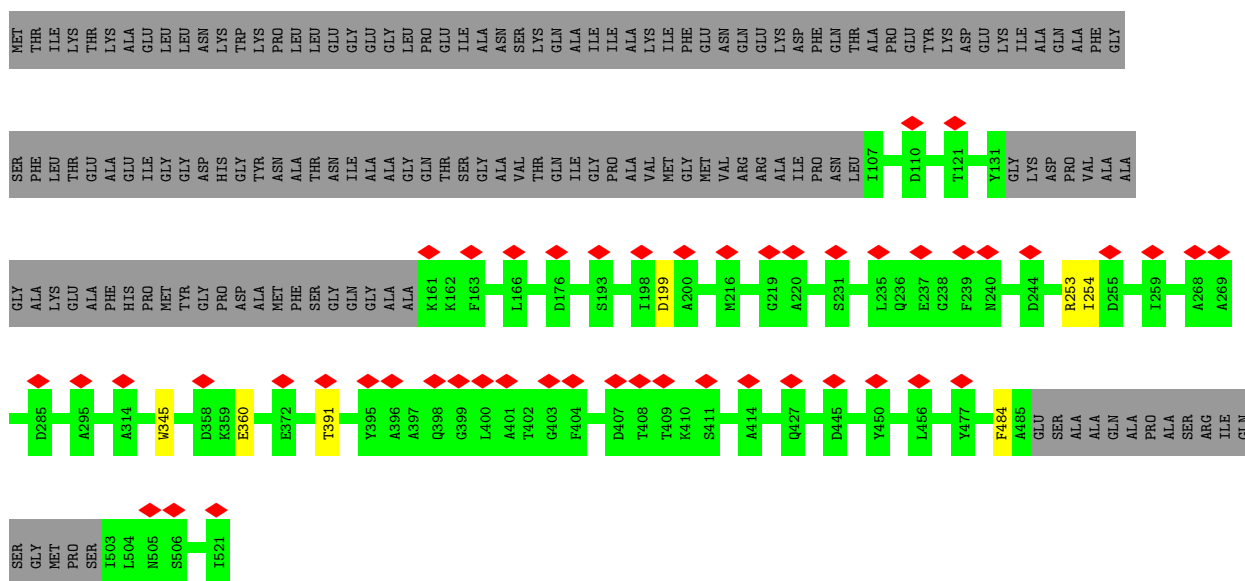

• Molecule 1: Major capsid protein

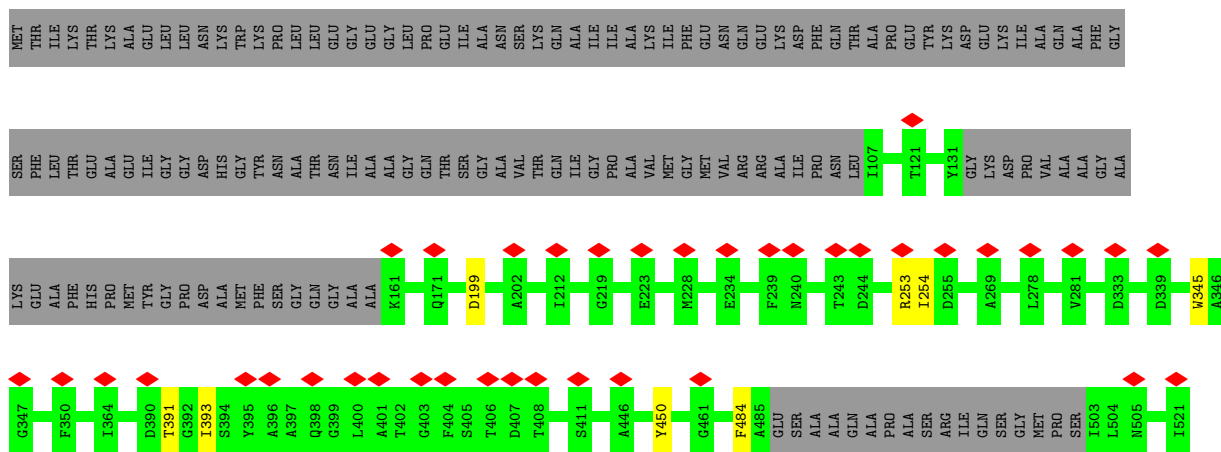

• Molecule 1: Major capsid protein

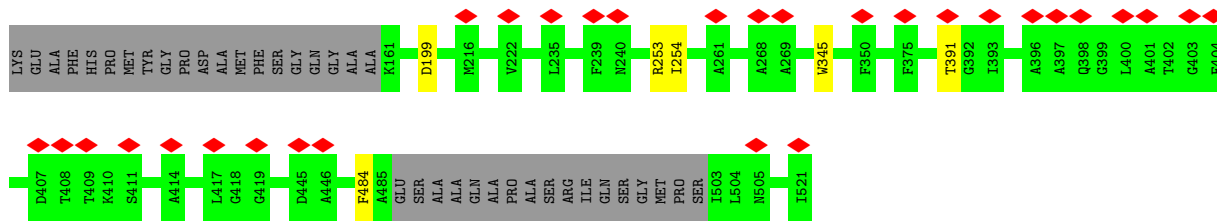

• Molecule 1: Major capsid protein

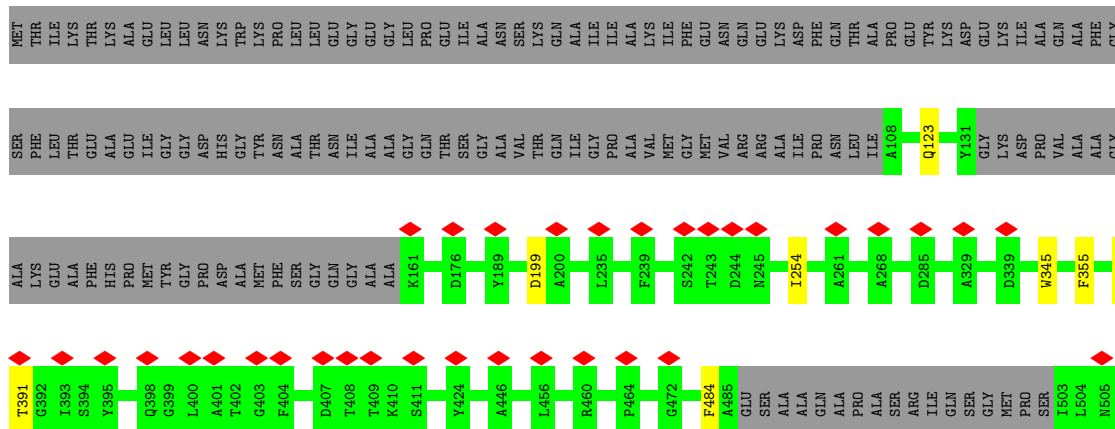

• Molecule 1: Major capsid protein

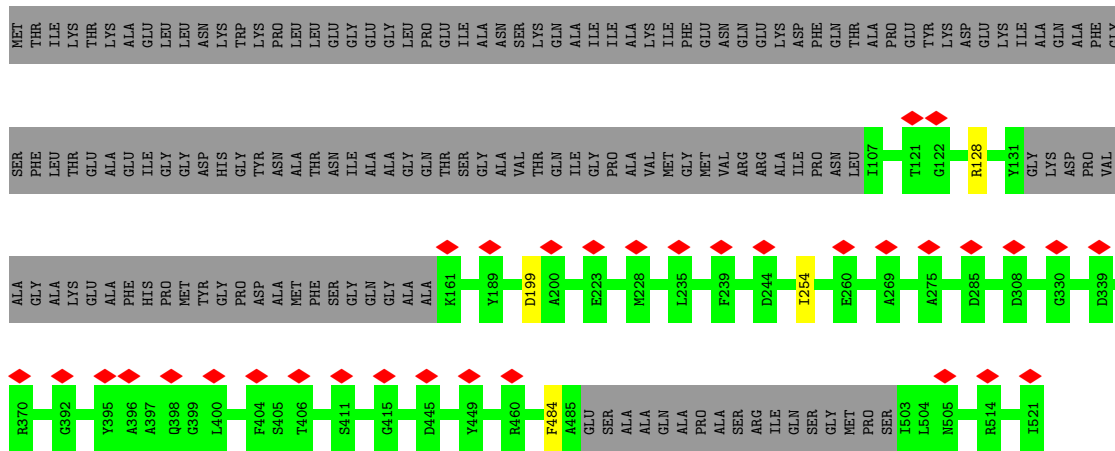

• Molecule 1: Major capsid protein

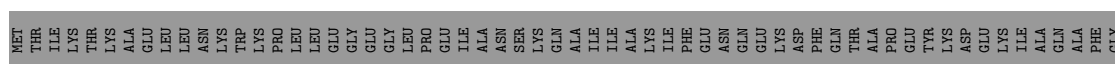

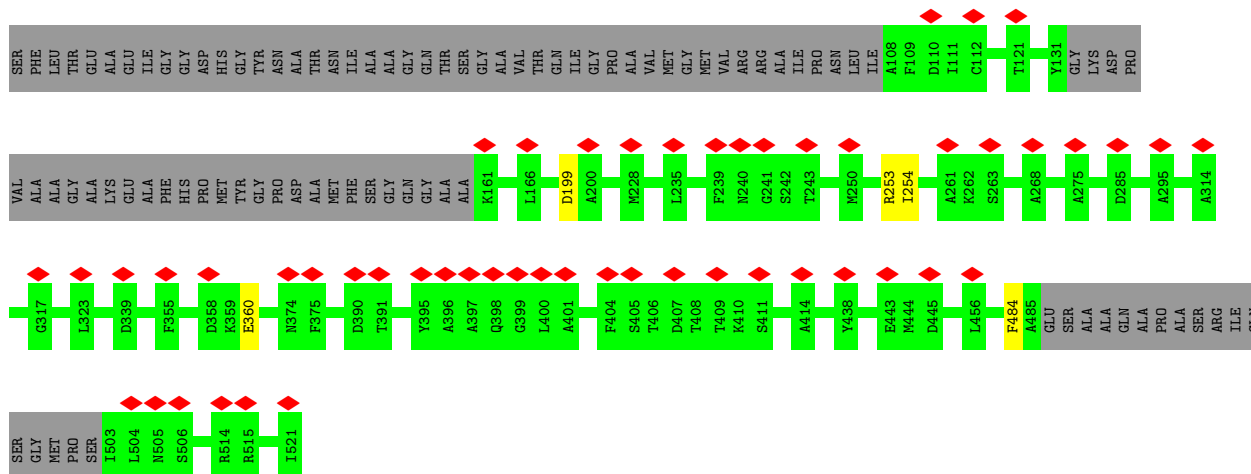

• Molecule 1: Major capsid protein

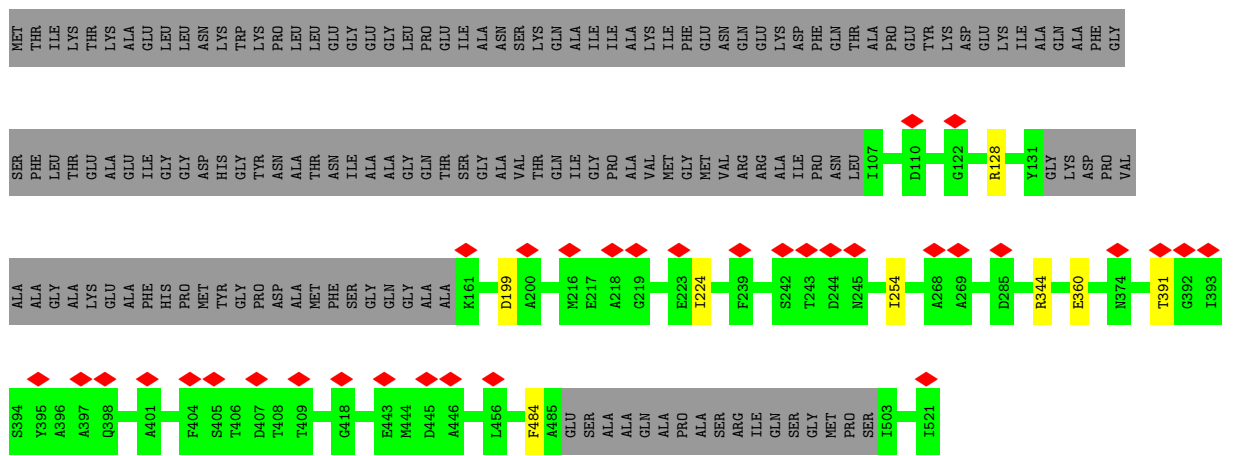

• Molecule 1: Major capsid protein

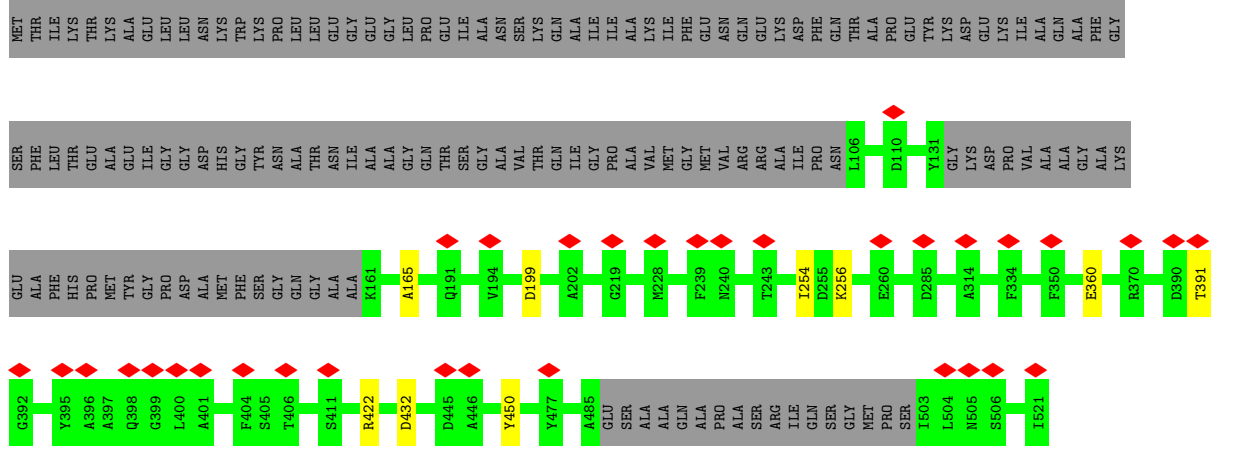

• Molecule 1: Major capsid protein



• Molecule 1: Major capsid protein

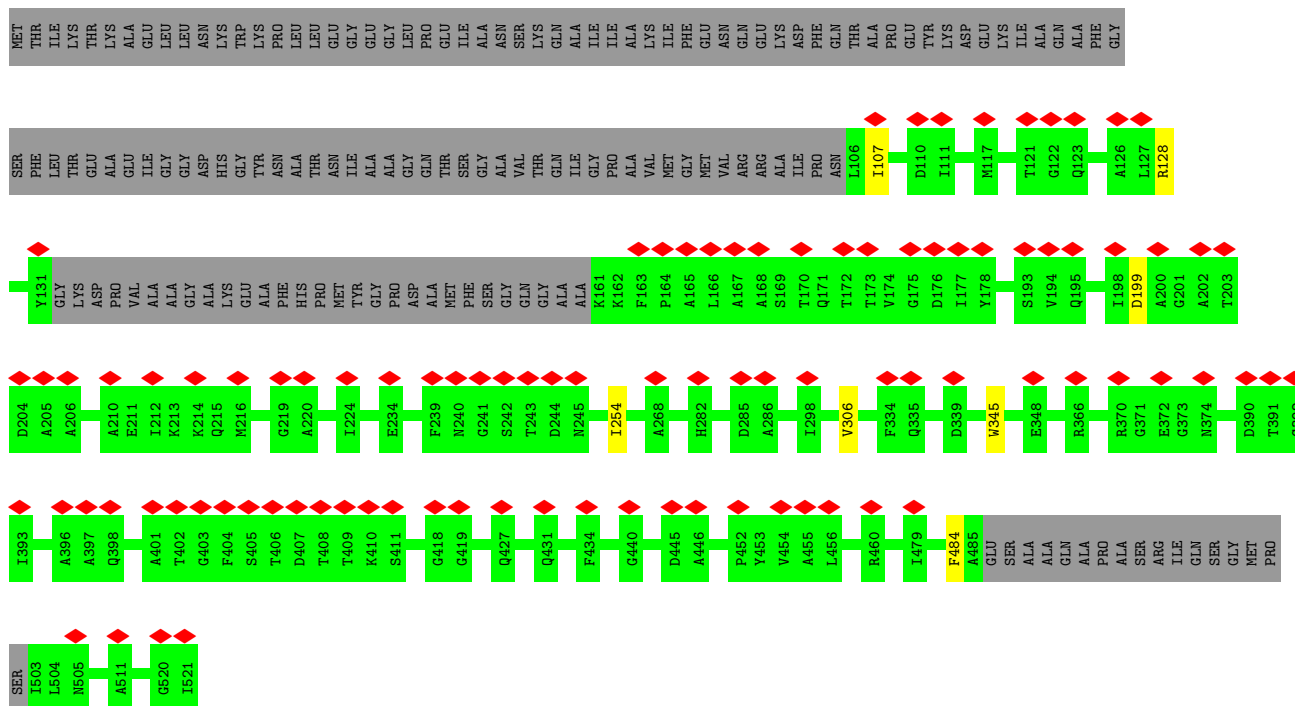

• Molecule 1: Major capsid protein

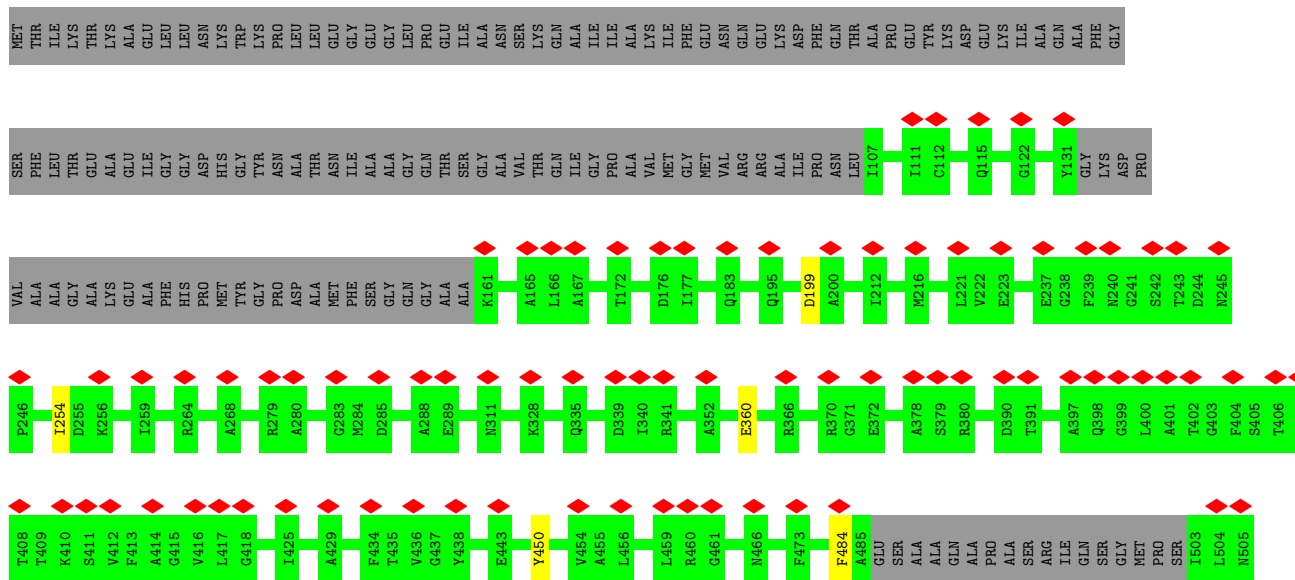

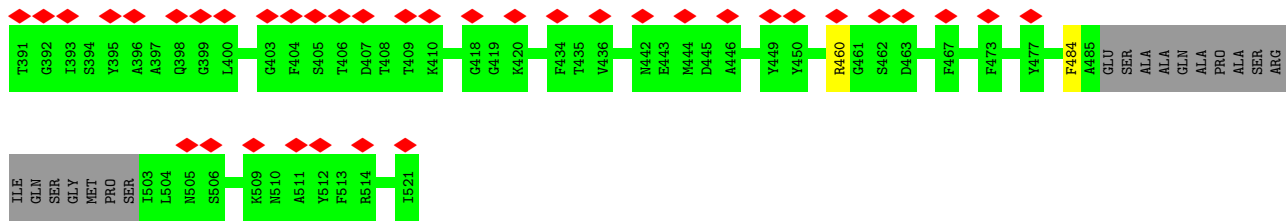

• Molecule 1: Major capsid protein

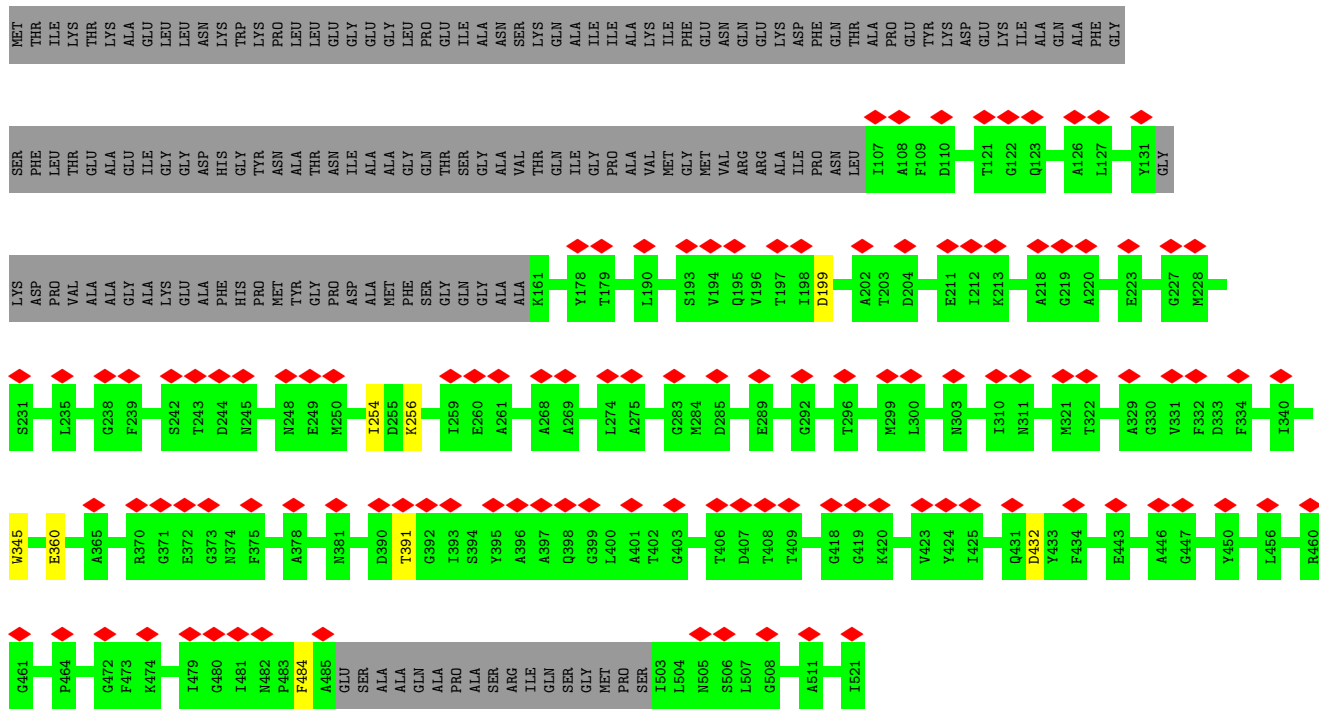

• Molecule 1: Major capsid protein

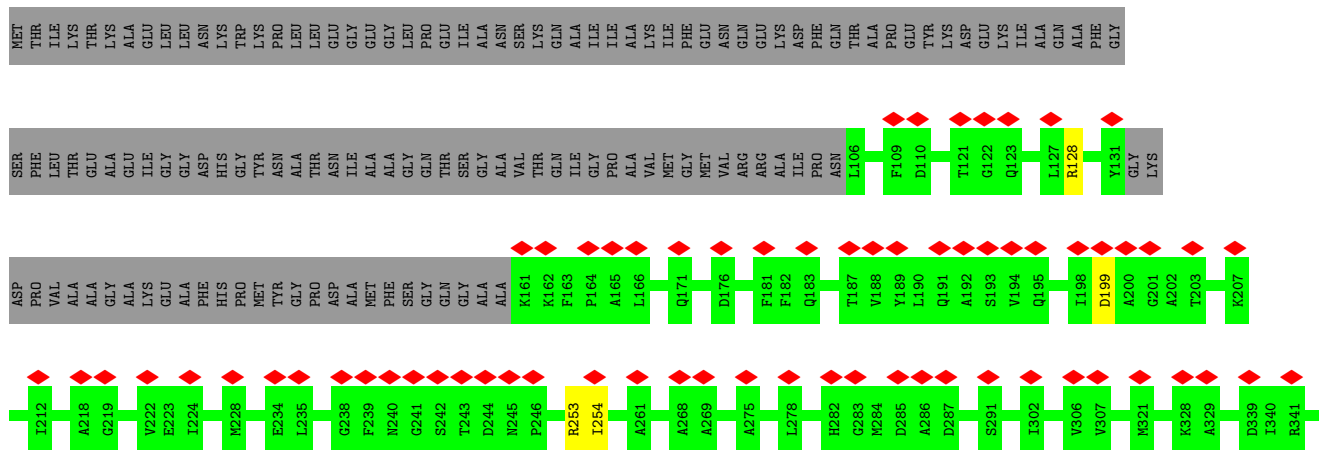

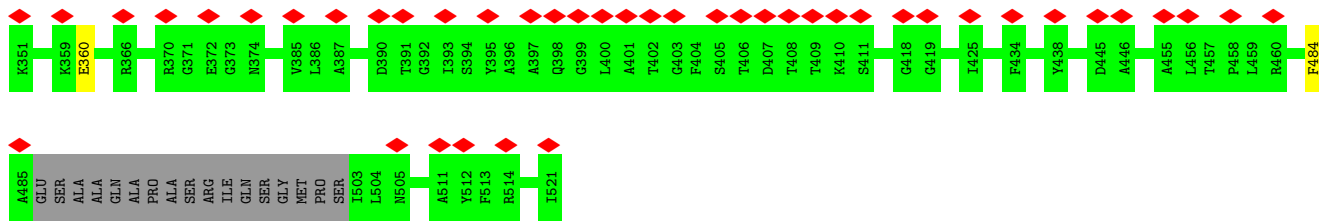

• Molecule 1: Major capsid protein

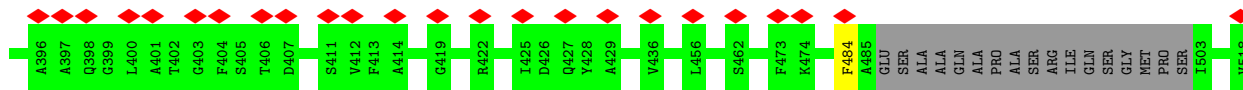
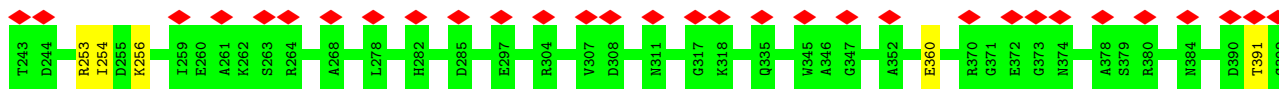
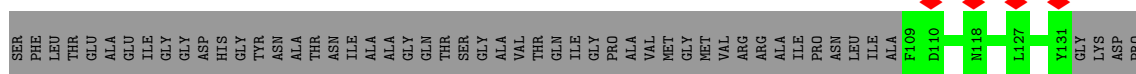
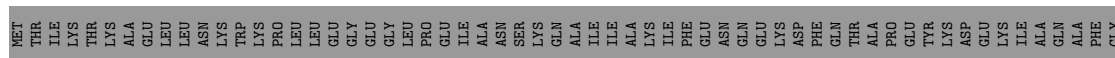

• Molecule 1: Major capsid protein

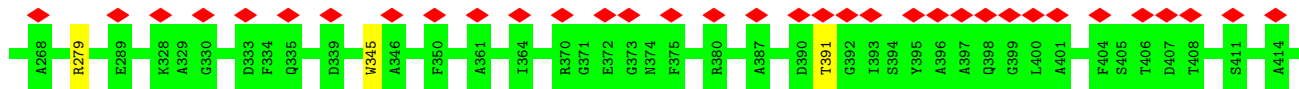
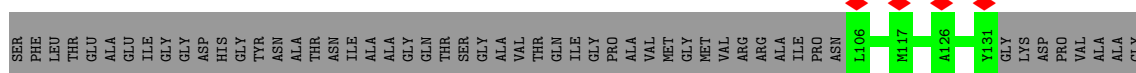

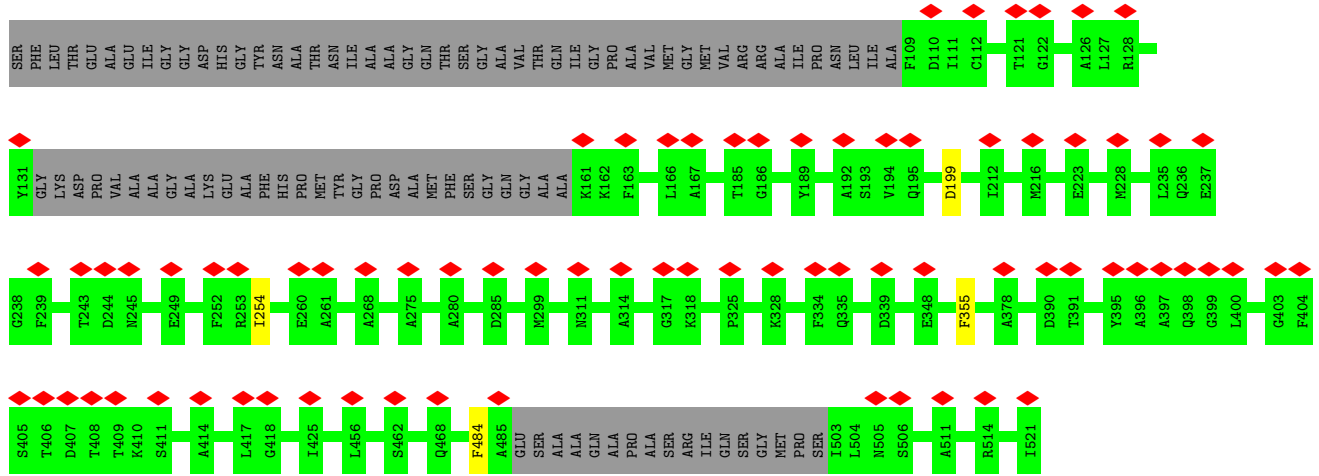

• Molecule 1: Major capsid protein

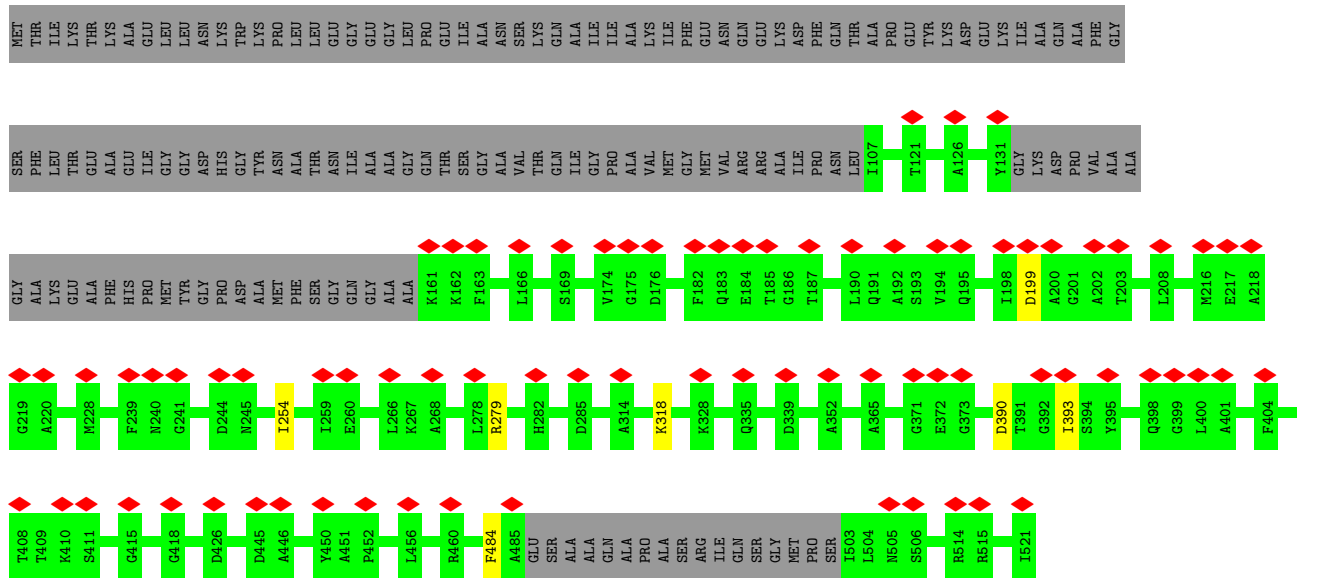

• Molecule 1: Major capsid protein

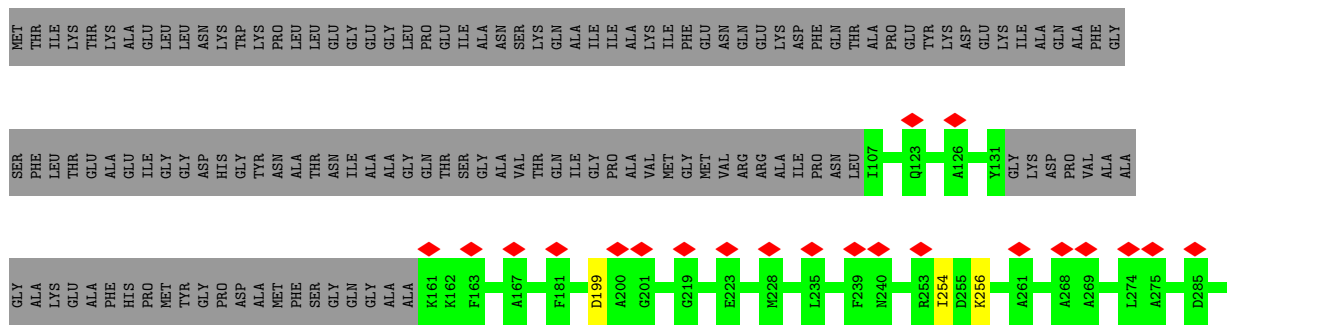

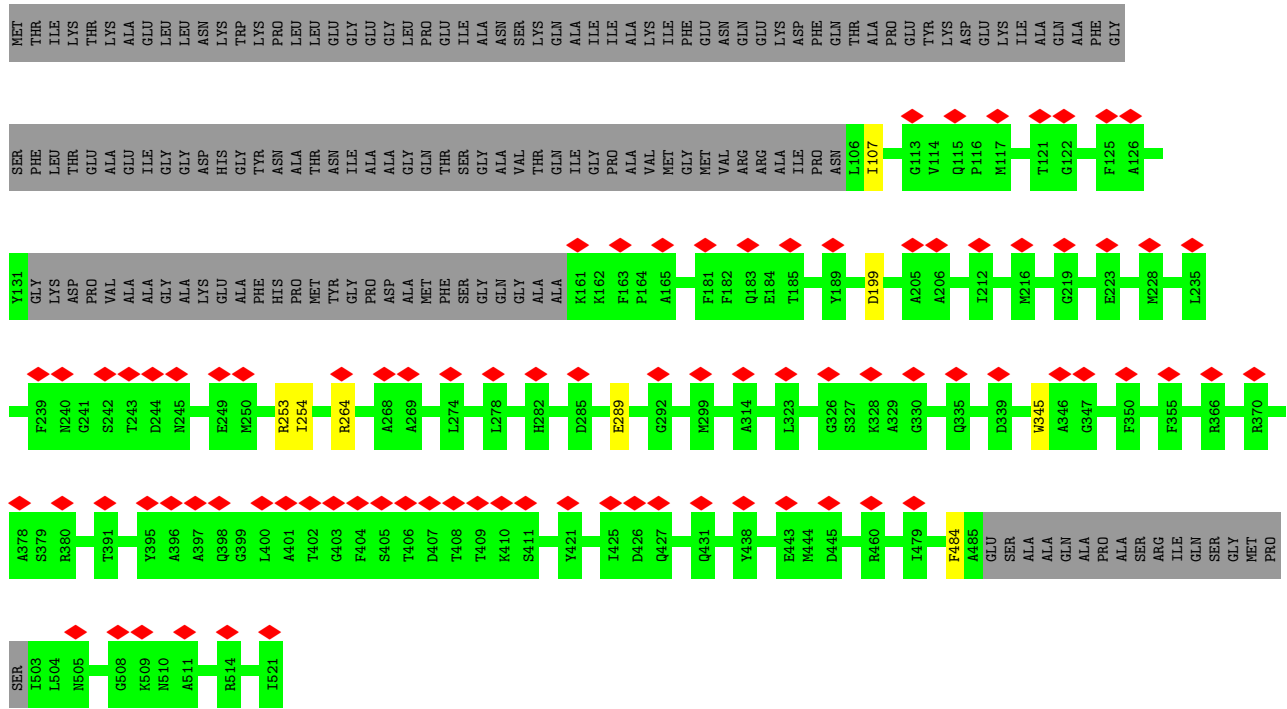

• Molecule 1: Major capsid protein

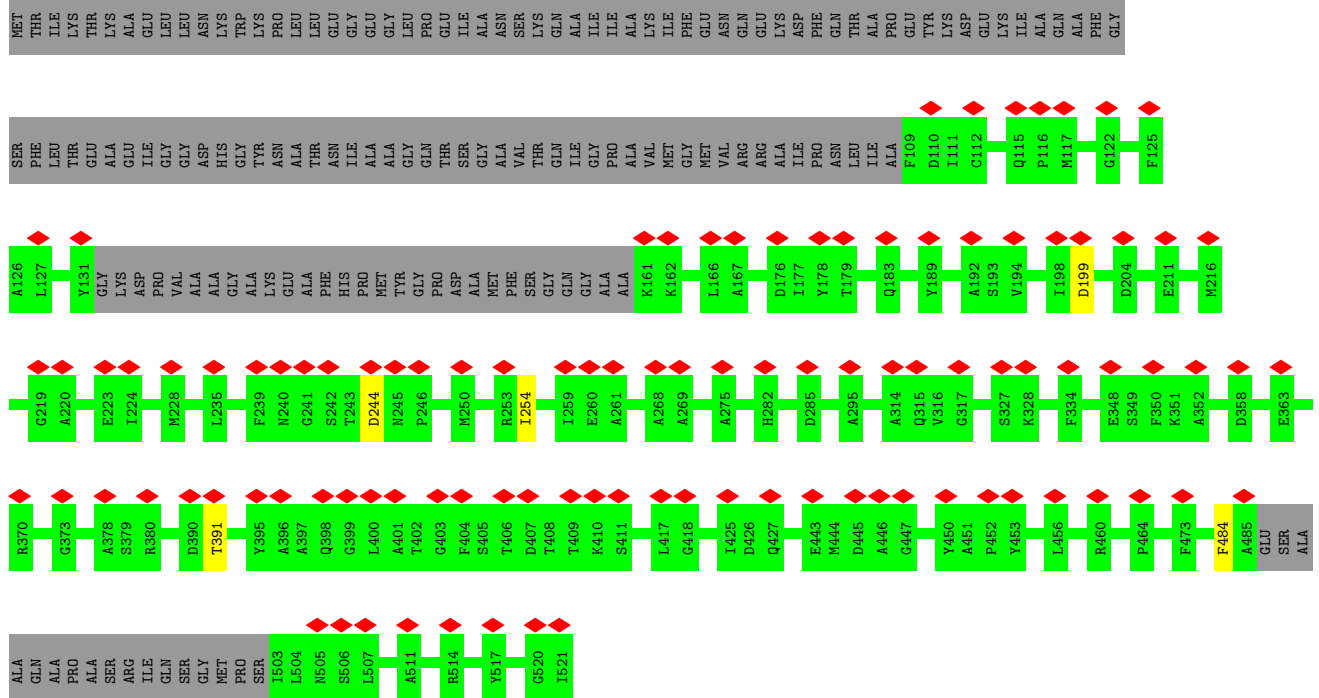

• Molecule 1: Major capsid protein



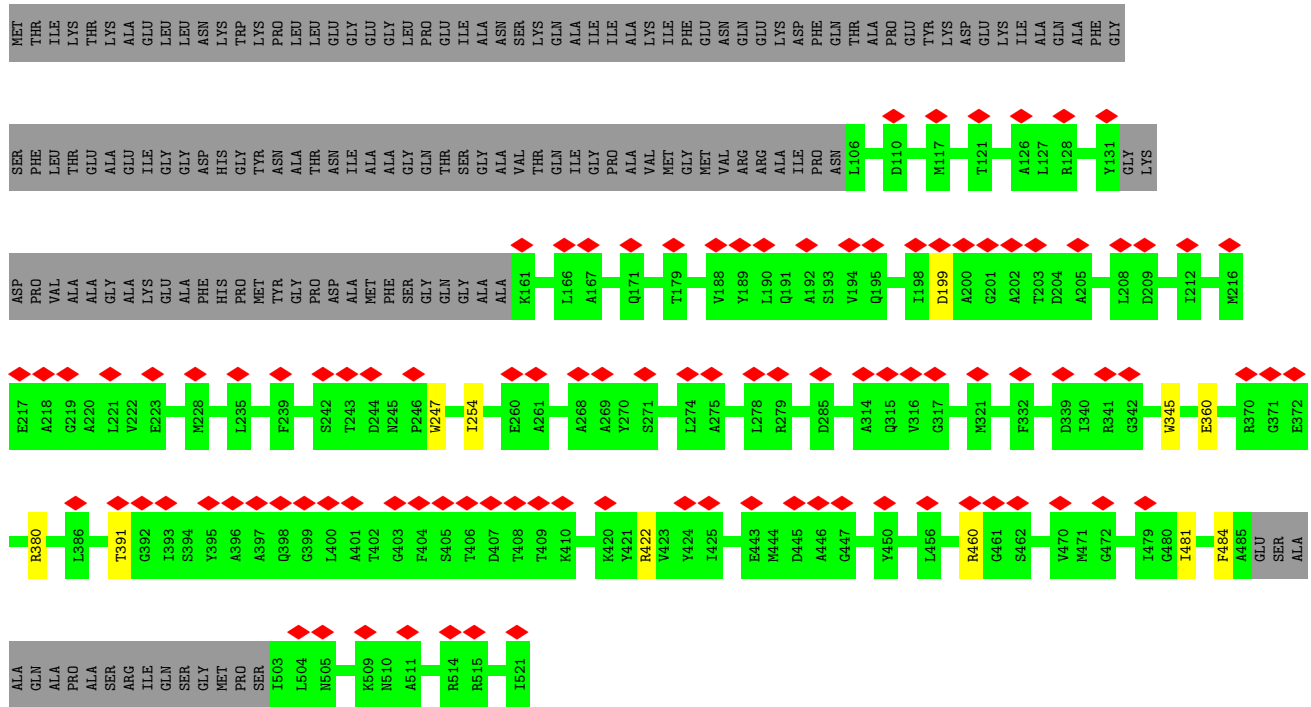

• Molecule 1: Major capsid protein

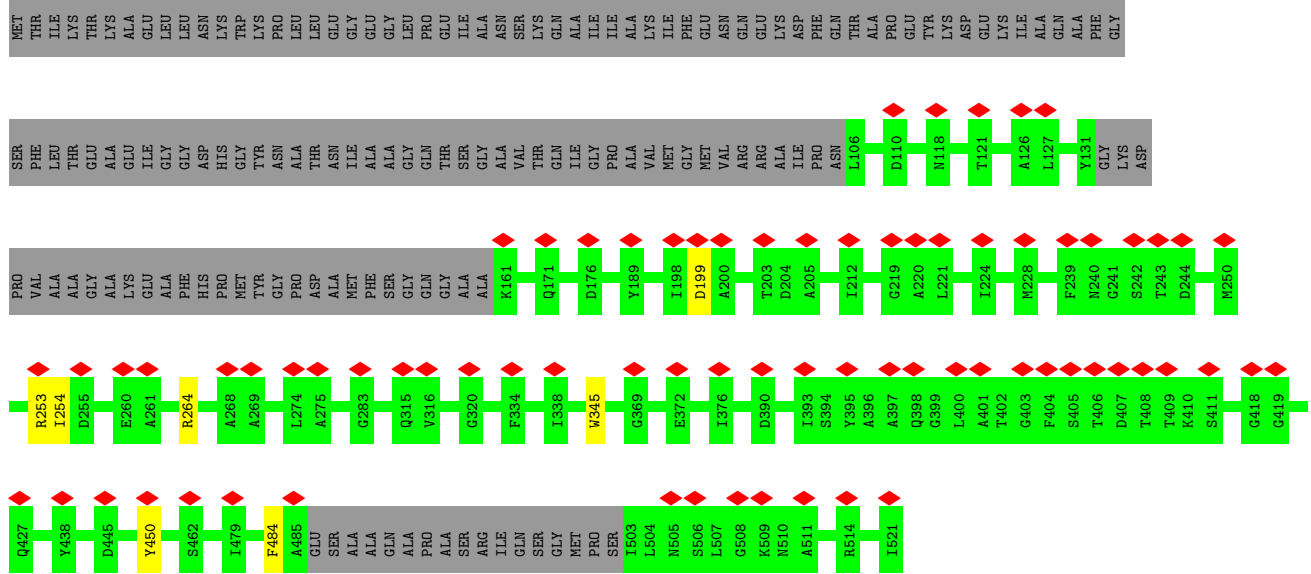

• Molecule 1: Major capsid protein



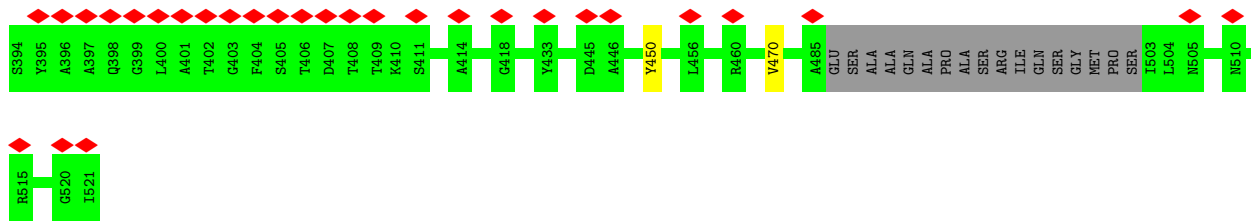

• Molecule 1: Major capsid protein

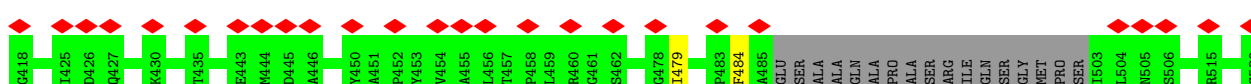
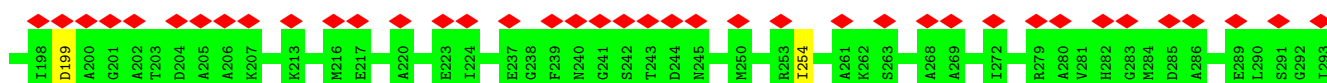
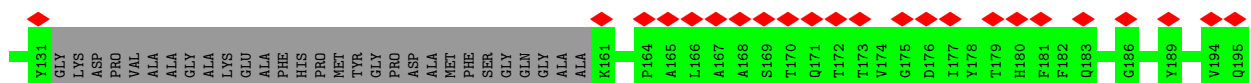
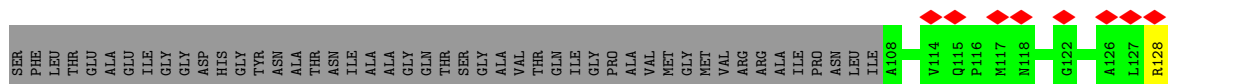
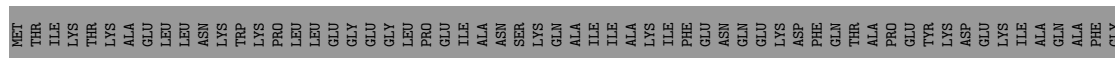

• Molecule 1: Major capsid protein

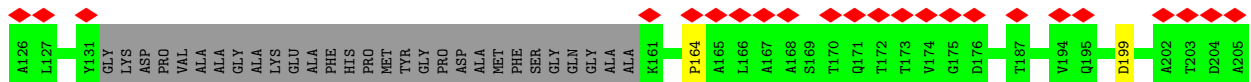
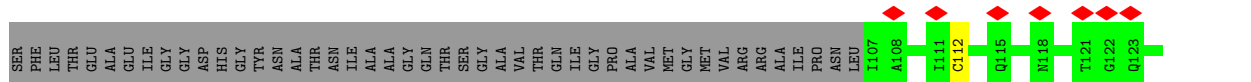

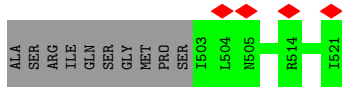

• Molecule 1: Major capsid protein

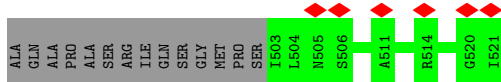
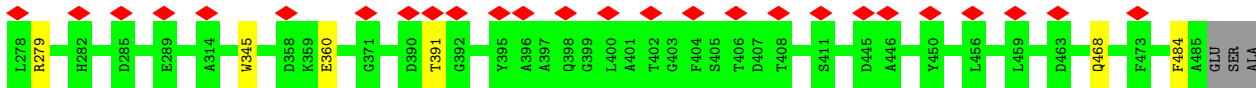
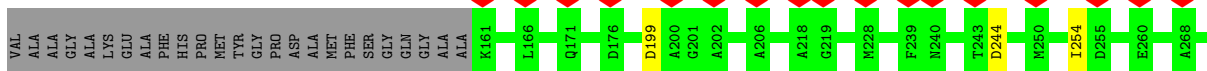
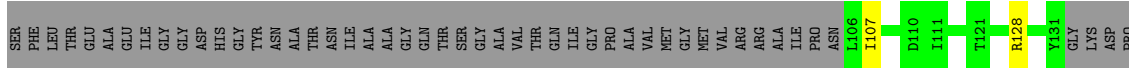
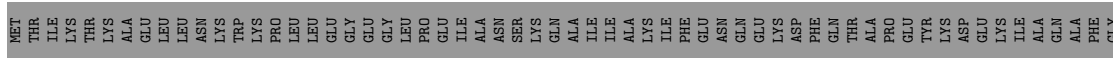

• Molecule 1: Major capsid protein

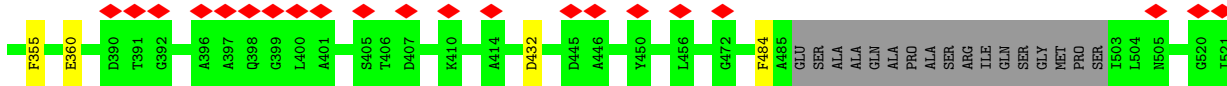
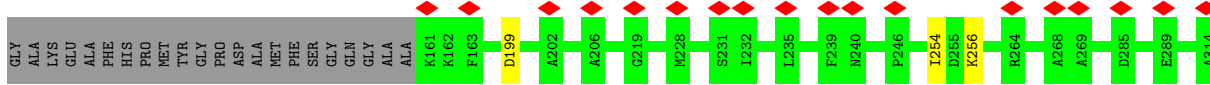
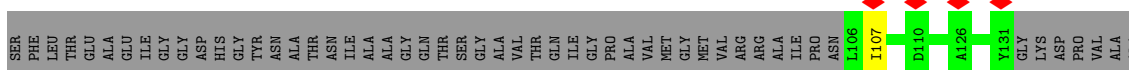
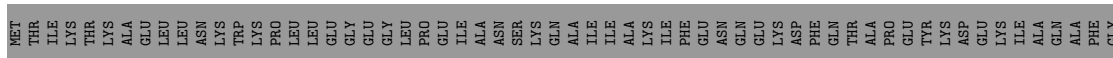

• Molecule 1: Major capsid protein

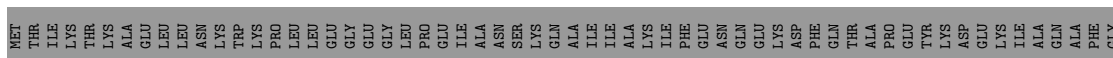

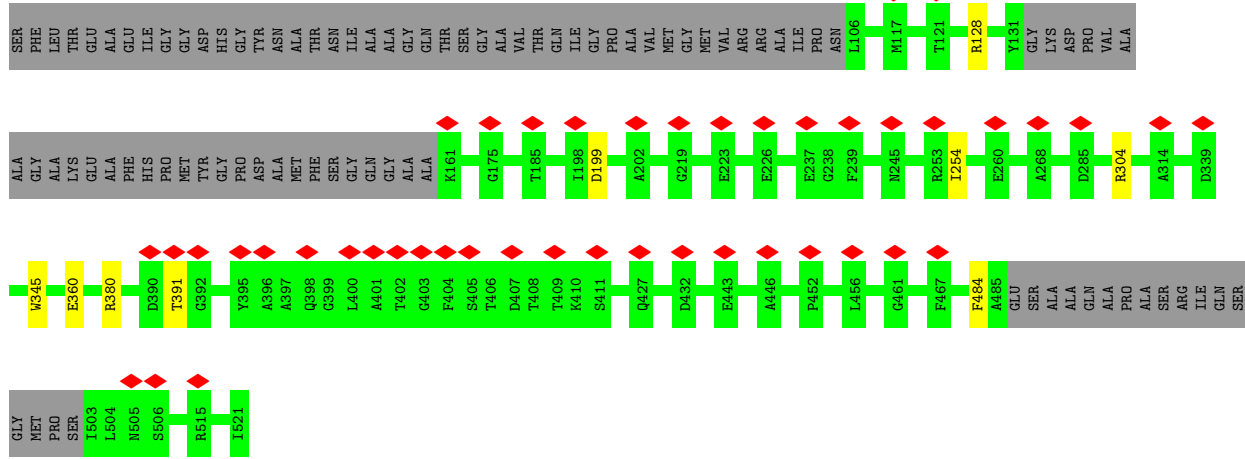

• Molecule 1: Major capsid protein

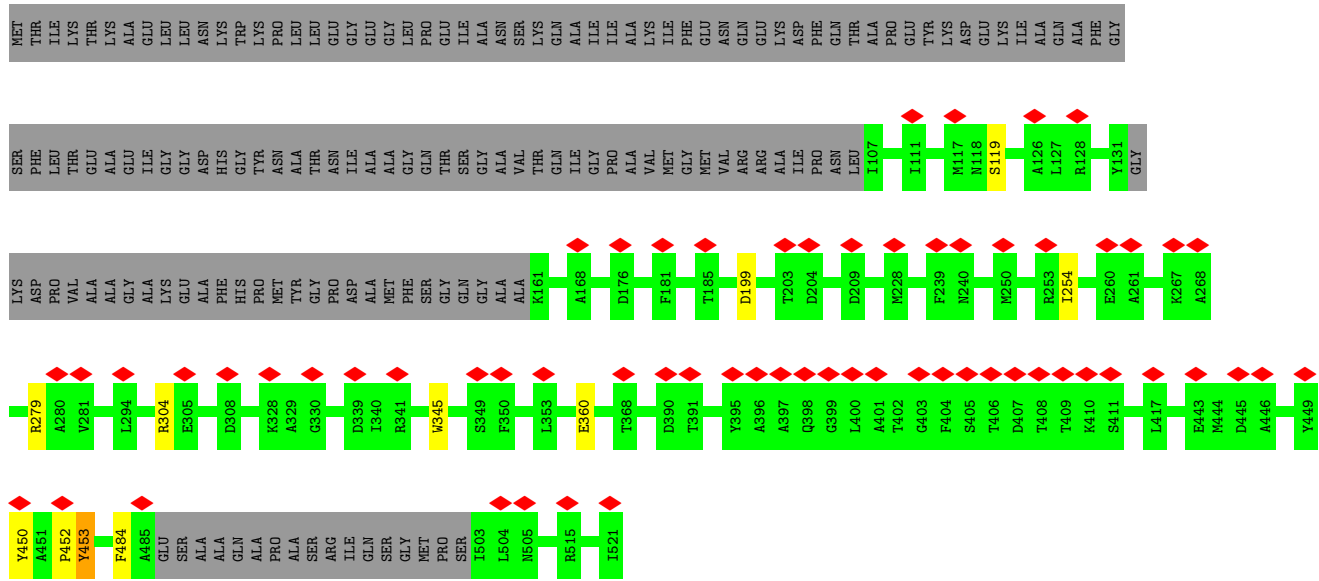

• Molecule 1: Major capsid protein

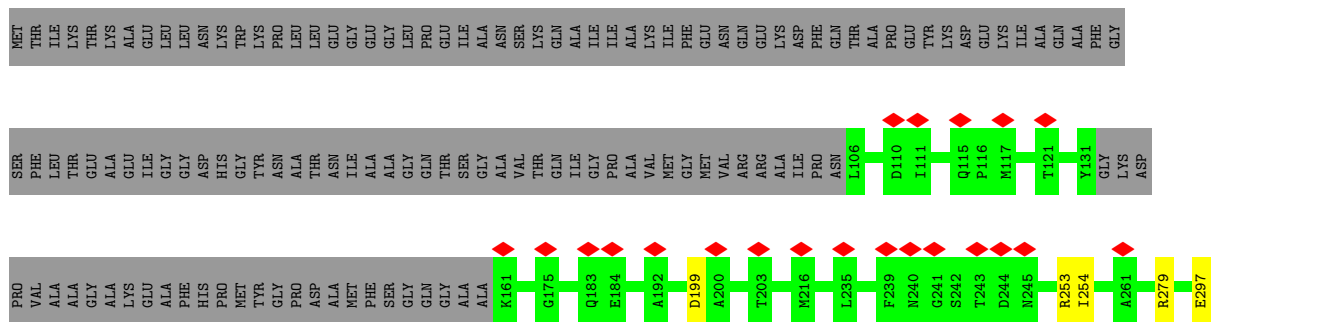
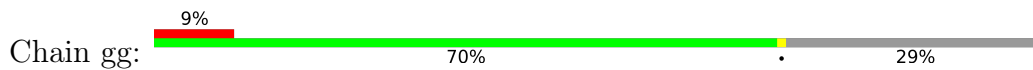

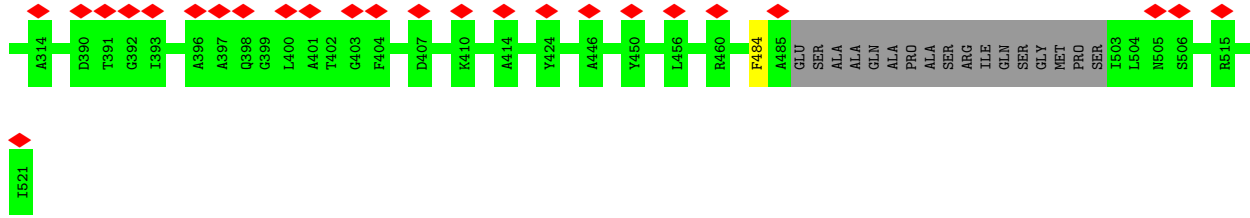

• Molecule 1: Major capsid protein

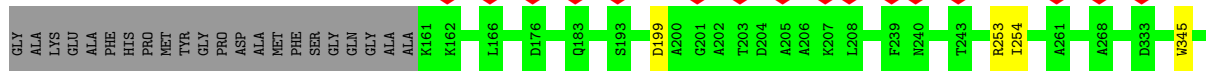
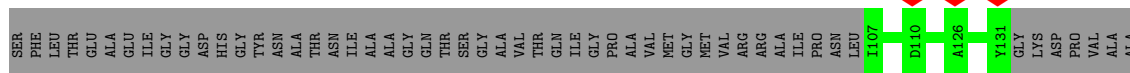

• Molecule 1: Major capsid protein

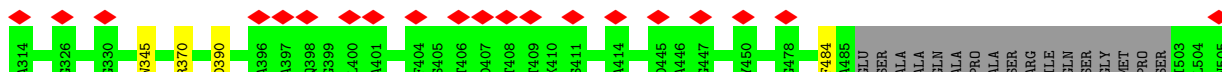
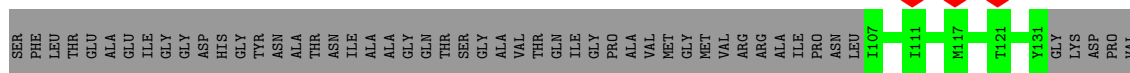
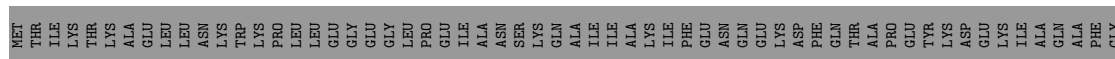

• Molecule 1: Major capsid protein

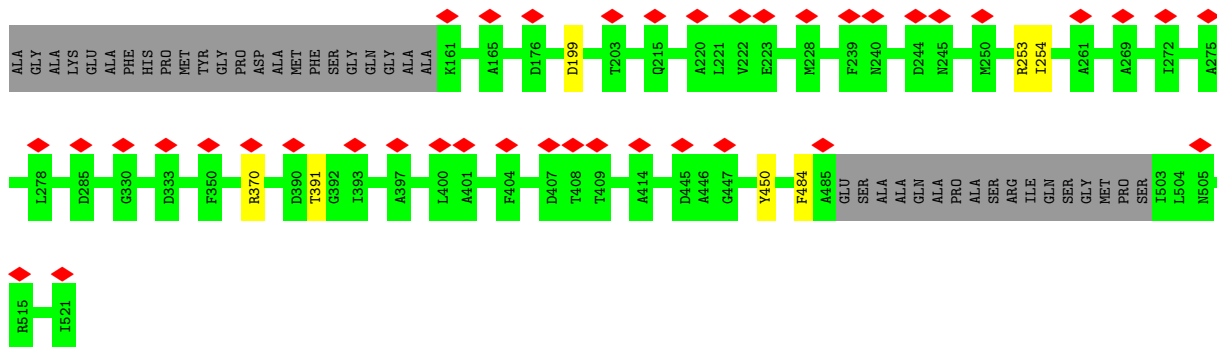

• Molecule 1: Major capsid protein

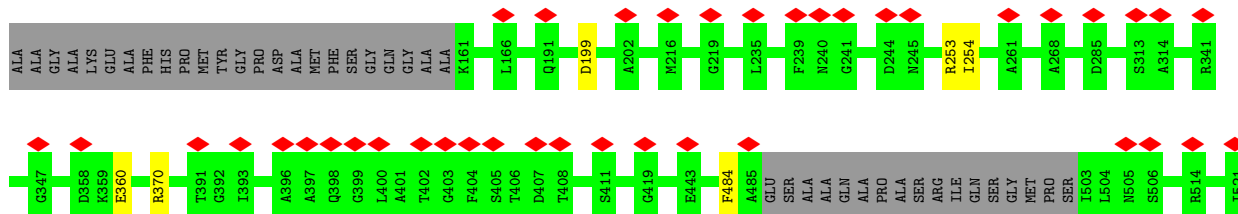
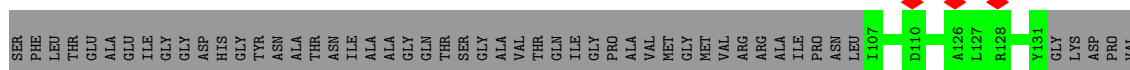
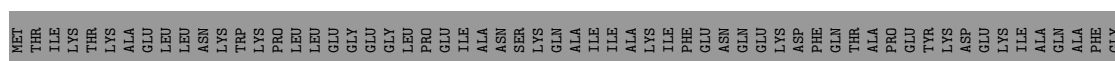
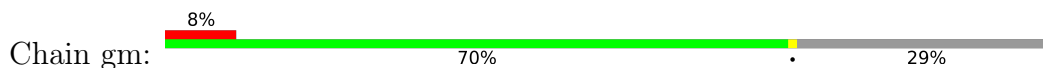

• Molecule 1: Major capsid protein

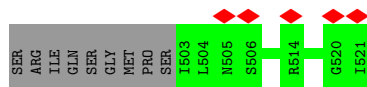
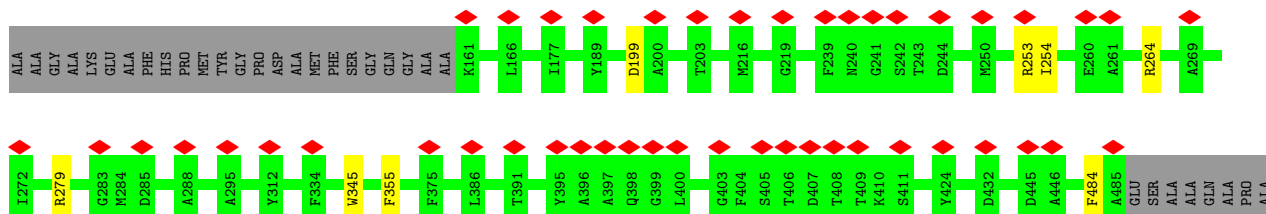
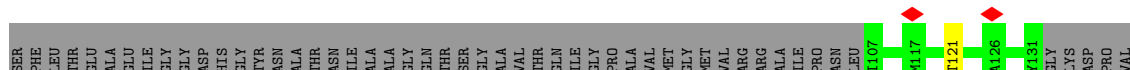
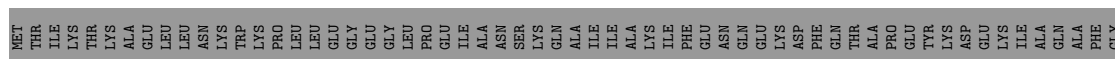

• Molecule 1: Major capsid protein

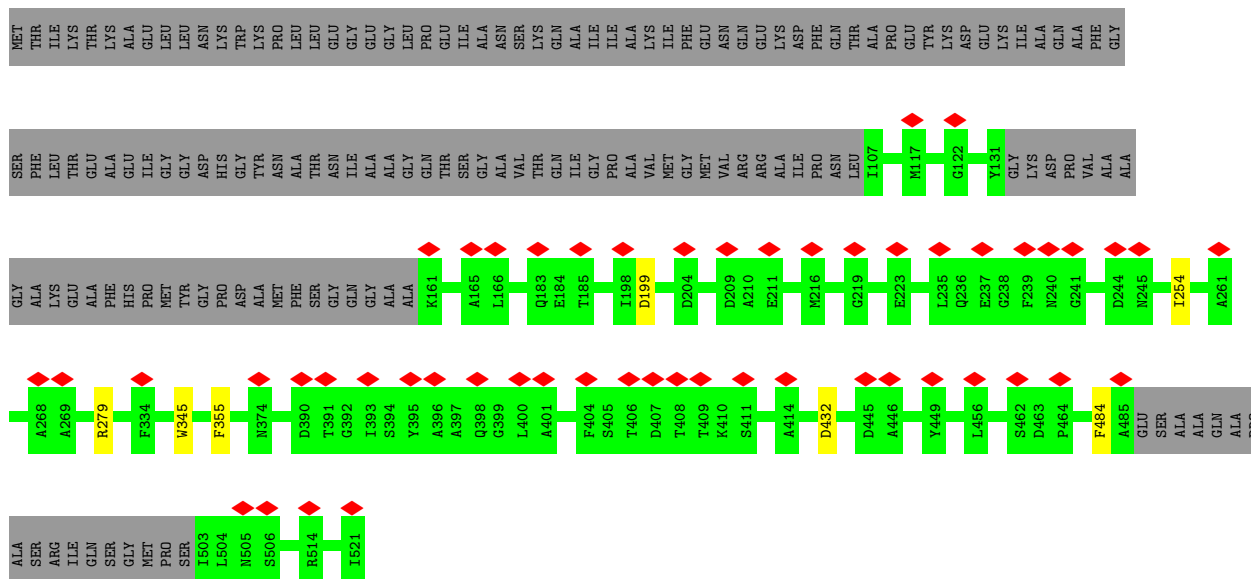

• Molecule 1: Major capsid protein

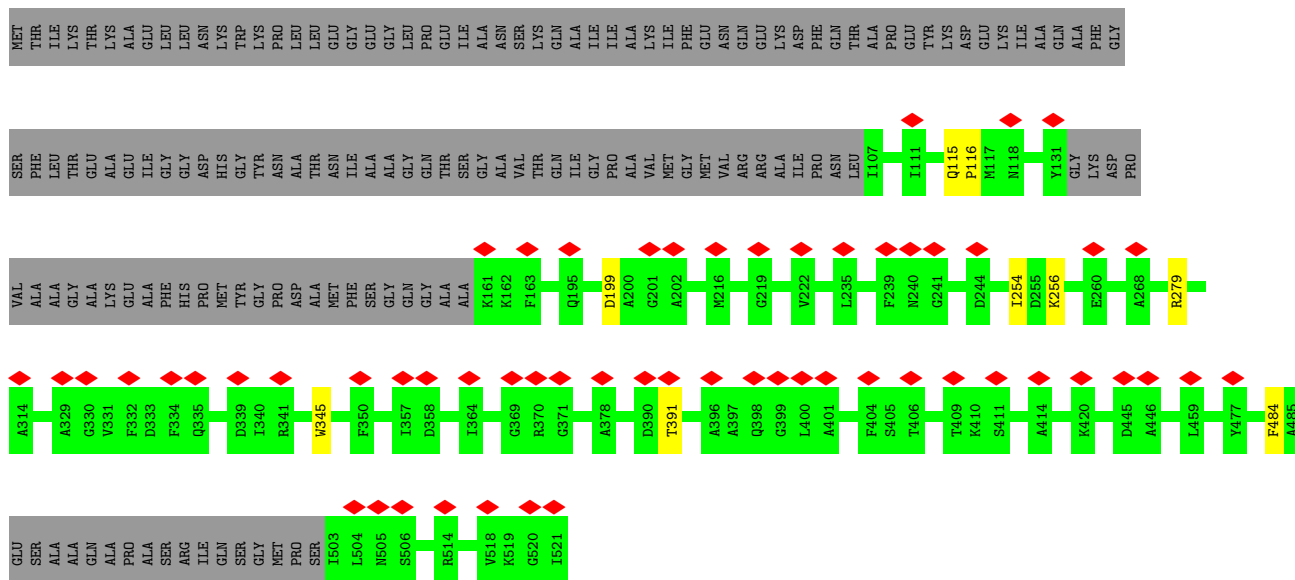

• Molecule 1: Major capsid protein

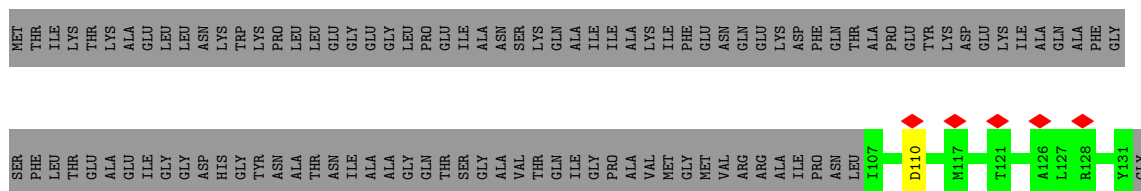

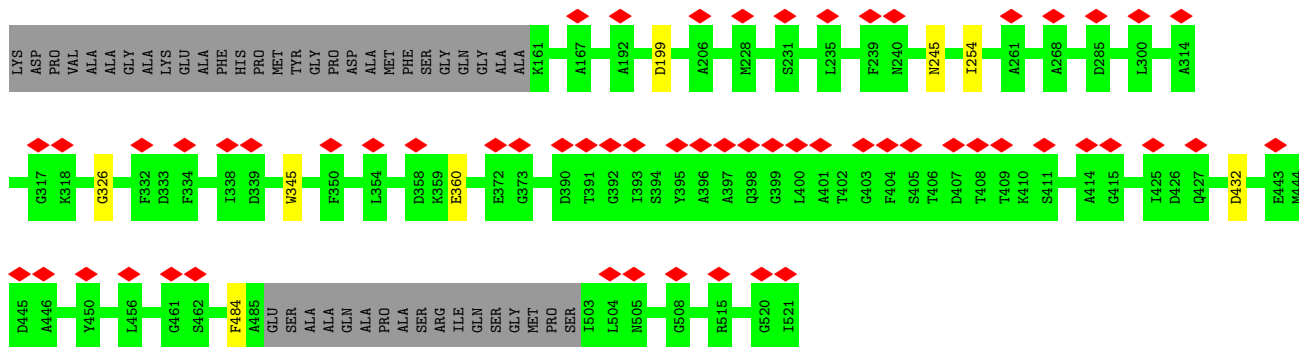

• Molecule 1: Major capsid protein

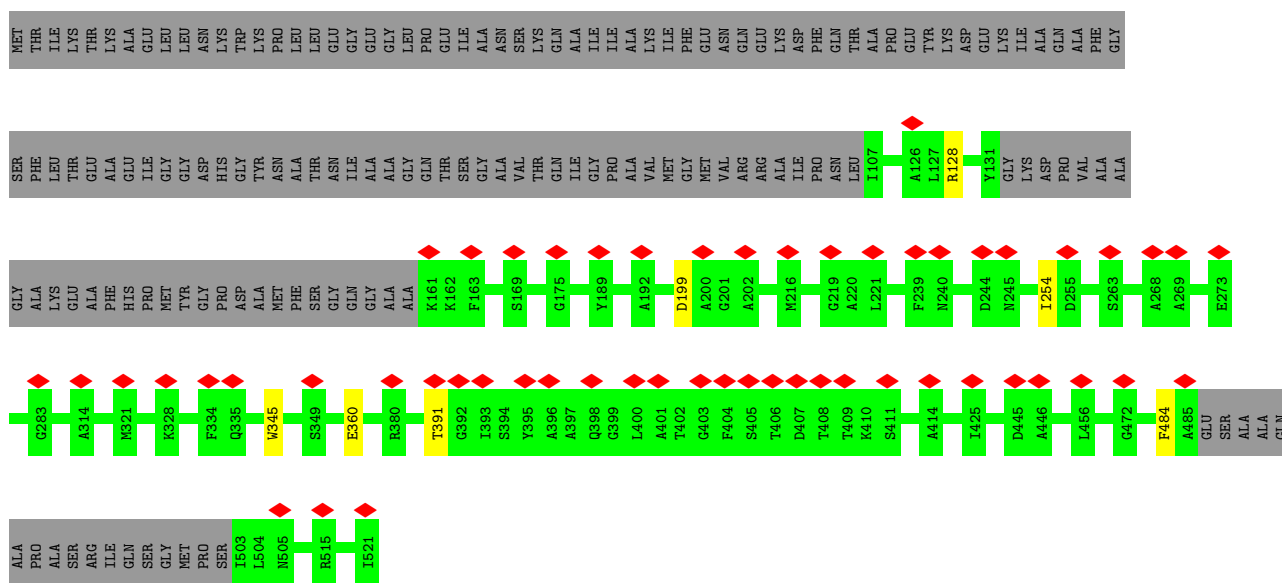

• Molecule 1: Major capsid protein

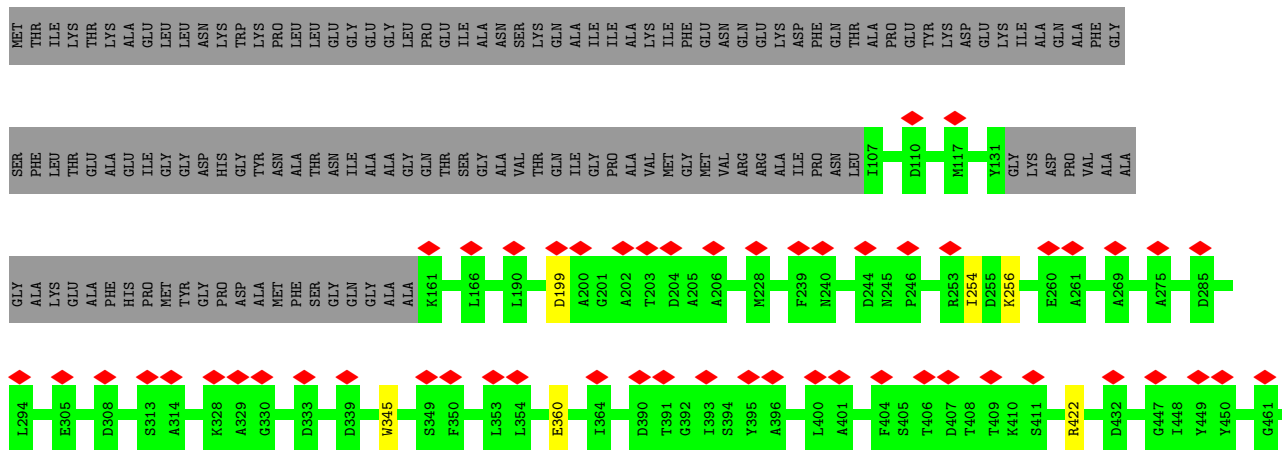

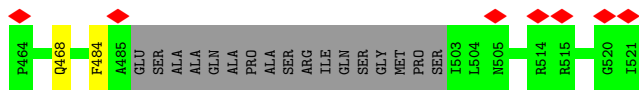

• Molecule 1: Major capsid protein

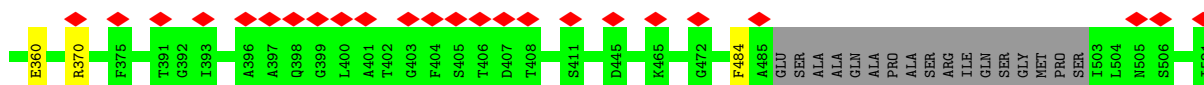
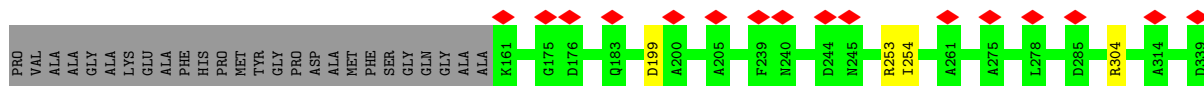
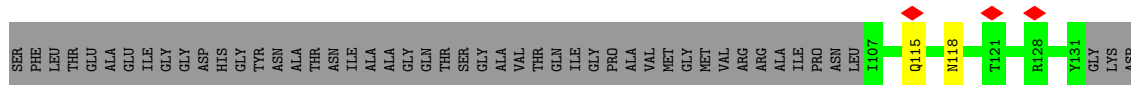
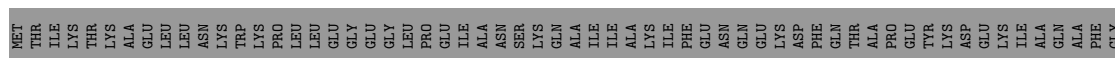

• Molecule 1: Major capsid protein

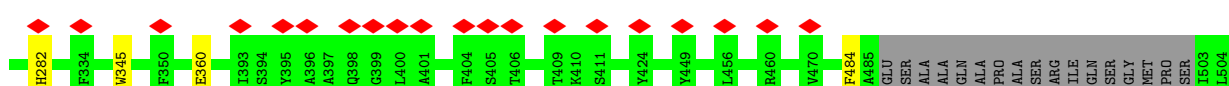
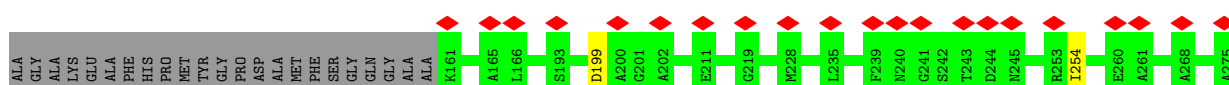
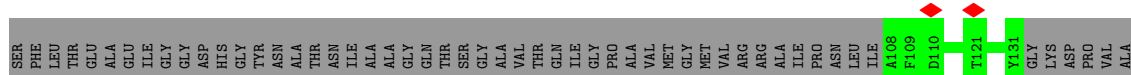

• Molecule 1: Major capsid protein

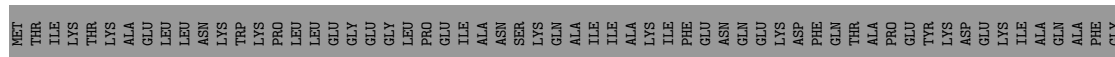

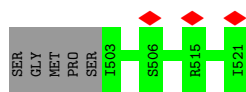

• Molecule 1: Major capsid protein

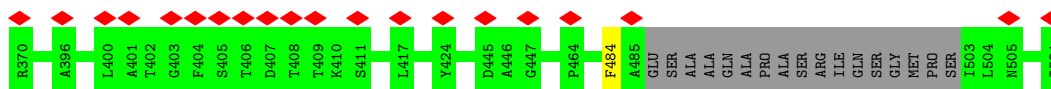
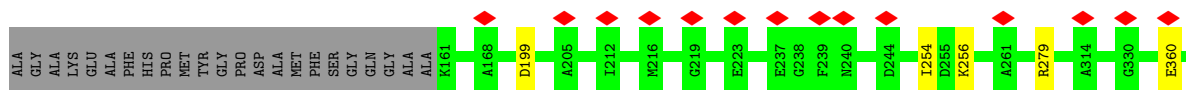
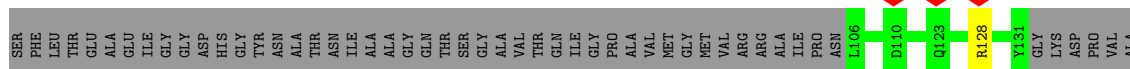
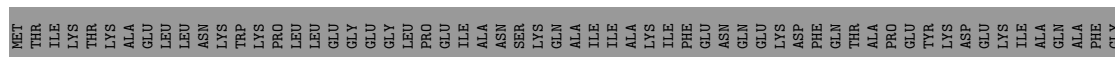

• Molecule 2: Capsid vertex protein

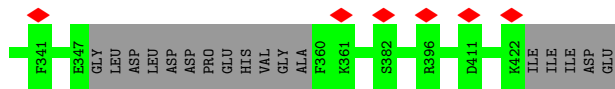
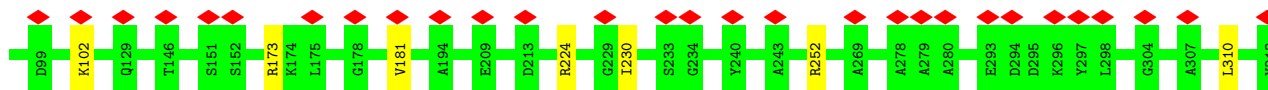
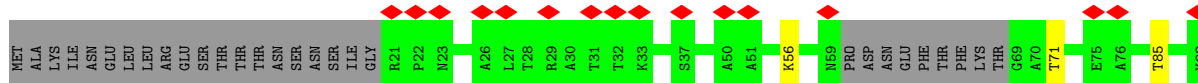
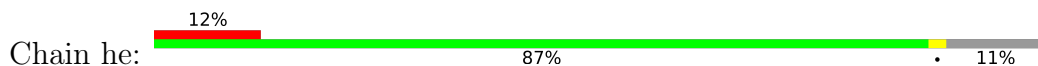

• Molecule 2: Capsid vertex protein

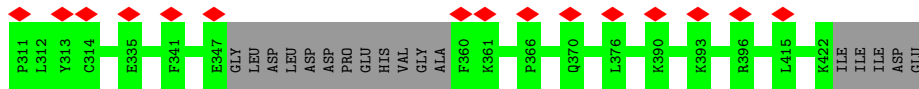
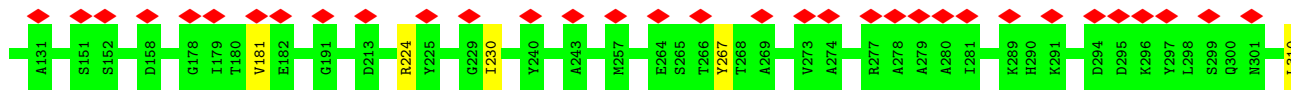
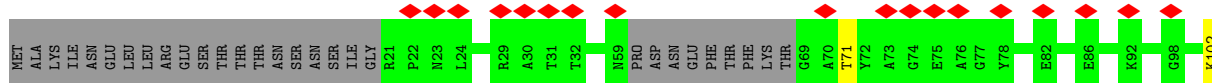
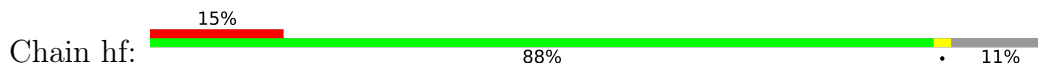

• Molecule 2: Capsid vertex protein

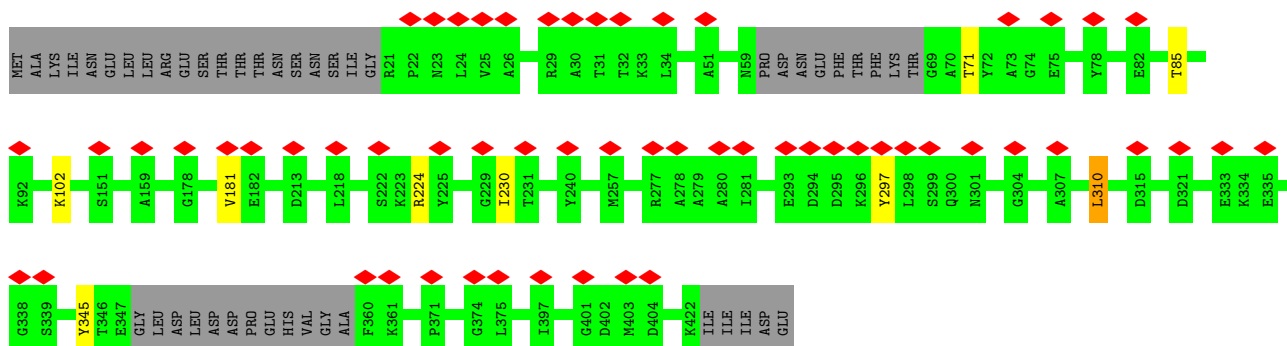
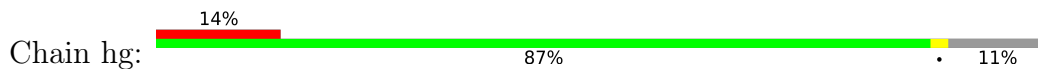

• Molecule 2: Capsid vertex protein

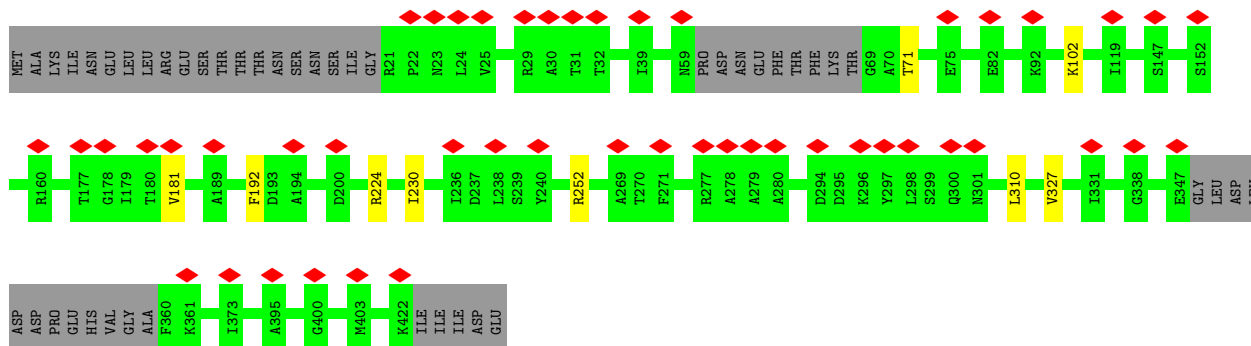
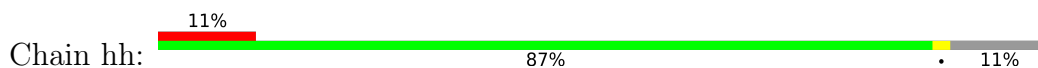

• Molecule 2: Capsid vertex protein

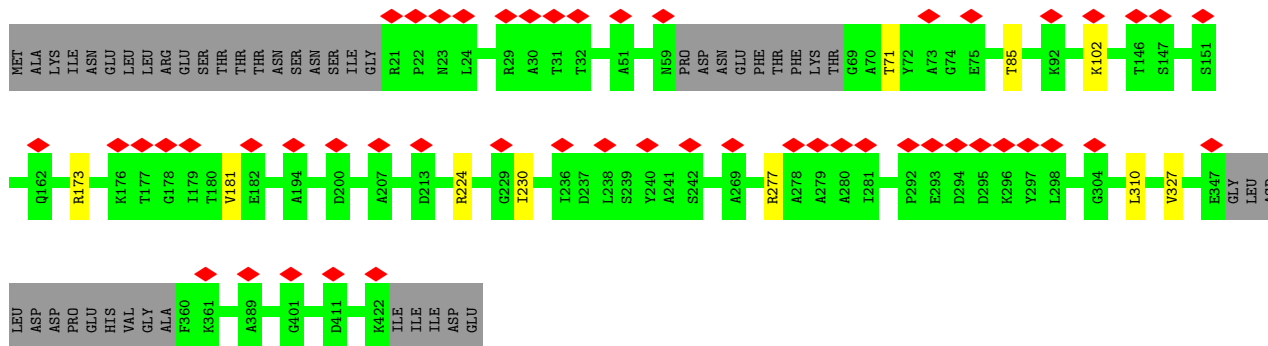
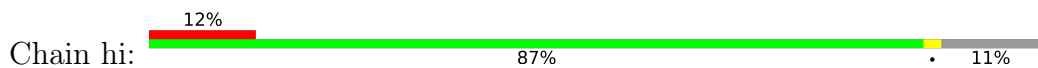

• Molecule 2: Capsid vertex protein

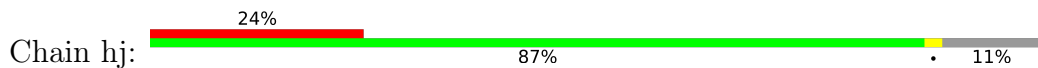

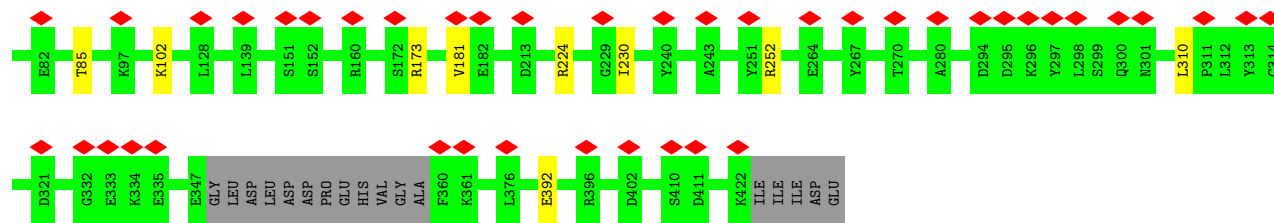

4 Experimental information

Property	Value	Source
EM reconstruction method	SINGLE PARTICLE	Depositor
Imposed symmetry	POINT, C5	Depositor
Number of particles used	28706	Depositor
Resolution determination method	FSC 0.143 CUT-OFF	Depositor
CTF correction method	PHASE FLIPPING AND AMPLITUDE CORRECTION	Depositor
Microscope	FEI TITAN KRIOS	Depositor
Voltage (kV)	300	Depositor
Electron dose ($e^-/\text{\AA}^2$)	25.3	Depositor
Minimum defocus (nm)	Not provided	
Maximum defocus (nm)	Not provided	
Magnification	Not provided	
Image detector	GATAN K2 SUMMIT (4k x 4k)	Depositor
Maximum map value	21.951	Depositor
Minimum map value	-12.494	Depositor
Average map value	0.025	Depositor
Map value standard deviation	0.977	Depositor
Recommended contour level	4.0	Depositor
Map size (Å)	1244.16, 1244.16, 1244.16	wwPDB
Map dimensions	768, 768, 768	wwPDB
Map angles (°)	90.0, 90.0, 90.0	wwPDB
Pixel spacing (Å)	1.62, 1.62, 1.62	Depositor

5 Model quality [i](#)

5.1 Standard geometry [i](#)

The Z score for a bond length (or angle) is the number of standard deviations the observed value is removed from the expected value. A bond length (or angle) with $|Z| > 5$ is considered an outlier worth inspection. RMSZ is the root-mean-square of all Z scores of the bond lengths (or angles).

Mol	Chain	Bond lengths		Bond angles	
		RMSZ	# Z >5	RMSZ	# Z >5
1	aa	0.98	0/2885	0.94	0/3903
1	ab	0.96	0/2885	0.94	0/3903
1	ac	0.97	0/2885	0.96	1/3903 (0.0%)
1	ad	0.99	0/2885	0.96	0/3903
1	ae	0.96	0/2885	0.93	0/3903
1	af	0.97	0/2864	0.93	0/3874
1	ag	1.01	0/2885	0.95	0/3903
1	ah	0.97	0/2885	0.95	0/3903
1	ai	0.99	0/2885	0.93	0/3903
1	aj	0.98	0/2885	0.96	0/3903
1	ak	0.93	0/2885	0.94	0/3903
1	al	1.00	0/2877	0.93	0/3892
1	am	0.99	0/2885	0.98	0/3903
1	an	0.98	0/2885	0.95	0/3903
1	ao	0.98	0/2885	0.95	0/3903
1	ap	1.01	0/2877	0.96	0/3892
1	aq	0.96	0/2885	0.93	0/3903
1	ar	0.98	0/2885	0.94	0/3903
1	as	1.01	0/2885	0.95	0/3903
1	at	0.99	0/2877	0.96	0/3892
1	au	0.96	0/2885	0.92	0/3903
1	av	0.98	0/2885	0.95	1/3903 (0.0%)
1	aw	0.96	0/2864	0.95	0/3874
1	ax	1.00	0/2877	0.95	0/3892
1	ay	0.96	0/2885	0.96	0/3903
1	az	0.96	0/2885	0.93	0/3903
1	ba	0.99	0/2877	0.95	0/3892
1	bb	0.97	0/2877	0.96	0/3892
1	bc	0.96	0/2885	0.93	0/3903
1	bd	1.02	0/2877	0.96	0/3892
1	be	1.01	0/2885	0.97	1/3903 (0.0%)
1	bf	0.99	0/2864	0.95	0/3874
1	bg	0.99	0/2885	0.93	0/3903
1	bh	0.99	0/2885	0.95	0/3903

Mol	Chain	Bond lengths		Bond angles	
		RMSZ	# Z >5	RMSZ	# Z >5
1	bi	0.96	0/2885	0.93	1/3903 (0.0%)
1	bj	1.01	0/2893	0.96	1/3914 (0.0%)
1	bk	0.95	0/2864	0.95	0/3874
1	bl	0.94	0/2864	0.93	0/3874
1	bm	0.98	0/2877	0.93	0/3892
1	bn	0.94	0/2877	0.96	1/3892 (0.0%)
1	bo	0.97	0/2877	0.93	1/3892 (0.0%)
1	bp	0.98	0/2885	0.92	0/3903
1	bq	1.02	0/2893	0.96	0/3914
1	br	1.01	0/2864	0.96	0/3874
1	bs	0.96	0/2864	0.92	0/3874
1	bt	1.00	0/2864	0.94	0/3874
1	bu	0.99	0/2885	0.94	0/3903
1	bv	1.02	0/2885	0.97	0/3903
1	bw	0.97	0/2885	0.95	0/3903
1	bx	0.94	0/2885	0.94	0/3903
1	by	0.93	0/2864	0.94	0/3874
1	bz	0.99	0/2877	0.94	0/3892
1	ca	0.95	0/2877	0.94	0/3892
1	cb	0.99	0/2864	0.97	0/3874
1	cc	0.95	0/2877	0.96	0/3892
1	cd	0.98	0/2893	0.94	0/3914
1	ce	0.99	0/2877	0.93	1/3892 (0.0%)
1	cf	0.96	0/2869	0.94	0/3881
1	cg	0.97	0/2869	0.97	2/3881 (0.1%)
1	ch	0.96	0/2877	0.98	0/3892
1	ci	0.96	0/2893	0.94	0/3914
1	cj	0.97	0/2877	0.93	0/3892
1	ck	0.93	0/2885	0.93	0/3903
1	cl	0.99	0/2885	0.96	0/3903
1	cm	0.97	0/2885	0.96	0/3903
1	cn	0.98	0/2877	0.93	0/3892
1	co	0.97	0/2885	0.96	0/3903
1	cp	0.95	0/2877	0.94	0/3892
1	cq	1.01	0/2877	0.93	0/3892
1	cr	0.95	0/2877	0.95	0/3892
1	cs	0.95	0/2877	0.95	0/3892
1	ct	0.97	0/2877	0.93	0/3892
1	cu	0.97	0/2864	0.97	0/3874
1	cv	0.99	0/2885	0.93	0/3903
1	cw	0.95	0/2893	0.94	1/3914 (0.0%)
1	cx	0.97	0/2877	0.98	0/3892
1	cy	0.97	0/2885	0.93	0/3903

Mol	Chain	Bond lengths		Bond angles	
		RMSZ	# Z >5	RMSZ	# Z >5
1	cz	1.00	0/2877	0.93	0/3892
1	da	0.97	0/2877	0.94	0/3892
1	db	0.97	0/2877	0.96	0/3892
1	dc	0.97	0/2877	0.96	0/3892
1	dd	0.96	0/2877	0.96	0/3892
1	de	0.96	0/2877	0.93	0/3892
1	df	0.99	0/2885	0.93	0/3903
1	dg	0.96	0/2877	0.94	0/3892
1	dh	0.98	0/2877	0.93	0/3892
1	di	0.99	0/2877	0.95	0/3892
1	dj	1.00	0/2877	0.96	0/3892
1	dk	0.96	0/2877	0.95	0/3892
1	dl	0.99	0/2877	0.96	0/3892
1	dm	1.00	0/2877	0.97	0/3892
1	dn	0.97	0/2869	0.93	0/3881
1	do	0.97	0/2877	0.91	0/3892
1	dp	0.96	0/2869	0.97	0/3881
1	dq	0.99	0/2877	0.96	0/3892
1	dr	1.01	0/2885	0.97	0/3903
1	dy	0.97	0/2885	0.96	0/3903
1	dz	0.98	0/2885	0.94	0/3903
1	ea	0.95	0/2885	0.93	0/3903
1	eb	0.97	0/2885	0.95	0/3903
1	ec	0.95	0/2885	0.92	0/3903
1	ed	0.96	0/2877	0.94	0/3892
1	ee	0.94	0/2885	0.95	0/3903
1	ef	0.96	0/2885	0.95	0/3903
1	eg	0.96	0/2885	0.94	0/3903
1	eh	0.93	0/2877	0.95	0/3892
1	ei	0.94	0/2885	0.92	0/3903
1	ej	0.96	0/2885	0.95	0/3903
1	ek	1.02	0/2885	0.95	0/3903
1	el	0.98	0/2877	0.95	0/3892
1	em	0.98	0/2885	0.94	0/3903
1	en	0.98	0/2885	0.94	0/3903
1	eo	0.97	0/2869	0.96	0/3881
1	ep	1.00	0/2877	0.95	0/3892
1	eq	0.95	0/2885	0.97	0/3903
1	er	0.95	0/2885	0.93	0/3903
1	es	0.94	0/2877	0.93	0/3892
1	et	0.99	0/2877	0.96	0/3892
1	eu	0.97	0/2885	0.91	0/3903
1	ev	0.98	0/2877	0.96	0/3892

Mol	Chain	Bond lengths		Bond angles	
		RMSZ	# Z >5	RMSZ	# Z >5
1	ew	0.97	0/2885	0.96	0/3903
1	ex	0.93	0/2864	0.96	0/3874
1	ey	0.98	0/2885	0.93	0/3903
1	ez	0.98	0/2885	0.95	0/3903
1	fa	0.97	0/2885	0.95	1/3903 (0.0%)
1	fb	0.97	0/2893	0.96	0/3914
1	fc	0.95	0/2864	0.94	0/3874
1	fd	0.96	0/2864	0.92	0/3874
1	fe	0.98	0/2877	0.95	0/3892
1	ff	0.99	0/2877	0.95	0/3892
1	fg	0.95	0/2877	0.93	0/3892
1	fh	1.00	0/2885	0.94	0/3903
1	fi	0.97	0/2893	0.97	0/3914
1	fj	0.94	0/2864	0.96	0/3874
1	fk	0.97	0/2885	0.95	0/3903
1	fl	0.99	0/2864	0.92	0/3874
1	fm	0.95	0/2885	0.92	0/3903
1	fn	0.98	0/2885	0.94	0/3903
1	fo	1.01	0/2885	0.99	0/3903
1	fp	0.98	0/2885	0.95	1/3903 (0.0%)
1	fq	0.96	0/2877	0.95	0/3892
1	fr	0.95	0/2877	0.94	0/3892
1	fs	0.94	0/2877	0.95	0/3892
1	ft	0.98	0/2864	0.95	0/3874
1	fu	0.97	0/2877	0.96	0/3892
1	fv	0.96	0/2893	0.94	1/3914 (0.0%)
1	fw	0.94	0/2877	0.92	1/3892 (0.0%)
1	fx	0.94	0/2869	0.94	0/3881
1	fy	0.95	0/2869	0.95	0/3881
1	fz	0.98	0/2877	0.97	2/3892 (0.1%)
1	ga	0.98	0/2893	0.95	0/3914
1	gb	0.97	0/2877	0.92	0/3892
1	gc	0.97	0/2885	0.95	0/3903
1	gd	0.98	0/2885	0.97	0/3903
1	ge	0.97	0/2885	0.93	0/3903
1	gf	1.00	0/2877	0.97	2/3892 (0.1%)
1	gg	0.97	0/2885	0.96	0/3903
1	gh	0.97	0/2877	0.97	0/3892
1	gi	0.97	0/2877	0.93	0/3892
1	gj	0.98	0/2877	0.95	0/3892
1	gk	0.98	0/2877	0.94	0/3892
1	gl	1.01	0/2877	0.94	0/3892
1	gm	0.97	0/2877	0.95	0/3892

Mol	Chain	Bond lengths		Bond angles	
		RMSZ	# Z >5	RMSZ	# Z >5
1	gn	0.98	0/2877	0.95	0/3892
1	go	0.97	0/2877	0.92	0/3892
1	gp	0.95	0/2877	0.96	0/3892
1	gq	0.99	0/2877	0.93	0/3892
1	gr	0.98	0/2885	0.92	0/3903
1	gs	0.98	0/2877	0.94	0/3892
1	gt	0.98	0/2877	0.95	0/3892
1	gu	0.99	0/2877	0.96	0/3892
1	gv	0.95	0/2877	0.95	0/3892
1	gw	0.95	0/2877	0.93	0/3892
1	gx	0.97	0/2877	0.95	0/3892
1	gy	0.98	0/2877	0.97	0/3892
1	gz	0.95	0/2869	0.93	0/3881
1	ha	0.98	0/2877	0.92	0/3892
1	hb	0.96	0/2869	0.95	0/3881
1	hc	0.95	0/2877	0.95	0/3892
1	hd	1.02	0/2885	0.97	0/3903
2	he	1.02	0/3002	0.93	0/4069
2	hf	1.06	0/3002	0.92	0/4069
2	hg	1.04	0/3002	0.95	1/4069 (0.0%)
2	hh	1.04	0/3002	0.94	0/4069
2	hi	1.02	0/3002	0.93	0/4069
2	hj	1.00	0/3002	0.94	0/4069
2	hk	1.01	0/3002	0.93	0/4069
2	hl	1.03	0/3002	0.96	0/4069
2	hm	0.99	0/3002	0.93	1/4069 (0.0%)
2	hn	0.99	0/3002	0.92	0/4069
2	ho	1.02	0/3002	0.93	0/4069
All	All	0.98	0/551293	0.95	21/745882 (0.0%)

Chiral center outliers are detected by calculating the chiral volume of a chiral center and verifying if the center is modelled as a planar moiety or with the opposite hand. A planarity outlier is detected by checking planarity of atoms in a peptide group, atoms in a mainchain group or atoms of a sidechain that are expected to be planar.

Mol	Chain	#Chirality outliers	#Planarity outliers
1	be	0	1
1	bj	0	1
1	br	0	1
1	cb	0	1
1	fy	0	1
All	All	0	5

There are no bond length outliers.

The worst 5 of 21 bond angle outliers are listed below:

Mol	Chain	Res	Type	Atoms	Z	Observed(°)	Ideal(°)
1	bn	469	PRO	N-CA-C	6.51	129.03	112.10
1	cg	401	ALA	CB-CA-C	6.19	119.39	110.10
1	fa	120	PRO	N-CA-C	-6.09	96.25	112.10
1	bi	120	PRO	N-CA-C	-6.08	96.28	112.10
1	cg	401	ALA	N-CA-CB	-6.03	101.65	110.10

There are no chirality outliers.

All (5) planarity outliers are listed below:

Mol	Chain	Res	Type	Group
1	be	469	PRO	Peptide
1	bj	323	LEU	Peptide
1	br	244	ASP	Peptide
1	cb	469	PRO	Peptide
1	fy	403	GLY	Peptide

5.2 Too-close contacts [i](#)

In the following table, the Non-H and H(model) columns list the number of non-hydrogen atoms and hydrogen atoms in the chain respectively. The H(added) column lists the number of hydrogen atoms added and optimized by MolProbity. The Clashes column lists the number of clashes within the asymmetric unit, whereas Symm-Clashes lists symmetry-related clashes.

Mol	Chain	Non-H	H(model)	H(added)	Clashes	Symm-Clashes
1	aa	2832	0	2801	0	0
1	ab	2832	0	2801	0	0
1	ac	2832	0	2801	0	0
1	ad	2832	0	2801	0	0
1	ae	2832	0	2801	0	0
1	af	2811	0	2774	0	0
1	ag	2832	0	2801	0	0
1	ah	2832	0	2801	0	0
1	ai	2832	0	2801	0	0
1	aj	2832	0	2801	0	0
1	ak	2832	0	2801	0	0
1	al	2824	0	2790	0	0
1	am	2832	0	2801	0	0
1	an	2832	0	2801	0	0
1	ao	2832	0	2801	0	0

Continued on next page...

Continued from previous page...

Mol	Chain	Non-H	H(model)	H(added)	Clashes	Symm-Clashes
1	ap	2824	0	2790	0	0
1	aq	2832	0	2801	0	0
1	ar	2832	0	2801	0	0
1	as	2832	0	2801	0	0
1	at	2824	0	2790	0	0
1	au	2832	0	2801	0	0
1	av	2832	0	2801	0	0
1	aw	2811	0	2774	0	0
1	ax	2824	0	2790	0	0
1	ay	2832	0	2801	0	0
1	az	2832	0	2801	0	0
1	ba	2824	0	2790	0	0
1	bb	2824	0	2790	0	0
1	bc	2832	0	2801	0	0
1	bd	2824	0	2790	0	0
1	be	2832	0	2801	0	0
1	bf	2811	0	2774	0	0
1	bg	2832	0	2801	0	0
1	bh	2832	0	2801	0	0
1	bi	2832	0	2801	0	0
1	bj	2840	0	2807	0	0
1	bk	2811	0	2774	0	0
1	bl	2811	0	2774	0	0
1	bm	2824	0	2790	0	0
1	bn	2824	0	2790	0	0
1	bo	2824	0	2790	0	0
1	bp	2832	0	2801	0	0
1	bq	2840	0	2807	0	0
1	br	2811	0	2774	0	0
1	bs	2811	0	2774	0	0
1	bt	2811	0	2774	0	0
1	bu	2832	0	2801	0	0
1	bv	2832	0	2801	0	0
1	bw	2832	0	2801	0	0
1	bx	2832	0	2801	0	0
1	by	2811	0	2774	0	0
1	bz	2824	0	2790	0	0
1	ca	2824	0	2790	0	0
1	cb	2811	0	2774	0	0
1	cc	2824	0	2790	0	0
1	cd	2840	0	2807	0	0
1	ce	2824	0	2790	0	0

Continued on next page...

Continued from previous page...

Mol	Chain	Non-H	H(model)	H(added)	Clashes	Symm-Clashes
1	cf	2816	0	2779	0	0
1	cg	2816	0	2779	0	0
1	ch	2824	0	2790	0	0
1	ci	2840	0	2807	0	0
1	cj	2824	0	2790	0	0
1	ck	2832	0	2801	0	0
1	cl	2832	0	2801	0	0
1	cm	2832	0	2801	0	0
1	cn	2824	0	2790	0	0
1	co	2832	0	2801	0	0
1	cp	2824	0	2790	0	0
1	cq	2824	0	2790	0	0
1	cr	2824	0	2790	0	0
1	cs	2824	0	2790	0	0
1	ct	2824	0	2790	0	0
1	cu	2811	0	2774	0	0
1	cv	2832	0	2801	0	0
1	cw	2840	0	2807	0	0
1	cx	2824	0	2790	0	0
1	cy	2832	0	2801	0	0
1	cz	2824	0	2790	0	0
1	da	2824	0	2790	0	0
1	db	2824	0	2790	0	0
1	dc	2824	0	2790	0	0
1	dd	2824	0	2790	0	0
1	de	2824	0	2790	0	0
1	df	2832	0	2801	0	0
1	dg	2824	0	2790	0	0
1	dh	2824	0	2790	0	0
1	di	2824	0	2790	0	0
1	dj	2824	0	2790	0	0
1	dk	2824	0	2790	0	0
1	dl	2824	0	2790	0	0
1	dm	2824	0	2790	0	0
1	dn	2816	0	2779	0	0
1	do	2824	0	2790	0	0
1	dp	2816	0	2779	0	0
1	dq	2824	0	2790	0	0
1	dr	2832	0	2801	0	0
1	dy	2832	0	2801	0	0
1	dz	2832	0	2801	0	0
1	ea	2832	0	2801	0	0

Continued on next page...

Continued from previous page...

Mol	Chain	Non-H	H(model)	H(added)	Clashes	Symm-Clashes
1	eb	2832	0	2801	0	0
1	ec	2832	0	2801	0	0
1	ed	2824	0	2790	0	0
1	ee	2832	0	2801	0	0
1	ef	2832	0	2801	0	0
1	eg	2832	0	2801	0	0
1	eh	2824	0	2790	0	0
1	ei	2832	0	2801	0	0
1	ej	2832	0	2801	0	0
1	ek	2832	0	2801	0	0
1	el	2824	0	2790	0	0
1	em	2832	0	2801	0	0
1	en	2832	0	2801	0	0
1	eo	2816	0	2779	0	0
1	ep	2824	0	2790	0	0
1	eq	2832	0	2801	0	0
1	er	2832	0	2801	0	0
1	es	2824	0	2790	0	0
1	et	2824	0	2790	0	0
1	eu	2832	0	2801	0	0
1	ev	2824	0	2790	0	0
1	ew	2832	0	2801	0	0
1	ex	2811	0	2774	0	0
1	ey	2832	0	2801	0	0
1	ez	2832	0	2801	0	0
1	fa	2832	0	2801	0	0
1	fb	2840	0	2807	0	0
1	fc	2811	0	2774	0	0
1	fd	2811	0	2774	0	0
1	fe	2824	0	2790	0	0
1	ff	2824	0	2790	0	0
1	fg	2824	0	2790	0	0
1	fh	2832	0	2801	0	0
1	fi	2840	0	2807	0	0
1	fj	2811	0	2774	0	0
1	fk	2832	0	2801	0	0
1	fl	2811	0	2774	0	0
1	fm	2832	0	2801	0	0
1	fn	2832	0	2801	0	0
1	fo	2832	0	2801	0	0
1	fp	2832	0	2801	0	0
1	fq	2824	0	2790	0	0

Continued on next page...

Continued from previous page...

Mol	Chain	Non-H	H(model)	H(added)	Clashes	Symm-Clashes
1	fr	2824	0	2790	0	0
1	fs	2824	0	2790	0	0
1	ft	2811	0	2774	0	0
1	fu	2824	0	2790	0	0
1	fv	2840	0	2807	0	0
1	fw	2824	0	2790	0	0
1	fx	2816	0	2779	0	0
1	fy	2816	0	2779	0	0
1	fz	2824	0	2790	0	0
1	ga	2840	0	2807	0	0
1	gb	2824	0	2790	0	0
1	gc	2832	0	2801	0	0
1	gd	2832	0	2801	0	0
1	ge	2832	0	2801	0	0
1	gf	2824	0	2790	0	0
1	gg	2832	0	2801	0	0
1	gh	2824	0	2790	0	0
1	gi	2824	0	2790	0	0
1	gj	2824	0	2790	0	0
1	gk	2824	0	2790	0	0
1	gl	2824	0	2790	0	0
1	gm	2824	0	2790	0	0
1	gn	2824	0	2790	0	0
1	go	2824	0	2790	0	0
1	gp	2824	0	2790	0	0
1	gq	2824	0	2790	0	0
1	gr	2832	0	2801	0	0
1	gs	2824	0	2790	0	0
1	gt	2824	0	2790	0	0
1	gu	2824	0	2790	0	0
1	gv	2824	0	2790	0	0
1	gw	2824	0	2790	0	0
1	gx	2824	0	2790	0	0
1	gy	2824	0	2790	0	0
1	gz	2816	0	2779	0	0
1	ha	2824	0	2790	0	0
1	hb	2816	0	2779	0	0
1	hc	2824	0	2790	0	0
1	hd	2832	0	2801	0	0
2	he	2954	0	2966	0	0
2	hf	2954	0	2966	0	0
2	hg	2954	0	2966	0	0

Continued on next page...

Continued from previous page...

Mol	Chain	Non-H	H(model)	H(added)	Clashes	Symm-Clashes
2	hh	2954	0	2966	0	0
2	hi	2954	0	2966	0	0
2	hj	2954	0	2966	0	0
2	hk	2954	0	2966	0	0
2	hl	2954	0	2966	0	0
2	hm	2954	0	2966	0	0
2	hn	2954	0	2966	0	0
2	ho	2954	0	2966	0	0
All	All	541225	0	535378	0	0

The all-atom clashscore is defined as the number of clashes found per 1000 atoms (including hydrogen atoms). The all-atom clashscore for this structure is 2.

There are no clashes within the asymmetric unit.

There are no symmetry-related clashes.

5.3 Torsion angles [i](#)

5.3.1 Protein backbone [i](#)

In the following table, the Percentiles column shows the percent Ramachandran outliers of the chain as a percentile score with respect to all PDB entries followed by that with respect to all EM entries.

The Analysed column shows the number of residues for which the backbone conformation was analysed, and the total number of residues.

Mol	Chain	Analysed	Favoured	Allowed	Outliers	Percentiles
1	aa	364/521 (70%)	342 (94%)	19 (5%)	3 (1%)	19 60
1	ab	364/521 (70%)	339 (93%)	21 (6%)	4 (1%)	14 52
1	ac	364/521 (70%)	340 (93%)	19 (5%)	5 (1%)	11 46
1	ad	364/521 (70%)	343 (94%)	16 (4%)	5 (1%)	11 46
1	ae	364/521 (70%)	338 (93%)	20 (6%)	6 (2%)	9 44
1	af	361/521 (69%)	333 (92%)	23 (6%)	5 (1%)	11 46
1	ag	364/521 (70%)	336 (92%)	23 (6%)	5 (1%)	11 46
1	ah	364/521 (70%)	336 (92%)	25 (7%)	3 (1%)	19 60
1	ai	364/521 (70%)	338 (93%)	21 (6%)	5 (1%)	11 46
1	aj	364/521 (70%)	342 (94%)	19 (5%)	3 (1%)	19 60

Continued on next page...

Continued from previous page...

Mol	Chain	Analysed	Favoured	Allowed	Outliers	Percentiles	
1	ak	364/521 (70%)	343 (94%)	16 (4%)	5 (1%)	11	46
1	al	363/521 (70%)	337 (93%)	21 (6%)	5 (1%)	11	46
1	am	364/521 (70%)	339 (93%)	18 (5%)	7 (2%)	8	40
1	an	364/521 (70%)	340 (93%)	18 (5%)	6 (2%)	9	44
1	ao	364/521 (70%)	337 (93%)	24 (7%)	3 (1%)	19	60
1	ap	363/521 (70%)	342 (94%)	17 (5%)	4 (1%)	14	52
1	aq	364/521 (70%)	341 (94%)	18 (5%)	5 (1%)	11	46
1	ar	364/521 (70%)	339 (93%)	21 (6%)	4 (1%)	14	52
1	as	364/521 (70%)	335 (92%)	24 (7%)	5 (1%)	11	46
1	at	363/521 (70%)	340 (94%)	17 (5%)	6 (2%)	9	43
1	au	364/521 (70%)	337 (93%)	23 (6%)	4 (1%)	14	52
1	av	364/521 (70%)	340 (93%)	19 (5%)	5 (1%)	11	46
1	aw	361/521 (69%)	339 (94%)	17 (5%)	5 (1%)	11	46
1	ax	363/521 (70%)	336 (93%)	23 (6%)	4 (1%)	14	52
1	ay	364/521 (70%)	341 (94%)	17 (5%)	6 (2%)	9	44
1	az	364/521 (70%)	340 (93%)	20 (6%)	4 (1%)	14	52
1	ba	363/521 (70%)	335 (92%)	24 (7%)	4 (1%)	14	52
1	bb	363/521 (70%)	342 (94%)	17 (5%)	4 (1%)	14	52
1	bc	364/521 (70%)	334 (92%)	24 (7%)	6 (2%)	9	44
1	bd	363/521 (70%)	339 (93%)	19 (5%)	5 (1%)	11	46
1	be	364/521 (70%)	339 (93%)	18 (5%)	7 (2%)	8	40
1	bf	361/521 (69%)	339 (94%)	18 (5%)	4 (1%)	14	52
1	bg	364/521 (70%)	340 (93%)	19 (5%)	5 (1%)	11	46
1	bh	364/521 (70%)	341 (94%)	15 (4%)	8 (2%)	6	37
1	bi	364/521 (70%)	337 (93%)	22 (6%)	5 (1%)	11	46
1	bj	365/521 (70%)	337 (92%)	23 (6%)	5 (1%)	11	46
1	bk	361/521 (69%)	331 (92%)	23 (6%)	7 (2%)	8	40
1	bl	361/521 (69%)	338 (94%)	18 (5%)	5 (1%)	11	46
1	bm	363/521 (70%)	341 (94%)	18 (5%)	4 (1%)	14	52
1	bn	363/521 (70%)	338 (93%)	21 (6%)	4 (1%)	14	52
1	bo	363/521 (70%)	338 (93%)	21 (6%)	4 (1%)	14	52

Continued on next page...

Continued from previous page...

Mol	Chain	Analysed	Favoured	Allowed	Outliers	Percentiles	
1	bp	364/521 (70%)	341 (94%)	20 (6%)	3 (1%)	19	60
1	bq	365/521 (70%)	341 (93%)	19 (5%)	5 (1%)	11	46
1	br	361/521 (69%)	336 (93%)	20 (6%)	5 (1%)	11	46
1	bs	361/521 (69%)	334 (92%)	21 (6%)	6 (2%)	9	43
1	bt	361/521 (69%)	334 (92%)	21 (6%)	6 (2%)	9	43
1	bu	364/521 (70%)	338 (93%)	21 (6%)	5 (1%)	11	46
1	bv	364/521 (70%)	334 (92%)	25 (7%)	5 (1%)	11	46
1	bw	364/521 (70%)	340 (93%)	17 (5%)	7 (2%)	8	40
1	bx	364/521 (70%)	337 (93%)	22 (6%)	5 (1%)	11	46
1	by	361/521 (69%)	336 (93%)	21 (6%)	4 (1%)	14	52
1	bz	363/521 (70%)	335 (92%)	23 (6%)	5 (1%)	11	46
1	ca	363/521 (70%)	337 (93%)	21 (6%)	5 (1%)	11	46
1	cb	361/521 (69%)	335 (93%)	22 (6%)	4 (1%)	14	52
1	cc	363/521 (70%)	335 (92%)	18 (5%)	10 (3%)	5	32
1	cd	365/521 (70%)	343 (94%)	18 (5%)	4 (1%)	14	52
1	ce	363/521 (70%)	338 (93%)	21 (6%)	4 (1%)	14	52
1	cf	362/521 (70%)	343 (95%)	17 (5%)	2 (1%)	25	65
1	cg	362/521 (70%)	336 (93%)	21 (6%)	5 (1%)	11	46
1	ch	363/521 (70%)	336 (93%)	23 (6%)	4 (1%)	14	52
1	ci	365/521 (70%)	340 (93%)	20 (6%)	5 (1%)	11	46
1	cj	363/521 (70%)	340 (94%)	19 (5%)	4 (1%)	14	52
1	ck	364/521 (70%)	338 (93%)	21 (6%)	5 (1%)	11	46
1	cl	364/521 (70%)	341 (94%)	17 (5%)	6 (2%)	9	44
1	cm	364/521 (70%)	342 (94%)	17 (5%)	5 (1%)	11	46
1	cn	363/521 (70%)	338 (93%)	20 (6%)	5 (1%)	11	46
1	co	364/521 (70%)	339 (93%)	20 (6%)	5 (1%)	11	46
1	cp	363/521 (70%)	337 (93%)	21 (6%)	5 (1%)	11	46
1	cq	363/521 (70%)	338 (93%)	20 (6%)	5 (1%)	11	46
1	cr	363/521 (70%)	337 (93%)	20 (6%)	6 (2%)	9	43
1	cs	363/521 (70%)	340 (94%)	18 (5%)	5 (1%)	11	46
1	ct	363/521 (70%)	340 (94%)	20 (6%)	3 (1%)	19	60

Continued on next page...

Continued from previous page...

Mol	Chain	Analysed	Favoured	Allowed	Outliers	Percentiles	
1	cu	361/521 (69%)	337 (93%)	17 (5%)	7 (2%)	8	40
1	cv	364/521 (70%)	335 (92%)	24 (7%)	5 (1%)	11	46
1	cw	365/521 (70%)	339 (93%)	21 (6%)	5 (1%)	11	46
1	cx	363/521 (70%)	337 (93%)	22 (6%)	4 (1%)	14	52
1	cy	364/521 (70%)	341 (94%)	17 (5%)	6 (2%)	9	44
1	cz	363/521 (70%)	341 (94%)	17 (5%)	5 (1%)	11	46
1	da	363/521 (70%)	337 (93%)	20 (6%)	6 (2%)	9	43
1	db	363/521 (70%)	335 (92%)	25 (7%)	3 (1%)	19	60
1	dc	363/521 (70%)	336 (93%)	22 (6%)	5 (1%)	11	46
1	dd	363/521 (70%)	336 (93%)	23 (6%)	4 (1%)	14	52
1	de	363/521 (70%)	340 (94%)	18 (5%)	5 (1%)	11	46
1	df	364/521 (70%)	336 (92%)	24 (7%)	4 (1%)	14	52
1	dg	363/521 (70%)	337 (93%)	20 (6%)	6 (2%)	9	43
1	dh	363/521 (70%)	339 (93%)	20 (6%)	4 (1%)	14	52
1	di	363/521 (70%)	334 (92%)	25 (7%)	4 (1%)	14	52
1	dj	363/521 (70%)	339 (93%)	18 (5%)	6 (2%)	9	43
1	dk	363/521 (70%)	338 (93%)	19 (5%)	6 (2%)	9	43
1	dl	363/521 (70%)	337 (93%)	21 (6%)	5 (1%)	11	46
1	dm	363/521 (70%)	338 (93%)	20 (6%)	5 (1%)	11	46
1	dn	362/521 (70%)	341 (94%)	16 (4%)	5 (1%)	11	46
1	do	363/521 (70%)	339 (93%)	20 (6%)	4 (1%)	14	52
1	dp	362/521 (70%)	339 (94%)	20 (6%)	3 (1%)	19	60
1	dq	363/521 (70%)	336 (93%)	23 (6%)	4 (1%)	14	52
1	dr	364/521 (70%)	341 (94%)	18 (5%)	5 (1%)	11	46
1	dy	364/521 (70%)	339 (93%)	20 (6%)	5 (1%)	11	46
1	dz	364/521 (70%)	342 (94%)	17 (5%)	5 (1%)	11	46
1	ea	364/521 (70%)	339 (93%)	21 (6%)	4 (1%)	14	52
1	eb	364/521 (70%)	343 (94%)	17 (5%)	4 (1%)	14	52
1	ec	364/521 (70%)	340 (93%)	19 (5%)	5 (1%)	11	46
1	ed	363/521 (70%)	338 (93%)	21 (6%)	4 (1%)	14	52
1	ee	364/521 (70%)	336 (92%)	23 (6%)	5 (1%)	11	46

Continued on next page...

Continued from previous page...

Mol	Chain	Analysed	Favoured	Allowed	Outliers	Percentiles	
1	ef	364/521 (70%)	340 (93%)	18 (5%)	6 (2%)	9	44
1	eg	364/521 (70%)	338 (93%)	21 (6%)	5 (1%)	11	46
1	eh	363/521 (70%)	340 (94%)	20 (6%)	3 (1%)	19	60
1	ei	364/521 (70%)	339 (93%)	20 (6%)	5 (1%)	11	46
1	ej	364/521 (70%)	340 (93%)	19 (5%)	5 (1%)	11	46
1	ek	364/521 (70%)	338 (93%)	20 (6%)	6 (2%)	9	44
1	el	363/521 (70%)	339 (93%)	18 (5%)	6 (2%)	9	43
1	em	364/521 (70%)	339 (93%)	21 (6%)	4 (1%)	14	52
1	en	364/521 (70%)	339 (93%)	20 (6%)	5 (1%)	11	46
1	eo	362/521 (70%)	338 (93%)	19 (5%)	5 (1%)	11	46
1	ep	363/521 (70%)	335 (92%)	25 (7%)	3 (1%)	19	60
1	eq	364/521 (70%)	338 (93%)	20 (6%)	6 (2%)	9	44
1	er	364/521 (70%)	340 (93%)	20 (6%)	4 (1%)	14	52
1	es	363/521 (70%)	341 (94%)	17 (5%)	5 (1%)	11	46
1	et	363/521 (70%)	341 (94%)	17 (5%)	5 (1%)	11	46
1	eu	364/521 (70%)	340 (93%)	20 (6%)	4 (1%)	14	52
1	ev	363/521 (70%)	337 (93%)	20 (6%)	6 (2%)	9	43
1	ew	364/521 (70%)	336 (92%)	25 (7%)	3 (1%)	19	60
1	ex	361/521 (69%)	338 (94%)	19 (5%)	4 (1%)	14	52
1	ey	364/521 (70%)	343 (94%)	16 (4%)	5 (1%)	11	46
1	ez	364/521 (70%)	341 (94%)	17 (5%)	6 (2%)	9	44
1	fa	364/521 (70%)	342 (94%)	17 (5%)	5 (1%)	11	46
1	fb	365/521 (70%)	340 (93%)	20 (6%)	5 (1%)	11	46
1	fc	361/521 (69%)	336 (93%)	17 (5%)	8 (2%)	6	37
1	fd	361/521 (69%)	337 (93%)	21 (6%)	3 (1%)	19	60
1	fe	363/521 (70%)	338 (93%)	21 (6%)	4 (1%)	14	52
1	ff	363/521 (70%)	338 (93%)	21 (6%)	4 (1%)	14	52
1	fg	363/521 (70%)	339 (93%)	19 (5%)	5 (1%)	11	46
1	fh	364/521 (70%)	341 (94%)	19 (5%)	4 (1%)	14	52
1	fi	365/521 (70%)	341 (93%)	19 (5%)	5 (1%)	11	46
1	fj	361/521 (69%)	336 (93%)	21 (6%)	4 (1%)	14	52

Continued on next page...

Continued from previous page...

Mol	Chain	Analysed	Favoured	Allowed	Outliers	Percentiles	
1	fk	364/521 (70%)	338 (93%)	21 (6%)	5 (1%)	11	46
1	fl	361/521 (69%)	338 (94%)	18 (5%)	5 (1%)	11	46
1	fm	364/521 (70%)	342 (94%)	17 (5%)	5 (1%)	11	46
1	fn	364/521 (70%)	335 (92%)	25 (7%)	4 (1%)	14	52
1	fo	364/521 (70%)	337 (93%)	20 (6%)	7 (2%)	8	40
1	fp	364/521 (70%)	338 (93%)	20 (6%)	6 (2%)	9	44
1	fq	363/521 (70%)	339 (93%)	21 (6%)	3 (1%)	19	60
1	fr	363/521 (70%)	339 (93%)	18 (5%)	6 (2%)	9	43
1	fs	363/521 (70%)	343 (94%)	15 (4%)	5 (1%)	11	46
1	ft	361/521 (69%)	333 (92%)	24 (7%)	4 (1%)	14	52
1	fu	363/521 (70%)	341 (94%)	16 (4%)	6 (2%)	9	43
1	fv	365/521 (70%)	344 (94%)	16 (4%)	5 (1%)	11	46
1	fw	363/521 (70%)	340 (94%)	20 (6%)	3 (1%)	19	60
1	fx	362/521 (70%)	340 (94%)	19 (5%)	3 (1%)	19	60
1	fy	362/521 (70%)	337 (93%)	20 (6%)	5 (1%)	11	46
1	fz	363/521 (70%)	338 (93%)	20 (6%)	5 (1%)	11	46
1	ga	365/521 (70%)	340 (93%)	21 (6%)	4 (1%)	14	52
1	gb	363/521 (70%)	341 (94%)	19 (5%)	3 (1%)	19	60
1	gc	364/521 (70%)	340 (93%)	17 (5%)	7 (2%)	8	40
1	gd	364/521 (70%)	337 (93%)	22 (6%)	5 (1%)	11	46
1	ge	364/521 (70%)	341 (94%)	18 (5%)	5 (1%)	11	46
1	gf	363/521 (70%)	333 (92%)	25 (7%)	5 (1%)	11	46
1	gg	364/521 (70%)	338 (93%)	23 (6%)	3 (1%)	19	60
1	gh	363/521 (70%)	339 (93%)	19 (5%)	5 (1%)	11	46
1	gi	363/521 (70%)	339 (93%)	19 (5%)	5 (1%)	11	46
1	gj	363/521 (70%)	335 (92%)	24 (7%)	4 (1%)	14	52
1	gk	363/521 (70%)	336 (93%)	22 (6%)	5 (1%)	11	46
1	gl	363/521 (70%)	336 (93%)	23 (6%)	4 (1%)	14	52
1	gm	363/521 (70%)	337 (93%)	23 (6%)	3 (1%)	19	60
1	gn	363/521 (70%)	336 (93%)	23 (6%)	4 (1%)	14	52
1	go	363/521 (70%)	338 (93%)	21 (6%)	4 (1%)	14	52

Continued on next page...

Continued from previous page...

Mol	Chain	Analysed	Favoured	Allowed	Outliers	Percentiles	
1	gp	363/521 (70%)	340 (94%)	20 (6%)	3 (1%)	19	60
1	gq	363/521 (70%)	340 (94%)	18 (5%)	5 (1%)	11	46
1	gr	364/521 (70%)	342 (94%)	18 (5%)	4 (1%)	14	52
1	gs	363/521 (70%)	334 (92%)	22 (6%)	7 (2%)	8	40
1	gt	363/521 (70%)	339 (93%)	19 (5%)	5 (1%)	11	46
1	gu	363/521 (70%)	335 (92%)	22 (6%)	6 (2%)	9	43
1	gv	363/521 (70%)	337 (93%)	18 (5%)	8 (2%)	6	37
1	gw	363/521 (70%)	341 (94%)	17 (5%)	5 (1%)	11	46
1	gx	363/521 (70%)	339 (93%)	20 (6%)	4 (1%)	14	52
1	gy	363/521 (70%)	329 (91%)	29 (8%)	5 (1%)	11	46
1	gz	362/521 (70%)	337 (93%)	21 (6%)	4 (1%)	14	52
1	ha	363/521 (70%)	337 (93%)	21 (6%)	5 (1%)	11	46
1	hb	362/521 (70%)	337 (93%)	21 (6%)	4 (1%)	14	52
1	hc	363/521 (70%)	335 (92%)	25 (7%)	3 (1%)	19	60
1	hd	364/521 (70%)	342 (94%)	19 (5%)	3 (1%)	19	60
2	he	375/427 (88%)	356 (95%)	14 (4%)	5 (1%)	12	48
2	hf	375/427 (88%)	356 (95%)	15 (4%)	4 (1%)	14	52
2	hg	375/427 (88%)	356 (95%)	14 (4%)	5 (1%)	12	48
2	hh	375/427 (88%)	356 (95%)	15 (4%)	4 (1%)	14	52
2	hi	375/427 (88%)	356 (95%)	15 (4%)	4 (1%)	14	52
2	hj	375/427 (88%)	351 (94%)	19 (5%)	5 (1%)	12	48
2	hk	375/427 (88%)	354 (94%)	17 (4%)	4 (1%)	14	52
2	hl	375/427 (88%)	351 (94%)	20 (5%)	4 (1%)	14	52
2	hm	375/427 (88%)	356 (95%)	14 (4%)	5 (1%)	12	48
2	hn	375/427 (88%)	357 (95%)	14 (4%)	4 (1%)	14	52
2	ho	375/427 (88%)	355 (95%)	15 (4%)	5 (1%)	12	48
All	All	69510/98477 (71%)	64810 (93%)	3789 (6%)	911 (1%)	16	48

5 of 911 Ramachandran outliers are listed below:

Mol	Chain	Res	Type
1	ab	484	PHE
1	ac	391	THR

Continued on next page...

Continued from previous page...

Mol	Chain	Res	Type
1	ac	484	PHE
1	ae	345	TRP
1	ag	484	PHE

5.3.2 Protein sidechains [i](#)

In the following table, the Percentiles column shows the percent sidechain outliers of the chain as a percentile score with respect to all PDB entries followed by that with respect to all EM entries.

The Analysed column shows the number of residues for which the sidechain conformation was analysed, and the total number of residues.

Mol	Chain	Analysed	Rotameric	Outliers	Percentiles	
1	aa	290/400 (72%)	286 (99%)	4 (1%)	67	81
1	ab	290/400 (72%)	287 (99%)	3 (1%)	76	86
1	ac	290/400 (72%)	289 (100%)	1 (0%)	92	95
1	ad	290/400 (72%)	288 (99%)	2 (1%)	84	90
1	ae	290/400 (72%)	287 (99%)	3 (1%)	76	86
1	af	288/400 (72%)	286 (99%)	2 (1%)	84	90
1	ag	290/400 (72%)	284 (98%)	6 (2%)	53	72
1	ah	290/400 (72%)	285 (98%)	5 (2%)	60	78
1	ai	290/400 (72%)	288 (99%)	2 (1%)	84	90
1	aj	290/400 (72%)	289 (100%)	1 (0%)	92	95
1	ak	290/400 (72%)	287 (99%)	3 (1%)	76	86
1	al	289/400 (72%)	288 (100%)	1 (0%)	92	95
1	am	290/400 (72%)	286 (99%)	4 (1%)	67	81
1	an	290/400 (72%)	287 (99%)	3 (1%)	76	86
1	ao	290/400 (72%)	290 (100%)	0	100	100
1	ap	289/400 (72%)	286 (99%)	3 (1%)	76	86
1	aq	290/400 (72%)	287 (99%)	3 (1%)	76	86
1	ar	290/400 (72%)	289 (100%)	1 (0%)	92	95
1	as	290/400 (72%)	288 (99%)	2 (1%)	84	90
1	at	289/400 (72%)	285 (99%)	4 (1%)	67	81
1	au	290/400 (72%)	289 (100%)	1 (0%)	92	95

Continued on next page...

Continued from previous page...

Mol	Chain	Analysed	Rotameric	Outliers	Percentiles	
1	av	290/400 (72%)	287 (99%)	3 (1%)	76	86
1	aw	288/400 (72%)	286 (99%)	2 (1%)	84	90
1	ax	289/400 (72%)	286 (99%)	3 (1%)	76	86
1	ay	290/400 (72%)	286 (99%)	4 (1%)	67	81
1	az	290/400 (72%)	288 (99%)	2 (1%)	84	90
1	ba	289/400 (72%)	284 (98%)	5 (2%)	60	78
1	bb	289/400 (72%)	285 (99%)	4 (1%)	67	81
1	bc	290/400 (72%)	286 (99%)	4 (1%)	67	81
1	bd	289/400 (72%)	286 (99%)	3 (1%)	76	86
1	be	290/400 (72%)	288 (99%)	2 (1%)	84	90
1	bf	288/400 (72%)	284 (99%)	4 (1%)	67	81
1	bg	290/400 (72%)	288 (99%)	2 (1%)	84	90
1	bh	290/400 (72%)	288 (99%)	2 (1%)	84	90
1	bi	290/400 (72%)	285 (98%)	5 (2%)	60	78
1	bj	291/400 (73%)	288 (99%)	3 (1%)	76	86
1	bk	288/400 (72%)	285 (99%)	3 (1%)	76	86
1	bl	288/400 (72%)	284 (99%)	4 (1%)	67	81
1	bm	289/400 (72%)	287 (99%)	2 (1%)	84	90
1	bn	289/400 (72%)	286 (99%)	3 (1%)	76	86
1	bo	289/400 (72%)	285 (99%)	4 (1%)	67	81
1	bp	290/400 (72%)	285 (98%)	5 (2%)	60	78
1	bq	291/400 (73%)	288 (99%)	3 (1%)	76	86
1	br	288/400 (72%)	283 (98%)	5 (2%)	60	78
1	bs	288/400 (72%)	285 (99%)	3 (1%)	76	86
1	bt	288/400 (72%)	286 (99%)	2 (1%)	84	90
1	bu	290/400 (72%)	285 (98%)	5 (2%)	60	78
1	bv	290/400 (72%)	288 (99%)	2 (1%)	84	90
1	bw	290/400 (72%)	289 (100%)	1 (0%)	92	95
1	bx	290/400 (72%)	285 (98%)	5 (2%)	60	78
1	by	288/400 (72%)	285 (99%)	3 (1%)	76	86
1	bz	289/400 (72%)	285 (99%)	4 (1%)	67	81

Continued on next page...

Continued from previous page...

Mol	Chain	Analysed	Rotameric	Outliers	Percentiles	
1	ca	289/400 (72%)	284 (98%)	5 (2%)	60	78
1	cb	288/400 (72%)	285 (99%)	3 (1%)	76	86
1	cc	289/400 (72%)	287 (99%)	2 (1%)	84	90
1	cd	291/400 (73%)	288 (99%)	3 (1%)	76	86
1	ce	289/400 (72%)	286 (99%)	3 (1%)	76	86
1	cf	288/400 (72%)	285 (99%)	3 (1%)	76	86
1	cg	288/400 (72%)	285 (99%)	3 (1%)	76	86
1	ch	289/400 (72%)	284 (98%)	5 (2%)	60	78
1	ci	291/400 (73%)	288 (99%)	3 (1%)	76	86
1	cj	289/400 (72%)	286 (99%)	3 (1%)	76	86
1	ck	290/400 (72%)	286 (99%)	4 (1%)	67	81
1	cl	290/400 (72%)	289 (100%)	1 (0%)	92	95
1	cm	290/400 (72%)	285 (98%)	5 (2%)	60	78
1	cn	289/400 (72%)	289 (100%)	0	100	100
1	co	290/400 (72%)	285 (98%)	5 (2%)	60	78
1	cp	289/400 (72%)	287 (99%)	2 (1%)	84	90
1	cq	289/400 (72%)	286 (99%)	3 (1%)	76	86
1	cr	289/400 (72%)	287 (99%)	2 (1%)	84	90
1	cs	289/400 (72%)	284 (98%)	5 (2%)	60	78
1	ct	289/400 (72%)	283 (98%)	6 (2%)	53	72
1	cu	288/400 (72%)	284 (99%)	4 (1%)	67	81
1	cv	290/400 (72%)	287 (99%)	3 (1%)	76	86
1	cw	291/400 (73%)	288 (99%)	3 (1%)	76	86
1	cx	289/400 (72%)	286 (99%)	3 (1%)	76	86
1	cy	290/400 (72%)	284 (98%)	6 (2%)	53	72
1	cz	289/400 (72%)	287 (99%)	2 (1%)	84	90
1	da	289/400 (72%)	288 (100%)	1 (0%)	92	95
1	db	289/400 (72%)	283 (98%)	6 (2%)	53	72
1	dc	289/400 (72%)	287 (99%)	2 (1%)	84	90
1	dd	289/400 (72%)	286 (99%)	3 (1%)	76	86
1	de	289/400 (72%)	287 (99%)	2 (1%)	84	90

Continued on next page...

Continued from previous page...

Mol	Chain	Analysed	Rotameric	Outliers	Percentiles	
1	df	290/400 (72%)	289 (100%)	1 (0%)	92	95
1	dg	289/400 (72%)	287 (99%)	2 (1%)	84	90
1	dh	289/400 (72%)	286 (99%)	3 (1%)	76	86
1	di	289/400 (72%)	286 (99%)	3 (1%)	76	86
1	dj	289/400 (72%)	288 (100%)	1 (0%)	92	95
1	dk	289/400 (72%)	283 (98%)	6 (2%)	53	72
1	dl	289/400 (72%)	286 (99%)	3 (1%)	76	86
1	dm	289/400 (72%)	288 (100%)	1 (0%)	92	95
1	dn	288/400 (72%)	284 (99%)	4 (1%)	67	81
1	do	289/400 (72%)	287 (99%)	2 (1%)	84	90
1	dp	288/400 (72%)	286 (99%)	2 (1%)	84	90
1	dq	289/400 (72%)	285 (99%)	4 (1%)	67	81
1	dr	290/400 (72%)	286 (99%)	4 (1%)	67	81
1	dy	290/400 (72%)	288 (99%)	2 (1%)	84	90
1	dz	290/400 (72%)	288 (99%)	2 (1%)	84	90
1	ea	290/400 (72%)	288 (99%)	2 (1%)	84	90
1	eb	290/400 (72%)	287 (99%)	3 (1%)	76	86
1	ec	290/400 (72%)	286 (99%)	4 (1%)	67	81
1	ed	289/400 (72%)	287 (99%)	2 (1%)	84	90
1	ee	290/400 (72%)	286 (99%)	4 (1%)	67	81
1	ef	290/400 (72%)	286 (99%)	4 (1%)	67	81
1	eg	290/400 (72%)	288 (99%)	2 (1%)	84	90
1	eh	289/400 (72%)	286 (99%)	3 (1%)	76	86
1	ei	290/400 (72%)	287 (99%)	3 (1%)	76	86
1	ej	290/400 (72%)	288 (99%)	2 (1%)	84	90
1	ek	290/400 (72%)	284 (98%)	6 (2%)	53	72
1	el	289/400 (72%)	286 (99%)	3 (1%)	76	86
1	em	290/400 (72%)	287 (99%)	3 (1%)	76	86
1	en	290/400 (72%)	287 (99%)	3 (1%)	76	86
1	eo	288/400 (72%)	285 (99%)	3 (1%)	76	86
1	ep	289/400 (72%)	287 (99%)	2 (1%)	84	90

Continued on next page...

Continued from previous page...

Mol	Chain	Analysed	Rotameric	Outliers	Percentiles	
1	eq	290/400 (72%)	287 (99%)	3 (1%)	76	86
1	er	290/400 (72%)	286 (99%)	4 (1%)	67	81
1	es	289/400 (72%)	286 (99%)	3 (1%)	76	86
1	et	289/400 (72%)	285 (99%)	4 (1%)	67	81
1	eu	290/400 (72%)	287 (99%)	3 (1%)	76	86
1	ev	289/400 (72%)	287 (99%)	2 (1%)	84	90
1	ew	290/400 (72%)	287 (99%)	3 (1%)	76	86
1	ex	288/400 (72%)	285 (99%)	3 (1%)	76	86
1	ey	290/400 (72%)	289 (100%)	1 (0%)	92	95
1	ez	290/400 (72%)	289 (100%)	1 (0%)	92	95
1	fa	290/400 (72%)	286 (99%)	4 (1%)	67	81
1	fb	291/400 (73%)	288 (99%)	3 (1%)	76	86
1	fc	288/400 (72%)	285 (99%)	3 (1%)	76	86
1	fd	288/400 (72%)	287 (100%)	1 (0%)	92	95
1	fe	289/400 (72%)	286 (99%)	3 (1%)	76	86
1	ff	289/400 (72%)	287 (99%)	2 (1%)	84	90
1	fg	289/400 (72%)	286 (99%)	3 (1%)	76	86
1	fh	290/400 (72%)	289 (100%)	1 (0%)	92	95
1	fi	291/400 (73%)	287 (99%)	4 (1%)	67	81
1	fj	288/400 (72%)	286 (99%)	2 (1%)	84	90
1	fk	290/400 (72%)	287 (99%)	3 (1%)	76	86
1	fl	288/400 (72%)	288 (100%)	0	100	100
1	fm	290/400 (72%)	284 (98%)	6 (2%)	53	72
1	fn	290/400 (72%)	287 (99%)	3 (1%)	76	86
1	fo	290/400 (72%)	289 (100%)	1 (0%)	92	95
1	fp	290/400 (72%)	288 (99%)	2 (1%)	84	90
1	fq	289/400 (72%)	285 (99%)	4 (1%)	67	81
1	fr	289/400 (72%)	286 (99%)	3 (1%)	76	86
1	fs	289/400 (72%)	285 (99%)	4 (1%)	67	81
1	ft	288/400 (72%)	285 (99%)	3 (1%)	76	86
1	fu	289/400 (72%)	286 (99%)	3 (1%)	76	86

Continued on next page...

Continued from previous page...

Mol	Chain	Analysed	Rotameric	Outliers	Percentiles	
1	fv	291/400 (73%)	287 (99%)	4 (1%)	67	81
1	fw	289/400 (72%)	283 (98%)	6 (2%)	53	72
1	fx	288/400 (72%)	283 (98%)	5 (2%)	60	78
1	fy	288/400 (72%)	285 (99%)	3 (1%)	76	86
1	fz	289/400 (72%)	285 (99%)	4 (1%)	67	81
1	ga	291/400 (73%)	287 (99%)	4 (1%)	67	81
1	gb	289/400 (72%)	285 (99%)	4 (1%)	67	81
1	gc	290/400 (72%)	286 (99%)	4 (1%)	67	81
1	gd	290/400 (72%)	287 (99%)	3 (1%)	76	86
1	ge	290/400 (72%)	286 (99%)	4 (1%)	67	81
1	gf	289/400 (72%)	284 (98%)	5 (2%)	60	78
1	gg	290/400 (72%)	287 (99%)	3 (1%)	76	86
1	gh	289/400 (72%)	285 (99%)	4 (1%)	67	81
1	gi	289/400 (72%)	287 (99%)	2 (1%)	84	90
1	gj	289/400 (72%)	287 (99%)	2 (1%)	84	90
1	gk	289/400 (72%)	287 (99%)	2 (1%)	84	90
1	gl	289/400 (72%)	286 (99%)	3 (1%)	76	86
1	gm	289/400 (72%)	286 (99%)	3 (1%)	76	86
1	gn	289/400 (72%)	284 (98%)	5 (2%)	60	78
1	go	289/400 (72%)	285 (99%)	4 (1%)	67	81
1	gp	289/400 (72%)	284 (98%)	5 (2%)	60	78
1	gq	289/400 (72%)	285 (99%)	4 (1%)	67	81
1	gr	290/400 (72%)	287 (99%)	3 (1%)	76	86
1	gs	289/400 (72%)	287 (99%)	2 (1%)	84	90
1	gt	289/400 (72%)	287 (99%)	2 (1%)	84	90
1	gu	289/400 (72%)	286 (99%)	3 (1%)	76	86
1	gv	289/400 (72%)	288 (100%)	1 (0%)	92	95
1	gw	289/400 (72%)	287 (99%)	2 (1%)	84	90
1	gx	289/400 (72%)	285 (99%)	4 (1%)	67	81
1	gy	289/400 (72%)	285 (99%)	4 (1%)	67	81
1	gz	288/400 (72%)	286 (99%)	2 (1%)	84	90

Continued on next page...

Continued from previous page...

Mol	Chain	Analysed	Rotameric	Outliers	Percentiles	
1	ha	289/400 (72%)	288 (100%)	1 (0%)	92	95
1	hb	288/400 (72%)	286 (99%)	2 (1%)	84	90
1	hc	289/400 (72%)	284 (98%)	5 (2%)	60	78
1	hd	290/400 (72%)	286 (99%)	4 (1%)	67	81
2	he	320/361 (89%)	315 (98%)	5 (2%)	62	79
2	hf	320/361 (89%)	317 (99%)	3 (1%)	78	87
2	hg	320/361 (89%)	316 (99%)	4 (1%)	69	82
2	hh	320/361 (89%)	315 (98%)	5 (2%)	62	79
2	hi	320/361 (89%)	314 (98%)	6 (2%)	57	75
2	hj	320/361 (89%)	317 (99%)	3 (1%)	78	87
2	hk	320/361 (89%)	317 (99%)	3 (1%)	78	87
2	hl	320/361 (89%)	316 (99%)	4 (1%)	69	82
2	hm	320/361 (89%)	316 (99%)	4 (1%)	69	82
2	hn	320/361 (89%)	316 (99%)	4 (1%)	69	82
2	ho	320/361 (89%)	314 (98%)	6 (2%)	57	75
All	All	55602/75971 (73%)	55006 (99%)	596 (1%)	74	85

5 of 596 residues with a non-rotameric sidechain are listed below:

Mol	Chain	Res	Type
1	gc	360	GLU
2	hj	102	LYS
1	gf	453	TYR
1	gc	279	ARG
1	gt	355	PHE

Sometimes sidechains can be flipped to improve hydrogen bonding and reduce clashes. 5 of 43 such sidechains are listed below:

Mol	Chain	Res	Type
1	fb	123	GLN
1	ga	123	GLN
1	ff	123	GLN
1	fr	123	GLN
1	ge	265	GLN

5.3.3 RNA [i](#)

There are no RNA molecules in this entry.

5.4 Non-standard residues in protein, DNA, RNA chains [i](#)

There are no non-standard protein/DNA/RNA residues in this entry.

5.5 Carbohydrates [i](#)

There are no monosaccharides in this entry.

5.6 Ligand geometry [i](#)

There are no ligands in this entry.

5.7 Other polymers [i](#)

There are no such residues in this entry.

5.8 Polymer linkage issues [i](#)

There are no chain breaks in this entry.

6 Map visualisation [i](#)

This section contains visualisations of the EMDB entry EMD-32103. These allow visual inspection of the internal detail of the map and identification of artifacts.

No raw map or half-maps were deposited for this entry and therefore no images, graphs, etc. pertaining to the raw map can be shown.

6.1 Orthogonal projections [i](#)

6.1.1 Primary map

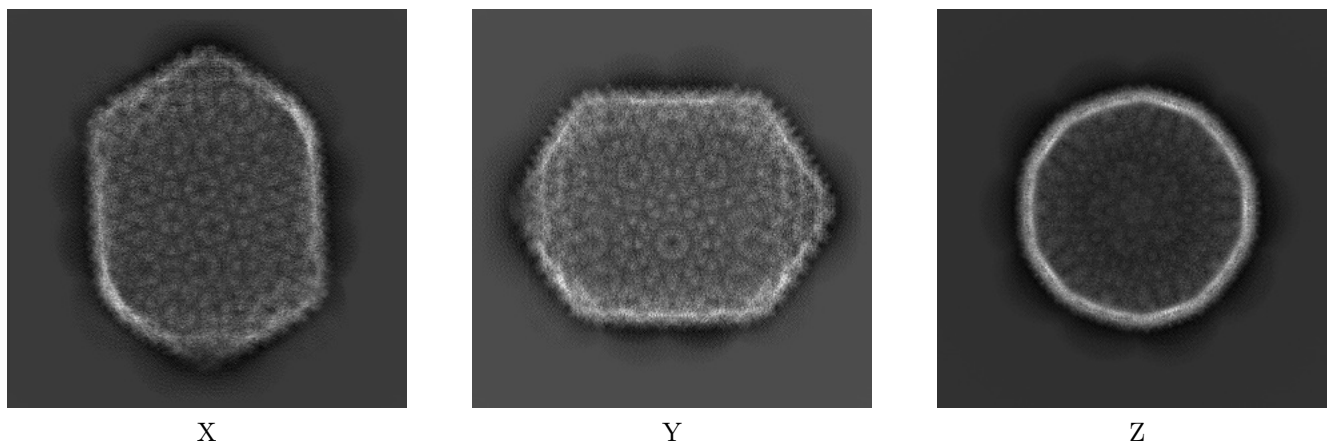

The images above show the map projected in three orthogonal directions.

6.2 Central slices [i](#)

6.2.1 Primary map

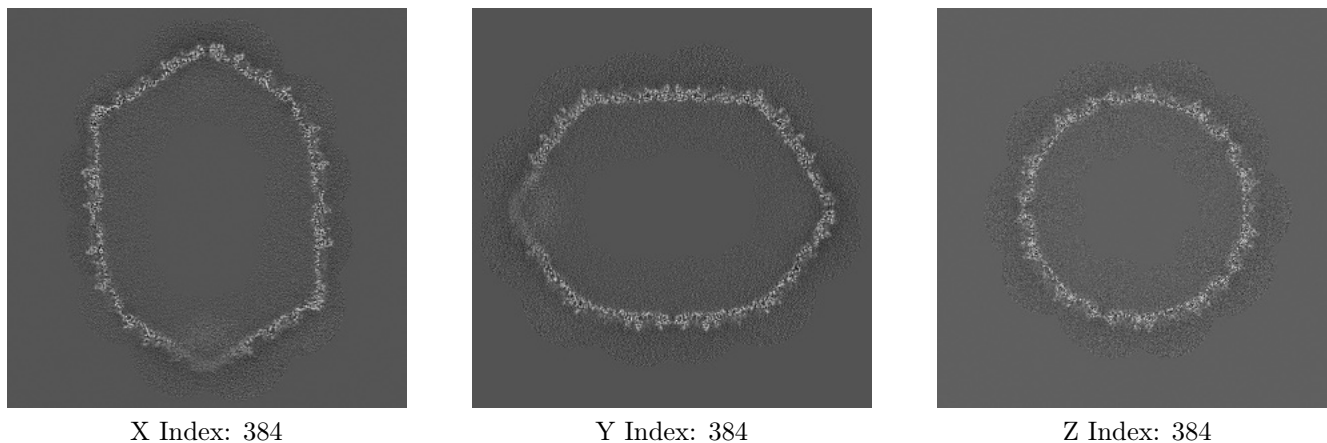

The images above show central slices of the map in three orthogonal directions.

6.3 Largest variance slices [i](#)

6.3.1 Primary map

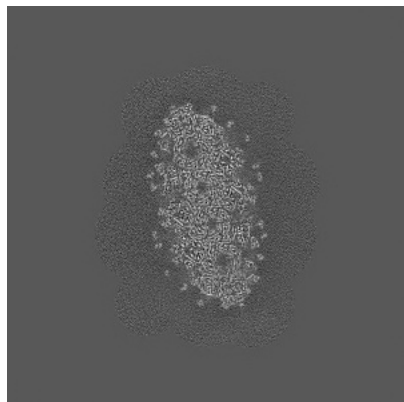

X Index: 592

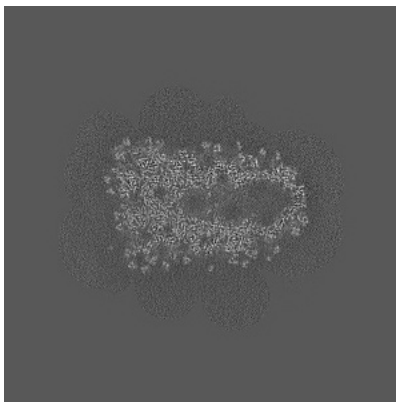

Y Index: 183

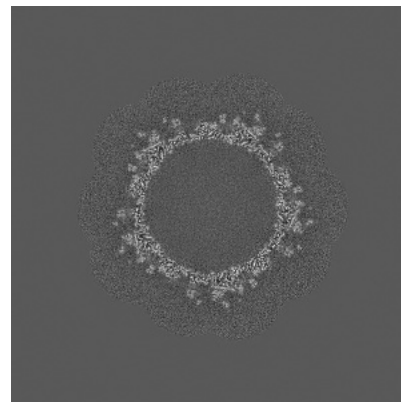

Z Index: 601

The images above show the largest variance slices of the map in three orthogonal directions.

6.4 Orthogonal surface views [i](#)

6.4.1 Primary map



X



Y



Z

The images above show the 3D surface view of the map at the recommended contour level 4.0. These images, in conjunction with the slice images, may facilitate assessment of whether an appropriate contour level has been provided.

6.5 Mask visualisation

This section was not generated. No masks/segmentation were deposited.

7 Map analysis [i](#)

This section contains the results of statistical analysis of the map.

7.1 Map-value distribution [i](#)

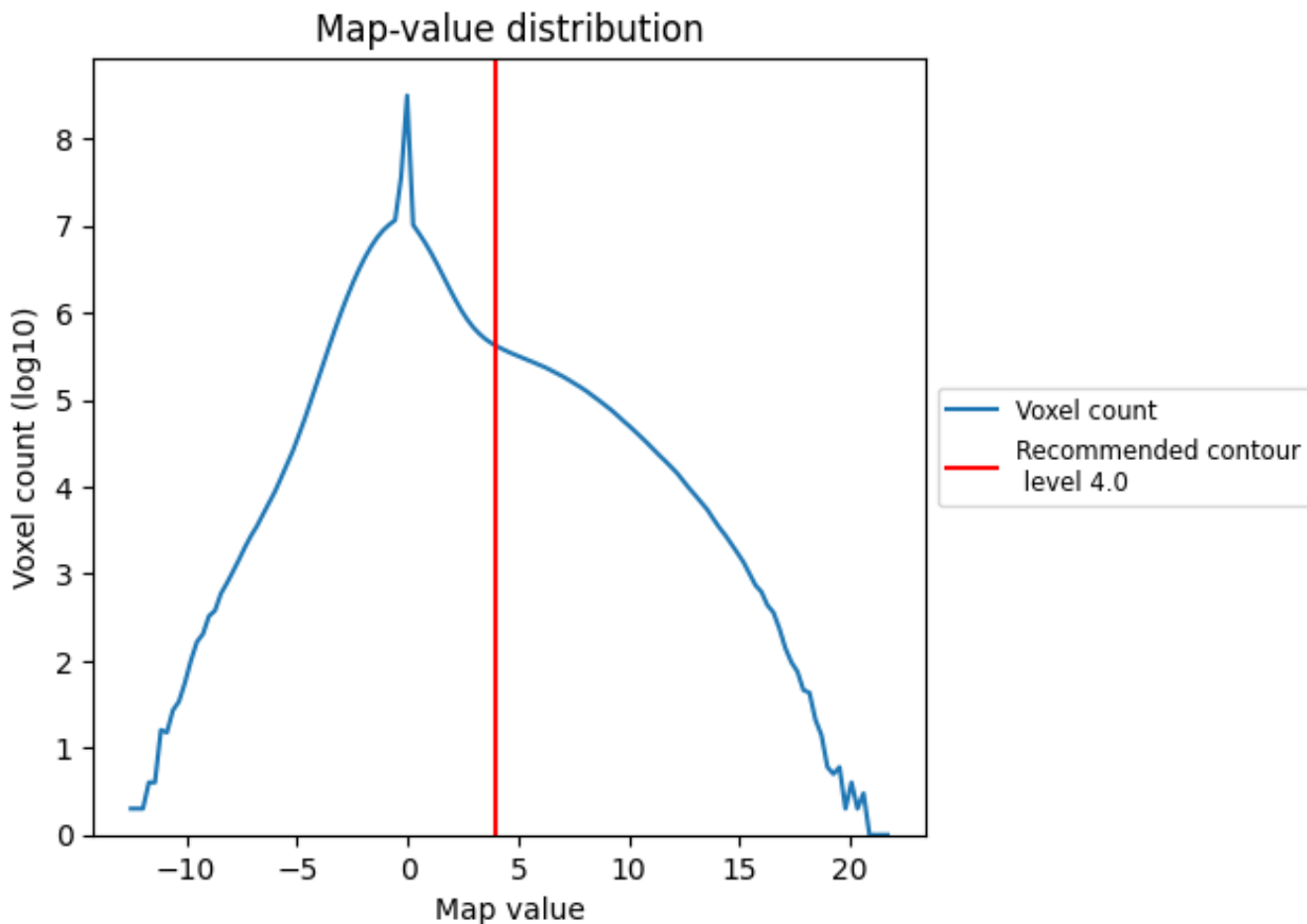

The map-value distribution is plotted in 128 intervals along the x-axis. The y-axis is logarithmic. A spike in this graph at zero usually indicates that the volume has been masked.

7.2 Volume estimate [\(i\)](#)

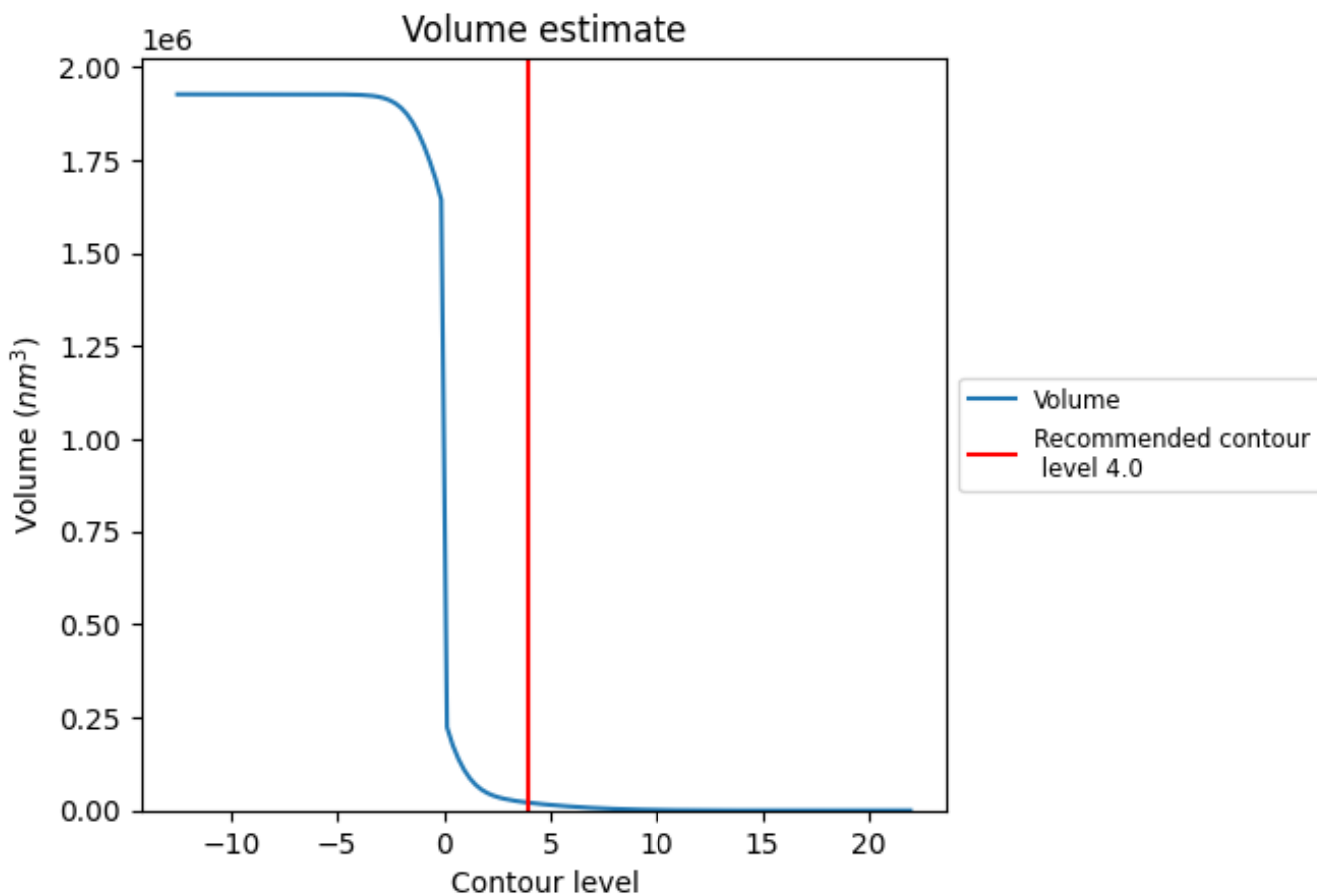

The volume at the recommended contour level is 20765 nm³; this corresponds to an approximate mass of 18758 kDa.

The volume estimate graph shows how the enclosed volume varies with the contour level. The recommended contour level is shown as a vertical line and the intersection between the line and the curve gives the volume of the enclosed surface at the given level.

7.3 Rotationally averaged power spectrum [i](#)

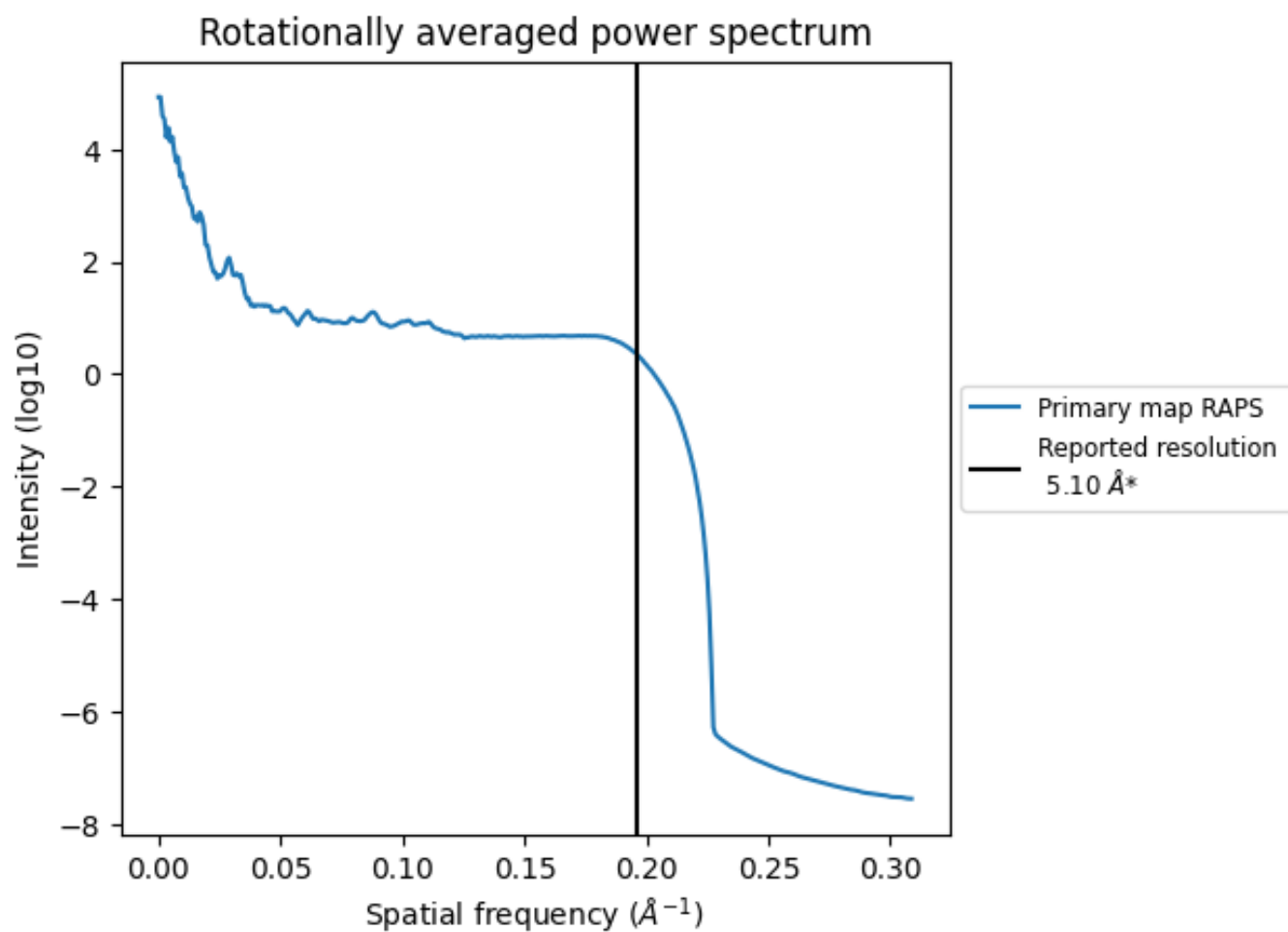

*Reported resolution corresponds to spatial frequency of 0.196 Å⁻¹

8 Fourier-Shell correlation

This section was not generated. No FSC curve or half-maps provided.

9 Map-model fit [i](#)

This section contains information regarding the fit between EMDB map EMD-32103 and PDB model 7VRT. Per-residue inclusion information can be found in section 3 on page 21.

9.1 Map-model overlays

9.1.1 Map-model overlay [i](#)

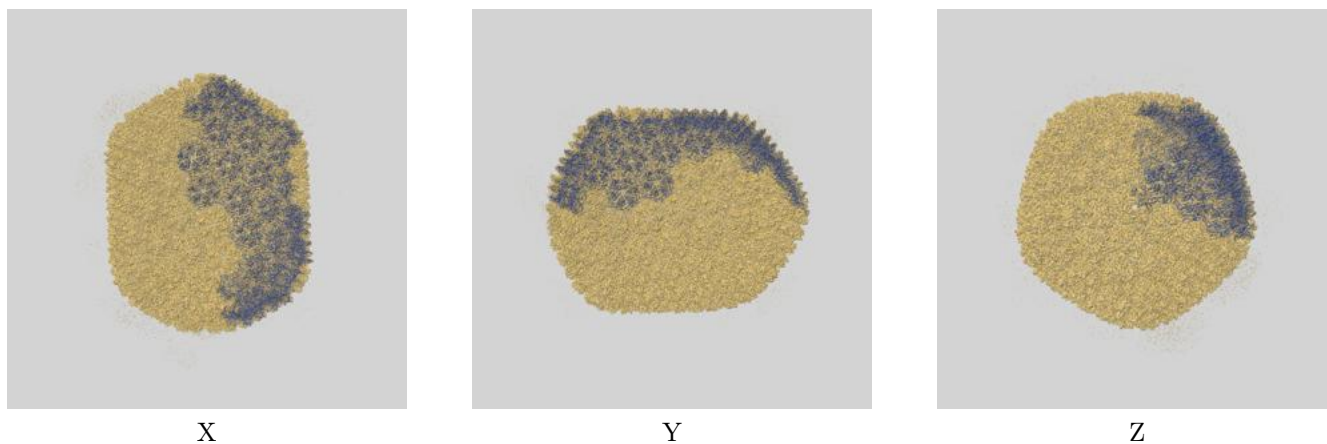

9.1.2 Map-model assembly overlay [i](#)

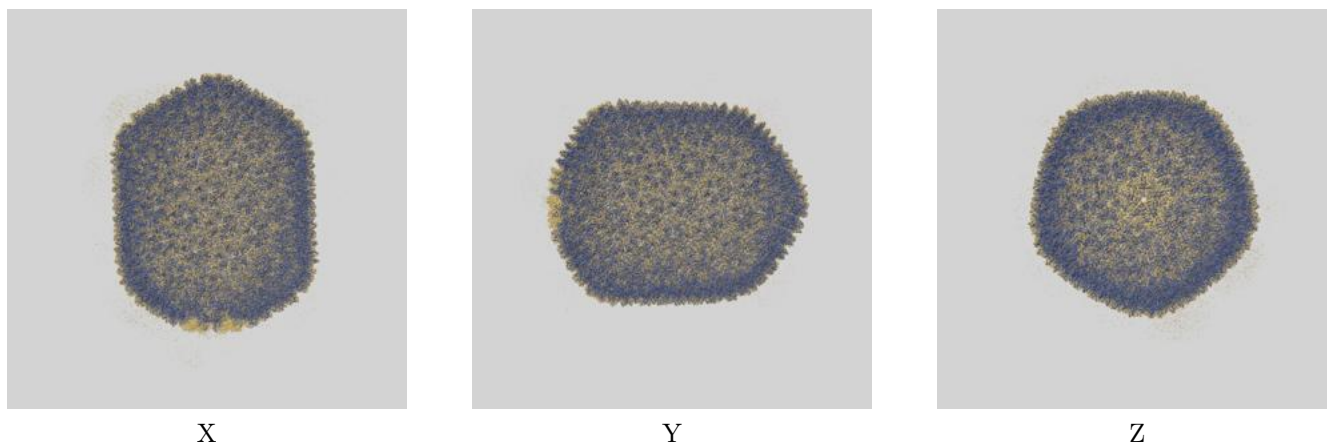

The images above show the 3D surface view of the map at the recommended contour level 4.0 at 50% transparency in yellow overlaid with a ribbon representation of the model coloured in blue. These images allow for the visual assessment of the quality of fit between the atomic model and the map.

9.2 Q-score mapped to coordinate model [i](#)

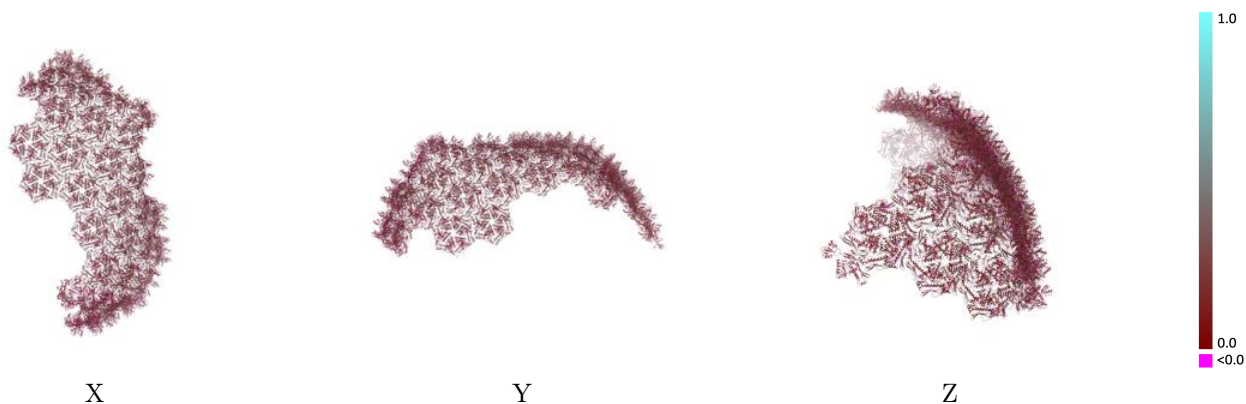

The images above show the model with each residue coloured according to its Q-score. This shows their resolvability in the map with higher Q-score values reflecting better resolvability. Please note: Q-score is calculating the resolvability of atoms, and thus high values are only expected at resolutions at which atoms can be resolved. Low Q-score values may therefore be expected for many entries.

9.3 Atom inclusion mapped to coordinate model [i](#)

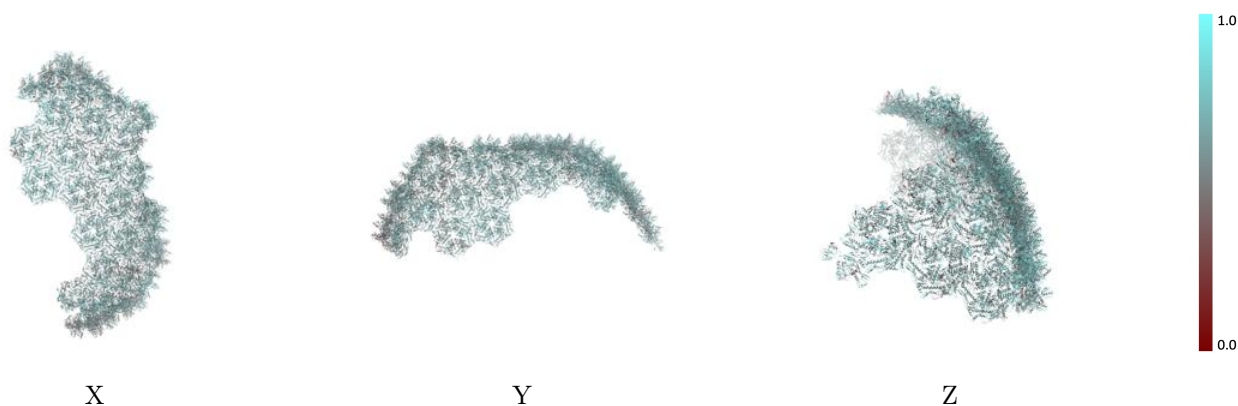

The images above show the model with each residue coloured according to its atom inclusion. This shows to what extent they are inside the map at the recommended contour level (4.0).

9.4 Atom inclusion [i](#)

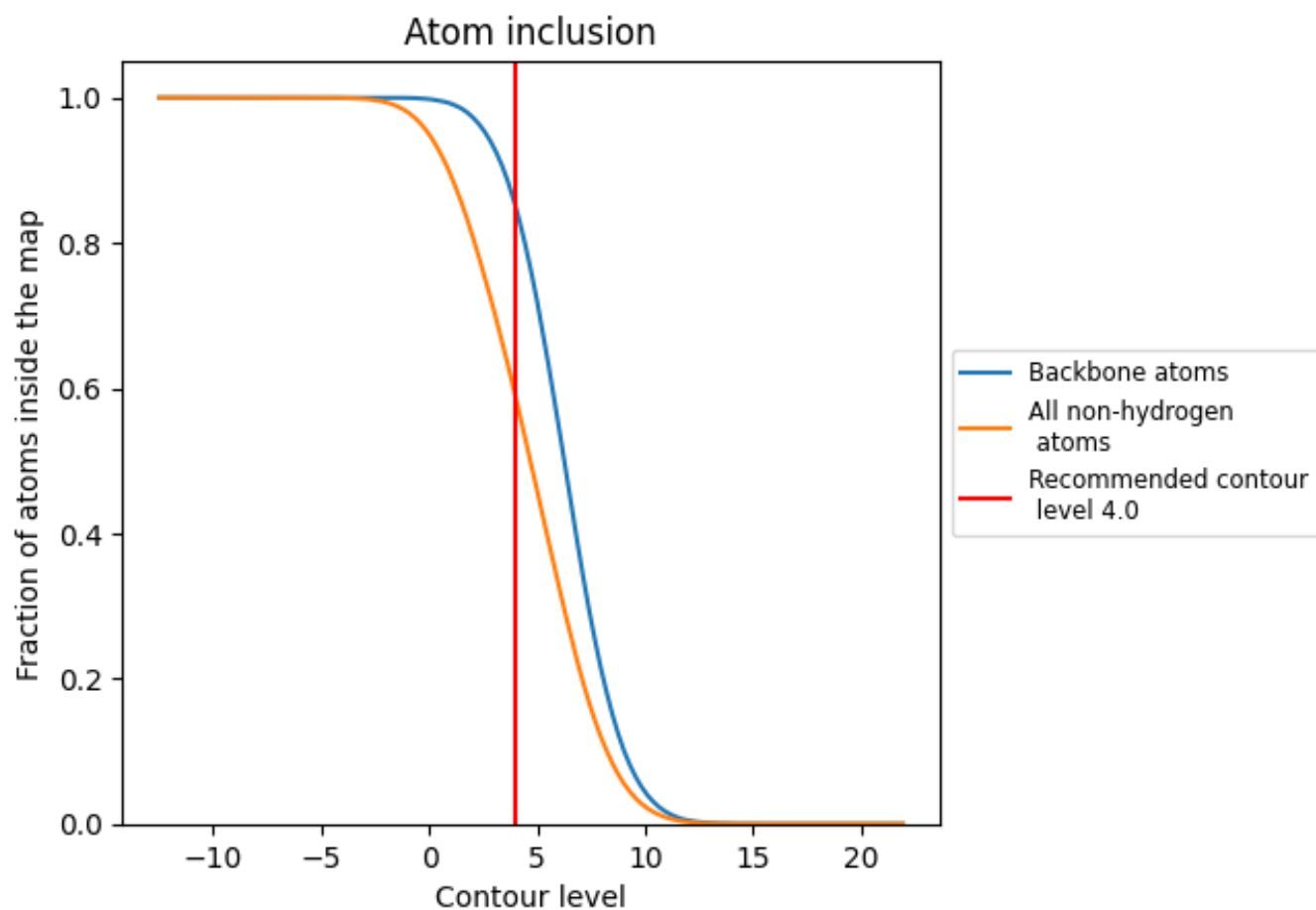

At the recommended contour level, 85% of all backbone atoms, 59% of all non-hydrogen atoms, are inside the map.

9.5 Map-model fit summary





















































































The table lists the average atom inclusion at the recommended contour level (4.0) and Q-score for the entire model and for each chain.

Chain	Atom inclusion	Q-score
All	0.5892	0.2020
aa	0.5845	0.1910
ab	0.5492	0.1820
ac	0.5794	0.2000
ad	0.5798	0.1890
ae	0.5607	0.1870
af	0.6012	0.1950
ag	0.5838	0.1950
ah	0.5730	0.2050
ai	0.5798	0.2140
aj	0.5733	0.2090
ak	0.5467	0.1940
al	0.5505	0.1960
am	0.6021	0.2060
an	0.5891	0.2010
ao	0.6139	0.2140
ap	0.6262	0.2040
aq	0.5938	0.1950
ar	0.5554	0.1850
as	0.6341	0.2130
at	0.6215	0.2080
au	0.6039	0.2100
av	0.6280	0.2200
aw	0.6193	0.2150
ax	0.6359	0.2240
ay	0.5507	0.2090
az	0.5651	0.2100
ba	0.6092	0.2060
bb	0.6132	0.2110
bc	0.5909	0.2040
bd	0.5638	0.2020
be	0.5899	0.1890
bf	0.6454	0.2150
bg	0.6391	0.2030
bh	0.6208	0.1960























































































Continued on next page...

Continued from previous page...

Chain	Atom inclusion	Q-score
bi	 0.6157	 0.2030
bj	 0.6061	 0.2000
bk	 0.6175	 0.2210
bl	 0.5762	 0.2070
bm	 0.5393	 0.1960
bn	 0.5851	 0.2080
bo	 0.6042	 0.2040
bp	 0.6201	 0.2090
bq	 0.6237	 0.2090
br	 0.6266	 0.2190
bs	 0.5969	 0.2170
bt	 0.5925	 0.2090
bu	 0.5935	 0.2090
bv	 0.6150	 0.2160
bw	 0.6326	 0.2070
bx	 0.6262	 0.2090
by	 0.6219	 0.2070
bz	 0.6388	 0.2070
ca	 0.6637	 0.2090
cb	 0.6480	 0.2080
cc	 0.6009	 0.2040
cd	 0.5989	 0.2030
ce	 0.6449	 0.2150
cf	 0.5871	 0.1970
cg	 0.5593	 0.1930
ch	 0.5991	 0.2070
ci	 0.5731	 0.2190
cj	 0.5789	 0.2210
ck	 0.6139	 0.2130
cl	 0.6423	 0.2170
cm	 0.6247	 0.2120
cn	 0.6114	 0.2180
co	 0.5927	 0.2240
cp	 0.6175	 0.2120
cq	 0.6175	 0.2110
cr	 0.6020	 0.2160
cs	 0.5782	 0.2140
ct	 0.5779	 0.2140
cu	 0.6078	 0.2000
cv	 0.6078	 0.2140
cw	 0.6197	 0.2140
cx	 0.6089	 0.2190





















































































Continued on next page...

Continued from previous page...

Chain	Atom inclusion	Q-score
cy	 0.6064	 0.2120
 0.6222	 0.2090	
da	 0.6067	 0.2200
db	 0.6265	 0.2070
dc	 0.6186	 0.2160
dd	 0.6081	 0.2110
de	 0.5919	 0.2040
df	 0.6175	 0.2190
dg	 0.5887	 0.2140
dh	 0.5847	 0.2190
di	 0.5804	 0.2200
dj	 0.5671	 0.2120
dk	 0.6114	 0.2160
dl	 0.6071	 0.2180
dm	 0.6565	 0.2210
dn	 0.6439	 0.2240
do	 0.6417	 0.2160
dp	 0.6280	 0.2150
dq	 0.6539	 0.2160
dr	 0.6585	 0.2150
dy	 0.4479	 0.1560
dz	 0.4756	 0.1700
ea	 0.5155	 0.1890
eb	 0.5205	 0.1870
ec	 0.4917	 0.1730
ed	 0.4146	 0.1560
ee	 0.5514	 0.1790
ef	 0.5410	 0.1700
eg	 0.5302	 0.1680
eh	 0.5699	 0.1780
ei	 0.5597	 0.1740
ej	 0.5072	 0.1710
ek	 0.5877	 0.2030
el	 0.5689	 0.1950
em	 0.5478	 0.1950
en	 0.5690	 0.1970
eo	 0.5705	 0.1910
ep	 0.5584	 0.1880
eq	 0.5079	 0.1750
er	 0.5266	 0.1730
es	 0.5739	 0.1810
et	 0.5681	 0.1850































































Continued on next page...

Continued from previous page...

Chain	Atom inclusion	Q-score
eu	 0.5489	 0.1790
ev	 0.5126	 0.1640
ew	 0.5331	 0.1630
ex	 0.5828	 0.1850
ey	 0.5974	 0.1820
ez	 0.5827	 0.1850
fa	 0.5935	 0.1870
fb	 0.5627	 0.1750
fc	 0.5686	 0.2020
fd	 0.5610	 0.2020
fe	 0.5667	 0.1870
ff	 0.5930	 0.2060
fg	 0.5433	 0.1980
fh	 0.5582	 0.1870
fi	 0.5835	 0.2020
fj	 0.5712	 0.2060
fk	 0.5521	 0.2090
fl	 0.5089	 0.2120
fm	 0.5090	 0.1970
fn	 0.5615	 0.2040
fo	 0.6014	 0.1890
fp	 0.5931	 0.2000
fq	 0.5912	 0.1970
fr	 0.5725	 0.1910
fs	 0.6027	 0.1960
ft	 0.6092	 0.1920
fu	 0.5620	 0.1920
fv	 0.5767	 0.1940
fw	 0.6229	 0.1960
fx	 0.5723	 0.1730
fy	 0.4993	 0.1580
fz	 0.5249	 0.1820
ga	 0.5706	 0.2120
gb	 0.5844	 0.2090
gc	 0.6089	 0.2200
gd	 0.6312	 0.2170
ge	 0.6179	 0.2030
gf	 0.5851	 0.2010
gg	 0.6143	 0.2230
gh	 0.6276	 0.2140
gi	 0.6251	 0.2150
gj	 0.6110	 0.2150

Continued on next page...

Continued from previous page...

Chain	Atom inclusion	Q-score
gk	 0.6027	 0.2190
gl	 0.6157	 0.2190
gm	 0.6168	 0.2070
gn	 0.6182	 0.2130
go	 0.6291	 0.2190
gp	 0.6013	 0.2100
gq	 0.6114	 0.2240
gr	 0.6370	 0.2190
gs	 0.5793	 0.2130
gt	 0.5991	 0.2150
gu	 0.5789	 0.2090
gv	 0.5793	 0.2140
gw	 0.5898	 0.2110
gx	 0.5865	 0.2080
gy	 0.6345	 0.2140
gz	 0.6208	 0.2160
ha	 0.6204	 0.2220
hb	 0.6012	 0.2080
hc	 0.6186	 0.2100
hd	 0.6495	 0.2120
he	 0.6437	 0.2010
hf	 0.6162	 0.2120
hg	 0.6034	 0.2060
hh	 0.6172	 0.2090
hi	 0.6148	 0.2010
hj	 0.5625	 0.1860
hk	 0.5415	 0.1800
hl	 0.5466	 0.1780
hm	 0.5676	 0.1790
hn	 0.5597	 0.1730
ho	 0.5766	 0.1950