



wwPDB X-ray Structure Validation Summary Report ⓘ

Jun 11, 2024 – 05:47 PM EDT

PDB ID : 1VH0
Title : Crystal structure of a hypothetical protein
Authors : Structural GenomiX
Deposited on : 2003-11-03
Resolution : 2.31 Å(reported)

This is a wwPDB X-ray Structure Validation Summary Report for a publicly released PDB entry.

We welcome your comments at validation@mail.wwpdb.org

A user guide is available at

<https://www.wwpdb.org/validation/2017/XrayValidationReportHelp>

with specific help available everywhere you see the ⓘ symbol.

The types of validation reports are described at

<http://www.wwpdb.org/validation/2017/FAQs#types>.

The following versions of software and data (see [references ⓘ](#)) were used in the production of this report:

MolProbity : 4.02b-467
Xtriage (Phenix) : 1.20.1
EDS : 2.36.2
Percentile statistics : 20191225.v01 (using entries in the PDB archive December 25th 2019)
Refmac : 5.8.0158
CCP4 : 7.0.044 (Gargrove)
Ideal geometry (proteins) : Engh & Huber (2001)
Ideal geometry (DNA, RNA) : Parkinson et al. (1996)
Validation Pipeline (wwPDB-VP) : 2.36.2

1 Overall quality at a glance i

The following experimental techniques were used to determine the structure:

X-RAY DIFFRACTION

The reported resolution of this entry is 2.31 Å.

Percentile scores (ranging between 0-100) for global validation metrics of the entry are shown in the following graphic. The table shows the number of entries on which the scores are based.

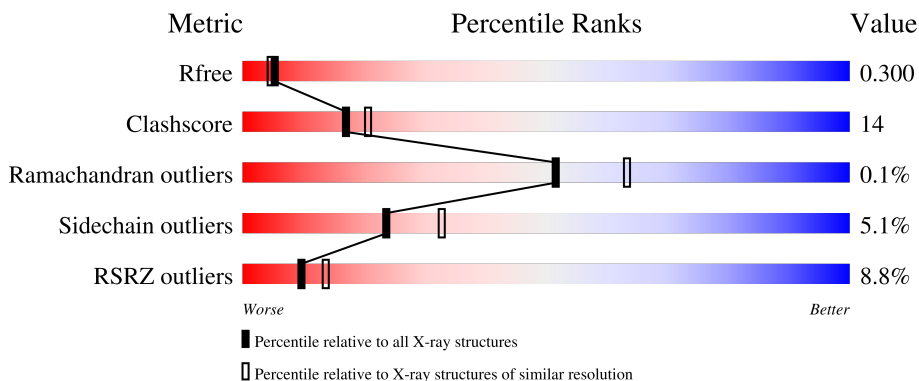

Metric	Whole archive (#Entries)	Similar resolution (#Entries, resolution range(Å))
R_{free}	130704	5974 (2.34-2.30)
Clashscore	141614	6604 (2.34-2.30)
Ramachandran outliers	138981	6523 (2.34-2.30)
Sidechain outliers	138945	6523 (2.34-2.30)
RSRZ outliers	127900	5855 (2.34-2.30)

The table below summarises the geometric issues observed across the polymeric chains and their fit to the electron density. The red, orange, yellow and green segments of the lower bar indicate the fraction of residues that contain outliers for ≥ 3 , 2, 1 and 0 types of geometric quality criteria respectively. A grey segment represents the fraction of residues that are not modelled. The numeric value for each fraction is indicated below the corresponding segment, with a dot representing fractions $\leq 5\%$. The upper red bar (where present) indicates the fraction of residues that have poor fit to the electron density. The numeric value is given above the bar.

Mol	Chain	Length	Quality of chain
1	A	161	
1	B	161	
1	C	161	
1	D	161	
1	E	161	

Continued on next page...

Continued from previous page...

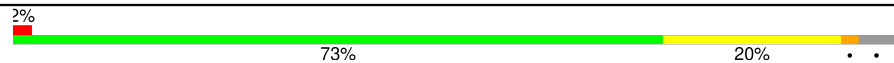
Mol	Chain	Length	Quality of chain
1	F	161	 A horizontal bar chart showing the quality of chain. The bar is divided into segments: a small red segment at the beginning labeled '2%', a large green segment labeled '73%', a yellow segment labeled '20%', and a small grey segment at the end. Two dots are visible at the far right end of the bar.

2 Entry composition

There are 2 unique types of molecules in this entry. The entry contains 7758 atoms, of which 0 are hydrogens and 0 are deuteriums.

In the tables below, the ZeroOcc column contains the number of atoms modelled with zero occupancy, the AltConf column contains the number of residues with at least one atom in alternate conformation and the Trace column contains the number of residues modelled with at most 2 atoms.

- Molecule 1 is a protein called Hypothetical UPF0247 protein SAV0024/SA0023.

Mol	Chain	Residues	Atoms					ZeroOcc	AltConf	Trace
			Total	C	N	O	S			
1	A	157	1260	804	215	234	7	0	0	0
1	B	157	1260	804	215	234	7	0	0	0
1	C	157	1258	804	215	232	7	0	0	0
1	D	148	1187	761	204	216	6	0	0	0
1	E	157	1248	797	214	230	7	0	0	0
1	F	154	1224	784	209	225	6	0	0	0

There are 18 discrepancies between the modelled and reference sequences:

Chain	Residue	Modelled	Actual	Comment	Reference
A	-1	MET	-	cloning artifact	UNP P0A0N8
A	0	SER	-	cloning artifact	UNP P0A0N8
A	1	LEU	-	cloning artifact	UNP P0A0N8
B	-1	MET	-	cloning artifact	UNP P0A0N8
B	0	SER	-	cloning artifact	UNP P0A0N8
B	1	LEU	-	cloning artifact	UNP P0A0N8
C	-1	MET	-	cloning artifact	UNP P0A0N8
C	0	SER	-	cloning artifact	UNP P0A0N8
C	1	LEU	-	cloning artifact	UNP P0A0N8
D	-1	MET	-	cloning artifact	UNP P0A0N8
D	0	SER	-	cloning artifact	UNP P0A0N8
D	1	LEU	-	cloning artifact	UNP P0A0N8
E	-1	MET	-	cloning artifact	UNP P0A0N8
E	0	SER	-	cloning artifact	UNP P0A0N8
E	1	LEU	-	cloning artifact	UNP P0A0N8
F	-1	MET	-	cloning artifact	UNP P0A0N8
F	0	SER	-	cloning artifact	UNP P0A0N8

Continued on next page...

Continued from previous page...

Chain	Residue	Modelled	Actual	Comment	Reference
F	1	LEU	-	cloning artifact	UNP P0A0N8

- Molecule 2 is water.

Mol	Chain	Residues	Atoms	ZeroOcc	AltConf
2	A	76	Total O 76 76	0	0
2	B	43	Total O 43 43	0	0
2	C	45	Total O 45 45	0	0
2	D	47	Total O 47 47	0	0
2	E	49	Total O 49 49	0	0
2	F	61	Total O 61 61	0	0

3 Residue-property plots [i](#)

These plots are drawn for all protein, RNA, DNA and oligosaccharide chains in the entry. The first graphic for a chain summarises the proportions of the various outlier classes displayed in the second graphic. The second graphic shows the sequence view annotated by issues in geometry and electron density. Residues are color-coded according to the number of geometric quality criteria for which they contain at least one outlier: green = 0, yellow = 1, orange = 2 and red = 3 or more. A red dot above a residue indicates a poor fit to the electron density ($RSRZ > 2$). Stretches of 2 or more consecutive residues without any outlier are shown as a green connector. Residues present in the sample, but not in the model, are shown in grey.

- Molecule 1: Hypothetical UPF0247 protein SAV0024/SA0023

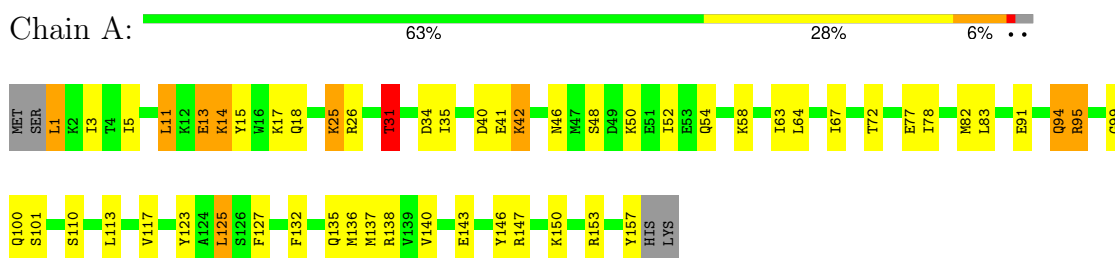

- Molecule 1: Hypothetical UPF0247 protein SAV0024/SA0023

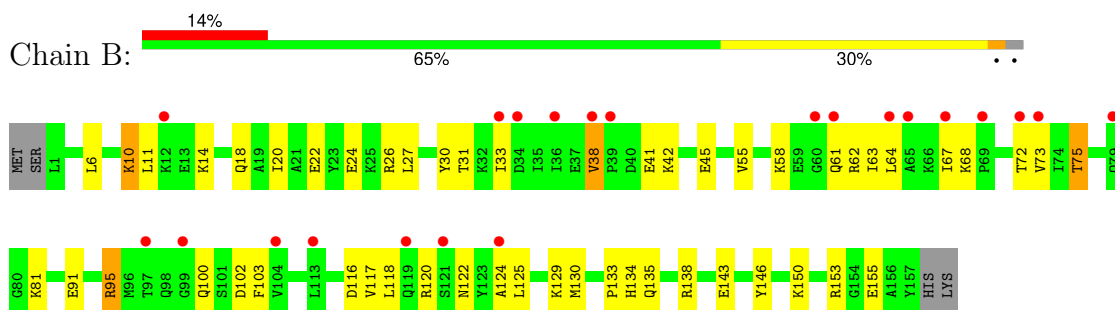

- Molecule 1: Hypothetical UPF0247 protein SAV0024/SA0023



- Molecule 1: Hypothetical UPF0247 protein SAV0024/SA0023



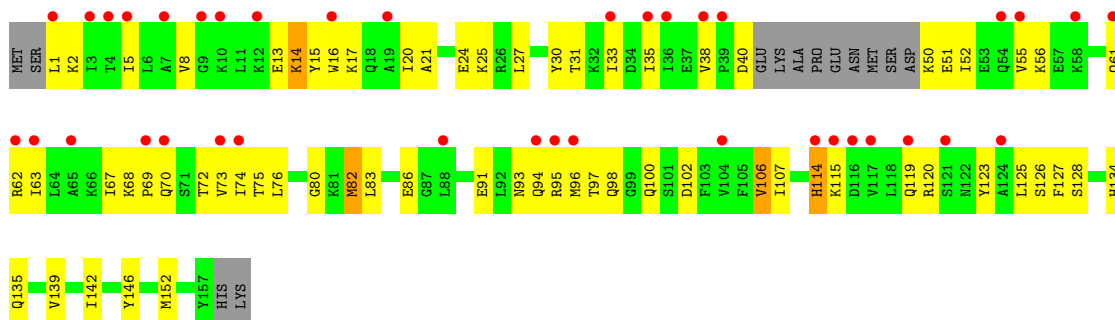

● Molecule 1: Hypothetical UPF0247 protein SAV0024/SA0023

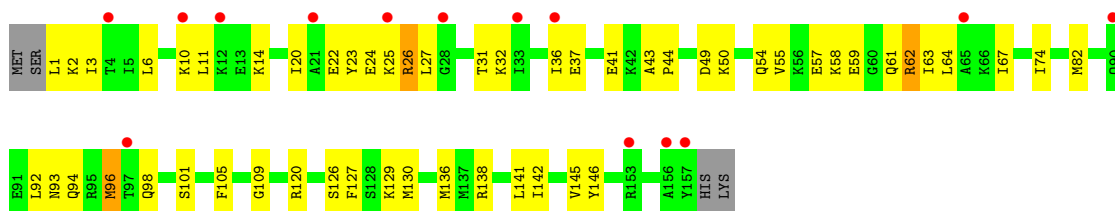

● Molecule 1: Hypothetical UPF0247 protein SAV0024/SA0023

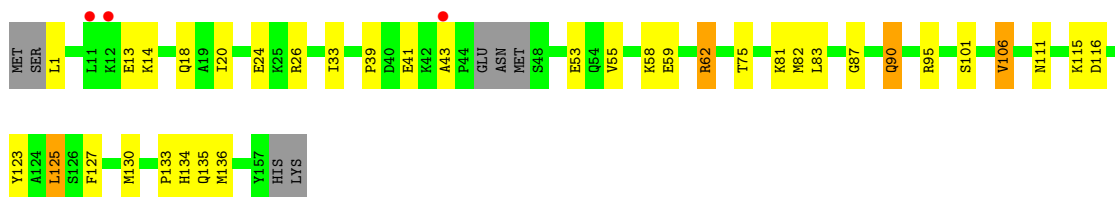
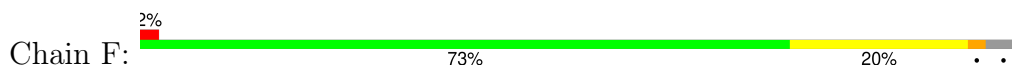

4 Data and refinement statistics i

Property	Value	Source
Space group	P 1	Depositor
Cell constants a, b, c, α , β , γ	48.53Å 74.50Å 81.53Å 91.06° 107.14° 90.14°	Depositor
Resolution (Å)	19.92 – 2.31 19.94 – 2.31	Depositor EDS
% Data completeness (in resolution range)	(Not available) (19.92-2.31) 96.9 (19.94-2.31)	Depositor EDS
R_{merge}	0.05	Depositor
R_{sym}	(Not available)	Depositor
$\langle I/\sigma(I) \rangle$ ¹	8.52 (at 2.30Å)	Xtriage
Refinement program	REFMAC 4.0	Depositor
R, R_{free}	0.260 , 0.318 0.246 , 0.300	Depositor DCC
R_{free} test set	2359 reflections (5.05%)	wwPDB-VP
Wilson B-factor (Å ²)	30.2	Xtriage
Anisotropy	0.554	Xtriage
Bulk solvent k_{sol} (e/Å ³), B_{sol} (Å ²)	0.33 , 45.3	EDS
L-test for twinning ²	$\langle L \rangle = 0.50$, $\langle L^2 \rangle = 0.34$	Xtriage
Estimated twinning fraction	0.269 for h,-k,-h-l 0.012 for -h,k,-l 0.006 for -h,-k,h+l	Xtriage
F_o, F_c correlation	0.92	EDS
Total number of atoms	7758	wwPDB-VP
Average B, all atoms (Å ²)	48.0	wwPDB-VP

Xtriage's analysis on translational NCS is as follows: *The largest off-origin peak in the Patterson function is 6.62% of the height of the origin peak. No significant pseudotranslation is detected.*

¹Intensities estimated from amplitudes.

²Theoretical values of $\langle |L| \rangle$, $\langle L^2 \rangle$ for acentric reflections are 0.5, 0.333 respectively for untwinned datasets, and 0.375, 0.2 for perfectly twinned datasets.

5 Model quality [i](#)

5.1 Standard geometry [i](#)

The Z score for a bond length (or angle) is the number of standard deviations the observed value is removed from the expected value. A bond length (or angle) with $|Z| > 5$ is considered an outlier worth inspection. RMSZ is the root-mean-square of all Z scores of the bond lengths (or angles).

Mol	Chain	Bond lengths		Bond angles	
		RMSZ	# Z >5	RMSZ	# Z >5
1	A	0.92	0/1279	1.33	7/1714 (0.4%)
1	B	0.90	0/1279	1.43	10/1714 (0.6%)
1	C	0.86	0/1277	1.25	2/1711 (0.1%)
1	D	0.85	0/1204	1.21	1/1612 (0.1%)
1	E	0.84	0/1267	1.26	5/1699 (0.3%)
1	F	0.86	0/1242	1.27	8/1665 (0.5%)
All	All	0.87	0/7548	1.30	33/10115 (0.3%)

Chiral center outliers are detected by calculating the chiral volume of a chiral center and verifying if the center is modelled as a planar moiety or with the opposite hand. A planarity outlier is detected by checking planarity of atoms in a peptide group, atoms in a mainchain group or atoms of a sidechain that are expected to be planar.

Mol	Chain	#Chirality outliers	#Planarity outliers
1	A	0	4
1	B	0	1
1	C	0	2
1	D	0	3
1	E	0	2
All	All	0	12

There are no bond length outliers.

The worst 5 of 33 bond angle outliers are listed below:

Mol	Chain	Res	Type	Atoms	Z	Observed(°)	Ideal(°)
1	E	96	MET	CA-CB-CG	11.89	133.51	113.30
1	B	153	ARG	CD-NE-CZ	11.59	139.83	123.60
1	A	95	ARG	NE-CZ-NH1	-10.03	115.28	120.30
1	B	95	ARG	NE-CZ-NH1	-9.85	115.38	120.30
1	F	95	ARG	NE-CZ-NH2	-8.28	116.16	120.30

There are no chirality outliers.

5 of 12 planarity outliers are listed below:

Mol	Chain	Res	Type	Group
1	A	132	PHE	Mainchain
1	A	146	TYR	Mainchain
1	A	64	LEU	Mainchain
1	A	94	GLN	Mainchain
1	B	102	ASP	Mainchain

5.2 Too-close contacts [\(i\)](#)

In the following table, the Non-H and H(model) columns list the number of non-hydrogen atoms and hydrogen atoms in the chain respectively. The H(added) column lists the number of hydrogen atoms added and optimized by MolProbity. The Clashes column lists the number of clashes within the asymmetric unit, whereas Symm-Clashes lists symmetry-related clashes.

Mol	Chain	Non-H	H(model)	H(added)	Clashes	Symm-Clashes
1	A	1260	0	1303	32	0
1	B	1260	0	1303	44	0
1	C	1258	0	1303	50	0
1	D	1187	0	1229	44	0
1	E	1248	0	1281	38	0
1	F	1224	0	1262	18	0
2	A	76	0	0	4	0
2	B	43	0	0	4	0
2	C	45	0	0	3	0
2	D	47	0	0	7	0
2	E	49	0	0	2	0
2	F	61	0	0	0	0
All	All	7758	0	7681	212	0

The all-atom clashscore is defined as the number of clashes found per 1000 atoms (including hydrogen atoms). The all-atom clashscore for this structure is 14.

The worst 5 of 212 close contacts within the same asymmetric unit are listed below, sorted by their clash magnitude.

Atom-1	Atom-2	Interatomic distance (Å)	Clash overlap (Å)
1:A:3:ILE:HG12	1:A:31:THR:HG21	1.54	0.86
1:B:91:GLU:OE2	1:B:95:ARG:NH1	2.09	0.84
1:C:3:ILE:HG12	1:C:31:THR:HG21	1.59	0.84
1:C:104:VAL:HG22	2:C:183:HOH:O	1.76	0.84
1:B:146:TYR:CZ	1:B:150:LYS:HD2	2.15	0.82

There are no symmetry-related clashes.

5.3 Torsion angles [i](#)

5.3.1 Protein backbone [i](#)

In the following table, the Percentiles column shows the percent Ramachandran outliers of the chain as a percentile score with respect to all X-ray entries followed by that with respect to entries of similar resolution.

The Analysed column shows the number of residues for which the backbone conformation was analysed, and the total number of residues.

Mol	Chain	Analysed	Favoured	Allowed	Outliers	Percentiles	
1	A	155/161 (96%)	153 (99%)	2 (1%)	0	100	100
1	B	155/161 (96%)	148 (96%)	7 (4%)	0	100	100
1	C	155/161 (96%)	149 (96%)	6 (4%)	0	100	100
1	D	144/161 (89%)	137 (95%)	6 (4%)	1 (1%)	22	26
1	E	155/161 (96%)	150 (97%)	5 (3%)	0	100	100
1	F	150/161 (93%)	148 (99%)	2 (1%)	0	100	100
All	All	914/966 (95%)	885 (97%)	28 (3%)	1 (0%)	51	63

All (1) Ramachandran outliers are listed below:

Mol	Chain	Res	Type
1	D	80	GLY

5.3.2 Protein sidechains [i](#)

In the following table, the Percentiles column shows the percent sidechain outliers of the chain as a percentile score with respect to all X-ray entries followed by that with respect to entries of similar resolution.

The Analysed column shows the number of residues for which the sidechain conformation was analysed, and the total number of residues.

Mol	Chain	Analysed	Rotameric	Outliers	Percentiles	
1	A	137/142 (96%)	125 (91%)	12 (9%)	10	11
1	B	137/142 (96%)	132 (96%)	5 (4%)	35	48
1	C	136/142 (96%)	129 (95%)	7 (5%)	24	33

Continued on next page...

Continued from previous page...

Mol	Chain	Analysed	Rotameric	Outliers	Percentiles	
1	D	127/142 (89%)	118 (93%)	9 (7%)	14	19
1	E	133/142 (94%)	130 (98%)	3 (2%)	50	66
1	F	131/142 (92%)	126 (96%)	5 (4%)	33	46
All	All	801/852 (94%)	760 (95%)	41 (5%)	24	33

5 of 41 residues with a non-rotameric sidechain are listed below:

Mol	Chain	Res	Type
1	D	61	GLN
1	E	98	GLN
1	D	70	GLN
1	D	125	LEU
1	F	53	GLU

Sometimes sidechains can be flipped to improve hydrogen bonding and reduce clashes. 5 of 14 such sidechains are listed below:

Mol	Chain	Res	Type
1	D	98	GLN
1	E	79	GLN
1	F	119	GLN
1	F	90	GLN
1	F	111	ASN

5.3.3 RNA [i](#)

There are no RNA molecules in this entry.

5.4 Non-standard residues in protein, DNA, RNA chains [i](#)

There are no non-standard protein/DNA/RNA residues in this entry.

5.5 Carbohydrates [i](#)

There are no monosaccharides in this entry.

5.6 Ligand geometry [i](#)

There are no ligands in this entry.

5.7 Other polymers [i](#)

There are no such residues in this entry.

5.8 Polymer linkage issues [i](#)

There are no chain breaks in this entry.

6 Fit of model and data [i](#)

6.1 Protein, DNA and RNA chains [i](#)

In the following table, the column labelled ‘#RSRZ> 2’ contains the number (and percentage) of RSRZ outliers, followed by percent RSRZ outliers for the chain as percentile scores relative to all X-ray entries and entries of similar resolution. The OWAB column contains the minimum, median, 95th percentile and maximum values of the occupancy-weighted average B-factor per residue. The column labelled ‘Q< 0.9’ lists the number of (and percentage) of residues with an average occupancy less than 0.9.

Mol	Chain	Analysed	<RSRZ>	#RSRZ>2	OWAB(Å ²)	Q<0.9
1	A	157/161 (97%)	0.09	0 100 100	28, 41, 55, 62	0
1	B	157/161 (97%)	0.83	22 (14%) 2 4	30, 47, 60, 64	0
1	C	157/161 (97%)	0.58	5 (3%) 47 55	31, 51, 69, 72	0
1	D	148/161 (91%)	1.30	38 (25%) 0 0	31, 50, 65, 75	0
1	E	157/161 (97%)	0.71	14 (8%) 9 13	29, 52, 69, 82	0
1	F	154/161 (95%)	0.25	3 (1%) 66 73	30, 43, 63, 68	0
All	All	930/966 (96%)	0.62	82 (8%) 10 14	28, 48, 65, 82	0

The worst 5 of 82 RSRZ outliers are listed below:

Mol	Chain	Res	Type	RSRZ
1	B	60	GLY	7.6
1	D	65	ALA	6.5
1	E	153	ARG	6.4
1	D	55	VAL	6.0
1	D	117	VAL	5.9

6.2 Non-standard residues in protein, DNA, RNA chains [i](#)

There are no non-standard protein/DNA/RNA residues in this entry.

6.3 Carbohydrates [i](#)

There are no monosaccharides in this entry.

6.4 Ligands [i](#)

There are no ligands in this entry.

6.5 Other polymers [i](#)

There are no such residues in this entry.