



wwPDB X-ray Structure Validation Summary Report ⓘ

Dec 5, 2023 – 02:12 am GMT

PDB ID : 1V0J
Title : Udp-galactopyranose mutase from Mycobacterium tuberculosis
Authors : Beis, K.; Naismith, J.H.
Deposited on : 2004-03-30
Resolution : 2.25 Å(reported)

This is a wwPDB X-ray Structure Validation Summary Report for a publicly released PDB entry.

We welcome your comments at validation@mail.wwpdb.org

A user guide is available at

<https://www.wwpdb.org/validation/2017/XrayValidationReportHelp>

with specific help available everywhere you see the ⓘ symbol.

The types of validation reports are described at

<http://www.wwpdb.org/validation/2017/FAQs#types>.

The following versions of software and data (see [references ⓘ](#)) were used in the production of this report:

MolProbity : 4.02b-467
Mogul : 1.8.4, CSD as541be (2020)
Xtriage (Phenix) : 1.13
EDS : 2.36
buster-report : 1.1.7 (2018)
Percentile statistics : 20191225.v01 (using entries in the PDB archive December 25th 2019)
Refmac : 5.8.0158
CCP4 : 7.0.044 (Gargrove)
Ideal geometry (proteins) : Engh & Huber (2001)
Ideal geometry (DNA, RNA) : Parkinson et al. (1996)
Validation Pipeline (wwPDB-VP) : 2.36

1 Overall quality at a glance

The following experimental techniques were used to determine the structure:

X-RAY DIFFRACTION

The reported resolution of this entry is 2.25 Å.

Percentile scores (ranging between 0-100) for global validation metrics of the entry are shown in the following graphic. The table shows the number of entries on which the scores are based.

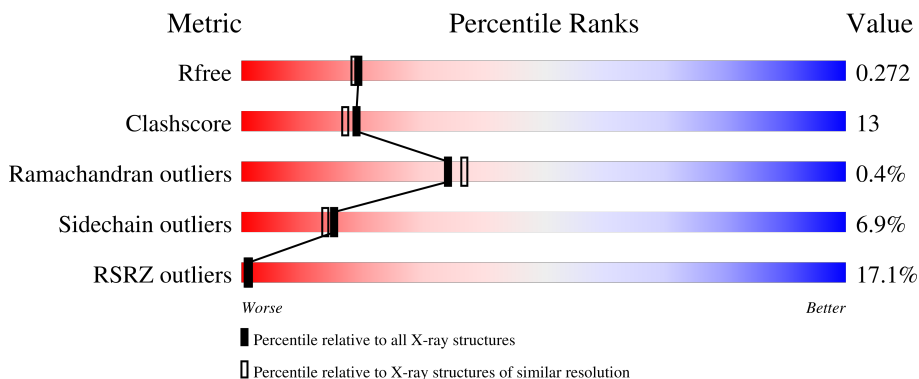

Metric	Whole archive (#Entries)	Similar resolution (#Entries, resolution range(Å))
R_{free}	130704	1377 (2.26-2.26)
Clashscore	141614	1487 (2.26-2.26)
Ramachandran outliers	138981	1449 (2.26-2.26)
Sidechain outliers	138945	1450 (2.26-2.26)
RSRZ outliers	127900	1356 (2.26-2.26)

The table below summarises the geometric issues observed across the polymeric chains and their fit to the electron density. The red, orange, yellow and green segments of the lower bar indicate the fraction of residues that contain outliers for ≥ 3 , 2, 1 and 0 types of geometric quality criteria respectively. A grey segment represents the fraction of residues that are not modelled. The numeric value for each fraction is indicated below the corresponding segment, with a dot representing fractions $\leq 5\%$. The upper red bar (where present) indicates the fraction of residues that have poor fit to the electron density. The numeric value is given above the bar.

Mol	Chain	Length	Quality of chain
1	A	399	 15% 76% 17% 5%
1	B	399	 16% 72% 20% 5%
1	C	399	 17% 74% 20% 5%
1	D	399	 19% 75% 18% 5%

The following table lists non-polymeric compounds, carbohydrate monomers and non-standard

residues in protein, DNA, RNA chains that are outliers for geometric or electron-density-fit criteria:

Mol	Type	Chain	Res	Chirality	Geometry	Clashes	Electron density
3	BCN	A	1394	-	-	X	-

2 Entry composition i

There are 4 unique types of molecules in this entry. The entry contains 13892 atoms, of which 0 are hydrogens and 0 are deuteriums.

In the tables below, the ZeroOcc column contains the number of atoms modelled with zero occupancy, the AltConf column contains the number of residues with at least one atom in alternate conformation and the Trace column contains the number of residues modelled with at most 2 atoms.

- Molecule 1 is a protein called UDP-GALACTOPYRANOSE MUTASE.

Mol	Chain	Residues	Atoms					ZeroOcc	AltConf	Trace
			Total	C	N	O	S			
1	A	388	Total 3162	C 2020	N 548	O 585	S 9	0	0	0
1	B	388	Total 3162	C 2020	N 548	O 585	S 9	0	0	0
1	C	388	Total 3162	C 2020	N 548	O 585	S 9	0	0	0
1	D	388	Total 3162	C 2020	N 548	O 585	S 9	0	0	0

- Molecule 2 is FLAVIN-ADENINE DINUCLEOTIDE (three-letter code: FAD) (formula: $C_{27}H_{33}N_9O_{15}P_2$).

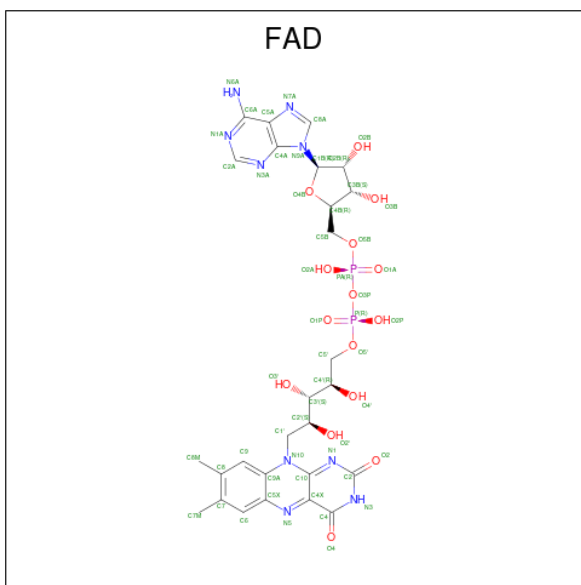

Mol	Chain	Residues	Atoms				ZeroOcc	AltConf	
			Total	C	N	O			P
2	A	1	Total 53	C 27	N 9	O 15	P 2	0	0
2	B	1	Total 53	C 27	N 9	O 15	P 2	0	0

Continued on next page...

Continued from previous page...

Mol	Chain	Residues	Atoms					ZeroOcc	AltConf
			Total	C	N	O	P		
2	C	1	Total 53	C 27	N 9	O 15	P 2	0	0
2	D	1	Total 53	C 27	N 9	O 15	P 2	0	0

- Molecule 3 is BICINE (three-letter code: BCN) (formula: C₆H₁₃NO₄).

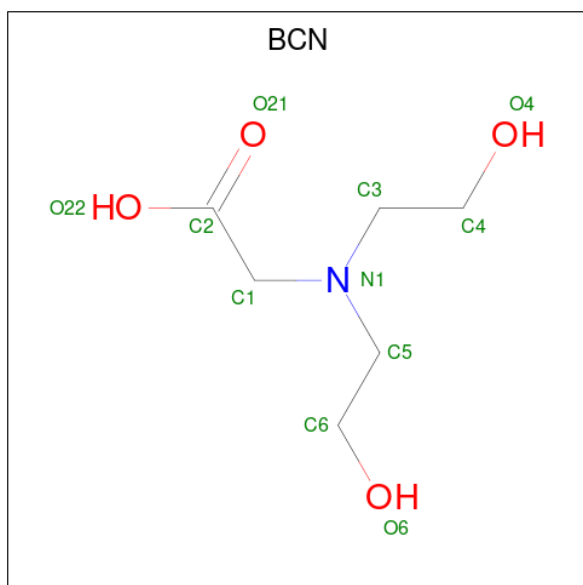

Mol	Chain	Residues	Atoms				ZeroOcc	AltConf
			Total	C	N	O		
3	A	1	Total 11	C 6	N 1	O 4	0	0

- Molecule 4 is water.

Mol	Chain	Residues	Atoms		ZeroOcc	AltConf
4	A	334	Total 334	O 334	0	0
4	B	238	Total 238	O 238	0	0
4	C	267	Total 267	O 267	0	0
4	D	182	Total 182	O 182	0	0

3 Residue-property plots

These plots are drawn for all protein, RNA, DNA and oligosaccharide chains in the entry. The first graphic for a chain summarises the proportions of the various outlier classes displayed in the second graphic. The second graphic shows the sequence view annotated by issues in geometry and electron density. Residues are color-coded according to the number of geometric quality criteria for which they contain at least one outlier: green = 0, yellow = 1, orange = 2 and red = 3 or more. A red dot above a residue indicates a poor fit to the electron density ($RSRZ > 2$). Stretches of 2 or more consecutive residues without any outlier are shown as a green connector. Residues present in the sample, but not in the model, are shown in grey.

- Molecule 1: UDP-GALACTOPYRANOSE MUTASE

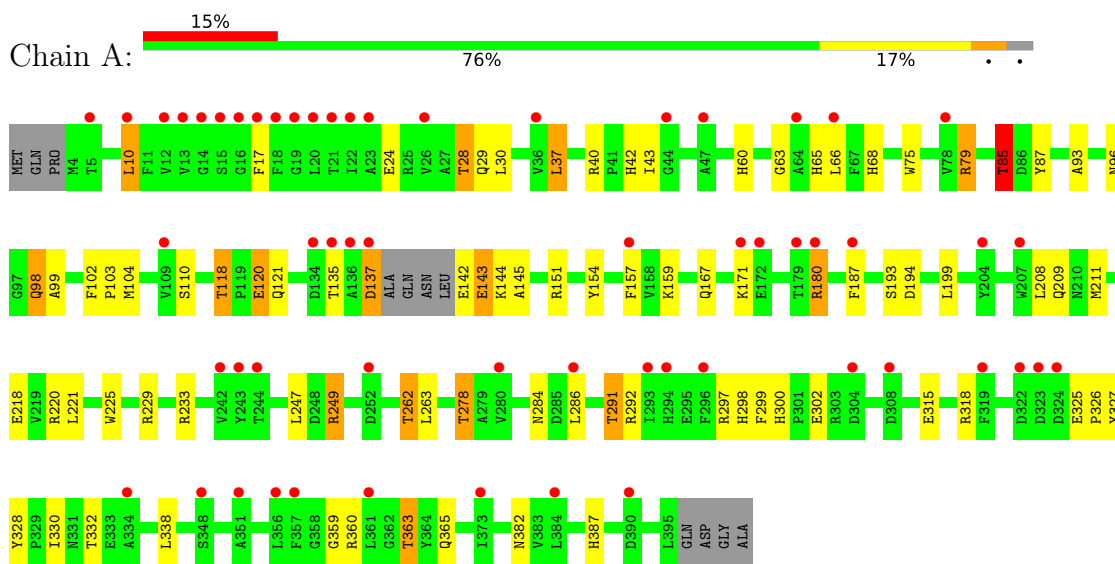

- Molecule 1: UDP-GALACTOPYRANOSE MUTASE

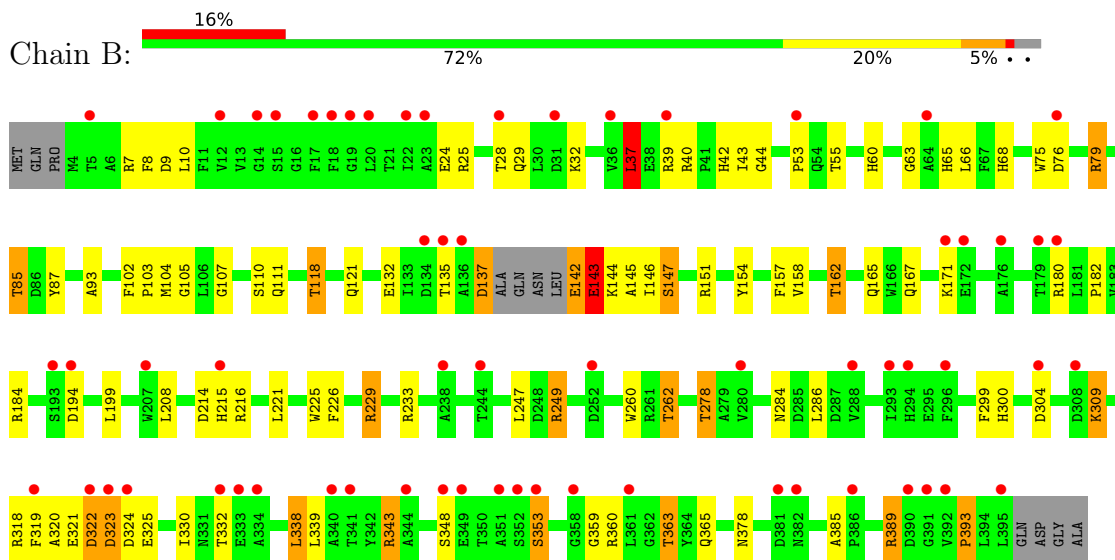

- Molecule 1: UDP-GALACTOPYRANOSE MUTASE

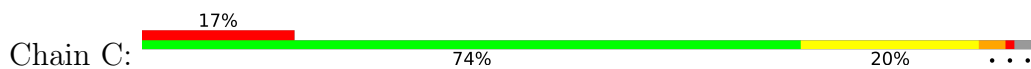

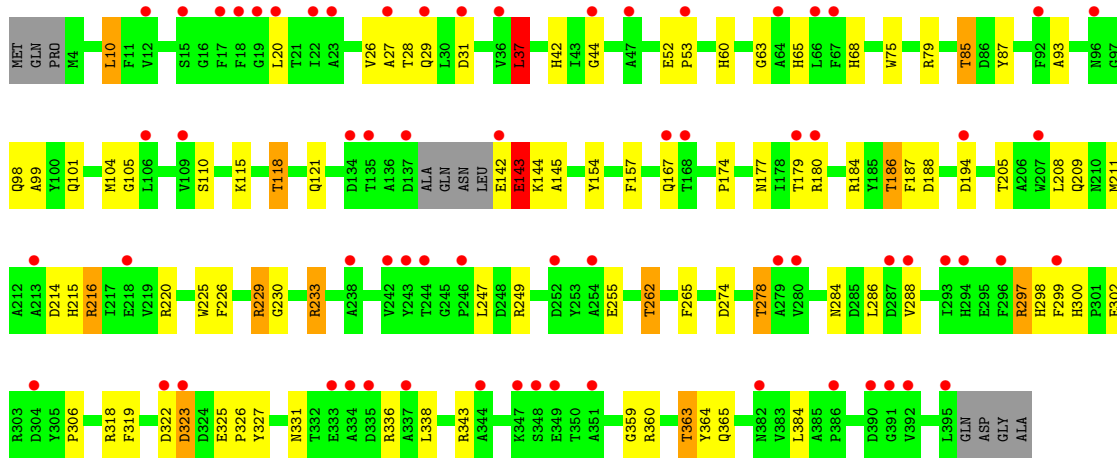

● Molecule 1: UDP-GALACTOPYRANOSE MUTASE

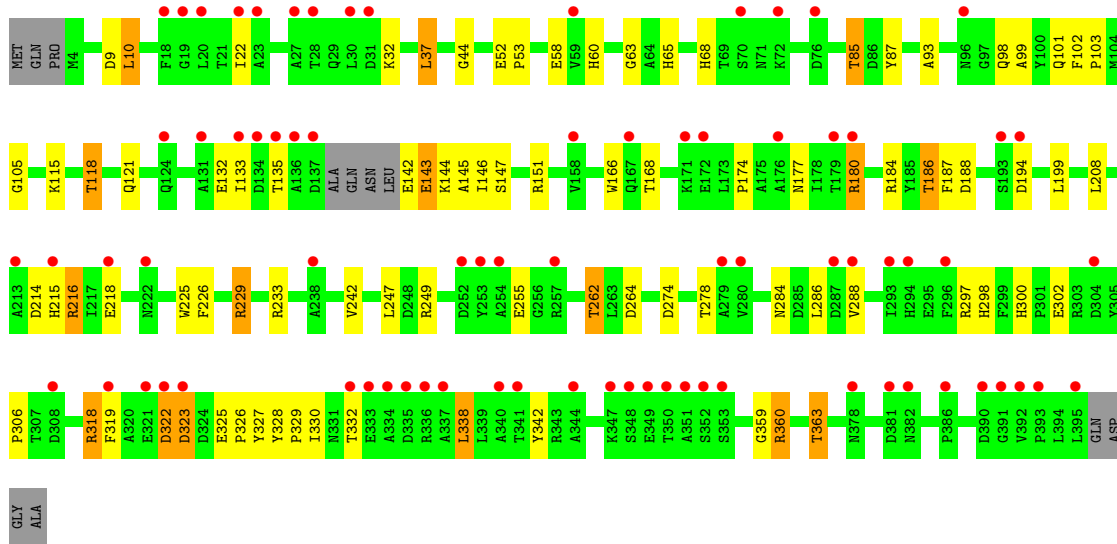
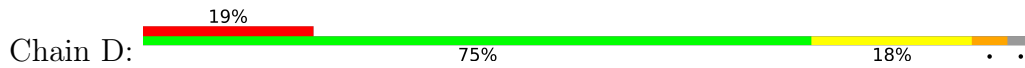

4 Data and refinement statistics i

Property	Value	Source
Space group	P 21 21 2	Depositor
Cell constants a, b, c, α , β , γ	137.60Å 153.73Å 137.69Å 90.00° 90.00° 90.00°	Depositor
Resolution (Å)	15.00 – 2.25 25.46 – 2.25	Depositor EDS
% Data completeness (in resolution range)	88.4 (15.00-2.25) 88.4 (25.46-2.25)	Depositor EDS
R_{merge}	0.10	Depositor
R_{sym}	(Not available)	Depositor
$\langle I/\sigma(I) \rangle$ ¹	2.75 (at 2.26Å)	Xtrriage
Refinement program	REFMAC 5.2.0007	Depositor
R, R_{free}	0.225 , 0.266 0.240 , 0.272	Depositor DCC
R_{free} test set	6232 reflections (5.09%)	wwPDB-VP
Wilson B-factor (Å ²)	43.9	Xtrriage
Anisotropy	0.142	Xtrriage
Bulk solvent k_{sol} (e/Å ³), B_{sol} (Å ²)	0.40 , 47.1	EDS
L-test for twinning ²	$\langle L \rangle = 0.51$, $\langle L^2 \rangle = 0.35$	Xtrriage
Estimated twinning fraction	0.018 for l,-k,h	Xtrriage
F_o, F_c correlation	0.94	EDS
Total number of atoms	13892	wwPDB-VP
Average B, all atoms (Å ²)	41.0	wwPDB-VP

Xtrriage's analysis on translational NCS is as follows: *The analyses of the Patterson function reveals a significant off-origin peak that is 45.64 % of the origin peak, indicating pseudo-translational symmetry. The chance of finding a peak of this or larger height randomly in a structure without pseudo-translational symmetry is equal to 1.2839e-04. The detected translational NCS is most likely also responsible for the elevated intensity ratio.*

¹Intensities estimated from amplitudes.

²Theoretical values of $\langle |L| \rangle$, $\langle L^2 \rangle$ for acentric reflections are 0.5, 0.333 respectively for untwinned datasets, and 0.375, 0.2 for perfectly twinned datasets.

5 Model quality [i](#)

5.1 Standard geometry [i](#)

Bond lengths and bond angles in the following residue types are not validated in this section: BCN, FAD

The Z score for a bond length (or angle) is the number of standard deviations the observed value is removed from the expected value. A bond length (or angle) with $|Z| > 5$ is considered an outlier worth inspection. RMSZ is the root-mean-square of all Z scores of the bond lengths (or angles).

Mol	Chain	Bond lengths		Bond angles	
		RMSZ	# $ Z > 5$	RMSZ	# $ Z > 5$
1	A	0.69	0/3251	0.79	7/4417 (0.2%)
1	B	0.63	0/3251	0.73	2/4417 (0.0%)
1	C	0.77	3/3251 (0.1%)	0.79	3/4417 (0.1%)
1	D	0.67	1/3251 (0.0%)	0.70	1/4417 (0.0%)
All	All	0.69	4/13004 (0.0%)	0.75	13/17668 (0.1%)

Chiral center outliers are detected by calculating the chiral volume of a chiral center and verifying if the center is modelled as a planar moiety or with the opposite hand. A planarity outlier is detected by checking planarity of atoms in a peptide group, atoms in a mainchain group or atoms of a sidechain that are expected to be planar.

Mol	Chain	#Chirality outliers	#Planarity outliers
1	A	0	1
1	B	0	1
1	C	0	1
1	D	0	1
All	All	0	4

All (4) bond length outliers are listed below:

Mol	Chain	Res	Type	Atoms	Z	Observed(Å)	Ideal(Å)
1	D	255	GLU	C-N	11.39	1.53	1.33
1	C	143	GLU	CD-OE2	5.86	1.32	1.25
1	C	255	GLU	C-N	5.76	1.43	1.33
1	C	364	TYR	CE1-CZ	5.40	1.45	1.38

The worst 5 of 13 bond angle outliers are listed below:

Mol	Chain	Res	Type	Atoms	Z	Observed(°)	Ideal(°)
1	A	297	ARG	NE-CZ-NH2	-7.95	116.32	120.30

Continued on next page...

Continued from previous page...

Mol	Chain	Res	Type	Atoms	Z	Observed(°)	Ideal(°)
1	A	79	ARG	NE-CZ-NH2	-6.94	116.83	120.30
1	A	297	ARG	NE-CZ-NH1	6.24	123.42	120.30
1	A	37	LEU	CA-CB-CG	-5.74	102.09	115.30
1	C	233	ARG	NE-CZ-NH2	-5.74	117.43	120.30

There are no chirality outliers.

All (4) planarity outliers are listed below:

Mol	Chain	Res	Type	Group
1	A	143	GLU	Peptide
1	B	143	GLU	Peptide
1	C	143	GLU	Peptide
1	D	143	GLU	Peptide

5.2 Too-close contacts [i](#)

In the following table, the Non-H and H(model) columns list the number of non-hydrogen atoms and hydrogen atoms in the chain respectively. The H(added) column lists the number of hydrogen atoms added and optimized by MolProbity. The Clashes column lists the number of clashes within the asymmetric unit, whereas Symm-Clashes lists symmetry-related clashes.

Mol	Chain	Non-H	H(model)	H(added)	Clashes	Symm-Clashes
1	A	3162	0	3019	87	0
1	B	3162	0	3019	87	0
1	C	3162	0	3019	83	0
1	D	3162	0	3019	68	0
2	A	53	0	31	3	0
2	B	53	0	31	2	0
2	C	53	0	31	4	0
2	D	53	0	31	4	0
3	A	11	0	12	12	0
4	A	334	0	0	34	0
4	B	238	0	0	15	0
4	C	267	0	0	25	0
4	D	182	0	0	16	0
All	All	13892	0	12212	326	0

The all-atom clashscore is defined as the number of clashes found per 1000 atoms (including hydrogen atoms). The all-atom clashscore for this structure is 13.

The worst 5 of 326 close contacts within the same asymmetric unit are listed below, sorted by their clash magnitude.

Atom-1	Atom-2	Interatomic distance (Å)	Clash overlap (Å)
3:A:1394:BCN:C4	4:A:2330:HOH:O	2.05	1.01
3:A:1394:BCN:O21	4:A:2329:HOH:O	1.77	1.01
1:A:28:THR:CG2	1:A:29:GLN:HE21	1.74	0.99
1:A:142:GLU:N	1:A:154:TYR:HH	1.61	0.98
1:C:93:ALA:HB1	1:C:284:ASN:HD21	1.29	0.98

There are no symmetry-related clashes.

5.3 Torsion angles [i](#)

5.3.1 Protein backbone [i](#)

In the following table, the Percentiles column shows the percent Ramachandran outliers of the chain as a percentile score with respect to all X-ray entries followed by that with respect to entries of similar resolution.

The Analysed column shows the number of residues for which the backbone conformation was analysed, and the total number of residues.

Mol	Chain	Analysed	Favoured	Allowed	Outliers	Percentiles	
1	A	384/399 (96%)	372 (97%)	12 (3%)	0	100	100
1	B	384/399 (96%)	372 (97%)	8 (2%)	4 (1%)	15	13
1	C	384/399 (96%)	370 (96%)	12 (3%)	2 (0%)	29	29
1	D	384/399 (96%)	377 (98%)	7 (2%)	0	100	100
All	All	1536/1596 (96%)	1491 (97%)	39 (2%)	6 (0%)	34	37

5 of 6 Ramachandran outliers are listed below:

Mol	Chain	Res	Type
1	C	323	ASP
1	B	393	PRO
1	C	143	GLU
1	B	143	GLU
1	B	53	PRO

5.3.2 Protein sidechains [i](#)

In the following table, the Percentiles column shows the percent sidechain outliers of the chain as a percentile score with respect to all X-ray entries followed by that with respect to entries of similar resolution.

The Analysed column shows the number of residues for which the sidechain conformation was analysed, and the total number of residues.

Mol	Chain	Analysed	Rotameric	Outliers	Percentiles	
1	A	326/334 (98%)	303 (93%)	23 (7%)	14	13
1	B	326/334 (98%)	299 (92%)	27 (8%)	11	9
1	C	326/334 (98%)	306 (94%)	20 (6%)	18	18
1	D	326/334 (98%)	306 (94%)	20 (6%)	18	18
All	All	1304/1336 (98%)	1214 (93%)	90 (7%)	15	14

5 of 90 residues with a non-rotameric sidechain are listed below:

Mol	Chain	Res	Type
1	C	186	THR
1	D	37	LEU
1	C	220	ARG
1	C	286	LEU
1	D	180	ARG

Sometimes sidechains can be flipped to improve hydrogen bonding and reduce clashes. 5 of 49 such sidechains are listed below:

Mol	Chain	Res	Type
1	C	98	GLN
1	C	331	ASN
1	C	101	GLN
1	C	284	ASN
1	D	65	HIS

5.3.3 RNA [i](#)

There are no RNA molecules in this entry.

5.4 Non-standard residues in protein, DNA, RNA chains [i](#)

There are no non-standard protein/DNA/RNA residues in this entry.

5.5 Carbohydrates [i](#)

There are no monosaccharides in this entry.

5.6 Ligand geometry [i](#)

5 ligands are modelled in this entry.

In the following table, the Counts columns list the number of bonds (or angles) for which Mogul statistics could be retrieved, the number of bonds (or angles) that are observed in the model and the number of bonds (or angles) that are defined in the Chemical Component Dictionary. The Link column lists molecule types, if any, to which the group is linked. The Z score for a bond length (or angle) is the number of standard deviations the observed value is removed from the expected value. A bond length (or angle) with $|Z| > 2$ is considered an outlier worth inspection. RMSZ is the root-mean-square of all Z scores of the bond lengths (or angles).

Mol	Type	Chain	Res	Link	Bond lengths			Bond angles		
					Counts	RMSZ	# Z > 2	Counts	RMSZ	# Z > 2
3	BCN	A	1394	-	10,10,10	0.76	0	11,11,11	1.67	2 (18%)
2	FAD	C	1388	-	53,58,58	1.33	4 (7%)	68,89,89	1.37	10 (14%)
2	FAD	A	1393	-	53,58,58	1.25	4 (7%)	68,89,89	1.50	13 (19%)
2	FAD	D	1388	-	53,58,58	1.31	4 (7%)	68,89,89	1.38	11 (16%)
2	FAD	B	1390	-	53,58,58	1.23	4 (7%)	68,89,89	1.43	11 (16%)

In the following table, the Chirals column lists the number of chiral outliers, the number of chiral centers analysed, the number of these observed in the model and the number defined in the Chemical Component Dictionary. Similar counts are reported in the Torsion and Rings columns. '-' means no outliers of that kind were identified.

Mol	Type	Chain	Res	Link	Chirals	Torsions	Rings
3	BCN	A	1394	-	-	7/10/10/10	-
2	FAD	C	1388	-	-	8/30/50/50	0/6/6/6
2	FAD	A	1393	-	-	9/30/50/50	0/6/6/6
2	FAD	D	1388	-	-	8/30/50/50	0/6/6/6
2	FAD	B	1390	-	-	8/30/50/50	0/6/6/6

The worst 5 of 16 bond length outliers are listed below:

Mol	Chain	Res	Type	Atoms	Z	Observed(Å)	Ideal(Å)
2	C	1388	FAD	C2A-N3A	5.28	1.40	1.32
2	A	1393	FAD	C2A-N3A	5.18	1.40	1.32
2	B	1390	FAD	C2A-N3A	5.07	1.40	1.32
2	D	1388	FAD	C2A-N3A	4.80	1.39	1.32
2	D	1388	FAD	C4X-N5	4.75	1.40	1.30

The worst 5 of 47 bond angle outliers are listed below:

Mol	Chain	Res	Type	Atoms	Z	Observed(°)	Ideal(°)
2	C	1388	FAD	N3A-C2A-N1A	-5.91	119.44	128.68
2	D	1388	FAD	N3A-C2A-N1A	-5.35	120.31	128.68
2	A	1393	FAD	N3A-C2A-N1A	-5.29	120.41	128.68
2	B	1390	FAD	N3A-C2A-N1A	-4.83	121.13	128.68
3	A	1394	BCN	C1-N1-C3	-4.07	102.04	111.94

There are no chirality outliers.

5 of 40 torsion outliers are listed below:

Mol	Chain	Res	Type	Atoms
2	A	1393	FAD	C5B-O5B-PA-O1A
2	A	1393	FAD	C5B-O5B-PA-O2A
2	A	1393	FAD	O4B-C4B-C5B-O5B
2	A	1393	FAD	C3'-C4'-C5'-O5'
2	B	1390	FAD	O4B-C4B-C5B-O5B

There are no ring outliers.

5 monomers are involved in 25 short contacts:

Mol	Chain	Res	Type	Clashes	Symm-Clashes
3	A	1394	BCN	12	0
2	C	1388	FAD	4	0
2	A	1393	FAD	3	0
2	D	1388	FAD	4	0
2	B	1390	FAD	2	0

The following is a two-dimensional graphical depiction of Mogul quality analysis of bond lengths, bond angles, torsion angles, and ring geometry for all instances of the Ligand of Interest. In addition, ligands with molecular weight > 250 and outliers as shown on the validation Tables will also be included. For torsion angles, if less than 5% of the Mogul distribution of torsion angles is within 10 degrees of the torsion angle in question, then that torsion angle is considered an outlier. Any bond that is central to one or more torsion angles identified as an outlier by Mogul will be highlighted in the graph. For rings, the root-mean-square deviation (RMSD) between the ring in question and similar rings identified by Mogul is calculated over all ring torsion angles. If the average RMSD is greater than 60 degrees and the minimal RMSD between the ring in question and any Mogul-identified rings is also greater than 60 degrees, then that ring is considered an outlier. The outliers are highlighted in purple. The color gray indicates Mogul did not find sufficient equivalents in the CSD to analyse the geometry.

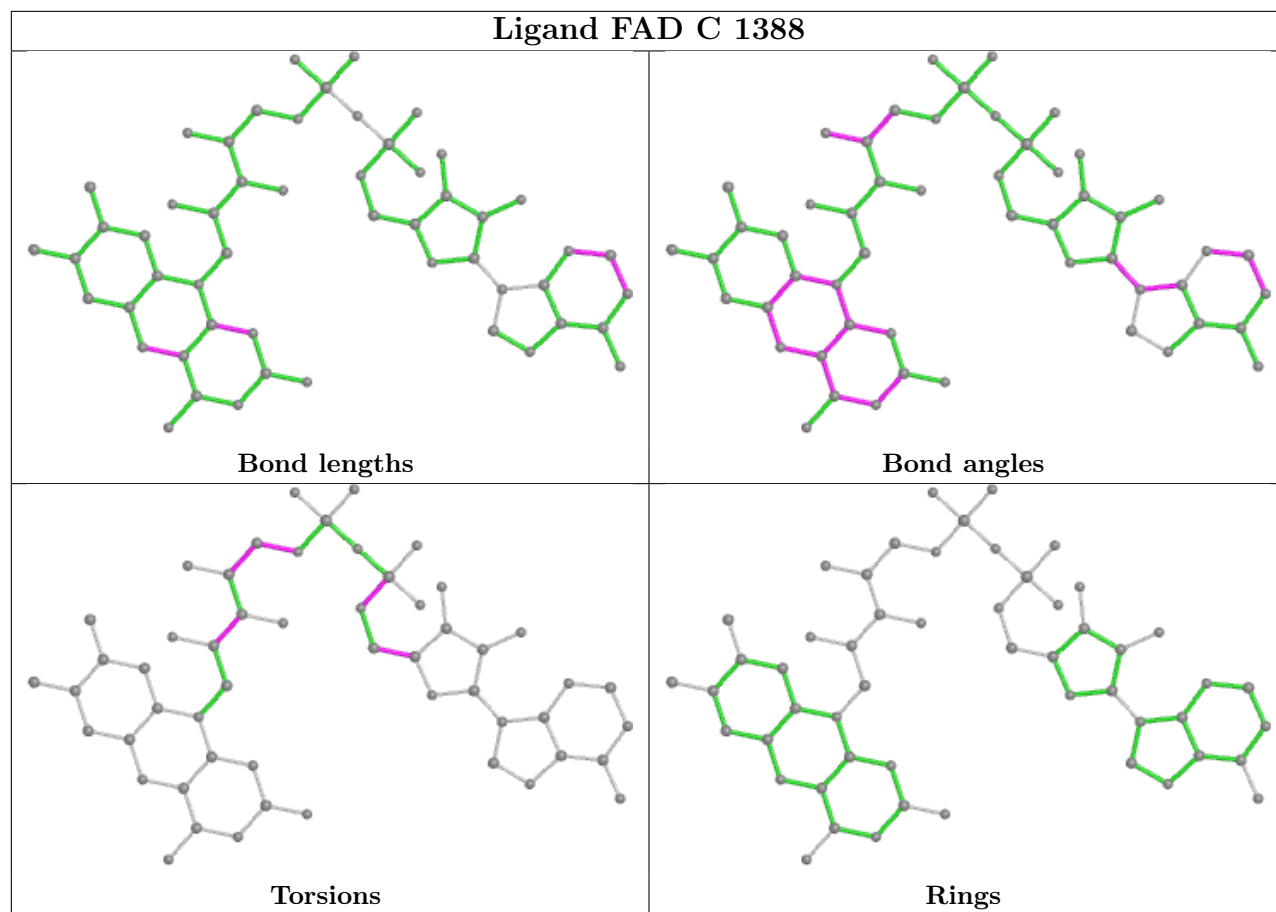

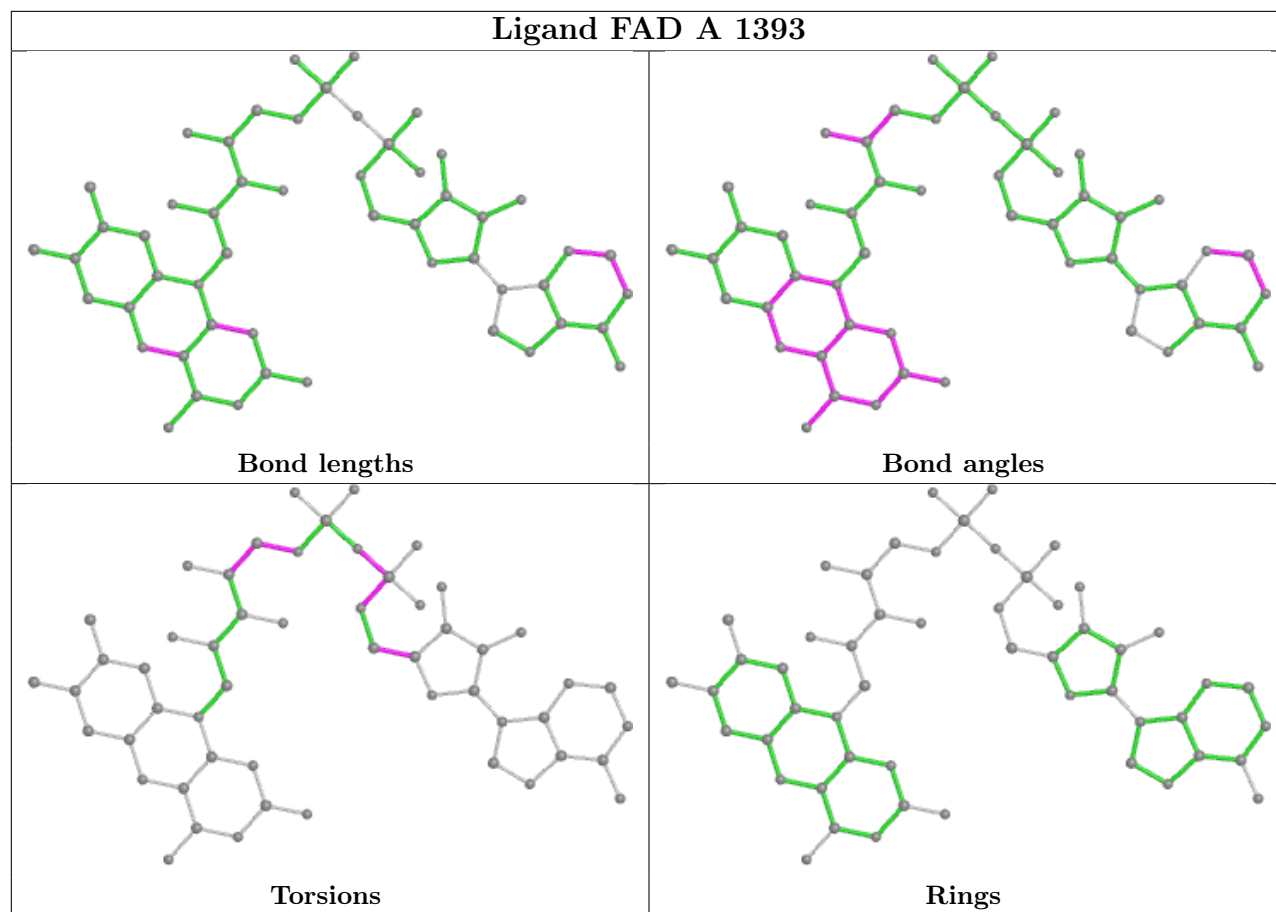

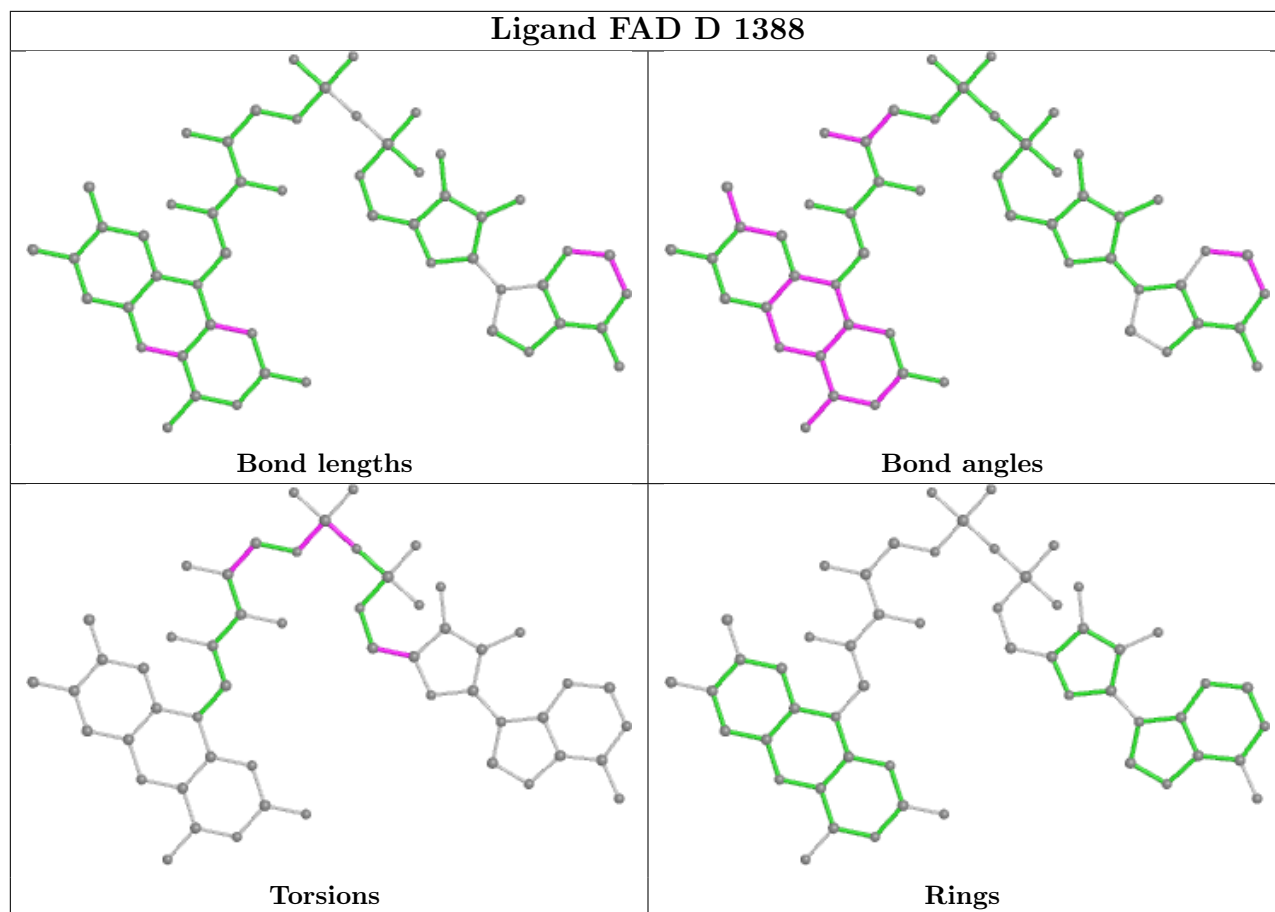

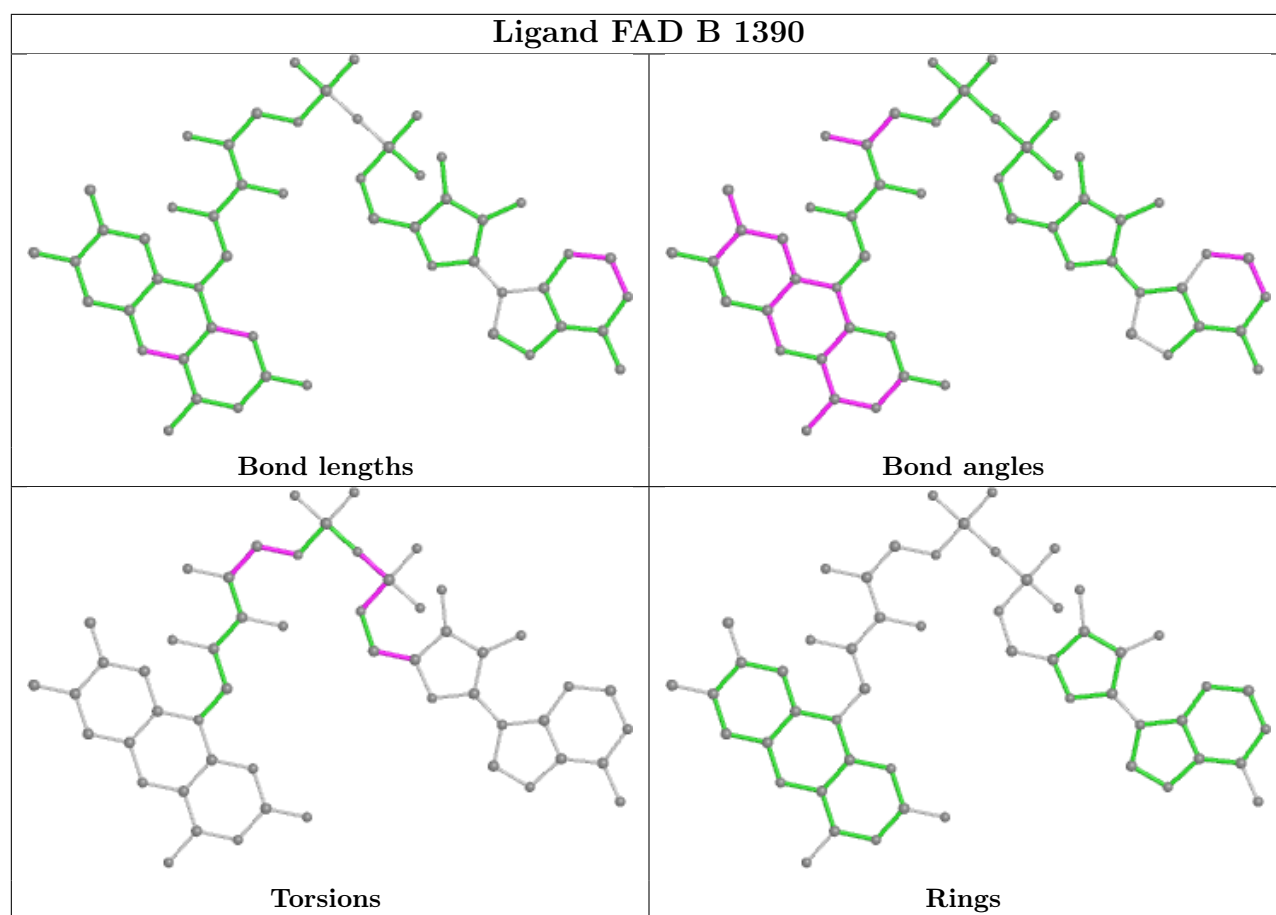

5.7 Other polymers [i](#)

There are no such residues in this entry.

5.8 Polymer linkage issues [i](#)

There are no chain breaks in this entry.

6 Fit of model and data [i](#)

6.1 Protein, DNA and RNA chains [i](#)

In the following table, the column labelled ‘#RSRZ > 2’ contains the number (and percentage) of RSRZ outliers, followed by percent RSRZ outliers for the chain as percentile scores relative to all X-ray entries and entries of similar resolution. The OWAB column contains the minimum, median, 95th percentile and maximum values of the occupancy-weighted average B-factor per residue. The column labelled ‘Q < 0.9’ lists the number of (and percentage) of residues with an average occupancy less than 0.9.

Mol	Chain	Analysed	<RSRZ>	#RSRZ>2	OWAB(Å ²)	Q<0.9
1	A	388/399 (97%)	0.78	58 (14%) 2 2	29, 39, 55, 64	0
1	B	388/399 (97%)	0.73	63 (16%) 1 1	30, 40, 56, 64	0
1	C	388/399 (97%)	0.82	67 (17%) 1 1	30, 40, 55, 64	0
1	D	388/399 (97%)	0.92	77 (19%) 1 1	31, 40, 55, 64	0
All	All	1552/1596 (97%)	0.81	265 (17%) 1 1	29, 40, 55, 64	0

The worst 5 of 265 RSRZ outliers are listed below:

Mol	Chain	Res	Type	RSRZ
1	B	76	ASP	8.3
1	D	344	ALA	6.2
1	B	351	ALA	5.8
1	B	390	ASP	5.7
1	D	390	ASP	5.5

6.2 Non-standard residues in protein, DNA, RNA chains [i](#)

There are no non-standard protein/DNA/RNA residues in this entry.

6.3 Carbohydrates [i](#)

There are no monosaccharides in this entry.

6.4 Ligands [i](#)

In the following table, the Atoms column lists the number of modelled atoms in the group and the number defined in the chemical component dictionary. The B-factors column lists the minimum, median, 95th percentile and maximum values of B factors of atoms in the group. The column labelled ‘Q < 0.9’ lists the number of atoms with occupancy less than 0.9.

Mol	Type	Chain	Res	Atoms	RSCC	RSR	B-factors(\AA^2)	$Q < 0.9$
3	BCN	A	1394	11/11	0.83	0.30	48,58,65,66	0
2	FAD	C	1388	53/53	0.91	0.17	43,51,56,56	0
2	FAD	D	1388	53/53	0.92	0.15	45,50,54,56	0
2	FAD	B	1390	53/53	0.94	0.13	36,44,48,49	0
2	FAD	A	1393	53/53	0.94	0.16	40,46,53,55	0

The following is a graphical depiction of the model fit to experimental electron density of all instances of the Ligand of Interest. In addition, ligands with molecular weight > 250 and outliers as shown on the geometry validation Tables will also be included. Each fit is shown from different orientation to approximate a three-dimensional view.

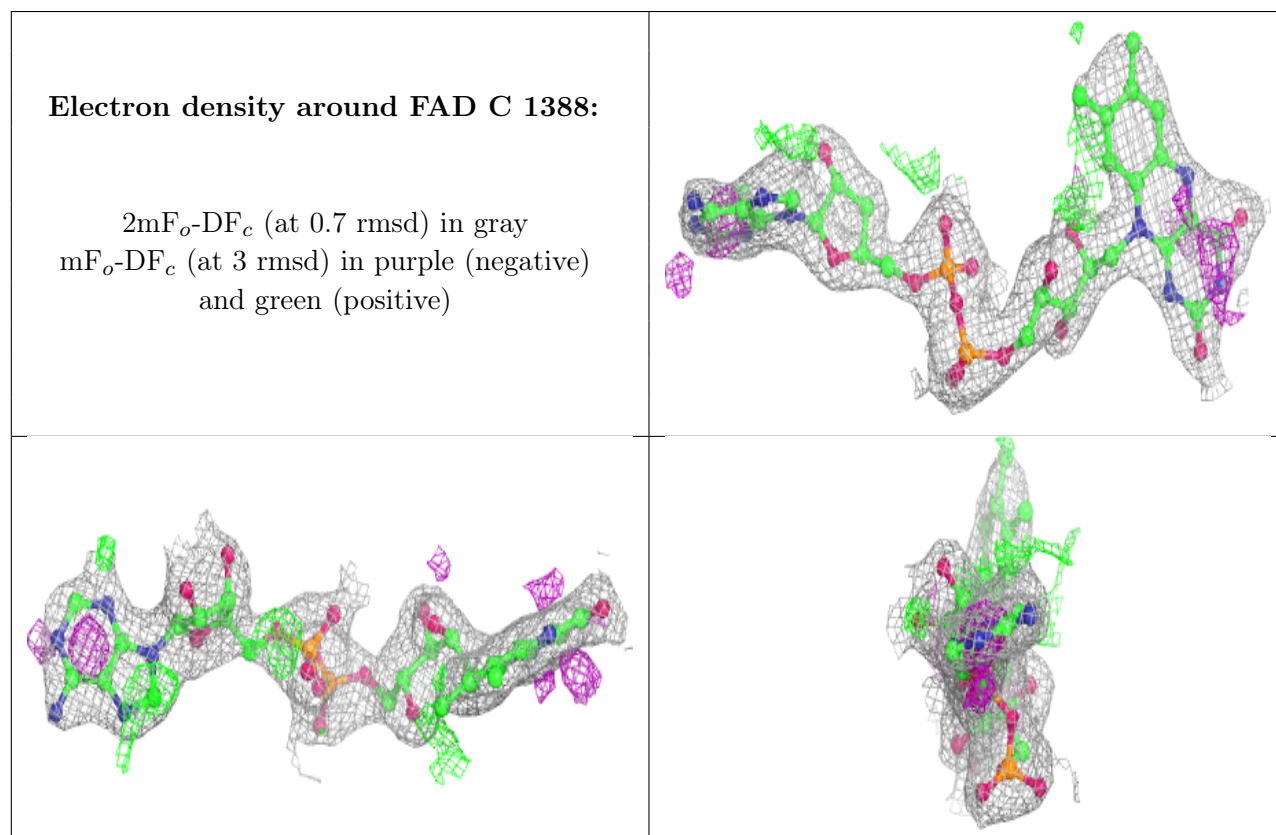

Electron density around FAD D 1388:

$2mF_o-DF_c$ (at 0.7 rmsd) in gray
 mF_o-DF_c (at 3 rmsd) in purple (negative)
and green (positive)

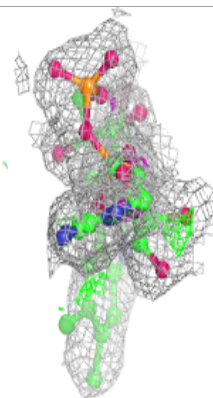
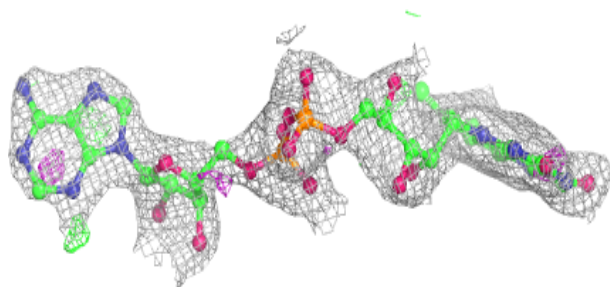
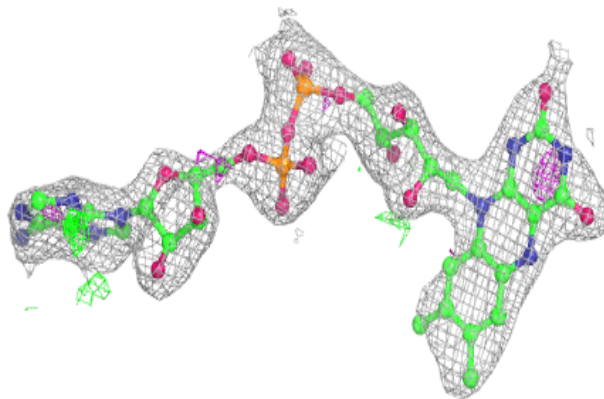
**Electron density around FAD B 1390:**

$2mF_o-DF_c$ (at 0.7 rmsd) in gray
 mF_o-DF_c (at 3 rmsd) in purple (negative)
and green (positive)

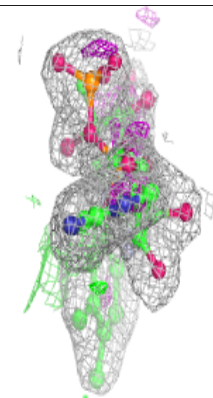
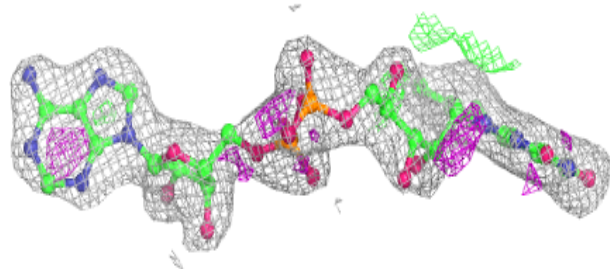
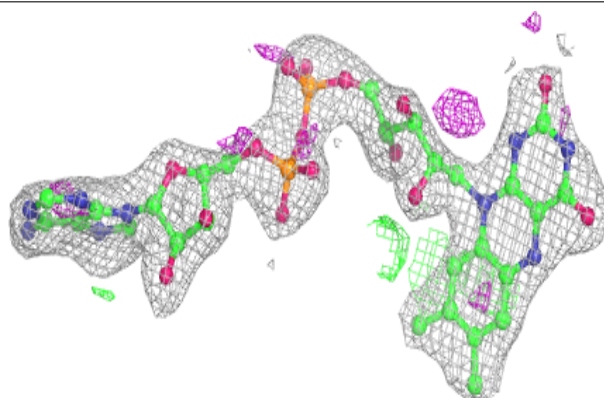

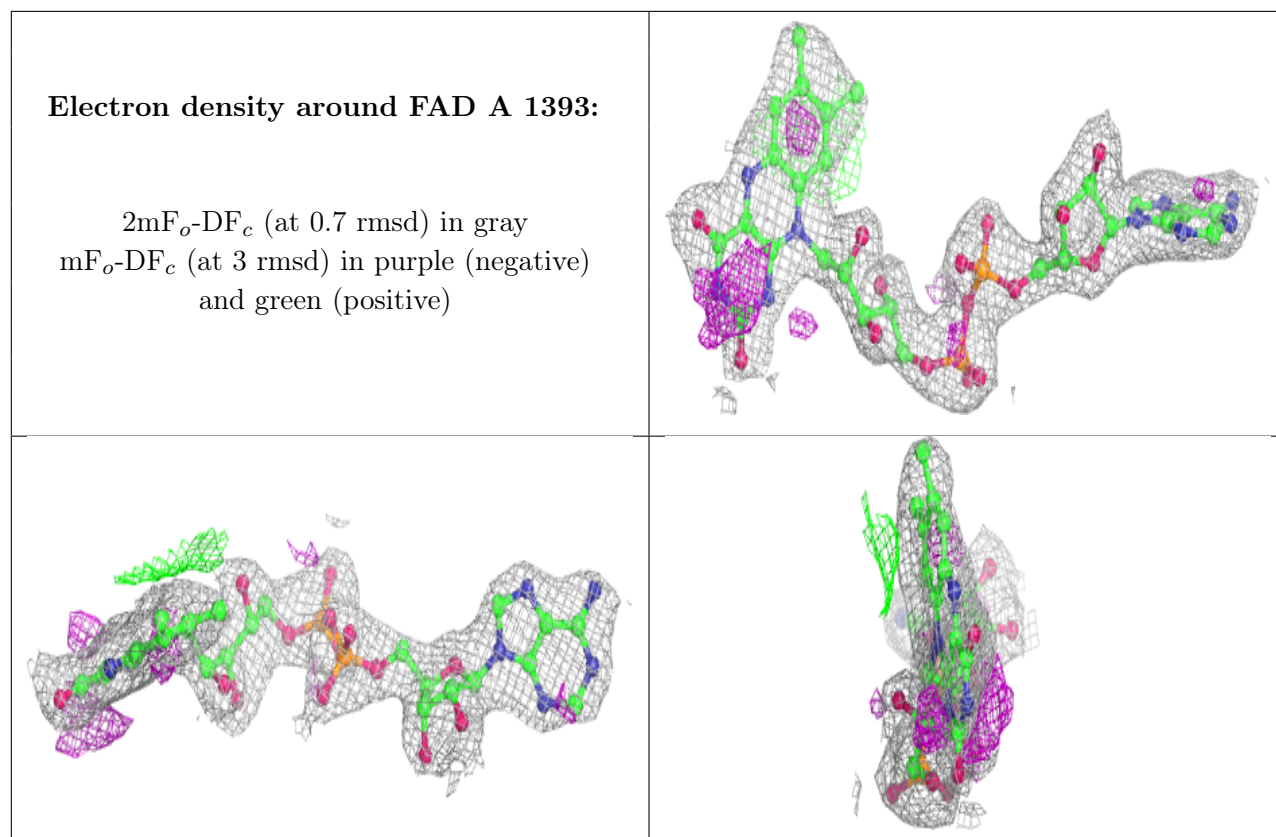

6.5 Other polymers [i](#)

There are no such residues in this entry.