



Full wwPDB EM Validation Report ⓘ

May 20, 2024 – 01:17 PM EDT

PDB ID : 8UT9
EMDB ID : EMD-42534
Title : CryoEM structure of A/Shanghai/1/2013 H7 in complex with polyclonal Fab from mice immunized with H7 stem nanoparticles-28 days post immunization
Authors : Huang, J.; Han, J.; Ward, A.B.
Deposited on : 2023-10-30
Resolution : 3.30 Å(reported)

This is a Full wwPDB EM Validation Report for a publicly released PDB entry.

We welcome your comments at validation@mail.wwpdb.org

A user guide is available at

<https://www.wwpdb.org/validation/2017/EMValidationReportHelp>

with specific help available everywhere you see the ⓘ symbol.

The types of validation reports are described at

<http://www.wwpdb.org/validation/2017/FAQs#types>.

The following versions of software and data (see [references ⓘ](#)) were used in the production of this report:

EMDB validation analysis : 0.0.1.dev92
Mogul : 1.8.5 (274361), CSD as541be (2020)
MolProbity : 4.02b-467
Percentile statistics : 20191225.v01 (using entries in the PDB archive December 25th 2019)
MapQ : 1.9.13
Ideal geometry (proteins) : Engh & Huber (2001)
Ideal geometry (DNA, RNA) : Parkinson et al. (1996)
Validation Pipeline (wwPDB-VP) : 2.36.2

1 Overall quality at a glance i

The following experimental techniques were used to determine the structure:
ELECTRON MICROSCOPY

The reported resolution of this entry is 3.30 Å.

Percentile scores (ranging between 0-100) for global validation metrics of the entry are shown in the following graphic. The table shows the number of entries on which the scores are based.

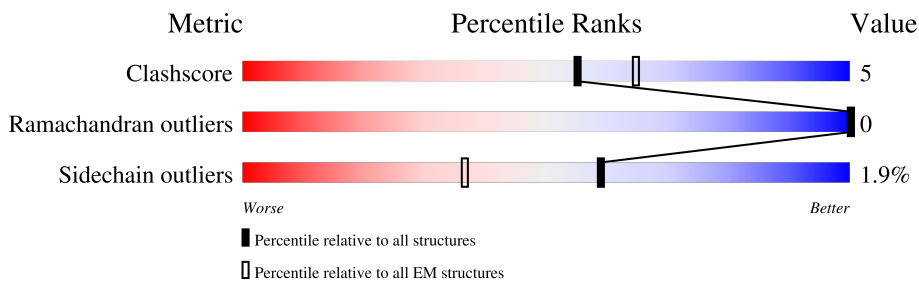



Metric	Whole archive (#Entries)	EM structures (#Entries)
Clashscore	158937	4297
Ramachandran outliers	154571	4023
Sidechain outliers	154315	3826

The table below summarises the geometric issues observed across the polymeric chains and their fit to the map. The red, orange, yellow and green segments of the bar indicate the fraction of residues that contain outliers for ≥ 3 , 2, 1 and 0 types of geometric quality criteria respectively. A grey segment represents the fraction of residues that are not modelled. The numeric value for each fraction is indicated below the corresponding segment, with a dot representing fractions $\leq 5\%$. The upper red bar (where present) indicates the fraction of residues that have poor fit to the EM map (all-atom inclusion $< 40\%$). The numeric value is given above the bar.

Mol	Chain	Length	Quality of chain
1	A	317	
1	C	317	
1	E	317	
2	B	231	
2	D	231	
2	F	231	
3	G	126	
4	H	108	

Continued on next page...

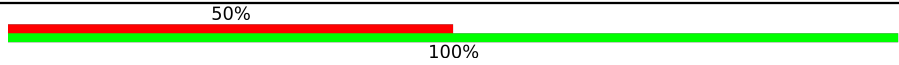
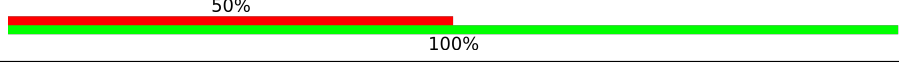
Continued from previous page...

Mol	Chain	Length	Quality of chain
5	I	2	
6	J	2	
6	K	2	

2 Entry composition [i](#)

There are 7 unique types of molecules in this entry. The entry contains 12707 atoms, of which 0 are hydrogens and 0 are deuteriums.

In the tables below, the AltConf column contains the number of residues with at least one atom in alternate conformation and the Trace column contains the number of residues modelled with at most 2 atoms.

- Molecule 1 is a protein called Hemagglutinin HA1 chain.

Mol	Chain	Residues	Atoms					AltConf	Trace
			Total	C	N	O	S		
1	A	317	Total 2422	C 1503	N 436	O 468	S 15	0	0
1	C	316	Total 2414	C 1497	N 435	O 467	S 15	0	0
1	E	316	Total 2414	C 1497	N 435	O 467	S 15	0	0

There are 6 discrepancies between the modelled and reference sequences:

Chain	Residue	Modelled	Actual	Comment	Reference
A	88	PHE	TYR	conflict	UNP V5IRV0
A	317	ILE	-	expression tag	UNP V5IRV0
C	88	PHE	TYR	conflict	UNP V5IRV0
C	317	ILE	-	expression tag	UNP V5IRV0
E	88	PHE	TYR	conflict	UNP V5IRV0
E	317	ILE	-	expression tag	UNP V5IRV0

- Molecule 2 is a protein called Hemagglutinin HA2 chain.

Mol	Chain	Residues	Atoms					AltConf	Trace
			Total	C	N	O	S		
2	B	167	Total 1359	C 838	N 237	O 277	S 7	0	0
2	D	167	Total 1359	C 838	N 237	O 277	S 7	0	0
2	F	167	Total 1359	C 838	N 237	O 277	S 7	0	0

There are 162 discrepancies between the modelled and reference sequences:

Chain	Residue	Modelled	Actual	Comment	Reference
B	71	THR	ASN	conflict	UNP A0A881CR78
B	175	GLY	-	expression tag	UNP A0A881CR78
B	176	SER	-	expression tag	UNP A0A881CR78

Continued on next page...

Continued from previous page...

Chain	Residue	Modelled	Actual	Comment	Reference
B	177	GLY	-	expression tag	UNP A0A881CR78
B	178	TYR	-	expression tag	UNP A0A881CR78
B	179	ILE	-	expression tag	UNP A0A881CR78
B	180	PRO	-	expression tag	UNP A0A881CR78
B	181	GLU	-	expression tag	UNP A0A881CR78
B	182	ALA	-	expression tag	UNP A0A881CR78
B	183	PRO	-	expression tag	UNP A0A881CR78
B	184	ARG	-	expression tag	UNP A0A881CR78
B	185	ASP	-	expression tag	UNP A0A881CR78
B	186	GLY	-	expression tag	UNP A0A881CR78
B	187	GLN	-	expression tag	UNP A0A881CR78
B	188	ALA	-	expression tag	UNP A0A881CR78
B	189	TYR	-	expression tag	UNP A0A881CR78
B	190	VAL	-	expression tag	UNP A0A881CR78
B	191	ARG	-	expression tag	UNP A0A881CR78
B	192	LYS	-	expression tag	UNP A0A881CR78
B	193	ASP	-	expression tag	UNP A0A881CR78
B	194	GLY	-	expression tag	UNP A0A881CR78
B	195	GLU	-	expression tag	UNP A0A881CR78
B	196	TRP	-	expression tag	UNP A0A881CR78
B	197	VAL	-	expression tag	UNP A0A881CR78
B	198	LEU	-	expression tag	UNP A0A881CR78
B	199	LEU	-	expression tag	UNP A0A881CR78
B	200	SER	-	expression tag	UNP A0A881CR78
B	201	THR	-	expression tag	UNP A0A881CR78
B	202	PHE	-	expression tag	UNP A0A881CR78
B	203	LEU	-	expression tag	UNP A0A881CR78
B	204	GLY	-	expression tag	UNP A0A881CR78
B	205	SER	-	expression tag	UNP A0A881CR78
B	206	GLY	-	expression tag	UNP A0A881CR78
B	207	LEU	-	expression tag	UNP A0A881CR78
B	208	ASN	-	expression tag	UNP A0A881CR78
B	209	ASP	-	expression tag	UNP A0A881CR78
B	210	ILE	-	expression tag	UNP A0A881CR78
B	211	PHE	-	expression tag	UNP A0A881CR78
B	212	GLU	-	expression tag	UNP A0A881CR78
B	213	ALA	-	expression tag	UNP A0A881CR78
B	214	GLN	-	expression tag	UNP A0A881CR78
B	215	LYS	-	expression tag	UNP A0A881CR78
B	216	ILE	-	expression tag	UNP A0A881CR78
B	217	GLU	-	expression tag	UNP A0A881CR78
B	218	TRP	-	expression tag	UNP A0A881CR78

Continued on next page...

Continued from previous page...

Chain	Residue	Modelled	Actual	Comment	Reference
B	219	HIS	-	expression tag	UNP A0A881CR78
B	220	GLU	-	expression tag	UNP A0A881CR78
B	221	GLY	-	expression tag	UNP A0A881CR78
B	222	HIS	-	expression tag	UNP A0A881CR78
B	223	HIS	-	expression tag	UNP A0A881CR78
B	224	HIS	-	expression tag	UNP A0A881CR78
B	225	HIS	-	expression tag	UNP A0A881CR78
B	226	HIS	-	expression tag	UNP A0A881CR78
B	227	HIS	-	expression tag	UNP A0A881CR78
D	71	THR	ASN	conflict	UNP A0A881CR78
D	175	GLY	-	expression tag	UNP A0A881CR78
D	176	SER	-	expression tag	UNP A0A881CR78
D	177	GLY	-	expression tag	UNP A0A881CR78
D	178	TYR	-	expression tag	UNP A0A881CR78
D	179	ILE	-	expression tag	UNP A0A881CR78
D	180	PRO	-	expression tag	UNP A0A881CR78
D	181	GLU	-	expression tag	UNP A0A881CR78
D	182	ALA	-	expression tag	UNP A0A881CR78
D	183	PRO	-	expression tag	UNP A0A881CR78
D	184	ARG	-	expression tag	UNP A0A881CR78
D	185	ASP	-	expression tag	UNP A0A881CR78
D	186	GLY	-	expression tag	UNP A0A881CR78
D	187	GLN	-	expression tag	UNP A0A881CR78
D	188	ALA	-	expression tag	UNP A0A881CR78
D	189	TYR	-	expression tag	UNP A0A881CR78
D	190	VAL	-	expression tag	UNP A0A881CR78
D	191	ARG	-	expression tag	UNP A0A881CR78
D	192	LYS	-	expression tag	UNP A0A881CR78
D	193	ASP	-	expression tag	UNP A0A881CR78
D	194	GLY	-	expression tag	UNP A0A881CR78
D	195	GLU	-	expression tag	UNP A0A881CR78
D	196	TRP	-	expression tag	UNP A0A881CR78
D	197	VAL	-	expression tag	UNP A0A881CR78
D	198	LEU	-	expression tag	UNP A0A881CR78
D	199	LEU	-	expression tag	UNP A0A881CR78
D	200	SER	-	expression tag	UNP A0A881CR78
D	201	THR	-	expression tag	UNP A0A881CR78
D	202	PHE	-	expression tag	UNP A0A881CR78
D	203	LEU	-	expression tag	UNP A0A881CR78
D	204	GLY	-	expression tag	UNP A0A881CR78
D	205	SER	-	expression tag	UNP A0A881CR78
D	206	GLY	-	expression tag	UNP A0A881CR78

Continued on next page...

Continued from previous page...

Chain	Residue	Modelled	Actual	Comment	Reference
D	207	LEU	-	expression tag	UNP A0A881CR78
D	208	ASN	-	expression tag	UNP A0A881CR78
D	209	ASP	-	expression tag	UNP A0A881CR78
D	210	ILE	-	expression tag	UNP A0A881CR78
D	211	PHE	-	expression tag	UNP A0A881CR78
D	212	GLU	-	expression tag	UNP A0A881CR78
D	213	ALA	-	expression tag	UNP A0A881CR78
D	214	GLN	-	expression tag	UNP A0A881CR78
D	215	LYS	-	expression tag	UNP A0A881CR78
D	216	ILE	-	expression tag	UNP A0A881CR78
D	217	GLU	-	expression tag	UNP A0A881CR78
D	218	TRP	-	expression tag	UNP A0A881CR78
D	219	HIS	-	expression tag	UNP A0A881CR78
D	220	GLU	-	expression tag	UNP A0A881CR78
D	221	GLY	-	expression tag	UNP A0A881CR78
D	222	HIS	-	expression tag	UNP A0A881CR78
D	223	HIS	-	expression tag	UNP A0A881CR78
D	224	HIS	-	expression tag	UNP A0A881CR78
D	225	HIS	-	expression tag	UNP A0A881CR78
D	226	HIS	-	expression tag	UNP A0A881CR78
D	227	HIS	-	expression tag	UNP A0A881CR78
F	71	THR	ASN	conflict	UNP A0A881CR78
F	175	GLY	-	expression tag	UNP A0A881CR78
F	176	SER	-	expression tag	UNP A0A881CR78
F	177	GLY	-	expression tag	UNP A0A881CR78
F	178	TYR	-	expression tag	UNP A0A881CR78
F	179	ILE	-	expression tag	UNP A0A881CR78
F	180	PRO	-	expression tag	UNP A0A881CR78
F	181	GLU	-	expression tag	UNP A0A881CR78
F	182	ALA	-	expression tag	UNP A0A881CR78
F	183	PRO	-	expression tag	UNP A0A881CR78
F	184	ARG	-	expression tag	UNP A0A881CR78
F	185	ASP	-	expression tag	UNP A0A881CR78
F	186	GLY	-	expression tag	UNP A0A881CR78
F	187	GLN	-	expression tag	UNP A0A881CR78
F	188	ALA	-	expression tag	UNP A0A881CR78
F	189	TYR	-	expression tag	UNP A0A881CR78
F	190	VAL	-	expression tag	UNP A0A881CR78
F	191	ARG	-	expression tag	UNP A0A881CR78
F	192	LYS	-	expression tag	UNP A0A881CR78
F	193	ASP	-	expression tag	UNP A0A881CR78
F	194	GLY	-	expression tag	UNP A0A881CR78

Continued on next page...

Continued from previous page...

Chain	Residue	Modelled	Actual	Comment	Reference
F	195	GLU	-	expression tag	UNP A0A881CR78
F	196	TRP	-	expression tag	UNP A0A881CR78
F	197	VAL	-	expression tag	UNP A0A881CR78
F	198	LEU	-	expression tag	UNP A0A881CR78
F	199	LEU	-	expression tag	UNP A0A881CR78
F	200	SER	-	expression tag	UNP A0A881CR78
F	201	THR	-	expression tag	UNP A0A881CR78
F	202	PHE	-	expression tag	UNP A0A881CR78
F	203	LEU	-	expression tag	UNP A0A881CR78
F	204	GLY	-	expression tag	UNP A0A881CR78
F	205	SER	-	expression tag	UNP A0A881CR78
F	206	GLY	-	expression tag	UNP A0A881CR78
F	207	LEU	-	expression tag	UNP A0A881CR78
F	208	ASN	-	expression tag	UNP A0A881CR78
F	209	ASP	-	expression tag	UNP A0A881CR78
F	210	ILE	-	expression tag	UNP A0A881CR78
F	211	PHE	-	expression tag	UNP A0A881CR78
F	212	GLU	-	expression tag	UNP A0A881CR78
F	213	ALA	-	expression tag	UNP A0A881CR78
F	214	GLN	-	expression tag	UNP A0A881CR78
F	215	LYS	-	expression tag	UNP A0A881CR78
F	216	ILE	-	expression tag	UNP A0A881CR78
F	217	GLU	-	expression tag	UNP A0A881CR78
F	218	TRP	-	expression tag	UNP A0A881CR78
F	219	HIS	-	expression tag	UNP A0A881CR78
F	220	GLU	-	expression tag	UNP A0A881CR78
F	221	GLY	-	expression tag	UNP A0A881CR78
F	222	HIS	-	expression tag	UNP A0A881CR78
F	223	HIS	-	expression tag	UNP A0A881CR78
F	224	HIS	-	expression tag	UNP A0A881CR78
F	225	HIS	-	expression tag	UNP A0A881CR78
F	226	HIS	-	expression tag	UNP A0A881CR78
F	227	HIS	-	expression tag	UNP A0A881CR78

- Molecule 3 is a protein called H7D28 pFab HC Fv_polyA.

Mol	Chain	Residues	Atoms			AltConf	Trace	
			Total	C	N			O
3	G	126	630	378	126	126	0	0

- Molecule 4 is a protein called H7D28 pFab LC Fv_polyA.

Mol	Chain	Residues	Atoms				AltConf	Trace
			Total	C	N	O		
4	H	108	540	324	108	108	0	0

- Molecule 5 is an oligosaccharide called 2-acetamido-2-deoxy-beta-D-glucopyranose-(1-3)-2-acetamido-2-deoxy-beta-D-glucopyranose.



Mol	Chain	Residues	Atoms				AltConf	Trace
			Total	C	N	O		
5	I	2	28	16	2	10	0	0

- Molecule 6 is an oligosaccharide called 2-acetamido-2-deoxy-beta-D-glucopyranose-(1-4)-2-acetamido-2-deoxy-beta-D-glucopyranose.



Mol	Chain	Residues	Atoms				AltConf	Trace
			Total	C	N	O		
6	J	2	28	16	2	10	0	0
6	K	2	28	16	2	10	0	0

- Molecule 7 is 2-acetamido-2-deoxy-beta-D-glucopyranose (three-letter code: NAG) (formula: C₈H₁₅NO₆).



Mol	Chain	Residues	Atoms				AltConf
			Total	C	N	O	
7	A	1	Total 14	C 8	N 1	O 5	0
7	A	1	Total 14	C 8	N 1	O 5	0
7	B	1	Total 14	C 8	N 1	O 5	0
7	C	1	Total 14	C 8	N 1	O 5	0
7	C	1	Total 14	C 8	N 1	O 5	0
7	D	1	Total 14	C 8	N 1	O 5	0
7	E	1	Total 14	C 8	N 1	O 5	0
7	E	1	Total 14	C 8	N 1	O 5	0
7	F	1	Total 14	C 8	N 1	O 5	0

3 Residue-property plots [i](#)

These plots are drawn for all protein, RNA, DNA and oligosaccharide chains in the entry. The first graphic for a chain summarises the proportions of the various outlier classes displayed in the second graphic. The second graphic shows the sequence view annotated by issues in geometry and atom inclusion in map density. Residues are color-coded according to the number of geometric quality criteria for which they contain at least one outlier: green = 0, yellow = 1, orange = 2 and red = 3 or more. A red diamond above a residue indicates a poor fit to the EM map for this residue (all-atom inclusion < 40%). Stretches of 2 or more consecutive residues without any outlier are shown as a green connector. Residues present in the sample, but not in the model, are shown in grey.

- Molecule 1: Hemagglutinin HA1 chain

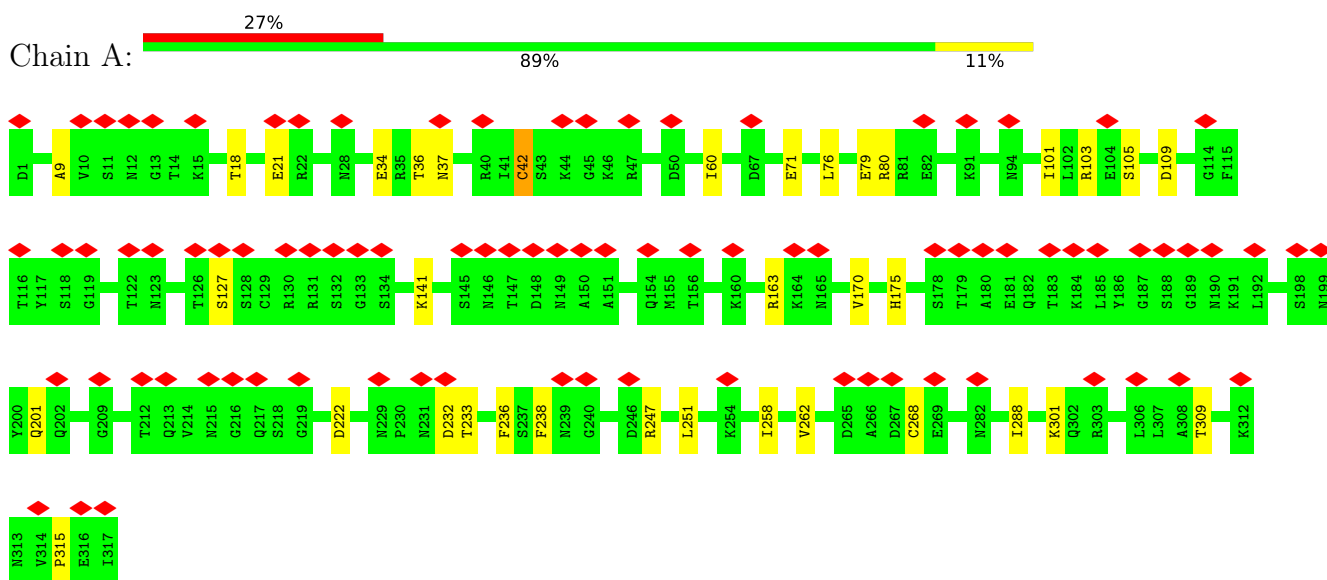

- Molecule 1: Hemagglutinin HA1 chain

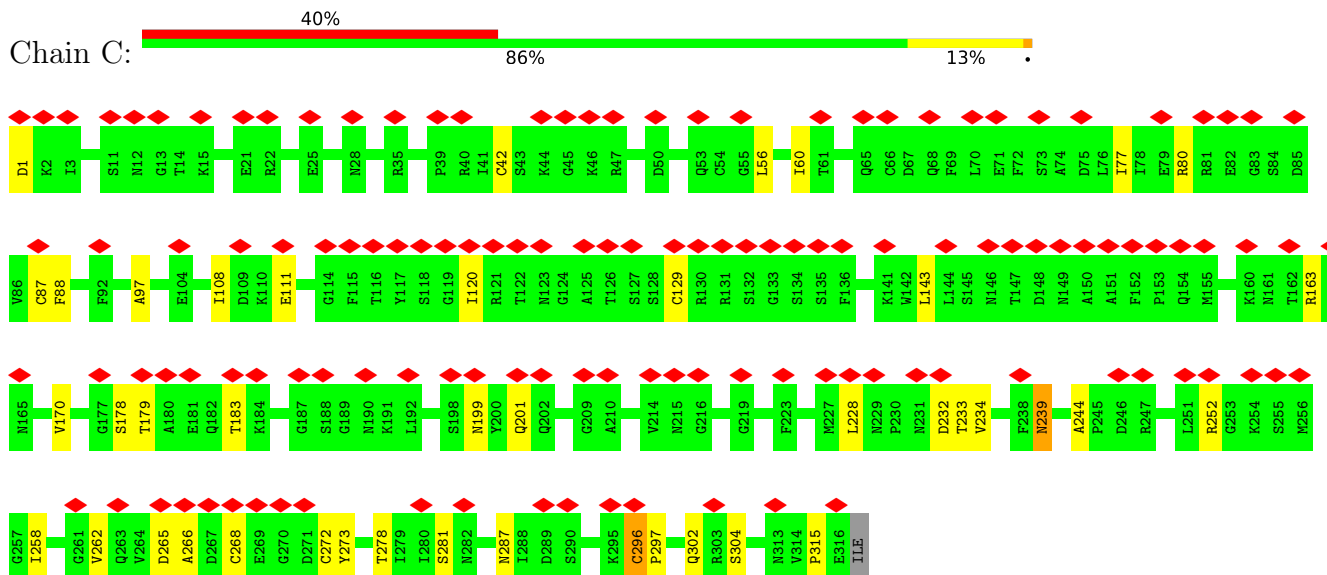

- Molecule 1: Hemagglutinin HA1 chain

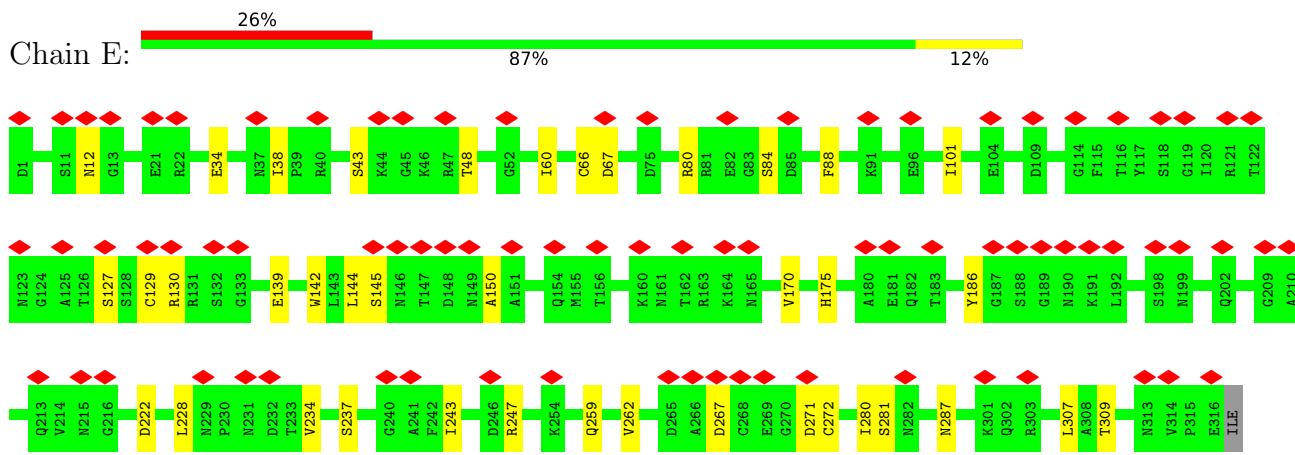

• Molecule 2: Hemagglutinin HA2 chain

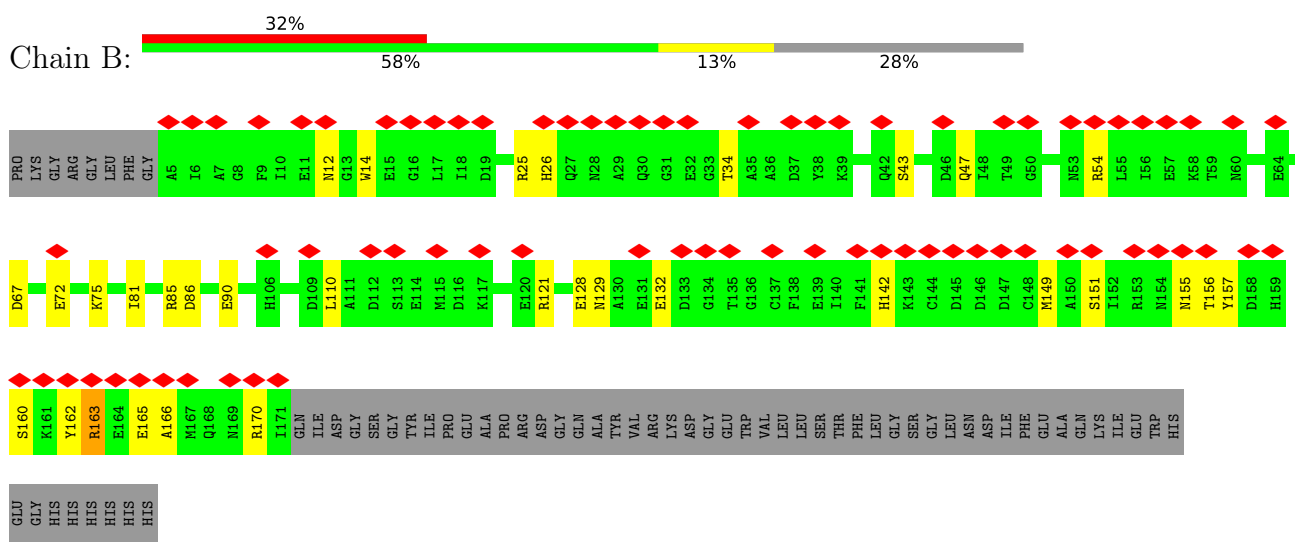

• Molecule 2: Hemagglutinin HA2 chain

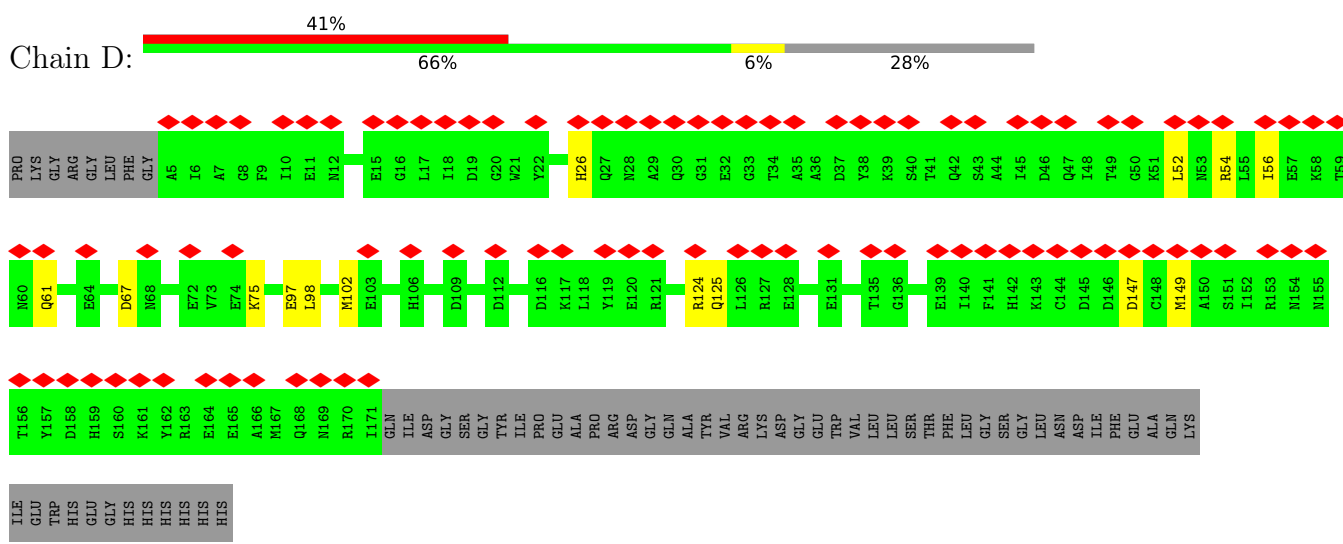

• Molecule 2: Hemagglutinin HA2 chain

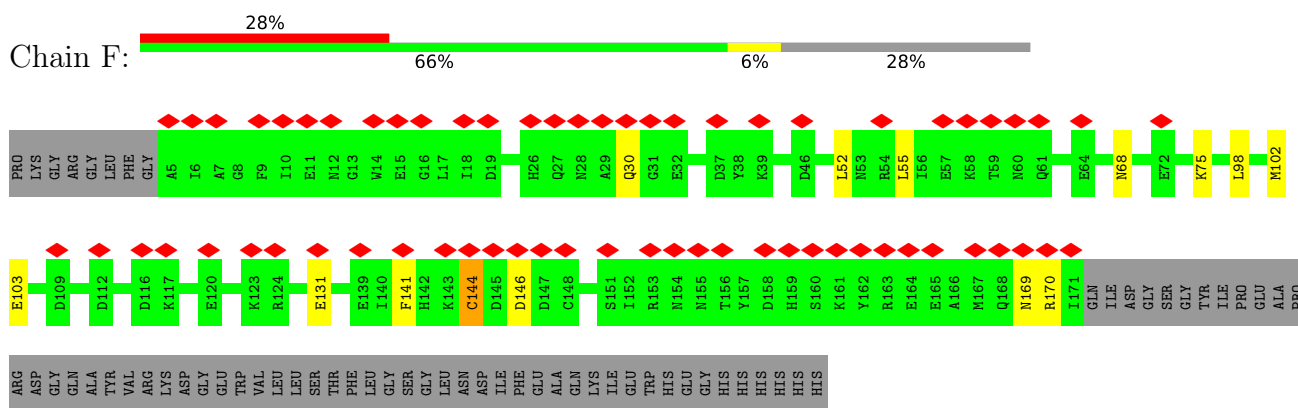

- Molecule 3: H7D28 pFab HC Fv_polyA

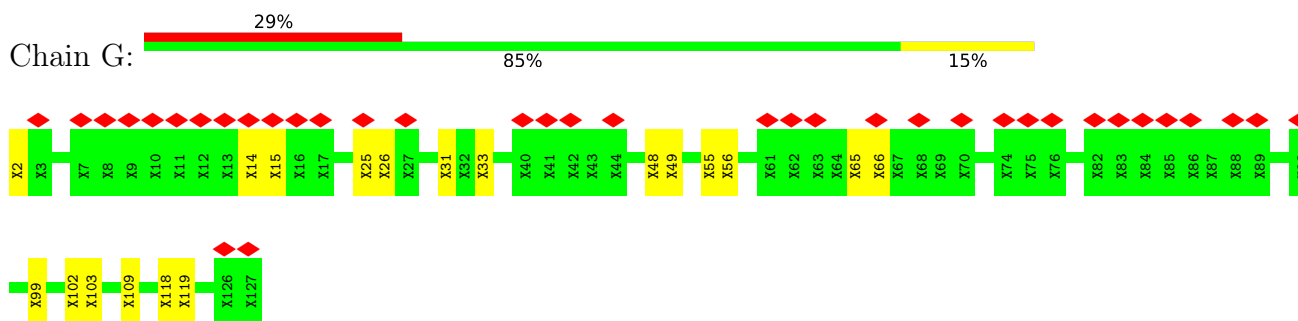

- Molecule 4: H7D28 pFab LC Fv_polyA

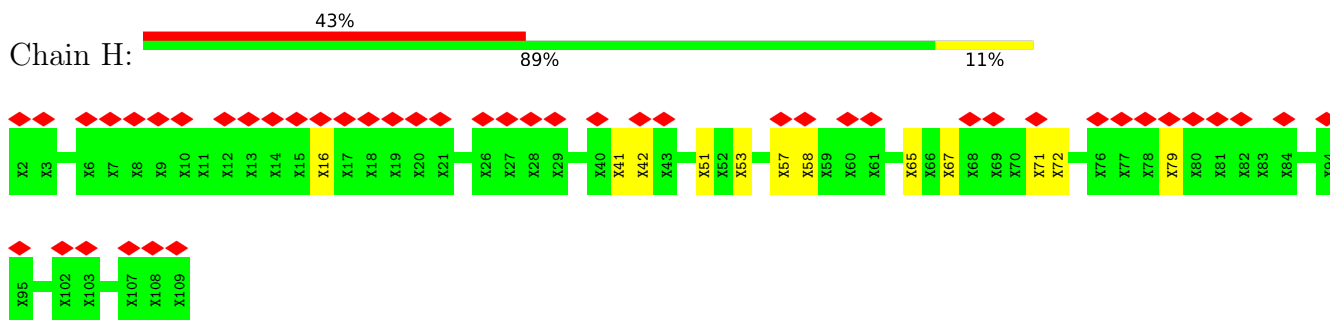

- Molecule 5: 2-acetamido-2-deoxy-beta-D-glucopyranose-(1-3)-2-acetamido-2-deoxy-beta-D-glucopyranose

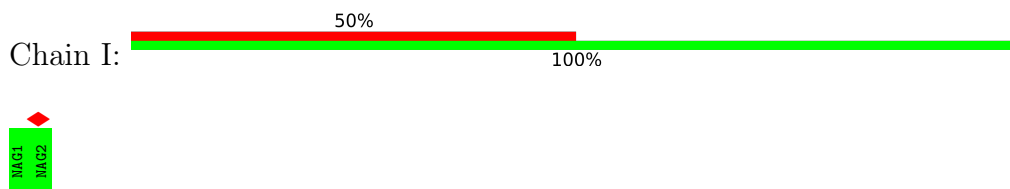

- Molecule 6: 2-acetamido-2-deoxy-beta-D-glucopyranose-(1-4)-2-acetamido-2-deoxy-beta-D-glucopyranose





- Molecule 6: 2-acetamido-2-deoxy-beta-D-glucopyranose-(1-4)-2-acetamido-2-deoxy-beta-D-glucopyranose



4 Experimental information

Property	Value	Source
EM reconstruction method	SINGLE PARTICLE	Depositor
Imposed symmetry	POINT, C1	Depositor
Number of particles used	183753	Depositor
Resolution determination method	FSC 0.143 CUT-OFF	Depositor
CTF correction method	PHASE FLIPPING AND AMPLITUDE CORRECTION	Depositor
Microscope	TFS GLACIOS	Depositor
Voltage (kV)	200	Depositor
Electron dose ($e^-/\text{\AA}^2$)	50	Depositor
Minimum defocus (nm)	700	Depositor
Maximum defocus (nm)	1500	Depositor
Magnification	Not provided	
Image detector	FEI FALCON IV (4k x 4k)	Depositor
Maximum map value	0.734	Depositor
Minimum map value	-0.494	Depositor
Average map value	0.000	Depositor
Map value standard deviation	0.016	Depositor
Recommended contour level	0.17	Depositor
Map size (Å)	319.0, 319.0, 319.0	wwPDB
Map dimensions	440, 440, 440	wwPDB
Map angles (°)	90.0, 90.0, 90.0	wwPDB
Pixel spacing (Å)	0.725, 0.725, 0.725	Depositor

5 Model quality [i](#)

5.1 Standard geometry [i](#)

Bond lengths and bond angles in the following residue types are not validated in this section: NAG

The Z score for a bond length (or angle) is the number of standard deviations the observed value is removed from the expected value. A bond length (or angle) with $|Z| > 5$ is considered an outlier worth inspection. RMSZ is the root-mean-square of all Z scores of the bond lengths (or angles).

Mol	Chain	Bond lengths		Bond angles	
		RMSZ	# Z >5	RMSZ	# Z >5
1	A	0.35	0/2467	0.75	1/3332 (0.0%)
1	C	0.36	0/2459	0.78	2/3321 (0.1%)
1	E	0.35	0/2459	0.72	0/3321
2	B	0.34	0/1382	0.70	0/1863
2	D	0.31	0/1382	0.65	0/1863
2	F	0.33	0/1382	0.69	1/1863 (0.1%)
All	All	0.35	0/11531	0.73	4/15563 (0.0%)

Chiral center outliers are detected by calculating the chiral volume of a chiral center and verifying if the center is modelled as a planar moiety or with the opposite hand. A planarity outlier is detected by checking planarity of atoms in a peptide group, atoms in a mainchain group or atoms of a sidechain that are expected to be planar.

Mol	Chain	#Chirality outliers	#Planarity outliers
2	B	0	1

There are no bond length outliers.

All (4) bond angle outliers are listed below:

Mol	Chain	Res	Type	Atoms	Z	Observed(°)	Ideal(°)
1	C	296	CYS	CA-CB-SG	10.11	132.20	114.00
1	A	42	CYS	CA-CB-SG	7.96	128.33	114.00
1	C	315	PRO	CA-N-CD	-7.80	100.58	111.50
2	F	144	CYS	CA-CB-SG	5.81	124.46	114.00

There are no chirality outliers.

All (1) planarity outliers are listed below:

Mol	Chain	Res	Type	Group
2	B	163	ARG	Sidechain

5.2 Too-close contacts [i](#)

In the following table, the Non-H and H(model) columns list the number of non-hydrogen atoms and hydrogen atoms in the chain respectively. The H(added) column lists the number of hydrogen atoms added and optimized by MolProbity. The Clashes column lists the number of clashes within the asymmetric unit, whereas Symm-Clashes lists symmetry-related clashes.

Mol	Chain	Non-H	H(model)	H(added)	Clashes	Symm-Clashes
1	A	2422	0	2378	26	0
1	C	2414	0	2365	23	0
1	E	2414	0	2364	25	0
2	B	1359	0	1263	32	0
2	D	1359	0	1263	7	0
2	F	1359	0	1262	12	0
3	G	630	0	135	13	0
4	H	540	0	117	7	0
5	I	28	0	25	0	0
6	J	28	0	25	0	0
6	K	28	0	25	0	0
7	A	28	0	26	0	0
7	B	14	0	13	0	0
7	C	28	0	26	0	0
7	D	14	0	13	0	0
7	E	28	0	26	0	0
7	F	14	0	13	0	0
All	All	12707	0	11339	128	0

The all-atom clashscore is defined as the number of clashes found per 1000 atoms (including hydrogen atoms). The all-atom clashscore for this structure is 5.

All (128) close contacts within the same asymmetric unit are listed below, sorted by their clash magnitude.

Atom-1	Atom-2	Interatomic distance (Å)	Clash overlap (Å)
1:A:201:GLN:NE2	1:E:222:ASP:OD1	1.68	1.26
2:B:67:ASP:OD2	2:B:85:ARG:NH2	1.89	1.05
4:H:67:UNK:CB	4:H:72:UNK:HA	1.90	1.02
3:G:2:UNK:HA	3:G:26:UNK:CB	1.90	1.01
2:B:129:ASN:HA	2:B:166:ALA:HB1	1.53	0.91
2:B:129:ASN:HA	2:B:166:ALA:CB	2.04	0.86

Continued on next page...

Continued from previous page...

Atom-1	Atom-2	Interatomic distance (Å)	Clash overlap (Å)
1:E:175:HIS:NE2	1:E:222:ASP:OD2	2.14	0.80
3:G:2:UNK:CA	3:G:26:UNK:CB	2.59	0.80
2:B:162:TYR:O	2:B:165:GLU:HB2	1.87	0.75
2:B:132:GLU:OE2	2:D:124:ARG:NE	2.20	0.74
2:B:67:ASP:CG	2:B:85:ARG:HH22	1.90	0.74
2:B:128:GLU:HB3	2:B:163:ARG:HH22	1.51	0.74
1:A:42:CYS:SG	1:A:268:CYS:HB2	2.29	0.73
1:A:42:CYS:HB3	1:A:268:CYS:HB2	1.70	0.72
1:C:265:ASP:OD1	1:C:266:ALA:N	2.22	0.71
2:B:67:ASP:OD1	2:B:81:ILE:HG21	1.91	0.71
1:E:43:SER:OG	1:E:48:THR:OG1	2.06	0.70
4:H:53:UNK:HA	4:H:65:UNK:O	1.91	0.70
2:B:160:SER:HA	2:B:163:ARG:HG3	1.74	0.69
3:G:109:UNK:CB	4:H:51:UNK:CB	2.72	0.68
2:B:129:ASN:OD1	2:B:166:ALA:HB3	1.93	0.68
2:B:26:HIS:ND1	2:B:149:MET:SD	2.67	0.67
3:G:2:UNK:N	3:G:26:UNK:CB	2.58	0.66
1:A:42:CYS:CB	1:A:268:CYS:HB2	2.25	0.66
3:G:65:UNK:O	3:G:66:UNK:CB	2.44	0.65
2:B:121:ARG:NH1	2:B:155:ASN:OD1	2.29	0.63
4:H:57:UNK:O	4:H:58:UNK:CB	2.47	0.63
1:E:127:SER:O	1:E:130:ARG:NH1	2.32	0.63
2:B:142:HIS:ND1	2:B:142:HIS:O	2.32	0.62
3:G:14:UNK:O	3:G:15:UNK:CB	2.48	0.62
4:H:41:UNK:O	4:H:42:UNK:CB	2.48	0.61
2:B:128:GLU:O	2:B:170:ARG:NH1	2.33	0.61
2:B:162:TYR:O	2:B:165:GLU:N	2.32	0.61
1:C:232:ASP:OD1	1:C:233:THR:N	2.34	0.61
1:A:232:ASP:OD1	1:A:233:THR:N	2.35	0.60
1:A:222:ASP:OD1	1:C:201:GLN:NE2	2.35	0.59
1:C:120:ILE:HG21	1:C:143:LEU:HD23	1.84	0.58
1:C:80:ARG:NH1	1:C:262:VAL:O	2.34	0.58
1:A:42:CYS:HG	1:A:268:CYS:CB	2.16	0.58
1:A:71:GLU:OE2	1:A:247:ARG:NH1	2.36	0.58
2:B:47:GLN:OE1	2:B:110:LEU:HD11	2.04	0.58
1:A:34:GLU:OE2	1:A:36:THR:OG1	2.17	0.57
1:E:259:GLN:NE2	2:F:68:ASN:OD1	2.36	0.57
1:C:108:ILE:O	1:C:252:ARG:NH2	2.36	0.57
2:F:55:LEU:HD21	2:F:103:GLU:HG3	1.87	0.55
2:B:72:GLU:OE1	2:B:75:LYS:NZ	2.38	0.55
1:A:42:CYS:HG	1:A:268:CYS:HB2	1.72	0.55

Continued on next page...

Continued from previous page...

Atom-1	Atom-2	Interatomic distance (Å)	Clash overlap (Å)
2:D:75:LYS:HG3	1:E:101:ILE:HD11	1.89	0.55
1:A:36:THR:O	1:A:37:ASN:ND2	2.40	0.55
2:B:67:ASP:OD2	2:B:85:ARG:CZ	2.54	0.55
2:F:131:GLU:OE1	2:F:170:ARG:NH2	2.39	0.54
1:E:60:ILE:HG21	1:E:170:VAL:HG21	1.88	0.54
1:E:287:ASN:O	1:E:287:ASN:ND2	2.41	0.54
2:B:166:ALA:O	2:B:170:ARG:HD3	2.07	0.53
1:C:143:LEU:HD11	1:C:244:ALA:HB2	1.90	0.53
1:C:179:THR:O	1:C:183:THR:HG23	2.08	0.53
1:A:101:ILE:HD11	2:F:75:LYS:HG3	1.89	0.53
1:C:228:LEU:HD22	1:C:234:VAL:HG23	1.91	0.53
1:E:67:ASP:N	1:E:67:ASP:OD1	2.42	0.53
3:G:55:UNK:O	3:G:56:UNK:CB	2.56	0.53
3:G:118:UNK:O	3:G:119:UNK:C	2.56	0.53
3:G:25:UNK:O	3:G:26:UNK:CB	2.56	0.52
1:A:9:ALA:N	2:B:14:TRP:O	2.42	0.52
1:C:111:GLU:OE2	1:C:163:ARG:NH2	2.43	0.52
2:D:26:HIS:ND1	2:D:149:MET:SD	2.84	0.51
1:E:228:LEU:HD13	1:E:234:VAL:HG23	1.93	0.51
1:C:302:GLN:NE2	2:D:97:GLU:OE2	2.42	0.50
2:B:151:SER:OG	2:B:156:THR:O	2.28	0.50
1:A:18:THR:OG1	1:A:21:GLU:O	2.27	0.50
1:A:315:PRO:O	2:B:12:ASN:ND2	2.43	0.50
2:B:128:GLU:HB3	2:B:163:ARG:NH2	2.24	0.50
1:A:105:SER:HB2	1:A:251:LEU:HD22	1.94	0.50
1:E:38:ILE:HD11	1:E:280:ILE:HD11	1.94	0.49
1:E:80:ARG:NH1	1:E:262:VAL:O	2.42	0.49
2:B:162:TYR:HD1	2:B:165:GLU:OE1	1.97	0.48
2:F:30:GLN:OE1	2:F:30:GLN:N	2.48	0.47
3:G:102:UNK:O	3:G:103:UNK:CB	2.62	0.47
1:E:307:LEU:HD22	2:F:52:LEU:HD21	1.97	0.46
4:H:67:UNK:CB	4:H:71:UNK:O	2.63	0.46
2:B:86:ASP:OD2	2:D:61:GLN:NE2	2.48	0.46
2:F:98:LEU:O	2:F:102:MET:HG2	2.15	0.46
1:E:142:TRP:HE1	1:E:186:TYR:HH	1.62	0.46
1:E:175:HIS:HE2	1:E:222:ASP:CG	2.13	0.46
1:E:271:ASP:OD1	1:E:271:ASP:N	2.48	0.46
2:D:52:LEU:O	2:D:56:ILE:HG23	2.16	0.45
1:E:34:GLU:OE1	1:E:281:SER:OG	2.25	0.45
1:E:139:GLU:OE2	1:E:247:ARG:NH2	2.49	0.45
2:B:25:ARG:HE	2:B:34:THR:HG22	1.82	0.45

Continued on next page...

Continued from previous page...

Atom-1	Atom-2	Interatomic distance (Å)	Clash overlap (Å)
1:A:301:LYS:NZ	2:B:90:GLU:OE2	2.34	0.45
1:C:273:TYR:CD1	1:C:278:THR:HG22	2.52	0.45
2:F:30:GLN:NE2	2:F:146:ASP:OD2	2.50	0.45
1:C:87:CYS:SG	1:C:88:PHE:N	2.90	0.44
1:A:79:GLU:OE2	1:A:103:ARG:NE	2.46	0.44
1:A:109:ASP:OD2	1:A:163:ARG:NH1	2.49	0.44
1:C:258:ILE:HG21	1:C:273:TYR:HB2	1.99	0.44
1:E:309:THR:HG23	2:F:52:LEU:HD11	1.99	0.44
3:G:31:UNK:O	3:G:102:UNK:N	2.50	0.44
1:C:296:CYS:HB2	1:C:297:PRO:HD2	1.99	0.44
1:C:199:ASN:N	1:C:199:ASN:OD1	2.49	0.44
1:A:37:ASN:OD1	1:A:288:ILE:HD13	2.18	0.44
4:H:16:UNK:N	4:H:79:UNK:O	2.51	0.44
1:C:42:CYS:SG	1:C:268:CYS:N	2.91	0.43
1:C:239:ASN:O	1:C:239:ASN:ND2	2.47	0.43
1:A:236:PHE:HB3	1:A:238:PHE:CE1	2.54	0.43
1:E:145:SER:OG	1:E:150:ALA:O	2.29	0.43
1:A:60:ILE:HG21	1:A:170:VAL:HG21	2.00	0.43
1:A:76:LEU:HD11	1:A:258:ILE:CD1	2.48	0.43
2:B:162:TYR:O	2:B:165:GLU:CB	2.63	0.43
1:C:272:CYS:HB2	1:C:296:CYS:HB3	1.59	0.43
1:A:309:THR:O	1:A:309:THR:HG22	2.19	0.42
2:B:142:HIS:NE2	2:B:157:TYR:OH	2.43	0.42
2:F:141:PHE:O	2:F:169:ASN:ND2	2.45	0.42
2:B:75:LYS:HB2	1:C:97:ALA:HB1	2.01	0.42
1:C:60:ILE:HG21	1:C:170:VAL:HG21	2.00	0.42
2:B:129:ASN:CA	2:B:166:ALA:CB	2.89	0.42
2:B:128:GLU:CB	2:B:163:ARG:HH12	2.33	0.42
1:E:43:SER:HG	1:E:48:THR:HG1	1.38	0.42
1:A:175:HIS:NE2	1:A:222:ASP:OD2	2.52	0.41
2:D:98:LEU:HD21	2:F:102:MET:HE1	2.02	0.41
3:G:48:UNK:O	3:G:49:UNK:CB	2.66	0.41
1:C:56:LEU:HD13	1:C:77:ILE:HG21	2.01	0.41
1:E:228:LEU:HD22	1:E:234:VAL:HG23	2.02	0.41
1:E:243:ILE:O	1:E:243:ILE:HG22	2.20	0.41
1:E:307:LEU:HD11	2:F:55:LEU:HD22	2.01	0.41
3:G:33:UNK:O	3:G:99:UNK:N	2.53	0.41
1:C:87:CYS:HB2	1:C:129:CYS:HB3	1.97	0.41
1:A:80:ARG:NH1	1:A:262:VAL:O	2.45	0.40
1:E:88:PHE:N	1:E:129:CYS:SG	2.94	0.40

There are no symmetry-related clashes.

5.3 Torsion angles [i](#)

5.3.1 Protein backbone [i](#)

In the following table, the Percentiles column shows the percent Ramachandran outliers of the chain as a percentile score with respect to all PDB entries followed by that with respect to all EM entries.

The Analysed column shows the number of residues for which the backbone conformation was analysed, and the total number of residues.

Mol	Chain	Analysed	Favoured	Allowed	Outliers	Percentiles	
1	A	315/317 (99%)	305 (97%)	10 (3%)	0	100	100
1	C	314/317 (99%)	302 (96%)	12 (4%)	0	100	100
1	E	314/317 (99%)	305 (97%)	9 (3%)	0	100	100
2	B	165/231 (71%)	161 (98%)	4 (2%)	0	100	100
2	D	165/231 (71%)	161 (98%)	4 (2%)	0	100	100
2	F	165/231 (71%)	161 (98%)	4 (2%)	0	100	100
All	All	1438/1644 (88%)	1395 (97%)	43 (3%)	0	100	100

There are no Ramachandran outliers to report.

5.3.2 Protein sidechains [i](#)

In the following table, the Percentiles column shows the percent sidechain outliers of the chain as a percentile score with respect to all PDB entries followed by that with respect to all EM entries.

The Analysed column shows the number of residues for which the sidechain conformation was analysed, and the total number of residues.

Mol	Chain	Analysed	Rotameric	Outliers	Percentiles	
1	A	266/266 (100%)	264 (99%)	2 (1%)	81	89
1	C	265/266 (100%)	259 (98%)	6 (2%)	50	73
1	E	265/266 (100%)	258 (97%)	7 (3%)	46	71
2	B	144/195 (74%)	142 (99%)	2 (1%)	67	82
2	D	144/195 (74%)	139 (96%)	5 (4%)	36	64
2	F	144/195 (74%)	143 (99%)	1 (1%)	84	90
All	All	1228/1383 (89%)	1205 (98%)	23 (2%)	59	77

All (23) residues with a non-rotameric sidechain are listed below:

Mol	Chain	Res	Type
1	A	127	SER
1	A	141	LYS
2	B	43	SER
2	B	54	ARG
1	C	1	ASP
1	C	178	SER
1	C	239	ASN
1	C	281	SER
1	C	287	ASN
1	C	304	SER
2	D	54	ARG
2	D	67	ASP
2	D	102	MET
2	D	125	GLN
2	D	147	ASP
1	E	12	ASN
1	E	66	CYS
1	E	84	SER
1	E	144	LEU
1	E	237	SER
1	E	267	ASP
1	E	272	CYS
2	F	144	CYS

Sometimes sidechains can be flipped to improve hydrogen bonding and reduce clashes. There are no such sidechains identified.

5.3.3 RNA [i](#)

There are no RNA molecules in this entry.

5.4 Non-standard residues in protein, DNA, RNA chains [i](#)

There are no non-standard protein/DNA/RNA residues in this entry.

5.5 Carbohydrates [i](#)

6 monosaccharides are modelled in this entry.

In the following table, the Counts columns list the number of bonds (or angles) for which Mogul statistics could be retrieved, the number of bonds (or angles) that are observed in the model and the number of bonds (or angles) that are defined in the Chemical Component Dictionary. The Link column lists molecule types, if any, to which the group is linked. The Z score for a bond length (or angle) is the number of standard deviations the observed value is removed from the expected value. A bond length (or angle) with $|Z| > 2$ is considered an outlier worth inspection. RMSZ is the root-mean-square of all Z scores of the bond lengths (or angles).

Mol	Type	Chain	Res	Link	Bond lengths			Bond angles		
					Counts	RMSZ	# Z > 2	Counts	RMSZ	# Z > 2
5	NAG	I	1	2,5	14,14,15	0.16	0	17,19,21	0.67	0
5	NAG	I	2	5	14,14,15	0.30	0	17,19,21	0.65	0
6	NAG	J	1	6,2	14,14,15	0.18	0	17,19,21	0.53	0
6	NAG	J	2	6	14,14,15	0.19	0	17,19,21	0.53	0
6	NAG	K	1	6,2	14,14,15	0.19	0	17,19,21	0.51	0
6	NAG	K	2	6	14,14,15	0.17	0	17,19,21	0.55	0

In the following table, the Chirals column lists the number of chiral outliers, the number of chiral centers analysed, the number of these observed in the model and the number defined in the Chemical Component Dictionary. Similar counts are reported in the Torsion and Rings columns. '-' means no outliers of that kind were identified.

Mol	Type	Chain	Res	Link	Chirals	Torsions	Rings
5	NAG	I	1	2,5	-	1/6/23/26	0/1/1/1
5	NAG	I	2	5	-	0/6/23/26	0/1/1/1
6	NAG	J	1	6,2	-	0/6/23/26	0/1/1/1
6	NAG	J	2	6	-	1/6/23/26	0/1/1/1
6	NAG	K	1	6,2	-	0/6/23/26	0/1/1/1
6	NAG	K	2	6	-	1/6/23/26	0/1/1/1

There are no bond length outliers.

There are no bond angle outliers.

There are no chirality outliers.

All (3) torsion outliers are listed below:

Mol	Chain	Res	Type	Atoms
6	J	2	NAG	O5-C5-C6-O6
6	K	2	NAG	O5-C5-C6-O6
5	I	1	NAG	O5-C5-C6-O6

There are no ring outliers.

No monomer is involved in short contacts.

The following is a two-dimensional graphical depiction of Mogul quality analysis of bond lengths, bond angles, torsion angles, and ring geometry for oligosaccharide.

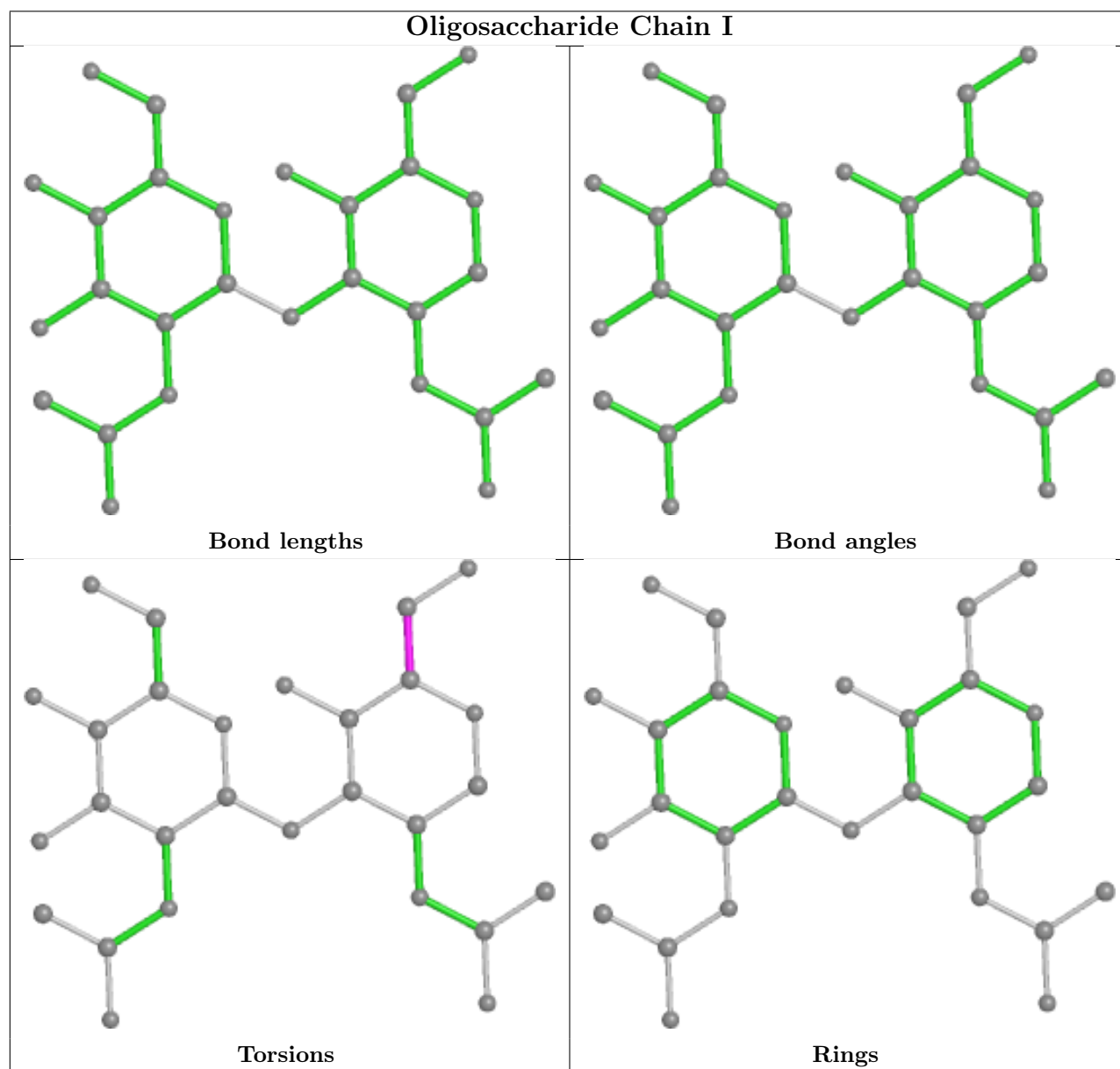

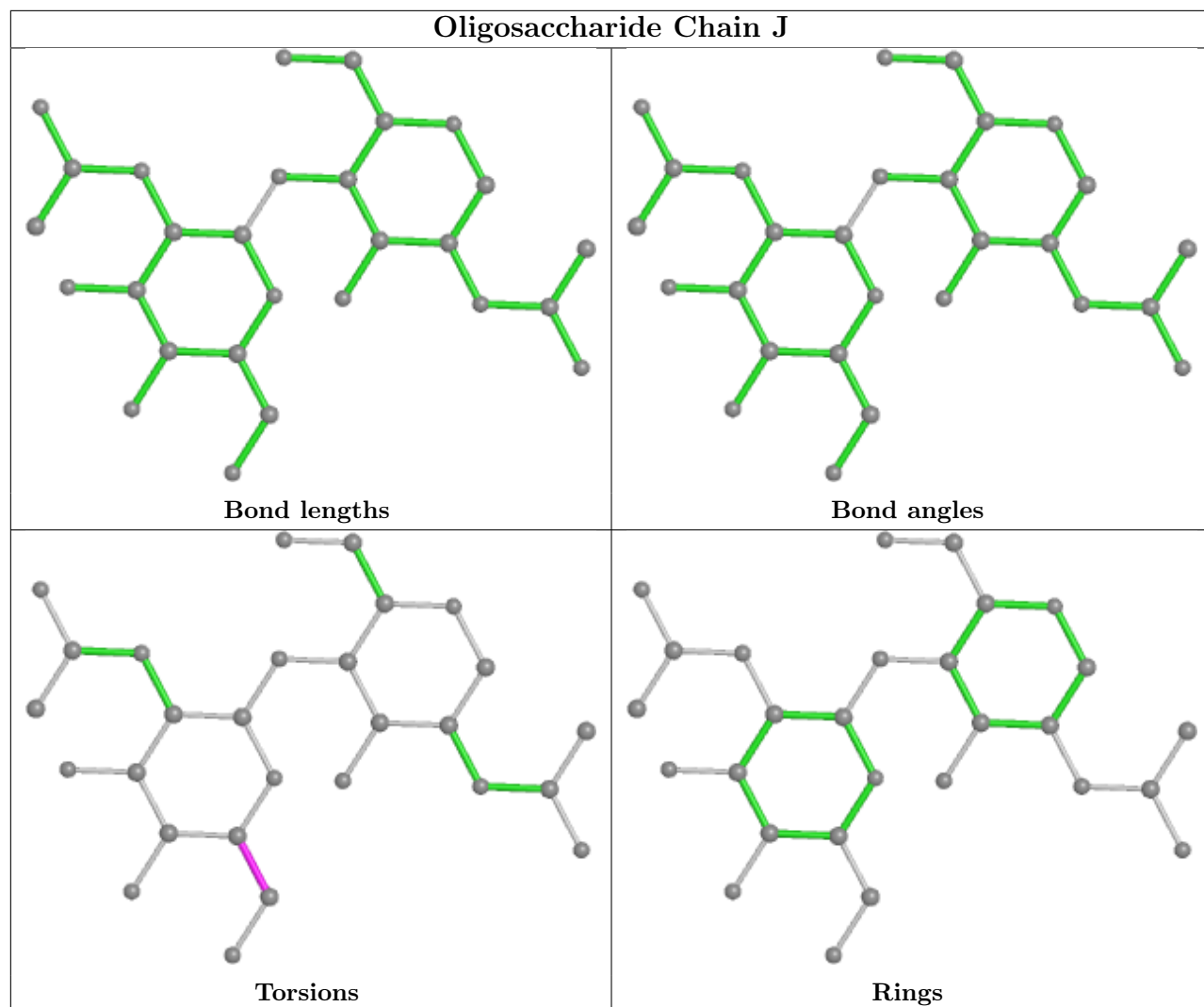

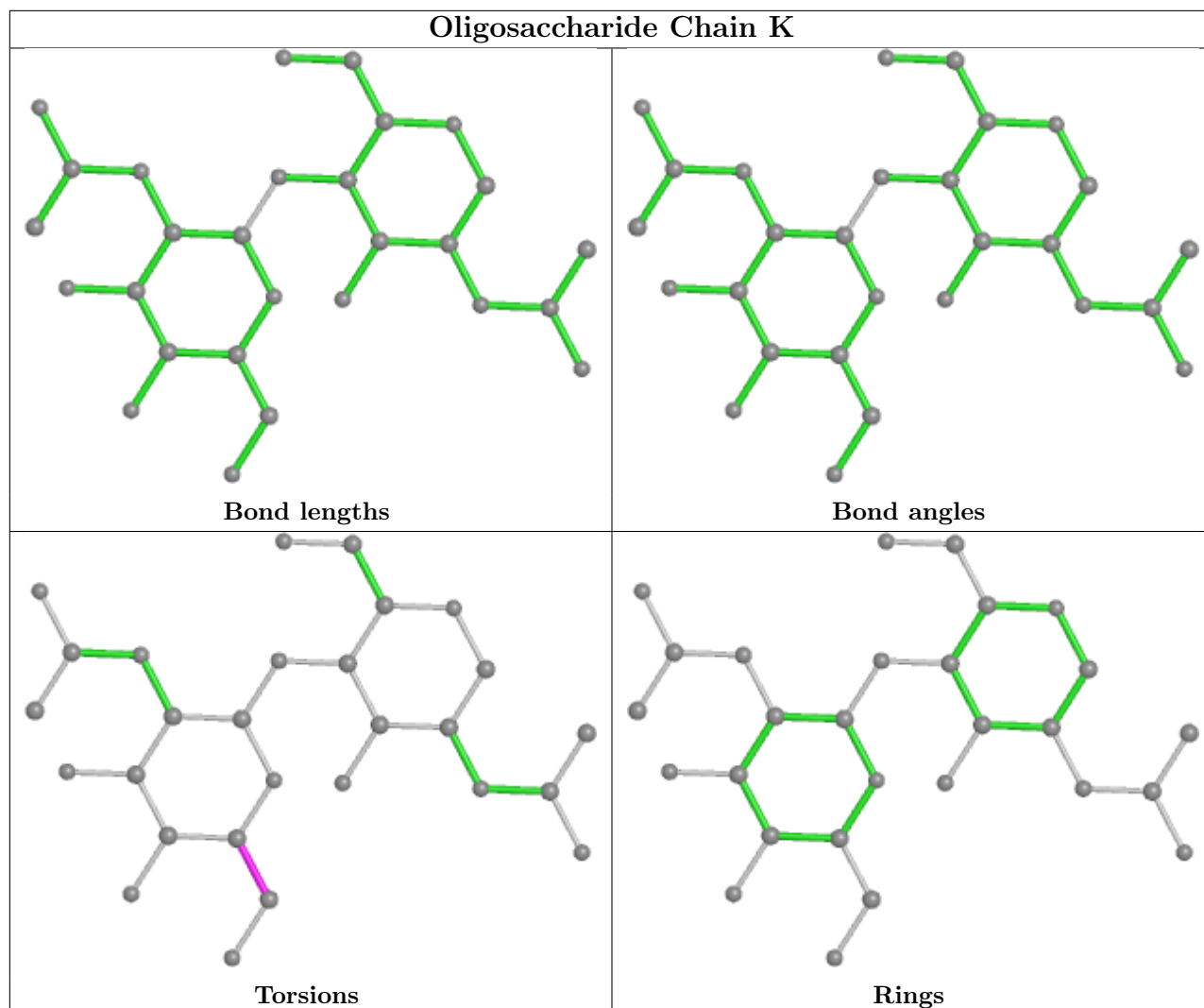

5.6 Ligand geometry [i](#)

9 ligands are modelled in this entry.

In the following table, the Counts columns list the number of bonds (or angles) for which Mogul statistics could be retrieved, the number of bonds (or angles) that are observed in the model and the number of bonds (or angles) that are defined in the Chemical Component Dictionary. The Link column lists molecule types, if any, to which the group is linked. The Z score for a bond length (or angle) is the number of standard deviations the observed value is removed from the expected value. A bond length (or angle) with $|Z| > 2$ is considered an outlier worth inspection. RMSZ is the root-mean-square of all Z scores of the bond lengths (or angles).

Mol	Type	Chain	Res	Link	Bond lengths			Bond angles		
					Counts	RMSZ	$\# Z > 2$	Counts	RMSZ	$\# Z > 2$
7	NAG	C	401	1	14,14,15	0.43	0	17,19,21	0.65	0
7	NAG	B	301	2	14,14,15	0.21	0	17,19,21	0.50	0
7	NAG	F	301	2	14,14,15	0.41	0	17,19,21	0.56	0
7	NAG	E	402	1	14,14,15	0.31	0	17,19,21	0.51	0

Mol	Type	Chain	Res	Link	Bond lengths			Bond angles		
					Counts	RMSZ	# Z > 2	Counts	RMSZ	# Z > 2
7	NAG	E	401	1	14,14,15	0.26	0	17,19,21	0.58	0
7	NAG	A	401	1	14,14,15	0.24	0	17,19,21	0.53	0
7	NAG	A	402	1	14,14,15	0.31	0	17,19,21	0.51	0
7	NAG	C	402	1	14,14,15	0.23	0	17,19,21	0.49	0
7	NAG	D	301	2	14,14,15	0.21	0	17,19,21	0.51	0

In the following table, the Chirals column lists the number of chiral outliers, the number of chiral centers analysed, the number of these observed in the model and the number defined in the Chemical Component Dictionary. Similar counts are reported in the Torsion and Rings columns. '-' means no outliers of that kind were identified.

Mol	Type	Chain	Res	Link	Chirals	Torsions	Rings
7	NAG	C	401	1	-	2/6/23/26	0/1/1/1
7	NAG	B	301	2	-	0/6/23/26	0/1/1/1
7	NAG	F	301	2	-	1/6/23/26	0/1/1/1
7	NAG	E	402	1	-	1/6/23/26	0/1/1/1
7	NAG	E	401	1	-	2/6/23/26	0/1/1/1
7	NAG	A	401	1	-	1/6/23/26	0/1/1/1
7	NAG	A	402	1	-	0/6/23/26	0/1/1/1
7	NAG	C	402	1	-	1/6/23/26	0/1/1/1
7	NAG	D	301	2	-	1/6/23/26	0/1/1/1

There are no bond length outliers.

There are no bond angle outliers.

There are no chirality outliers.

All (9) torsion outliers are listed below:

Mol	Chain	Res	Type	Atoms
7	C	401	NAG	O5-C5-C6-O6
7	E	401	NAG	O5-C5-C6-O6
7	C	401	NAG	C4-C5-C6-O6
7	E	401	NAG	C4-C5-C6-O6
7	F	301	NAG	O5-C5-C6-O6
7	E	402	NAG	O5-C5-C6-O6
7	D	301	NAG	O5-C5-C6-O6
7	C	402	NAG	O5-C5-C6-O6
7	A	401	NAG	O5-C5-C6-O6

There are no ring outliers.

No monomer is involved in short contacts.

5.7 Other polymers [i](#)

There are no such residues in this entry.

5.8 Polymer linkage issues [i](#)

There are no chain breaks in this entry.

6 Map visualisation [i](#)

This section contains visualisations of the EMDB entry EMD-42534. These allow visual inspection of the internal detail of the map and identification of artifacts.

Images derived from a raw map, generated by summing the deposited half-maps, are presented below the corresponding image components of the primary map to allow further visual inspection and comparison with those of the primary map.

6.1 Orthogonal projections [i](#)

6.1.1 Primary map

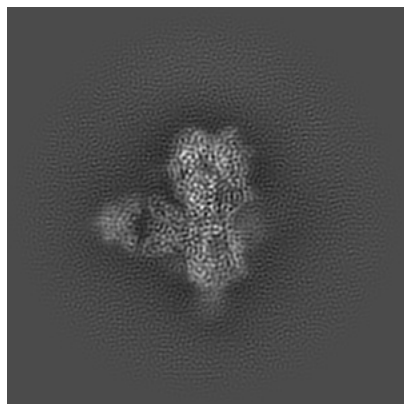

X

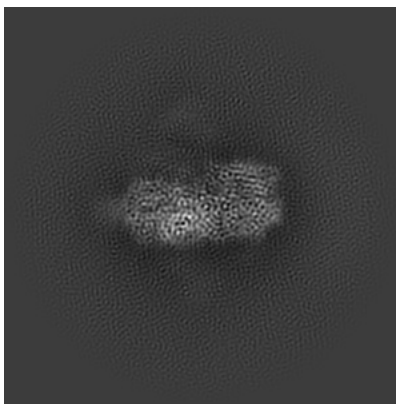

Y

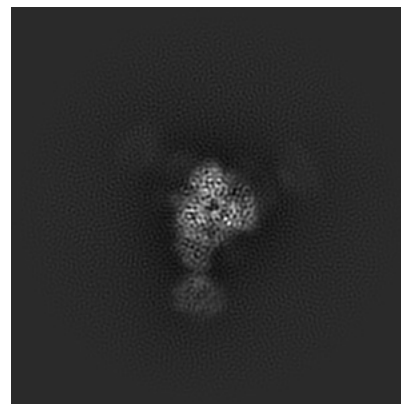

Z

6.1.2 Raw map

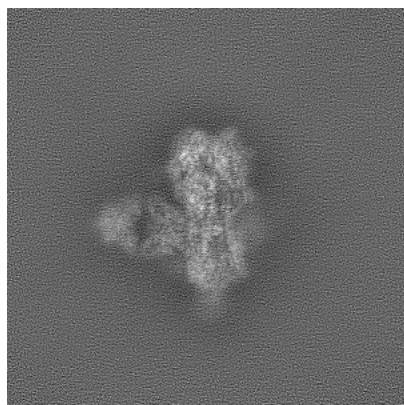

X

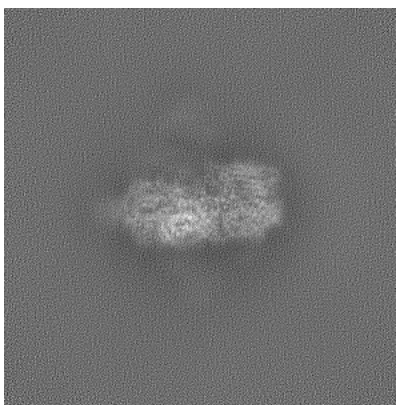

Y

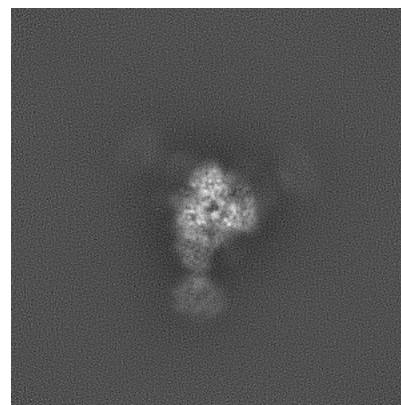

Z

The images above show the map projected in three orthogonal directions.

6.2 Central slices [i](#)

6.2.1 Primary map

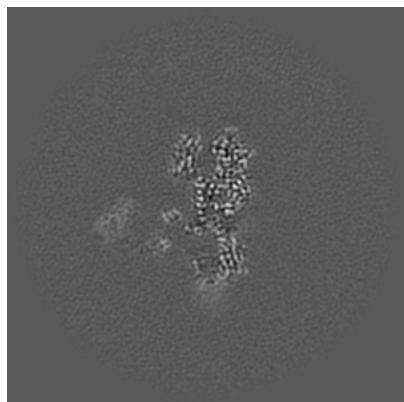

X Index: 220

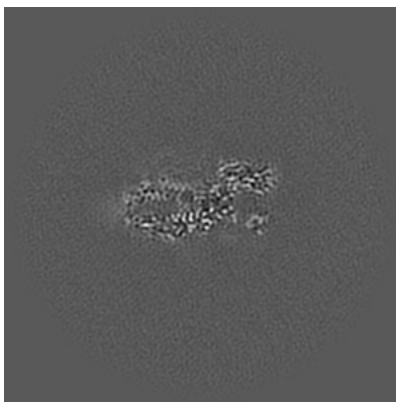

Y Index: 220

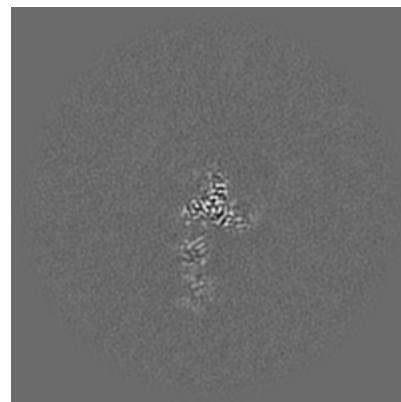

Z Index: 220

6.2.2 Raw map

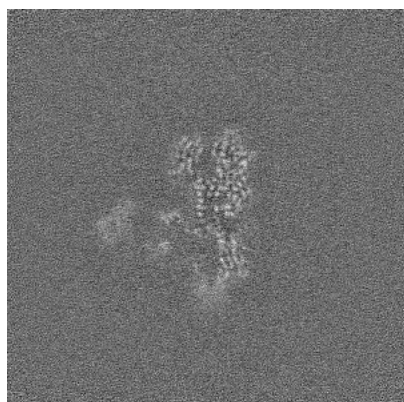

X Index: 220

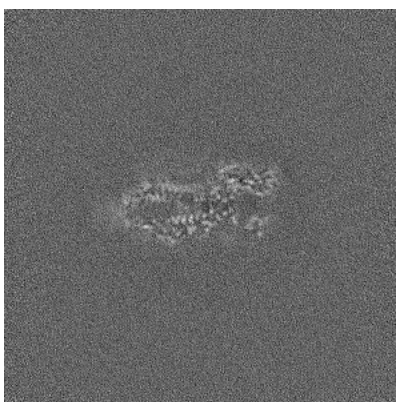

Y Index: 220

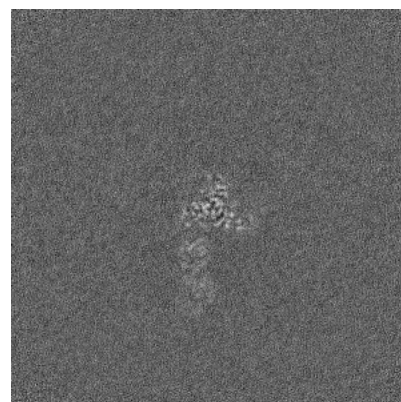

Z Index: 220

The images above show central slices of the map in three orthogonal directions.

6.3 Largest variance slices [i](#)

6.3.1 Primary map

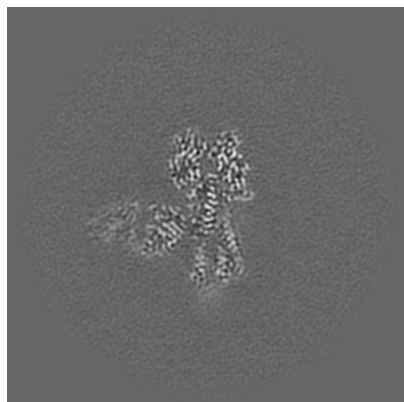

X Index: 212

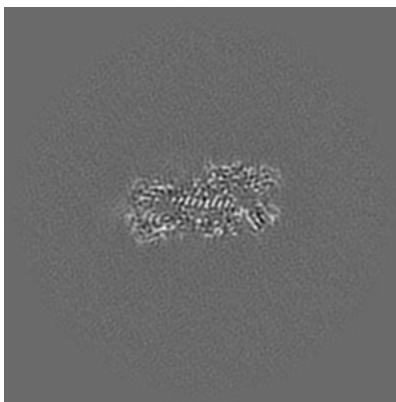

Y Index: 210

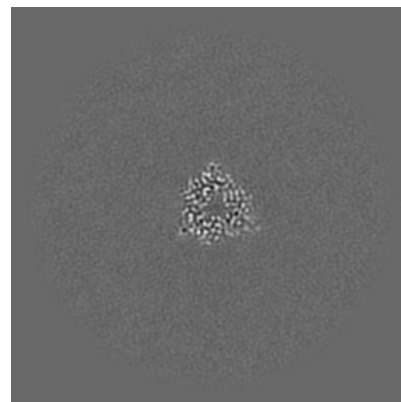

Z Index: 276

6.3.2 Raw map

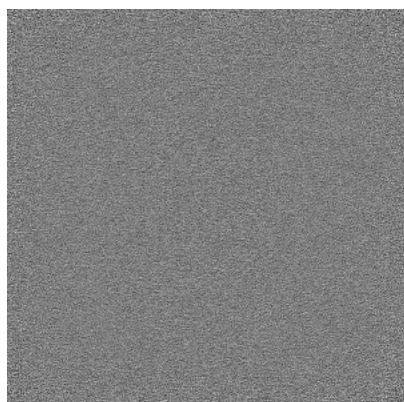

X Index: 0

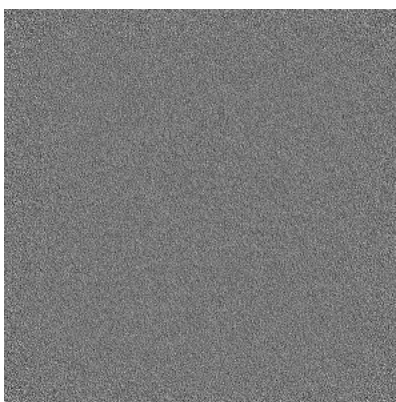

Y Index: 0

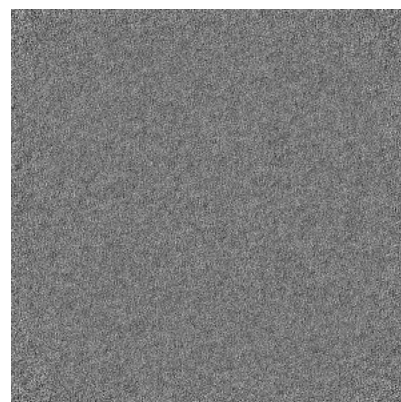

Z Index: 0

The images above show the largest variance slices of the map in three orthogonal directions.

6.4 Orthogonal standard-deviation projections (False-color) [i](#)

6.4.1 Primary map

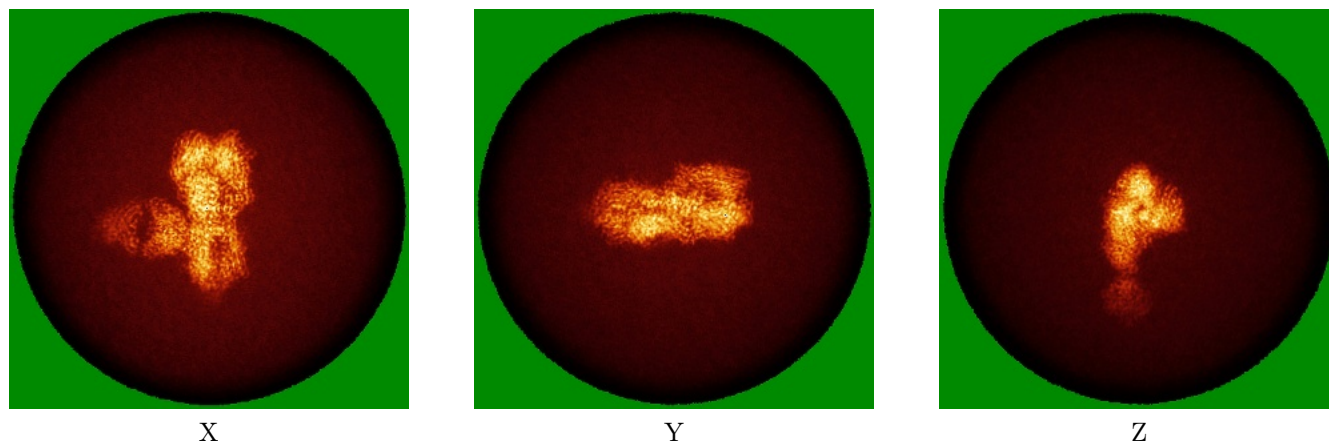

6.4.2 Raw map

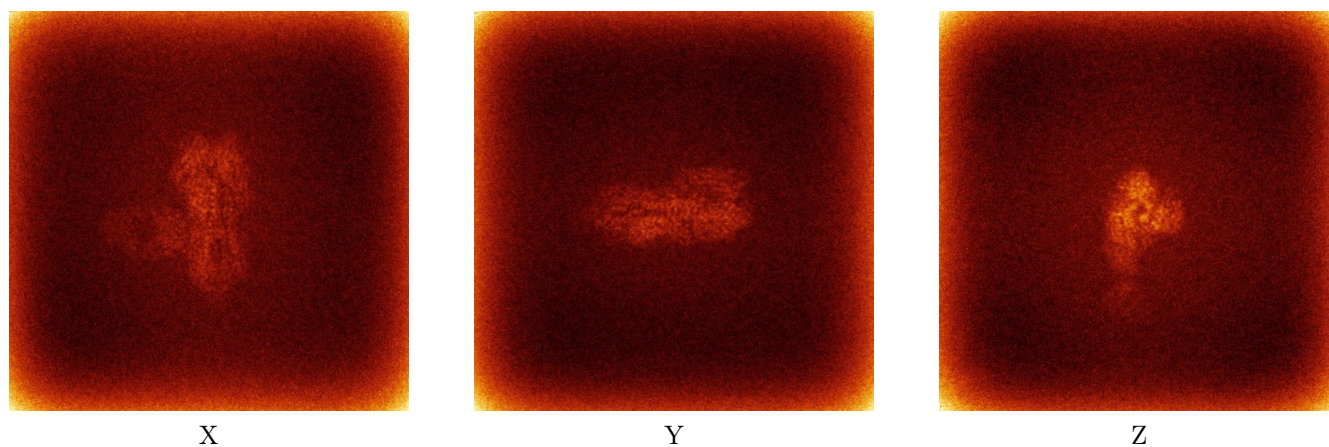

The images above show the map standard deviation projections with false color in three orthogonal directions. Minimum values are shown in green, max in blue, and dark to light orange shades represent small to large values respectively.

6.5 Orthogonal surface views [i](#)

6.5.1 Primary map

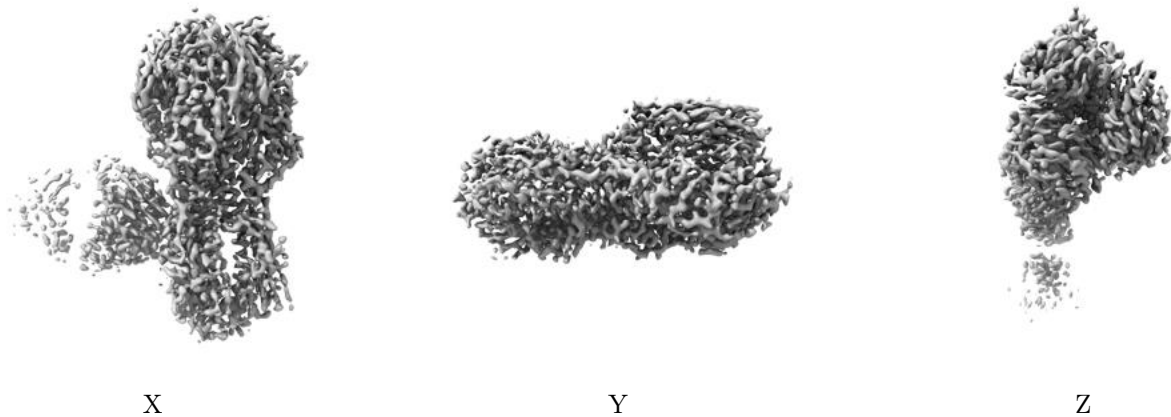

The images above show the 3D surface view of the map at the recommended contour level 0.17. These images, in conjunction with the slice images, may facilitate assessment of whether an appropriate contour level has been provided.

6.5.2 Raw map

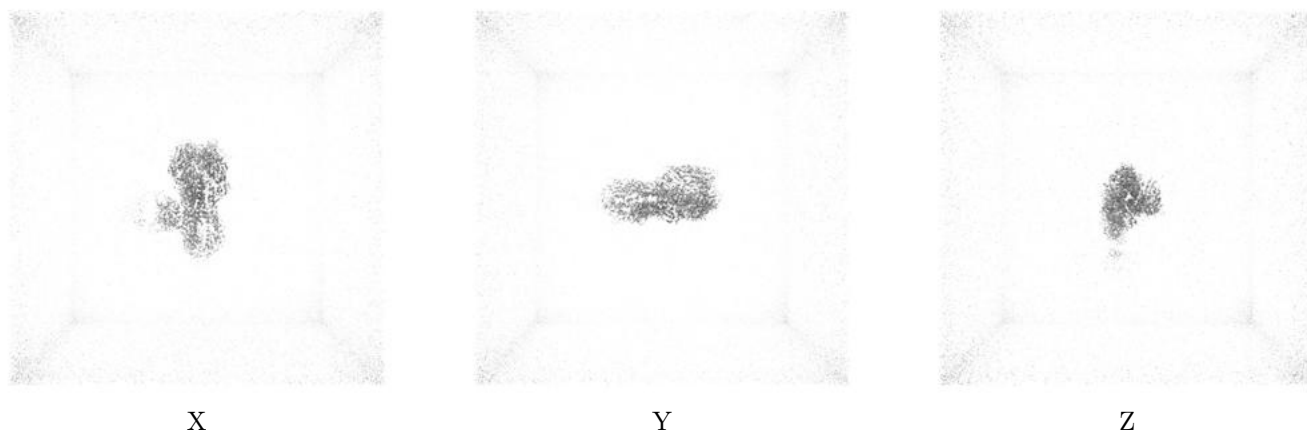

These images show the 3D surface of the raw map. The raw map's contour level was selected so that its surface encloses the same volume as the primary map does at its recommended contour level.

6.6 Mask visualisation [i](#)

This section was not generated. No masks/segmentation were deposited.

7 Map analysis [i](#)

This section contains the results of statistical analysis of the map.

7.1 Map-value distribution [i](#)

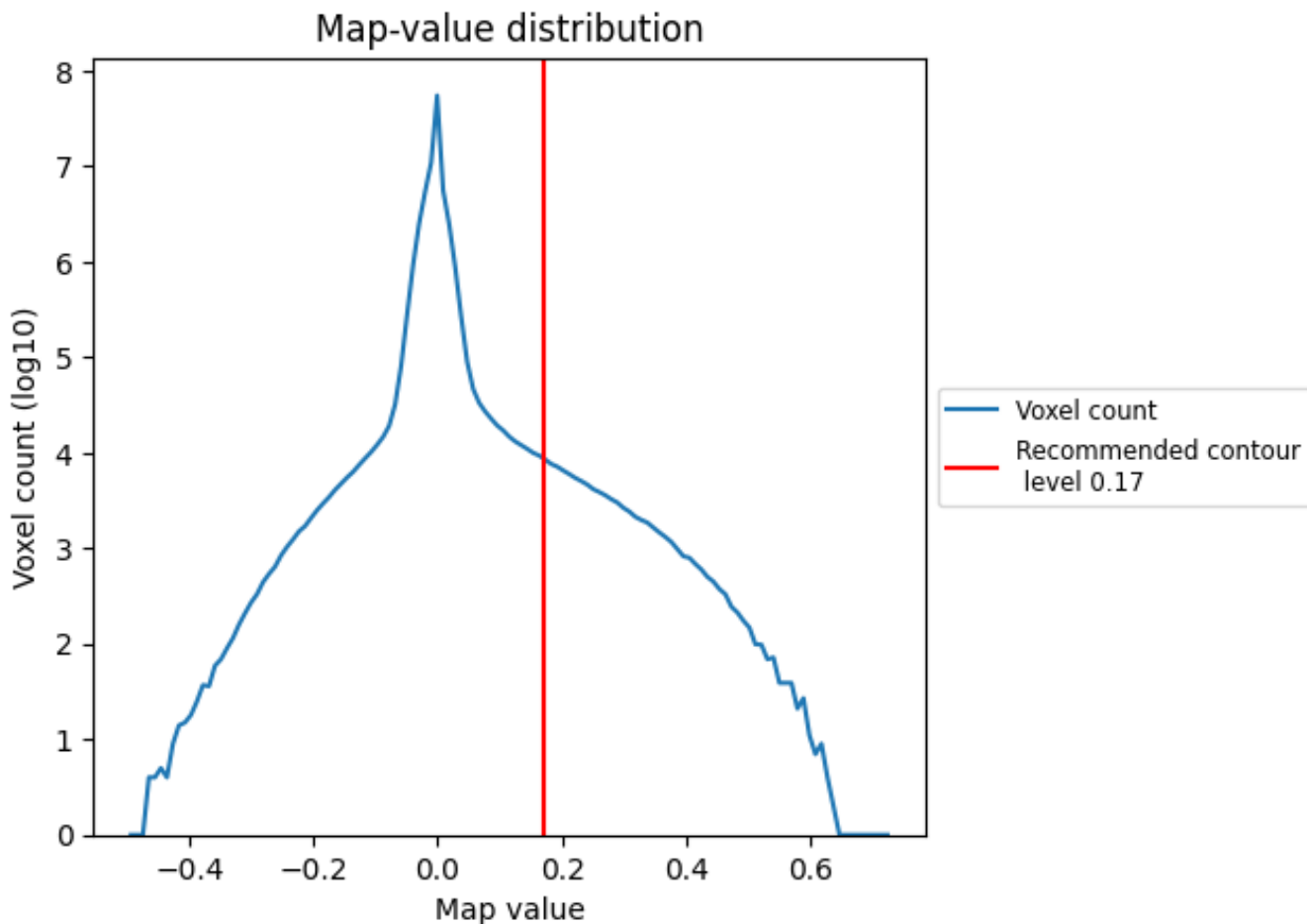

The map-value distribution is plotted in 128 intervals along the x-axis. The y-axis is logarithmic. A spike in this graph at zero usually indicates that the volume has been masked.

7.2 Volume estimate [i](#)

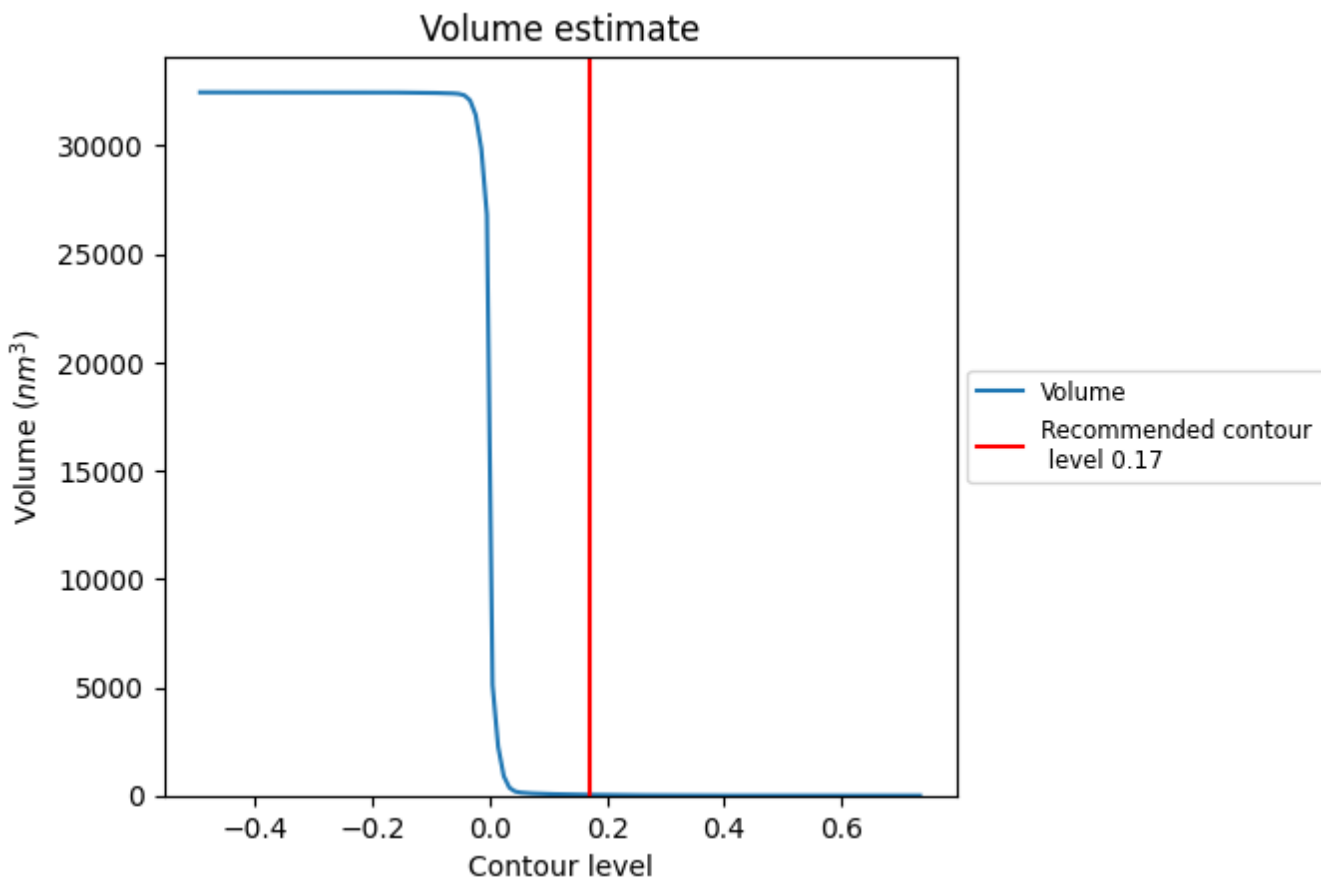

The volume at the recommended contour level is 36 nm³; this corresponds to an approximate mass of 33 kDa.

The volume estimate graph shows how the enclosed volume varies with the contour level. The recommended contour level is shown as a vertical line and the intersection between the line and the curve gives the volume of the enclosed surface at the given level.

7.3 Rotationally averaged power spectrum [i](#)

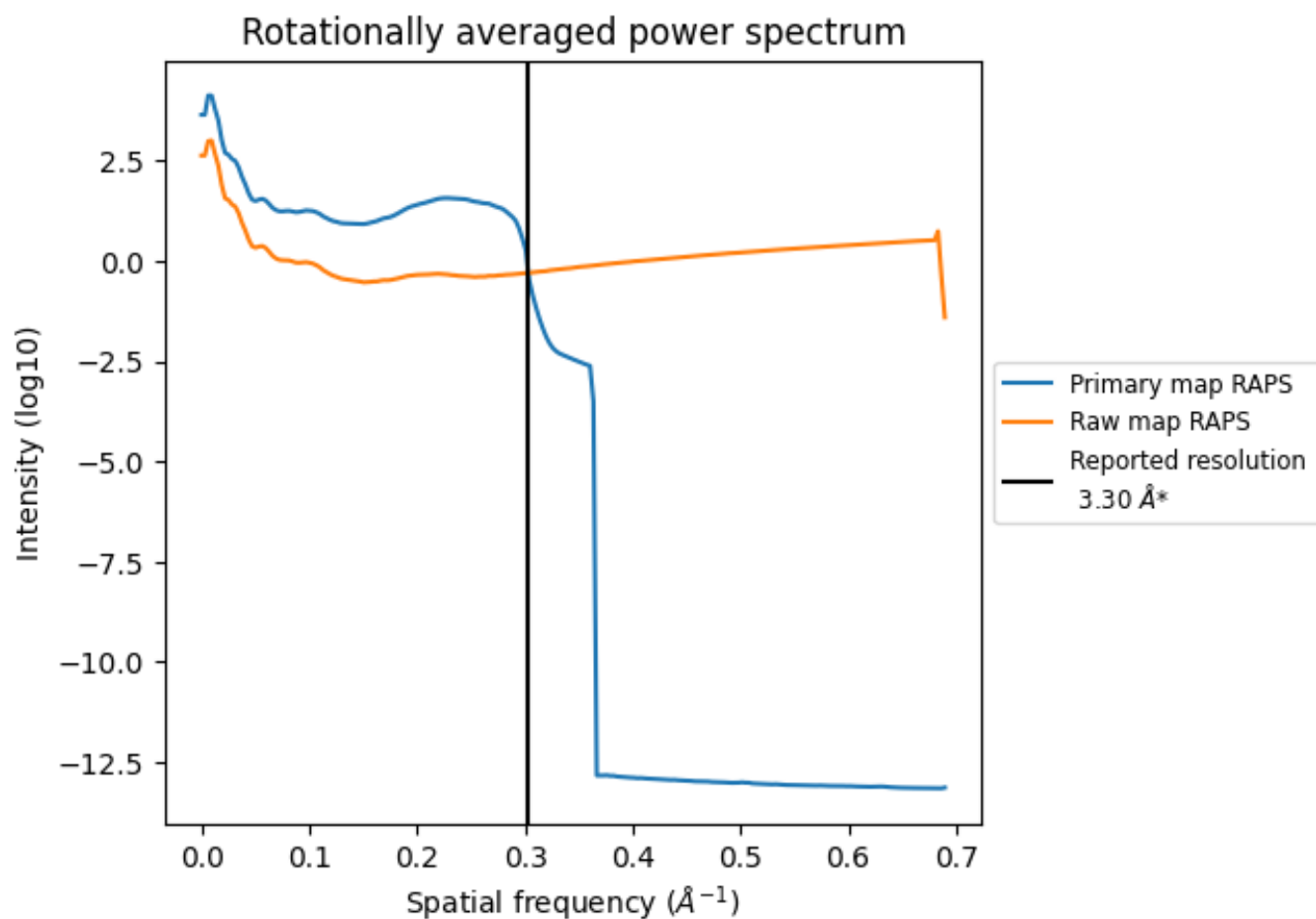

*Reported resolution corresponds to spatial frequency of 0.303 Å⁻¹

8 Fourier-Shell correlation [i](#)

Fourier-Shell Correlation (FSC) is the most commonly used method to estimate the resolution of single-particle and subtomogram-averaged maps. The shape of the curve depends on the imposed symmetry, mask and whether or not the two 3D reconstructions used were processed from a common reference. The reported resolution is shown as a black line. A curve is displayed for the half-bit criterion in addition to lines showing the 0.143 gold standard cut-off and 0.5 cut-off.

8.1 FSC [i](#)

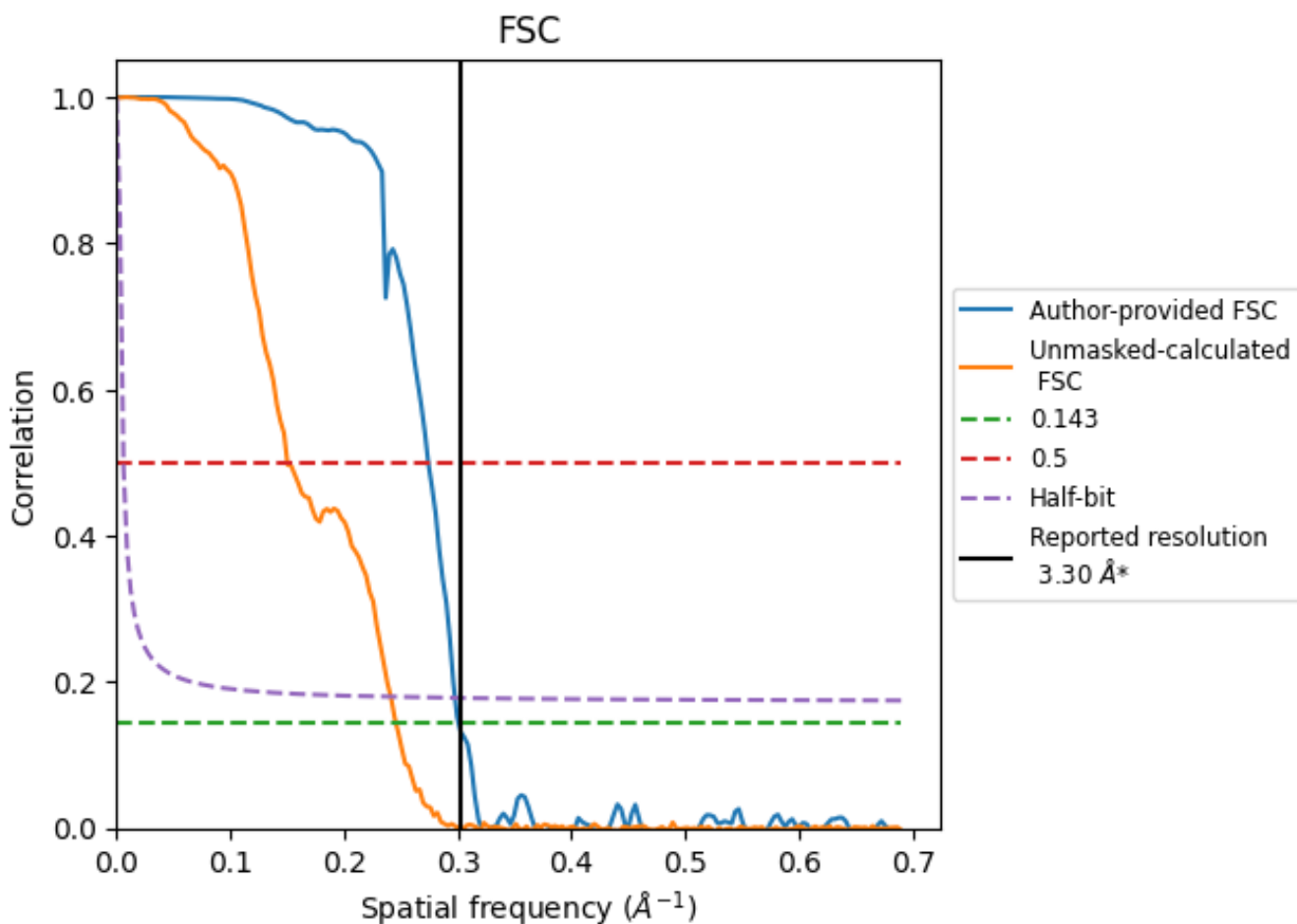

*Reported resolution corresponds to spatial frequency of 0.303 \AA^{-1}

8.2 Resolution estimates [i](#)

Resolution estimate (Å)	Estimation criterion (FSC cut-off)		
	0.143	0.5	Half-bit
Reported by author	3.30	-	-
Author-provided FSC curve	3.32	3.65	3.36
Unmasked-calculated*	4.07	6.66	4.15

*Resolution estimate based on FSC curve calculated by comparison of deposited half-maps. The value from deposited half-maps intersecting FSC 0.143 CUT-OFF 4.07 differs from the reported value 3.3 by more than 10 %

9 Map-model fit [i](#)

This section contains information regarding the fit between EMDB map EMD-42534 and PDB model 8UT9. Per-residue inclusion information can be found in section 3 on page 11.

9.1 Map-model overlay [i](#)

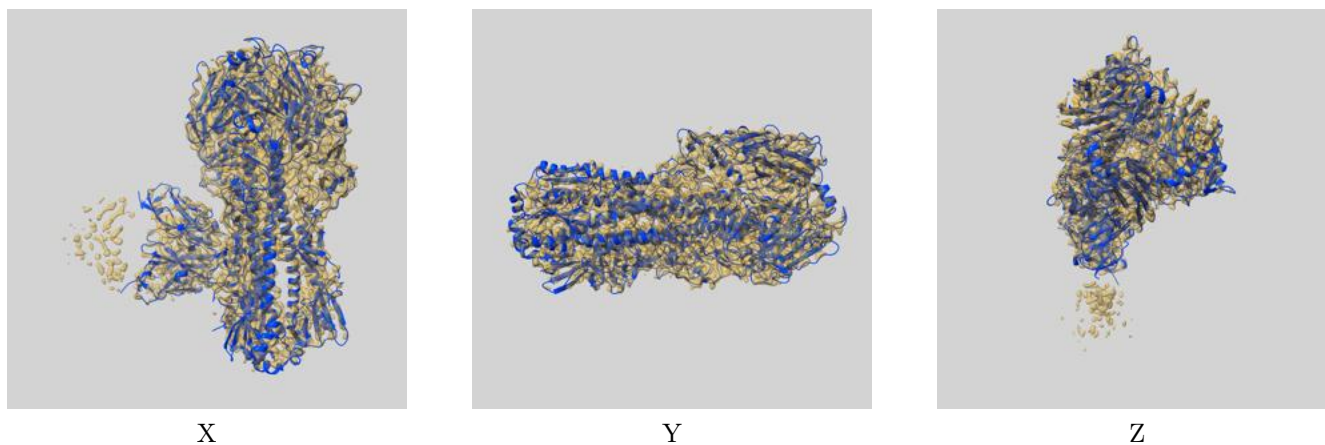

The images above show the 3D surface view of the map at the recommended contour level 0.17 at 50% transparency in yellow overlaid with a ribbon representation of the model coloured in blue. These images allow for the visual assessment of the quality of fit between the atomic model and the map.

9.2 Q-score mapped to coordinate model [\(i\)](#)

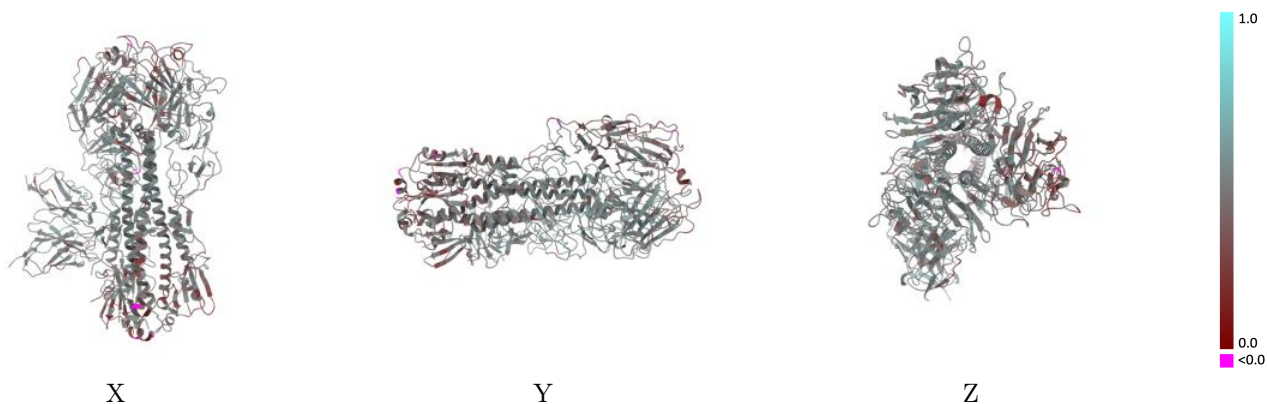

The images above show the model with each residue coloured according to its Q-score. This shows their resolvability in the map with higher Q-score values reflecting better resolvability. Please note: Q-score is calculating the resolvability of atoms, and thus high values are only expected at resolutions at which atoms can be resolved. Low Q-score values may therefore be expected for many entries.

9.3 Atom inclusion mapped to coordinate model [\(i\)](#)

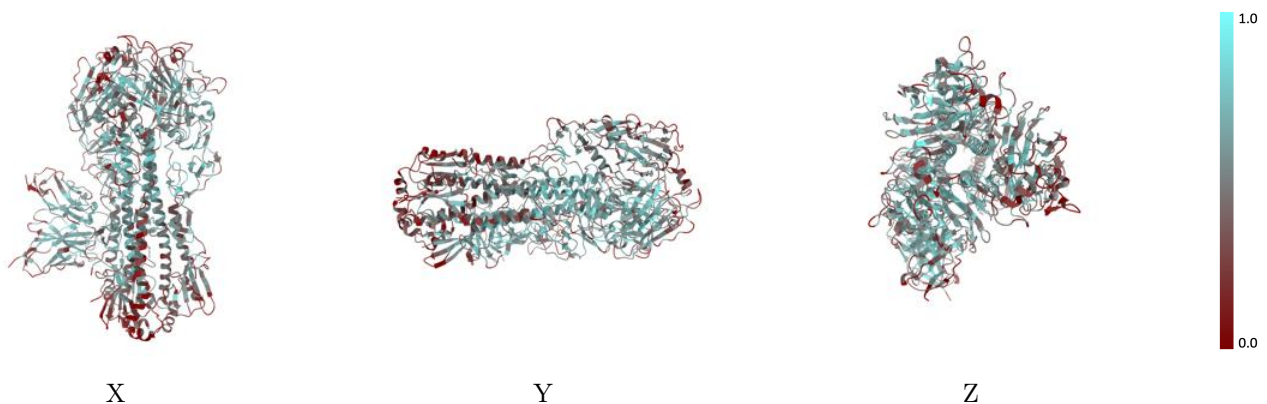

The images above show the model with each residue coloured according to its atom inclusion. This shows to what extent they are inside the map at the recommended contour level (0.17).

9.4 Atom inclusion [i](#)

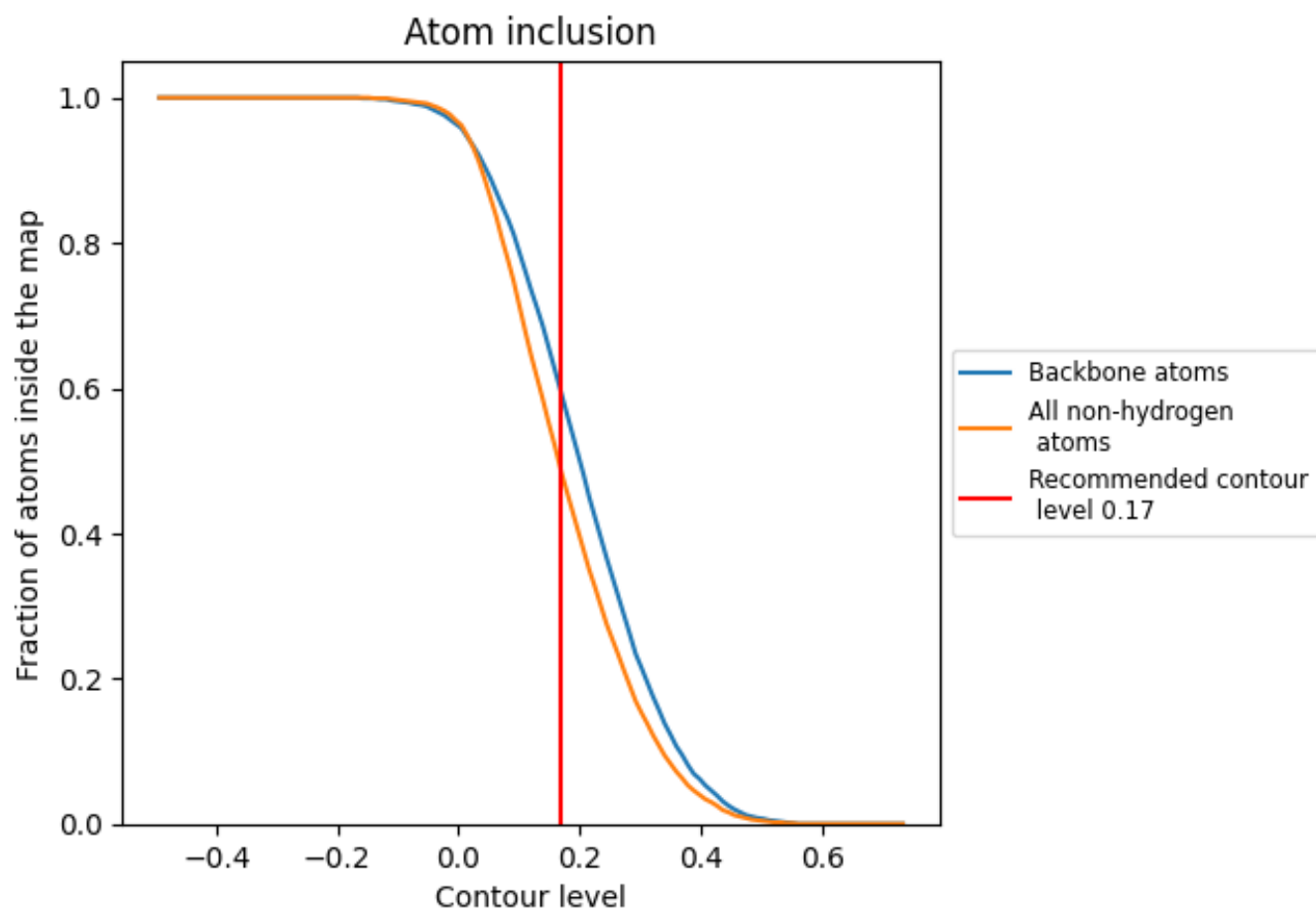

At the recommended contour level, 59% of all backbone atoms, 48% of all non-hydrogen atoms, are inside the map.

9.5 Map-model fit summary [i](#)

The table lists the average atom inclusion at the recommended contour level (0.17) and Q-score for the entire model and for each chain.

Chain	Atom inclusion	Q-score
All	0.4840	0.4610
A	0.5310	0.4750
B	0.4250	0.4290
C	0.4520	0.4340
D	0.3900	0.4310
E	0.5390	0.4960
F	0.4870	0.4660
G	0.5640	0.4890
H	0.4830	0.4870
I	0.2860	0.3510
J	0.3210	0.4520
K	0.3210	0.4810

