



# Full wwPDB X-ray Structure Validation Report ⓘ

Dec 28, 2023 – 06:09 PM EST

PDB ID : 8U7X  
Title : Crystal structure of non-receptor protein tyrosine phosphatase SHP2 in complex with inhibitor compound 24  
Authors : Mou, T.C.  
Deposited on : 2023-09-15  
Resolution : 2.06 Å(reported)

This is a Full wwPDB X-ray Structure Validation Report for a publicly released PDB entry.

We welcome your comments at [validation@mail.wwpdb.org](mailto:validation@mail.wwpdb.org)

A user guide is available at

<https://www.wwpdb.org/validation/2017/XrayValidationReportHelp>

with specific help available everywhere you see the ⓘ symbol.

The types of validation reports are described at

<http://www.wwpdb.org/validation/2017/FAQs#types>.

---

The following versions of software and data (see [references ⓘ](#)) were used in the production of this report:

MolProbity : 4.02b-467  
Mogul : 1.8.5 (274361), CSD as541be (2020)  
Xtrriage (Phenix) : 1.13  
EDS : 2.36  
buster-report : 1.1.7 (2018)  
Percentile statistics : 20191225.v01 (using entries in the PDB archive December 25th 2019)  
Refmac : 5.8.0158  
CCP4 : 7.0.044 (Gargrove)  
Ideal geometry (proteins) : Engh & Huber (2001)  
Ideal geometry (DNA, RNA) : Parkinson et al. (1996)  
Validation Pipeline (wwPDB-VP) : 2.36

# 1 Overall quality at a glance

The following experimental techniques were used to determine the structure:

*X-RAY DIFFRACTION*

The reported resolution of this entry is 2.06 Å.

Percentile scores (ranging between 0-100) for global validation metrics of the entry are shown in the following graphic. The table shows the number of entries on which the scores are based.

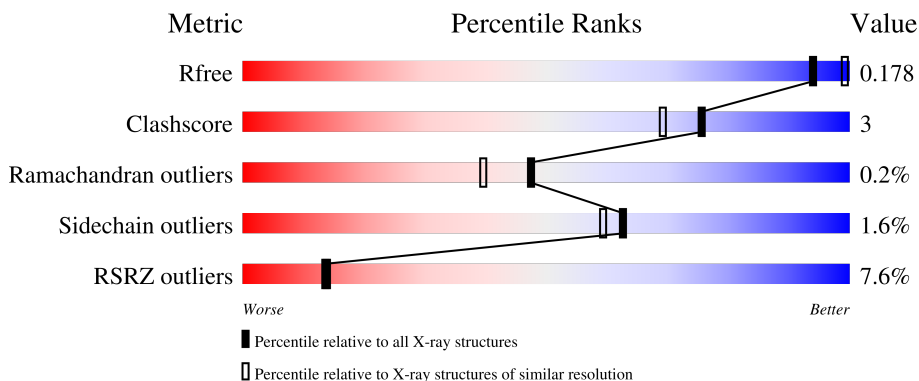

Metric	Whole archive (#Entries)	Similar resolution (#Entries, resolution range(Å))
$R_{free}$	130704	2684 (2.08-2.04)
Clashscore	141614	2801 (2.08-2.04)
Ramachandran outliers	138981	2768 (2.08-2.04)
Sidechain outliers	138945	2768 (2.08-2.04)
RSRZ outliers	127900	2646 (2.08-2.04)

The table below summarises the geometric issues observed across the polymeric chains and their fit to the electron density. The red, orange, yellow and green segments of the lower bar indicate the fraction of residues that contain outliers for  $\geq 3$ , 2, 1 and 0 types of geometric quality criteria respectively. A grey segment represents the fraction of residues that are not modelled. The numeric value for each fraction is indicated below the corresponding segment, with a dot representing fractions  $\leq 5\%$ . The upper red bar (where present) indicates the fraction of residues that have poor fit to the electron density. The numeric value is given above the bar.

Mol	Chain	Length	Quality of chain
1	A	539	 6% 83% 9% 9%
1	B	539	 8% 84% 8% 7%

## 2 Entry composition [i](#)

There are 3 unique types of molecules in this entry. The entry contains 8733 atoms, of which 0 are hydrogens and 0 are deuteriums.

In the tables below, the ZeroOcc column contains the number of atoms modelled with zero occupancy, the AltConf column contains the number of residues with at least one atom in alternate conformation and the Trace column contains the number of residues modelled with at most 2 atoms.

- Molecule 1 is a protein called Tyrosine-protein phosphatase non-receptor type 11.

Mol	Chain	Residues	Atoms					ZeroOcc	AltConf	Trace
			Total	C	N	O	S			
1	A	491	3970	2498	707	746	19	0	1	0
1	B	499	4037	2536	717	766	18	0	2	0

There are 28 discrepancies between the modelled and reference sequences:

Chain	Residue	Modelled	Actual	Comment	Reference
A	-13	MET	-	initiating methionine	UNP Q06124
A	-12	HIS	-	expression tag	UNP Q06124
A	-11	HIS	-	expression tag	UNP Q06124
A	-10	HIS	-	expression tag	UNP Q06124
A	-9	HIS	-	expression tag	UNP Q06124
A	-8	HIS	-	expression tag	UNP Q06124
A	-7	HIS	-	expression tag	UNP Q06124
A	-6	GLU	-	expression tag	UNP Q06124
A	-5	ASN	-	expression tag	UNP Q06124
A	-4	LEU	-	expression tag	UNP Q06124
A	-3	TYR	-	expression tag	UNP Q06124
A	-2	PHE	-	expression tag	UNP Q06124
A	-1	GLN	-	expression tag	UNP Q06124
A	0	SER	-	expression tag	UNP Q06124
B	-13	MET	-	initiating methionine	UNP Q06124
B	-12	HIS	-	expression tag	UNP Q06124
B	-11	HIS	-	expression tag	UNP Q06124
B	-10	HIS	-	expression tag	UNP Q06124
B	-9	HIS	-	expression tag	UNP Q06124
B	-8	HIS	-	expression tag	UNP Q06124
B	-7	HIS	-	expression tag	UNP Q06124
B	-6	GLU	-	expression tag	UNP Q06124
B	-5	ASN	-	expression tag	UNP Q06124
B	-4	LEU	-	expression tag	UNP Q06124
B	-3	TYR	-	expression tag	UNP Q06124

*Continued on next page...*

Continued from previous page...

Chain	Residue	Modelled	Actual	Comment	Reference
B	-2	PHE	-	expression tag	UNP Q06124
B	-1	GLN	-	expression tag	UNP Q06124
B	0	SER	-	expression tag	UNP Q06124

- Molecule 2 is (3S,4S)-8-{6-[(2-amino-3-chloropyridin-4-yl)sulfanyl]pyrido[2,3-b]pyrazin-2-yl}-3-methyl-2-oxa-8-azaspiro[4.5]decan-4-amine (three-letter code: WAB) (formula: C<sub>21</sub>H<sub>24</sub>ClN<sub>7</sub>OS) (labeled as "Ligand of Interest" by depositor).

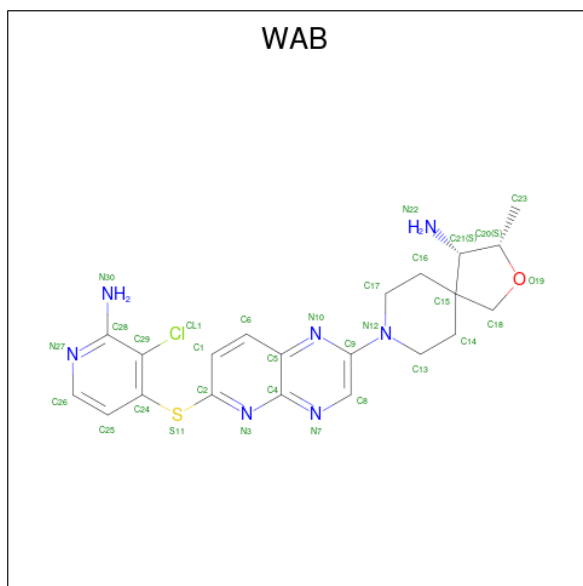

Mol	Chain	Residues	Atoms					ZeroOcc	AltConf	
			Total	C	Cl	N	O			S
2	A	1	Total	C	Cl	N	O	S	0	0
			31	21	1	7	1	1		
2	B	1	Total	C	Cl	N	O	S	0	0
			31	21	1	7	1	1		

- Molecule 3 is water.

Mol	Chain	Residues	Atoms	ZeroOcc	AltConf	
3	A	341	Total	O	0	0
			341	341		
3	B	323	Total	O	0	0
			323	323		

### 3 Residue-property plots [i](#)

These plots are drawn for all protein, RNA, DNA and oligosaccharide chains in the entry. The first graphic for a chain summarises the proportions of the various outlier classes displayed in the second graphic. The second graphic shows the sequence view annotated by issues in geometry and electron density. Residues are color-coded according to the number of geometric quality criteria for which they contain at least one outlier: green = 0, yellow = 1, orange = 2 and red = 3 or more. A red dot above a residue indicates a poor fit to the electron density ( $RSRZ > 2$ ). Stretches of 2 or more consecutive residues without any outlier are shown as a green connector. Residues present in the sample, but not in the model, are shown in grey.

- Molecule 1: Tyrosine-protein phosphatase non-receptor type 11

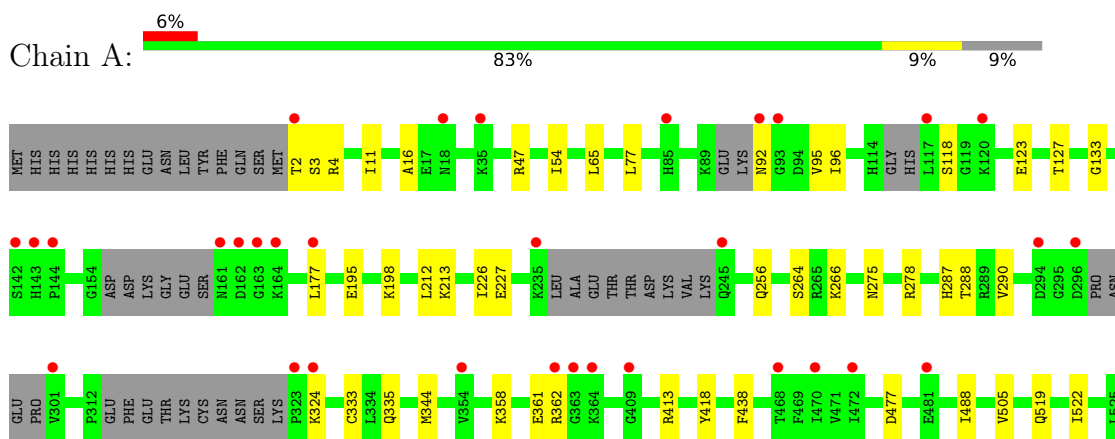

- Molecule 1: Tyrosine-protein phosphatase non-receptor type 11

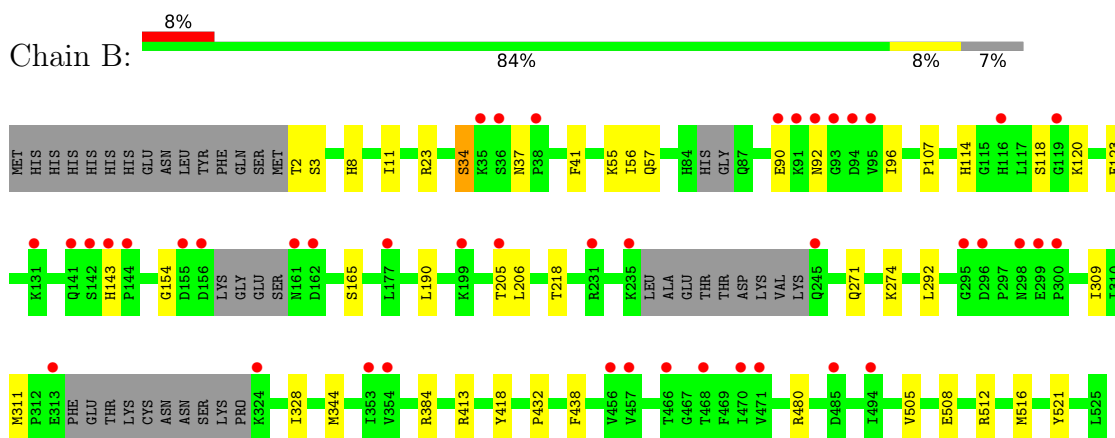

## 4 Data and refinement statistics

Property	Value	Source
Space group	P 1 21 1	Depositor
Cell constants a, b, c, $\alpha$ , $\beta$ , $\gamma$	45.44Å 213.20Å 55.77Å 90.00° 96.36° 90.00°	Depositor
Resolution (Å)	27.71 – 2.06 28.21 – 2.06	Depositor EDS
% Data completeness (in resolution range)	97.5 (27.71-2.06) 97.5 (28.21-2.06)	Depositor EDS
$R_{merge}$	(Not available)	Depositor
$R_{sym}$	(Not available)	Depositor
$\langle I/\sigma(I) \rangle$ <sup>1</sup>	4.42 (at 2.06Å)	Xtrriage
Refinement program	PHENIX 1.20.1_4487	Depositor
R, $R_{free}$	0.168 , 0.175 0.169 , 0.178	Depositor DCC
$R_{free}$ test set	2000 reflections (3.17%)	wwPDB-VP
Wilson B-factor (Å <sup>2</sup> )	24.4	Xtrriage
Anisotropy	0.091	Xtrriage
Bulk solvent $k_{sol}$ (e/Å <sup>3</sup> ), $B_{sol}$ (Å <sup>2</sup> )	0.36 , 53.5	EDS
L-test for twinning <sup>2</sup>	$\langle  L  \rangle = 0.49$ , $\langle L^2 \rangle = 0.32$	Xtrriage
Estimated twinning fraction	No twinning to report.	Xtrriage
$F_o, F_c$ correlation	0.95	EDS
Total number of atoms	8733	wwPDB-VP
Average B, all atoms (Å <sup>2</sup> )	30.0	wwPDB-VP

Xtrriage's analysis on translational NCS is as follows: *The largest off-origin peak in the Patterson function is 5.55% of the height of the origin peak. No significant pseudotranslation is detected.*

<sup>1</sup>Intensities estimated from amplitudes.

<sup>2</sup>Theoretical values of  $\langle |L| \rangle$ ,  $\langle L^2 \rangle$  for acentric reflections are 0.5, 0.333 respectively for untwinned datasets, and 0.375, 0.2 for perfectly twinned datasets.

## 5 Model quality [i](#)

### 5.1 Standard geometry [i](#)

Bond lengths and bond angles in the following residue types are not validated in this section: WAB

The Z score for a bond length (or angle) is the number of standard deviations the observed value is removed from the expected value. A bond length (or angle) with  $|Z| > 5$  is considered an outlier worth inspection. RMSZ is the root-mean-square of all Z scores of the bond lengths (or angles).

Mol	Chain	Bond lengths		Bond angles	
		RMSZ	# Z  >5	RMSZ	# Z  >5
1	A	0.25	0/4052	0.49	0/5460
1	B	0.25	0/4122	0.51	0/5559
All	All	0.25	0/8174	0.50	0/11019

There are no bond length outliers.

There are no bond angle outliers.

There are no chirality outliers.

There are no planarity outliers.

### 5.2 Too-close contacts [i](#)

In the following table, the Non-H and H(model) columns list the number of non-hydrogen atoms and hydrogen atoms in the chain respectively. The H(added) column lists the number of hydrogen atoms added and optimized by MolProbity. The Clashes column lists the number of clashes within the asymmetric unit, whereas Symm-Clashes lists symmetry-related clashes.

Mol	Chain	Non-H	H(model)	H(added)	Clashes	Symm-Clashes
1	A	3970	0	3910	27	0
1	B	4037	0	3963	23	0
2	A	31	0	0	0	0
2	B	31	0	0	0	0
3	A	341	0	0	7	0
3	B	323	0	0	3	0
All	All	8733	0	7873	50	0

The all-atom clashscore is defined as the number of clashes found per 1000 atoms (including hydrogen atoms). The all-atom clashscore for this structure is 3.

All (50) close contacts within the same asymmetric unit are listed below, sorted by their clash

magnitude.

Atom-1	Atom-2	Interatomic distance (Å)	Clash overlap (Å)
1:A:477:ASP:HB2	3:A:782:HOH:O	1.84	0.78
1:A:227:GLU:HG3	1:A:519:GLN:HE21	1.57	0.70
1:B:114:HIS:HE1	1:B:218:THR:HG21	1.60	0.66
1:A:264:SER:HB2	1:A:266:LYS:HD2	1.81	0.61
1:B:2:THR:N	3:B:705:HOH:O	2.33	0.60
1:B:432:PRO:HG3	1:B:516:MET:HG2	1.89	0.55
1:A:477:ASP:CB	3:A:782:HOH:O	2.48	0.52
1:A:133:GLY:HA3	1:A:213:LYS:HB2	1.91	0.52
1:B:292:LEU:HD21	1:B:344:MET:HB2	1.92	0.52
1:A:275:ASN:ND2	3:A:711:HOH:O	2.39	0.51
1:A:123:GLU:O	1:A:127:THR:OG1	2.21	0.51
1:B:120:LYS:HA	1:B:123:GLU:HB2	1.93	0.51
1:B:114:HIS:CE1	1:B:218:THR:HG21	2.44	0.51
1:B:8:HIS:HB2	1:B:11:ILE:HG12	1.93	0.51
1:A:54:ILE:HD11	1:A:96:ILE:HD12	1.94	0.50
1:A:358:LYS:HB2	1:A:361:GLU:HG3	1.94	0.49
1:B:309:ILE:HD13	1:B:328:ILE:HG12	1.93	0.49
1:B:34:SER:OG	1:B:37:ASN:HB2	2.13	0.49
1:A:226:ILE:HD13	1:A:488:ILE:HD11	1.96	0.48
1:B:92:ASN:ND2	3:B:713:HOH:O	2.41	0.48
1:A:65:LEU:HD12	1:A:77:LEU:HD11	1.97	0.46
1:A:290:VAL:HG11	1:A:344:MET:HG3	1.97	0.46
1:B:271:GLN:HA	1:B:274:LYS:HG3	1.97	0.45
1:A:195:GLU:OE1	3:A:702:HOH:O	2.21	0.45
1:B:23:ARG:HG3	1:B:23:ARG:NH1	2.32	0.45
1:A:226:ILE:HG21	1:A:522:ILE:HD12	1.98	0.45
1:A:4:ARG:HB3	1:A:256:GLN:NE2	2.32	0.45
1:A:198:LYS:HG2	1:A:212:LEU:HB2	1.98	0.44
1:B:55:LYS:NZ	1:B:57:GLN:HB2	2.32	0.44
1:A:362:ARG:HH11	1:A:362:ARG:HG2	1.83	0.44
1:A:335:GLN:NE2	3:A:713:HOH:O	2.40	0.43
1:B:90:GLU:HG2	1:B:96:ILE:HD11	1.98	0.43
1:A:4:ARG:HB3	1:A:256:GLN:HE22	1.83	0.43
1:B:23:ARG:HG3	1:B:23:ARG:HH11	1.83	0.43
1:B:41:PHE:HB2	1:B:56:ILE:HB	2.01	0.42
1:B:508:GLU:OE2	1:B:512:ARG:NH2	2.47	0.42
1:B:384:ARG:NE	3:B:710:HOH:O	2.37	0.42
1:B:480:ARG:HG3	1:B:521:TYR:OH	2.19	0.42
1:A:278:ARG:NH2	1:A:333:CYS:O	2.52	0.42
1:A:362:ARG:HG2	1:A:362:ARG:NH1	2.35	0.41
1:A:11:ILE:HD12	1:A:16:ALA:HB2	2.02	0.41

*Continued on next page...*



Continued from previous page...

Atom-1	Atom-2	Interatomic distance (Å)	Clash overlap (Å)
1:A:47:ARG:NH1	1:A:95:VAL:O	2.52	0.41
1:A:418:TYR:HB3	1:A:438:PHE:CE1	2.55	0.41
1:A:198:LYS:NZ	3:A:706:HOH:O	2.34	0.41
1:B:206:LEU:HD23	1:B:206:LEU:HA	1.72	0.41
1:B:107:PRO:HG3	1:B:190:LEU:HD12	2.02	0.41
1:A:287:HIS:CD2	1:A:288:THR:HG23	2.56	0.41
1:A:477:ASP:CG	3:A:782:HOH:O	2.59	0.41
1:B:418:TYR:HB3	1:B:438:PHE:CE1	2.56	0.40
1:B:154:GLY:HA3	1:B:165:SER:HA	2.03	0.40

There are no symmetry-related clashes.

## 5.3 Torsion angles [i](#)

### 5.3.1 Protein backbone [i](#)

In the following table, the Percentiles column shows the percent Ramachandran outliers of the chain as a percentile score with respect to all X-ray entries followed by that with respect to entries of similar resolution.

The Analysed column shows the number of residues for which the backbone conformation was analysed, and the total number of residues.

Mol	Chain	Analysed	Favoured	Allowed	Outliers	Percentiles	
1	A	478/539 (89%)	469 (98%)	8 (2%)	1 (0%)	47	39
1	B	490/539 (91%)	481 (98%)	8 (2%)	1 (0%)	47	39
All	All	968/1078 (90%)	950 (98%)	16 (2%)	2 (0%)	47	39

All (2) Ramachandran outliers are listed below:

Mol	Chain	Res	Type
1	A	505	VAL
1	B	505	VAL

### 5.3.2 Protein sidechains [i](#)

In the following table, the Percentiles column shows the percent sidechain outliers of the chain as a percentile score with respect to all X-ray entries followed by that with respect to entries of similar resolution.

The Analysed column shows the number of residues for which the sidechain conformation was analysed, and the total number of residues.

Mol	Chain	Analysed	Rotameric	Outliers	Percentiles	
1	A	437/481 (91%)	430 (98%)	7 (2%)	62	59
1	B	445/481 (92%)	438 (98%)	7 (2%)	62	59
All	All	882/962 (92%)	868 (98%)	14 (2%)	62	59

All (14) residues with a non-rotameric sidechain are listed below:

Mol	Chain	Res	Type
1	A	2	THR
1	A	3	SER
1	A	92	ASN
1	A	118	SER
1	A	177	LEU
1	A	324	LYS
1	A	413	ARG
1	B	3	SER
1	B	34	SER
1	B	118	SER
1	B	143	HIS
1	B	205	THR
1	B	311	MET
1	B	413	ARG

Sometimes sidechains can be flipped to improve hydrogen bonding and reduce clashes. All (4) such sidechains are listed below:

Mol	Chain	Res	Type
1	A	211	GLN
1	A	519	GLN
1	B	275	ASN
1	B	335	GLN

### 5.3.3 RNA [i](#)

There are no RNA molecules in this entry.

## 5.4 Non-standard residues in protein, DNA, RNA chains [i](#)

There are no non-standard protein/DNA/RNA residues in this entry.

## 5.5 Carbohydrates [i](#)

There are no monosaccharides in this entry.

## 5.6 Ligand geometry [i](#)

2 ligands are modelled in this entry.

In the following table, the Counts columns list the number of bonds (or angles) for which Mogul statistics could be retrieved, the number of bonds (or angles) that are observed in the model and the number of bonds (or angles) that are defined in the Chemical Component Dictionary. The Link column lists molecule types, if any, to which the group is linked. The Z score for a bond length (or angle) is the number of standard deviations the observed value is removed from the expected value. A bond length (or angle) with  $|Z| > 2$  is considered an outlier worth inspection. RMSZ is the root-mean-square of all Z scores of the bond lengths (or angles).

Mol	Type	Chain	Res	Link	Bond lengths			Bond angles		
					Counts	RMSZ	# Z  > 2	Counts	RMSZ	# Z  > 2
2	WAB	A	601	-	32,35,35	1.14	3 (9%)	39,52,52	1.47	5 (12%)
2	WAB	B	601	-	32,35,35	1.15	3 (9%)	39,52,52	1.53	5 (12%)

In the following table, the Chirals column lists the number of chiral outliers, the number of chiral centers analysed, the number of these observed in the model and the number defined in the Chemical Component Dictionary. Similar counts are reported in the Torsion and Rings columns. '-' means no outliers of that kind were identified.

Mol	Type	Chain	Res	Link	Chirals	Torsions	Rings
2	WAB	A	601	-	-	5/8/36/36	0/5/5/5
2	WAB	B	601	-	-	5/8/36/36	0/5/5/5

All (6) bond length outliers are listed below:

Mol	Chain	Res	Type	Atoms	Z	Observed(Å)	Ideal(Å)
2	B	601	WAB	C8-N7	2.79	1.36	1.31
2	A	601	WAB	C8-N7	2.76	1.36	1.31
2	B	601	WAB	C9-N10	2.64	1.36	1.32
2	A	601	WAB	C9-N10	2.63	1.36	1.32
2	B	601	WAB	C28-N30	2.44	1.40	1.34
2	A	601	WAB	C28-N30	2.36	1.40	1.34

All (10) bond angle outliers are listed below:

Mol	Chain	Res	Type	Atoms	Z	Observed(°)	Ideal(°)
2	B	601	WAB	C18-C15-C21	4.64	105.41	100.61
2	A	601	WAB	C18-C15-C21	4.59	105.35	100.61
2	B	601	WAB	C28-C29-CL1	4.47	121.10	118.92
2	A	601	WAB	C28-C29-CL1	3.70	120.72	118.92
2	A	601	WAB	C29-C28-N27	3.32	122.08	119.30
2	B	601	WAB	C29-C28-N27	3.20	121.98	119.30
2	B	601	WAB	O19-C20-C23	-2.32	106.51	109.76
2	A	601	WAB	O19-C20-C23	-2.28	106.56	109.76
2	A	601	WAB	C29-C28-N30	-2.16	121.68	122.94
2	B	601	WAB	C16-C15-C18	-2.04	109.61	111.41

There are no chirality outliers.

All (10) torsion outliers are listed below:

Mol	Chain	Res	Type	Atoms
2	A	601	WAB	C1-C2-S11-C24
2	B	601	WAB	C1-C2-S11-C24
2	A	601	WAB	C25-C24-S11-C2
2	B	601	WAB	C25-C24-S11-C2
2	A	601	WAB	N10-C9-N12-C17
2	A	601	WAB	C29-C24-S11-C2
2	B	601	WAB	C29-C24-S11-C2
2	A	601	WAB	C8-C9-N12-C17
2	B	601	WAB	N10-C9-N12-C17
2	B	601	WAB	C8-C9-N12-C17

There are no ring outliers.

No monomer is involved in short contacts.

The following is a two-dimensional graphical depiction of Mogul quality analysis of bond lengths, bond angles, torsion angles, and ring geometry for all instances of the Ligand of Interest. In addition, ligands with molecular weight > 250 and outliers as shown on the validation Tables will also be included. For torsion angles, if less than 5% of the Mogul distribution of torsion angles is within 10 degrees of the torsion angle in question, then that torsion angle is considered an outlier. Any bond that is central to one or more torsion angles identified as an outlier by Mogul will be highlighted in the graph. For rings, the root-mean-square deviation (RMSD) between the ring in question and similar rings identified by Mogul is calculated over all ring torsion angles. If the average RMSD is greater than 60 degrees and the minimal RMSD between the ring in question and any Mogul-identified rings is also greater than 60 degrees, then that ring is considered an outlier. The outliers are highlighted in purple. The color gray indicates Mogul did not find sufficient equivalents in the CSD to analyse the geometry.

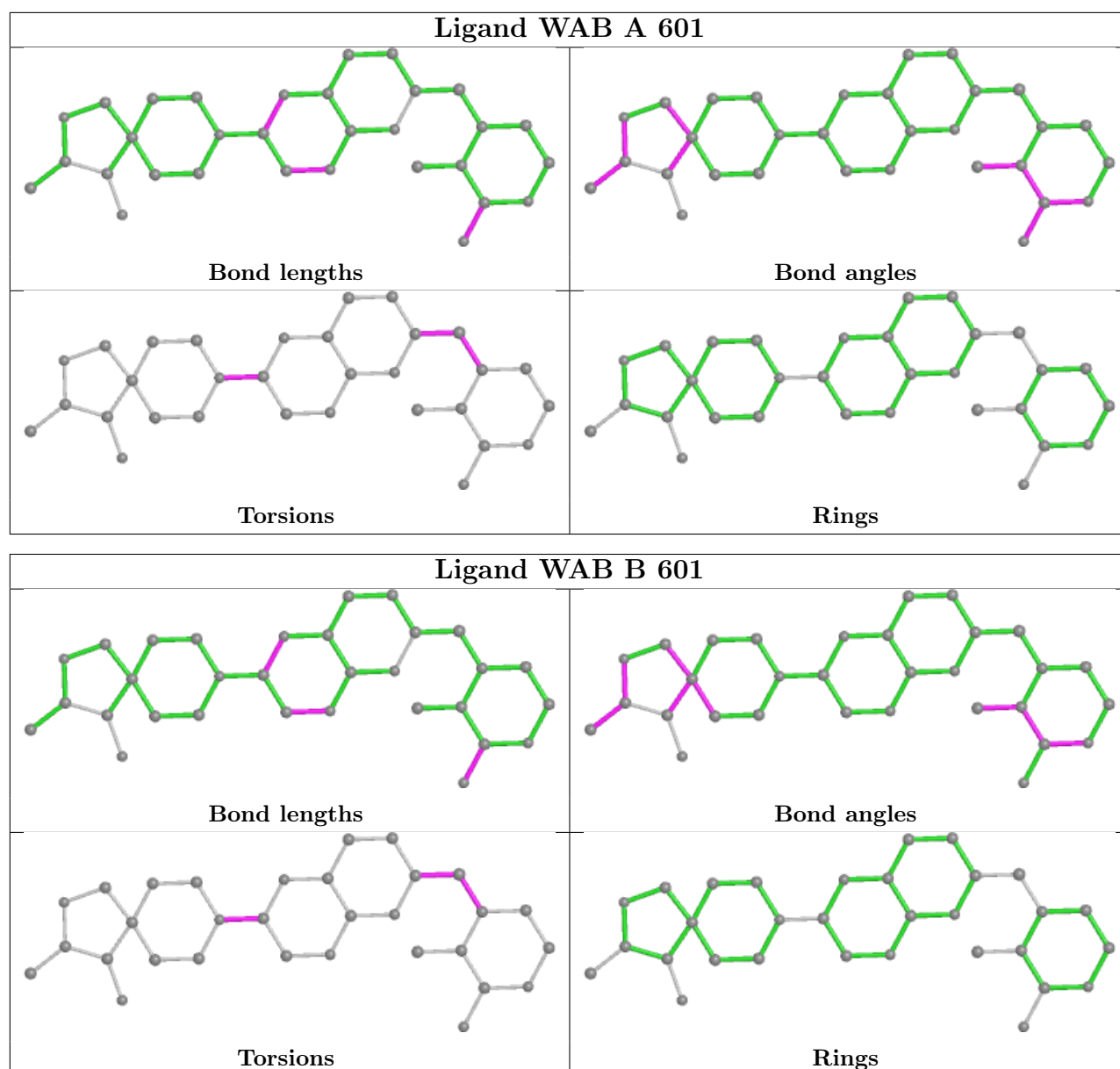

## 5.7 Other polymers [i](#)

There are no such residues in this entry.

## 5.8 Polymer linkage issues [i](#)

There are no chain breaks in this entry.

## 6 Fit of model and data [i](#)

### 6.1 Protein, DNA and RNA chains [i](#)

In the following table, the column labelled ‘#RSRZ > 2’ contains the number (and percentage) of RSRZ outliers, followed by percent RSRZ outliers for the chain as percentile scores relative to all X-ray entries and entries of similar resolution. The OWAB column contains the minimum, median, 95<sup>th</sup> percentile and maximum values of the occupancy-weighted average B-factor per residue. The column labelled ‘Q < 0.9’ lists the number of (and percentage) of residues with an average occupancy less than 0.9.

Mol	Chain	Analysed	<RSRZ>	#RSRZ>2	OWAB(Å <sup>2</sup> )	Q<0.9
1	A	491/539 (91%)	0.27	32 (6%) 18 19	12, 28, 53, 74	0
1	B	499/539 (92%)	0.29	43 (8%) 10 10	12, 27, 58, 72	0
All	All	990/1078 (91%)	0.28	75 (7%) 13 14	12, 28, 55, 74	0

All (75) RSRZ outliers are listed below:

Mol	Chain	Res	Type	RSRZ
1	A	92	ASN	4.9
1	B	93	GLY	4.8
1	B	92	ASN	4.7
1	B	36	SER	4.5
1	A	177	LEU	4.2
1	A	323	PRO	4.1
1	B	35	LYS	4.0
1	B	245	GLN	4.0
1	A	363	GLY	4.0
1	A	296	ASP	3.9
1	A	301	VAL	3.9
1	B	177	LEU	3.9
1	A	409	GLY	3.8
1	B	91	LYS	3.8
1	A	144	PRO	3.8
1	A	85	HIS	3.8
1	A	142	SER	3.6
1	A	294	ASP	3.6
1	B	94	ASP	3.6
1	A	93	GLY	3.5
1	B	300	PRO	3.4
1	B	116	HIS	3.4
1	B	313	GLU	3.3
1	B	298	ASN	3.3

*Continued on next page...*

*Continued from previous page...*

<b>Mol</b>	<b>Chain</b>	<b>Res</b>	<b>Type</b>	<b>RSRZ</b>
1	B	470	ILE	3.3
1	B	457	VAL	3.2
1	B	235	LYS	3.2
1	A	18	ASN	3.0
1	B	199	LYS	3.0
1	A	161	ASN	3.0
1	A	117	LEU	2.8
1	A	143	HIS	2.8
1	B	141	GLN	2.8
1	B	299	GLU	2.7
1	B	324	LYS	2.7
1	B	143	HIS	2.7
1	B	354	VAL	2.6
1	B	485	ASP	2.6
1	A	364	LYS	2.6
1	B	144	PRO	2.6
1	B	353	ILE	2.6
1	B	38	PRO	2.5
1	A	163	GLY	2.5
1	A	481	GLU	2.5
1	A	245	GLN	2.5
1	B	90	GLU	2.5
1	A	362	ARG	2.4
1	A	354	VAL	2.4
1	A	235	LYS	2.4
1	A	470	ILE	2.4
1	B	468	THR	2.4
1	B	161	ASN	2.3
1	B	456	VAL	2.3
1	A	120	LYS	2.3
1	B	205	THR	2.3
1	B	131	LYS	2.3
1	A	2	THR	2.3
1	A	35	LYS	2.3
1	B	295	GLY	2.3
1	B	156	ASP	2.2
1	A	162	ASP	2.2
1	B	119	GLY	2.2
1	B	162	ASP	2.2
1	B	494	ILE	2.2
1	B	155	ASP	2.2
1	B	296	ASP	2.2

*Continued on next page...*

*Continued from previous page...*

Mol	Chain	Res	Type	RSRZ
1	A	324	LYS	2.2
1	B	471	VAL	2.2
1	A	468	THR	2.2
1	A	164	LYS	2.1
1	B	95	VAL	2.0
1	B	142	SER	2.0
1	A	472	ILE	2.0
1	B	466	THR	2.0
1	B	231	ARG	2.0

## 6.2 Non-standard residues in protein, DNA, RNA chains [\(i\)](#)

There are no non-standard protein/DNA/RNA residues in this entry.

## 6.3 Carbohydrates [\(i\)](#)

There are no monosaccharides in this entry.

## 6.4 Ligands [\(i\)](#)

In the following table, the Atoms column lists the number of modelled atoms in the group and the number defined in the chemical component dictionary. The B-factors column lists the minimum, median, 95<sup>th</sup> percentile and maximum values of B factors of atoms in the group. The column labelled 'Q< 0.9' lists the number of atoms with occupancy less than 0.9.

Mol	Type	Chain	Res	Atoms	RSCC	RSR	B-factors(Å <sup>2</sup> )	Q<0.9
2	WAB	A	601	31/31	0.95	0.12	20,26,31,33	0
2	WAB	B	601	31/31	0.95	0.12	19,25,29,30	0

The following is a graphical depiction of the model fit to experimental electron density of all instances of the Ligand of Interest. In addition, ligands with molecular weight > 250 and outliers as shown on the geometry validation Tables will also be included. Each fit is shown from different orientation to approximate a three-dimensional view.



**Electron density around WAB A 601:**

$2mF_o-DF_c$  (at 0.7 rmsd) in gray  
 $mF_o-DF_c$  (at 3 rmsd) in purple (negative)  
and green (positive)

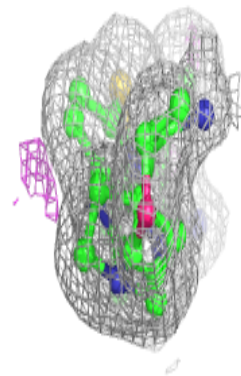
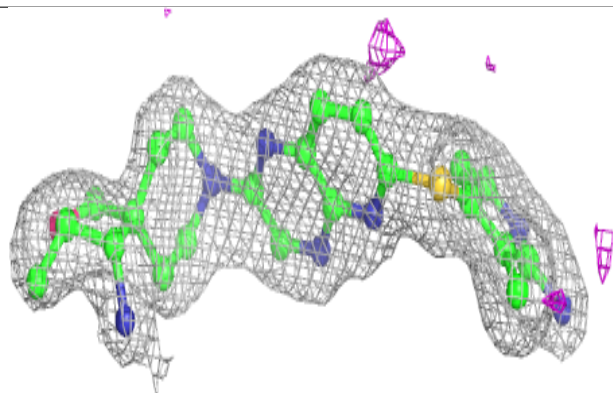
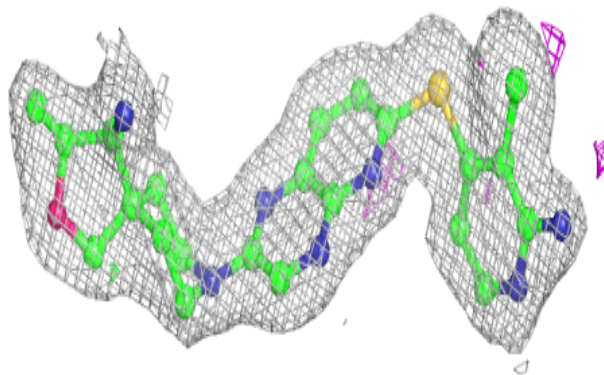
**Electron density around WAB B 601:**

$2mF_o-DF_c$  (at 0.7 rmsd) in gray  
 $mF_o-DF_c$  (at 3 rmsd) in purple (negative)  
and green (positive)

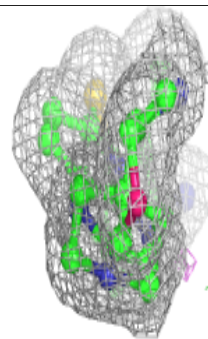
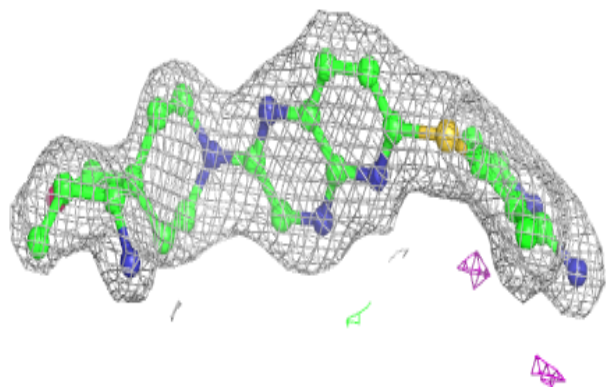
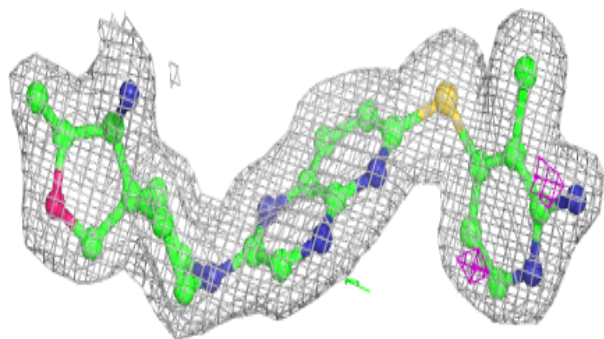

## 6.5 Other polymers [i](#)

There are no such residues in this entry.