



wwPDB X-ray Structure Validation Summary Report ⓘ

Sep 16, 2023 – 08:23 PM EDT

PDB ID : 4TYV
Title : Ensemble refinement of the E502A variant of sacteLam55A from Streptomyces sp. SirexAA-E in complex with glucose
Authors : Bianchetti, C.M.; Takasuka, T.E.; Yik, E.J.; Bergeman, L.F.; Fox, B.G.
Deposited on : 2014-07-09
Resolution : 1.75 Å(reported)

This is a wwPDB X-ray Structure Validation Summary Report for a publicly released PDB entry.

We welcome your comments at validation@mail.wwpdb.org

A user guide is available at

<https://www.wwpdb.org/validation/2017/XrayValidationReportHelp>

with specific help available everywhere you see the ⓘ symbol.

The types of validation reports are described at

<http://www.wwpdb.org/validation/2017/FAQs#types>.

The following versions of software and data (see [references ⓘ](#)) were used in the production of this report:

MolProbity : 4.02b-467
Mogul : 1.8.5 (274361), CSD as541be (2020)
Xtriage (Phenix) : 1.13
EDS : 2.35.1
Percentile statistics : 20191225.v01 (using entries in the PDB archive December 25th 2019)
Refmac : 5.8.0158
CCP4 : 7.0.044 (Gargrove)
Ideal geometry (proteins) : Engh & Huber (2001)
Ideal geometry (DNA, RNA) : Parkinson et al. (1996)
Validation Pipeline (wwPDB-VP) : 2.35.1

1 Overall quality at a glance

The following experimental techniques were used to determine the structure:

X-RAY DIFFRACTION

The reported resolution of this entry is 1.75 Å.

Percentile scores (ranging between 0-100) for global validation metrics of the entry are shown in the following graphic. The table shows the number of entries on which the scores are based.

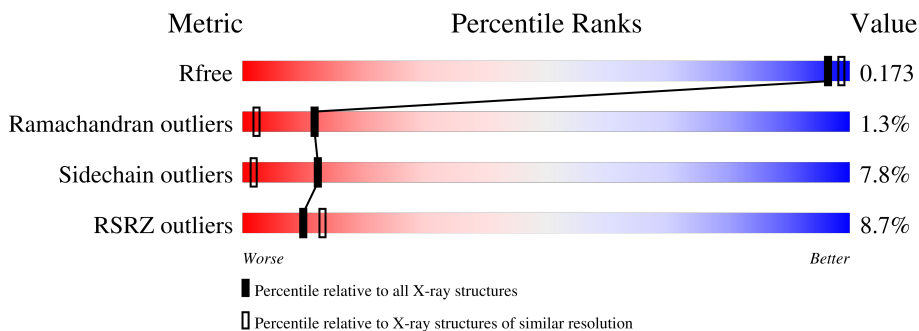



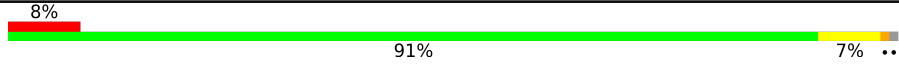
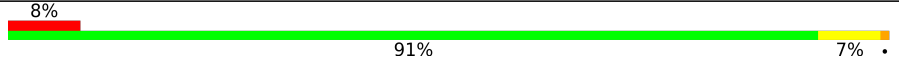
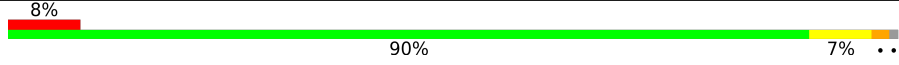
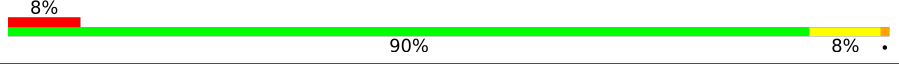
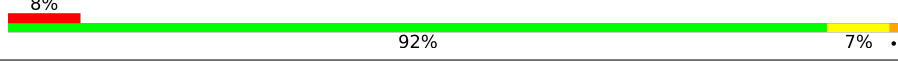

Metric	Whole archive (#Entries)	Similar resolution (#Entries, resolution range(Å))
R_{free}	130704	2340 (1.76-1.76)
Ramachandran outliers	138981	2437 (1.76-1.76)
Sidechain outliers	138945	2437 (1.76-1.76)
RSRZ outliers	127900	2298 (1.76-1.76)

The table below summarises the geometric issues observed across the polymeric chains and their fit to the electron density. The red, orange, yellow and green segments of the lower bar indicate the fraction of residues that contain outliers for ≥ 3 , 2, 1 and 0 types of geometric quality criteria respectively. A grey segment represents the fraction of residues that are not modelled. The numeric value for each fraction is indicated below the corresponding segment, with a dot representing fractions $\leq 5\%$. The upper red bar (where present) indicates the fraction of residues that have poor fit to the electron density. The numeric value is given above the bar.

Mol	Chain	Length	Quality of chain
1	1-A	551	
1	1-B	551	
1	10-A	551	
1	10-B	551	
1	11-A	551	
1	11-B	551	

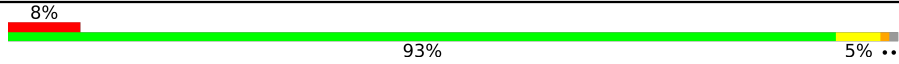
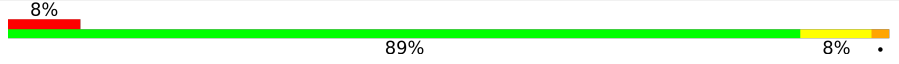
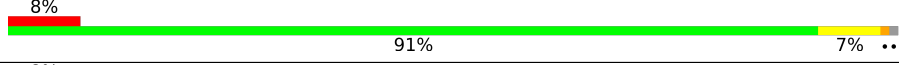
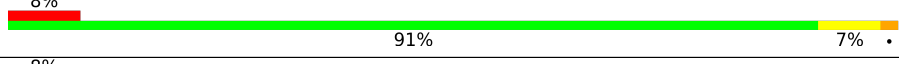
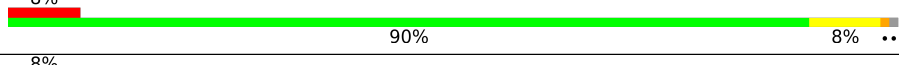
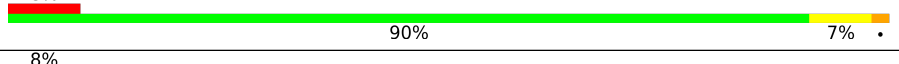
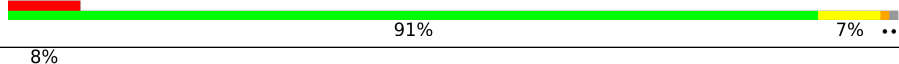
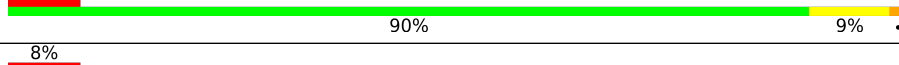
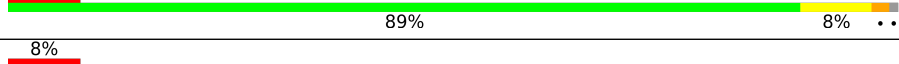
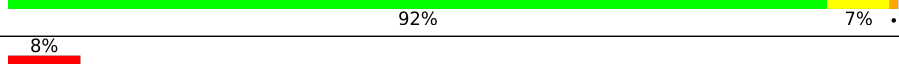
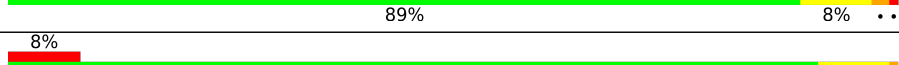
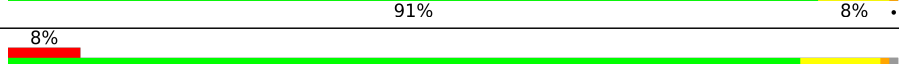

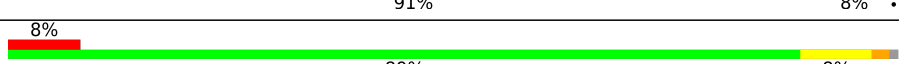
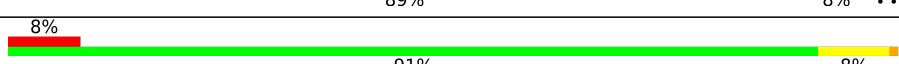
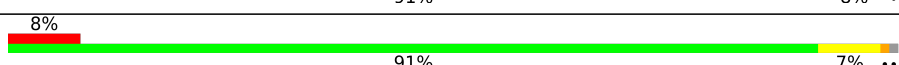
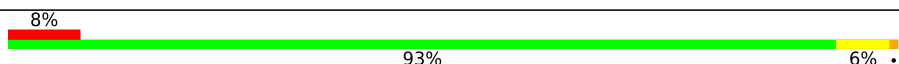
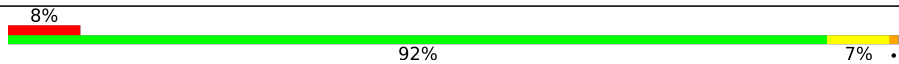
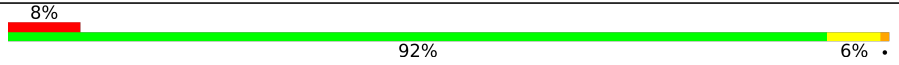
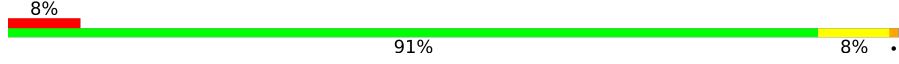
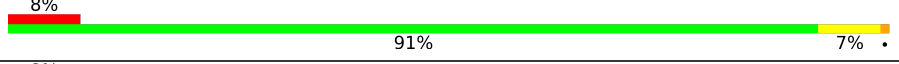
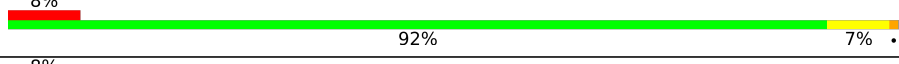
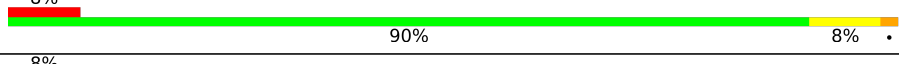
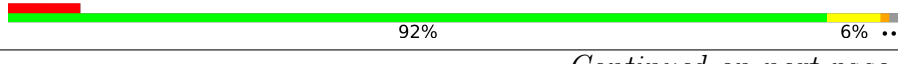
Continued on next page...

Continued from previous page...

Mol	Chain	Length	Quality of chain
1	12-A	551	 8% 93% 5% ..
1	12-B	551	 8% 89% 8% .
1	13-A	551	 8% 91% 7% ..
1	13-B	551	 8% 91% 7% .
1	14-A	551	 8% 90% 8% ..
1	14-B	551	 8% 90% 7% .
1	15-A	551	 8% 91% 7% ..
1	15-B	551	 8% 90% 9% .
1	16-A	551	 8% 89% 8% ..
1	16-B	551	 8% 92% 7% .
1	17-A	551	 8% 89% 8% ...
1	17-B	551	 8% 91% 8% .
1	18-A	551	 8% 89% 9% ..
1	18-B	551	 8% 91% 8% .
1	19-A	551	 8% 89% 8% ..
1	19-B	551	 8% 91% 8% .
1	2-A	551	 8% 91% 7% ..
1	2-B	551	 8% 93% 6% .
1	20-A	551	 8% 92% 7% ..
1	20-B	551	 8% 92% 6% .
1	21-A	551	 8% 91% 8% ..
1	21-B	551	 8% 91% 7% .
1	22-A	551	 8% 92% 7% ..
1	22-B	551	 8% 90% 8% .
1	23-A	551	 8% 92% 6% ..

Continued on next page...

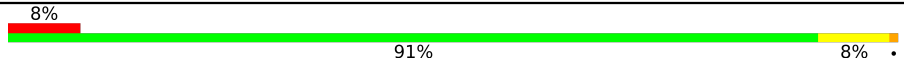
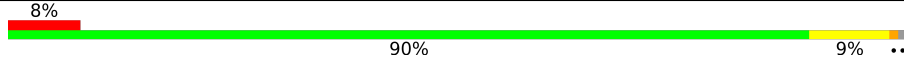
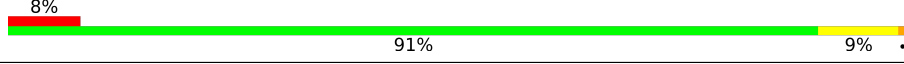
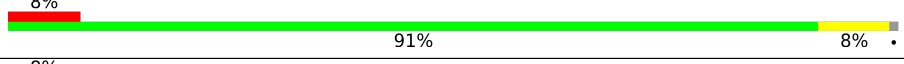
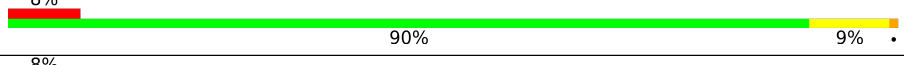
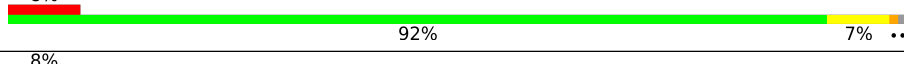
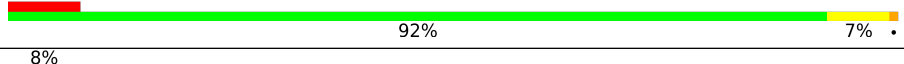
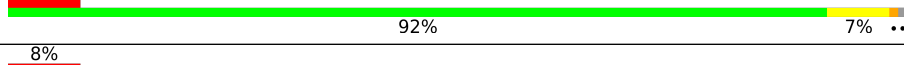
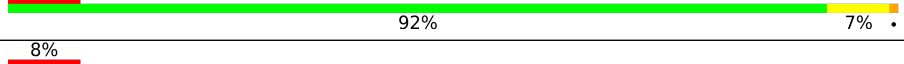
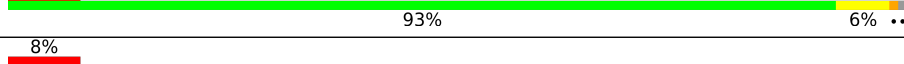
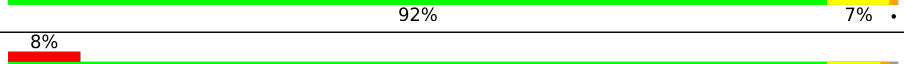
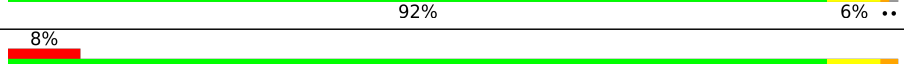
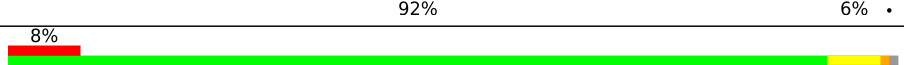
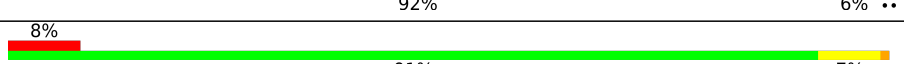
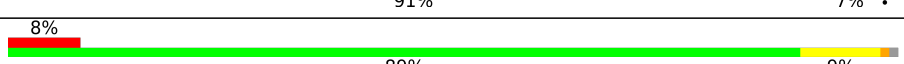
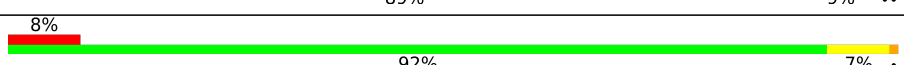
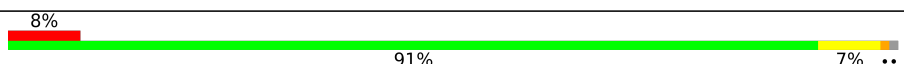
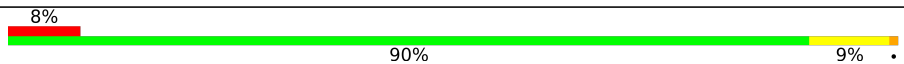
Continued from previous page...

Mol	Chain	Length	Quality of chain
1	23-B	551	 8% 91% 8%
1	24-A	551	 8% 90% 9%
1	24-B	551	 8% 91% 9%
1	25-A	551	 8% 91% 8%
1	25-B	551	 8% 90% 9%
1	3-A	551	 8% 92% 7%
1	3-B	551	 8% 92% 7%
1	4-A	551	 8% 92% 7%
1	4-B	551	 8% 92% 7%
1	5-A	551	 8% 93% 6%
1	5-B	551	 8% 92% 7%
1	6-A	551	 8% 92% 6%
1	6-B	551	 8% 92% 6%
1	7-A	551	 8% 92% 6%
1	7-B	551	 8% 91% 7%
1	8-A	551	 8% 89% 9%
1	8-B	551	 8% 92% 7%
1	9-A	551	 8% 91% 7%
1	9-B	551	 8% 90% 9%

2 Entry composition [i](#)

There are 4 unique types of molecules in this entry. The entry contains 418117 atoms, of which 196575 are hydrogens and 0 are deuteriums.

In the tables below, the ZeroOcc column contains the number of atoms modelled with zero occupancy, the AltConf column contains the number of residues with at least one atom in alternate conformation and the Trace column contains the number of residues modelled with at most 2 atoms.

- Molecule 1 is a protein called Putative secreted protein.

Mol	Chain	Residues	Atoms					ZeroOcc	AltConf	Trace	
			Total	C	H	N	O				S
1	1-A	548	8059	2624	3901	707	822	5	0	0	0
1	2-A	548	8059	2624	3901	707	822	5	0	0	0
1	3-A	548	8059	2624	3901	707	822	5	0	0	0
1	4-A	548	8059	2624	3901	707	822	5	0	0	0
1	5-A	548	8059	2624	3901	707	822	5	0	0	0
1	6-A	548	8059	2624	3901	707	822	5	0	0	0
1	7-A	548	8059	2624	3901	707	822	5	0	0	0
1	8-A	548	8059	2624	3901	707	822	5	0	0	0
1	9-A	548	8059	2624	3901	707	822	5	0	0	0
1	10-A	548	8059	2624	3901	707	822	5	0	0	0
1	11-A	548	8059	2624	3901	707	822	5	0	0	0
1	12-A	548	8059	2624	3901	707	822	5	0	0	0
1	13-A	548	8059	2624	3901	707	822	5	0	0	0
1	14-A	548	8059	2624	3901	707	822	5	0	0	0
1	15-A	548	8059	2624	3901	707	822	5	0	0	0
1	16-A	548	8059	2624	3901	707	822	5	0	0	0

Continued on next page...

Continued from previous page...

Mol	Chain	Residues	Atoms					ZeroOcc	AltConf	Trace	
1	17-A	548	Total	C	H	N	O	S	0	0	0
			8059	2624	3901	707	822	5			
1	18-A	548	Total	C	H	N	O	S	0	0	0
			8059	2624	3901	707	822	5			
1	19-A	548	Total	C	H	N	O	S	0	0	0
			8059	2624	3901	707	822	5			
1	20-A	548	Total	C	H	N	O	S	0	0	0
			8059	2624	3901	707	822	5			
1	21-A	548	Total	C	H	N	O	S	0	0	0
			8059	2624	3901	707	822	5			
1	22-A	548	Total	C	H	N	O	S	0	0	0
			8059	2624	3901	707	822	5			
1	23-A	548	Total	C	H	N	O	S	0	0	0
			8059	2624	3901	707	822	5			
1	24-A	548	Total	C	H	N	O	S	0	0	0
			8059	2624	3901	707	822	5			
1	25-A	548	Total	C	H	N	O	S	0	0	0
			8059	2624	3901	707	822	5			
1	1-B	551	Total	C	H	N	O	S	0	0	0
			8101	2637	3920	711	828	5			
1	2-B	551	Total	C	H	N	O	S	0	0	0
			8101	2637	3920	711	828	5			
1	3-B	551	Total	C	H	N	O	S	0	0	0
			8101	2637	3920	711	828	5			
1	4-B	551	Total	C	H	N	O	S	0	0	0
			8101	2637	3920	711	828	5			
1	5-B	551	Total	C	H	N	O	S	0	0	0
			8101	2637	3920	711	828	5			
1	6-B	551	Total	C	H	N	O	S	0	0	0
			8101	2637	3920	711	828	5			
1	7-B	551	Total	C	H	N	O	S	0	0	0
			8101	2637	3920	711	828	5			
1	8-B	551	Total	C	H	N	O	S	0	0	0
			8101	2637	3920	711	828	5			
1	9-B	551	Total	C	H	N	O	S	0	0	0
			8101	2637	3920	711	828	5			
1	10-B	551	Total	C	H	N	O	S	0	0	0
			8101	2637	3920	711	828	5			
1	11-B	551	Total	C	H	N	O	S	0	0	0
			8101	2637	3920	711	828	5			
1	12-B	551	Total	C	H	N	O	S	0	0	0
			8101	2637	3920	711	828	5			

Continued on next page...

Continued from previous page...

Mol	Chain	Residues	Atoms					ZeroOcc	AltConf	Trace	
1	13-B	551	Total	C	H	N	O	S	0	0	0
			8101	2637	3920	711	828	5			
1	14-B	551	Total	C	H	N	O	S	0	0	0
			8101	2637	3920	711	828	5			
1	15-B	551	Total	C	H	N	O	S	0	0	0
			8101	2637	3920	711	828	5			
1	16-B	551	Total	C	H	N	O	S	0	0	0
			8101	2637	3920	711	828	5			
1	17-B	551	Total	C	H	N	O	S	0	0	0
			8101	2637	3920	711	828	5			
1	18-B	551	Total	C	H	N	O	S	0	0	0
			8101	2637	3920	711	828	5			
1	19-B	551	Total	C	H	N	O	S	0	0	0
			8101	2637	3920	711	828	5			
1	20-B	551	Total	C	H	N	O	S	0	0	0
			8101	2637	3920	711	828	5			
1	21-B	551	Total	C	H	N	O	S	0	0	0
			8101	2637	3920	711	828	5			
1	22-B	551	Total	C	H	N	O	S	0	0	0
			8101	2637	3920	711	828	5			
1	23-B	551	Total	C	H	N	O	S	0	0	0
			8101	2637	3920	711	828	5			
1	24-B	551	Total	C	H	N	O	S	0	0	0
			8101	2637	3920	711	828	5			
1	25-B	551	Total	C	H	N	O	S	0	0	0
			8101	2637	3920	711	828	5			

There are 2 discrepancies between the modelled and reference sequences:

Chain	Residue	Modelled	Actual	Comment	Reference
A	502	ALA	GLU	engineered mutation	UNP G2NFJ9
B	502	ALA	GLU	engineered mutation	UNP G2NFJ9

- Molecule 2 is 1,2-ETHANEDIOL (three-letter code: EDO) (formula: C₂H₆O₂).



Mol	Chain	Residues	Atoms				ZeroOcc	AltConf
2	1-A	1	Total	C	H	O	0	0
			10	2	6	2		
2	2-A	1	Total	C	H	O	0	0
			10	2	6	2		
2	3-A	1	Total	C	H	O	0	0
			10	2	6	2		
2	4-A	1	Total	C	H	O	0	0
			10	2	6	2		
2	5-A	1	Total	C	H	O	0	0
			10	2	6	2		
2	6-A	1	Total	C	H	O	0	0
			10	2	6	2		
2	7-A	1	Total	C	H	O	0	0
			10	2	6	2		
2	8-A	1	Total	C	H	O	0	0
			10	2	6	2		
2	9-A	1	Total	C	H	O	0	0
			10	2	6	2		
2	10-A	1	Total	C	H	O	0	0
			10	2	6	2		
2	11-A	1	Total	C	H	O	0	0
			10	2	6	2		
2	12-A	1	Total	C	H	O	0	0
			10	2	6	2		
2	13-A	1	Total	C	H	O	0	0
			10	2	6	2		
2	14-A	1	Total	C	H	O	0	0
			10	2	6	2		

Continued on next page...

Continued from previous page...

Mol	Chain	Residues	Atoms				ZeroOcc	AltConf
2	15-A	1	Total	C	H	O	0	0
			10	2	6	2		
2	16-A	1	Total	C	H	O	0	0
			10	2	6	2		
2	17-A	1	Total	C	H	O	0	0
			10	2	6	2		
2	18-A	1	Total	C	H	O	0	0
			10	2	6	2		
2	19-A	1	Total	C	H	O	0	0
			10	2	6	2		
2	20-A	1	Total	C	H	O	0	0
			10	2	6	2		
2	21-A	1	Total	C	H	O	0	0
			10	2	6	2		
2	22-A	1	Total	C	H	O	0	0
			10	2	6	2		
2	23-A	1	Total	C	H	O	0	0
			10	2	6	2		
2	24-A	1	Total	C	H	O	0	0
			10	2	6	2		
2	25-A	1	Total	C	H	O	0	0
			10	2	6	2		
2	1-A	1	Total	C	H	O	0	0
			10	2	6	2		
2	2-A	1	Total	C	H	O	0	0
			10	2	6	2		
2	3-A	1	Total	C	H	O	0	0
			10	2	6	2		
2	4-A	1	Total	C	H	O	0	0
			10	2	6	2		
2	5-A	1	Total	C	H	O	0	0
			10	2	6	2		
2	6-A	1	Total	C	H	O	0	0
			10	2	6	2		
2	7-A	1	Total	C	H	O	0	0
			10	2	6	2		
2	8-A	1	Total	C	H	O	0	0
			10	2	6	2		
2	9-A	1	Total	C	H	O	0	0
			10	2	6	2		
2	10-A	1	Total	C	H	O	0	0
			10	2	6	2		

Continued on next page...

Continued from previous page...

Mol	Chain	Residues	Atoms				ZeroOcc	AltConf
2	11-A	1	Total	C	H	O	0	0
			10	2	6	2		
2	12-A	1	Total	C	H	O	0	0
			10	2	6	2		
2	13-A	1	Total	C	H	O	0	0
			10	2	6	2		
2	14-A	1	Total	C	H	O	0	0
			10	2	6	2		
2	15-A	1	Total	C	H	O	0	0
			10	2	6	2		
2	16-A	1	Total	C	H	O	0	0
			10	2	6	2		
2	17-A	1	Total	C	H	O	0	0
			10	2	6	2		
2	18-A	1	Total	C	H	O	0	0
			10	2	6	2		
2	19-A	1	Total	C	H	O	0	0
			10	2	6	2		
2	20-A	1	Total	C	H	O	0	0
			10	2	6	2		
2	21-A	1	Total	C	H	O	0	0
			10	2	6	2		
2	22-A	1	Total	C	H	O	0	0
			10	2	6	2		
2	23-A	1	Total	C	H	O	0	0
			10	2	6	2		
2	24-A	1	Total	C	H	O	0	0
			10	2	6	2		
2	25-A	1	Total	C	H	O	0	0
			10	2	6	2		
2	1-B	1	Total	C	H	O	0	0
			10	2	6	2		
2	2-B	1	Total	C	H	O	0	0
			10	2	6	2		
2	3-B	1	Total	C	H	O	0	0
			10	2	6	2		
2	4-B	1	Total	C	H	O	0	0
			10	2	6	2		
2	5-B	1	Total	C	H	O	0	0
			10	2	6	2		
2	6-B	1	Total	C	H	O	0	0
			10	2	6	2		

Continued on next page...

Continued from previous page...

Mol	Chain	Residues	Atoms				ZeroOcc	AltConf
2	7-B	1	Total	C	H	O	0	0
			10	2	6	2		
2	8-B	1	Total	C	H	O	0	0
			10	2	6	2		
2	9-B	1	Total	C	H	O	0	0
			10	2	6	2		
2	10-B	1	Total	C	H	O	0	0
			10	2	6	2		
2	11-B	1	Total	C	H	O	0	0
			10	2	6	2		
2	12-B	1	Total	C	H	O	0	0
			10	2	6	2		
2	13-B	1	Total	C	H	O	0	0
			10	2	6	2		
2	14-B	1	Total	C	H	O	0	0
			10	2	6	2		
2	15-B	1	Total	C	H	O	0	0
			10	2	6	2		
2	16-B	1	Total	C	H	O	0	0
			10	2	6	2		
2	17-B	1	Total	C	H	O	0	0
			10	2	6	2		
2	18-B	1	Total	C	H	O	0	0
			10	2	6	2		
2	19-B	1	Total	C	H	O	0	0
			10	2	6	2		
2	20-B	1	Total	C	H	O	0	0
			10	2	6	2		
2	21-B	1	Total	C	H	O	0	0
			10	2	6	2		
2	22-B	1	Total	C	H	O	0	0
			10	2	6	2		
2	23-B	1	Total	C	H	O	0	0
			10	2	6	2		
2	24-B	1	Total	C	H	O	0	0
			10	2	6	2		
2	25-B	1	Total	C	H	O	0	0
			10	2	6	2		
2	1-B	1	Total	C	H	O	0	0
			10	2	6	2		
2	2-B	1	Total	C	H	O	0	0
			10	2	6	2		

Continued on next page...

Continued from previous page...

Mol	Chain	Residues	Atoms				ZeroOcc	AltConf
			Total	C	H	O		
2	3-B	1	Total 10	C 2	H 6	O 2	0	0
2	4-B	1	Total 10	C 2	H 6	O 2	0	0
2	5-B	1	Total 10	C 2	H 6	O 2	0	0
2	6-B	1	Total 10	C 2	H 6	O 2	0	0
2	7-B	1	Total 10	C 2	H 6	O 2	0	0
2	8-B	1	Total 10	C 2	H 6	O 2	0	0
2	9-B	1	Total 10	C 2	H 6	O 2	0	0
2	10-B	1	Total 10	C 2	H 6	O 2	0	0
2	11-B	1	Total 10	C 2	H 6	O 2	0	0
2	12-B	1	Total 10	C 2	H 6	O 2	0	0
2	13-B	1	Total 10	C 2	H 6	O 2	0	0
2	14-B	1	Total 10	C 2	H 6	O 2	0	0
2	15-B	1	Total 10	C 2	H 6	O 2	0	0
2	16-B	1	Total 10	C 2	H 6	O 2	0	0
2	17-B	1	Total 10	C 2	H 6	O 2	0	0
2	18-B	1	Total 10	C 2	H 6	O 2	0	0
2	19-B	1	Total 10	C 2	H 6	O 2	0	0
2	20-B	1	Total 10	C 2	H 6	O 2	0	0
2	21-B	1	Total 10	C 2	H 6	O 2	0	0
2	22-B	1	Total 10	C 2	H 6	O 2	0	0
2	23-B	1	Total 10	C 2	H 6	O 2	0	0

Continued on next page...

Continued from previous page...

Mol	Chain	Residues	Atoms				ZeroOcc	AltConf
2	24-B	1	Total	C	H	O	0	0
			10	2	6	2		
2	25-B	1	Total	C	H	O	0	0
			10	2	6	2		
2	1-B	1	Total	C	H	O	0	0
			10	2	6	2		
2	2-B	1	Total	C	H	O	0	0
			10	2	6	2		
2	3-B	1	Total	C	H	O	0	0
			10	2	6	2		
2	4-B	1	Total	C	H	O	0	0
			10	2	6	2		
2	5-B	1	Total	C	H	O	0	0
			10	2	6	2		
2	6-B	1	Total	C	H	O	0	0
			10	2	6	2		
2	7-B	1	Total	C	H	O	0	0
			10	2	6	2		
2	8-B	1	Total	C	H	O	0	0
			10	2	6	2		
2	9-B	1	Total	C	H	O	0	0
			10	2	6	2		
2	10-B	1	Total	C	H	O	0	0
			10	2	6	2		
2	11-B	1	Total	C	H	O	0	0
			10	2	6	2		
2	12-B	1	Total	C	H	O	0	0
			10	2	6	2		
2	13-B	1	Total	C	H	O	0	0
			10	2	6	2		
2	14-B	1	Total	C	H	O	0	0
			10	2	6	2		
2	15-B	1	Total	C	H	O	0	0
			10	2	6	2		
2	16-B	1	Total	C	H	O	0	0
			10	2	6	2		
2	17-B	1	Total	C	H	O	0	0
			10	2	6	2		
2	18-B	1	Total	C	H	O	0	0
			10	2	6	2		
2	19-B	1	Total	C	H	O	0	0
			10	2	6	2		

Continued on next page...

Continued from previous page...

Mol	Chain	Residues	Atoms				ZeroOcc	AltConf
2	20-B	1	Total	C	H	O	0	0
			10	2	6	2		
2	21-B	1	Total	C	H	O	0	0
			10	2	6	2		
2	22-B	1	Total	C	H	O	0	0
			10	2	6	2		
2	23-B	1	Total	C	H	O	0	0
			10	2	6	2		
2	24-B	1	Total	C	H	O	0	0
			10	2	6	2		
2	25-B	1	Total	C	H	O	0	0
			10	2	6	2		

- Molecule 3 is beta-D-glucopyranose (three-letter code: BGC) (formula: $C_6H_{12}O_6$).

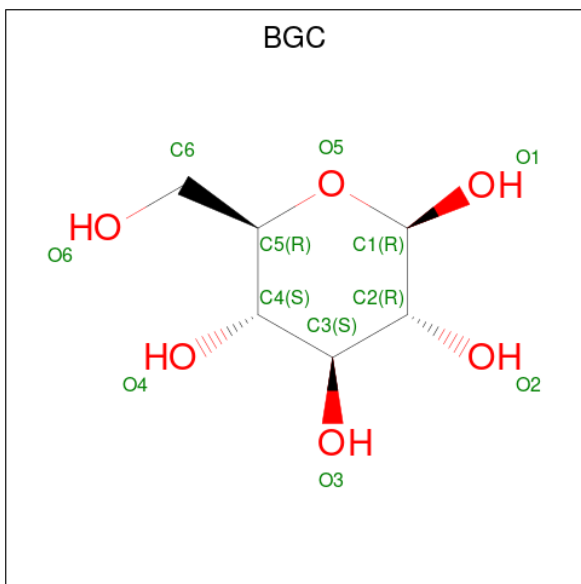

Mol	Chain	Residues	Atoms				ZeroOcc	AltConf
3	1-B	1	Total	C	H	O	0	0
			24	6	12	6		
3	2-B	1	Total	C	H	O	0	0
			24	6	12	6		
3	3-B	1	Total	C	H	O	0	0
			24	6	12	6		
3	4-B	1	Total	C	H	O	0	0
			24	6	12	6		
3	5-B	1	Total	C	H	O	0	0
			24	6	12	6		

Continued on next page...

Continued from previous page...

Mol	Chain	Residues	Atoms				ZeroOcc	AltConf
3	6-B	1	Total	C	H	O	0	0
			24	6	12	6		
3	7-B	1	Total	C	H	O	0	0
			24	6	12	6		
3	8-B	1	Total	C	H	O	0	0
			24	6	12	6		
3	9-B	1	Total	C	H	O	0	0
			24	6	12	6		
3	10-B	1	Total	C	H	O	0	0
			24	6	12	6		
3	11-B	1	Total	C	H	O	0	0
			24	6	12	6		
3	12-B	1	Total	C	H	O	0	0
			24	6	12	6		
3	13-B	1	Total	C	H	O	0	0
			24	6	12	6		
3	14-B	1	Total	C	H	O	0	0
			24	6	12	6		
3	15-B	1	Total	C	H	O	0	0
			24	6	12	6		
3	16-B	1	Total	C	H	O	0	0
			24	6	12	6		
3	17-B	1	Total	C	H	O	0	0
			24	6	12	6		
3	18-B	1	Total	C	H	O	0	0
			24	6	12	6		
3	19-B	1	Total	C	H	O	0	0
			24	6	12	6		
3	20-B	1	Total	C	H	O	0	0
			24	6	12	6		
3	21-B	1	Total	C	H	O	0	0
			24	6	12	6		
3	22-B	1	Total	C	H	O	0	0
			24	6	12	6		
3	23-B	1	Total	C	H	O	0	0
			24	6	12	6		
3	24-B	1	Total	C	H	O	0	0
			24	6	12	6		
3	25-B	1	Total	C	H	O	0	0
			24	6	12	6		

- Molecule 4 is water.

Mol	Chain	Residues	Atoms	ZeroOcc	AltConf
4	1-A	240	Total O 240 240	0	0
4	2-A	253	Total O 253 253	0	0
4	3-A	262	Total O 262 262	0	0
4	4-A	244	Total O 244 244	0	0
4	5-A	270	Total O 270 270	0	0
4	6-A	247	Total O 247 247	0	0
4	7-A	254	Total O 254 254	0	0
4	8-A	243	Total O 243 243	0	0
4	9-A	237	Total O 237 237	0	0
4	10-A	254	Total O 254 254	0	0
4	11-A	232	Total O 232 232	0	0
4	12-A	239	Total O 239 239	0	0
4	13-A	257	Total O 257 257	0	0
4	14-A	251	Total O 251 251	0	0
4	15-A	246	Total O 246 246	0	0
4	16-A	252	Total O 252 252	0	0
4	17-A	246	Total O 246 246	0	0
4	18-A	258	Total O 258 258	0	0
4	19-A	248	Total O 248 248	0	0
4	20-A	237	Total O 237 237	0	0
4	21-A	242	Total O 242 242	0	0
4	22-A	251	Total O 251 251	0	0

Continued on next page...

Continued from previous page...

Mol	Chain	Residues	Atoms	ZeroOcc	AltConf
4	23-A	248	Total O 248 248	0	0
4	24-A	239	Total O 239 239	0	0
4	25-A	240	Total O 240 240	0	0
4	1-B	263	Total O 263 263	0	0
4	2-B	236	Total O 236 236	0	0
4	3-B	224	Total O 224 224	0	0
4	4-B	246	Total O 246 246	0	0
4	5-B	233	Total O 233 233	0	0
4	6-B	243	Total O 243 243	0	0
4	7-B	236	Total O 236 236	0	0
4	8-B	242	Total O 242 242	0	0
4	9-B	240	Total O 240 240	0	0
4	10-B	252	Total O 252 252	0	0
4	11-B	252	Total O 252 252	0	0
4	12-B	263	Total O 263 263	0	0
4	13-B	231	Total O 231 231	0	0
4	14-B	246	Total O 246 246	0	0
4	15-B	239	Total O 239 239	0	0
4	16-B	246	Total O 246 246	0	0
4	17-B	238	Total O 238 238	0	0
4	18-B	251	Total O 251 251	0	0

Continued on next page...

Continued from previous page...

Mol	Chain	Residues	Atoms		ZeroOcc	AltConf
4	19-B	228	Total 228	O 228	0	0
4	20-B	230	Total 230	O 230	0	0
4	21-B	240	Total 240	O 240	0	0
4	22-B	267	Total 267	O 267	0	0
4	23-B	248	Total 248	O 248	0	0
4	24-B	241	Total 241	O 241	0	0
4	25-B	242	Total 242	O 242	0	0

3 Residue-property plots [i](#)

These plots are drawn for all protein, RNA, DNA and oligosaccharide chains in the entry. The first graphic for a chain summarises the proportions of the various outlier classes displayed in the second graphic. The second graphic shows the sequence view annotated by issues in geometry and electron density. Residues are color-coded according to the number of geometric quality criteria for which they contain at least one outlier: green = 0, yellow = 1, orange = 2 and red = 3 or more. A red dot above a residue indicates a poor fit to the electron density ($RSRZ > 2$). Stretches of 2 or more consecutive residues without any outlier are shown as a green connector. Residues present in the sample, but not in the model, are shown in grey.

- Molecule 1: Putative secreted protein

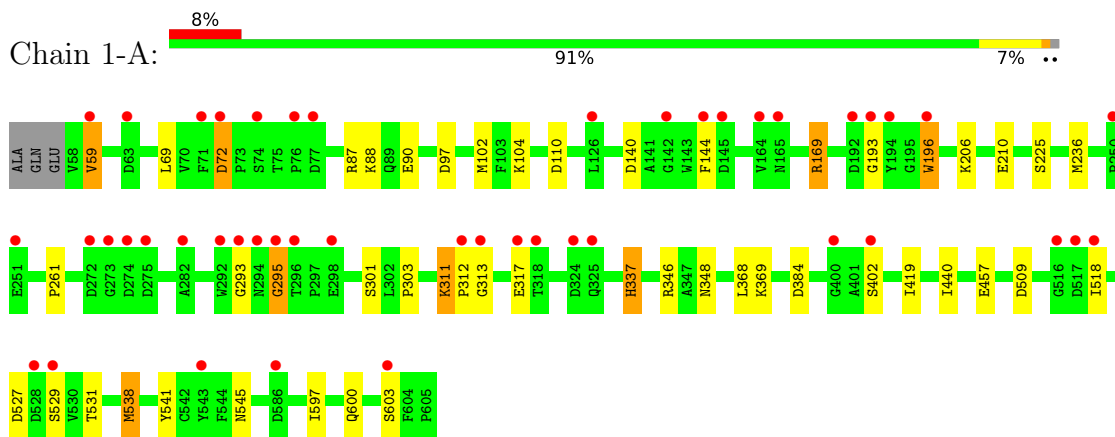

- Molecule 1: Putative secreted protein

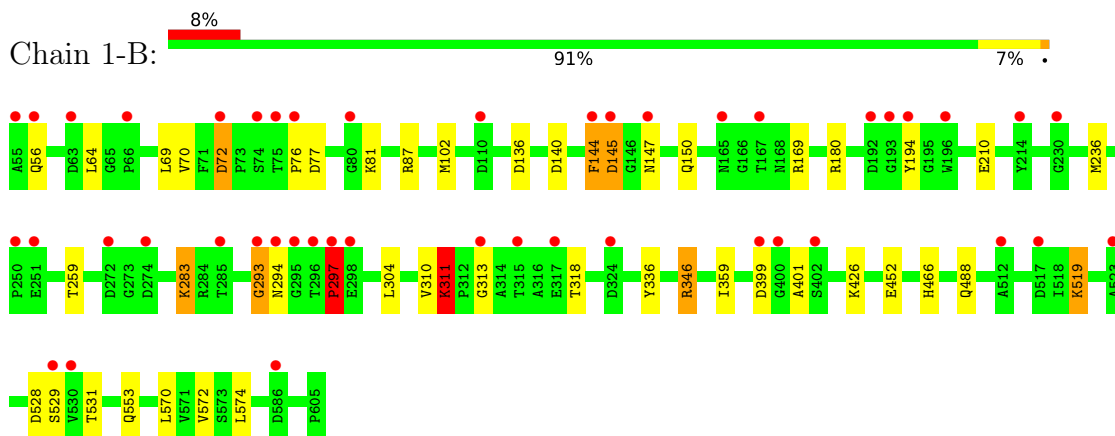

- Molecule 1: Putative secreted protein

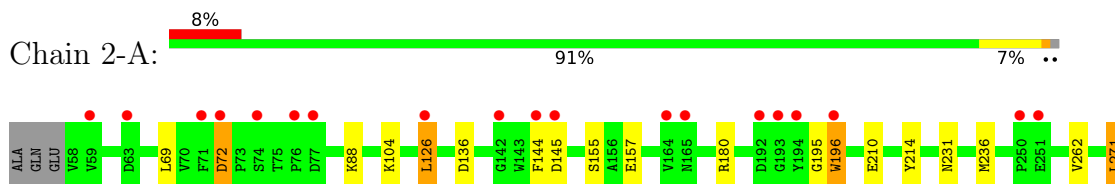

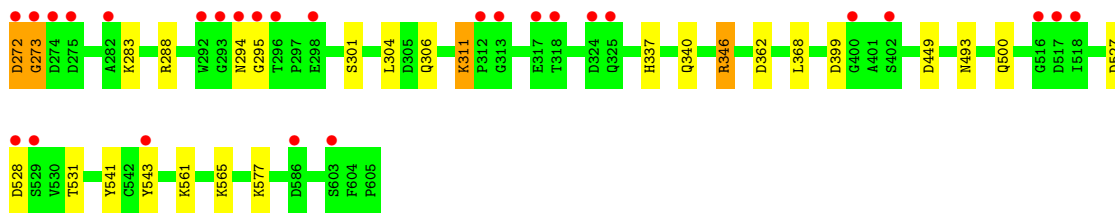

● Molecule 1: Putative secreted protein

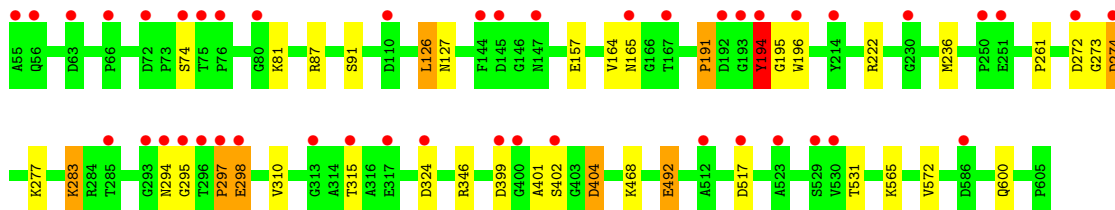

● Molecule 1: Putative secreted protein

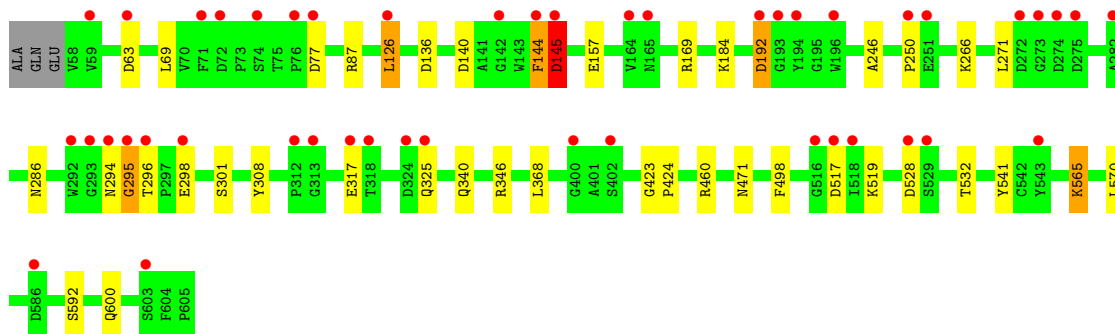

● Molecule 1: Putative secreted protein

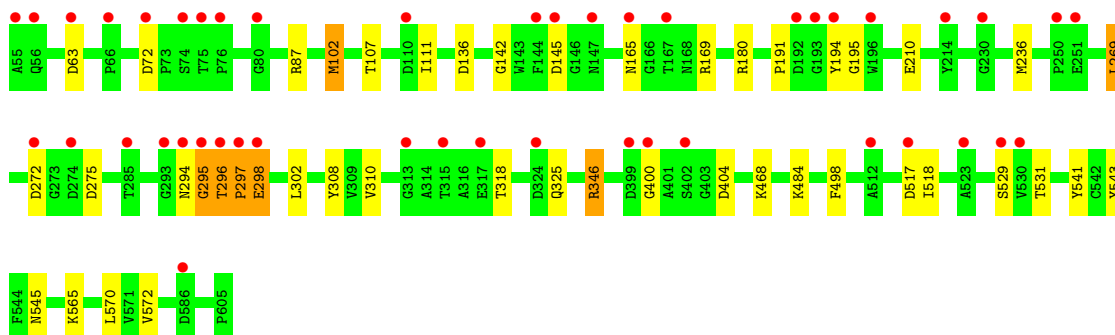

● Molecule 1: Putative secreted protein



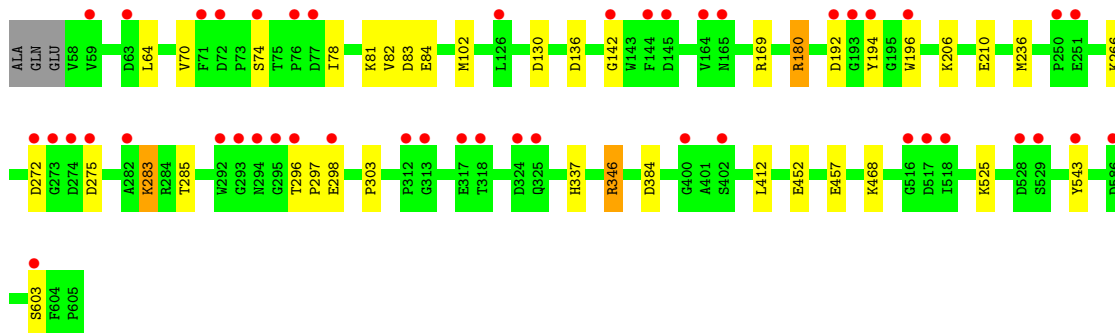

• Molecule 1: Putative secreted protein

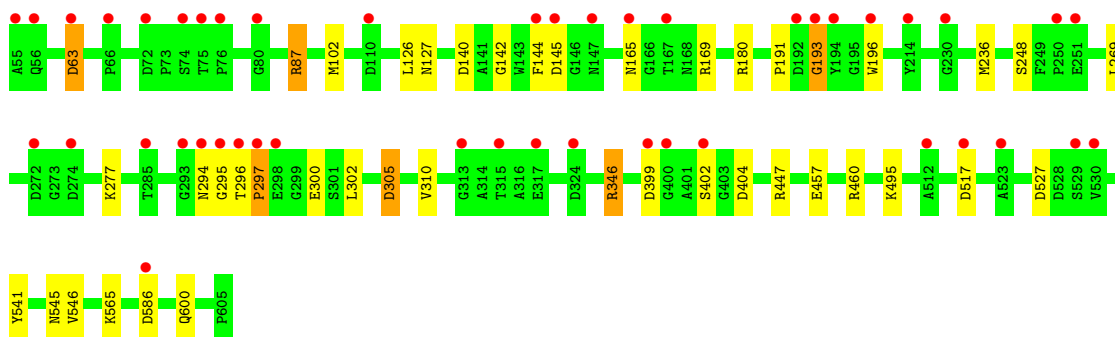

• Molecule 1: Putative secreted protein

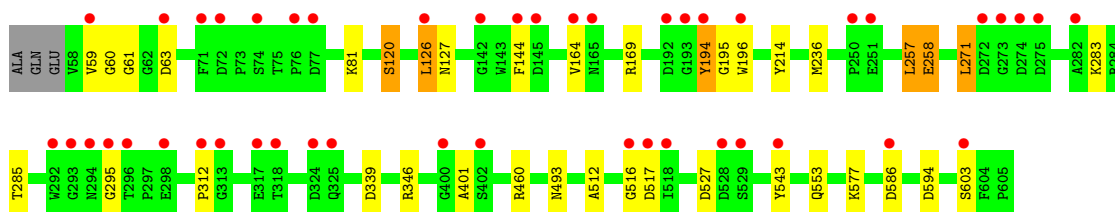

• Molecule 1: Putative secreted protein

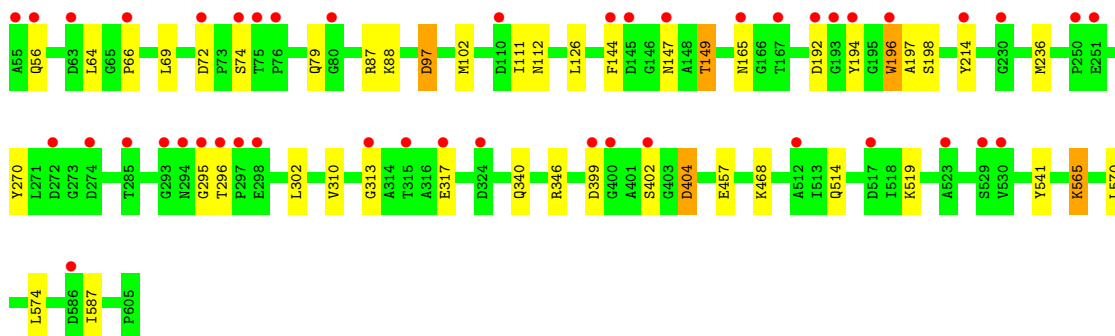

- Molecule 1: Putative secreted protein

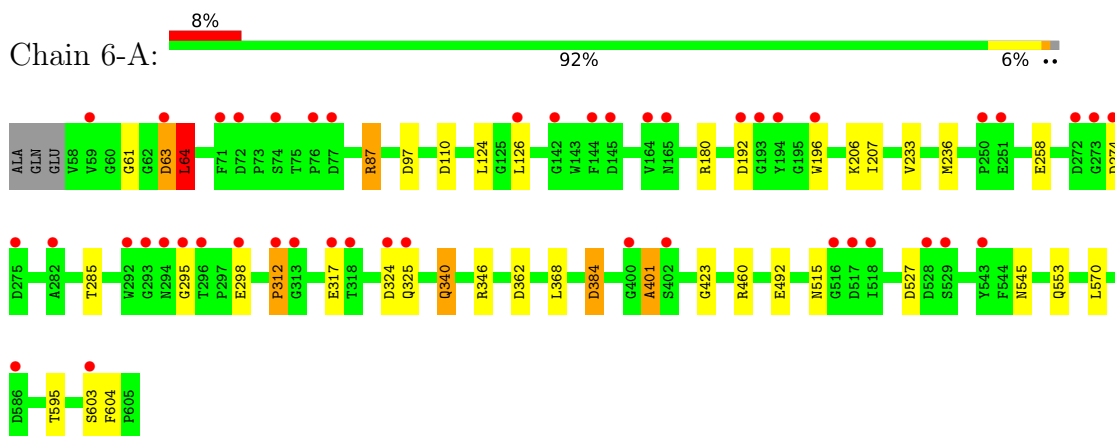

- Molecule 1: Putative secreted protein

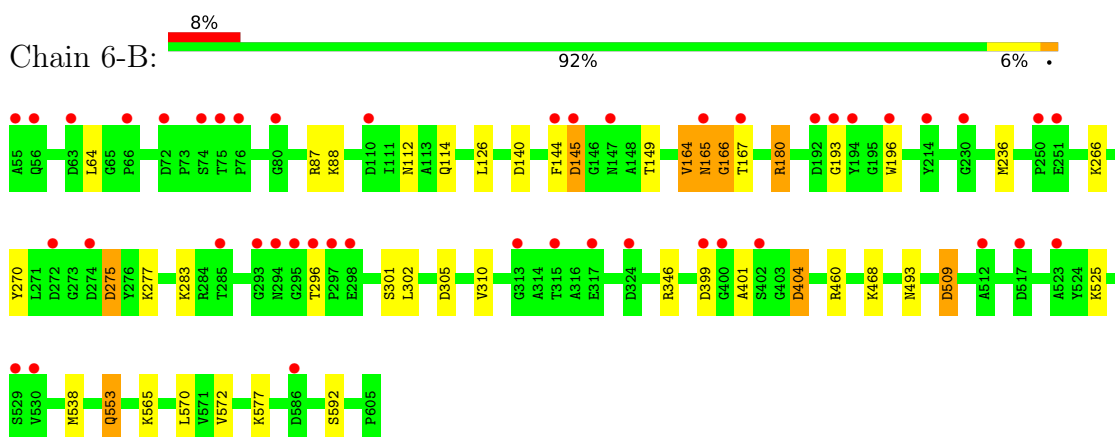

- Molecule 1: Putative secreted protein

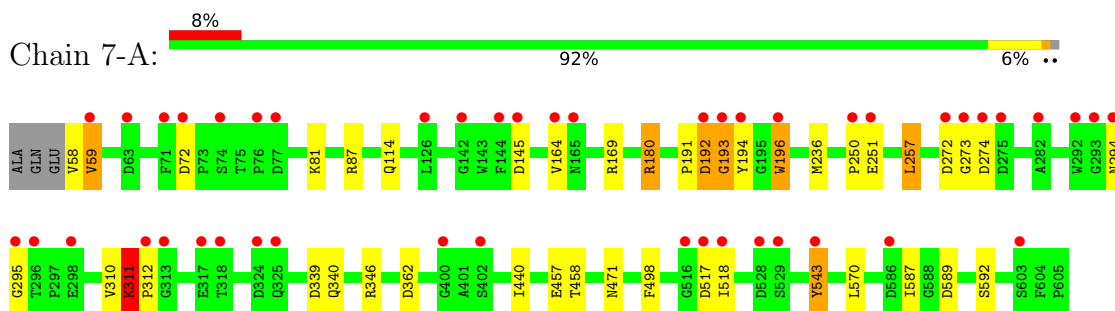

- Molecule 1: Putative secreted protein

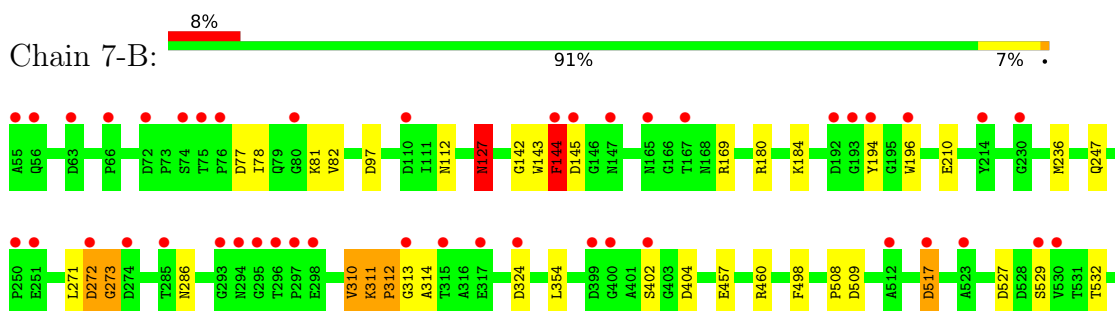



• Molecule 1: Putative secreted protein

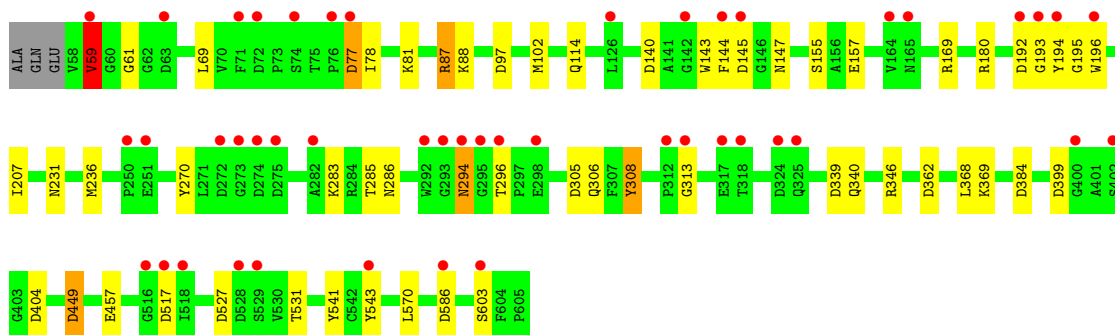
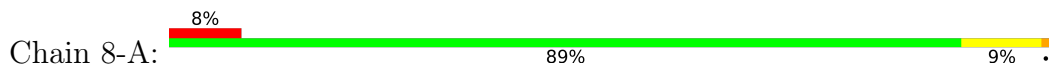

• Molecule 1: Putative secreted protein

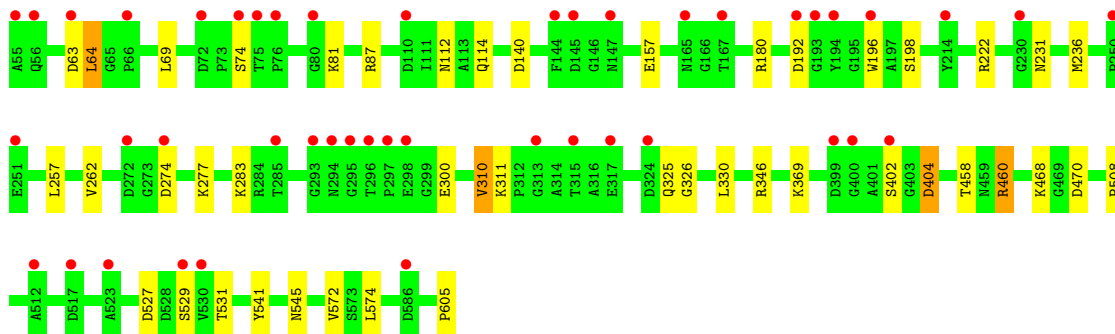

• Molecule 1: Putative secreted protein

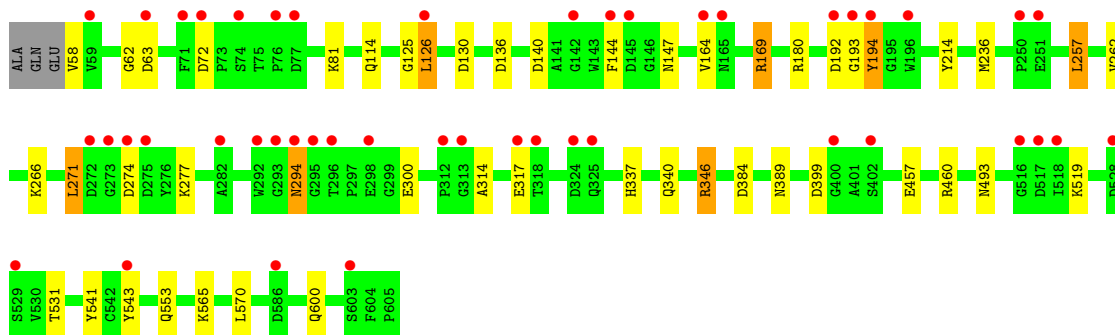

• Molecule 1: Putative secreted protein

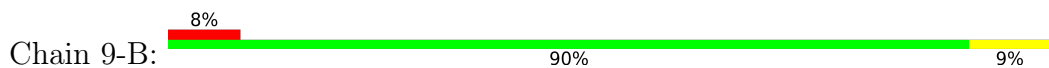

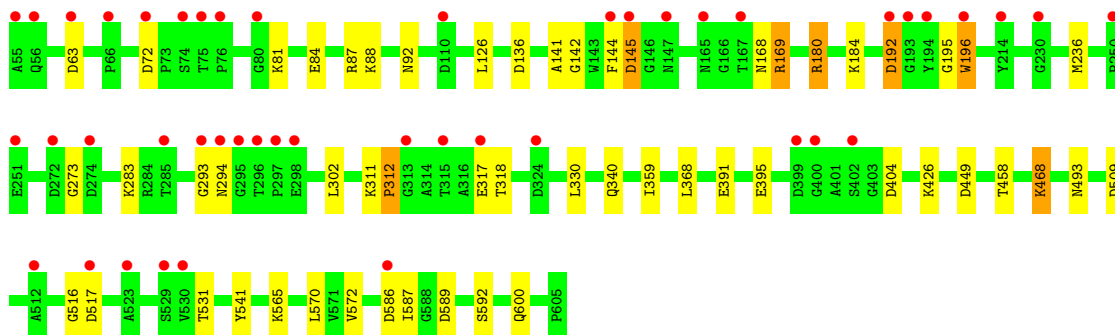

- Molecule 1: Putative secreted protein

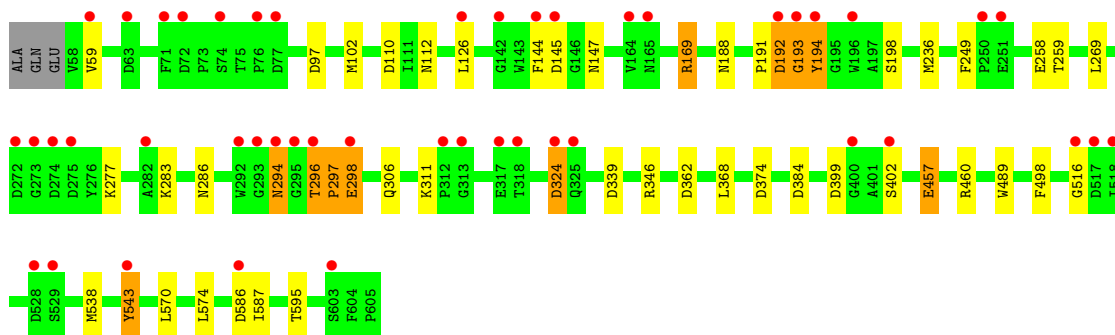

- Molecule 1: Putative secreted protein

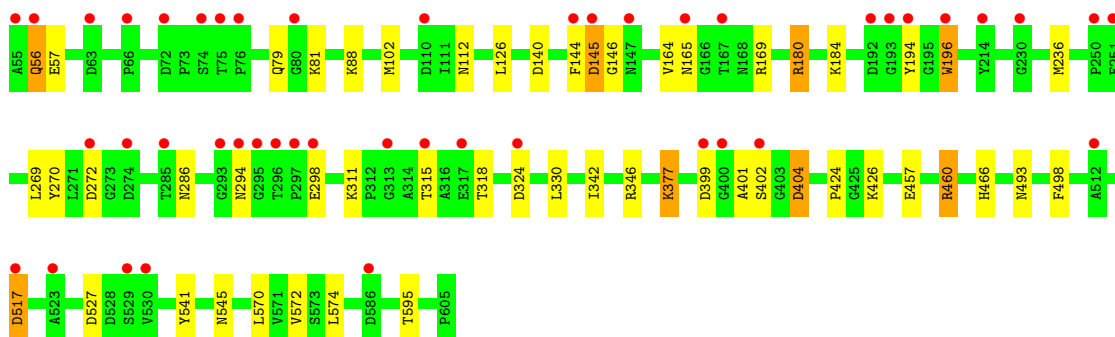

- Molecule 1: Putative secreted protein

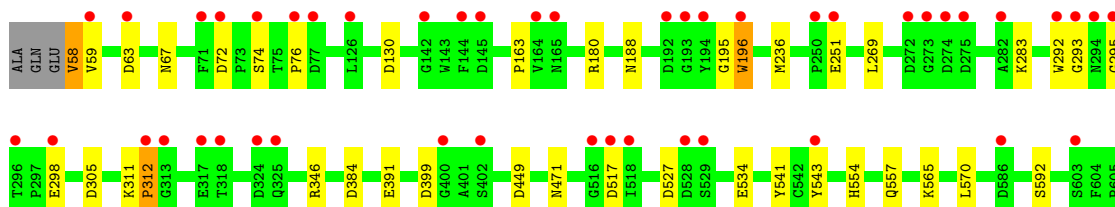

- Molecule 1: Putative secreted protein

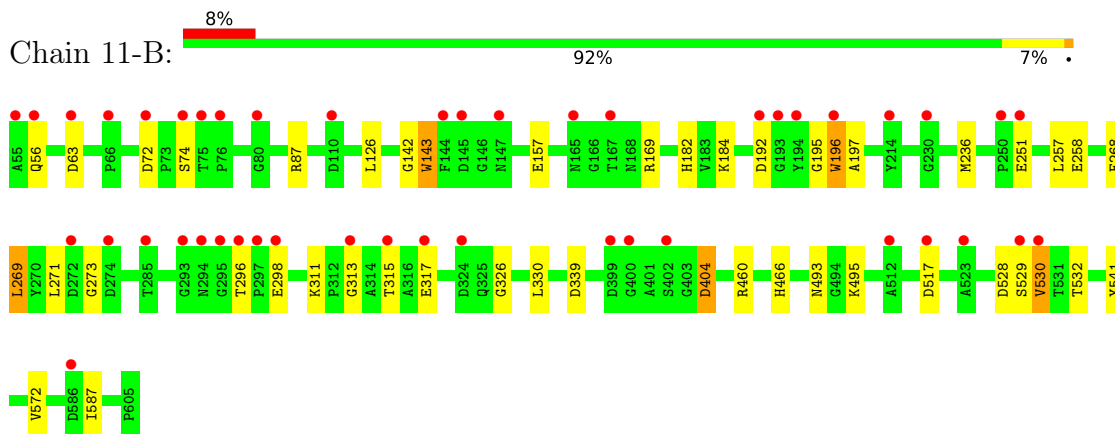

- Molecule 1: Putative secreted protein

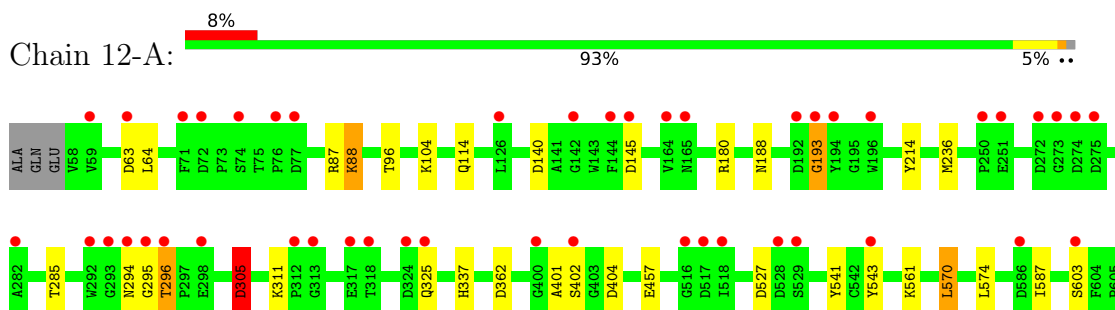

- Molecule 1: Putative secreted protein

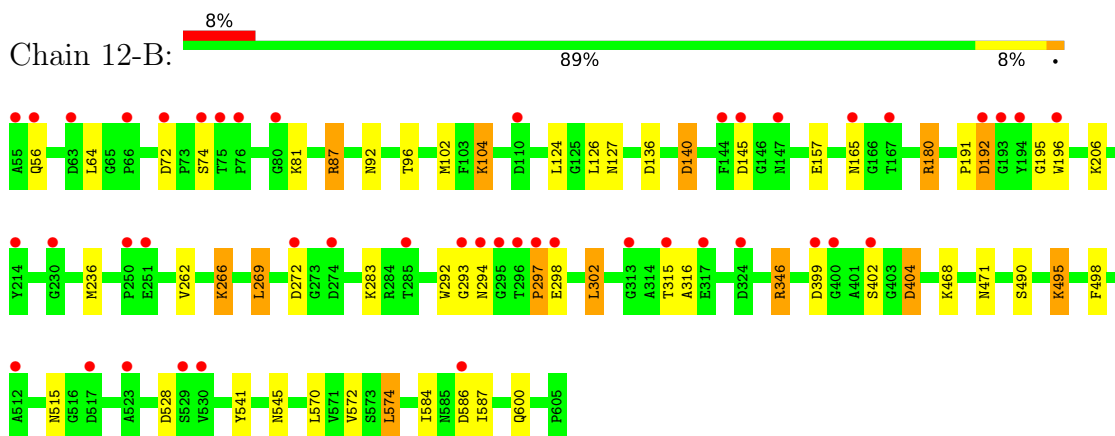

- Molecule 1: Putative secreted protein

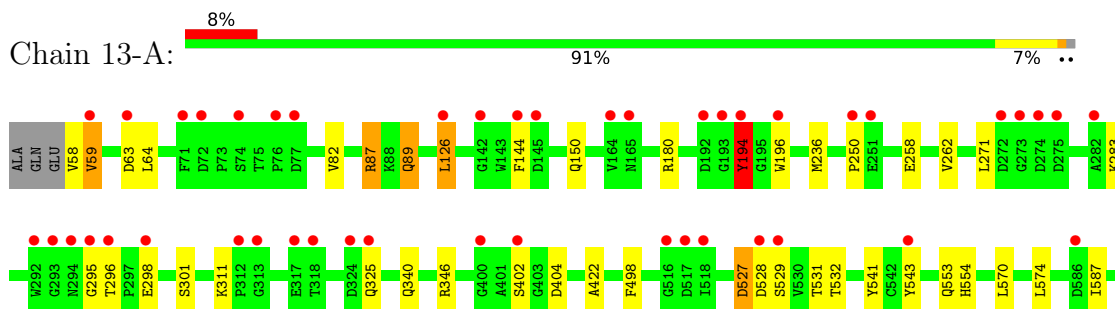



• Molecule 1: Putative secreted protein

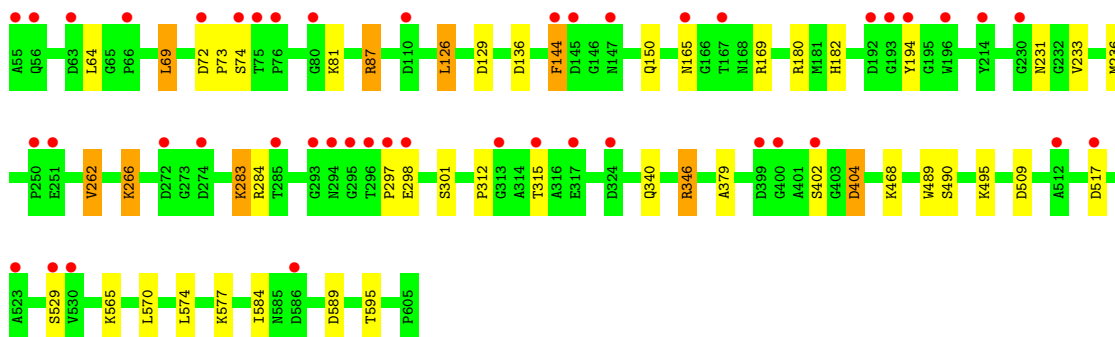

• Molecule 1: Putative secreted protein

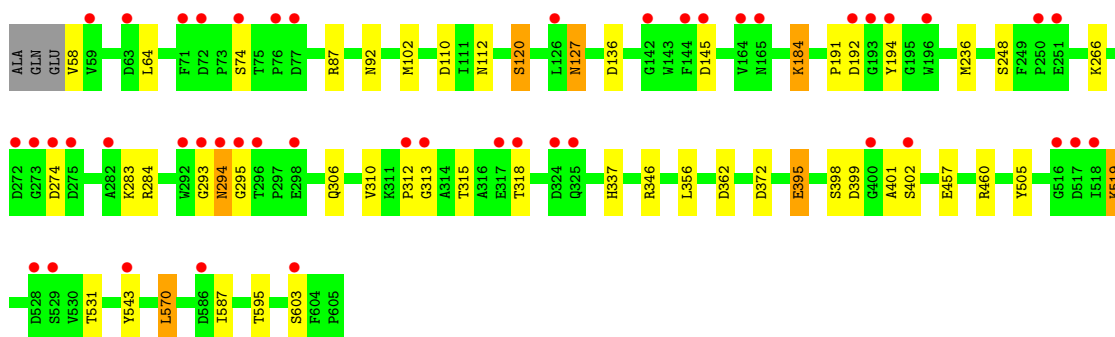

• Molecule 1: Putative secreted protein

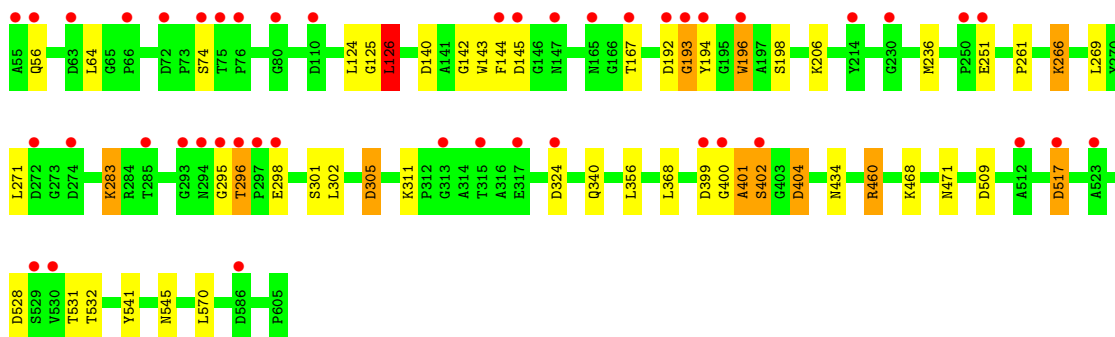
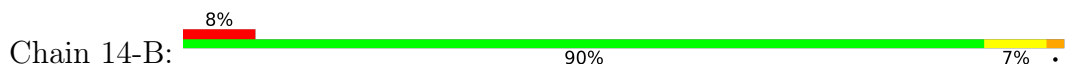

• Molecule 1: Putative secreted protein



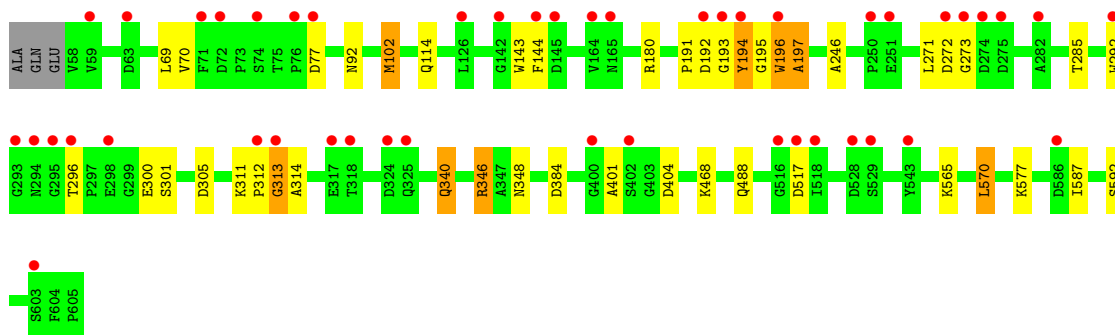

• Molecule 1: Putative secreted protein

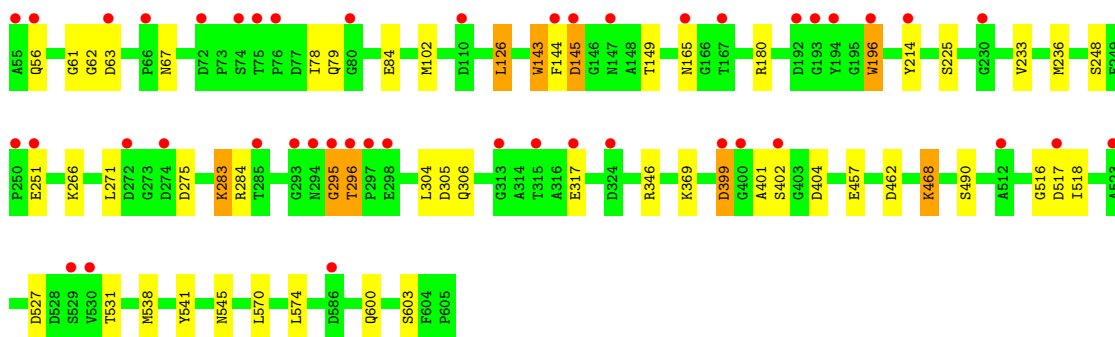

• Molecule 1: Putative secreted protein

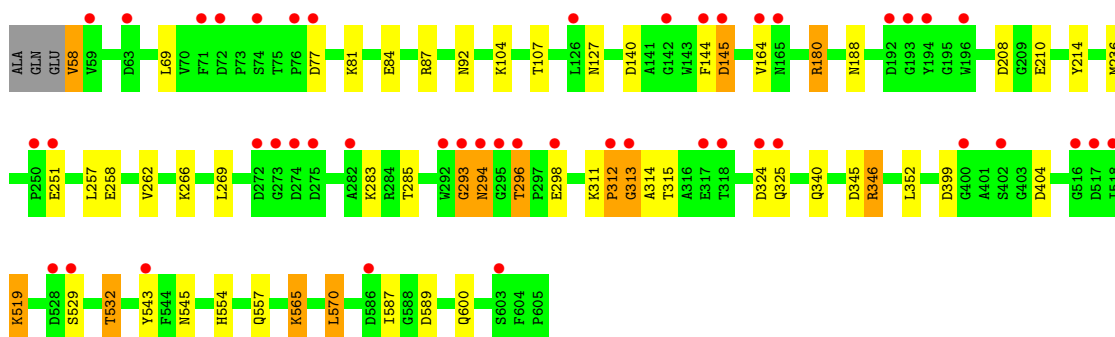
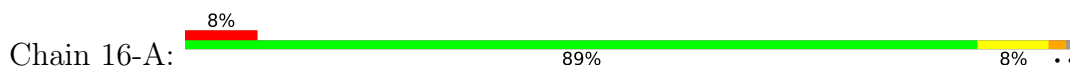

• Molecule 1: Putative secreted protein

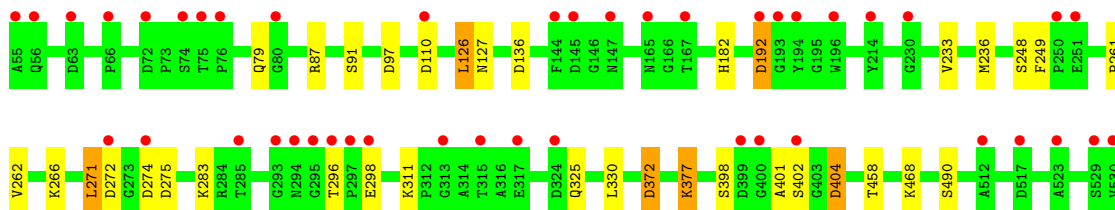



- Molecule 1: Putative secreted protein

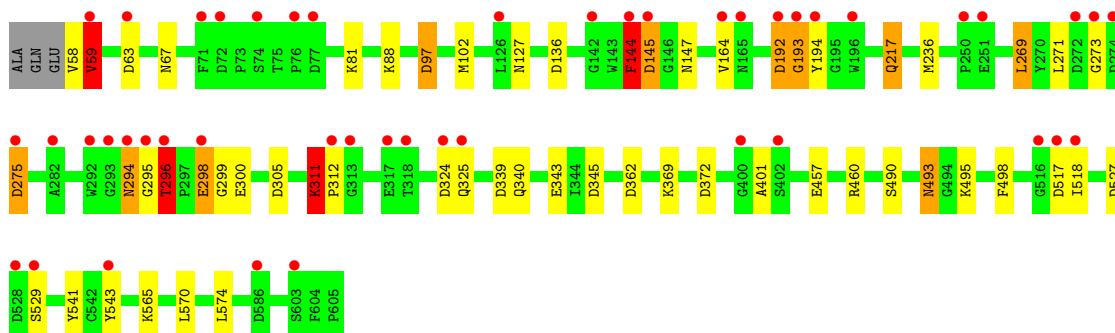
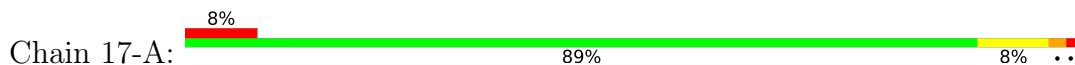

- Molecule 1: Putative secreted protein

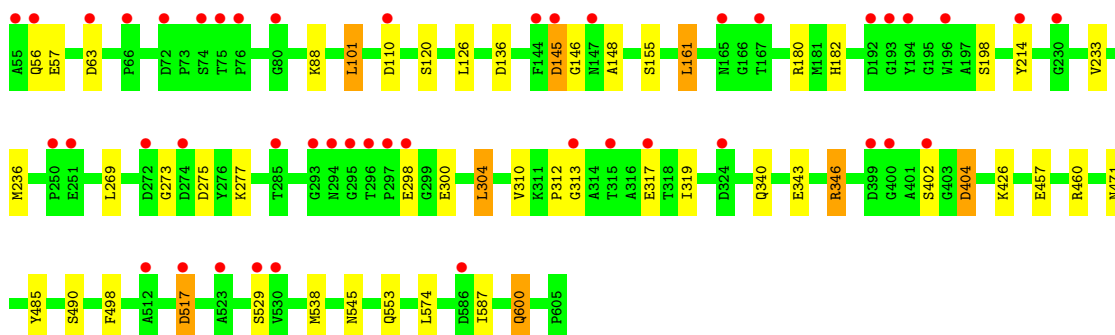
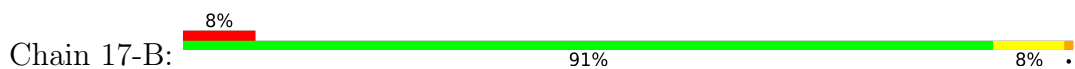

- Molecule 1: Putative secreted protein

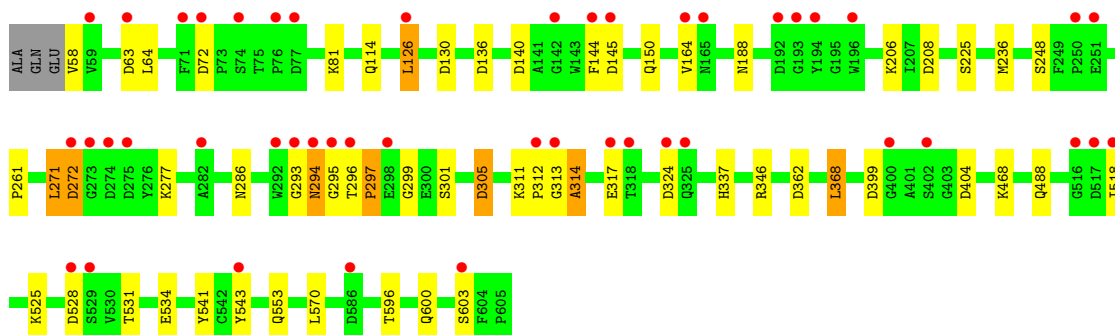
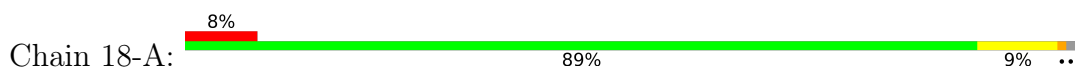

- Molecule 1: Putative secreted protein



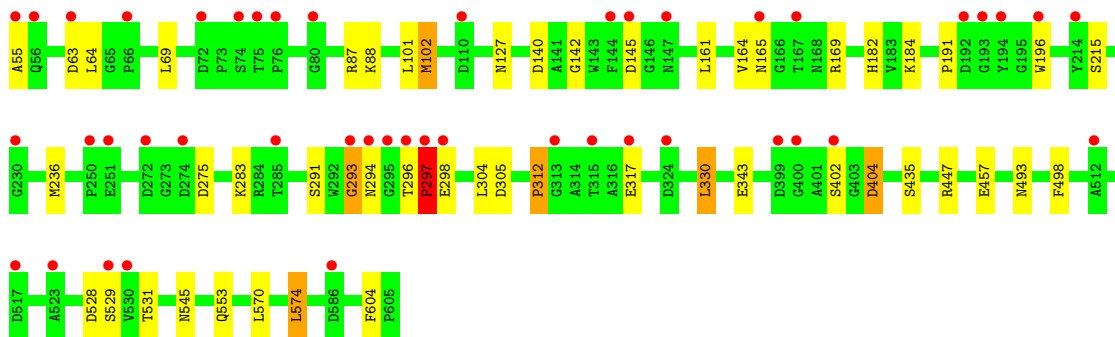

- Molecule 1: Putative secreted protein

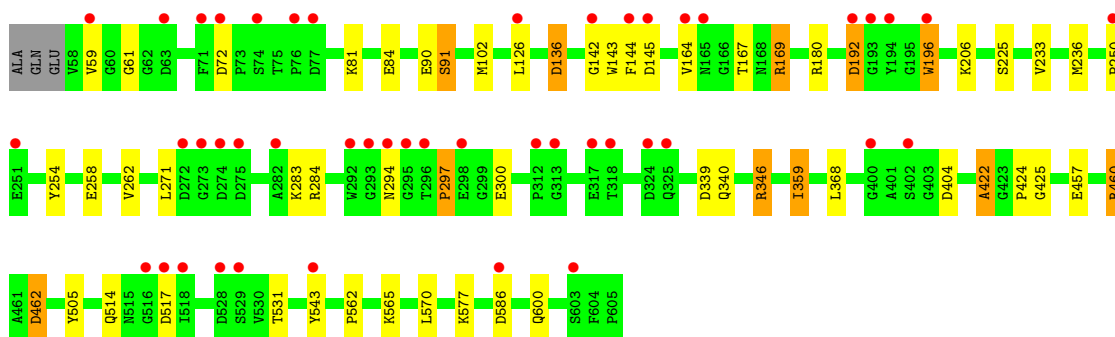
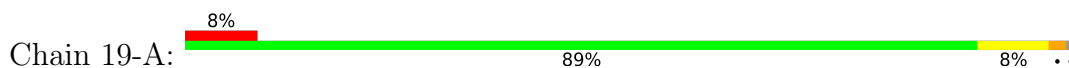

- Molecule 1: Putative secreted protein

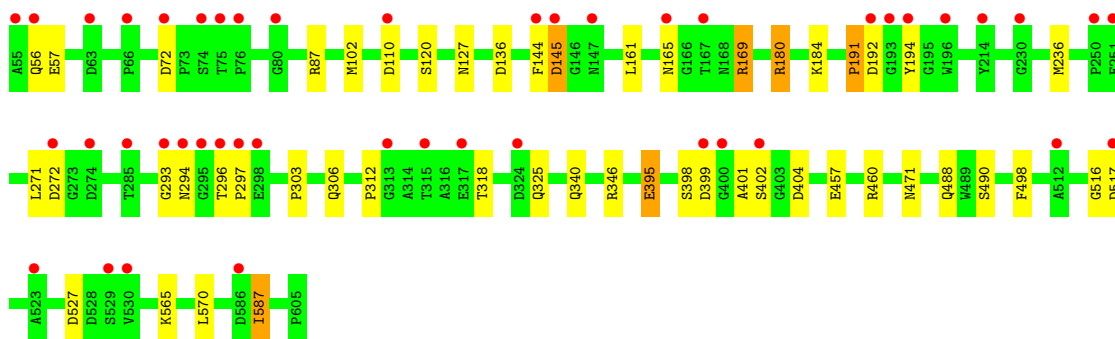

- Molecule 1: Putative secreted protein

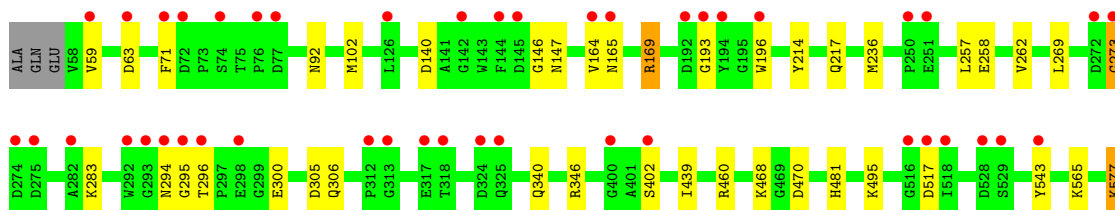

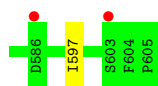

• Molecule 1: Putative secreted protein

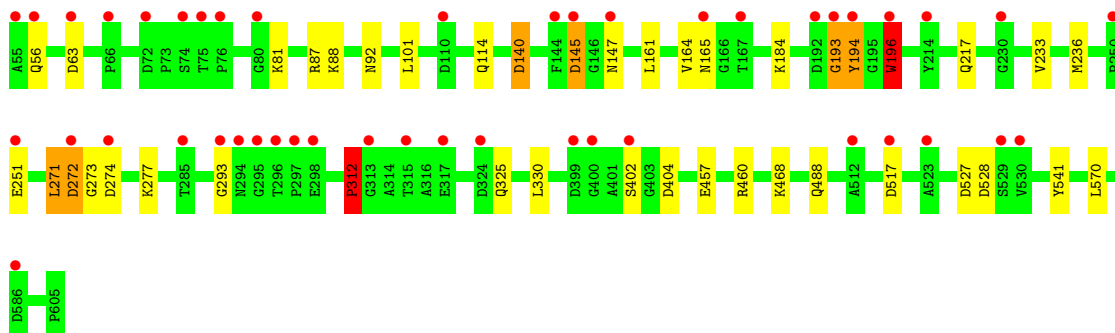

• Molecule 1: Putative secreted protein

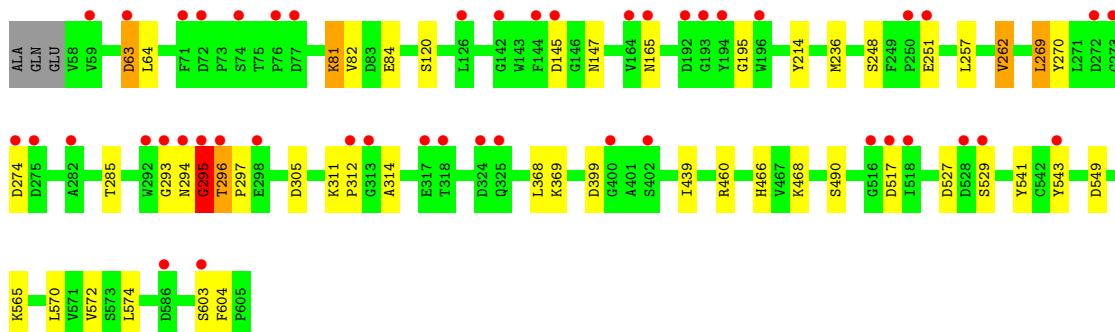
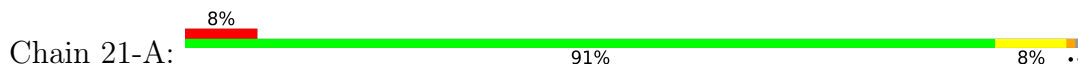

• Molecule 1: Putative secreted protein

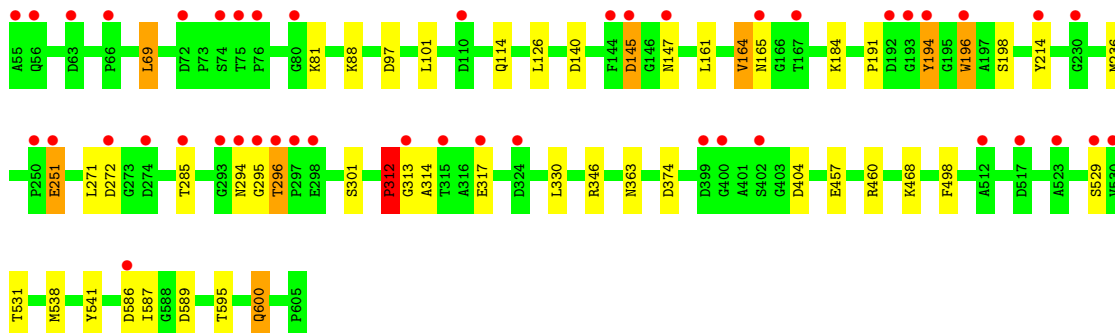

• Molecule 1: Putative secreted protein



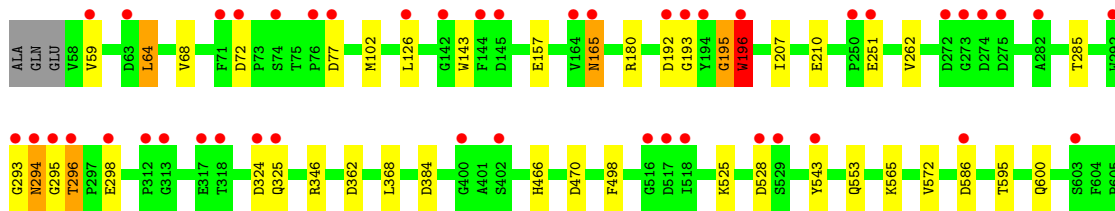

● Molecule 1: Putative secreted protein

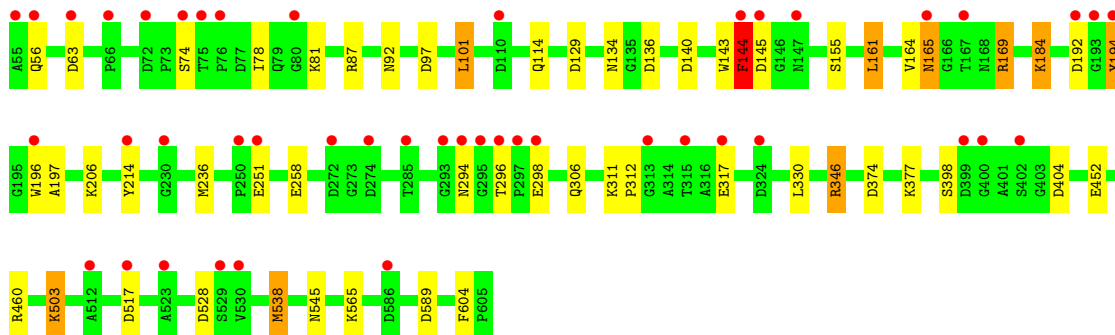
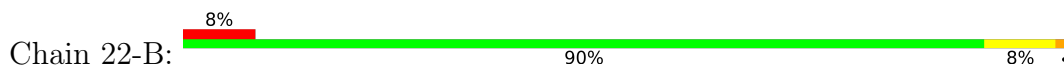

● Molecule 1: Putative secreted protein

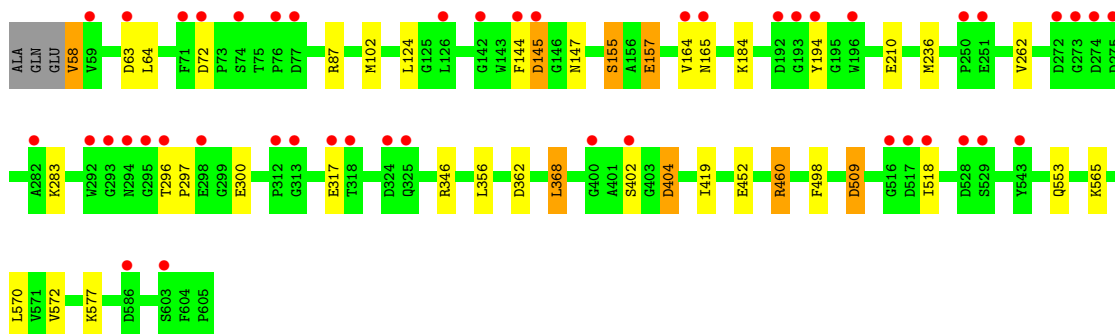

● Molecule 1: Putative secreted protein

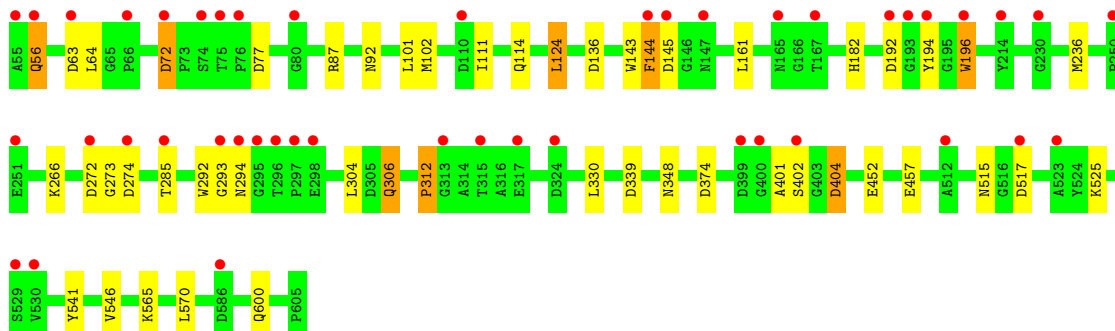

- Molecule 1: Putative secreted protein

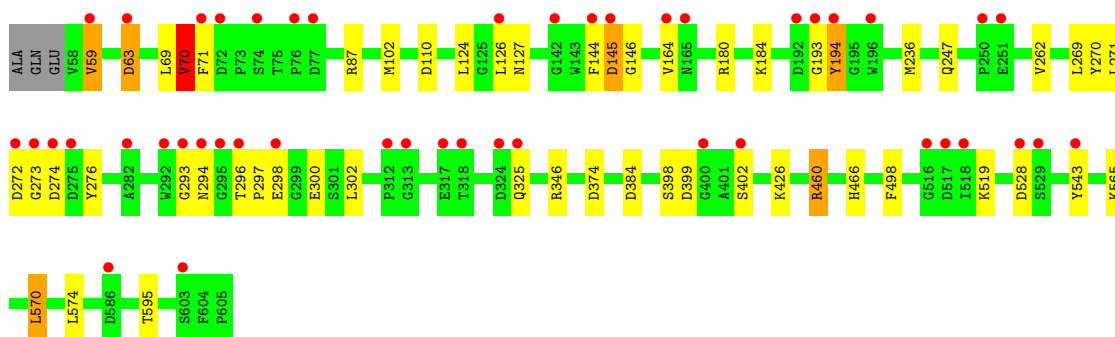
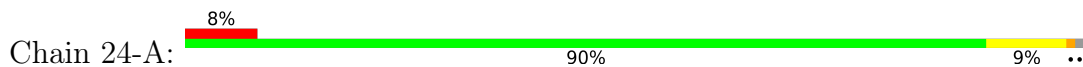

- Molecule 1: Putative secreted protein

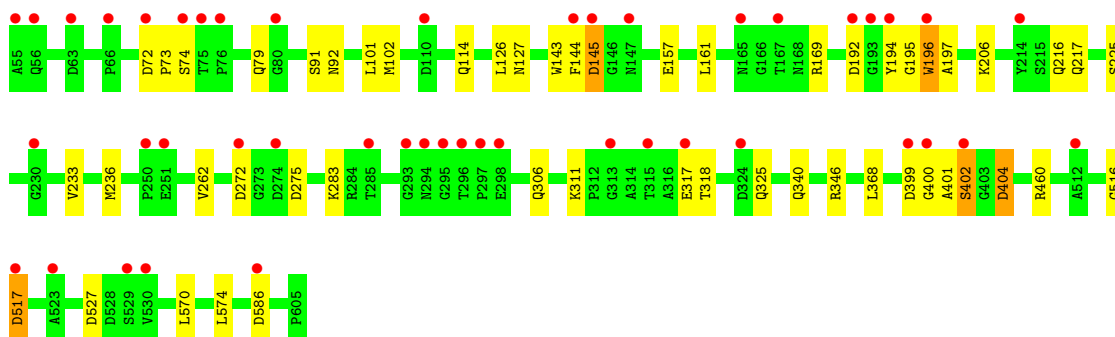

- Molecule 1: Putative secreted protein

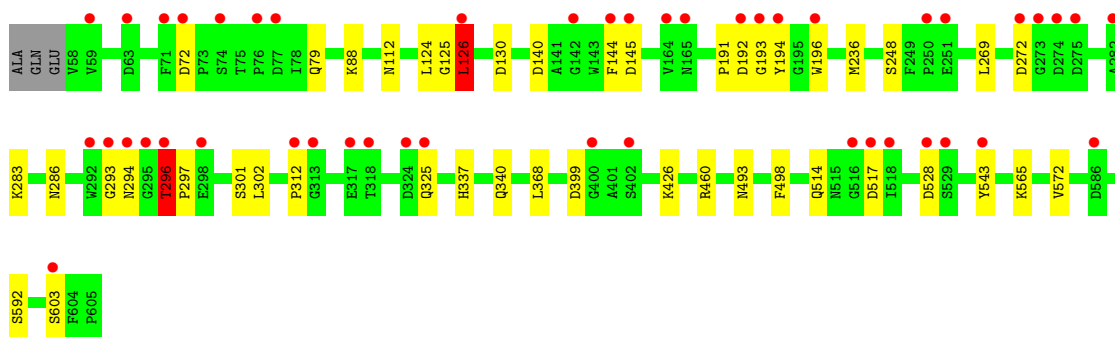

- Molecule 1: Putative secreted protein

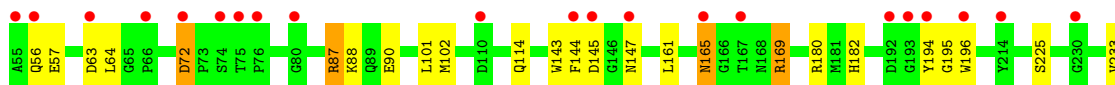

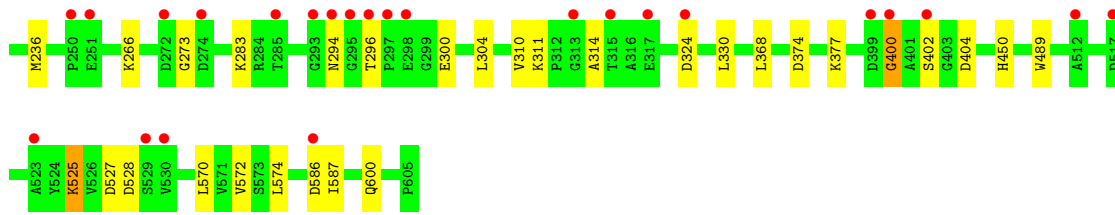

4 Data and refinement statistics i

Property	Value	Source
Space group	P 1 21 1	Depositor
Cell constants a, b, c, α , β , γ	53.94Å 100.06Å 99.56Å 90.00° 92.31° 90.00°	Depositor
Resolution (Å)	24.27 – 1.75 24.26 – 1.75	Depositor ED
% Data completeness (in resolution range)	98.8 (24.27-1.75) 92.8 (24.26-1.75)	Depositor ED
R_{merge}	0.08	Depositor
R_{sym}	(Not available)	Depositor
$\langle I/\sigma(I) \rangle$ ¹	2.99 (at 1.75Å)	Xtriage
Refinement program	PHENIX (PHENIX.ENSEMBLE_REFINEMENT: 1.9_1692)	Depositor
R, R_{free}	0.110 , 0.143 0.140 , 0.173	Depositor DC
R_{free} test set	5256 reflections (5.01%)	wwPDB
Wilson B-factor (Å ²)	14.7	Xtriage
Anisotropy	0.049	Xtriage
Bulk solvent k_{sol} (e/Å ³), B_{sol} (Å ²)	0.31 , 182.0	ED
L-test for twinning ²	$\langle L \rangle = 0.50$, $\langle L^2 \rangle = 0.34$	Xtriage
Estimated twinning fraction	0.000 for -h,-l,-k 0.000 for -h,l,k 0.026 for h,-k,-l	Xtriage
F_o, F_c correlation	0.97	ED
Total number of atoms	418117	wwPDB
Average B, all atoms (Å ²)	13.0	wwPDB

Xtriage's analysis on translational NCS is as follows: *The analyses of the Patterson function reveals a significant off-origin peak that is 45.00 % of the origin peak, indicating pseudo-translational symmetry. The chance of finding a peak of this or larger height randomly in a structure without pseudo-translational symmetry is equal to 1.4083e-04. The detected translational NCS is most likely also responsible for the elevated intensity ratio.*

¹Intensities estimated from amplitudes.

²Theoretical values of $\langle |L| \rangle$, $\langle L^2 \rangle$ for acentric reflections are 0.5, 0.333 respectively for untwinned datasets, and 0.375, 0.2 for perfectly twinned datasets.

5 Model quality

5.1 Standard geometry

Bond lengths and bond angles in the following residue types are not validated in this section: EDO, BGC

The Z score for a bond length (or angle) is the number of standard deviations the observed value is removed from the expected value. A bond length (or angle) with $|Z| > 5$ is considered an outlier worth inspection. RMSZ is the root-mean-square of all Z scores of the bond lengths (or angles).

Mol	Chain	Bond lengths		Bond angles	
		RMSZ	# Z >5	RMSZ	# Z >5
1	1-A	0.81	3/4271 (0.1%)	0.93	9/5836 (0.2%)
1	1-B	0.80	5/4294 (0.1%)	0.95	12/5867 (0.2%)
1	2-A	0.77	0/4271	0.91	9/5836 (0.2%)
1	2-B	0.81	8/4294 (0.2%)	0.92	7/5867 (0.1%)
1	3-A	0.79	5/4271 (0.1%)	0.93	12/5836 (0.2%)
1	3-B	0.81	5/4294 (0.1%)	0.91	6/5867 (0.1%)
1	4-A	0.81	6/4271 (0.1%)	0.92	12/5836 (0.2%)
1	4-B	0.79	4/4294 (0.1%)	0.95	12/5867 (0.2%)
1	5-A	0.78	4/4271 (0.1%)	0.90	5/5836 (0.1%)
1	5-B	0.79	3/4294 (0.1%)	0.93	8/5867 (0.1%)
1	6-A	0.78	2/4271 (0.0%)	0.95	8/5836 (0.1%)
1	6-B	0.82	3/4294 (0.1%)	0.96	14/5867 (0.2%)
1	7-A	0.76	3/4271 (0.1%)	0.95	13/5836 (0.2%)
1	7-B	0.80	4/4294 (0.1%)	0.95	14/5867 (0.2%)
1	8-A	0.81	3/4271 (0.1%)	0.98	14/5836 (0.2%)
1	8-B	0.82	6/4294 (0.1%)	0.96	9/5867 (0.2%)
1	9-A	0.77	3/4271 (0.1%)	0.90	11/5836 (0.2%)
1	9-B	0.79	6/4294 (0.1%)	0.94	9/5867 (0.2%)
1	10-A	0.77	2/4271 (0.0%)	0.92	12/5836 (0.2%)
1	10-B	0.83	6/4294 (0.1%)	0.94	7/5867 (0.1%)
1	11-A	0.75	2/4271 (0.0%)	0.91	8/5836 (0.1%)
1	11-B	0.81	4/4294 (0.1%)	0.92	6/5867 (0.1%)
1	12-A	0.76	3/4271 (0.1%)	0.92	9/5836 (0.2%)
1	12-B	0.80	4/4294 (0.1%)	0.96	16/5867 (0.3%)
1	13-A	0.83	7/4271 (0.2%)	0.92	11/5836 (0.2%)
1	13-B	0.84	4/4294 (0.1%)	1.01	20/5867 (0.3%)
1	14-A	0.77	7/4271 (0.2%)	0.94	9/5836 (0.2%)
1	14-B	0.80	3/4294 (0.1%)	0.94	12/5867 (0.2%)
1	15-A	0.75	1/4271 (0.0%)	0.94	16/5836 (0.3%)
1	15-B	0.80	2/4294 (0.0%)	0.95	12/5867 (0.2%)
1	16-A	0.80	6/4271 (0.1%)	0.93	13/5836 (0.2%)
1	16-B	0.79	4/4294 (0.1%)	0.90	10/5867 (0.2%)

Mol	Chain	Bond lengths		Bond angles	
		RMSZ	# Z >5	RMSZ	# Z >5
1	17-A	0.81	6/4271 (0.1%)	0.95	14/5836 (0.2%)
1	17-B	0.80	9/4294 (0.2%)	0.94	8/5867 (0.1%)
1	18-A	0.76	0/4271	0.93	10/5836 (0.2%)
1	18-B	0.80	7/4294 (0.2%)	0.92	9/5867 (0.2%)
1	19-A	0.84	8/4271 (0.2%)	1.01	16/5836 (0.3%)
1	19-B	0.81	4/4294 (0.1%)	0.94	9/5867 (0.2%)
1	20-A	0.76	3/4271 (0.1%)	0.89	6/5836 (0.1%)
1	20-B	0.77	2/4294 (0.0%)	0.90	6/5867 (0.1%)
1	21-A	0.77	2/4271 (0.0%)	0.92	7/5836 (0.1%)
1	21-B	0.79	4/4294 (0.1%)	0.95	15/5867 (0.3%)
1	22-A	0.78	6/4271 (0.1%)	0.94	12/5836 (0.2%)
1	22-B	0.78	3/4294 (0.1%)	0.97	21/5867 (0.4%)
1	23-A	0.76	3/4271 (0.1%)	0.91	9/5836 (0.2%)
1	23-B	0.76	3/4294 (0.1%)	0.94	13/5867 (0.2%)
1	24-A	0.78	1/4271 (0.0%)	0.97	15/5836 (0.3%)
1	24-B	0.79	5/4294 (0.1%)	0.92	8/5867 (0.1%)
1	25-A	0.79	2/4271 (0.0%)	0.93	10/5836 (0.2%)
1	25-B	0.75	0/4294	0.95	12/5867 (0.2%)
All	All	0.79	196/214125 (0.1%)	0.94	545/292575 (0.2%)

Chiral center outliers are detected by calculating the chiral volume of a chiral center and verifying if the center is modelled as a planar moiety or with the opposite hand. A planarity outlier is detected by checking planarity of atoms in a peptide group, atoms in a mainchain group or atoms of a sidechain that are expected to be planar.

Mol	Chain	#Chirality outliers	#Planarity outliers
1	1-A	0	4
1	1-B	0	4
1	2-A	0	4
1	2-B	0	5
1	3-A	0	2
1	3-B	0	5
1	4-A	0	1
1	4-B	0	2
1	5-A	0	2
1	6-A	0	4
1	6-B	0	2
1	7-A	0	5
1	7-B	0	7
1	8-A	0	4
1	8-B	0	1
1	9-A	0	3

Continued on next page...

Continued from previous page...

Mol	Chain	#Chirality outliers	#Planarity outliers
1	9-B	0	4
1	10-A	0	5
1	10-B	0	3
1	11-A	0	6
1	11-B	0	2
1	12-A	0	1
1	12-B	0	2
1	13-A	0	1
1	14-A	0	3
1	14-B	0	5
1	15-A	0	4
1	15-B	0	2
1	16-A	0	9
1	17-A	0	6
1	17-B	0	2
1	18-A	0	3
1	18-B	0	4
1	19-A	0	2
1	19-B	0	2
1	20-A	0	3
1	20-B	0	4
1	21-A	0	2
1	21-B	0	2
1	22-A	0	5
1	22-B	0	1
1	23-A	0	1
1	23-B	0	4
1	24-A	0	7
1	25-A	0	3
1	25-B	0	2
All	All	0	155

The worst 5 of 196 bond length outliers are listed below:

Mol	Chain	Res	Type	Atoms	Z	Observed(Å)	Ideal(Å)
1	13-A	194	TYR	CE2-CZ	-12.36	1.22	1.38
1	6-B	310	VAL	CB-CG2	-11.58	1.28	1.52
1	13-B	379	ALA	CA-CB	-11.38	1.28	1.52
1	4-B	310	VAL	CB-CG2	-10.93	1.29	1.52
1	1-A	196	TRP	CB-CG	10.82	1.69	1.50

The worst 5 of 545 bond angle outliers are listed below:

Mol	Chain	Res	Type	Atoms	Z	Observed(°)	Ideal(°)
1	13-B	87	ARG	NE-CZ-NH1	16.90	128.75	120.30
1	19-A	460	ARG	NE-CZ-NH2	13.89	127.24	120.30
1	4-B	346	ARG	NE-CZ-NH2	13.10	126.85	120.30
1	8-B	460	ARG	NE-CZ-NH2	12.66	126.63	120.30
1	22-B	346	ARG	NE-CZ-NH2	12.33	126.46	120.30

There are no chirality outliers.

5 of 155 planarity outliers are listed below:

Mol	Chain	Res	Type	Group
1	1-A	193	GLY	Peptide
1	1-A	311	LYS	Peptide
1	1-A	312	PRO	Peptide
1	1-A	337	HIS	Peptide
1	1-B	76	PRO	Peptide

5.2 Too-close contacts [i](#)

In the following table, the Non-H and H(model) columns list the number of non-hydrogen atoms and hydrogen atoms in the chain respectively. The H(added) column lists the number of hydrogen atoms added and optimized by MolProbity. The Clashes column lists the number of clashes within the asymmetric unit, whereas Symm-Clashes lists symmetry-related clashes.

Mol	Chain	Non-H	H(model)	H(added)	Clashes	Symm-Clashes
1	1-A	4158	3901	3913	0	0
1	1-B	4181	3920	3932	0	0
1	2-A	4158	3901	3913	0	0
1	2-B	4181	3920	3932	0	0
1	3-A	4158	3901	3913	0	0
1	3-B	4181	3920	3932	0	0
1	4-A	4158	3901	3913	0	0
1	4-B	4181	3920	3932	0	0
1	5-A	4158	3901	3913	0	0
1	5-B	4181	3920	3932	0	0
1	6-A	4158	3901	3913	0	0
1	6-B	4181	3920	3932	0	0
1	7-A	4158	3901	3913	0	0
1	7-B	4181	3920	3932	0	0
1	8-A	4158	3901	3913	0	0
1	8-B	4181	3920	3932	0	0
1	9-A	4158	3901	3913	0	0
1	9-B	4181	3920	3932	0	0

Continued on next page...

Continued from previous page...

Mol	Chain	Non-H	H(model)	H(added)	Clashes	Symm-Clashes
1	10-A	4158	3901	3913	0	0
1	10-B	4181	3920	3932	0	0
1	11-A	4158	3901	3913	0	0
1	11-B	4181	3920	3932	0	0
1	12-A	4158	3901	3913	0	0
1	12-B	4181	3920	3932	0	0
1	13-A	4158	3901	3913	0	0
1	13-B	4181	3920	3932	0	0
1	14-A	4158	3901	3913	0	0
1	14-B	4181	3920	3932	0	0
1	15-A	4158	3901	3913	0	0
1	15-B	4181	3920	3932	0	0
1	16-A	4158	3901	3913	0	0
1	16-B	4181	3920	3932	0	0
1	17-A	4158	3901	3913	0	0
1	17-B	4181	3920	3932	0	0
1	18-A	4158	3901	3913	0	0
1	18-B	4181	3920	3932	0	0
1	19-A	4158	3901	3913	0	0
1	19-B	4181	3920	3932	0	0
1	20-A	4158	3901	3913	0	0
1	20-B	4181	3920	3932	0	0
1	21-A	4158	3901	3913	0	0
1	21-B	4181	3920	3932	0	0
1	22-A	4158	3901	3913	0	0
1	22-B	4181	3920	3932	0	0
1	23-A	4158	3901	3913	0	0
1	23-B	4181	3920	3932	0	0
1	24-A	4158	3901	3913	0	0
1	24-B	4181	3920	3932	0	0
1	25-A	4158	3901	3913	0	0
1	25-B	4181	3920	3932	0	0
2	1-A	8	12	12	0	0
2	1-B	12	18	18	0	0
2	2-A	8	12	12	0	0
2	2-B	12	18	18	0	0
2	3-A	8	12	12	0	0
2	3-B	12	18	18	0	0
2	4-A	8	12	12	0	0
2	4-B	12	18	18	0	0
2	5-A	8	12	12	0	0
2	5-B	12	18	18	0	0

Continued on next page...

Continued from previous page...

Mol	Chain	Non-H	H(model)	H(added)	Clashes	Symm-Clashes
2	6-A	8	12	12	0	0
2	6-B	12	18	18	0	0
2	7-A	8	12	12	0	0
2	7-B	12	18	18	0	0
2	8-A	8	12	12	0	0
2	8-B	12	18	18	0	0
2	9-A	8	12	12	0	0
2	9-B	12	18	18	0	0
2	10-A	8	12	12	0	0
2	10-B	12	18	18	0	0
2	11-A	8	12	12	0	0
2	11-B	12	18	18	0	0
2	12-A	8	12	12	0	0
2	12-B	12	18	18	0	0
2	13-A	8	12	12	0	0
2	13-B	12	18	18	0	0
2	14-A	8	12	12	0	0
2	14-B	12	18	18	0	0
2	15-A	8	12	12	0	0
2	15-B	12	18	18	0	0
2	16-A	8	12	12	0	0
2	16-B	12	18	18	0	0
2	17-A	8	12	12	0	0
2	17-B	12	18	18	0	0
2	18-A	8	12	12	0	0
2	18-B	12	18	18	0	0
2	19-A	8	12	12	0	0
2	19-B	12	18	18	0	0
2	20-A	8	12	12	0	0
2	20-B	12	18	18	0	0
2	21-A	8	12	12	0	0
2	21-B	12	18	18	0	0
2	22-A	8	12	12	0	0
2	22-B	12	18	18	0	0
2	23-A	8	12	12	0	0
2	23-B	12	18	18	0	0
2	24-A	8	12	12	0	0
2	24-B	12	18	18	0	0
2	25-A	8	12	12	0	0
2	25-B	12	18	18	0	0
3	1-B	12	12	12	0	0
3	2-B	12	12	12	0	0

Continued on next page...

Continued from previous page...

Mol	Chain	Non-H	H(model)	H(added)	Clashes	Symm-Clashes
3	3-B	12	12	11	0	0
3	4-B	12	12	12	0	0
3	5-B	12	12	12	0	0
3	6-B	12	12	12	0	0
3	7-B	12	12	12	0	0
3	8-B	12	12	12	0	0
3	9-B	12	12	12	0	0
3	10-B	12	12	12	0	0
3	11-B	12	12	12	0	0
3	12-B	12	12	12	0	0
3	13-B	12	12	12	0	0
3	14-B	12	12	12	0	0
3	15-B	12	12	12	0	0
3	16-B	12	12	12	0	0
3	17-B	12	12	12	0	0
3	18-B	12	12	12	0	0
3	19-B	12	12	12	0	0
3	20-B	12	12	12	0	0
3	21-B	12	12	12	0	0
3	22-B	12	12	12	0	0
3	23-B	12	12	12	0	0
3	24-B	12	12	12	0	0
3	25-B	12	12	12	0	0
4	1-A	240	0	0	0	0
4	1-B	263	0	0	0	0
4	2-A	253	0	0	0	0
4	2-B	236	0	0	0	0
4	3-A	262	0	0	0	0
4	3-B	224	0	0	0	0
4	4-A	244	0	0	0	0
4	4-B	246	0	0	0	0
4	5-A	270	0	0	0	0
4	5-B	233	0	0	0	0
4	6-A	247	0	0	0	0
4	6-B	243	0	0	0	0
4	7-A	254	0	0	0	0
4	7-B	236	0	0	0	0
4	8-A	243	0	0	0	0
4	8-B	242	0	0	0	0
4	9-A	237	0	0	0	0
4	9-B	240	0	0	0	0
4	10-A	254	0	0	0	0

Continued on next page...

Continued from previous page...

Mol	Chain	Non-H	H(model)	H(added)	Clashes	Symm-Clashes
4	10-B	252	0	0	0	0
4	11-A	232	0	0	0	0
4	11-B	252	0	0	0	0
4	12-A	239	0	0	0	0
4	12-B	263	0	0	0	0
4	13-A	257	0	0	0	0
4	13-B	231	0	0	0	0
4	14-A	251	0	0	0	0
4	14-B	246	0	0	0	0
4	15-A	246	0	0	0	0
4	15-B	239	0	0	0	0
4	16-A	252	0	0	0	0
4	16-B	246	0	0	0	0
4	17-A	246	0	0	0	0
4	17-B	238	0	0	0	0
4	18-A	258	0	0	0	0
4	18-B	251	0	0	0	0
4	19-A	248	0	0	0	0
4	19-B	228	0	0	0	0
4	20-A	237	0	0	0	0
4	20-B	230	0	0	0	0
4	21-A	242	0	0	0	0
4	21-B	240	0	0	0	0
4	22-A	251	0	0	0	0
4	22-B	267	0	0	0	0
4	23-A	248	0	0	0	0
4	23-B	248	0	0	0	0
4	24-A	239	0	0	0	0
4	24-B	241	0	0	0	0
4	25-A	240	0	0	0	0
4	25-B	242	0	0	0	0
All	All	221542	196575	197174	0	0

The all-atom clashscore is defined as the number of clashes found per 1000 atoms (including hydrogen atoms). Clashscore could not be calculated for this entry.

There are no clashes within the asymmetric unit.

There are no symmetry-related clashes.

5.3 Torsion angles [i](#)

5.3.1 Protein backbone [i](#)

In the following table, the Percentiles column shows the percent Ramachandran outliers of the chain as a percentile score with respect to all X-ray entries followed by that with respect to entries of similar resolution.

The Analysed column shows the number of residues for which the backbone conformation was analysed, and the total number of residues.

Mol	Chain	Analysed	Favoured	Allowed	Outliers	Percentiles	
1	1-A	546/551 (99%)	497 (91%)	45 (8%)	4 (1%)	22	8
1	1-B	549/551 (100%)	504 (92%)	37 (7%)	8 (2%)	10	2
1	2-A	546/551 (99%)	506 (93%)	35 (6%)	5 (1%)	17	5
1	2-B	549/551 (100%)	504 (92%)	37 (7%)	8 (2%)	10	2
1	3-A	546/551 (99%)	507 (93%)	33 (6%)	6 (1%)	14	3
1	3-B	549/551 (100%)	508 (92%)	34 (6%)	7 (1%)	12	2
1	4-A	546/551 (99%)	511 (94%)	33 (6%)	2 (0%)	34	17
1	4-B	549/551 (100%)	508 (92%)	37 (7%)	4 (1%)	22	8
1	5-A	546/551 (99%)	501 (92%)	33 (6%)	12 (2%)	6	1
1	5-B	549/551 (100%)	509 (93%)	33 (6%)	7 (1%)	12	2
1	6-A	546/551 (99%)	500 (92%)	38 (7%)	8 (2%)	10	2
1	6-B	549/551 (100%)	513 (93%)	32 (6%)	4 (1%)	22	8
1	7-A	546/551 (99%)	507 (93%)	31 (6%)	8 (2%)	10	2
1	7-B	549/551 (100%)	494 (90%)	42 (8%)	13 (2%)	6	1
1	8-A	546/551 (99%)	505 (92%)	35 (6%)	6 (1%)	14	3
1	8-B	549/551 (100%)	516 (94%)	30 (6%)	3 (0%)	29	12
1	9-A	546/551 (99%)	505 (92%)	35 (6%)	6 (1%)	14	3
1	9-B	549/551 (100%)	505 (92%)	36 (7%)	8 (2%)	10	2
1	10-A	546/551 (99%)	499 (91%)	38 (7%)	9 (2%)	9	1
1	10-B	549/551 (100%)	507 (92%)	37 (7%)	5 (1%)	17	5
1	11-A	546/551 (99%)	509 (93%)	34 (6%)	3 (0%)	29	12
1	11-B	549/551 (100%)	508 (92%)	33 (6%)	8 (2%)	10	2
1	12-A	546/551 (99%)	504 (92%)	37 (7%)	5 (1%)	17	5
1	12-B	549/551 (100%)	507 (92%)	36 (7%)	6 (1%)	14	3
1	13-A	546/551 (99%)	502 (92%)	41 (8%)	3 (0%)	29	12

Continued on next page...

Continued from previous page...

Mol	Chain	Analysed	Favoured	Allowed	Outliers	Percentiles	
1	13-B	549/551 (100%)	514 (94%)	31 (6%)	4 (1%)	22	8
1	14-A	546/551 (99%)	505 (92%)	36 (7%)	5 (1%)	17	5
1	14-B	549/551 (100%)	504 (92%)	35 (6%)	10 (2%)	8	1
1	15-A	546/551 (99%)	496 (91%)	39 (7%)	11 (2%)	7	1
1	15-B	549/551 (100%)	505 (92%)	35 (6%)	9 (2%)	9	1
1	16-A	546/551 (99%)	503 (92%)	39 (7%)	4 (1%)	22	8
1	16-B	549/551 (100%)	515 (94%)	28 (5%)	6 (1%)	14	3
1	17-A	546/551 (99%)	500 (92%)	32 (6%)	14 (3%)	5	0
1	17-B	549/551 (100%)	510 (93%)	28 (5%)	11 (2%)	7	1
1	18-A	546/551 (99%)	487 (89%)	49 (9%)	10 (2%)	8	1
1	18-B	549/551 (100%)	506 (92%)	34 (6%)	9 (2%)	9	1
1	19-A	546/551 (99%)	505 (92%)	34 (6%)	7 (1%)	12	2
1	19-B	549/551 (100%)	508 (92%)	32 (6%)	9 (2%)	9	1
1	20-A	546/551 (99%)	508 (93%)	32 (6%)	6 (1%)	14	3
1	20-B	549/551 (100%)	513 (93%)	27 (5%)	9 (2%)	9	1
1	21-A	546/551 (99%)	510 (93%)	27 (5%)	9 (2%)	9	1
1	21-B	549/551 (100%)	510 (93%)	33 (6%)	6 (1%)	14	3
1	22-A	546/551 (99%)	505 (92%)	34 (6%)	7 (1%)	12	2
1	22-B	549/551 (100%)	513 (93%)	29 (5%)	7 (1%)	12	2
1	23-A	546/551 (99%)	510 (93%)	33 (6%)	3 (0%)	29	12
1	23-B	549/551 (100%)	508 (92%)	36 (7%)	5 (1%)	17	5
1	24-A	546/551 (99%)	499 (91%)	38 (7%)	9 (2%)	9	1
1	24-B	549/551 (100%)	505 (92%)	35 (6%)	9 (2%)	9	1
1	25-A	546/551 (99%)	505 (92%)	32 (6%)	9 (2%)	9	1
1	25-B	549/551 (100%)	509 (93%)	34 (6%)	6 (1%)	14	3
All	All	27375/27550 (99%)	25289 (92%)	1734 (6%)	352 (1%)	12	2

5 of 352 Ramachandran outliers are listed below:

Mol	Chain	Res	Type
1	1-A	59	VAL
1	1-A	311	LYS
1	1-B	77	ASP

Continued on next page...

Continued from previous page...

Mol	Chain	Res	Type
1	1-B	297	PRO
1	1-B	311	LYS

5.3.2 Protein sidechains [i](#)

In the following table, the Percentiles column shows the percent sidechain outliers of the chain as a percentile score with respect to all X-ray entries followed by that with respect to entries of similar resolution.

The Analysed column shows the number of residues for which the sidechain conformation was analysed, and the total number of residues.

Mol	Chain	Analysed	Rotameric	Outliers	Percentiles	
1	1-A	435/437 (100%)	396 (91%)	39 (9%)	9	1
1	1-B	437/437 (100%)	403 (92%)	34 (8%)	12	2
1	2-A	435/437 (100%)	398 (92%)	37 (8%)	10	1
1	2-B	437/437 (100%)	412 (94%)	25 (6%)	20	5
1	3-A	435/437 (100%)	404 (93%)	31 (7%)	14	2
1	3-B	437/437 (100%)	405 (93%)	32 (7%)	14	2
1	4-A	435/437 (100%)	409 (94%)	26 (6%)	19	4
1	4-B	437/437 (100%)	407 (93%)	30 (7%)	15	2
1	5-A	435/437 (100%)	411 (94%)	24 (6%)	21	5
1	5-B	437/437 (100%)	403 (92%)	34 (8%)	12	2
1	6-A	435/437 (100%)	406 (93%)	29 (7%)	16	3
1	6-B	437/437 (100%)	406 (93%)	31 (7%)	14	2
1	7-A	435/437 (100%)	408 (94%)	27 (6%)	18	4
1	7-B	437/437 (100%)	412 (94%)	25 (6%)	20	5
1	8-A	435/437 (100%)	396 (91%)	39 (9%)	9	1
1	8-B	437/437 (100%)	403 (92%)	34 (8%)	12	2
1	9-A	435/437 (100%)	402 (92%)	33 (8%)	13	2
1	9-B	437/437 (100%)	399 (91%)	38 (9%)	10	1
1	10-A	435/437 (100%)	400 (92%)	35 (8%)	12	1
1	10-B	437/437 (100%)	397 (91%)	40 (9%)	9	1
1	11-A	435/437 (100%)	410 (94%)	25 (6%)	20	5
1	11-B	437/437 (100%)	406 (93%)	31 (7%)	14	2

Continued on next page...

Continued from previous page...

Mol	Chain	Analysed	Rotameric	Outliers	Percentiles	
1	12-A	435/437 (100%)	410 (94%)	25 (6%)	20	5
1	12-B	437/437 (100%)	392 (90%)	45 (10%)	7	1
1	13-A	435/437 (100%)	399 (92%)	36 (8%)	11	1
1	13-B	437/437 (100%)	401 (92%)	36 (8%)	11	1
1	14-A	435/437 (100%)	397 (91%)	38 (9%)	10	1
1	14-B	437/437 (100%)	397 (91%)	40 (9%)	9	1
1	15-A	435/437 (100%)	412 (95%)	23 (5%)	22	5
1	15-B	437/437 (100%)	396 (91%)	41 (9%)	8	1
1	16-A	435/437 (100%)	394 (91%)	41 (9%)	8	1
1	16-B	437/437 (100%)	404 (92%)	33 (8%)	13	2
1	17-A	435/437 (100%)	396 (91%)	39 (9%)	9	1
1	17-B	437/437 (100%)	402 (92%)	35 (8%)	12	1
1	18-A	435/437 (100%)	391 (90%)	44 (10%)	7	1
1	18-B	437/437 (100%)	403 (92%)	34 (8%)	12	2
1	19-A	435/437 (100%)	395 (91%)	40 (9%)	9	1
1	19-B	437/437 (100%)	401 (92%)	36 (8%)	11	1
1	20-A	435/437 (100%)	408 (94%)	27 (6%)	18	4
1	20-B	437/437 (100%)	405 (93%)	32 (7%)	14	2
1	21-A	435/437 (100%)	399 (92%)	36 (8%)	11	1
1	21-B	437/437 (100%)	401 (92%)	36 (8%)	11	1
1	22-A	435/437 (100%)	413 (95%)	22 (5%)	24	6
1	22-B	437/437 (100%)	396 (91%)	41 (9%)	8	1
1	23-A	435/437 (100%)	401 (92%)	34 (8%)	12	2
1	23-B	437/437 (100%)	401 (92%)	36 (8%)	11	1
1	24-A	435/437 (100%)	401 (92%)	34 (8%)	12	2
1	24-B	437/437 (100%)	400 (92%)	37 (8%)	10	1
1	25-A	435/437 (100%)	405 (93%)	30 (7%)	15	2
1	25-B	437/437 (100%)	394 (90%)	43 (10%)	8	1
All	All	21800/21850 (100%)	20107 (92%)	1693 (8%)	12	2

5 of 1693 residues with a non-rotameric sidechain are listed below:

Mol	Chain	Res	Type
1	15-A	271	LEU
1	18-A	271	LEU
1	24-B	217	GLN
1	15-B	225	SER
1	15-A	196	TRP

Sometimes sidechains can be flipped to improve hydrogen bonding and reduce clashes. 5 of 465 such sidechains are listed below:

Mol	Chain	Res	Type
1	13-B	337	HIS
1	24-B	325	GLN
1	17-A	363	ASN
1	24-B	79	GLN
1	22-B	450	HIS

5.3.3 RNA [i](#)

There are no RNA molecules in this entry.

5.4 Non-standard residues in protein, DNA, RNA chains [i](#)

There are no non-standard protein/DNA/RNA residues in this entry.

5.5 Carbohydrates [i](#)

There are no monosaccharides in this entry.

5.6 Ligand geometry [i](#)

150 ligands are modelled in this entry.

In the following table, the Counts columns list the number of bonds (or angles) for which Mogul statistics could be retrieved, the number of bonds (or angles) that are observed in the model and the number of bonds (or angles) that are defined in the Chemical Component Dictionary. The Link column lists molecule types, if any, to which the group is linked. The Z score for a bond length (or angle) is the number of standard deviations the observed value is removed from the expected value. A bond length (or angle) with $|Z| > 2$ is considered an outlier worth inspection. RMSZ is the root-mean-square of all Z scores of the bond lengths (or angles).

Mol	Type	Chain	Res	Link	Bond lengths			Bond angles		
					Counts	RMSZ	# Z > 2	Counts	RMSZ	# Z > 2
2	EDO	3-A	702	-	3,3,3	0.63	0	2,2,2	0.30	0
2	EDO	11-B	704	-	3,3,3	0.49	0	2,2,2	0.71	0
2	EDO	21-B	704	-	3,3,3	0.41	0	2,2,2	0.24	0
2	EDO	25-B	703	-	3,3,3	0.47	0	2,2,2	0.38	0
2	EDO	12-B	703	-	3,3,3	0.46	0	2,2,2	0.21	0
3	BGC	2-B	701	-	12,12,12	1.03	0	17,17,17	2.29	8 (47%)
2	EDO	8-B	702	-	3,3,3	0.38	0	2,2,2	0.29	0
2	EDO	11-A	702	-	3,3,3	0.69	0	2,2,2	0.43	0
2	EDO	10-B	704	-	3,3,3	0.50	0	2,2,2	0.50	0
2	EDO	4-A	701	-	3,3,3	0.51	0	2,2,2	0.33	0
2	EDO	13-B	703	-	3,3,3	0.46	0	2,2,2	0.31	0
2	EDO	18-A	702	-	3,3,3	0.60	0	2,2,2	0.40	0
3	BGC	3-B	701	-	12,12,12	1.12	1 (8%)	17,17,17	1.96	6 (35%)
2	EDO	22-A	701	-	3,3,3	0.52	0	2,2,2	0.35	0
2	EDO	5-A	702	-	3,3,3	0.68	0	2,2,2	0.34	0
2	EDO	6-B	704	-	3,3,3	0.52	0	2,2,2	0.45	0
2	EDO	15-A	701	-	3,3,3	0.56	0	2,2,2	0.33	0
2	EDO	25-A	701	-	3,3,3	0.60	0	2,2,2	0.27	0
2	EDO	4-B	702	-	3,3,3	0.45	0	2,2,2	0.45	0
2	EDO	5-B	703	-	3,3,3	0.47	0	2,2,2	0.43	0
2	EDO	9-A	702	-	3,3,3	0.62	0	2,2,2	0.43	0
2	EDO	24-A	702	-	3,3,3	0.61	0	2,2,2	0.38	0
2	EDO	6-B	702	-	3,3,3	0.27	0	2,2,2	0.53	0
2	EDO	23-B	704	-	3,3,3	0.57	0	2,2,2	0.03	0
2	EDO	15-A	702	-	3,3,3	0.61	0	2,2,2	0.47	0
2	EDO	14-B	704	-	3,3,3	0.46	0	2,2,2	0.16	0
2	EDO	10-A	702	-	3,3,3	0.65	0	2,2,2	0.34	0
2	EDO	19-B	704	-	3,3,3	0.46	0	2,2,2	1.61	0
2	EDO	24-A	701	-	3,3,3	0.54	0	2,2,2	0.39	0
3	BGC	18-B	701	-	12,12,12	0.68	0	17,17,17	2.30	9 (52%)
3	BGC	6-B	701	-	12,12,12	0.93	0	17,17,17	1.92	5 (29%)
2	EDO	8-B	704	-	3,3,3	0.62	0	2,2,2	0.12	0
2	EDO	10-A	701	-	3,3,3	0.48	0	2,2,2	0.21	0
2	EDO	20-A	702	-	3,3,3	0.65	0	2,2,2	0.43	0
2	EDO	14-B	702	-	3,3,3	0.47	0	2,2,2	0.24	0
2	EDO	19-B	702	-	3,3,3	0.44	0	2,2,2	0.52	0
3	BGC	15-B	701	-	12,12,12	0.87	0	17,17,17	2.18	4 (23%)
2	EDO	18-B	704	-	3,3,3	0.55	0	2,2,2	0.24	0
2	EDO	3-B	703	-	3,3,3	0.47	0	2,2,2	0.25	0
2	EDO	16-A	701	-	3,3,3	0.51	0	2,2,2	0.49	0
3	BGC	25-B	701	-	12,12,12	0.91	0	17,17,17	2.24	8 (47%)
2	EDO	2-A	701	-	3,3,3	0.45	0	2,2,2	0.28	0

Mol	Type	Chain	Res	Link	Bond lengths			Bond angles		
					Counts	RMSZ	# Z > 2	Counts	RMSZ	# Z > 2
3	BGC	12-B	701	-	12,12,12	0.77	0	17,17,17	1.95	5 (29%)
2	EDO	9-B	704	-	3,3,3	0.47	0	2,2,2	0.73	0
2	EDO	8-A	702	-	3,3,3	0.64	0	2,2,2	0.35	0
3	BGC	17-B	701	-	12,12,12	1.32	1 (8%)	17,17,17	2.80	9 (52%)
2	EDO	2-B	703	-	3,3,3	0.47	0	2,2,2	0.24	0
2	EDO	3-B	704	-	3,3,3	0.54	0	2,2,2	0.71	0
2	EDO	16-B	702	-	3,3,3	0.46	0	2,2,2	0.33	0
2	EDO	6-A	702	-	3,3,3	0.66	0	2,2,2	0.40	0
2	EDO	22-B	702	-	3,3,3	0.44	0	2,2,2	0.20	0
3	BGC	21-B	701	-	12,12,12	0.82	0	17,17,17	2.57	11 (64%)
2	EDO	12-B	702	-	3,3,3	0.33	0	2,2,2	0.10	0
2	EDO	11-A	701	-	3,3,3	0.51	0	2,2,2	0.21	0
2	EDO	13-A	701	-	3,3,3	0.48	0	2,2,2	0.28	0
2	EDO	22-A	702	-	3,3,3	0.69	0	2,2,2	0.42	0
2	EDO	21-B	703	-	3,3,3	0.45	0	2,2,2	0.20	0
2	EDO	25-B	704	-	3,3,3	0.39	0	2,2,2	0.20	0
2	EDO	1-A	702	-	3,3,3	0.55	0	2,2,2	0.52	0
3	BGC	19-B	701	-	12,12,12	0.83	0	17,17,17	1.89	4 (23%)
2	EDO	18-B	702	-	3,3,3	0.43	0	2,2,2	0.37	0
2	EDO	11-B	703	-	3,3,3	0.49	0	2,2,2	0.20	0
2	EDO	6-A	701	-	3,3,3	0.57	0	2,2,2	0.51	0
2	EDO	15-B	703	-	3,3,3	0.47	0	2,2,2	0.21	0
3	BGC	22-B	701	-	12,12,12	0.77	0	17,17,17	2.10	4 (23%)
2	EDO	1-B	704	-	3,3,3	0.92	0	2,2,2	0.46	0
3	BGC	9-B	701	-	12,12,12	0.58	0	17,17,17	3.13	9 (52%)
2	EDO	12-A	701	-	3,3,3	0.50	0	2,2,2	0.27	0
2	EDO	20-A	701	-	3,3,3	0.48	0	2,2,2	0.34	0
2	EDO	24-B	704	-	3,3,3	0.49	0	2,2,2	1.15	0
2	EDO	5-B	704	-	3,3,3	0.61	0	2,2,2	0.49	0
2	EDO	1-B	702	-	3,3,3	0.35	0	2,2,2	0.15	0
2	EDO	5-A	701	-	3,3,3	0.53	0	2,2,2	0.40	0
2	EDO	9-B	702	-	3,3,3	0.39	0	2,2,2	0.13	0
2	EDO	24-B	703	-	3,3,3	0.44	0	2,2,2	0.29	0
2	EDO	6-B	703	-	3,3,3	0.50	0	2,2,2	0.28	0
2	EDO	23-B	702	-	3,3,3	0.51	0	2,2,2	0.01	0
2	EDO	22-B	704	-	3,3,3	0.45	0	2,2,2	0.87	0
3	BGC	11-B	701	-	12,12,12	0.94	0	17,17,17	2.33	4 (23%)
2	EDO	25-B	702	-	3,3,3	0.40	0	2,2,2	0.33	0
2	EDO	10-B	702	-	3,3,3	0.39	0	2,2,2	0.33	0
2	EDO	12-A	702	-	3,3,3	0.64	0	2,2,2	0.44	0
3	BGC	4-B	701	-	12,12,12	1.02	0	17,17,17	1.42	3 (17%)

Mol	Type	Chain	Res	Link	Bond lengths			Bond angles		
					Counts	RMSZ	# Z > 2	Counts	RMSZ	# Z > 2
2	EDO	21-B	702	-	3,3,3	0.41	0	2,2,2	0.48	0
2	EDO	21-A	701	-	3,3,3	0.52	0	2,2,2	0.30	0
2	EDO	4-A	702	-	3,3,3	0.67	0	2,2,2	0.31	0
2	EDO	7-B	703	-	3,3,3	0.42	0	2,2,2	0.31	0
2	EDO	19-B	703	-	3,3,3	0.50	0	2,2,2	0.41	0
2	EDO	2-A	702	-	3,3,3	0.62	0	2,2,2	0.44	0
2	EDO	20-B	704	-	3,3,3	0.49	0	2,2,2	0.70	0
2	EDO	11-B	702	-	3,3,3	0.37	0	2,2,2	0.27	0
3	BGC	23-B	701	-	12,12,12	0.70	0	17,17,17	1.96	5 (29%)
2	EDO	7-A	702	-	3,3,3	0.62	0	2,2,2	0.45	0
2	EDO	20-B	703	-	3,3,3	0.44	0	2,2,2	0.34	0
2	EDO	17-B	703	-	3,3,3	0.56	0	2,2,2	0.22	0
2	EDO	17-A	701	-	3,3,3	0.45	0	2,2,2	0.35	0
2	EDO	14-A	701	-	3,3,3	0.48	0	2,2,2	0.35	0
2	EDO	17-A	702	-	3,3,3	0.64	0	2,2,2	0.40	0
2	EDO	20-B	702	-	3,3,3	0.47	0	2,2,2	0.68	0
2	EDO	23-A	701	-	3,3,3	0.54	0	2,2,2	0.39	0
2	EDO	14-A	702	-	3,3,3	0.58	0	2,2,2	0.35	0
2	EDO	17-B	702	-	3,3,3	0.42	0	2,2,2	0.50	0
2	EDO	16-A	702	-	3,3,3	0.68	0	2,2,2	0.43	0
2	EDO	5-B	702	-	3,3,3	0.34	0	2,2,2	0.30	0
2	EDO	24-B	702	-	3,3,3	0.33	0	2,2,2	0.41	0
2	EDO	9-B	703	-	3,3,3	0.42	0	2,2,2	0.21	0
2	EDO	12-B	704	-	3,3,3	0.50	0	2,2,2	0.50	0
2	EDO	16-B	704	-	3,3,3	0.60	0	2,2,2	0.31	0
2	EDO	2-B	704	-	3,3,3	0.96	0	2,2,2	0.82	0
2	EDO	7-B	702	-	3,3,3	0.33	0	2,2,2	0.48	0
2	EDO	4-B	703	-	3,3,3	0.42	0	2,2,2	0.38	0
2	EDO	7-A	701	-	3,3,3	0.49	0	2,2,2	0.21	0
2	EDO	16-B	703	-	3,3,3	0.44	0	2,2,2	0.31	0
2	EDO	10-B	703	-	3,3,3	0.46	0	2,2,2	0.31	0
2	EDO	23-A	702	-	3,3,3	0.57	0	2,2,2	0.49	0
2	EDO	13-A	702	-	3,3,3	0.62	0	2,2,2	0.34	0
2	EDO	13-B	702	-	3,3,3	0.47	0	2,2,2	0.54	0
2	EDO	9-A	701	-	3,3,3	0.49	0	2,2,2	0.27	0
3	BGC	8-B	701	-	12,12,12	0.80	0	17,17,17	1.70	5 (29%)
2	EDO	3-A	701	-	3,3,3	0.52	0	2,2,2	0.32	0
2	EDO	18-B	703	-	3,3,3	0.46	0	2,2,2	0.23	0
2	EDO	2-B	702	-	3,3,3	0.41	0	2,2,2	0.10	0
3	BGC	1-B	701	-	12,12,12	0.86	0	17,17,17	2.02	7 (41%)
2	EDO	15-B	704	-	3,3,3	0.24	0	2,2,2	0.91	0
2	EDO	3-B	702	-	3,3,3	0.29	0	2,2,2	0.32	0

Mol	Type	Chain	Res	Link	Bond lengths			Bond angles		
					Counts	RMSZ	# Z > 2	Counts	RMSZ	# Z > 2
2	EDO	1-B	703	-	3,3,3	0.45	0	2,2,2	0.29	0
2	EDO	14-B	703	-	3,3,3	0.45	0	2,2,2	0.32	0
2	EDO	23-B	703	-	3,3,3	0.44	0	2,2,2	0.30	0
2	EDO	19-A	702	-	3,3,3	0.63	0	2,2,2	0.55	0
2	EDO	8-B	703	-	3,3,3	0.40	0	2,2,2	0.47	0
2	EDO	18-A	701	-	3,3,3	0.46	0	2,2,2	0.18	0
2	EDO	7-B	704	-	3,3,3	0.52	0	2,2,2	0.46	0
3	BGC	13-B	701	-	12,12,12	1.07	2 (16%)	17,17,17	1.32	3 (17%)
2	EDO	13-B	704	-	3,3,3	0.49	0	2,2,2	0.24	0
2	EDO	4-B	704	-	3,3,3	0.42	0	2,2,2	0.77	0
2	EDO	22-B	703	-	3,3,3	0.48	0	2,2,2	0.33	0
2	EDO	1-A	701	-	3,3,3	0.66	0	2,2,2	0.38	0
2	EDO	21-A	702	-	3,3,3	0.61	0	2,2,2	0.51	0
3	BGC	16-B	701	-	12,12,12	0.86	0	17,17,17	1.70	4 (23%)
3	BGC	10-B	701	-	12,12,12	0.70	0	17,17,17	2.05	4 (23%)
3	BGC	14-B	701	-	12,12,12	1.11	1 (8%)	17,17,17	2.24	8 (47%)
2	EDO	17-B	704	-	3,3,3	0.61	0	2,2,2	0.77	0
3	BGC	5-B	701	-	12,12,12	0.80	0	17,17,17	2.19	6 (35%)
2	EDO	15-B	702	-	3,3,3	0.40	0	2,2,2	0.35	0
3	BGC	24-B	701	-	12,12,12	0.73	0	17,17,17	1.76	4 (23%)
2	EDO	19-A	701	-	3,3,3	0.53	0	2,2,2	0.22	0
3	BGC	20-B	701	-	12,12,12	1.09	0	17,17,17	2.29	5 (29%)
3	BGC	7-B	701	-	12,12,12	1.00	0	17,17,17	1.50	4 (23%)
2	EDO	25-A	702	-	3,3,3	0.64	0	2,2,2	0.35	0
2	EDO	8-A	701	-	3,3,3	0.63	0	2,2,2	0.30	0

In the following table, the Chirals column lists the number of chiral outliers, the number of chiral centers analysed, the number of these observed in the model and the number defined in the Chemical Component Dictionary. Similar counts are reported in the Torsion and Rings columns. '-' means no outliers of that kind were identified.

Mol	Type	Chain	Res	Link	Chirals	Torsions	Rings
2	EDO	3-A	702	-	-	0/1/1/1	-
2	EDO	11-B	704	-	-	1/1/1/1	-
2	EDO	21-B	704	-	-	0/1/1/1	-
2	EDO	25-B	703	-	-	0/1/1/1	-
2	EDO	12-B	703	-	-	0/1/1/1	-
3	BGC	2-B	701	-	-	0/2/22/22	0/1/1/1
2	EDO	8-B	702	-	-	1/1/1/1	-
2	EDO	11-A	702	-	-	0/1/1/1	-
2	EDO	10-B	704	-	-	0/1/1/1	-

Continued on next page...

Continued from previous page...

Mol	Type	Chain	Res	Link	Chirals	Torsions	Rings
2	EDO	4-A	701	-	-	0/1/1/1	-
2	EDO	13-B	703	-	-	0/1/1/1	-
2	EDO	18-A	702	-	-	0/1/1/1	-
3	BGC	3-B	701	-	-	2/2/22/22	0/1/1/1
2	EDO	22-A	701	-	-	0/1/1/1	-
2	EDO	5-A	702	-	-	0/1/1/1	-
2	EDO	6-B	704	-	-	0/1/1/1	-
2	EDO	15-A	701	-	-	0/1/1/1	-
2	EDO	25-A	701	-	-	1/1/1/1	-
2	EDO	4-B	702	-	-	0/1/1/1	-
2	EDO	5-B	703	-	-	0/1/1/1	-
2	EDO	9-A	702	-	-	0/1/1/1	-
2	EDO	24-A	702	-	-	0/1/1/1	-
2	EDO	6-B	702	-	-	0/1/1/1	-
2	EDO	23-B	704	-	-	1/1/1/1	-
2	EDO	15-A	702	-	-	0/1/1/1	-
2	EDO	14-B	704	-	-	1/1/1/1	-
2	EDO	10-A	702	-	-	0/1/1/1	-
2	EDO	19-B	704	-	-	1/1/1/1	-
2	EDO	24-A	701	-	-	1/1/1/1	-
3	BGC	18-B	701	-	-	2/2/22/22	0/1/1/1
3	BGC	6-B	701	-	-	2/2/22/22	0/1/1/1
2	EDO	8-B	704	-	-	1/1/1/1	-
2	EDO	10-A	701	-	-	0/1/1/1	-
2	EDO	20-A	702	-	-	0/1/1/1	-
2	EDO	14-B	702	-	-	0/1/1/1	-
2	EDO	19-B	702	-	-	0/1/1/1	-
3	BGC	15-B	701	-	-	0/2/22/22	0/1/1/1
2	EDO	18-B	704	-	-	1/1/1/1	-
2	EDO	3-B	703	-	-	0/1/1/1	-
2	EDO	16-A	701	-	-	0/1/1/1	-
3	BGC	25-B	701	-	-	0/2/22/22	0/1/1/1
2	EDO	2-A	701	-	-	1/1/1/1	-
3	BGC	12-B	701	-	-	0/2/22/22	0/1/1/1
2	EDO	9-B	704	-	-	1/1/1/1	-
2	EDO	8-A	702	-	-	0/1/1/1	-
3	BGC	17-B	701	-	-	1/2/22/22	0/1/1/1
2	EDO	2-B	703	-	-	0/1/1/1	-
2	EDO	3-B	704	-	-	1/1/1/1	-
2	EDO	16-B	702	-	-	0/1/1/1	-
2	EDO	6-A	702	-	-	0/1/1/1	-
2	EDO	22-B	702	-	-	0/1/1/1	-

Continued on next page...

Continued from previous page...

Mol	Type	Chain	Res	Link	Chirals	Torsions	Rings
3	BGC	21-B	701	-	-	2/2/22/22	0/1/1/1
2	EDO	12-B	702	-	-	1/1/1/1	-
2	EDO	11-A	701	-	-	1/1/1/1	-
2	EDO	13-A	701	-	-	0/1/1/1	-
2	EDO	22-A	702	-	-	0/1/1/1	-
2	EDO	21-B	703	-	-	0/1/1/1	-
2	EDO	25-B	704	-	-	1/1/1/1	-
2	EDO	1-A	702	-	-	0/1/1/1	-
3	BGC	19-B	701	-	-	0/2/22/22	0/1/1/1
2	EDO	18-B	702	-	-	0/1/1/1	-
2	EDO	11-B	703	-	-	0/1/1/1	-
2	EDO	6-A	701	-	-	1/1/1/1	-
2	EDO	15-B	703	-	-	0/1/1/1	-
3	BGC	22-B	701	-	-	0/2/22/22	0/1/1/1
2	EDO	1-B	704	-	-	1/1/1/1	-
3	BGC	9-B	701	-	-	2/2/22/22	0/1/1/1
2	EDO	12-A	701	-	-	0/1/1/1	-
2	EDO	20-A	701	-	-	0/1/1/1	-
2	EDO	24-B	704	-	-	1/1/1/1	-
2	EDO	5-B	704	-	-	0/1/1/1	-
2	EDO	1-B	702	-	-	0/1/1/1	-
2	EDO	5-A	701	-	-	0/1/1/1	-
2	EDO	9-B	702	-	-	0/1/1/1	-
2	EDO	24-B	703	-	-	0/1/1/1	-
2	EDO	6-B	703	-	-	0/1/1/1	-
2	EDO	23-B	702	-	-	0/1/1/1	-
2	EDO	22-B	704	-	-	1/1/1/1	-
3	BGC	11-B	701	-	-	1/2/22/22	0/1/1/1
2	EDO	25-B	702	-	-	0/1/1/1	-
2	EDO	10-B	702	-	-	0/1/1/1	-
2	EDO	12-A	702	-	-	0/1/1/1	-
3	BGC	4-B	701	-	-	2/2/22/22	0/1/1/1
2	EDO	21-B	702	-	-	0/1/1/1	-
2	EDO	21-A	701	-	-	0/1/1/1	-
2	EDO	4-A	702	-	-	0/1/1/1	-
2	EDO	7-B	703	-	-	0/1/1/1	-
2	EDO	19-B	703	-	-	0/1/1/1	-
2	EDO	2-A	702	-	-	0/1/1/1	-
2	EDO	20-B	704	-	-	1/1/1/1	-
2	EDO	11-B	702	-	-	0/1/1/1	-
3	BGC	23-B	701	-	-	2/2/22/22	0/1/1/1

Continued on next page...

Continued from previous page...

Mol	Type	Chain	Res	Link	Chirals	Torsions	Rings
2	EDO	7-A	702	-	-	0/1/1/1	-
2	EDO	20-B	703	-	-	0/1/1/1	-
2	EDO	17-B	703	-	-	0/1/1/1	-
2	EDO	17-A	701	-	-	1/1/1/1	-
2	EDO	14-A	701	-	-	0/1/1/1	-
2	EDO	17-A	702	-	-	0/1/1/1	-
2	EDO	20-B	702	-	-	0/1/1/1	-
2	EDO	23-A	701	-	-	0/1/1/1	-
2	EDO	14-A	702	-	-	0/1/1/1	-
2	EDO	17-B	702	-	-	0/1/1/1	-
2	EDO	16-A	702	-	-	0/1/1/1	-
2	EDO	5-B	702	-	-	0/1/1/1	-
2	EDO	24-B	702	-	-	0/1/1/1	-
2	EDO	9-B	703	-	-	0/1/1/1	-
2	EDO	12-B	704	-	-	1/1/1/1	-
2	EDO	16-B	704	-	-	1/1/1/1	-
2	EDO	2-B	704	-	-	0/1/1/1	-
2	EDO	7-B	702	-	-	0/1/1/1	-
2	EDO	4-B	703	-	-	0/1/1/1	-
2	EDO	7-A	701	-	-	0/1/1/1	-
2	EDO	16-B	703	-	-	0/1/1/1	-
2	EDO	10-B	703	-	-	0/1/1/1	-
2	EDO	23-A	702	-	-	0/1/1/1	-
2	EDO	13-A	702	-	-	0/1/1/1	-
2	EDO	13-B	702	-	-	0/1/1/1	-
2	EDO	9-A	701	-	-	1/1/1/1	-
3	BGC	8-B	701	-	-	0/2/22/22	0/1/1/1
2	EDO	3-A	701	-	-	0/1/1/1	-
2	EDO	18-B	703	-	-	1/1/1/1	-
2	EDO	2-B	702	-	-	0/1/1/1	-
3	BGC	1-B	701	-	-	2/2/22/22	0/1/1/1
2	EDO	15-B	704	-	-	0/1/1/1	-
2	EDO	3-B	702	-	-	0/1/1/1	-
2	EDO	1-B	703	-	-	0/1/1/1	-
2	EDO	14-B	703	-	-	0/1/1/1	-
2	EDO	23-B	703	-	-	0/1/1/1	-
2	EDO	19-A	702	-	-	0/1/1/1	-
2	EDO	8-B	703	-	-	0/1/1/1	-
2	EDO	18-A	701	-	-	1/1/1/1	-
2	EDO	7-B	704	-	-	0/1/1/1	-
3	BGC	13-B	701	-	-	0/2/22/22	0/1/1/1
2	EDO	13-B	704	-	-	0/1/1/1	-

Continued on next page...

Continued from previous page...

Mol	Type	Chain	Res	Link	Chirals	Torsions	Rings
2	EDO	4-B	704	-	-	0/1/1/1	-
2	EDO	22-B	703	-	-	0/1/1/1	-
2	EDO	1-A	701	-	-	1/1/1/1	-
2	EDO	21-A	702	-	-	0/1/1/1	-
3	BGC	16-B	701	-	-	0/2/22/22	0/1/1/1
3	BGC	10-B	701	-	-	1/2/22/22	0/1/1/1
3	BGC	14-B	701	-	-	0/2/22/22	0/1/1/1
2	EDO	17-B	704	-	-	1/1/1/1	-
3	BGC	5-B	701	-	-	0/2/22/22	0/1/1/1
2	EDO	15-B	702	-	-	0/1/1/1	-
3	BGC	24-B	701	-	-	1/2/22/22	0/1/1/1
2	EDO	19-A	701	-	-	1/1/1/1	-
3	BGC	20-B	701	-	-	2/2/22/22	0/1/1/1
3	BGC	7-B	701	-	-	2/2/22/22	0/1/1/1
2	EDO	25-A	702	-	-	0/1/1/1	-
2	EDO	8-A	701	-	-	1/1/1/1	-

All (5) bond length outliers are listed below:

Mol	Chain	Res	Type	Atoms	Z	Observed(Å)	Ideal(Å)
3	3-B	701	BGC	O3-C3	-3.13	1.35	1.43
3	14-B	701	BGC	C1-C2	2.70	1.58	1.52
3	13-B	701	BGC	C1-C2	2.46	1.58	1.52
3	13-B	701	BGC	C4-C3	2.13	1.57	1.52
3	17-B	701	BGC	C4-C5	2.08	1.57	1.53

The worst 5 of 144 bond angle outliers are listed below:

Mol	Chain	Res	Type	Atoms	Z	Observed(°)	Ideal(°)
3	9-B	701	BGC	O4-C4-C3	-8.21	91.36	110.35
3	20-B	701	BGC	C3-C4-C5	6.11	121.14	110.24
3	9-B	701	BGC	C1-O5-C5	-5.60	103.10	113.66
3	17-B	701	BGC	C4-C3-C2	-5.32	101.54	110.82
3	17-B	701	BGC	C3-C4-C5	5.13	119.40	110.24

There are no chirality outliers.

5 of 54 torsion outliers are listed below:

Mol	Chain	Res	Type	Atoms
3	23-B	701	BGC	O5-C5-C6-O6
3	1-B	701	BGC	O5-C5-C6-O6

Continued on next page...

Continued from previous page...

Mol	Chain	Res	Type	Atoms
3	3-B	701	BGC	O5-C5-C6-O6
3	18-B	701	BGC	O5-C5-C6-O6
3	1-B	701	BGC	C4-C5-C6-O6

There are no ring outliers.

No monomer is involved in short contacts.

5.7 Other polymers [i](#)

There are no such residues in this entry.

5.8 Polymer linkage issues [i](#)

There are no chain breaks in this entry.

6 Fit of model and data

6.1 Protein, DNA and RNA chains

In the following table, the column labelled ‘#RSRZ > 2’ contains the number (and percentage) of RSRZ outliers, followed by percent RSRZ outliers for the chain as percentile scores relative to all X-ray entries and entries of similar resolution. The OWAB column contains the minimum, median, 95th percentile and maximum values of the occupancy-weighted average B-factor per residue. The column labelled ‘Q < 0.9’ lists the number of (and percentage) of residues with an average occupancy less than 0.9.

Mol	Chain	Analysed	<RSRZ>	#RSRZ>2	OWAB(Å ²)	Q<0.9
1	1-A	548/551 (99%)	0.26	46 (8%) 11 14	13, 14, 16, 17	548 (100%)
1	1-B	551/551 (100%)	0.19	45 (8%) 11 15	12, 14, 15, 17	551 (100%)
1	2-A	548/551 (99%)	0.26	46 (8%) 11 14	13, 14, 16, 17	548 (100%)
1	2-B	551/551 (100%)	0.19	45 (8%) 11 15	12, 14, 15, 17	551 (100%)
1	3-A	548/551 (99%)	0.26	46 (8%) 11 14	13, 14, 16, 17	548 (100%)
1	3-B	551/551 (100%)	0.19	45 (8%) 11 15	12, 14, 15, 17	551 (100%)
1	4-A	548/551 (99%)	0.26	46 (8%) 11 14	13, 14, 16, 17	548 (100%)
1	4-B	551/551 (100%)	0.19	45 (8%) 11 15	12, 14, 15, 17	551 (100%)
1	5-A	548/551 (99%)	0.26	46 (8%) 11 14	13, 14, 16, 17	548 (100%)
1	5-B	551/551 (100%)	0.19	45 (8%) 11 15	12, 14, 15, 17	551 (100%)
1	6-A	548/551 (99%)	0.26	46 (8%) 11 14	13, 14, 16, 17	548 (100%)
1	6-B	551/551 (100%)	0.19	45 (8%) 11 15	12, 14, 15, 17	551 (100%)
1	7-A	548/551 (99%)	0.26	46 (8%) 11 14	13, 14, 16, 17	548 (100%)
1	7-B	551/551 (100%)	0.19	45 (8%) 11 15	12, 14, 15, 17	551 (100%)
1	8-A	548/551 (99%)	0.26	46 (8%) 11 14	13, 14, 16, 17	548 (100%)
1	8-B	551/551 (100%)	0.19	45 (8%) 11 15	12, 14, 15, 17	551 (100%)
1	9-A	548/551 (99%)	0.26	46 (8%) 11 14	13, 14, 16, 17	548 (100%)
1	9-B	551/551 (100%)	0.19	45 (8%) 11 15	12, 14, 15, 17	551 (100%)
1	10-A	548/551 (99%)	0.26	46 (8%) 11 14	13, 14, 16, 17	548 (100%)
1	10-B	551/551 (100%)	0.19	45 (8%) 11 15	12, 14, 15, 17	551 (100%)
1	11-A	548/551 (99%)	0.26	46 (8%) 11 14	13, 14, 16, 17	548 (100%)
1	11-B	551/551 (100%)	0.19	45 (8%) 11 15	12, 14, 15, 17	551 (100%)
1	12-A	548/551 (99%)	0.26	46 (8%) 11 14	13, 14, 16, 17	548 (100%)
1	12-B	551/551 (100%)	0.19	45 (8%) 11 15	12, 14, 15, 17	551 (100%)

Continued on next page...

Continued from previous page...

Mol	Chain	Analysed	<RSRZ>	#RSRZ>2	OWAB(Å ²)	Q<0.9
1	13-A	548/551 (99%)	0.26	46 (8%) 11 14	13, 14, 16, 17	548 (100%)
1	13-B	551/551 (100%)	0.19	45 (8%) 11 15	12, 14, 15, 17	551 (100%)
1	14-A	548/551 (99%)	0.26	46 (8%) 11 14	13, 14, 16, 17	548 (100%)
1	14-B	551/551 (100%)	0.19	45 (8%) 11 15	12, 14, 15, 17	551 (100%)
1	15-A	548/551 (99%)	0.26	46 (8%) 11 14	13, 14, 16, 17	548 (100%)
1	15-B	551/551 (100%)	0.19	45 (8%) 11 15	12, 14, 15, 17	551 (100%)
1	16-A	548/551 (99%)	0.26	46 (8%) 11 14	13, 14, 16, 17	548 (100%)
1	16-B	551/551 (100%)	0.19	45 (8%) 11 15	12, 14, 15, 17	551 (100%)
1	17-A	548/551 (99%)	0.26	46 (8%) 11 14	13, 14, 16, 17	548 (100%)
1	17-B	551/551 (100%)	0.19	45 (8%) 11 15	12, 14, 15, 17	551 (100%)
1	18-A	548/551 (99%)	0.26	46 (8%) 11 14	13, 14, 16, 17	548 (100%)
1	18-B	551/551 (100%)	0.19	45 (8%) 11 15	12, 14, 15, 17	551 (100%)
1	19-A	548/551 (99%)	0.26	46 (8%) 11 14	13, 14, 16, 17	548 (100%)
1	19-B	551/551 (100%)	0.19	45 (8%) 11 15	12, 14, 15, 17	551 (100%)
1	20-A	548/551 (99%)	0.26	46 (8%) 11 14	13, 14, 16, 17	548 (100%)
1	20-B	551/551 (100%)	0.19	45 (8%) 11 15	12, 14, 15, 17	551 (100%)
1	21-A	548/551 (99%)	0.26	46 (8%) 11 14	13, 14, 16, 17	548 (100%)
1	21-B	551/551 (100%)	0.19	45 (8%) 11 15	12, 14, 15, 17	551 (100%)
1	22-A	548/551 (99%)	0.26	46 (8%) 11 14	13, 14, 16, 17	548 (100%)
1	22-B	551/551 (100%)	0.19	45 (8%) 11 15	12, 14, 15, 17	551 (100%)
1	23-A	548/551 (99%)	0.26	46 (8%) 11 14	13, 14, 16, 17	548 (100%)
1	23-B	551/551 (100%)	0.19	45 (8%) 11 15	12, 14, 15, 17	551 (100%)
1	24-A	548/551 (99%)	0.26	46 (8%) 11 14	13, 14, 16, 17	548 (100%)
1	24-B	551/551 (100%)	0.19	45 (8%) 11 15	12, 14, 15, 17	551 (100%)
1	25-A	548/551 (99%)	0.26	46 (8%) 11 14	13, 14, 16, 17	548 (100%)
1	25-B	551/551 (100%)	0.19	45 (8%) 11 15	12, 14, 15, 17	551 (100%)
All	All	27475/27550 (99%)	0.23	2275 (8%) 10 14	12, 14, 15, 17	27475 (100%)

The worst 5 of 2275 RSRZ outliers are listed below:

Mol	Chain	Res	Type	RSRZ
1	1-A	194	TYR	11.4
1	2-A	194	TYR	11.4

Continued on next page...

Continued from previous page...

Mol	Chain	Res	Type	RSRZ
1	3-A	194	TYR	11.4
1	4-A	194	TYR	11.4
1	5-A	194	TYR	11.4

6.2 Non-standard residues in protein, DNA, RNA chains [i](#)

There are no non-standard protein/DNA/RNA residues in this entry.

6.3 Carbohydrates [i](#)

There are no monosaccharides in this entry.

6.4 Ligands [i](#)

In the following table, the Atoms column lists the number of modelled atoms in the group and the number defined in the chemical component dictionary. The B-factors column lists the minimum, median, 95th percentile and maximum values of B factors of atoms in the group. The column labelled 'Q< 0.9' lists the number of atoms with occupancy less than 0.9.

Mol	Type	Chain	Res	Atoms	RSCC	RSR	B-factors(Å ²)	Q<0.9
3	BGC	1-B	701	12/12	0.93	0.17	10,16,32,38	24
3	BGC	2-B	701	12/12	0.93	0.17	10,16,32,38	24
3	BGC	3-B	701	12/12	0.93	0.17	10,16,32,38	24
3	BGC	4-B	701	12/12	0.93	0.17	10,16,32,38	24
3	BGC	5-B	701	12/12	0.93	0.17	10,16,32,38	24
3	BGC	6-B	701	12/12	0.93	0.17	10,16,32,38	24
3	BGC	7-B	701	12/12	0.93	0.17	10,16,32,38	24
3	BGC	8-B	701	12/12	0.93	0.17	10,16,32,38	24
3	BGC	9-B	701	12/12	0.93	0.17	10,16,32,38	24
3	BGC	10-B	701	12/12	0.93	0.17	10,16,32,38	24
3	BGC	11-B	701	12/12	0.93	0.17	10,16,32,38	24
3	BGC	12-B	701	12/12	0.93	0.17	10,16,32,38	24
3	BGC	13-B	701	12/12	0.93	0.17	10,16,32,38	24
3	BGC	14-B	701	12/12	0.93	0.17	10,16,32,38	24
3	BGC	15-B	701	12/12	0.93	0.17	10,16,32,38	24
3	BGC	16-B	701	12/12	0.93	0.17	10,16,32,38	24
3	BGC	17-B	701	12/12	0.93	0.17	10,16,32,38	24
3	BGC	18-B	701	12/12	0.93	0.17	10,16,32,38	24
3	BGC	19-B	701	12/12	0.93	0.17	10,16,32,38	24
3	BGC	20-B	701	12/12	0.93	0.17	10,16,32,38	24

Continued on next page...

Continued from previous page...

Mol	Type	Chain	Res	Atoms	RSCC	RSR	B-factors(\AA^2)	Q<0.9
3	BGC	21-B	701	12/12	0.93	0.17	10,16,32,38	24
3	BGC	22-B	701	12/12	0.93	0.17	10,16,32,38	24
3	BGC	23-B	701	12/12	0.93	0.17	10,16,32,38	24
3	BGC	24-B	701	12/12	0.93	0.17	10,16,32,38	24
3	BGC	25-B	701	12/12	0.93	0.17	10,16,32,38	24
2	EDO	1-B	704	4/4	0.94	0.14	13,14,29,30	10
2	EDO	2-B	704	4/4	0.94	0.14	13,14,29,30	10
2	EDO	3-B	704	4/4	0.94	0.14	13,14,29,30	10
2	EDO	4-B	704	4/4	0.94	0.14	13,14,29,30	10
2	EDO	5-B	704	4/4	0.94	0.14	13,14,29,30	10
2	EDO	6-B	704	4/4	0.94	0.14	13,14,29,30	10
2	EDO	7-B	704	4/4	0.94	0.14	13,14,29,30	10
2	EDO	8-B	704	4/4	0.94	0.14	13,14,29,30	10
2	EDO	9-B	704	4/4	0.94	0.14	13,14,29,30	10
2	EDO	10-B	704	4/4	0.94	0.14	13,14,29,30	10
2	EDO	11-B	704	4/4	0.94	0.14	13,14,29,30	10
2	EDO	12-B	704	4/4	0.94	0.14	13,14,29,30	10
2	EDO	13-B	704	4/4	0.94	0.14	13,14,29,30	10
2	EDO	14-B	704	4/4	0.94	0.14	13,14,29,30	10
2	EDO	15-B	704	4/4	0.94	0.14	13,14,29,30	10
2	EDO	16-B	704	4/4	0.94	0.14	13,14,29,30	10
2	EDO	17-B	704	4/4	0.94	0.14	13,14,29,30	10
2	EDO	18-B	704	4/4	0.94	0.14	13,14,29,30	10
2	EDO	19-B	704	4/4	0.94	0.14	13,14,29,30	10
2	EDO	20-B	704	4/4	0.94	0.14	13,14,29,30	10
2	EDO	21-B	704	4/4	0.94	0.14	13,14,29,30	10
2	EDO	22-B	704	4/4	0.94	0.14	13,14,29,30	10
2	EDO	23-B	704	4/4	0.94	0.14	13,14,29,30	10
2	EDO	24-B	704	4/4	0.94	0.14	13,14,29,30	10
2	EDO	25-B	704	4/4	0.94	0.14	13,14,29,30	10
2	EDO	1-A	701	4/4	0.97	0.08	13,26,27,27	10
2	EDO	2-A	701	4/4	0.97	0.08	13,26,27,27	10
2	EDO	3-A	701	4/4	0.97	0.08	13,26,27,27	10
2	EDO	4-A	701	4/4	0.97	0.08	13,26,27,27	10
2	EDO	5-A	701	4/4	0.97	0.08	13,26,27,27	10
2	EDO	6-A	701	4/4	0.97	0.08	13,26,27,27	10
2	EDO	7-A	701	4/4	0.97	0.08	13,26,27,27	10
2	EDO	8-A	701	4/4	0.97	0.08	13,26,27,27	10
2	EDO	9-A	701	4/4	0.97	0.08	13,26,27,27	10
2	EDO	10-A	701	4/4	0.97	0.08	13,26,27,27	10
2	EDO	11-A	701	4/4	0.97	0.08	13,26,27,27	10
2	EDO	12-A	701	4/4	0.97	0.08	13,26,27,27	10

Continued on next page...

Continued from previous page...

Mol	Type	Chain	Res	Atoms	RSCC	RSR	B-factors(\AA^2)	Q<0.9
2	EDO	13-A	701	4/4	0.97	0.08	13,26,27,27	10
2	EDO	14-A	701	4/4	0.97	0.08	13,26,27,27	10
2	EDO	15-A	701	4/4	0.97	0.08	13,26,27,27	10
2	EDO	16-A	701	4/4	0.97	0.08	13,26,27,27	10
2	EDO	17-A	701	4/4	0.97	0.08	13,26,27,27	10
2	EDO	18-A	701	4/4	0.97	0.08	13,26,27,27	10
2	EDO	19-A	701	4/4	0.97	0.08	13,26,27,27	10
2	EDO	20-A	701	4/4	0.97	0.08	13,26,27,27	10
2	EDO	21-A	701	4/4	0.97	0.08	13,26,27,27	10
2	EDO	22-A	701	4/4	0.97	0.08	13,26,27,27	10
2	EDO	23-A	701	4/4	0.97	0.08	13,26,27,27	10
2	EDO	24-A	701	4/4	0.97	0.08	13,26,27,27	10
2	EDO	25-A	701	4/4	0.97	0.08	13,26,27,27	10
2	EDO	1-B	702	4/4	0.97	0.07	13,13,16,16	10
2	EDO	2-B	702	4/4	0.97	0.07	13,13,16,16	10
2	EDO	3-B	702	4/4	0.97	0.07	13,13,16,16	10
2	EDO	4-B	702	4/4	0.97	0.07	13,13,16,16	10
2	EDO	5-B	702	4/4	0.97	0.07	13,13,16,16	10
2	EDO	6-B	702	4/4	0.97	0.07	13,13,16,16	10
2	EDO	7-B	702	4/4	0.97	0.07	13,13,16,16	10
2	EDO	8-B	702	4/4	0.97	0.07	13,13,16,16	10
2	EDO	9-B	702	4/4	0.97	0.07	13,13,16,16	10
2	EDO	10-B	702	4/4	0.97	0.07	13,13,16,16	10
2	EDO	11-B	702	4/4	0.97	0.07	13,13,16,16	10
2	EDO	12-B	702	4/4	0.97	0.07	13,13,16,16	10
2	EDO	13-B	702	4/4	0.97	0.07	13,13,16,16	10
2	EDO	14-B	702	4/4	0.97	0.07	13,13,16,16	10
2	EDO	15-B	702	4/4	0.97	0.07	13,13,16,16	10
2	EDO	16-B	702	4/4	0.97	0.07	13,13,16,16	10
2	EDO	17-B	702	4/4	0.97	0.07	13,13,16,16	10
2	EDO	18-B	702	4/4	0.97	0.07	13,13,16,16	10
2	EDO	19-B	702	4/4	0.97	0.07	13,13,16,16	10
2	EDO	20-B	702	4/4	0.97	0.07	13,13,16,16	10
2	EDO	21-B	702	4/4	0.97	0.07	13,13,16,16	10
2	EDO	22-B	702	4/4	0.97	0.07	13,13,16,16	10
2	EDO	23-B	702	4/4	0.97	0.07	13,13,16,16	10
2	EDO	24-B	702	4/4	0.97	0.07	13,13,16,16	10
2	EDO	25-B	702	4/4	0.97	0.07	13,13,16,16	10
2	EDO	1-A	702	4/4	0.98	0.15	13,20,20,21	10
2	EDO	2-A	702	4/4	0.98	0.15	13,20,20,21	10
2	EDO	3-A	702	4/4	0.98	0.15	13,20,20,21	10
2	EDO	4-A	702	4/4	0.98	0.15	13,20,20,21	10

Continued on next page...

Continued from previous page...

Mol	Type	Chain	Res	Atoms	RSCC	RSR	B-factors(\AA^2)	Q<0.9
2	EDO	5-A	702	4/4	0.98	0.15	13,20,20,21	10
2	EDO	6-A	702	4/4	0.98	0.15	13,20,20,21	10
2	EDO	7-A	702	4/4	0.98	0.15	13,20,20,21	10
2	EDO	8-A	702	4/4	0.98	0.15	13,20,20,21	10
2	EDO	9-A	702	4/4	0.98	0.15	13,20,20,21	10
2	EDO	10-A	702	4/4	0.98	0.15	13,20,20,21	10
2	EDO	11-A	702	4/4	0.98	0.15	13,20,20,21	10
2	EDO	12-A	702	4/4	0.98	0.15	13,20,20,21	10
2	EDO	13-A	702	4/4	0.98	0.15	13,20,20,21	10
2	EDO	14-A	702	4/4	0.98	0.15	13,20,20,21	10
2	EDO	15-A	702	4/4	0.98	0.15	13,20,20,21	10
2	EDO	16-A	702	4/4	0.98	0.15	13,20,20,21	10
2	EDO	17-A	702	4/4	0.98	0.15	13,20,20,21	10
2	EDO	18-A	702	4/4	0.98	0.15	13,20,20,21	10
2	EDO	19-A	702	4/4	0.98	0.15	13,20,20,21	10
2	EDO	20-A	702	4/4	0.98	0.15	13,20,20,21	10
2	EDO	21-A	702	4/4	0.98	0.15	13,20,20,21	10
2	EDO	22-A	702	4/4	0.98	0.15	13,20,20,21	10
2	EDO	23-A	702	4/4	0.98	0.15	13,20,20,21	10
2	EDO	24-A	702	4/4	0.98	0.15	13,20,20,21	10
2	EDO	25-A	702	4/4	0.98	0.15	13,20,20,21	10
2	EDO	1-B	703	4/4	0.99	0.17	12,21,22,22	10
2	EDO	2-B	703	4/4	0.99	0.17	12,21,22,22	10
2	EDO	3-B	703	4/4	0.99	0.17	12,21,22,22	10
2	EDO	4-B	703	4/4	0.99	0.17	12,21,22,22	10
2	EDO	5-B	703	4/4	0.99	0.17	12,21,22,22	10
2	EDO	6-B	703	4/4	0.99	0.17	12,21,22,22	10
2	EDO	7-B	703	4/4	0.99	0.17	12,21,22,22	10
2	EDO	8-B	703	4/4	0.99	0.17	12,21,22,22	10
2	EDO	9-B	703	4/4	0.99	0.17	12,21,22,22	10
2	EDO	10-B	703	4/4	0.99	0.17	12,21,22,22	10
2	EDO	11-B	703	4/4	0.99	0.17	12,21,22,22	10
2	EDO	12-B	703	4/4	0.99	0.17	12,21,22,22	10
2	EDO	13-B	703	4/4	0.99	0.17	12,21,22,22	10
2	EDO	14-B	703	4/4	0.99	0.17	12,21,22,22	10
2	EDO	15-B	703	4/4	0.99	0.17	12,21,22,22	10
2	EDO	16-B	703	4/4	0.99	0.17	12,21,22,22	10
2	EDO	17-B	703	4/4	0.99	0.17	12,21,22,22	10
2	EDO	18-B	703	4/4	0.99	0.17	12,21,22,22	10
2	EDO	19-B	703	4/4	0.99	0.17	12,21,22,22	10
2	EDO	20-B	703	4/4	0.99	0.17	12,21,22,22	10
2	EDO	21-B	703	4/4	0.99	0.17	12,21,22,22	10

Continued on next page...

Continued from previous page...

Mol	Type	Chain	Res	Atoms	RSCC	RSR	B-factors(\AA^2)	Q<0.9
2	EDO	22-B	703	4/4	0.99	0.17	12,21,22,22	10
2	EDO	23-B	703	4/4	0.99	0.17	12,21,22,22	10
2	EDO	24-B	703	4/4	0.99	0.17	12,21,22,22	10
2	EDO	25-B	703	4/4	0.99	0.17	12,21,22,22	10

6.5 Other polymers [i](#)

There are no such residues in this entry.