



wwPDB EM Validation Summary Report ⓘ

Nov 28, 2022 – 08:46 PM EST

PDB ID : 7TBJ
EMDB ID : EMD-14322
Title : Composite structure of the human nuclear pore complex (NPC) symmetric core generated with a 12Å cryo-ET map of the purified HeLa cell NPC
Authors : Petrovic, S.; Samanta, D.; Perriches, T.; Bley, C.J.; Thierbach, K.; Brown, B.; Nie, S.; Mobbs, G.W.; Stevens, T.A.; Liu, X.; Tomaleri, G.P.; Schaus, L.; Hoelz, A.
Deposited on : 2021-12-22
Resolution : 23.00 Å(reported)

This is a wwPDB EM Validation Summary Report for a publicly released PDB entry.

We welcome your comments at validation@mail.wwpdb.org

A user guide is available at

<https://www.wwpdb.org/validation/2017/EMValidationReportHelp>

with specific help available everywhere you see the ⓘ symbol.

The types of validation reports are described at

<http://www.wwpdb.org/validation/2017/FAQs#types>.

The following versions of software and data (see [references ⓘ](#)) were used in the production of this report:

EMDB validation analysis : 0.0.1.dev43
Mogul : 1.8.5 (274361), CSD as541be (2020)
MolProbity : 4.02b-467
Percentile statistics : 20191225.v01 (using entries in the PDB archive December 25th 2019)
MapQ : 1.9.9
Ideal geometry (proteins) : Engh & Huber (2001)
Ideal geometry (DNA, RNA) : Parkinson et al. (1996)
Validation Pipeline (wwPDB-VP) : 2.31.2

1 Overall quality at a glance i

The following experimental techniques were used to determine the structure:

ELECTRON MICROSCOPY

The reported resolution of this entry is 23.00 Å.

Percentile scores (ranging between 0-100) for global validation metrics of the entry are shown in the following graphic. The table shows the number of entries on which the scores are based.

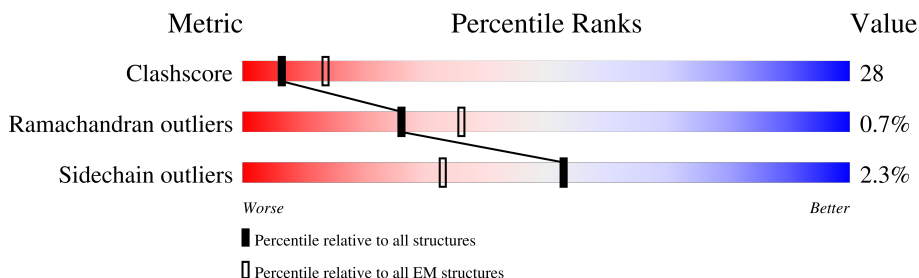

Metric	Whole archive (#Entries)	EM structures (#Entries)
Clashscore	158937	4297
Ramachandran outliers	154571	4023
Sidechain outliers	154315	3826

The table below summarises the geometric issues observed across the polymeric chains and their fit to the map. The red, orange, yellow and green segments of the bar indicate the fraction of residues that contain outliers for ≥ 3 , 2, 1 and 0 types of geometric quality criteria respectively. A grey segment represents the fraction of residues that are not modelled. The numeric value for each fraction is indicated below the corresponding segment, with a dot representing fractions $\leq 5\%$. The upper red bar (where present) indicates the fraction of residues that have poor fit to the EM map (all-atom inclusion $< 40\%$). The numeric value is given above the bar.

Mol	Chain	Length	Quality of chain
1	A1	1316	
1	A3	1316	
2	A2	1328	
2	A4	1328	
3	A5	1330	
3	A6	1330	
4	B1	14	
4	B2	14	

Continued on next page...

Continued from previous page...

Mol	Chain	Length	Quality of chain
4	B3	14	100% 93% 7%
4	B4	14	93% 57% 43%
4	B5	14	93% 79% 21%
4	B6	14	100% 64% 36%
5	C1	19	53% 84% 5% 11%
5	C2	19	37% 5% 95%
5	C3	19	84% 84% 5% 11%
5	C4	19	58% 5% 95%
5	C5	19	58% 32% 11%
5	C6	19	53% 58% 32% 11%
6	D1	644	20% 70% 26% .
6	D2	644	23% 83% 14% .
6	D3	644	25% 67% 29% .
6	D4	644	50% 83% 13% .
6	D5	644	15% 83% 13% .
6	D6	644	24% 84% 12% .
6	D7	644	46% 81% 15% .
7	E1	8	12% 75% 25%
7	E2	8	50% 75% 25%
7	E3	8	62% 75% 25%
7	E4	8	62% 75% 25%
7	E5	8	75% 75% 25%
7	E6	8	25% 75% 25%
7	E7	8	100% 75% 25%
8	F1	1858	26% 81% 7% 12%

Continued on next page...

Continued from previous page...

Mol	Chain	Length	Quality of chain
8	F2	1858	42% 82% 6% 12%
9	G1	53	40% 68% 32%
9	G2	53	55% 85% 15%
10	H1	13	62% 100%
10	H2	13	69% 100%
11	I1	1756	30% 68% 20% 12%
11	I2	1756	31% 68% 20% 12%
11	I3	1756	21% 79% 9% 12%
11	I4	1756	39% 80% 8% 12%
11	I5	1756	25% 78% 10% 12%
12	J1	63	46% 71% 29%
12	J2	63	35% 71% 29%
12	J3	63	43% 79% 21%
12	J4	63	49% 79% 21%
12	J5	63	29% 79% 21%
13	K1	9	89% 100%
13	K2	9	89% 100%
13	K3	9	67% 100%
13	K4	9	100%
13	K5	9	78% 100%
14	L1	2	100%
14	L2	2	100%
14	L3	2	100%
14	L4	2	100%
14	L5	2	50% 100%











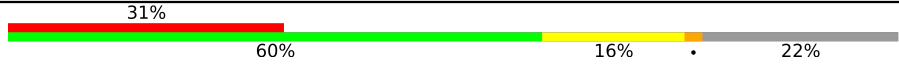
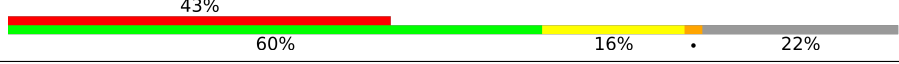
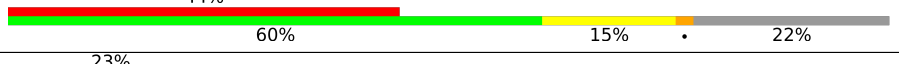

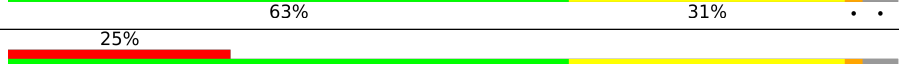
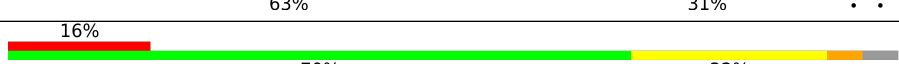
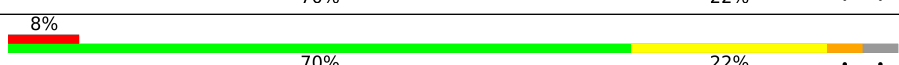
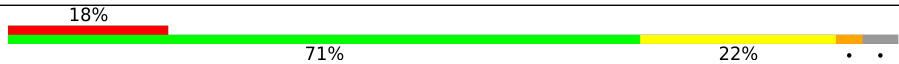

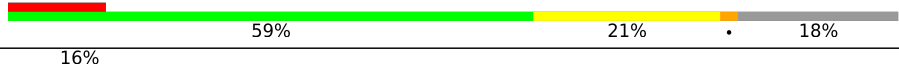
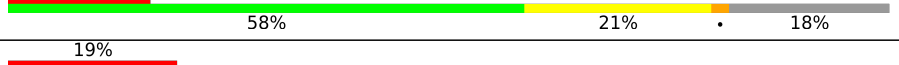

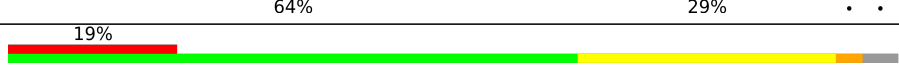
Continued on next page...

Continued from previous page...

Mol	Chain	Length	Quality of chain
15	M1	183	
15	M2	183	
15	M3	183	
15	M4	183	
16	N1	222	
16	N2	222	
16	N3	222	
16	N4	222	
17	O1	241	
17	O2	241	
17	O3	241	
17	O4	241	
18	P1	116	
18	P2	116	
18	P3	116	
18	P4	116	
19	Q1	84	
19	Q2	84	
19	Q3	84	
19	Q4	84	
20	R1	40	
20	R2	40	
20	R3	40	
20	R4	40	
21	S1	1156	

Continued on next page...

Continued from previous page...

Mol	Chain	Length	Quality of chain
21	S2	1156	
21	S3	1156	
21	S4	1156	
22	T1	258	
22	T2	258	
22	T3	258	
22	T4	258	
23	U1	436	
23	U2	436	
23	U3	436	
23	U4	436	
24	V1	621	
24	V2	621	
24	V3	621	
24	V4	621	
25	W1	286	
25	W2	286	
25	W3	286	
25	W4	286	
26	X1	698	
26	X2	698	
26	X3	698	
26	X4	698	
27	Y1	346	
27	Y2	346	

Continued on next page...

Continued from previous page...

Mol	Chain	Length	Quality of chain
27	Y3	346	
27	Y4	346	
28	Z1	1035	
28	Z2	1035	
28	Z3	1035	
28	Z4	1035	
29	a1	380	
29	a2	380	
29	a3	380	
29	a4	380	
30	b1	385	
30	b2	385	
30	b3	385	
30	b4	385	

2 Entry composition [i](#)

There are 30 unique types of molecules in this entry. The entry contains 358888 atoms, of which 0 are hydrogens and 0 are deuteriums.

In the tables below, the AltConf column contains the number of residues with at least one atom in alternate conformation and the Trace column contains the number of residues modelled with at most 2 atoms.

- Molecule 1 is a protein called NUP155.

Mol	Chain	Residues	Atoms					AltConf	Trace
			Total	C	N	O	S		
1	A1	1231	Total 9730	C 6152	N 1707	O 1843	S 28	1	0
1	A3	1231	Total 9730	C 6152	N 1707	O 1843	S 28	1	0

- Molecule 2 is a protein called NUP155.

Mol	Chain	Residues	Atoms						AltConf	Trace
			Total	C	N	O	S	Se		
2	A2	1269	Total 9946	C 6277	N 1745	O 1890	S 22	Se 12	0	0
2	A4	1269	Total 9946	C 6277	N 1745	O 1890	S 22	Se 12	0	0

- Molecule 3 is a protein called NUP155.

Mol	Chain	Residues	Atoms						AltConf	Trace
			Total	C	N	O	S	Se		
3	A5	1276	Total 10030	C 6331	N 1762	O 1901	S 24	Se 12	1	0
3	A6	1276	Total 10030	C 6331	N 1762	O 1901	S 24	Se 12	1	0

- Molecule 4 is a protein called NUP53 R3.

Mol	Chain	Residues	Atoms					AltConf	Trace
			Total	C	N	O	S		
4	B1	14	Total 111	C 73	N 19	O 18	S 1	0	0
4	B2	14	Total 111	C 73	N 19	O 18	S 1	0	0
4	B3	14	Total 111	C 73	N 19	O 18	S 1	0	0
4	B4	14	Total 111	C 73	N 19	O 18	S 1	0	0

Continued on next page...

Continued from previous page...

Mol	Chain	Residues	Atoms					AltConf	Trace
4	B5	14	Total	C	N	O	S	0	0
			111	73	19	18	1		
4	B6	14	Total	C	N	O	S	0	0
			111	73	19	18	1		

- Molecule 5 is a protein called NUP98 R3.

Mol	Chain	Residues	Atoms					AltConf	Trace
5	C1	17	Total	C	N	O	S	0	0
			138	88	24	25	1		
5	C2	19	Total	C	N	O	S	0	0
			157	100	29	27	1		
5	C3	17	Total	C	N	O	S	0	0
			138	88	24	25	1		
5	C4	19	Total	C	N	O	S	0	0
			157	100	29	27	1		
5	C5	17	Total	C	N	O	S	0	0
			138	88	24	25	1		
5	C6	17	Total	C	N	O	S	0	0
			138	88	24	25	1		

- Molecule 6 is a protein called NUP93 SOL.

Mol	Chain	Residues	Atoms					AltConf	Trace
6	D1	621	Total	C	N	O	S	0	0
			5034	3200	874	934	26		
6	D2	621	Total	C	N	O	S	0	0
			5034	3200	874	934	26		
6	D3	621	Total	C	N	O	S	0	0
			5034	3200	874	934	26		
6	D4	621	Total	C	N	O	S	0	0
			5034	3200	874	934	26		
6	D5	621	Total	C	N	O	S	0	0
			5034	3200	874	934	26		
6	D6	621	Total	C	N	O	S	0	0
			5034	3200	874	934	26		
6	D7	621	Total	C	N	O	S	0	0
			5034	3200	874	934	26		

- Molecule 7 is a protein called NUP53 R2.

Mol	Chain	Residues	Atoms				AltConf	Trace
7	E1	8	Total	C	N	O	0	0
			63	42	11	10		
7	E2	8	Total	C	N	O	0	0
			63	42	11	10		
7	E3	8	Total	C	N	O	0	0
			63	42	11	10		
7	E4	8	Total	C	N	O	0	0
			63	42	11	10		
7	E5	8	Total	C	N	O	0	0
			63	42	11	10		
7	E6	8	Total	C	N	O	0	0
			63	42	11	10		
7	E7	8	Total	C	N	O	0	0
			63	42	11	10		

- Molecule 8 is a protein called NUP188.

Mol	Chain	Residues	Atoms					AltConf	Trace
8	F1	1641	Total	C	N	O	S	0	0
			12779	8190	2201	2333	55		
8	F2	1641	Total	C	N	O	S	0	0
			12779	8190	2201	2333	55		

- Molecule 9 is a protein called NUP93 R2.

Mol	Chain	Residues	Atoms					AltConf	Trace
9	G1	53	Total	C	N	O	S	0	0
			438	274	75	88	1		
9	G2	53	Total	C	N	O	S	0	0
			438	274	75	88	1		

- Molecule 10 is a protein called NUP98 R2.

Mol	Chain	Residues	Atoms				AltConf	Trace
10	H1	13	Total	C	N	O	0	0
			94	58	15	21		
10	H2	13	Total	C	N	O	0	0
			94	58	15	21		

- Molecule 11 is a protein called NUP205.

Mol	Chain	Residues	Atoms					AltConf	Trace
11	I1	1542	Total 12307	C 7880	N 2084	O 2278	S 65	0	0
11	I2	1542	Total 12307	C 7880	N 2084	O 2278	S 65	0	0
11	I3	1542	Total 12307	C 7880	N 2084	O 2278	S 65	0	0
11	I4	1542	Total 12307	C 7880	N 2084	O 2278	S 65	0	0
11	I5	1542	Total 12307	C 7880	N 2084	O 2278	S 65	0	0

- Molecule 12 is a protein called NUP93 R2.

Mol	Chain	Residues	Atoms					AltConf	Trace
12	J1	63	Total 504	C 315	N 86	O 102	S 1	0	0
12	J2	63	Total 504	C 315	N 86	O 102	S 1	0	0
12	J3	63	Total 504	C 315	N 86	O 102	S 1	0	0
12	J4	63	Total 504	C 315	N 86	O 102	S 1	0	0
12	J5	63	Total 504	C 315	N 86	O 102	S 1	0	0

- Molecule 13 is a protein called NUP98 R1.

Mol	Chain	Residues	Atoms					AltConf	Trace
13	K1	9	Total 73	C 51	N 10	O 11	S 1	0	0
13	K2	9	Total 73	C 51	N 10	O 11	S 1	0	0
13	K3	9	Total 73	C 51	N 10	O 11	S 1	0	0
13	K4	9	Total 73	C 51	N 10	O 11	S 1	0	0
13	K5	9	Total 73	C 51	N 10	O 11	S 1	0	0

- Molecule 14 is a protein called NUP53 R1.

Mol	Chain	Residues	Atoms				AltConf	Trace
14	L1	2	Total	C	N	O	0	0
			15	11	2	2		
14	L2	2	Total	C	N	O	0	0
			15	11	2	2		
14	L3	2	Total	C	N	O	0	0
			15	11	2	2		
14	L4	2	Total	C	N	O	0	0
			15	11	2	2		
14	L5	2	Total	C	N	O	0	0
			15	11	2	2		

- Molecule 15 is a protein called NUP62.

Mol	Chain	Residues	Atoms					AltConf	Trace
15	M1	169	Total	C	N	O	S	0	0
			1372	855	235	276	6		
15	M2	169	Total	C	N	O	S	0	0
			1372	855	235	276	6		
15	M3	169	Total	C	N	O	S	0	0
			1372	855	235	276	6		
15	M4	169	Total	C	N	O	S	0	0
			1372	855	235	276	6		

- Molecule 16 is a protein called NUP58.

Mol	Chain	Residues	Atoms					AltConf	Trace
16	N1	180	Total	C	N	O	S	0	0
			1401	876	236	282	7		
16	N2	180	Total	C	N	O	S	0	0
			1401	876	236	282	7		
16	N3	180	Total	C	N	O	S	0	0
			1401	876	236	282	7		
16	N4	180	Total	C	N	O	S	0	0
			1401	876	236	282	7		

- Molecule 17 is a protein called NUP54.

Mol	Chain	Residues	Atoms					AltConf	Trace
17	O1	241	Total	C	N	O	S	0	0
			1971	1239	360	368	4		
17	O2	241	Total	C	N	O	S	0	0
			1971	1239	360	368	4		

Continued on next page...

Continued from previous page...

Mol	Chain	Residues	Atoms					AltConf	Trace
17	O3	241	Total	C	N	O	S	0	0
			1971	1239	360	368	4		
17	O4	241	Total	C	N	O	S	0	0
			1971	1239	360	368	4		

- Molecule 18 is a protein called NUP54 Ferredoxin-like domain.

Mol	Chain	Residues	Atoms					AltConf	Trace
18	P1	116	Total	C	N	O	S	1	0
			900	560	160	178	2		
18	P2	116	Total	C	N	O	S	1	0
			900	560	160	178	2		
18	P3	116	Total	C	N	O	S	1	0
			900	560	160	178	2		
18	P4	116	Total	C	N	O	S	1	0
			900	560	160	178	2		

- Molecule 19 is a protein called NUP53 RRM.

Mol	Chain	Residues	Atoms						AltConf	Trace
19	Q1	84	Total	C	N	O	S	Se	1	0
			658	421	114	117	1	5		
19	Q2	80	Total	C	N	O	S	Se	1	0
			616	399	103	108	1	5		
19	Q3	84	Total	C	N	O	S	Se	1	0
			658	421	114	117	1	5		
19	Q4	80	Total	C	N	O	S	Se	1	0
			616	399	103	108	1	5		

- Molecule 20 is a protein called NUP93 R1.

Mol	Chain	Residues	Atoms				AltConf	Trace
20	R1	40	Total	C	N	O	0	0
			311	195	59	57		
20	R2	40	Total	C	N	O	0	0
			311	195	59	57		
20	R3	40	Total	C	N	O	0	0
			311	195	59	57		
20	R4	40	Total	C	N	O	0	0
			311	195	59	57		

- Molecule 21 is a protein called NUP133.

Mol	Chain	Residues	Atoms					AltConf	Trace
21	S1	902	Total	C	N	O	S	0	0
			6013	3738	1046	1210	19		
21	S2	902	Total	C	N	O	S	0	0
			6013	3738	1046	1210	19		
21	S3	902	Total	C	N	O	S	0	0
			6013	3738	1046	1210	19		
21	S4	902	Total	C	N	O	S	0	0
			6013	3738	1046	1210	19		

- Molecule 22 is a protein called NUP107 CTD.

Mol	Chain	Residues	Atoms					AltConf	Trace
22	T1	247	Total	C	N	O	S	0	0
			1993	1282	343	355	13		
22	T2	247	Total	C	N	O	S	0	0
			1993	1282	343	355	13		
22	T3	247	Total	C	N	O	S	0	0
			1993	1282	343	355	13		
22	T4	247	Total	C	N	O	S	0	0
			1993	1282	343	355	13		

- Molecule 23 is a protein called NUP107 NTD.

Mol	Chain	Residues	Atoms					AltConf	Trace
23	U1	419	Total	C	N	O	S	0	0
			3404	2178	557	657	12		
23	U2	419	Total	C	N	O	S	0	0
			3404	2178	557	657	12		
23	U3	419	Total	C	N	O	S	0	0
			3404	2178	557	657	12		
23	U4	419	Total	C	N	O	S	0	0
			3404	2178	557	657	12		

- Molecule 24 is a protein called NUP96.

Mol	Chain	Residues	Atoms					AltConf	Trace
24	V1	511	Total	C	N	O	S	0	0
			3805	2417	648	730	10		
24	V2	511	Total	C	N	O	S	0	0
			3805	2417	648	730	10		
24	V3	511	Total	C	N	O	S	0	0
			3805	2417	648	730	10		

Continued on next page...

Continued from previous page...

Mol	Chain	Residues	Atoms					AltConf	Trace
			Total	C	N	O	S		
24	V4	511	3805	2417	648	730	10	0	0

- Molecule 25 is a protein called SEC13.

Mol	Chain	Residues	Atoms					AltConf	Trace
			Total	C	N	O	S		
25	W1	274	2160	1379	369	409	3	0	0
25	W2	274	2160	1379	369	409	3	0	0
25	W3	274	2160	1379	369	409	3	0	0
25	W4	274	2160	1379	369	409	3	0	0

- Molecule 26 is a protein called NUP75.

Mol	Chain	Residues	Atoms					AltConf	Trace
			Total	C	N	O	S		
26	X1	620	4535	2884	753	877	21	0	0
26	X2	620	4535	2884	753	877	21	0	0
26	X3	620	4535	2884	753	877	21	0	0
26	X4	620	4535	2884	753	877	21	0	0

- Molecule 27 is a protein called SEH1.

Mol	Chain	Residues	Atoms					AltConf	Trace
			Total	C	N	O	S		
27	Y1	307	2438	1543	422	462	11	0	0
27	Y2	307	2438	1543	422	462	11	0	0
27	Y3	307	2438	1543	422	462	11	0	0
27	Y4	307	2438	1543	422	462	11	0	0

- Molecule 28 is a protein called NUP160.

Mol	Chain	Residues	Atoms					AltConf	Trace
			Total	C	N	O	S		
28	Z1	896	6622	4232	1099	1275	16	0	0
28	Z2	896	6622	4232	1099	1275	16	0	0
28	Z3	896	6622	4232	1099	1275	16	0	0
28	Z4	896	6622	4232	1099	1275	16	0	0

- Molecule 29 is a protein called NUP43.

Mol	Chain	Residues	Atoms					AltConf	Trace
			Total	C	N	O	S		
29	a1	316	2587	1639	447	488	13	33	1
29	a2	316	2587	1639	447	488	13	33	1
29	a3	316	2587	1639	447	488	13	33	1
29	a4	316	2587	1639	447	488	13	33	1

- Molecule 30 is a protein called NUP37.

Mol	Chain	Residues	Atoms					AltConf	Trace
			Total	C	N	O	S		
30	b1	343	2638	1676	447	500	15	0	0
30	b2	343	2638	1676	447	500	15	0	0
30	b3	343	2638	1676	447	500	15	0	0
30	b4	343	2638	1676	447	500	15	0	0

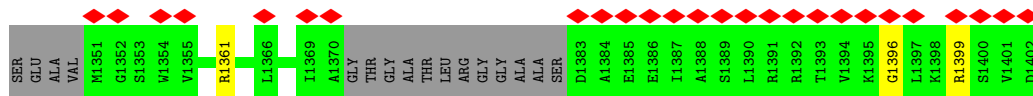

• Molecule 2: NUP155

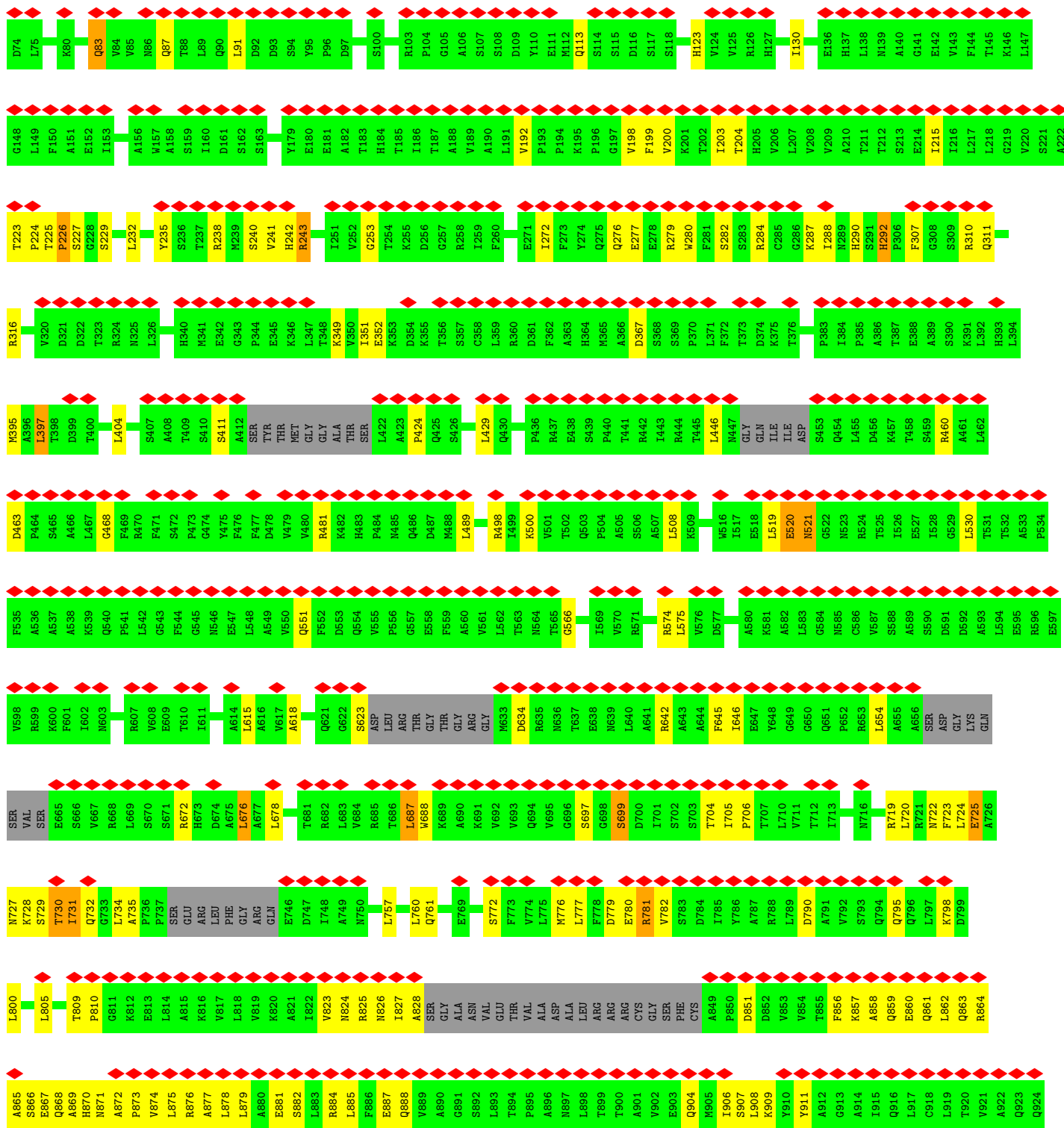
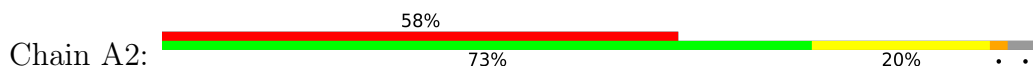

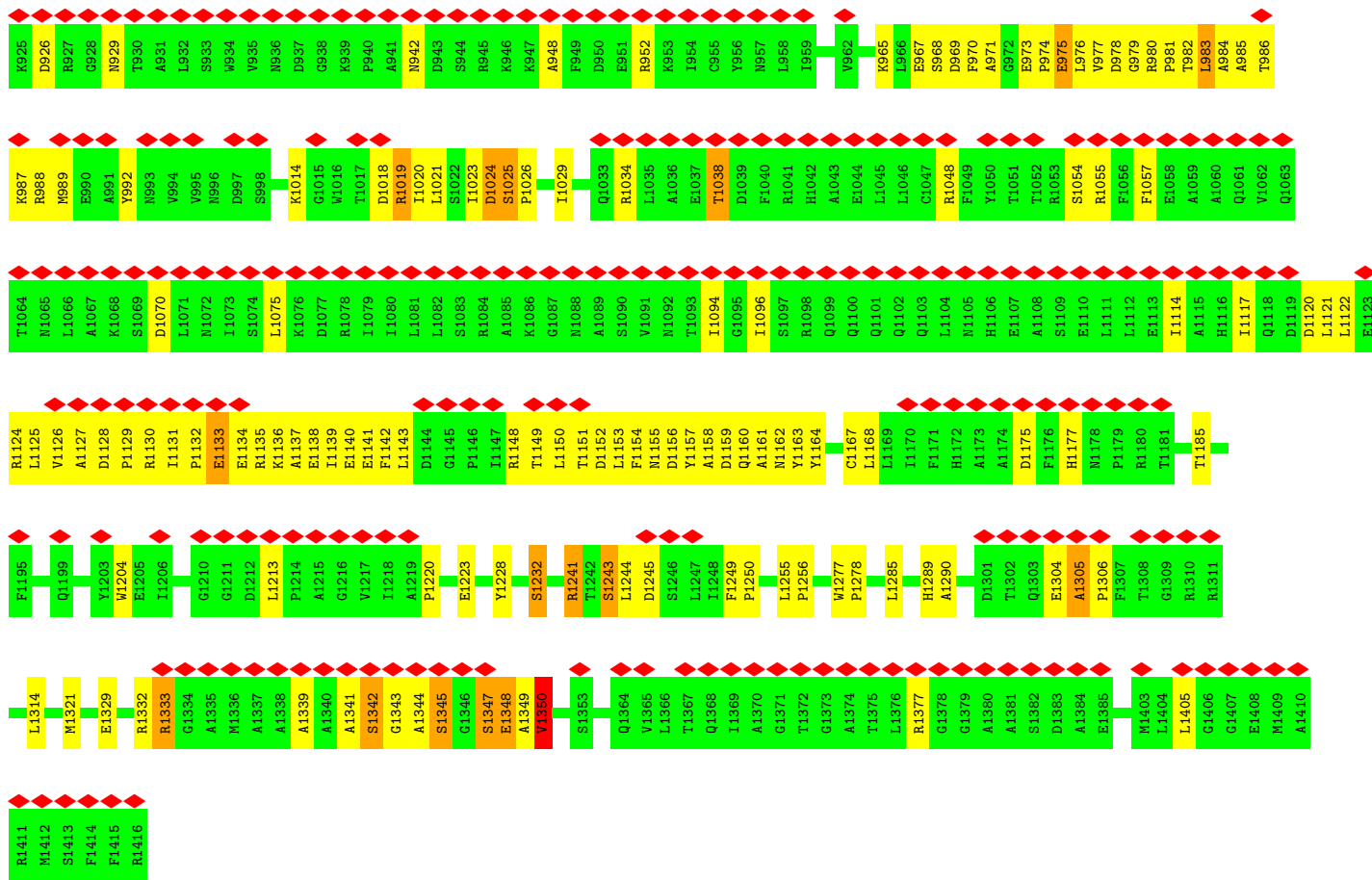

• Molecule 2: NUP155

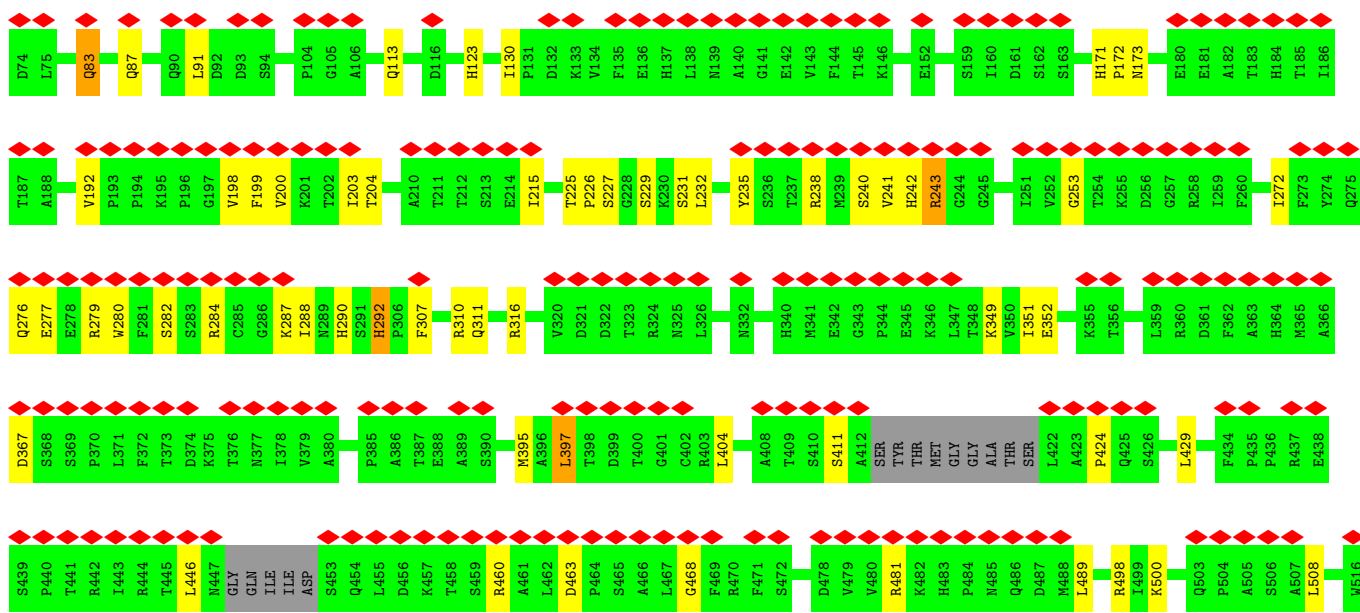
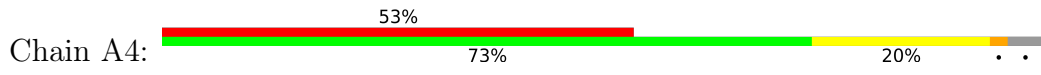

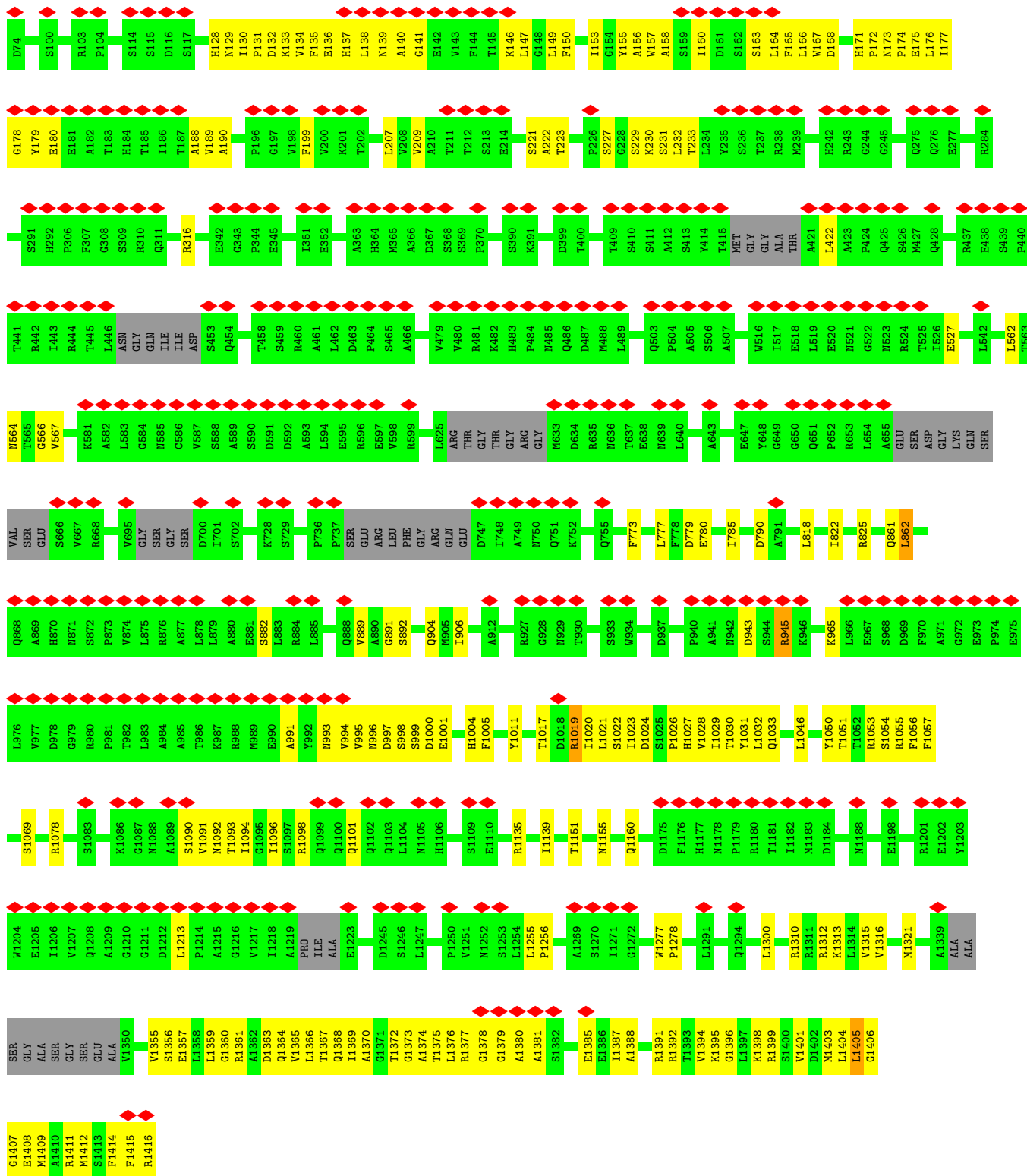

• Molecule 3: NUP155

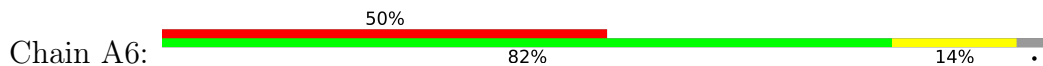

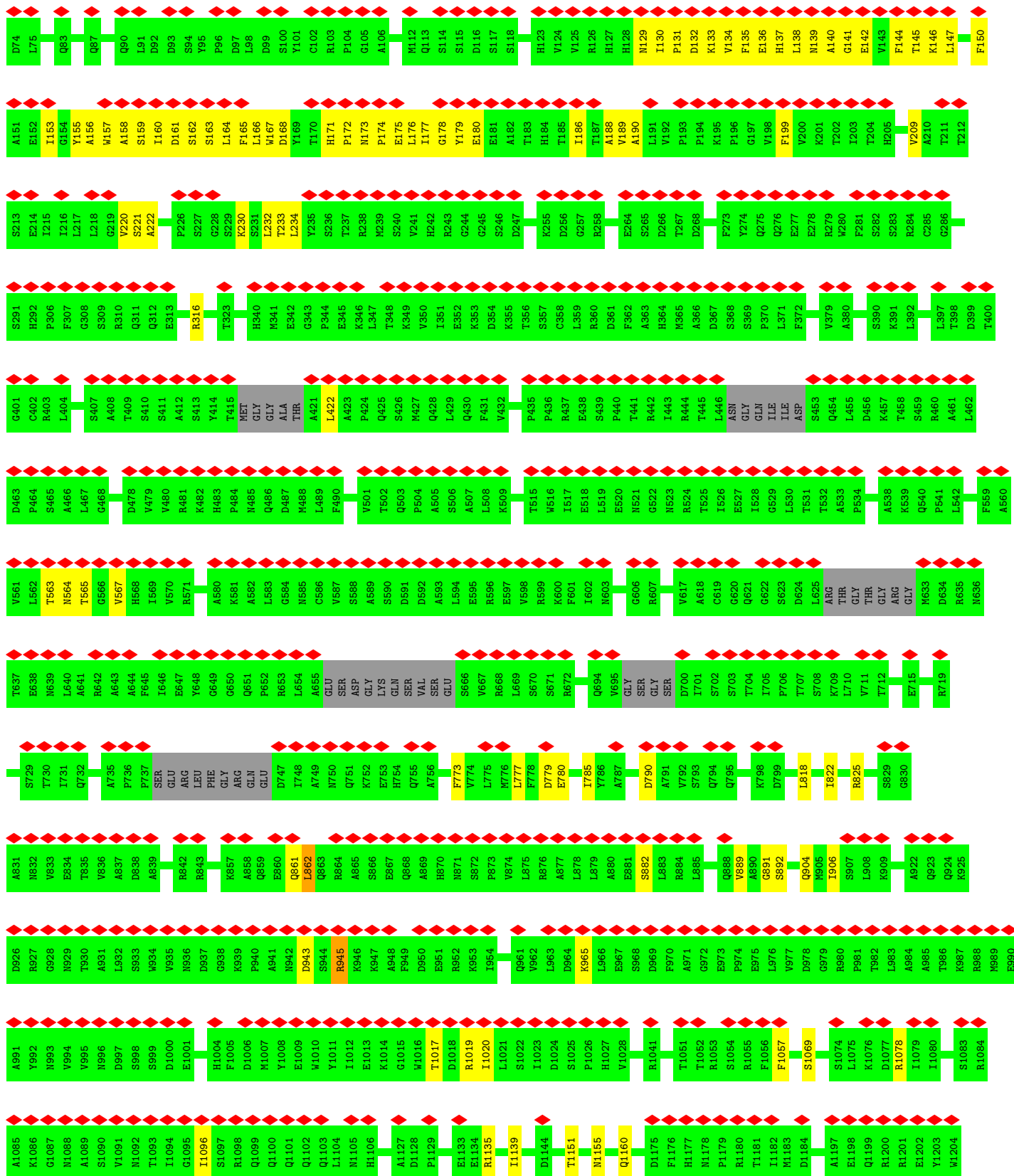

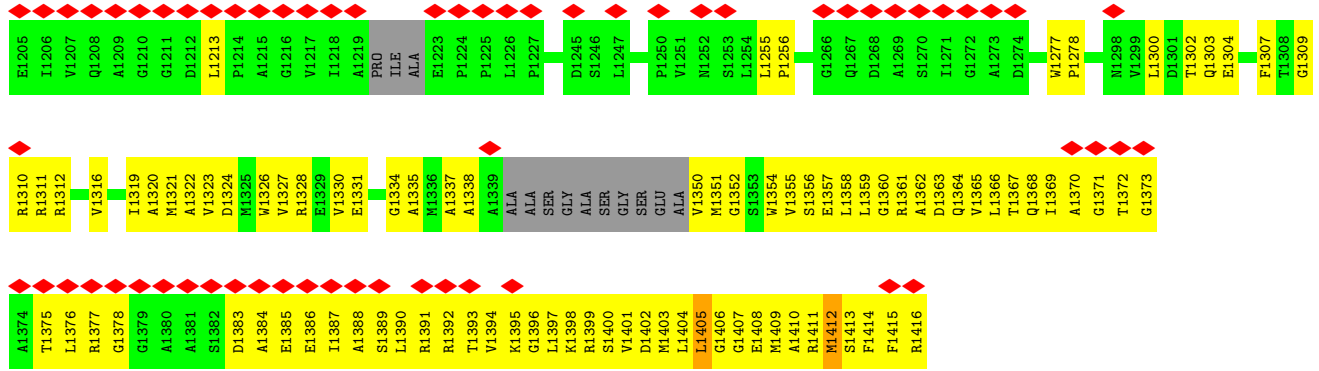

• Molecule 4: NUP53 R3

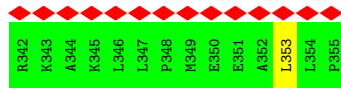

• Molecule 4: NUP53 R3

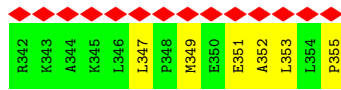

• Molecule 4: NUP53 R3

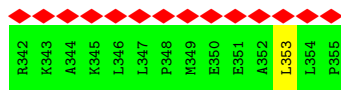

• Molecule 4: NUP53 R3

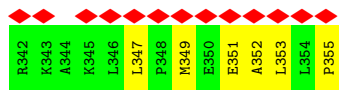

• Molecule 4: NUP53 R3

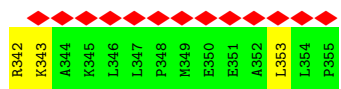
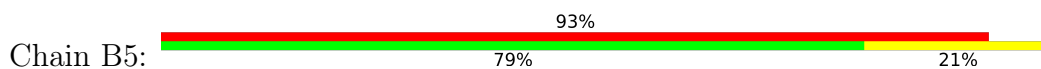

• Molecule 4: NUP53 R3

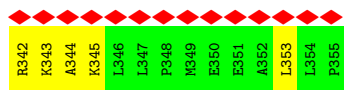

• Molecule 5: NUP98 R3

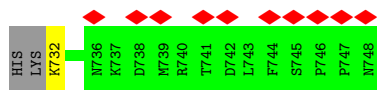
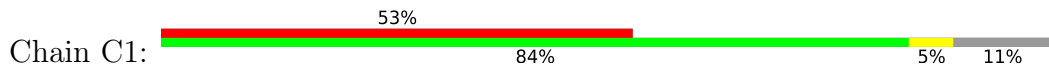

• Molecule 5: NUP98 R3

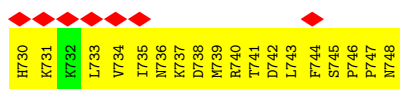

• Molecule 5: NUP98 R3

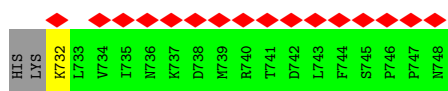
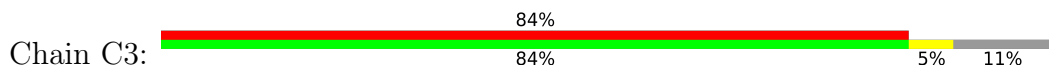

• Molecule 5: NUP98 R3

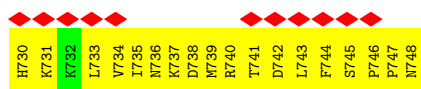

• Molecule 5: NUP98 R3

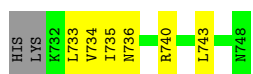

• Molecule 5: NUP98 R3



• Molecule 6: NUP93 SOL

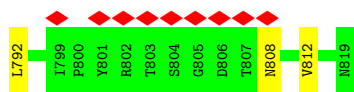

• Molecule 6: NUP93 SOL

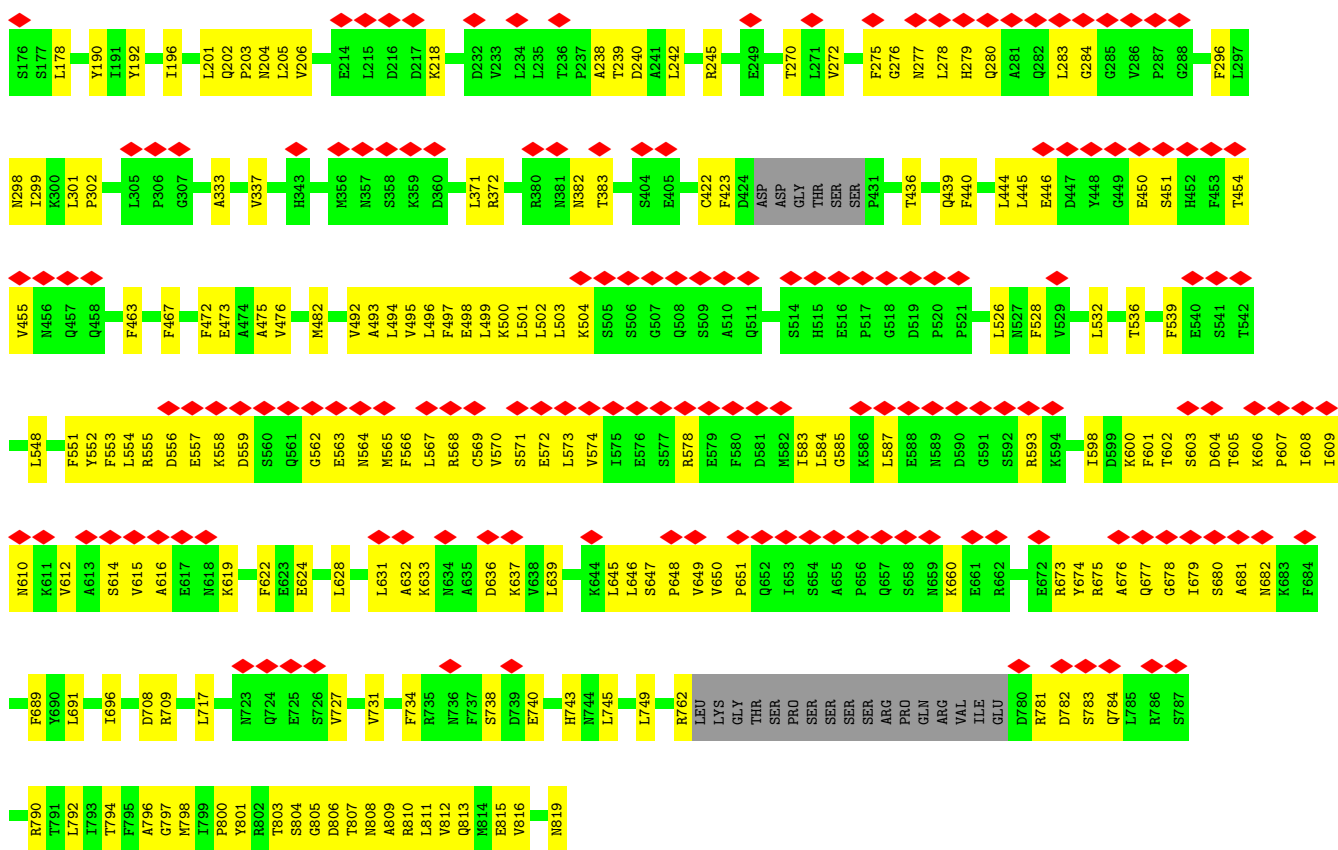

• Molecule 6: NUP93 SOL

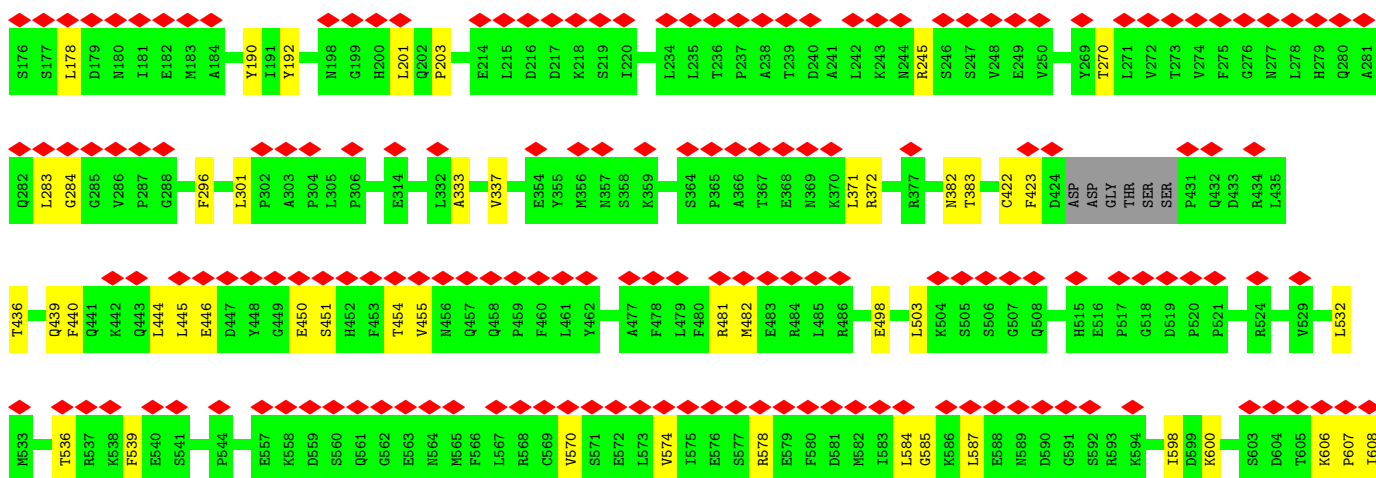
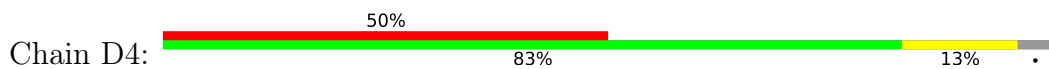

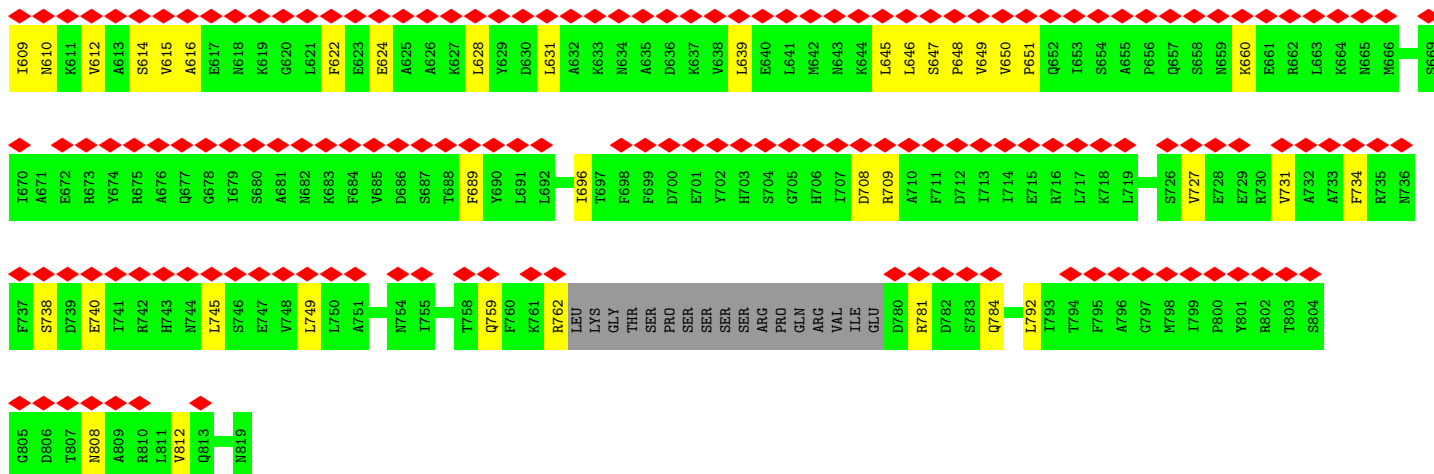

• Molecule 6: NUP93 SOL

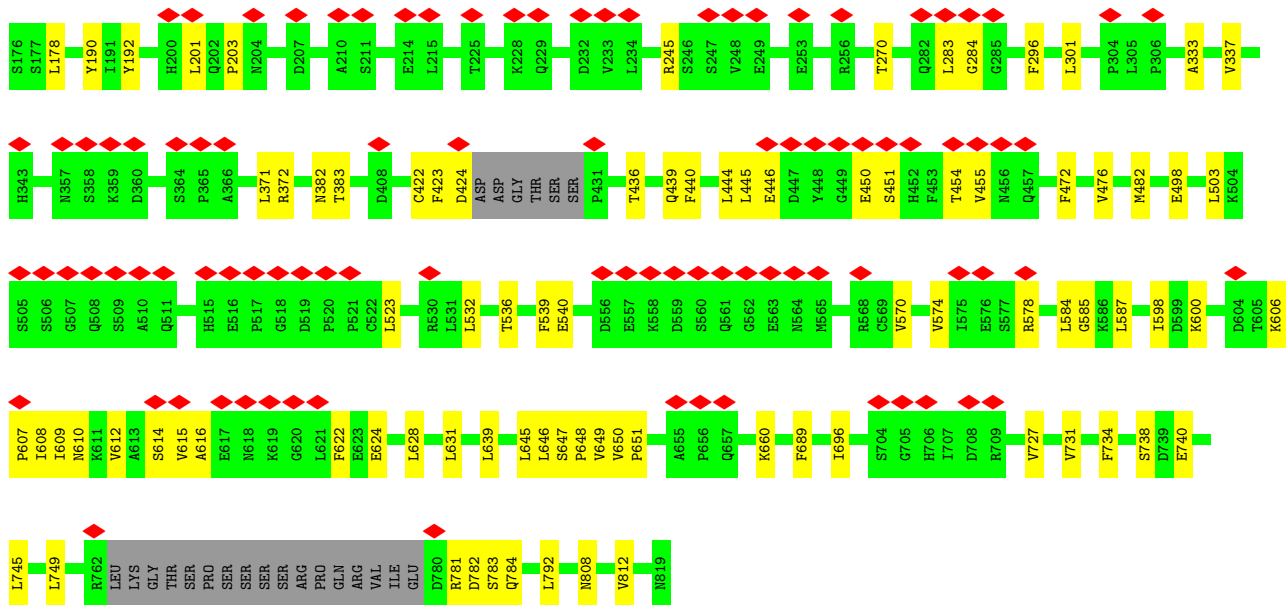
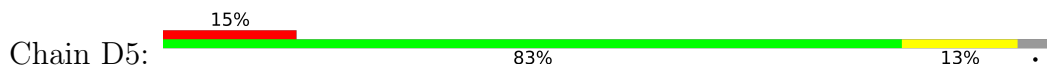

• Molecule 6: NUP93 SOL

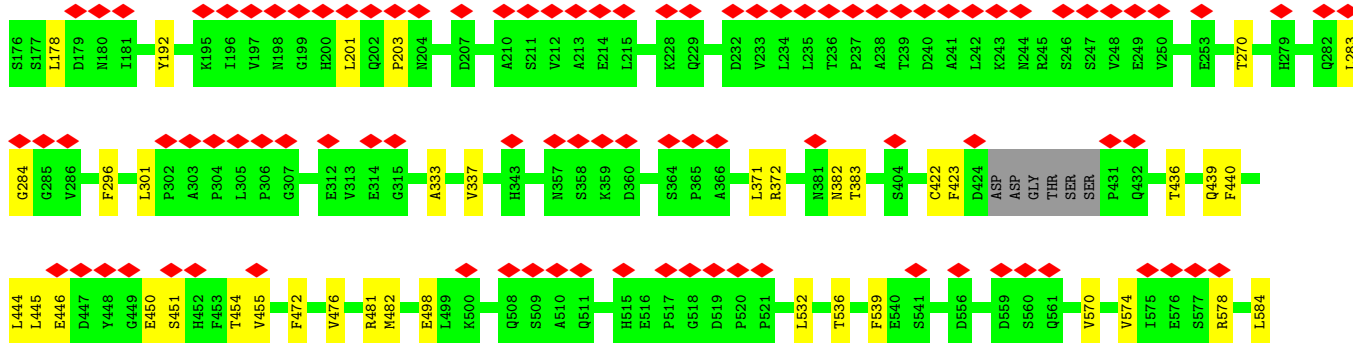
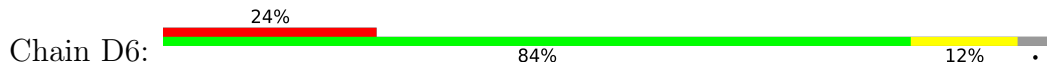

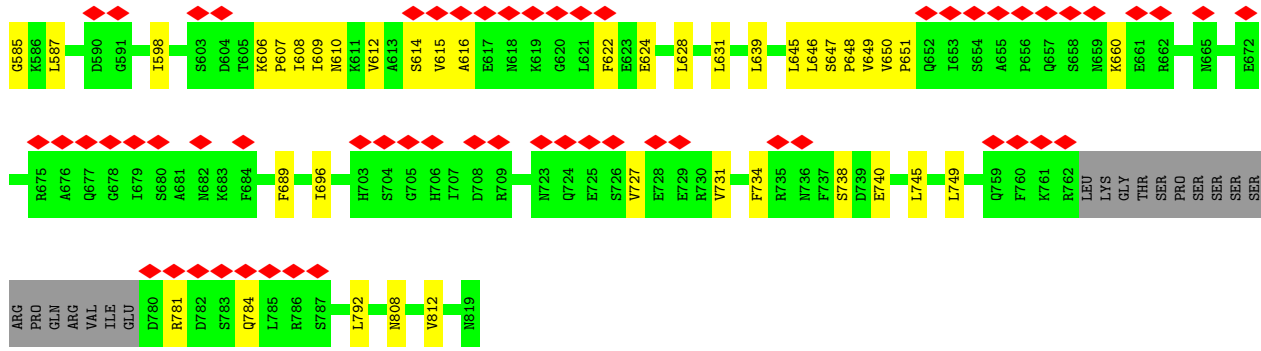

• Molecule 6: NUP93 SOL

Chain D7:

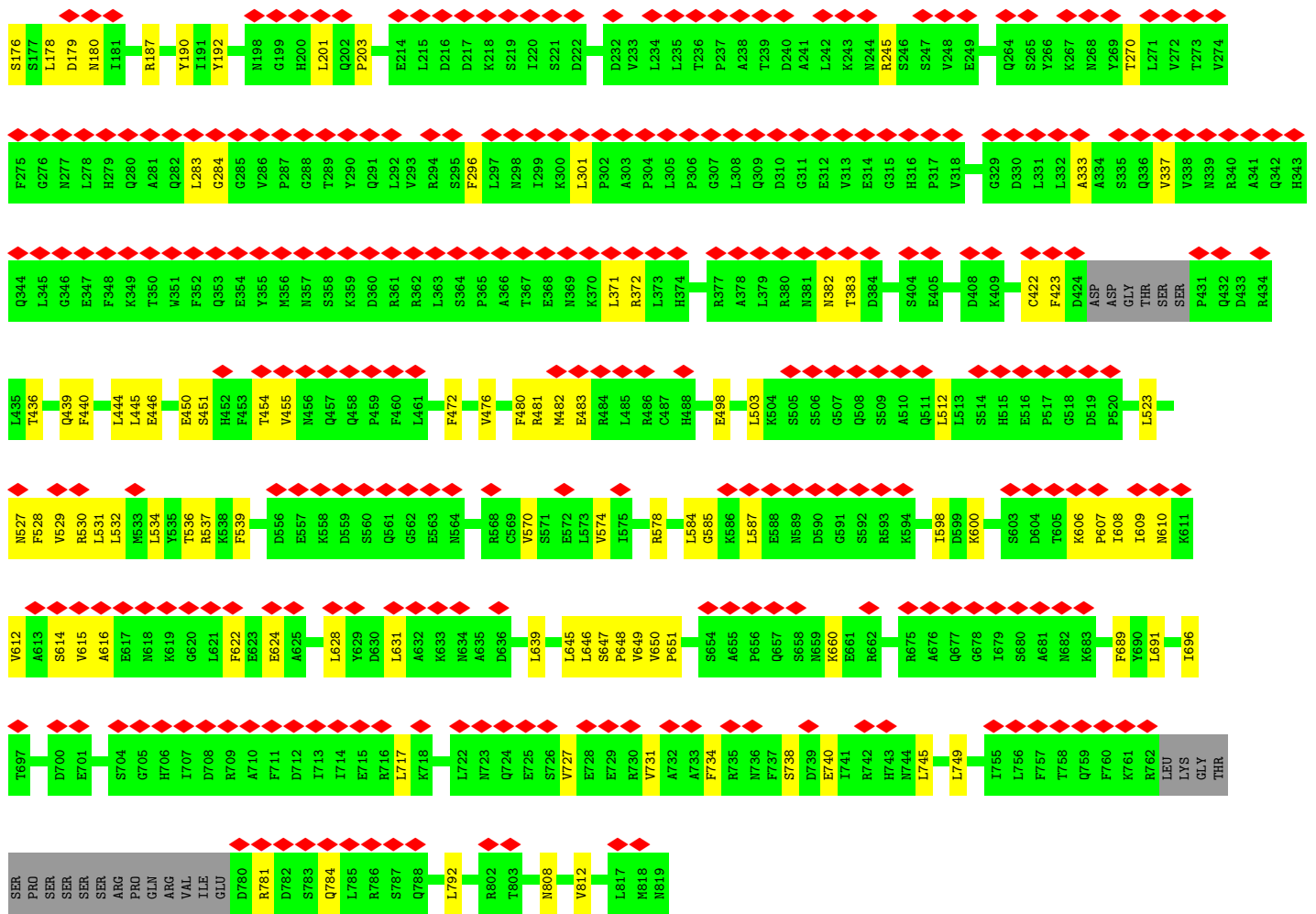

• Molecule 7: NUP53 R2

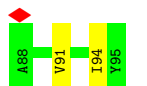
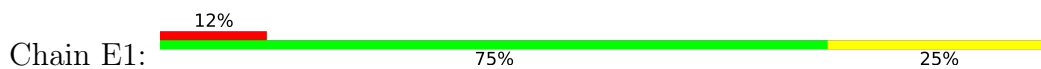

• Molecule 7: NUP53 R2

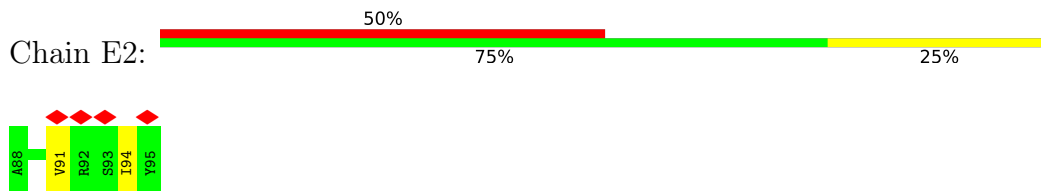

• Molecule 7: NUP53 R2

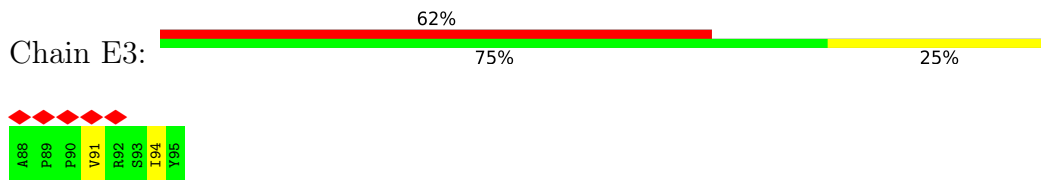

• Molecule 7: NUP53 R2

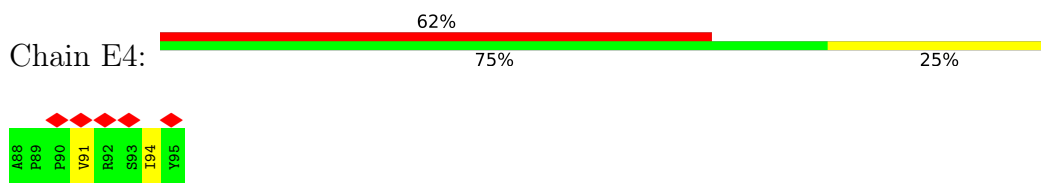

• Molecule 7: NUP53 R2

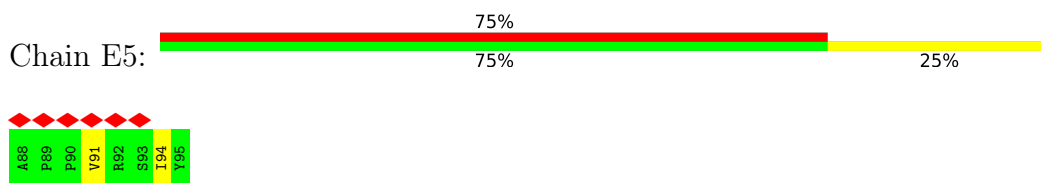

• Molecule 7: NUP53 R2

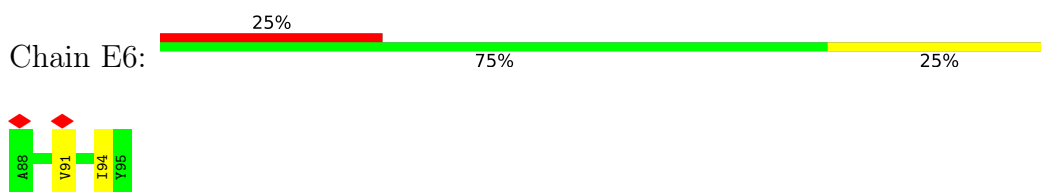

• Molecule 7: NUP53 R2

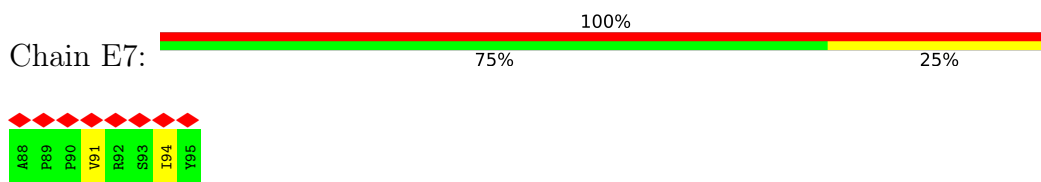

• Molecule 8: NUP188

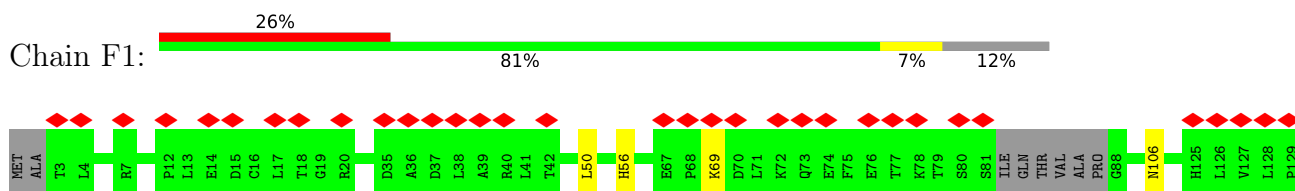

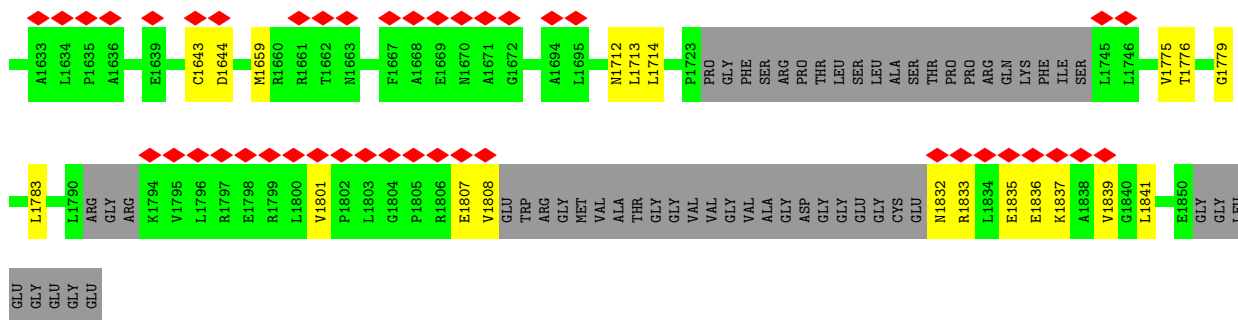

● Molecule 8: NUP188

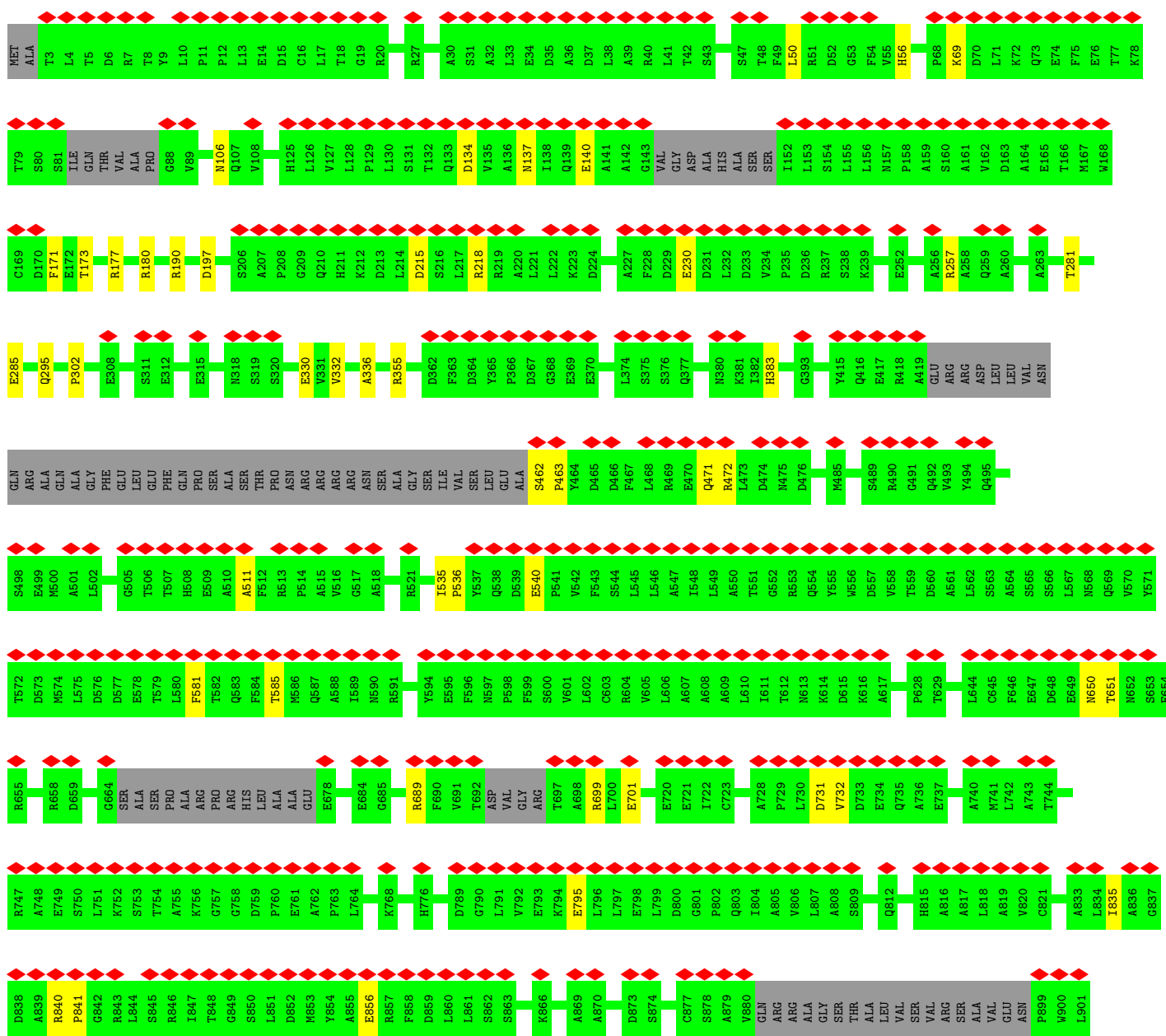
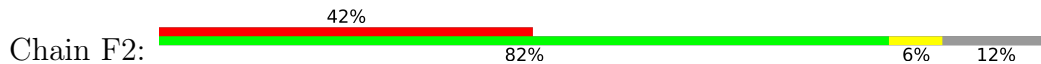

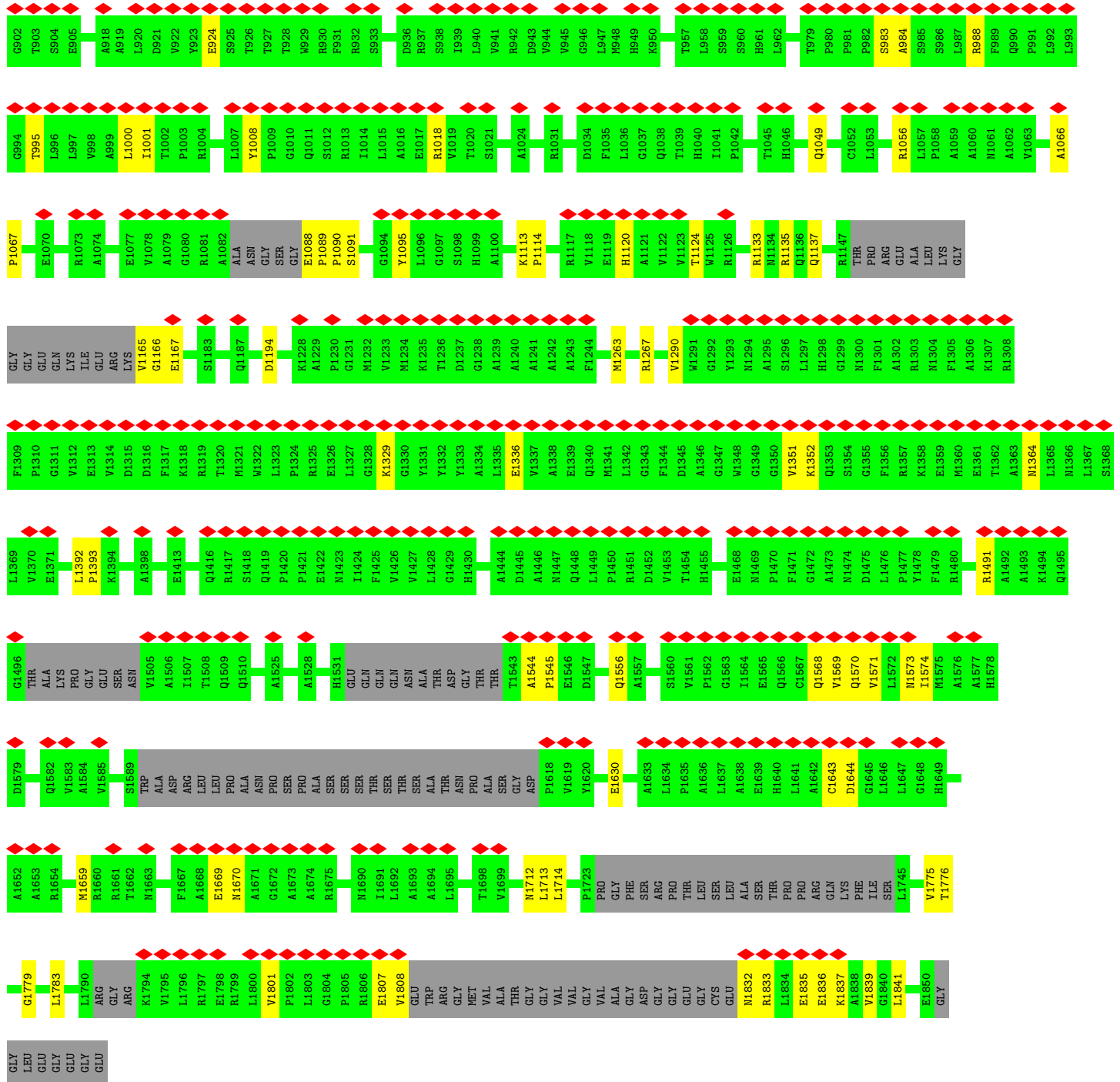

• Molecule 9: NUP93 R2

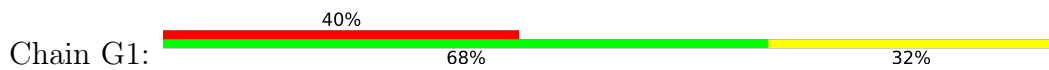

Chain G1:



• Molecule 9: NUP93 R2

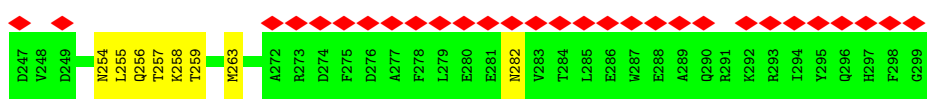
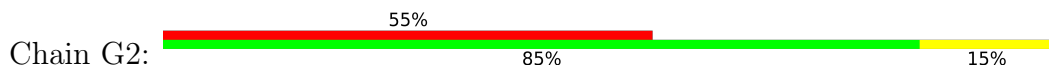

• Molecule 10: NUP98 R2

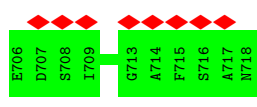

• Molecule 10: NUP98 R2

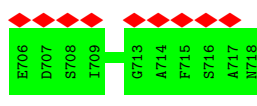
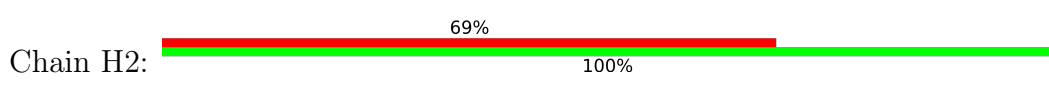

• Molecule 11: NUP205

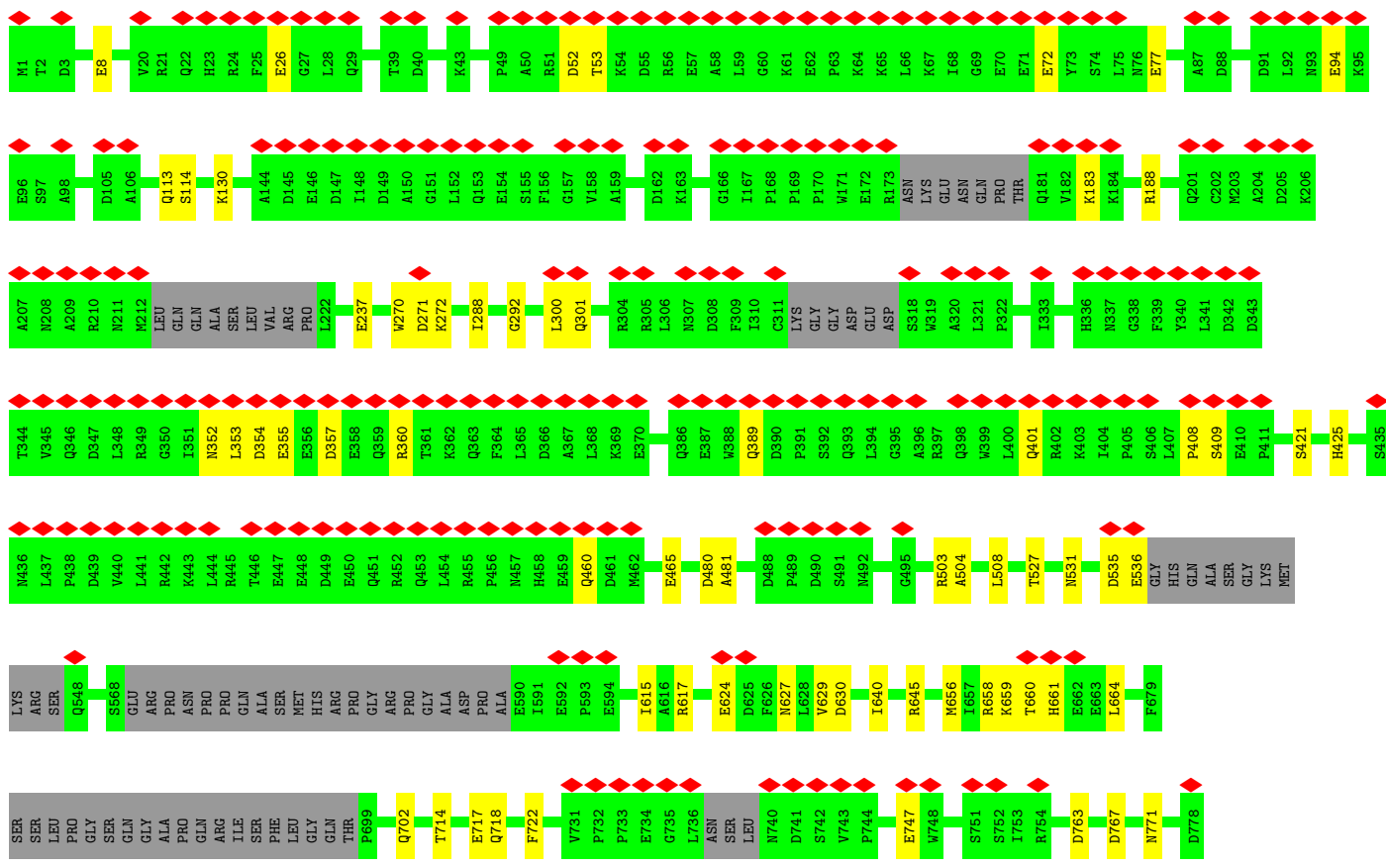

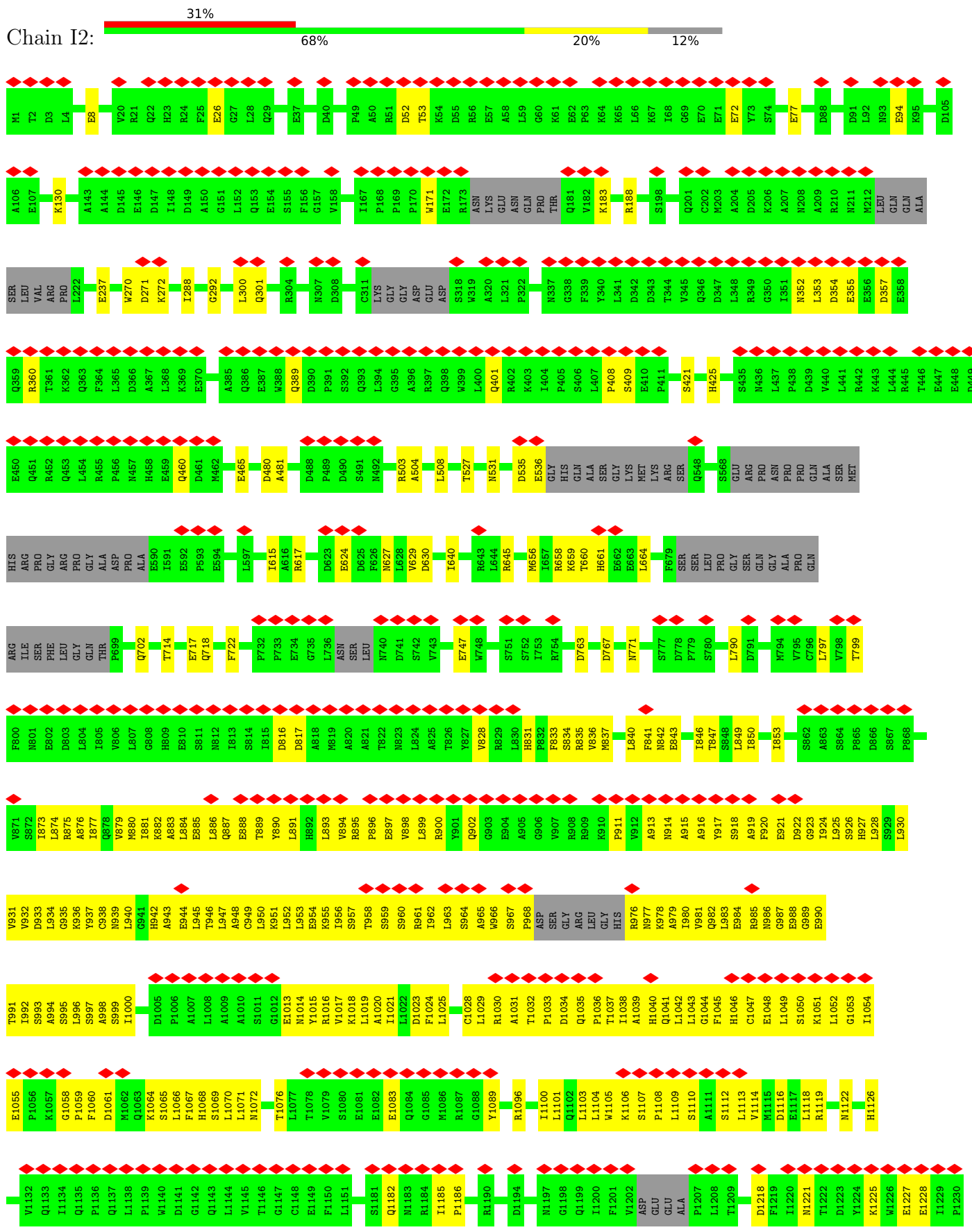

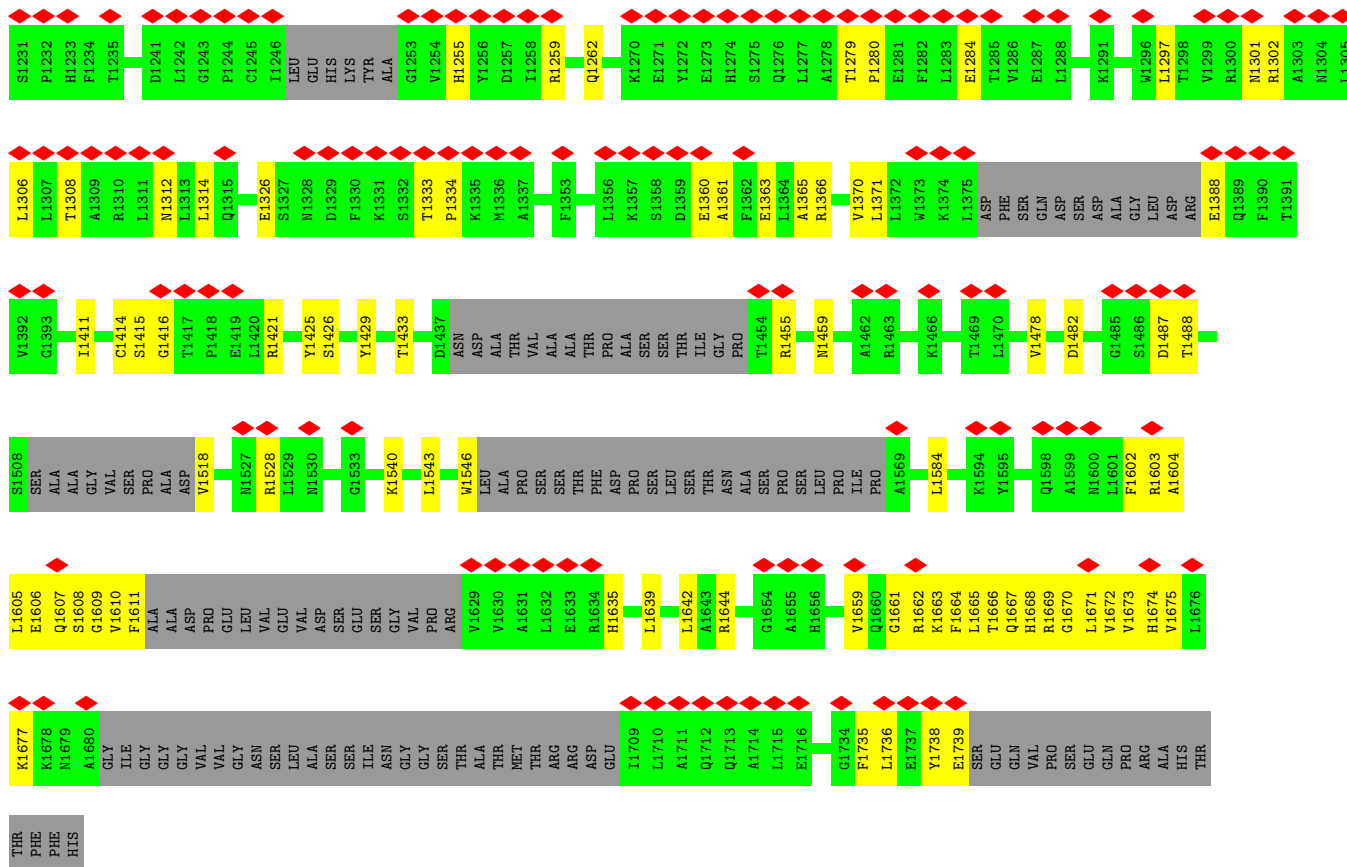

• Molecule 11: NUP205

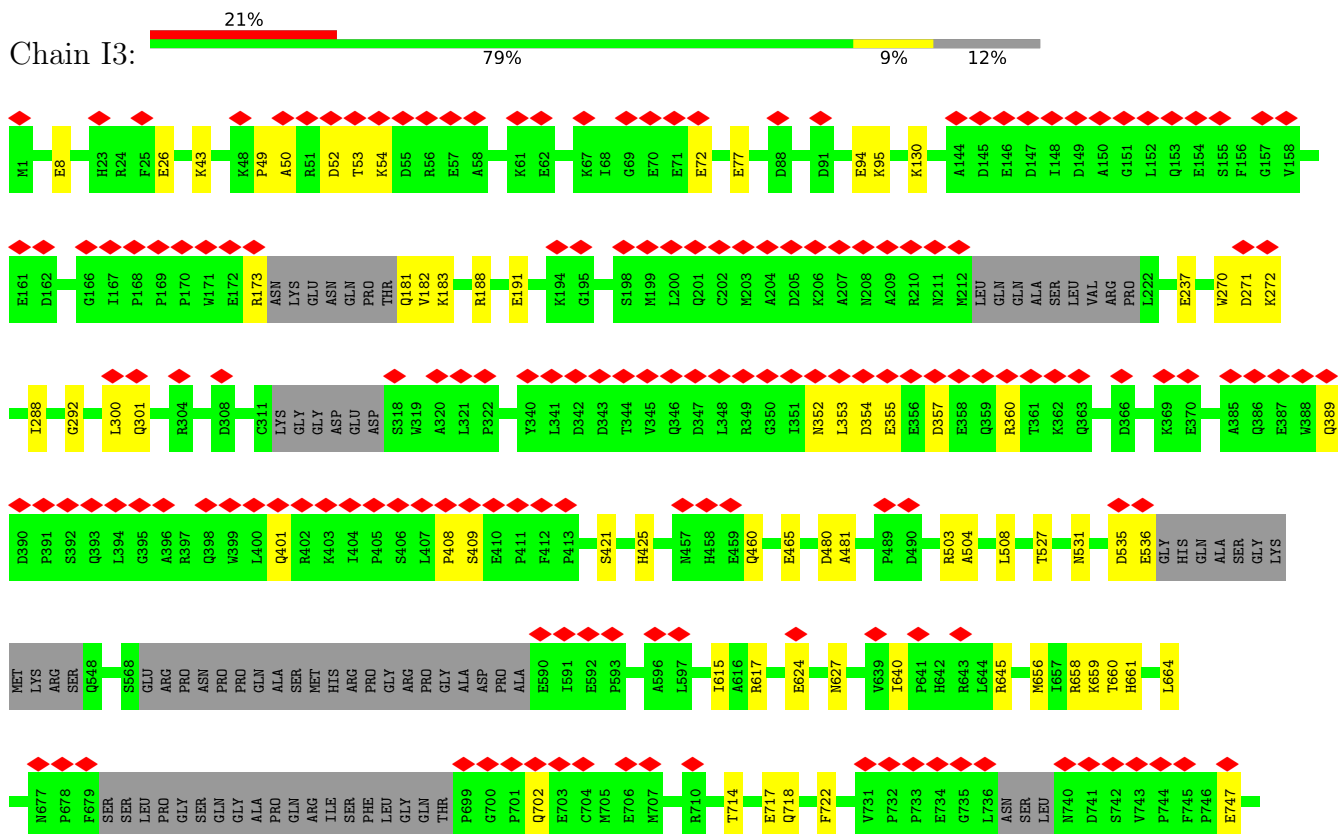

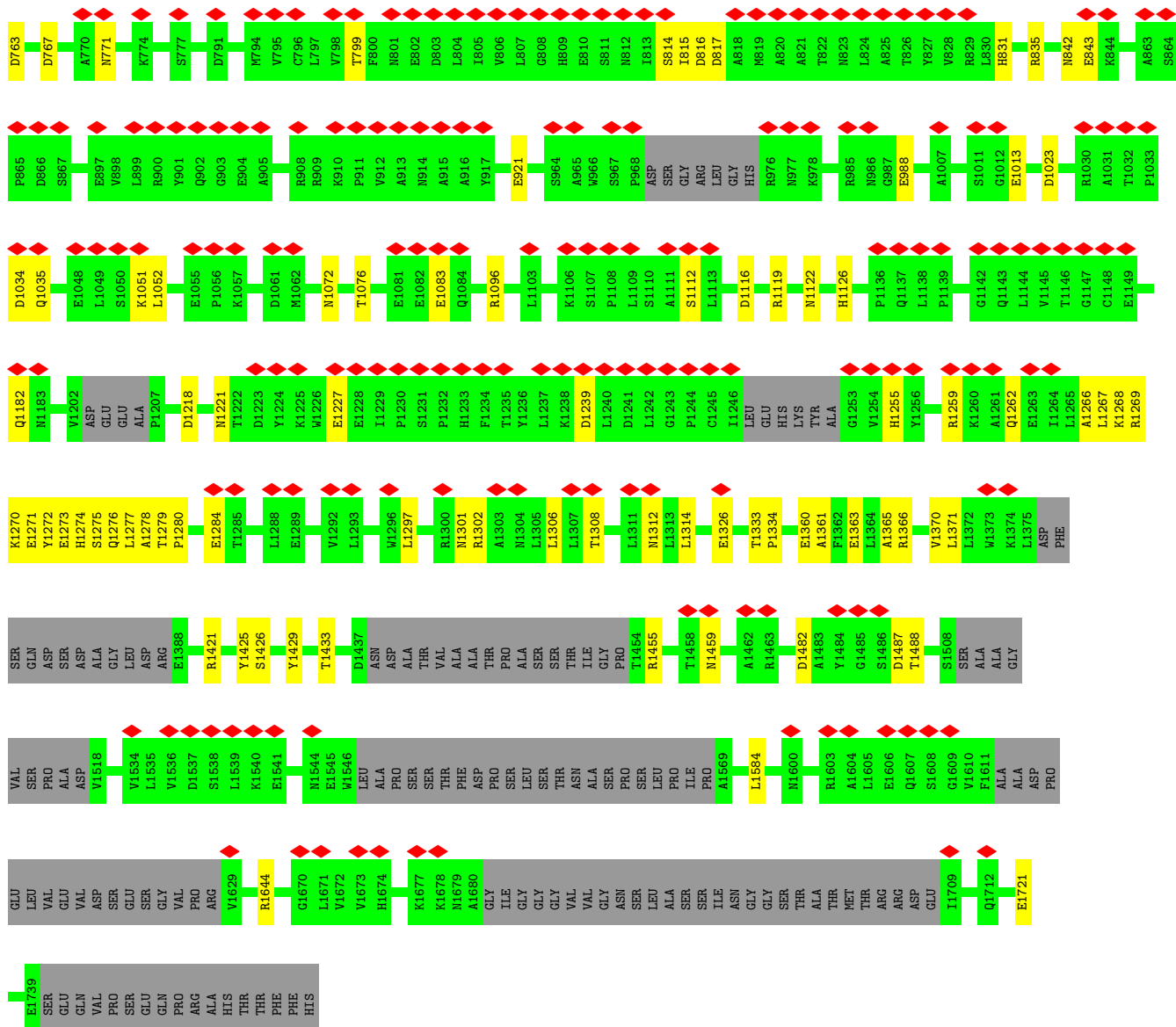

• Molecule 11: NUP205

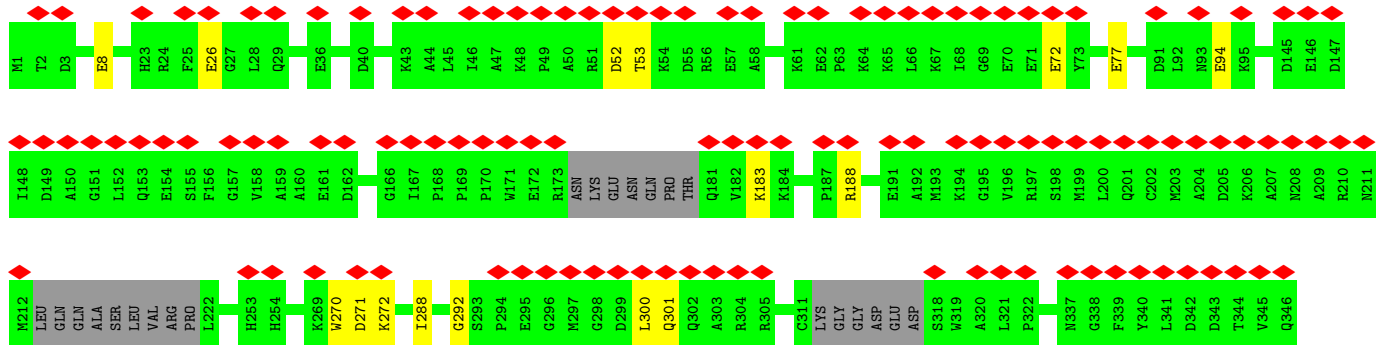
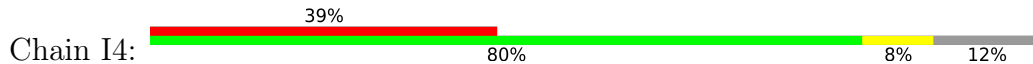

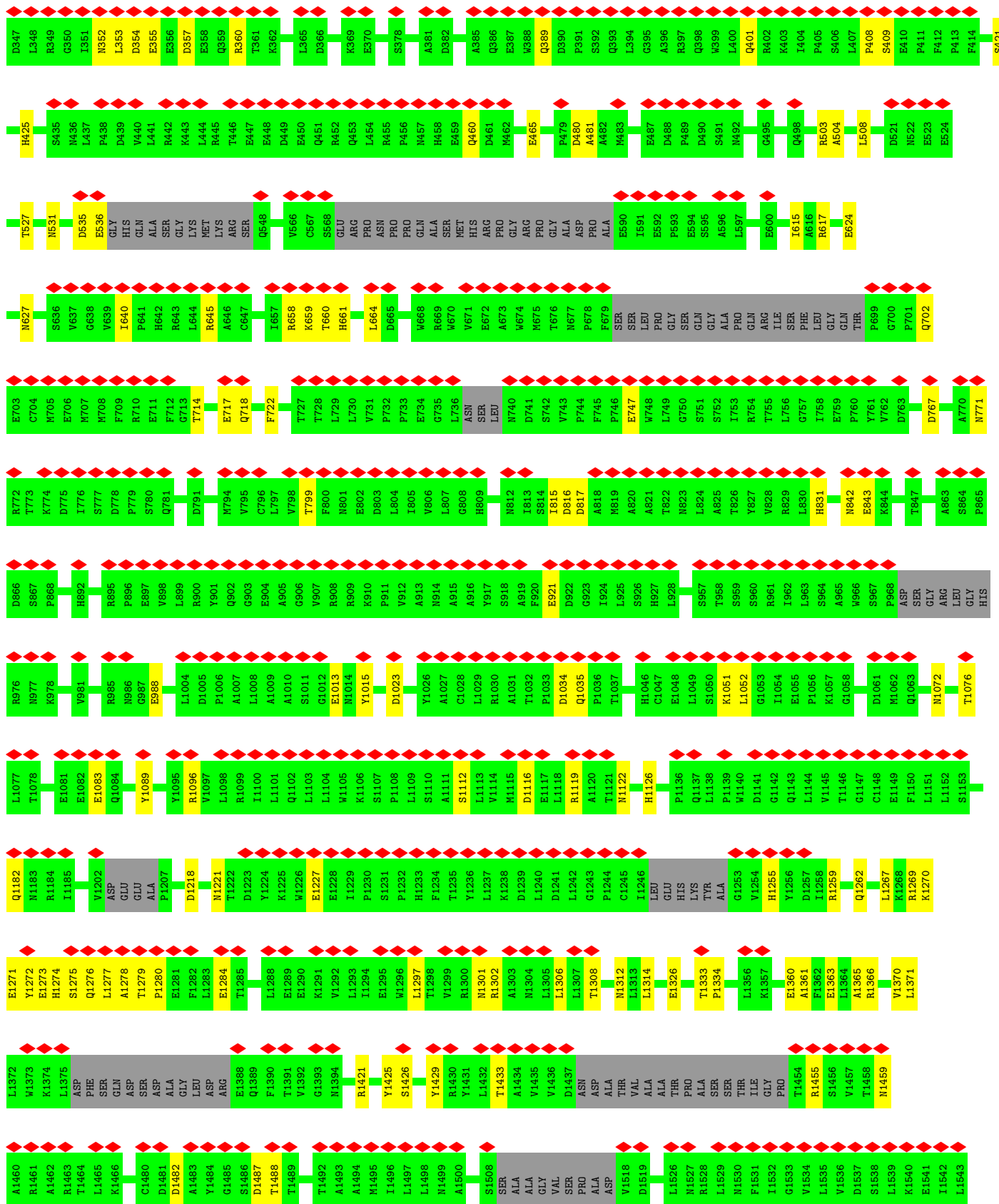

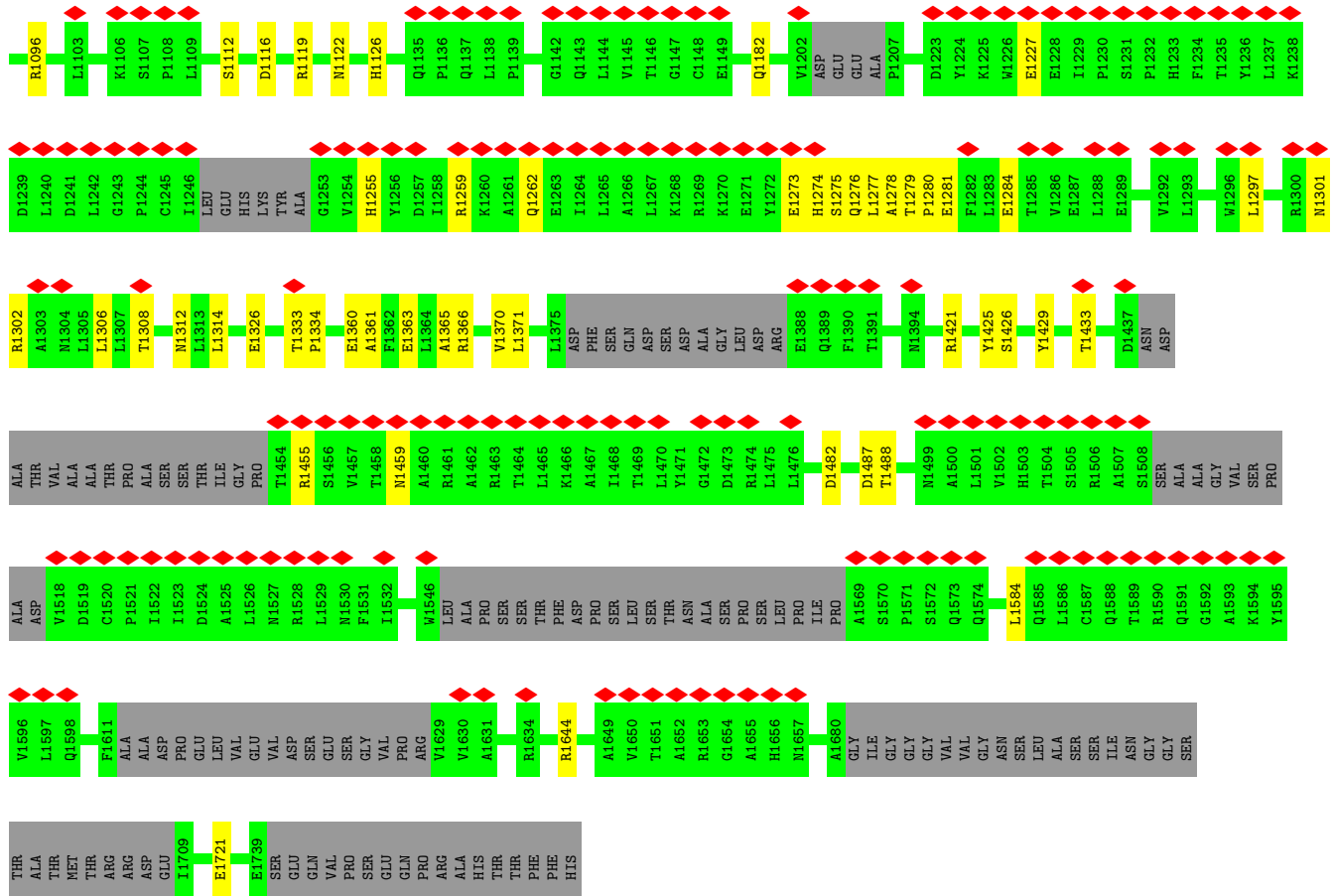

• Molecule 12: NUP93 R2

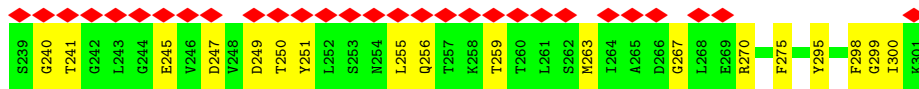
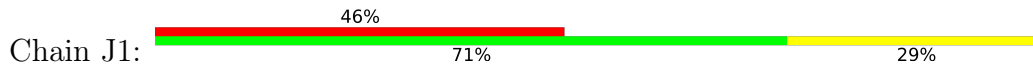

• Molecule 12: NUP93 R2

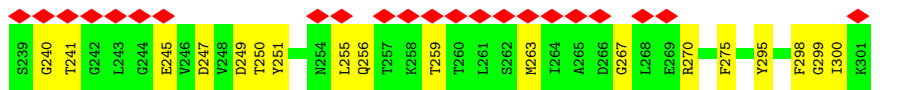
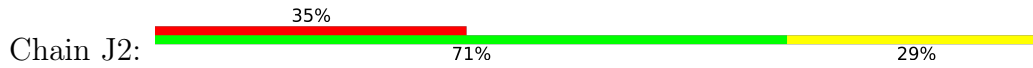

• Molecule 12: NUP93 R2

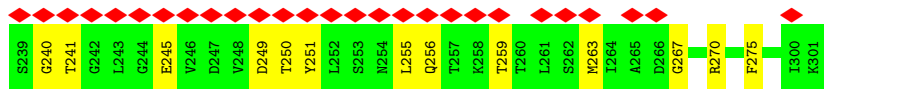
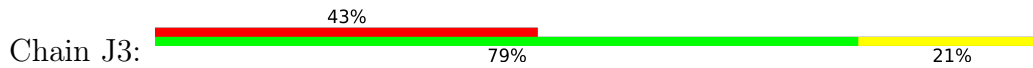

• Molecule 12: NUP93 R2

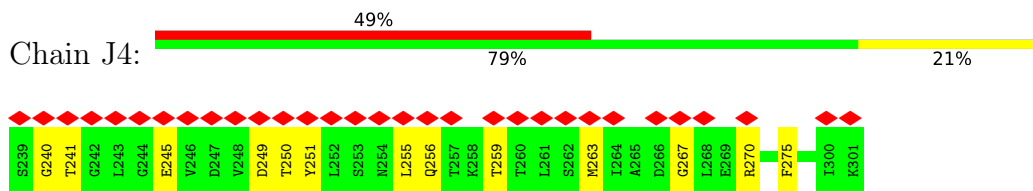

• Molecule 12: NUP93 R2

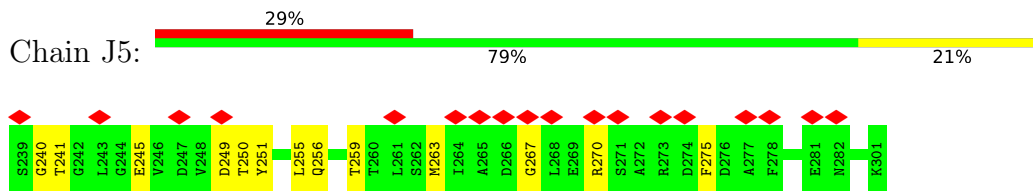

• Molecule 13: NUP98 R1

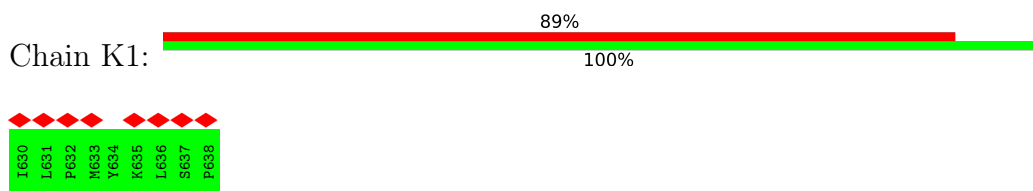

• Molecule 13: NUP98 R1

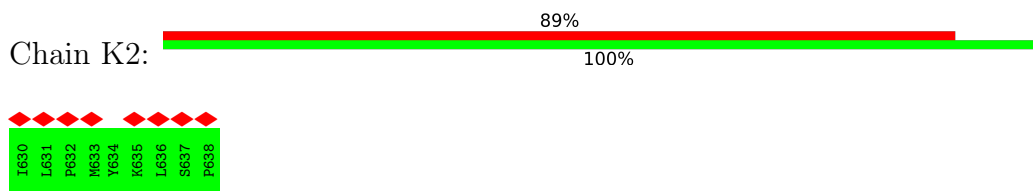

• Molecule 13: NUP98 R1

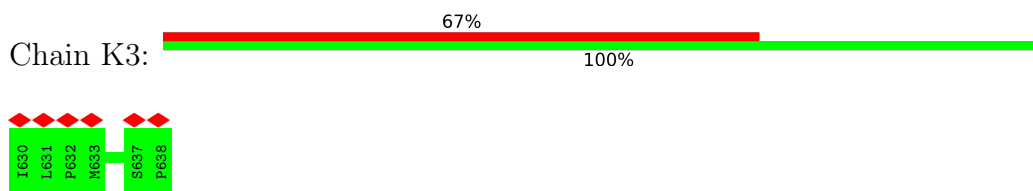

• Molecule 13: NUP98 R1

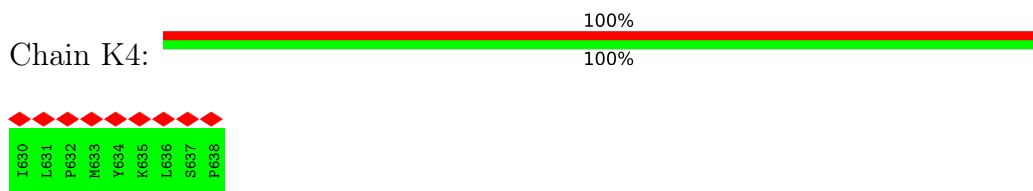

• Molecule 13: NUP98 R1

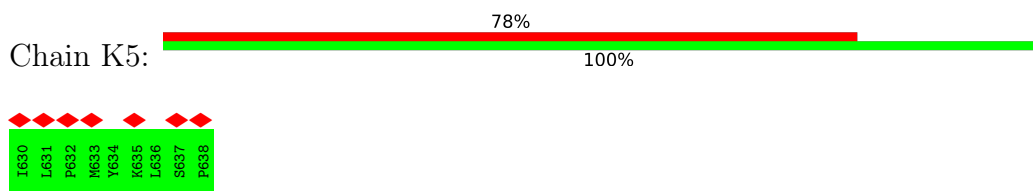

• Molecule 14: NUP53 R1

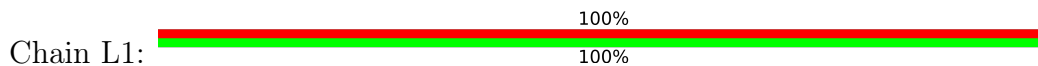

• Molecule 14: NUP53 R1



• Molecule 14: NUP53 R1



• Molecule 14: NUP53 R1



• Molecule 14: NUP53 R1



• Molecule 15: NUP62

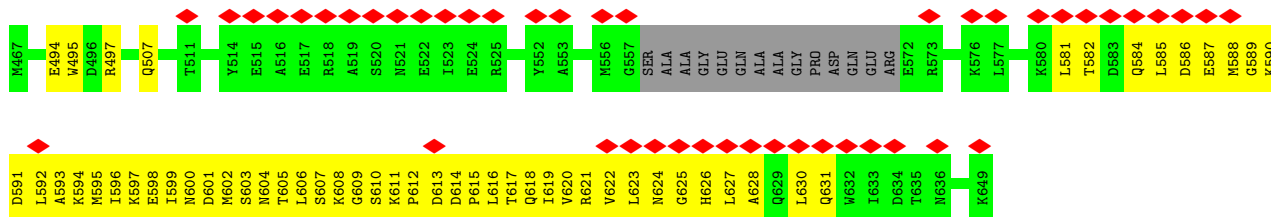

• Molecule 15: NUP62

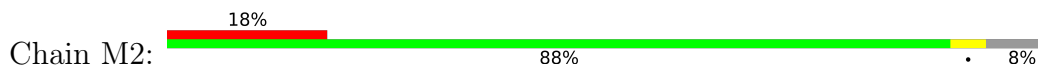

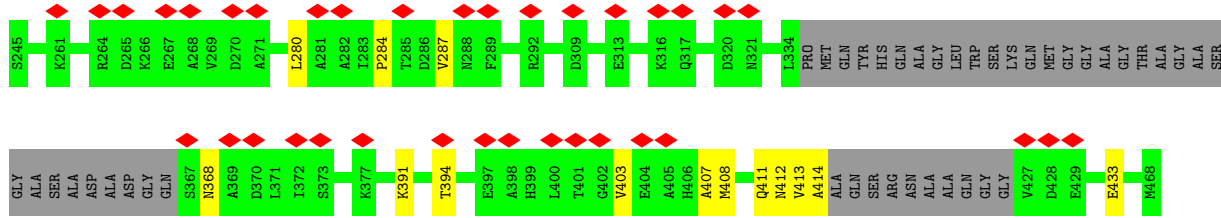

• Molecule 16: NUP58

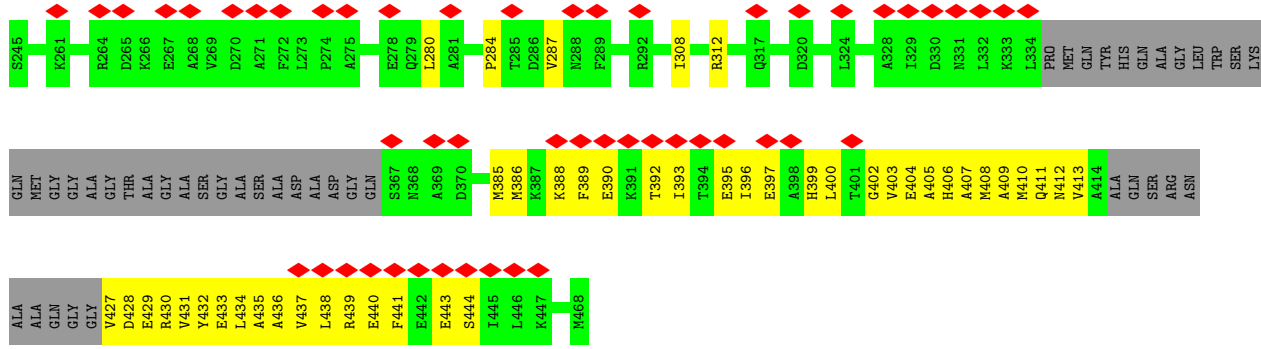

• Molecule 16: NUP58

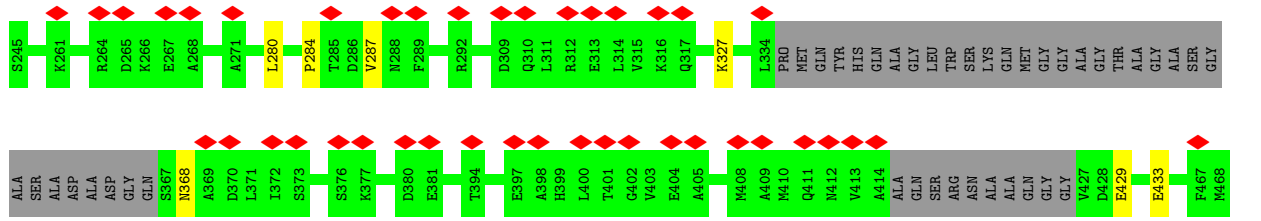
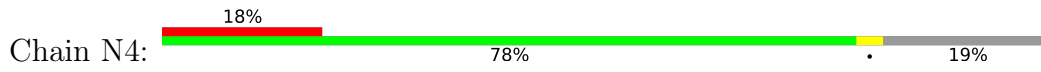

• Molecule 17: NUP54

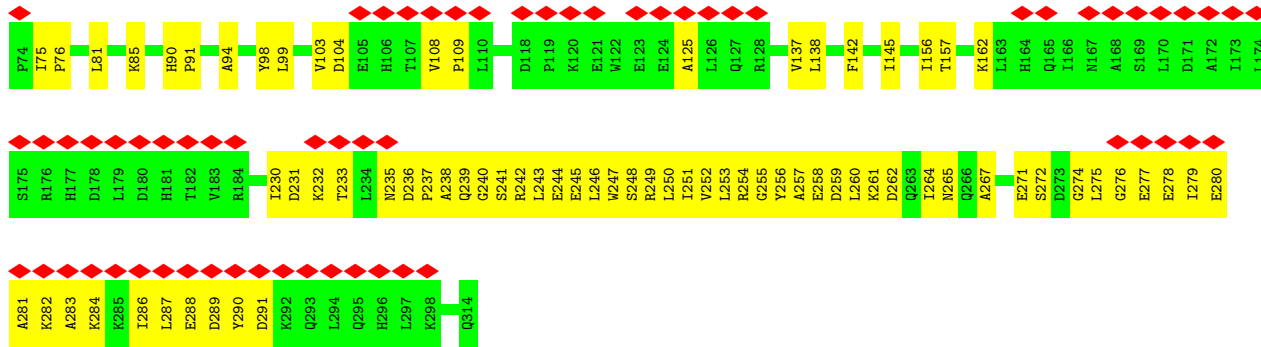

• Molecule 17: NUP54

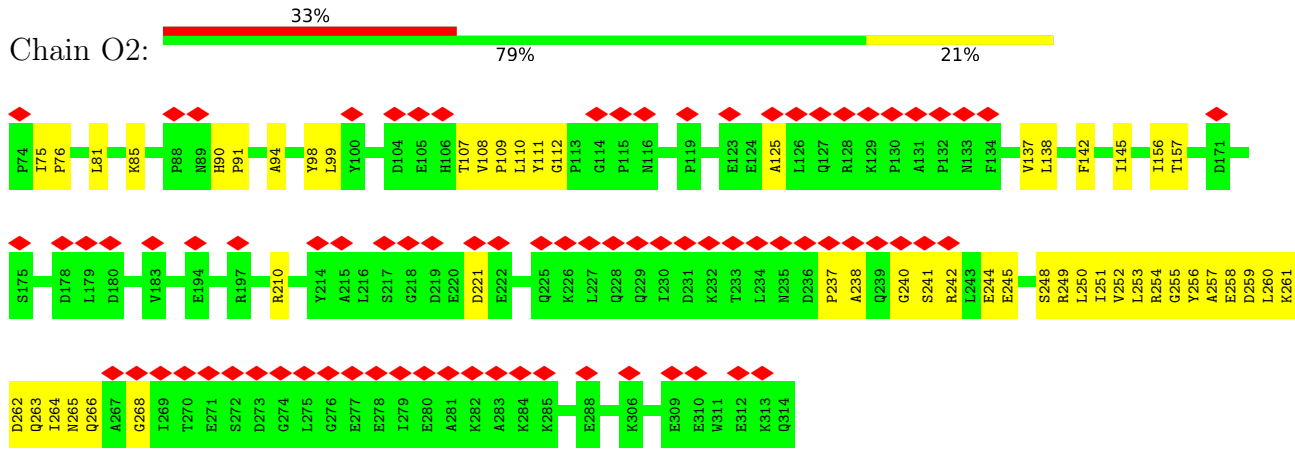

• Molecule 17: NUP54



• Molecule 17: NUP54

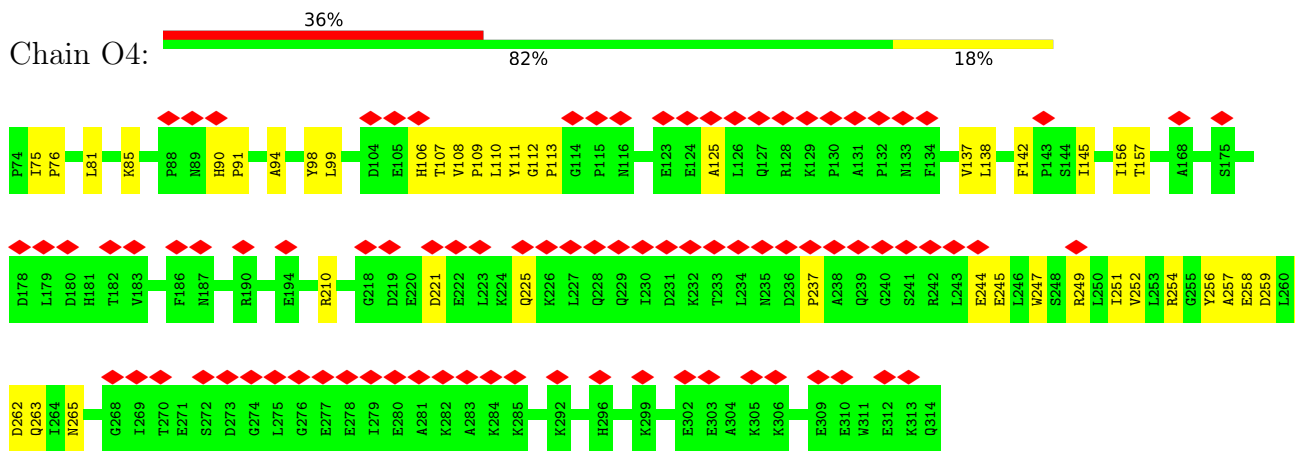

• Molecule 18: NUP54 Ferredoxin-like domain

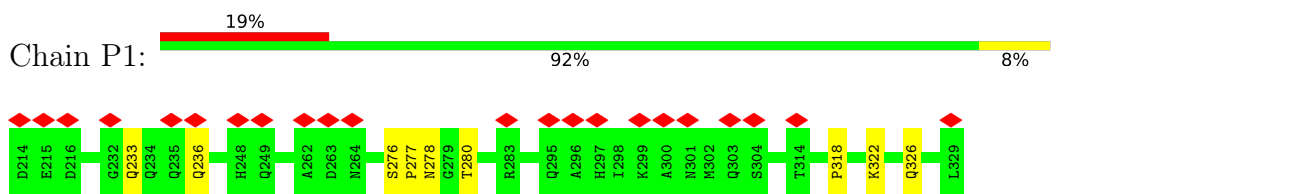

- Molecule 18: NUP54 Ferredoxin-like domain

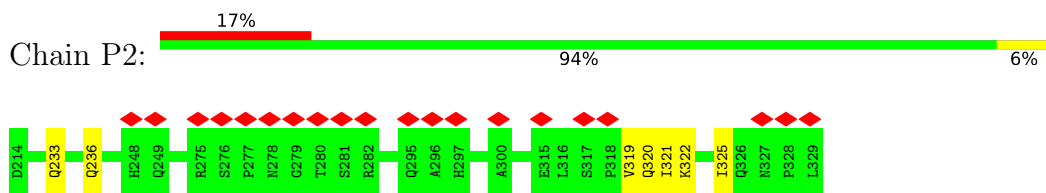

- Molecule 18: NUP54 Ferredoxin-like domain

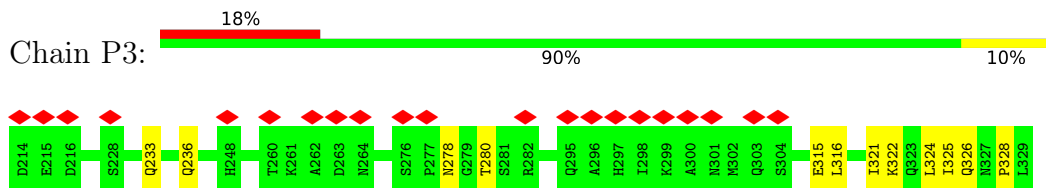

- Molecule 18: NUP54 Ferredoxin-like domain

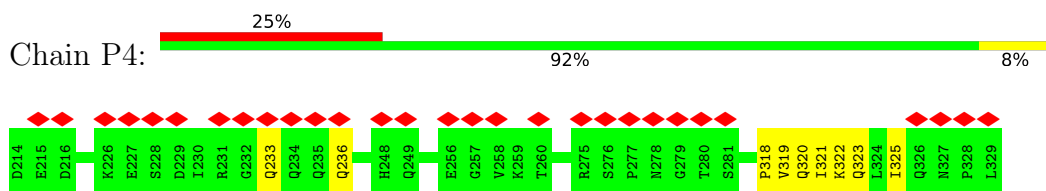

- Molecule 19: NUP53 RRM

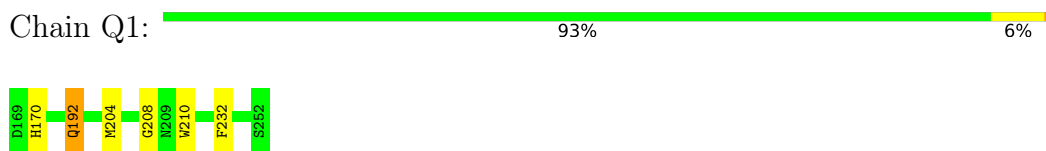

- Molecule 19: NUP53 RRM

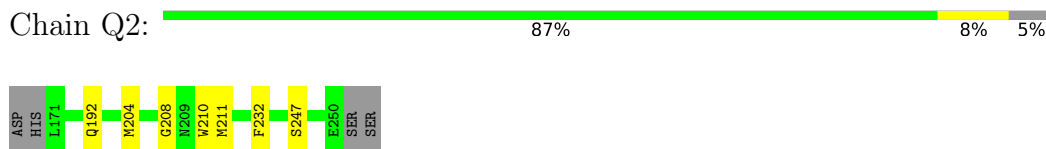

- Molecule 19: NUP53 RRM

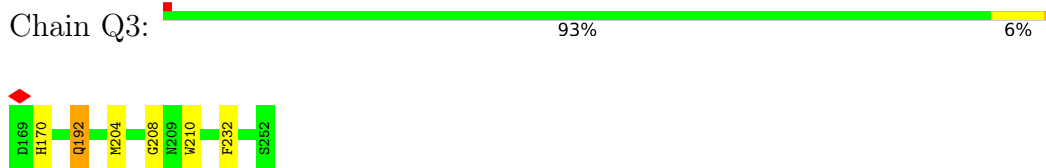

- Molecule 19: NUP53 RRM

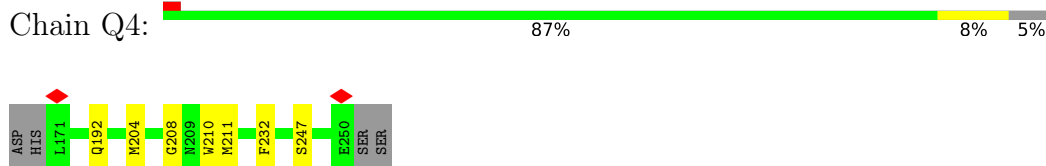

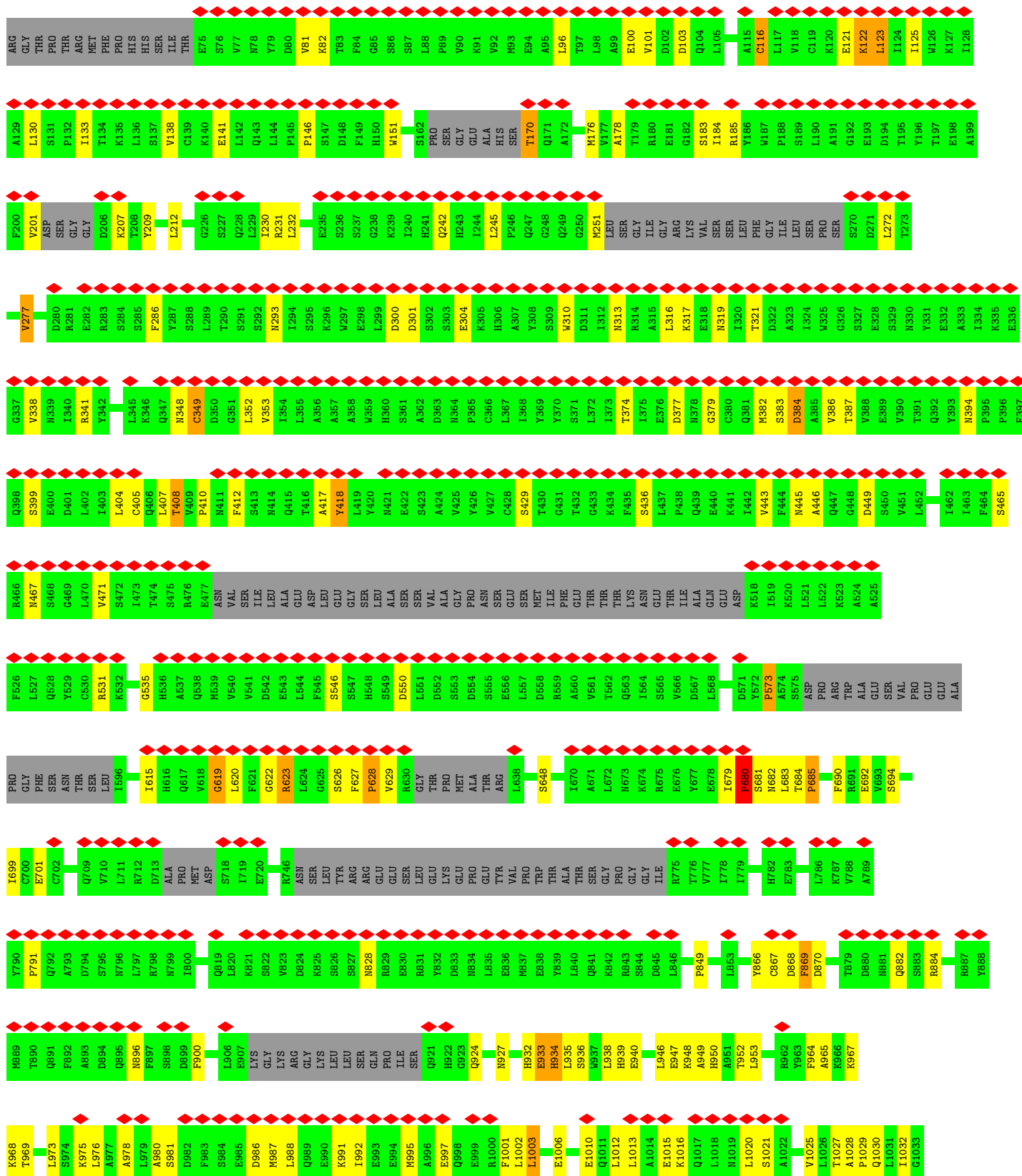

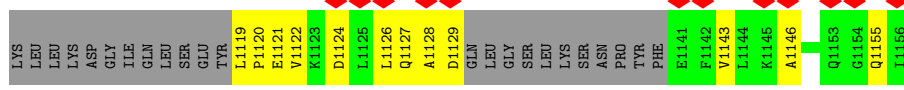
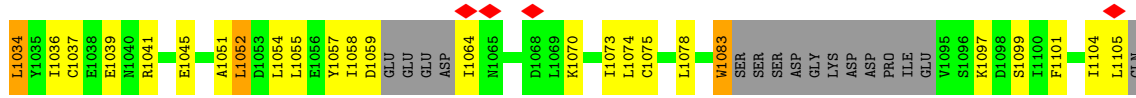

• Molecule 21: NUP133

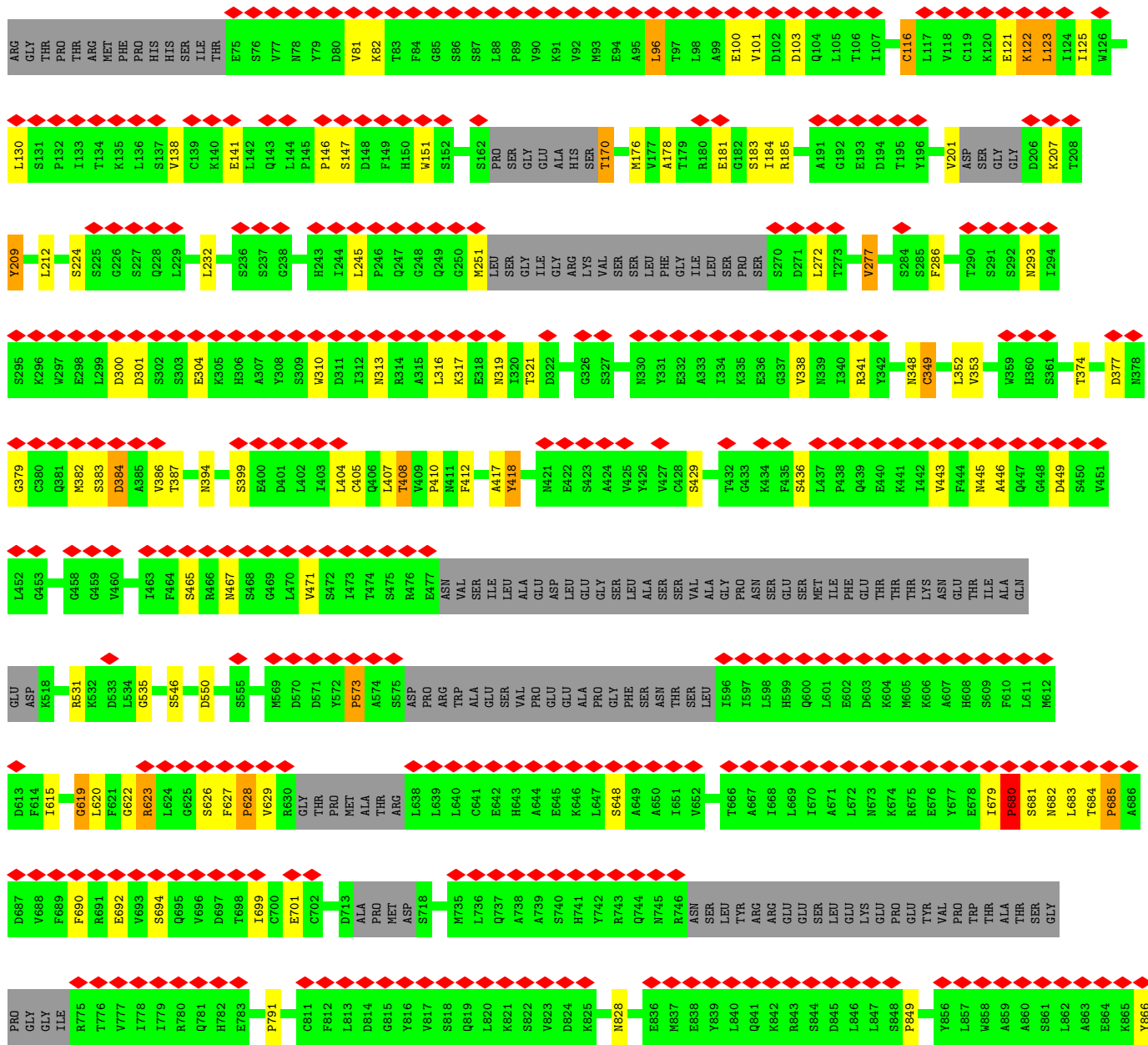

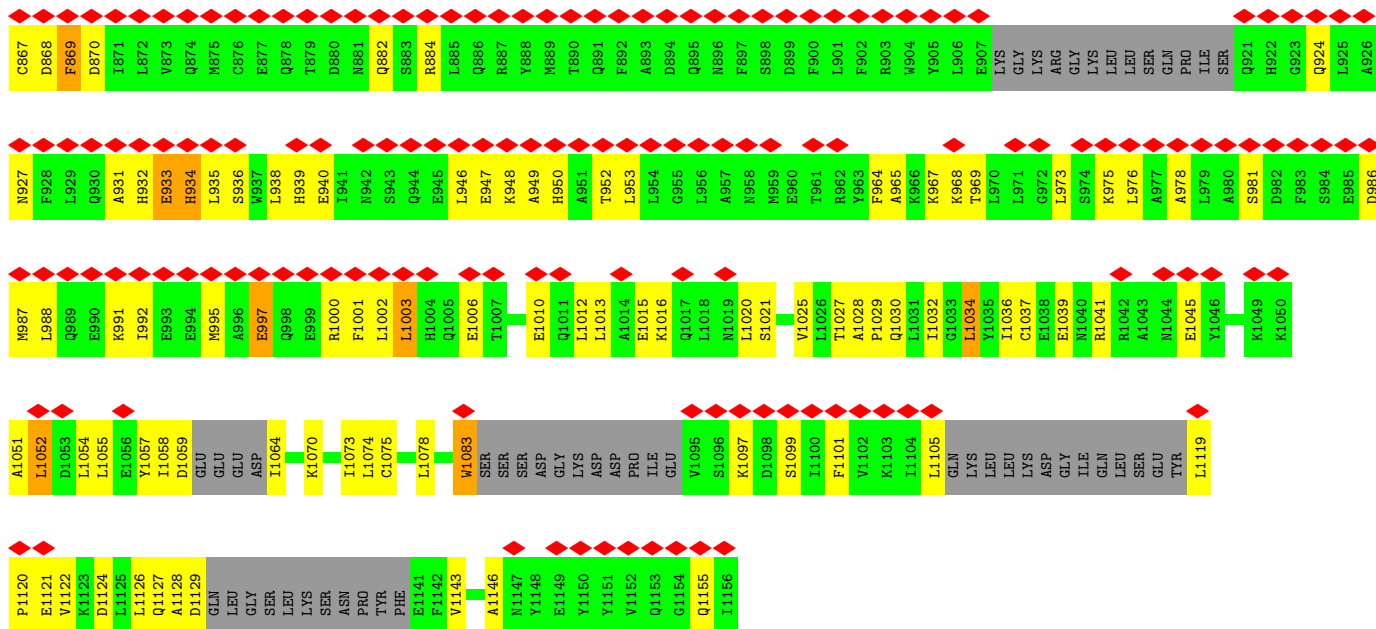

• Molecule 22: NUP107 CTD

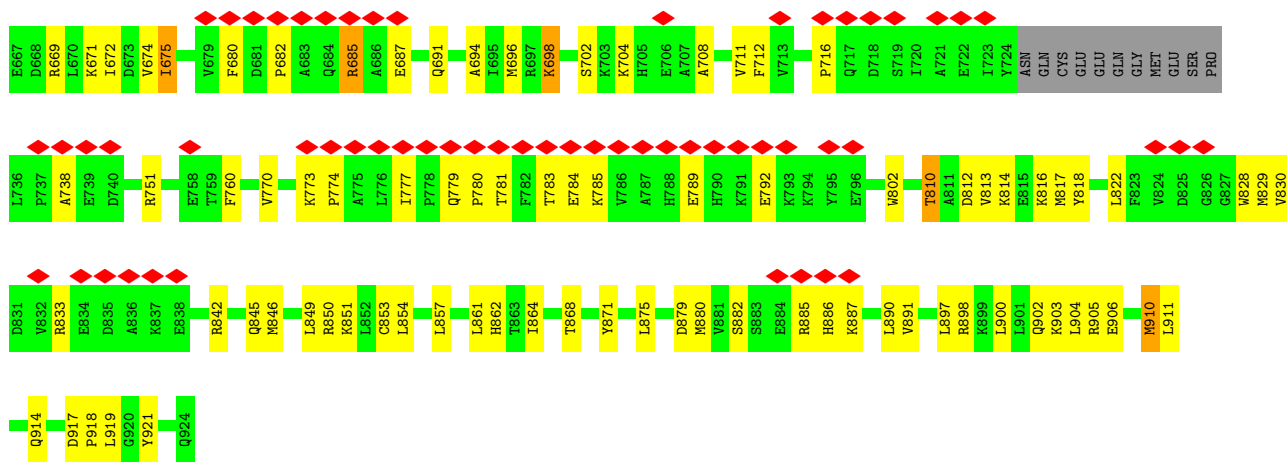

• Molecule 22: NUP107 CTD

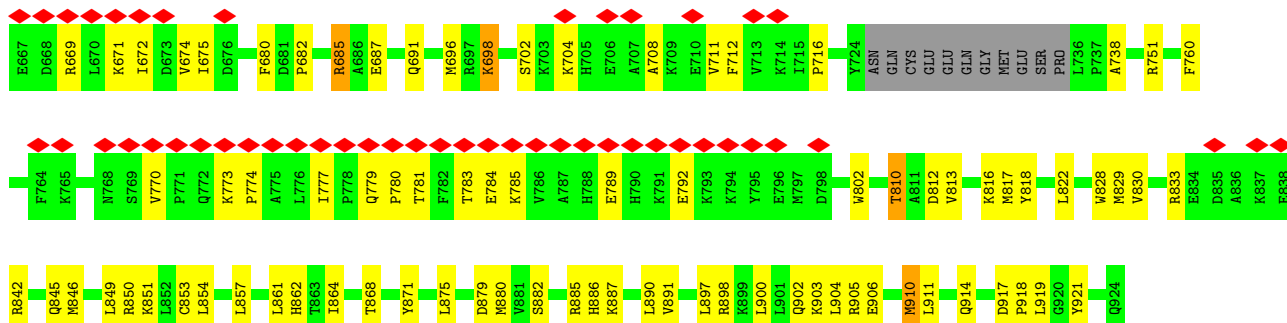

• Molecule 22: NUP107 CTD

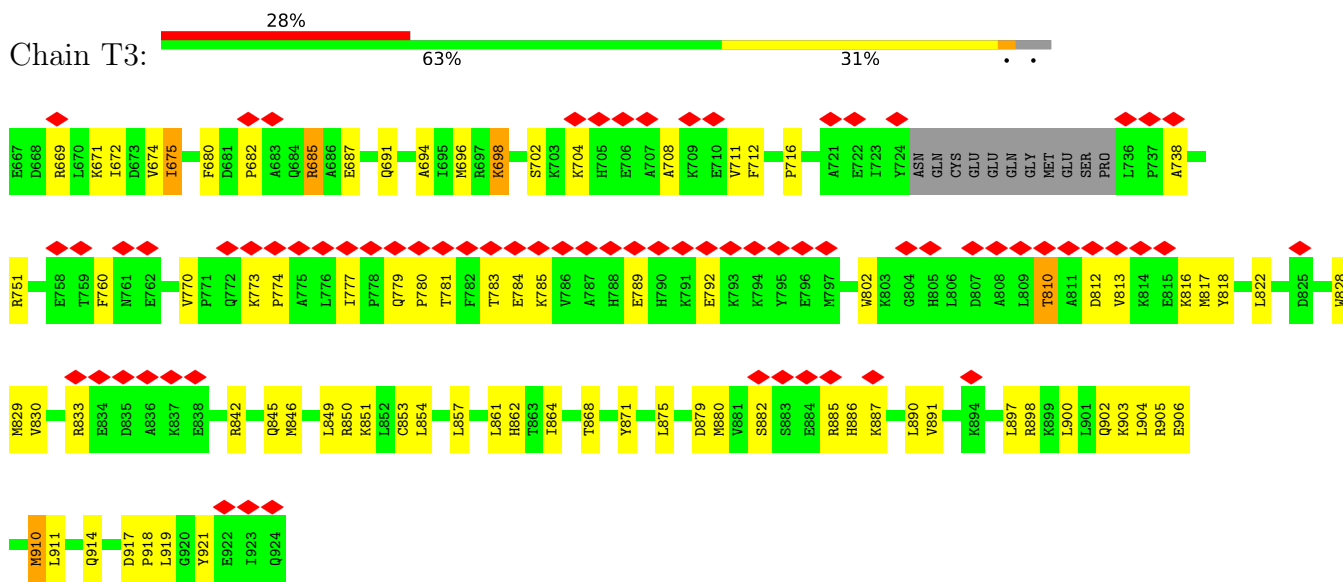

• Molecule 22: NUP107 CTD

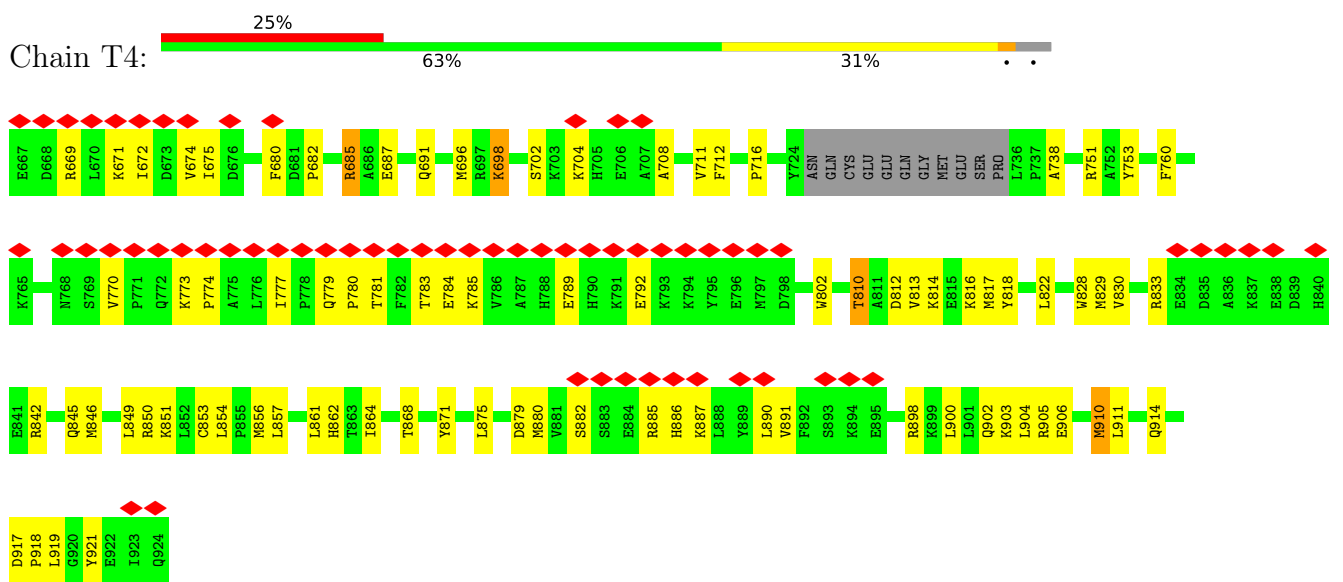

• Molecule 23: NUP107 NTD

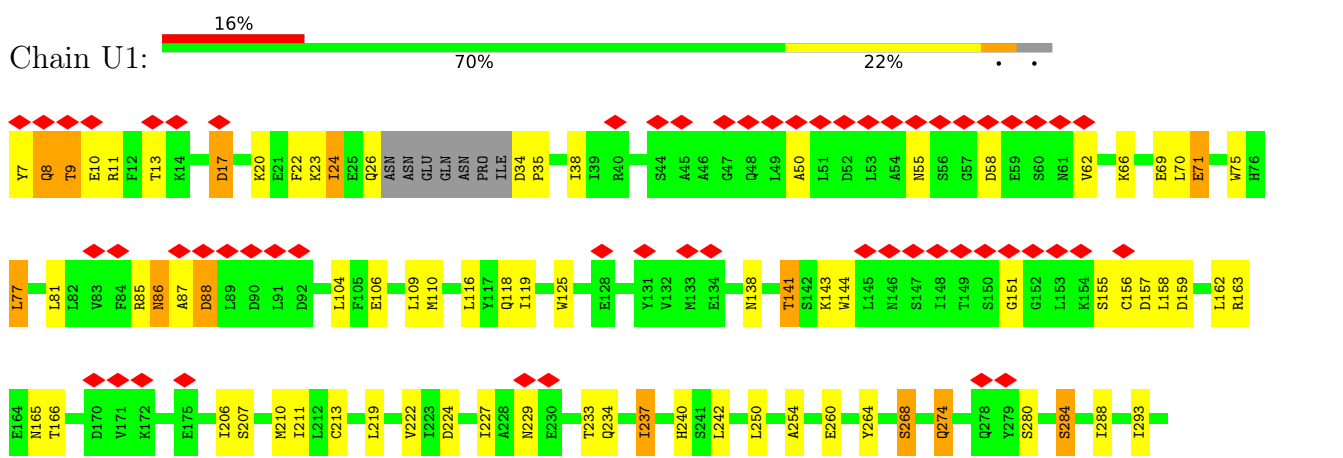

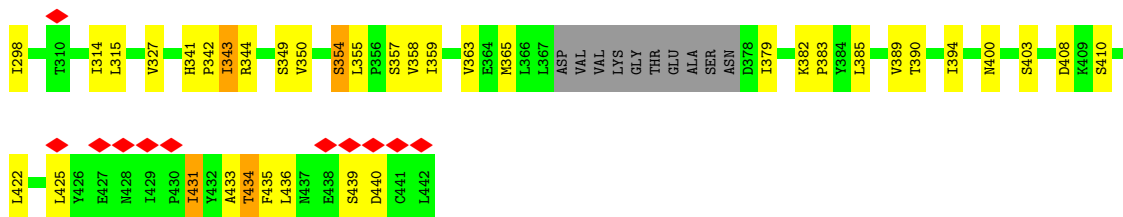

• Molecule 23: NUP107 NTD

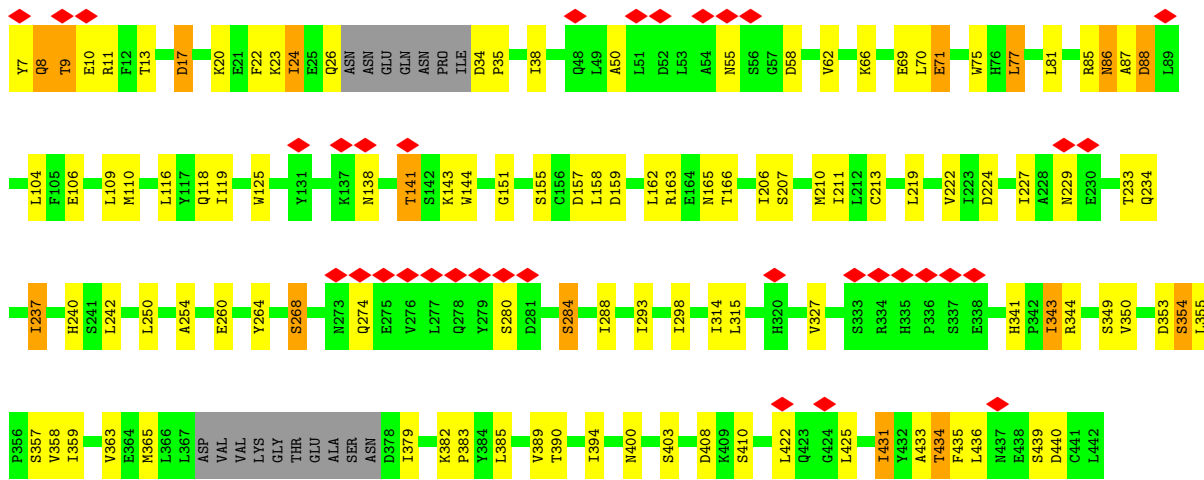
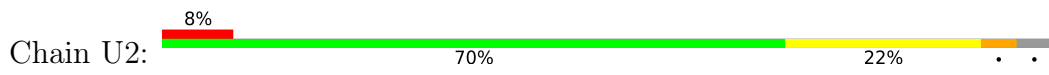

• Molecule 23: NUP107 NTD

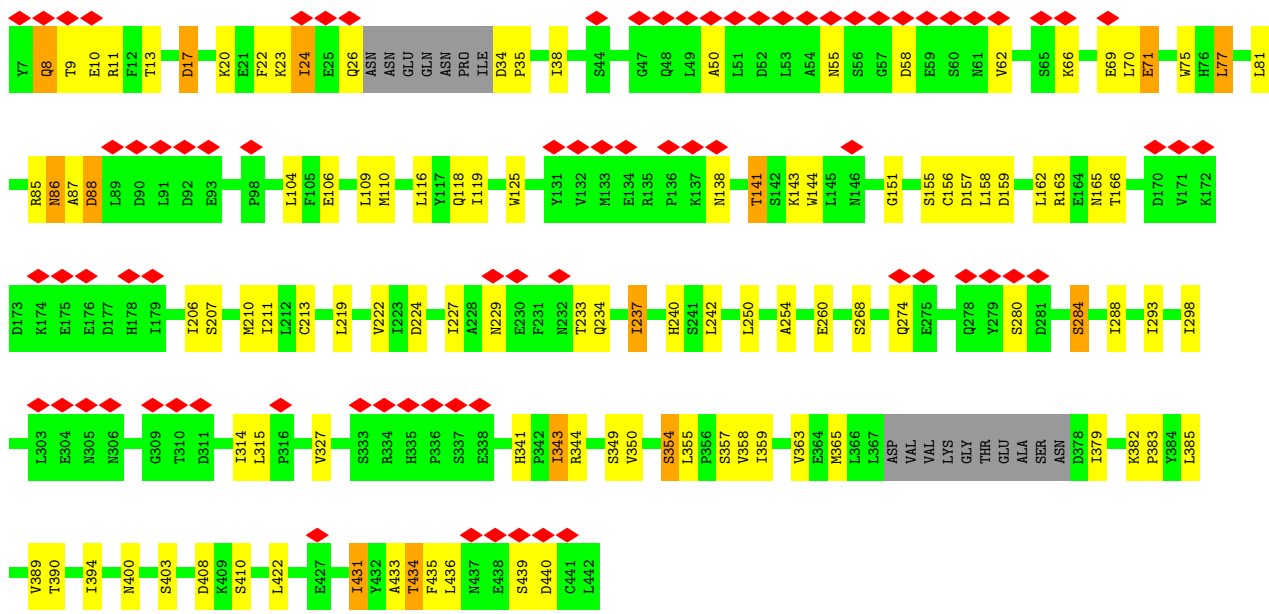
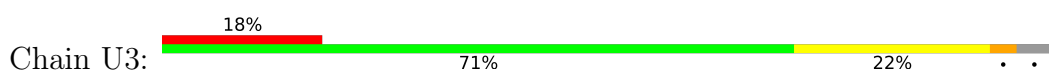

• Molecule 23: NUP107 NTD

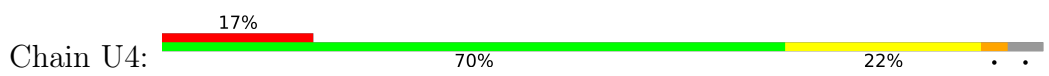

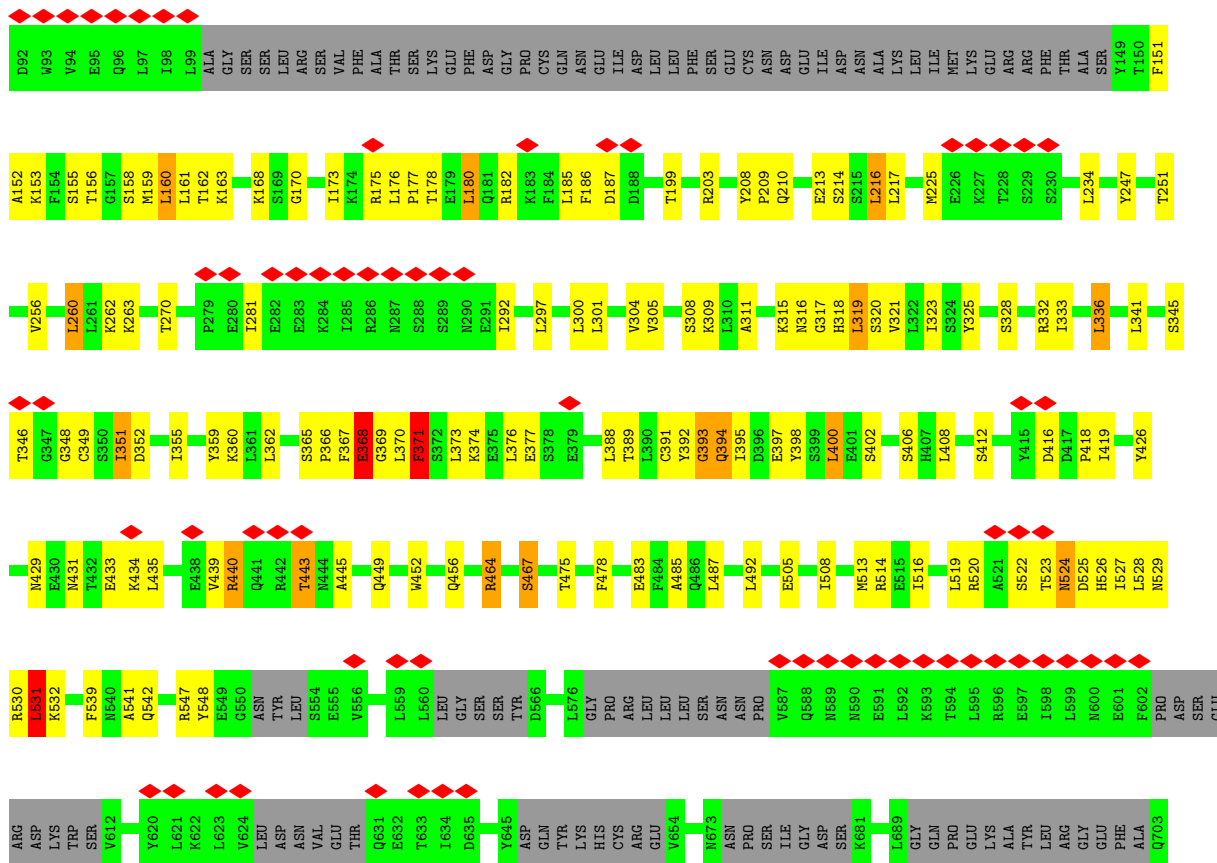

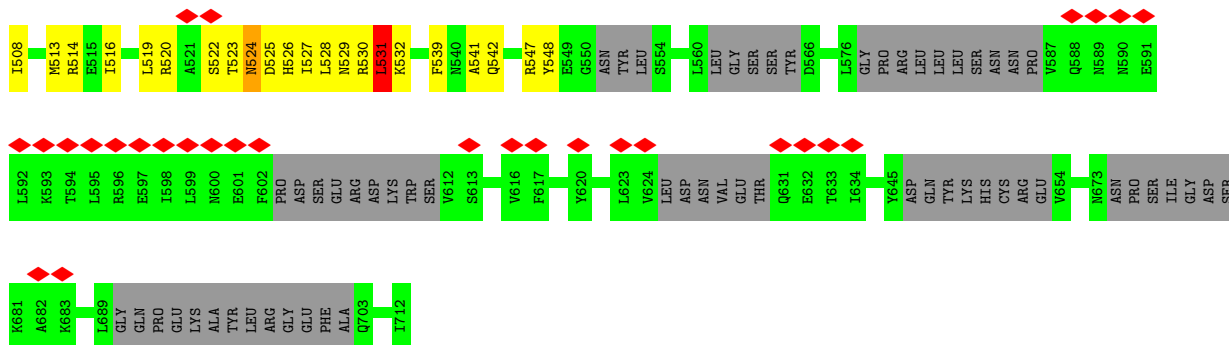

• Molecule 24: NUP96

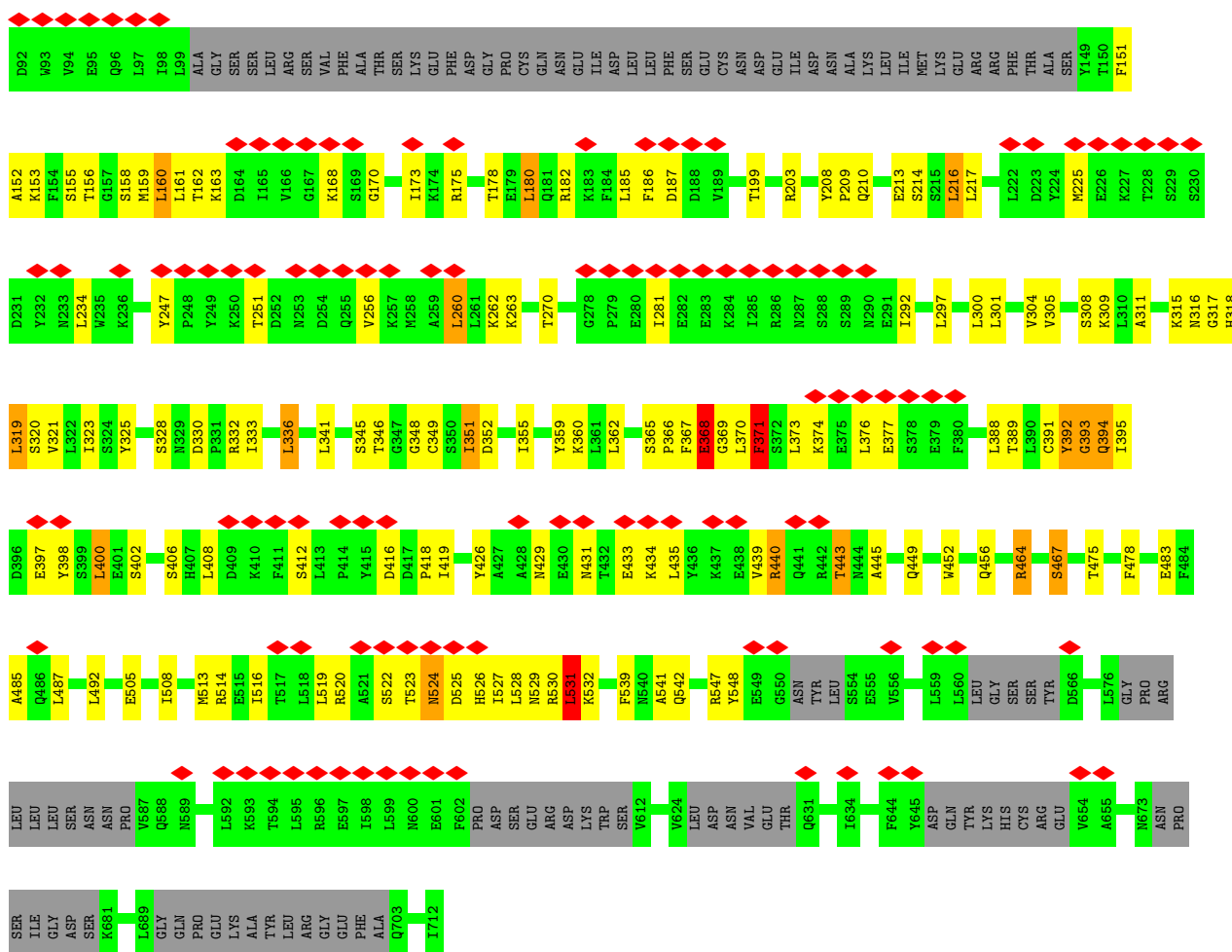

• Molecule 25: SEC13



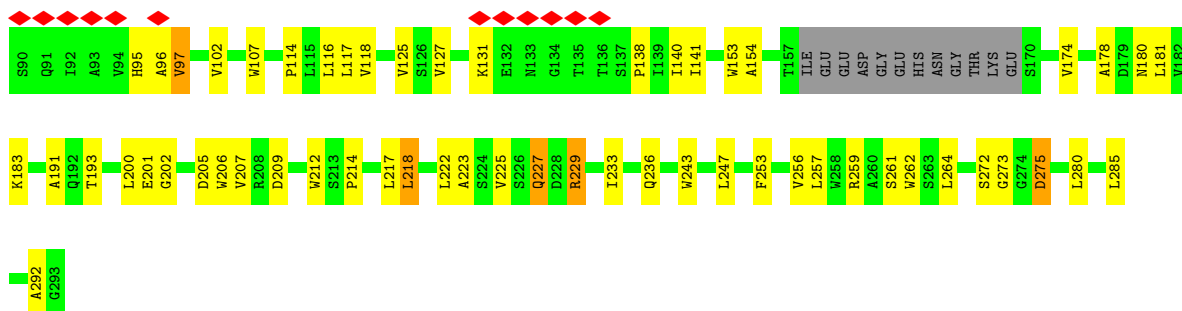

• Molecule 25: SEC13

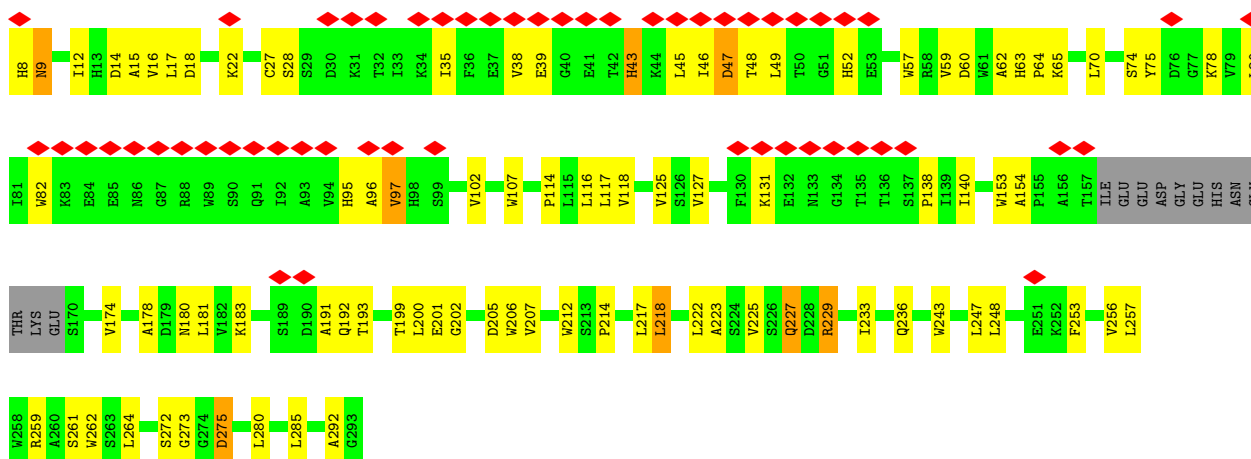

• Molecule 25: SEC13

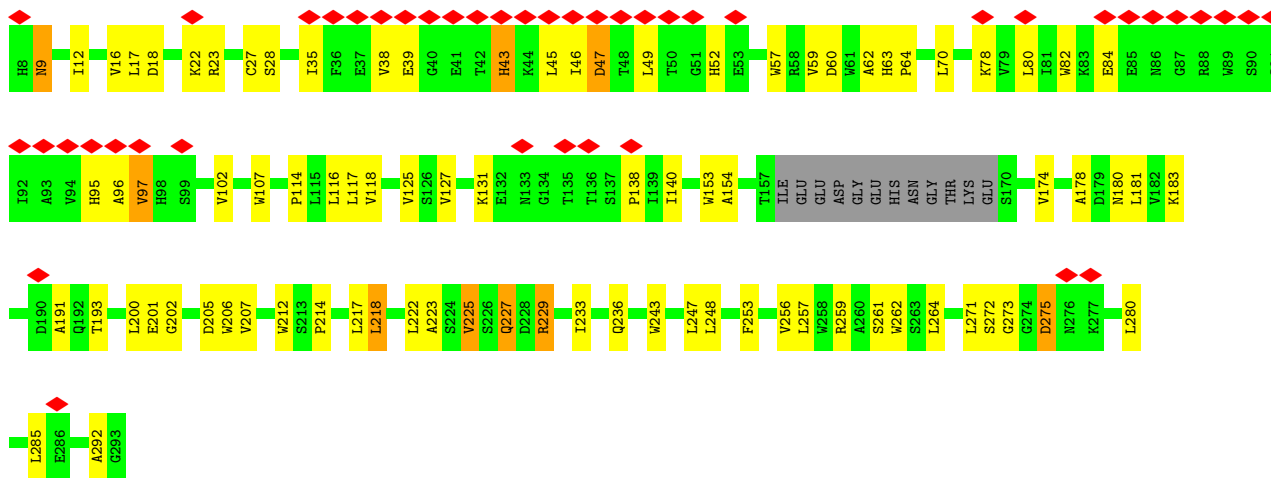

• Molecule 25: SEC13



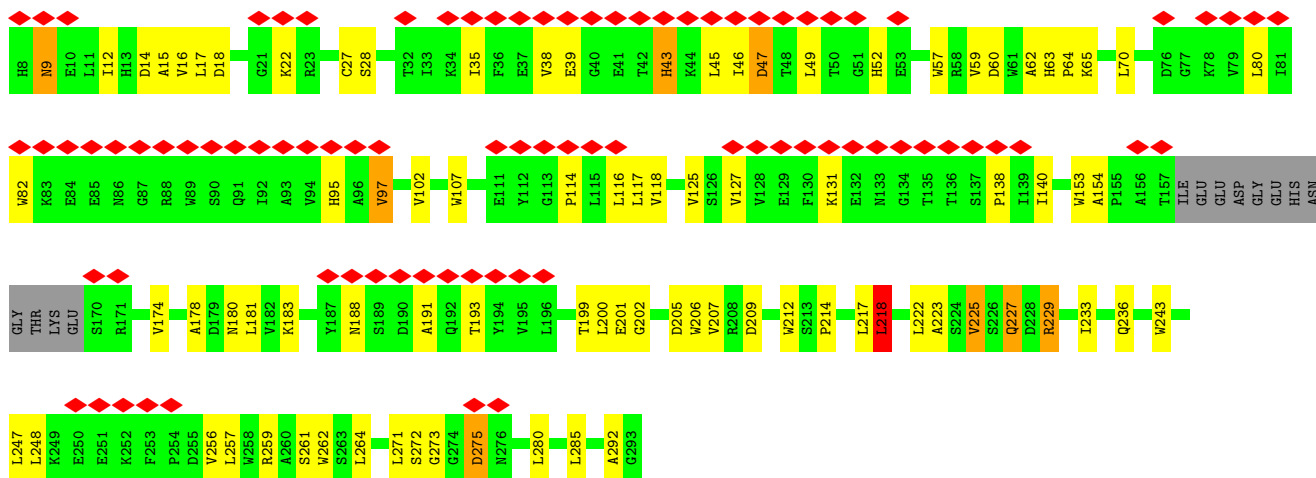

• Molecule 26: NUP75

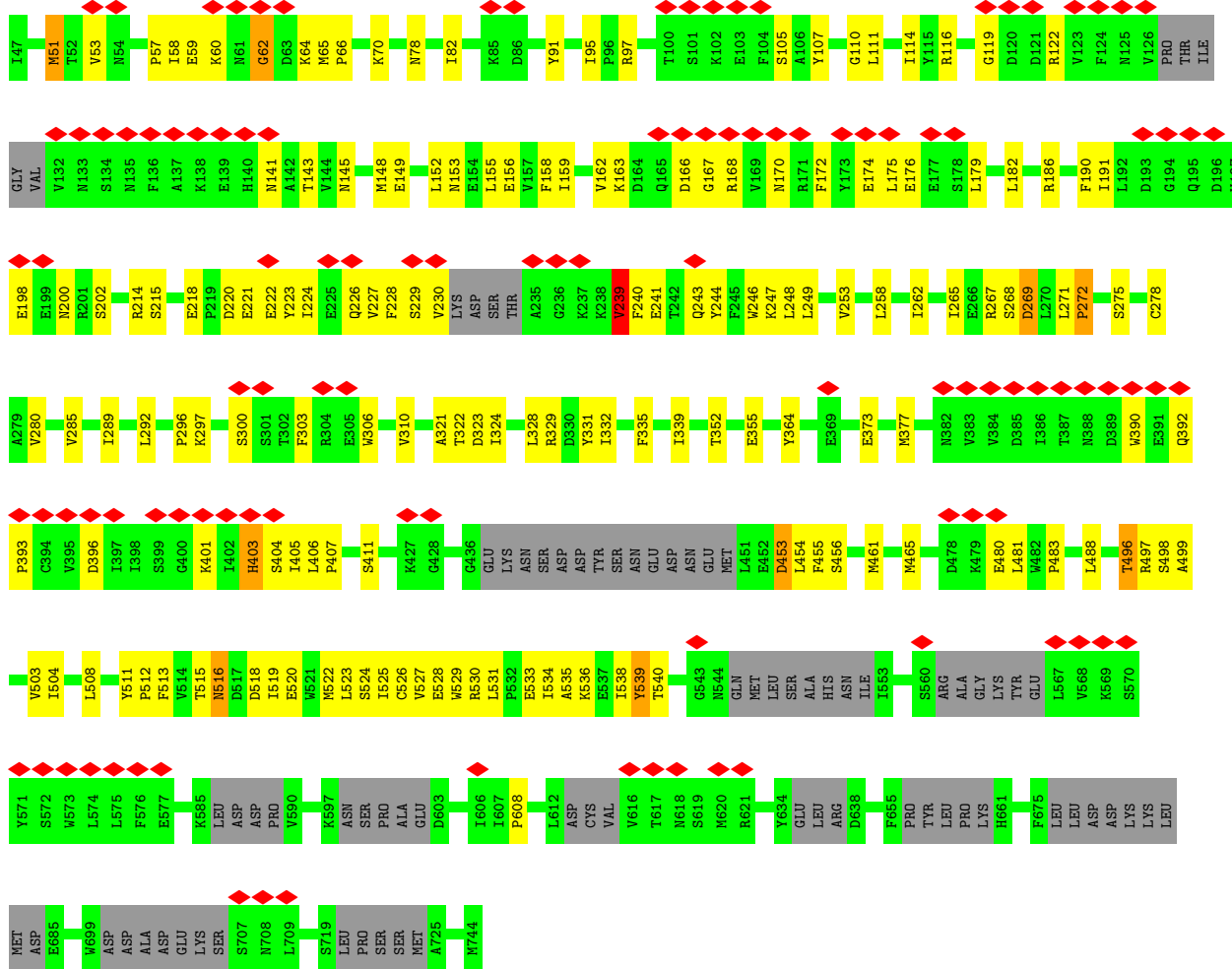

• Molecule 26: NUP75



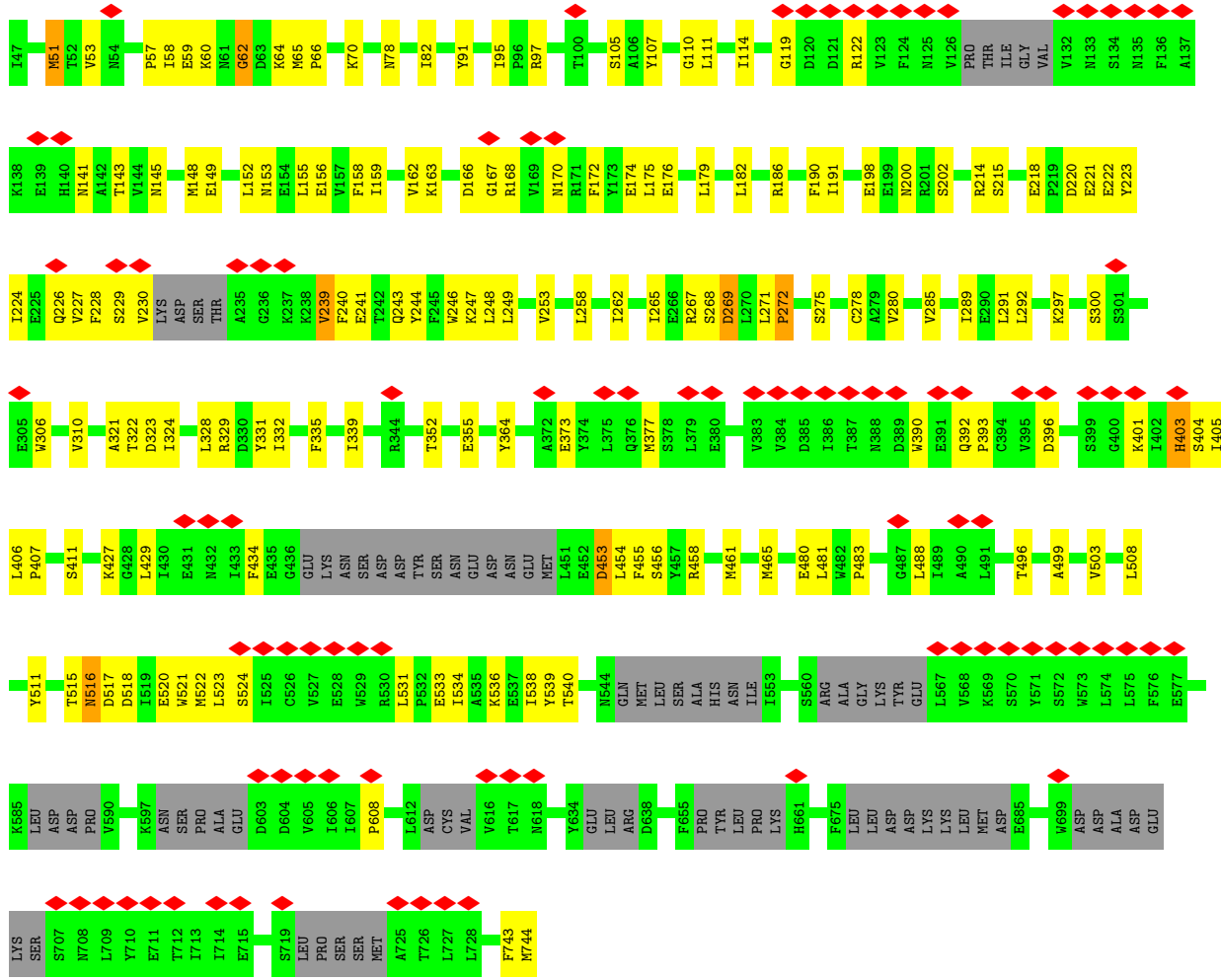

• Molecule 26: NUP75

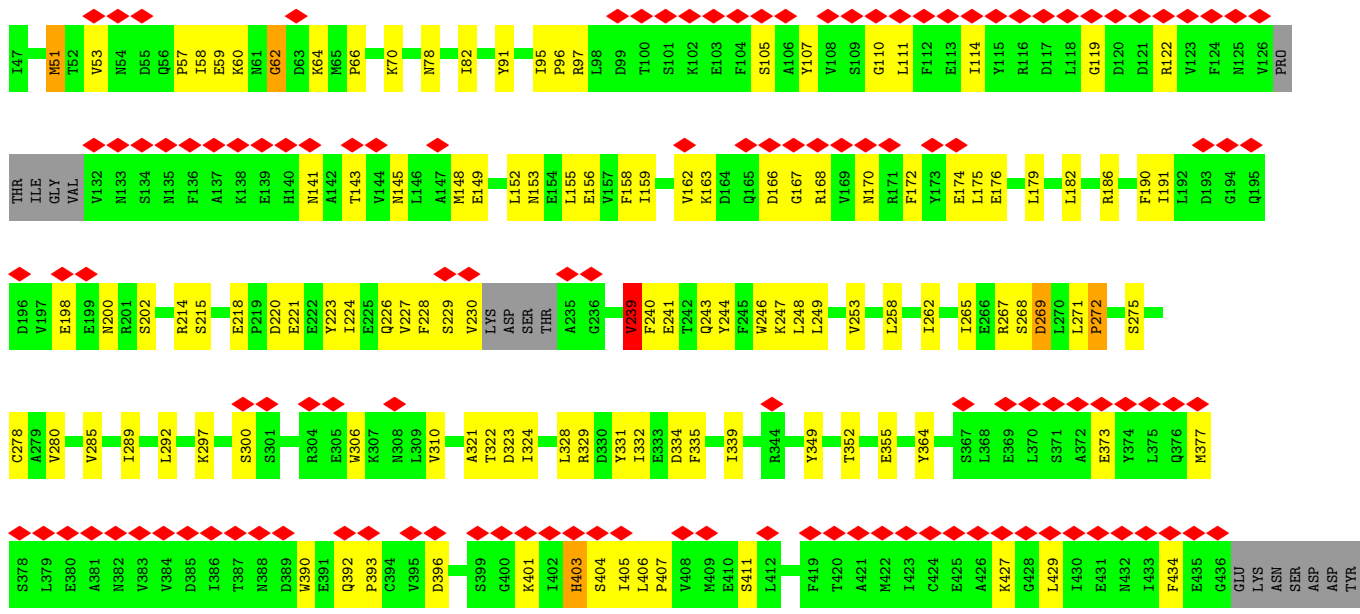

F743
M744

• Molecule 27: SEH1

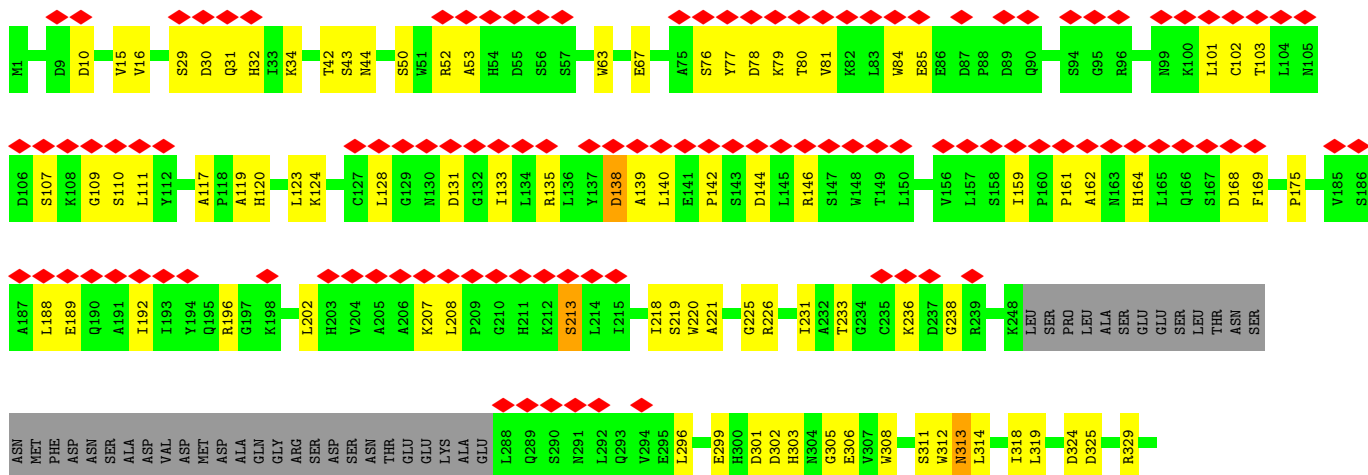

T334
V344
I346
T346

• Molecule 27: SEH1

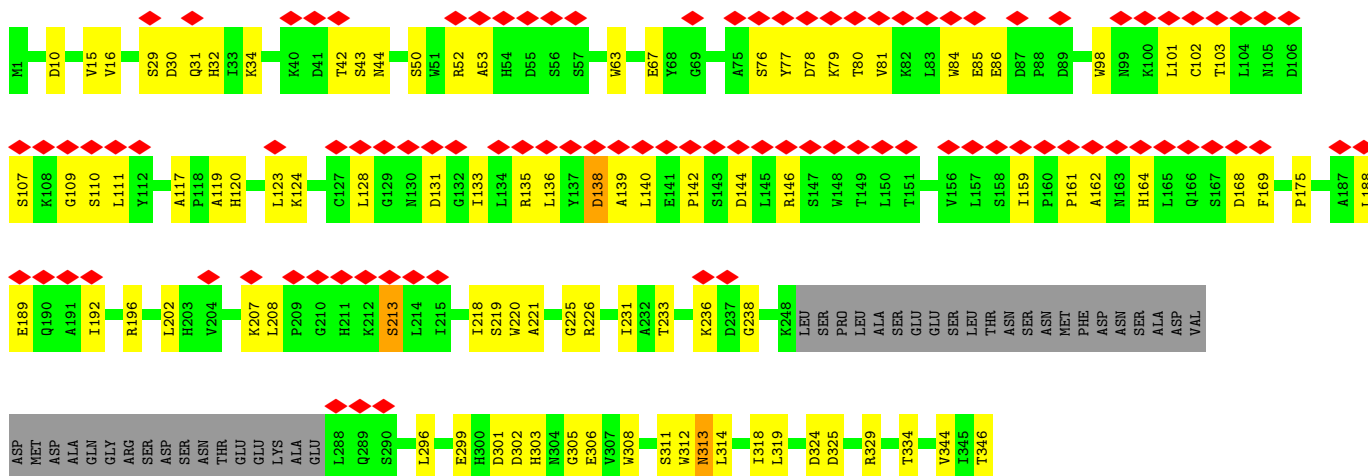

• Molecule 27: SEH1

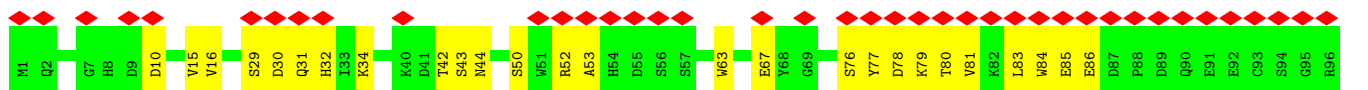
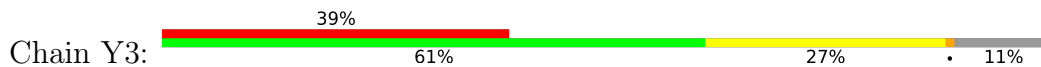

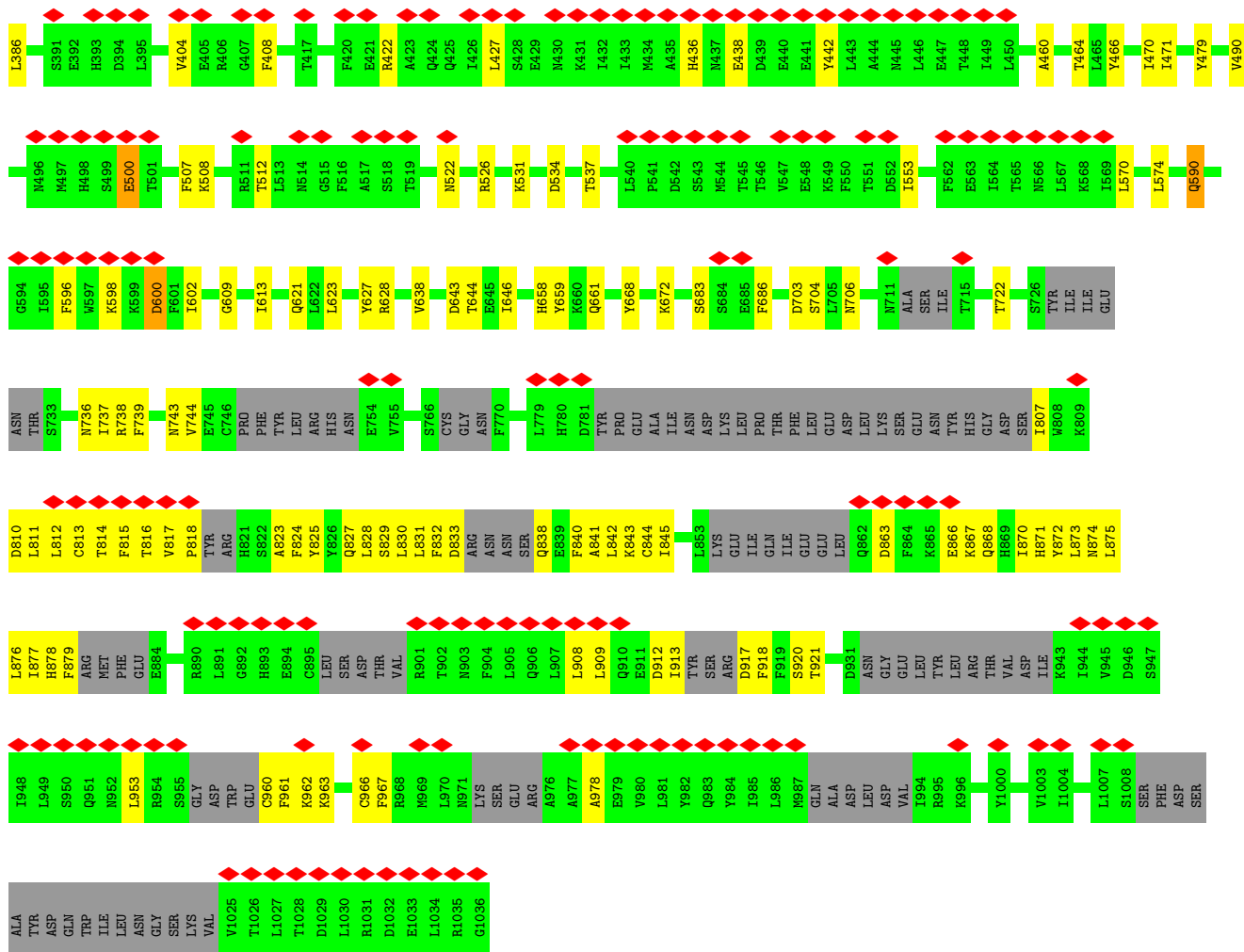

• Molecule 28: NUP160

Chain Z3:

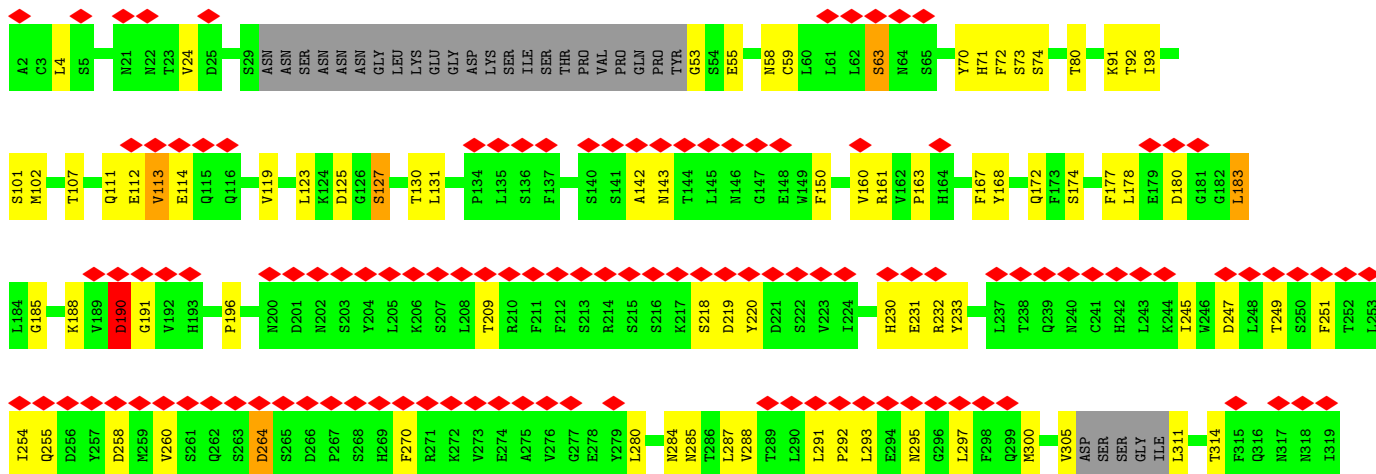

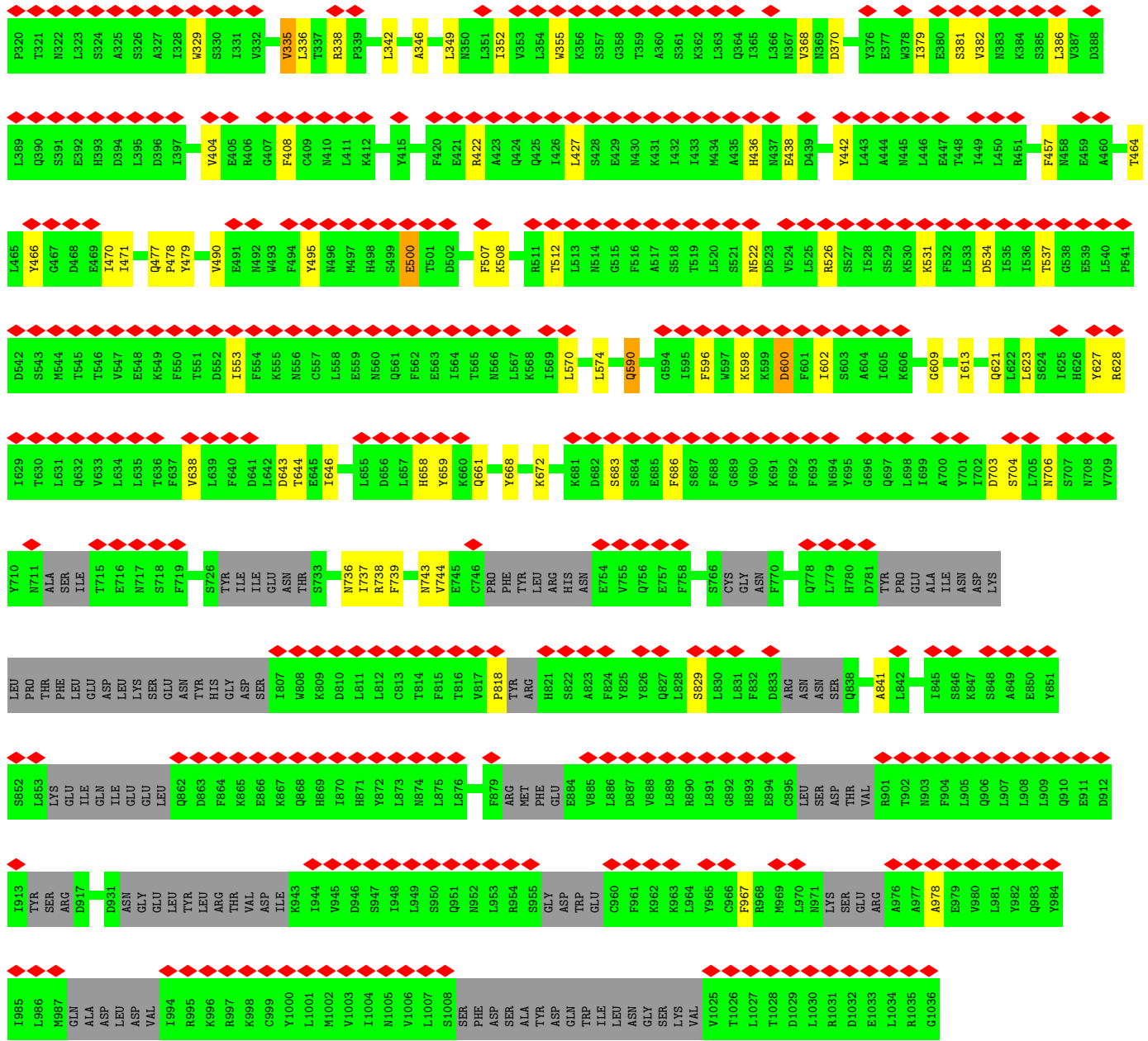

● Molecule 28: NUP160

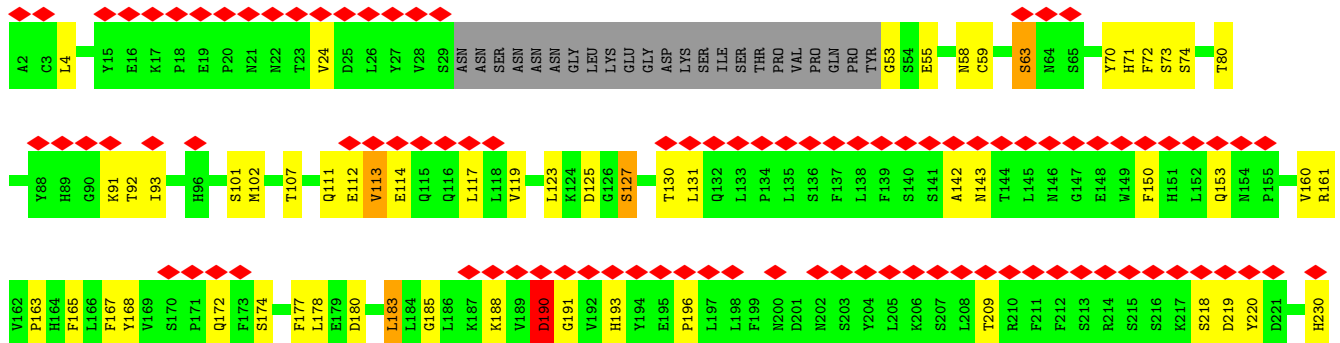
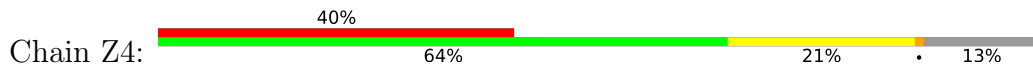

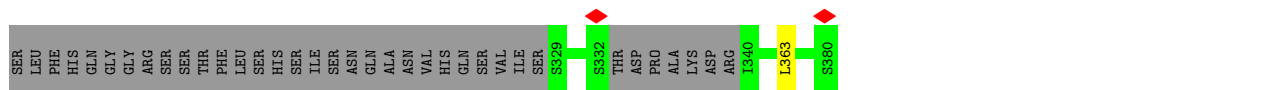

• Molecule 29: NUP43

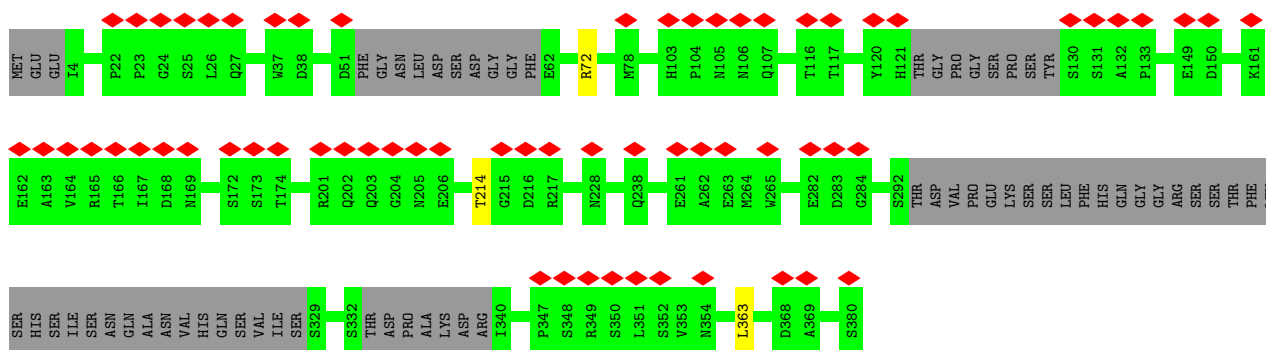
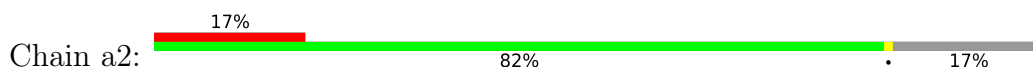

• Molecule 29: NUP43

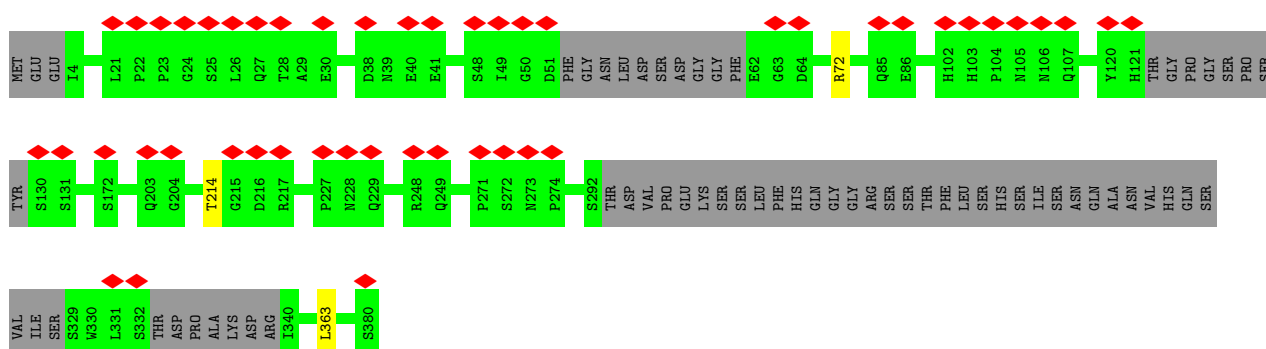
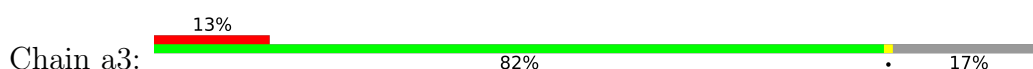

• Molecule 29: NUP43

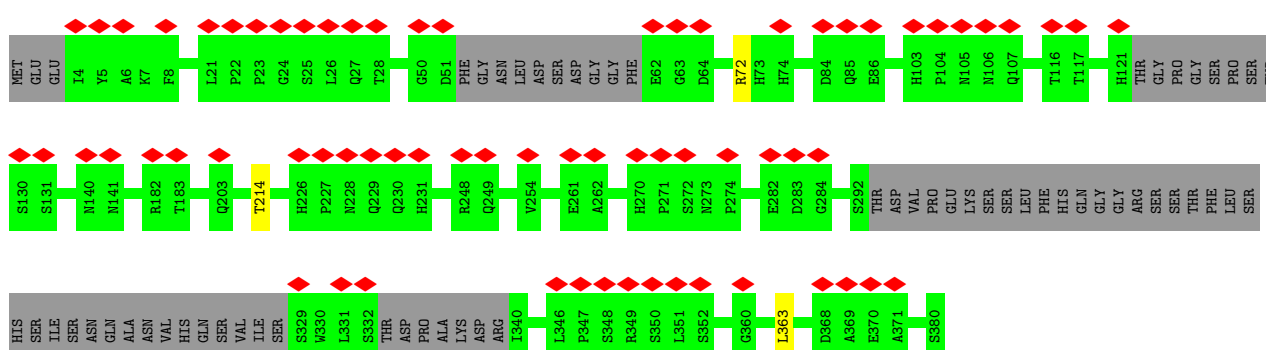
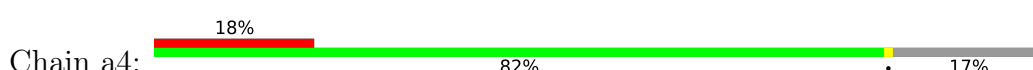

• Molecule 30: NUP37

4 Experimental information

Property	Value	Source
EM reconstruction method	SUBTOMOGRAM AVERAGING	Depositor
Imposed symmetry	POINT, Not provided	
Number of subtomograms used	17368	Depositor
Resolution determination method	FSC 0.143 CUT-OFF	Depositor
CTF correction method	PHASE FLIPPING AND AMPLITUDE CORRECTION	Depositor
Microscope	FEI TITAN KRIOS	Depositor
Voltage (kV)	300	Depositor
Electron dose ($e^-/\text{\AA}^2$)	110	Depositor
Minimum defocus (nm)	1900	Depositor
Maximum defocus (nm)	4000	Depositor
Magnification	Not provided	
Image detector	GATAN K2 SUMMIT (4k x 4k)	Depositor
Maximum map value	82.185	Depositor
Minimum map value	-69.686	Depositor
Average map value	0.077	Depositor
Map value standard deviation	0.791	Depositor
Recommended contour level	3.5	Depositor
Map size (Å)	1941.1199, 1941.1199, 1941.1199	wwPDB
Map dimensions	576, 576, 576	wwPDB
Map angles (°)	90.0, 90.0, 90.0	wwPDB
Pixel spacing (Å)	3.37, 3.37, 3.37	Depositor

5 Model quality [i](#)

5.1 Standard geometry [i](#)

The Z score for a bond length (or angle) is the number of standard deviations the observed value is removed from the expected value. A bond length (or angle) with $|Z| > 5$ is considered an outlier worth inspection. RMSZ is the root-mean-square of all Z scores of the bond lengths (or angles).

Mol	Chain	Bond lengths		Bond angles	
		RMSZ	# Z >5	RMSZ	# Z >5
1	A1	0.28	1/9926 (0.0%)	0.44	0/13474
1	A3	0.28	1/9926 (0.0%)	0.44	0/13474
2	A2	0.25	0/10133	0.45	0/13731
2	A4	0.25	0/10133	0.45	0/13731
3	A5	0.26	1/10216 (0.0%)	0.43	0/13838
3	A6	0.26	1/10216 (0.0%)	0.43	0/13838
4	B1	0.25	0/112	0.48	0/149
4	B2	0.25	0/112	0.48	0/149
4	B3	0.25	0/112	0.48	0/149
4	B4	0.25	0/112	0.48	0/149
4	B5	0.26	0/112	0.48	0/149
4	B6	0.26	0/112	0.48	0/149
5	C1	0.39	0/140	0.50	0/188
5	C2	0.30	0/160	0.53	0/214
5	C3	0.39	0/140	0.50	0/188
5	C4	0.30	0/160	0.53	0/214
5	C5	0.39	0/140	0.50	0/188
5	C6	0.39	0/140	0.51	0/188
6	D1	0.27	0/5130	0.43	0/6930
6	D2	0.27	0/5130	0.43	0/6930
6	D3	0.27	0/5130	0.43	0/6930
6	D4	0.27	0/5130	0.43	0/6930
6	D5	0.27	0/5130	0.43	0/6930
6	D6	0.27	0/5130	0.43	0/6930
6	D7	0.27	0/5130	0.43	0/6930
7	E1	0.25	0/65	0.41	0/89
7	E2	0.25	0/65	0.41	0/89
7	E3	0.25	0/65	0.42	0/89
7	E4	0.24	0/65	0.41	0/89
7	E5	0.24	0/65	0.42	0/89
7	E6	0.24	0/65	0.41	0/89
7	E7	0.24	0/65	0.42	0/89
8	F1	0.24	0/13031	0.39	0/17717
8	F2	0.24	0/13031	0.39	0/17717

Mol	Chain	Bond lengths		Bond angles	
		RMSZ	# Z >5	RMSZ	# Z >5
9	G1	0.23	0/445	0.38	0/600
9	G2	0.23	0/445	0.38	0/600
10	H1	0.25	0/95	0.37	0/128
10	H2	0.25	0/95	0.37	0/128
11	I1	0.23	0/12541	0.35	0/16980
11	I2	0.23	0/12541	0.35	0/16980
11	I3	0.23	0/12541	0.35	0/16980
11	I4	0.23	0/12541	0.36	0/16980
11	I5	0.23	0/12541	0.35	0/16980
12	J1	0.23	0/511	0.36	0/688
12	J2	0.23	0/511	0.37	0/688
12	J3	0.23	0/511	0.37	0/688
12	J4	0.23	0/511	0.37	0/688
12	J5	0.23	0/511	0.37	0/688
13	K1	0.23	0/75	0.40	0/101
13	K2	0.23	0/75	0.39	0/101
13	K3	0.23	0/75	0.39	0/101
13	K4	0.23	0/75	0.39	0/101
13	K5	0.23	0/75	0.39	0/101
14	L1	0.29	0/15	0.17	0/18
14	L2	0.28	0/15	0.17	0/18
14	L3	0.27	0/15	0.18	0/18
14	L4	0.28	0/15	0.19	0/18
14	L5	0.29	0/15	0.18	0/18
15	M1	0.26	0/1388	0.39	0/1866
15	M2	0.26	0/1388	0.39	0/1866
15	M3	0.26	0/1388	0.39	0/1866
15	M4	0.26	0/1388	0.40	0/1866
16	N1	0.24	0/1413	0.38	0/1898
16	N2	0.24	0/1413	0.38	0/1898
16	N3	0.24	0/1413	0.38	0/1898
16	N4	0.24	0/1413	0.38	0/1898
17	O1	0.26	0/2011	0.41	0/2715
17	O2	0.26	0/2011	0.41	0/2715
17	O3	0.26	0/2011	0.41	0/2715
17	O4	0.26	0/2011	0.41	0/2715
18	P1	0.37	0/910	0.51	0/1228
18	P2	0.37	0/910	0.51	0/1228
18	P3	0.37	0/910	0.51	0/1228
18	P4	0.37	0/910	0.51	0/1228
19	Q1	0.50	0/672	0.59	0/898
19	Q2	0.49	0/629	0.61	0/842
19	Q3	0.50	0/672	0.59	0/898

Mol	Chain	Bond lengths		Bond angles	
		RMSZ	# Z >5	RMSZ	# Z >5
19	Q4	0.49	0/629	0.61	0/842
20	R1	0.23	0/312	0.38	0/416
20	R2	0.23	0/312	0.38	0/416
20	R3	0.23	0/312	0.38	0/416
20	R4	0.23	0/312	0.38	0/416
21	S1	0.84	6/6081 (0.1%)	0.83	19/8304 (0.2%)
21	S2	0.84	6/6081 (0.1%)	0.83	18/8304 (0.2%)
21	S3	0.84	6/6081 (0.1%)	0.83	18/8304 (0.2%)
21	S4	0.84	6/6081 (0.1%)	0.83	18/8304 (0.2%)
22	T1	0.24	0/2037	0.41	0/2749
22	T2	0.24	0/2037	0.41	0/2749
22	T3	0.24	0/2037	0.41	0/2749
22	T4	0.24	0/2037	0.41	0/2749
23	U1	0.36	0/3472	0.64	2/4714 (0.0%)
23	U2	0.36	0/3472	0.64	2/4714 (0.0%)
23	U3	0.36	0/3472	0.64	2/4714 (0.0%)
23	U4	0.36	0/3472	0.64	2/4714 (0.0%)
24	V1	0.37	0/3860	0.66	2/5224 (0.0%)
24	V2	0.37	0/3860	0.66	2/5224 (0.0%)
24	V3	0.37	0/3860	0.66	2/5224 (0.0%)
24	V4	0.37	0/3860	0.66	2/5224 (0.0%)
25	W1	0.32	0/2220	0.62	0/3028
25	W2	0.32	0/2220	0.62	0/3028
25	W3	0.32	0/2220	0.62	0/3028
25	W4	0.32	0/2220	0.62	1/3028 (0.0%)
26	X1	0.31	0/4602	0.58	2/6246 (0.0%)
26	X2	0.31	0/4602	0.58	2/6246 (0.0%)
26	X3	0.31	0/4602	0.58	2/6246 (0.0%)
26	X4	0.31	0/4602	0.58	2/6246 (0.0%)
27	Y1	0.28	0/2499	0.64	0/3388
27	Y2	0.28	0/2499	0.64	0/3388
27	Y3	0.28	0/2499	0.64	0/3388
27	Y4	0.28	0/2499	0.64	0/3388
28	Z1	0.33	0/6730	0.55	1/9158 (0.0%)
28	Z2	0.33	0/6730	0.55	1/9158 (0.0%)
28	Z3	0.33	0/6730	0.55	1/9158 (0.0%)
28	Z4	0.33	0/6730	0.55	1/9158 (0.0%)
29	a1	0.78	0/2723	0.78	0/3715
29	a2	0.78	0/2723	0.78	0/3715
29	a3	0.78	0/2723	0.78	0/3715
29	a4	0.78	0/2723	0.78	0/3715
30	b1	0.33	0/2702	0.65	0/3689
30	b2	0.33	0/2702	0.65	0/3689

Mol	Chain	Bond lengths		Bond angles	
		RMSZ	# Z >5	RMSZ	# Z >5
30	b3	0.33	0/2702	0.65	0/3689
30	b4	0.33	0/2702	0.65	0/3689
All	All	0.37	28/365761 (0.0%)	0.52	102/495950 (0.0%)

Chiral center outliers are detected by calculating the chiral volume of a chiral center and verifying if the center is modelled as a planar moiety or with the opposite hand. A planarity outlier is detected by checking planarity of atoms in a peptide group, atoms in a mainchain group or atoms of a sidechain that are expected to be planar.

Mol	Chain	#Chirality outliers	#Planarity outliers
1	A1	0	2
1	A3	0	2
2	A2	0	1
2	A4	0	1
23	U1	0	1
23	U2	0	1
23	U3	0	1
23	U4	0	1
24	V1	0	2
24	V2	0	2
24	V3	0	2
24	V4	0	2
28	Z1	0	2
28	Z2	0	2
28	Z3	0	2
28	Z4	0	2
30	b1	0	3
30	b2	0	3
30	b3	0	3
30	b4	0	3
All	All	0	38

The worst 5 of 28 bond length outliers are listed below:

Mol	Chain	Res	Type	Atoms	Z	Observed(Å)	Ideal(Å)
1	A1	891	GLY	C-N	7.13	1.50	1.34
1	A3	891	GLY	C-N	7.09	1.50	1.34
21	S2	151	TRP	CE3-CZ3	7.01	1.50	1.38
21	S1	151	TRP	CE3-CZ3	7.00	1.50	1.38
21	S3	151	TRP	CE3-CZ3	7.00	1.50	1.38

The worst 5 of 102 bond angle outliers are listed below:

Mol	Chain	Res	Type	Atoms	Z	Observed(°)	Ideal(°)
21	S2	685	PRO	N-CA-CB	8.63	113.66	103.30
21	S1	685	PRO	N-CA-CB	8.62	113.65	103.30
21	S3	685	PRO	N-CA-CB	8.58	113.60	103.30
21	S4	685	PRO	N-CA-CB	8.58	113.60	103.30
21	S3	377	ASP	CB-CG-OD2	8.03	125.53	118.30

There are no chirality outliers.

5 of 38 planarity outliers are listed below:

Mol	Chain	Res	Type	Group
1	A1	891	GLY	Mainchain
1	A1	976	LEU	Peptide
2	A2	699	SER	Peptide
1	A3	891	GLY	Mainchain
1	A3	976	LEU	Peptide

5.2 Too-close contacts [i](#)

In the following table, the Non-H and H(model) columns list the number of non-hydrogen atoms and hydrogen atoms in the chain respectively. The H(added) column lists the number of hydrogen atoms added and optimized by MolProbity. The Clashes column lists the number of clashes within the asymmetric unit, whereas Symm-Clashes lists symmetry-related clashes.

Mol	Chain	Non-H	H(model)	H(added)	Clashes	Symm-Clashes
1	A1	9730	0	9632	528	0
1	A3	9730	0	9631	471	0
2	A2	9946	0	9773	1873	0
2	A4	9946	0	9777	1951	0
3	A5	10030	0	9896	1473	0
3	A6	10030	0	9913	1555	0
4	B1	111	0	127	1	0
4	B2	111	0	127	23	0
4	B3	111	0	127	1	0
4	B4	111	0	127	23	0
4	B5	111	0	126	43	0
4	B6	111	0	124	60	0
5	C1	138	0	144	33	0
5	C2	157	0	158	273	0
5	C3	138	0	144	10	0
5	C4	157	0	155	372	0
5	C5	138	0	144	23	0
5	C6	138	0	144	23	0

Continued on next page...

Continued from previous page...

Mol	Chain	Non-H	H(model)	H(added)	Clashes	Symm-Clashes
6	D1	5034	0	5006	1045	0
6	D2	5034	0	5030	85	0
6	D3	5034	0	4979	1450	0
6	D4	5034	0	5030	91	0
6	D5	5034	0	5030	55	0
6	D6	5034	0	5030	52	0
6	D7	5034	0	5026	126	0
7	E1	63	0	65	2	0
7	E2	63	0	65	2	0
7	E3	63	0	65	2	0
7	E4	63	0	65	2	0
7	E5	63	0	65	2	0
7	E6	63	0	65	2	0
7	E7	63	0	65	2	0
8	F1	12779	0	12914	333	0
8	F2	12779	0	12917	119	0
9	G1	438	0	411	204	0
9	G2	438	0	412	67	0
10	H1	94	0	84	0	0
10	H2	94	0	84	0	0
11	I1	12307	0	12275	3088	0
11	I2	12307	0	12283	3009	0
11	I3	12307	0	12352	452	0
11	I4	12307	0	12359	340	0
11	I5	12307	0	12349	507	0
12	J1	504	0	486	51	0
12	J2	504	0	485	52	0
12	J3	504	0	487	31	0
12	J4	504	0	487	30	0
12	J5	504	0	487	31	0
13	K1	73	0	82	0	0
13	K2	73	0	82	0	0
13	K3	73	0	82	0	0
13	K4	73	0	82	0	0
13	K5	73	0	82	0	0
14	L1	15	0	11	0	0
14	L2	15	0	11	0	0
14	L3	15	0	11	0	0
14	L4	15	0	11	0	0
14	L5	15	0	11	0	0
15	M1	1372	0	1330	685	0
15	M2	1372	0	1361	55	0

Continued on next page...

Continued from previous page...

Mol	Chain	Non-H	H(model)	H(added)	Clashes	Symm-Clashes
15	M3	1372	0	1332	570	0
15	M4	1372	0	1363	5	0
16	N1	1401	0	1376	729	0
16	N2	1401	0	1398	60	0
16	N3	1401	0	1384	604	0
16	N4	1401	0	1398	10	0
17	O1	1971	0	1944	825	0
17	O2	1971	0	1961	378	0
17	O3	1971	0	1936	1090	0
17	O4	1971	0	1963	228	0
18	P1	900	0	910	49	0
18	P2	900	0	910	41	0
18	P3	900	0	908	146	0
18	P4	900	0	907	107	0
19	Q1	658	0	645	3	0
19	Q2	616	0	600	3	0
19	Q3	658	0	645	3	0
19	Q4	616	0	600	3	0
20	R1	311	0	314	405	0
20	R2	311	0	334	2	0
20	R3	311	0	314	432	0
20	R4	311	0	334	2	0
21	S1	6013	0	4984	168	0
21	S2	6013	0	4984	163	0
21	S3	6013	0	4984	165	0
21	S4	6013	0	4984	164	0
22	T1	1993	0	1981	73	0
22	T2	1993	0	1981	68	0
22	T3	1993	0	1981	71	0
22	T4	1993	0	1981	68	0
23	U1	3404	0	3378	81	0
23	U2	3404	0	3378	80	0
23	U3	3404	0	3378	75	0
23	U4	3404	0	3378	81	0
24	V1	3805	0	3499	107	0
24	V2	3805	0	3499	104	0
24	V3	3805	0	3499	109	0
24	V4	3805	0	3499	106	0
25	W1	2160	0	2096	64	0
25	W2	2160	0	2096	72	0
25	W3	2160	0	2096	62	0
25	W4	2160	0	2096	64	0

Continued on next page...

Continued from previous page...

Mol	Chain	Non-H	H(model)	H(added)	Clashes	Symm-Clashes
26	X1	4535	0	4064	383	0
26	X2	4535	0	4071	159	0
26	X3	4535	0	4063	346	0
26	X4	4535	0	4073	139	0
27	Y1	2438	0	2378	55	0
27	Y2	2438	0	2378	56	0
27	Y3	2438	0	2378	57	0
27	Y4	2438	0	2378	56	0
28	Z1	6622	0	5893	82	0
28	Z2	6622	0	5882	485	0
28	Z3	6622	0	5893	80	0
28	Z4	6622	0	5872	791	0
29	a1	2587	0	2488	0	0
29	a2	2587	0	2488	0	0
29	a3	2587	0	2488	0	0
29	a4	2587	0	2488	0	0
30	b1	2638	0	2573	0	0
30	b2	2638	0	2573	0	0
30	b3	2638	0	2573	0	0
30	b4	2638	0	2573	0	0
All	All	358888	0	346678	17412	0

The all-atom clashscore is defined as the number of clashes found per 1000 atoms (including hydrogen atoms). The all-atom clashscore for this structure is 28.

The worst 5 of 17412 close contacts within the same asymmetric unit are listed below, sorted by their clash magnitude.

Atom-1	Atom-2	Interatomic distance (Å)	Clash overlap (Å)
11:I3:1267:LEU:HD22	26:X1:497:ARG:CZ	1.20	1.68
3:A6:1369:ILE:HA	28:Z4:826:TYR:CB	1.23	1.67
8:F1:1262:HIS:CE1	17:O2:259:ASP:HB2	1.26	1.67
11:I1:1052:LEU:CB	16:N1:438:LEU:HD11	1.18	1.66
1:A1:870:HIS:HB3	6:D3:279:HIS:CG	1.31	1.65

There are no symmetry-related clashes.

5.3 Torsion angles

5.3.1 Protein backbone

In the following table, the Percentiles column shows the percent Ramachandran outliers of the chain as a percentile score with respect to all PDB entries followed by that with respect to all EM entries.

The Analysed column shows the number of residues for which the backbone conformation was analysed, and the total number of residues.

Mol	Chain	Analysed	Favoured	Allowed	Outliers	Percentiles	
1	A1	1211/1316 (92%)	1172 (97%)	39 (3%)	0	100	100
1	A3	1211/1316 (92%)	1172 (97%)	39 (3%)	0	100	100
2	A2	1255/1328 (94%)	1183 (94%)	54 (4%)	18 (1%)	11	46
2	A4	1255/1328 (94%)	1182 (94%)	55 (4%)	18 (1%)	11	46
3	A5	1258/1330 (95%)	1224 (97%)	34 (3%)	0	100	100
3	A6	1258/1330 (95%)	1224 (97%)	34 (3%)	0	100	100
4	B1	12/14 (86%)	11 (92%)	1 (8%)	0	100	100
4	B2	12/14 (86%)	11 (92%)	1 (8%)	0	100	100
4	B3	12/14 (86%)	11 (92%)	1 (8%)	0	100	100
4	B4	12/14 (86%)	11 (92%)	1 (8%)	0	100	100
4	B5	12/14 (86%)	11 (92%)	1 (8%)	0	100	100
4	B6	12/14 (86%)	11 (92%)	1 (8%)	0	100	100
5	C1	15/19 (79%)	11 (73%)	4 (27%)	0	100	100
5	C2	17/19 (90%)	12 (71%)	5 (29%)	0	100	100
5	C3	15/19 (79%)	11 (73%)	4 (27%)	0	100	100
5	C4	17/19 (90%)	12 (71%)	5 (29%)	0	100	100
5	C5	15/19 (79%)	11 (73%)	4 (27%)	0	100	100
5	C6	15/19 (79%)	11 (73%)	4 (27%)	0	100	100
6	D1	615/644 (96%)	604 (98%)	11 (2%)	0	100	100
6	D2	615/644 (96%)	604 (98%)	11 (2%)	0	100	100
6	D3	615/644 (96%)	604 (98%)	11 (2%)	0	100	100
6	D4	615/644 (96%)	604 (98%)	11 (2%)	0	100	100
6	D5	615/644 (96%)	604 (98%)	11 (2%)	0	100	100
6	D6	615/644 (96%)	604 (98%)	11 (2%)	0	100	100
6	D7	615/644 (96%)	604 (98%)	11 (2%)	0	100	100

Continued on next page...

Continued from previous page...

Mol	Chain	Analysed	Favoured	Allowed	Outliers	Percentiles	
7	E1	6/8 (75%)	6 (100%)	0	0	100	100
7	E2	6/8 (75%)	6 (100%)	0	0	100	100
7	E3	6/8 (75%)	6 (100%)	0	0	100	100
7	E4	6/8 (75%)	6 (100%)	0	0	100	100
7	E5	6/8 (75%)	6 (100%)	0	0	100	100
7	E6	6/8 (75%)	6 (100%)	0	0	100	100
7	E7	6/8 (75%)	6 (100%)	0	0	100	100
8	F1	1611/1858 (87%)	1589 (99%)	22 (1%)	0	100	100
8	F2	1611/1858 (87%)	1589 (99%)	22 (1%)	0	100	100
9	G1	51/53 (96%)	51 (100%)	0	0	100	100
9	G2	51/53 (96%)	51 (100%)	0	0	100	100
10	H1	11/13 (85%)	7 (64%)	4 (36%)	0	100	100
10	H2	11/13 (85%)	7 (64%)	4 (36%)	0	100	100
11	I1	1508/1756 (86%)	1491 (99%)	17 (1%)	0	100	100
11	I2	1508/1756 (86%)	1491 (99%)	17 (1%)	0	100	100
11	I3	1508/1756 (86%)	1491 (99%)	17 (1%)	0	100	100
11	I4	1508/1756 (86%)	1491 (99%)	17 (1%)	0	100	100
11	I5	1508/1756 (86%)	1491 (99%)	17 (1%)	0	100	100
12	J1	61/63 (97%)	61 (100%)	0	0	100	100
12	J2	61/63 (97%)	61 (100%)	0	0	100	100
12	J3	61/63 (97%)	61 (100%)	0	0	100	100
12	J4	61/63 (97%)	61 (100%)	0	0	100	100
12	J5	61/63 (97%)	61 (100%)	0	0	100	100
13	K1	7/9 (78%)	5 (71%)	2 (29%)	0	100	100
13	K2	7/9 (78%)	5 (71%)	2 (29%)	0	100	100
13	K3	7/9 (78%)	5 (71%)	2 (29%)	0	100	100
13	K4	7/9 (78%)	5 (71%)	2 (29%)	0	100	100
13	K5	7/9 (78%)	5 (71%)	2 (29%)	0	100	100
15	M1	165/183 (90%)	158 (96%)	7 (4%)	0	100	100
15	M2	165/183 (90%)	158 (96%)	7 (4%)	0	100	100
15	M3	165/183 (90%)	158 (96%)	7 (4%)	0	100	100

Continued on next page...

Continued from previous page...

Mol	Chain	Analysed	Favoured	Allowed	Outliers	Percentiles	
15	M4	165/183 (90%)	158 (96%)	7 (4%)	0	100	100
16	N1	174/222 (78%)	172 (99%)	2 (1%)	0	100	100
16	N2	174/222 (78%)	172 (99%)	2 (1%)	0	100	100
16	N3	174/222 (78%)	172 (99%)	2 (1%)	0	100	100
16	N4	174/222 (78%)	172 (99%)	2 (1%)	0	100	100
17	O1	239/241 (99%)	213 (89%)	26 (11%)	0	100	100
17	O2	239/241 (99%)	212 (89%)	27 (11%)	0	100	100
17	O3	239/241 (99%)	213 (89%)	26 (11%)	0	100	100
17	O4	239/241 (99%)	213 (89%)	26 (11%)	0	100	100
18	P1	115/116 (99%)	114 (99%)	1 (1%)	0	100	100
18	P2	115/116 (99%)	114 (99%)	1 (1%)	0	100	100
18	P3	115/116 (99%)	114 (99%)	1 (1%)	0	100	100
18	P4	115/116 (99%)	114 (99%)	1 (1%)	0	100	100
19	Q1	83/84 (99%)	81 (98%)	2 (2%)	0	100	100
19	Q2	79/84 (94%)	77 (98%)	2 (2%)	0	100	100
19	Q3	83/84 (99%)	81 (98%)	2 (2%)	0	100	100
19	Q4	79/84 (94%)	77 (98%)	2 (2%)	0	100	100
20	R1	38/40 (95%)	31 (82%)	7 (18%)	0	100	100
20	R2	38/40 (95%)	31 (82%)	7 (18%)	0	100	100
20	R3	38/40 (95%)	31 (82%)	7 (18%)	0	100	100
20	R4	38/40 (95%)	31 (82%)	7 (18%)	0	100	100
21	S1	874/1156 (76%)	784 (90%)	74 (8%)	16 (2%)	8	40
21	S2	874/1156 (76%)	784 (90%)	74 (8%)	16 (2%)	8	40
21	S3	874/1156 (76%)	784 (90%)	74 (8%)	16 (2%)	8	40
21	S4	874/1156 (76%)	784 (90%)	74 (8%)	16 (2%)	8	40
22	T1	243/258 (94%)	235 (97%)	8 (3%)	0	100	100
22	T2	243/258 (94%)	234 (96%)	9 (4%)	0	100	100
22	T3	243/258 (94%)	234 (96%)	9 (4%)	0	100	100
22	T4	243/258 (94%)	234 (96%)	9 (4%)	0	100	100
23	U1	413/436 (95%)	368 (89%)	34 (8%)	11 (3%)	5	31
23	U2	413/436 (95%)	367 (89%)	35 (8%)	11 (3%)	5	31

Continued on next page...

Continued from previous page...

Mol	Chain	Analysed	Favoured	Allowed	Outliers	Percentiles	
23	U3	413/436 (95%)	368 (89%)	34 (8%)	11 (3%)	5	31
23	U4	413/436 (95%)	368 (89%)	34 (8%)	11 (3%)	5	31
24	V1	491/621 (79%)	451 (92%)	30 (6%)	10 (2%)	7	38
24	V2	491/621 (79%)	451 (92%)	30 (6%)	10 (2%)	7	38
24	V3	491/621 (79%)	451 (92%)	30 (6%)	10 (2%)	7	38
24	V4	491/621 (79%)	451 (92%)	30 (6%)	10 (2%)	7	38
25	W1	270/286 (94%)	228 (84%)	36 (13%)	6 (2%)	6	35
25	W2	270/286 (94%)	228 (84%)	36 (13%)	6 (2%)	6	35
25	W3	270/286 (94%)	228 (84%)	36 (13%)	6 (2%)	6	35
25	W4	270/286 (94%)	228 (84%)	36 (13%)	6 (2%)	6	35
26	X1	592/698 (85%)	531 (90%)	51 (9%)	10 (2%)	9	42
26	X2	592/698 (85%)	531 (90%)	51 (9%)	10 (2%)	9	42
26	X3	592/698 (85%)	532 (90%)	50 (8%)	10 (2%)	9	42
26	X4	592/698 (85%)	532 (90%)	50 (8%)	10 (2%)	9	42
27	Y1	303/346 (88%)	266 (88%)	31 (10%)	6 (2%)	7	38
27	Y2	303/346 (88%)	266 (88%)	31 (10%)	6 (2%)	7	38
27	Y3	303/346 (88%)	266 (88%)	31 (10%)	6 (2%)	7	38
27	Y4	303/346 (88%)	266 (88%)	31 (10%)	6 (2%)	7	38
28	Z1	858/1035 (83%)	798 (93%)	49 (6%)	11 (1%)	12	48
28	Z2	858/1035 (83%)	798 (93%)	49 (6%)	11 (1%)	12	48
28	Z3	858/1035 (83%)	798 (93%)	49 (6%)	11 (1%)	12	48
28	Z4	858/1035 (83%)	798 (93%)	49 (6%)	11 (1%)	12	48
29	a1	334/380 (88%)	325 (97%)	9 (3%)	0	100	100
29	a2	334/380 (88%)	325 (97%)	9 (3%)	0	100	100
29	a3	334/380 (88%)	325 (97%)	9 (3%)	0	100	100
29	a4	334/380 (88%)	325 (97%)	9 (3%)	0	100	100
30	b1	335/385 (87%)	315 (94%)	19 (6%)	1 (0%)	41	77
30	b2	335/385 (87%)	315 (94%)	19 (6%)	1 (0%)	41	77
30	b3	335/385 (87%)	315 (94%)	19 (6%)	1 (0%)	41	77
30	b4	335/385 (87%)	315 (94%)	19 (6%)	1 (0%)	41	77
All	All	45287/51646 (88%)	42909 (95%)	2058 (4%)	320 (1%)	26	63

5 of 320 Ramachandran outliers are listed below:

Mol	Chain	Res	Type
2	A2	521	ASN
2	A2	1024	ASP
2	A2	1305	ALA
2	A2	1342	SER
2	A2	1345	SER

5.3.2 Protein sidechains [i](#)

In the following table, the Percentiles column shows the percent sidechain outliers of the chain as a percentile score with respect to all PDB entries followed by that with respect to all EM entries.

The Analysed column shows the number of residues for which the sidechain conformation was analysed, and the total number of residues.

Mol	Chain	Analysed	Rotameric	Outliers	Percentiles	
1	A1	1061/1111 (96%)	1053 (99%)	8 (1%)	81	89
1	A3	1061/1111 (96%)	1054 (99%)	7 (1%)	84	90
2	A2	1073/1107 (97%)	991 (92%)	82 (8%)	13	37
2	A4	1073/1107 (97%)	991 (92%)	82 (8%)	13	37
3	A5	1087/1111 (98%)	1076 (99%)	11 (1%)	76	86
3	A6	1087/1111 (98%)	1076 (99%)	11 (1%)	76	86
4	B1	12/12 (100%)	12 (100%)	0	100	100
4	B2	12/12 (100%)	12 (100%)	0	100	100
4	B3	12/12 (100%)	12 (100%)	0	100	100
4	B4	12/12 (100%)	12 (100%)	0	100	100
4	B5	12/12 (100%)	12 (100%)	0	100	100
4	B6	12/12 (100%)	12 (100%)	0	100	100
5	C1	17/19 (90%)	17 (100%)	0	100	100
5	C2	19/19 (100%)	19 (100%)	0	100	100
5	C3	17/19 (90%)	17 (100%)	0	100	100
5	C4	19/19 (100%)	19 (100%)	0	100	100
5	C5	17/19 (90%)	17 (100%)	0	100	100
5	C6	17/19 (90%)	17 (100%)	0	100	100
6	D1	554/575 (96%)	554 (100%)	0	100	100

Continued on next page...

Continued from previous page...

Mol	Chain	Analysed	Rotameric	Outliers	Percentiles	
6	D2	554/575 (96%)	554 (100%)	0	100	100
6	D3	554/575 (96%)	554 (100%)	0	100	100
6	D4	554/575 (96%)	554 (100%)	0	100	100
6	D5	554/575 (96%)	554 (100%)	0	100	100
6	D6	554/575 (96%)	554 (100%)	0	100	100
6	D7	554/575 (96%)	554 (100%)	0	100	100
7	E1	7/7 (100%)	7 (100%)	0	100	100
7	E2	7/7 (100%)	7 (100%)	0	100	100
7	E3	7/7 (100%)	7 (100%)	0	100	100
7	E4	7/7 (100%)	7 (100%)	0	100	100
7	E5	7/7 (100%)	7 (100%)	0	100	100
7	E6	7/7 (100%)	7 (100%)	0	100	100
7	E7	7/7 (100%)	7 (100%)	0	100	100
8	F1	1350/1512 (89%)	1350 (100%)	0	100	100
8	F2	1350/1512 (89%)	1350 (100%)	0	100	100
9	G1	47/47 (100%)	47 (100%)	0	100	100
9	G2	47/47 (100%)	47 (100%)	0	100	100
10	H1	10/10 (100%)	10 (100%)	0	100	100
10	H2	10/10 (100%)	10 (100%)	0	100	100
11	I1	1340/1509 (89%)	1339 (100%)	1 (0%)	93	97
11	I2	1340/1509 (89%)	1339 (100%)	1 (0%)	93	97
11	I3	1340/1509 (89%)	1339 (100%)	1 (0%)	93	97
11	I4	1340/1509 (89%)	1339 (100%)	1 (0%)	93	97
11	I5	1340/1509 (89%)	1339 (100%)	1 (0%)	93	97
12	J1	54/54 (100%)	54 (100%)	0	100	100
12	J2	54/54 (100%)	54 (100%)	0	100	100
12	J3	54/54 (100%)	54 (100%)	0	100	100
12	J4	54/54 (100%)	54 (100%)	0	100	100
12	J5	54/54 (100%)	54 (100%)	0	100	100
13	K1	9/9 (100%)	9 (100%)	0	100	100
13	K2	9/9 (100%)	9 (100%)	0	100	100

Continued on next page...

Continued from previous page...

Mol	Chain	Analysed	Rotameric	Outliers	Percentiles	
13	K3	9/9 (100%)	9 (100%)	0	100	100
13	K4	9/9 (100%)	9 (100%)	0	100	100
13	K5	9/9 (100%)	9 (100%)	0	100	100
14	L1	1/1 (100%)	1 (100%)	0	100	100
14	L2	1/1 (100%)	1 (100%)	0	100	100
14	L3	1/1 (100%)	1 (100%)	0	100	100
14	L4	1/1 (100%)	1 (100%)	0	100	100
14	L5	1/1 (100%)	1 (100%)	0	100	100
15	M1	146/154 (95%)	146 (100%)	0	100	100
15	M2	146/154 (95%)	146 (100%)	0	100	100
15	M3	146/154 (95%)	146 (100%)	0	100	100
15	M4	146/154 (95%)	146 (100%)	0	100	100
16	N1	150/173 (87%)	150 (100%)	0	100	100
16	N2	150/173 (87%)	150 (100%)	0	100	100
16	N3	150/173 (87%)	150 (100%)	0	100	100
16	N4	150/173 (87%)	150 (100%)	0	100	100
17	O1	213/213 (100%)	213 (100%)	0	100	100
17	O2	213/213 (100%)	213 (100%)	0	100	100
17	O3	213/213 (100%)	213 (100%)	0	100	100
17	O4	213/213 (100%)	213 (100%)	0	100	100
18	P1	101/100 (101%)	101 (100%)	0	100	100
18	P2	101/100 (101%)	101 (100%)	0	100	100
18	P3	101/100 (101%)	101 (100%)	0	100	100
18	P4	101/100 (101%)	101 (100%)	0	100	100
19	Q1	70/69 (101%)	66 (94%)	4 (6%)	20	45
19	Q2	63/69 (91%)	62 (98%)	1 (2%)	62	79
19	Q3	70/69 (101%)	66 (94%)	4 (6%)	20	45
19	Q4	63/69 (91%)	62 (98%)	1 (2%)	62	79
20	R1	32/32 (100%)	32 (100%)	0	100	100
20	R2	32/32 (100%)	32 (100%)	0	100	100
20	R3	32/32 (100%)	32 (100%)	0	100	100

Continued on next page...

Continued from previous page...

Mol	Chain	Analysed	Rotameric	Outliers	Percentiles	
20	R4	32/32 (100%)	32 (100%)	0	100	100
21	S1	488/1013 (48%)	463 (95%)	25 (5%)	24	48
21	S2	488/1013 (48%)	463 (95%)	25 (5%)	24	48
21	S3	488/1013 (48%)	463 (95%)	25 (5%)	24	48
21	S4	488/1013 (48%)	463 (95%)	25 (5%)	24	48
22	T1	211/231 (91%)	206 (98%)	5 (2%)	49	69
22	T2	211/231 (91%)	206 (98%)	5 (2%)	49	69
22	T3	211/231 (91%)	206 (98%)	5 (2%)	49	69
22	T4	211/231 (91%)	206 (98%)	5 (2%)	49	69
23	U1	387/402 (96%)	367 (95%)	20 (5%)	23	48
23	U2	387/402 (96%)	367 (95%)	20 (5%)	23	48
23	U3	387/402 (96%)	367 (95%)	20 (5%)	23	48
23	U4	387/402 (96%)	367 (95%)	20 (5%)	23	48
24	V1	367/567 (65%)	332 (90%)	35 (10%)	8	27
24	V2	367/567 (65%)	332 (90%)	35 (10%)	8	27
24	V3	367/567 (65%)	332 (90%)	35 (10%)	8	27
24	V4	367/567 (65%)	332 (90%)	35 (10%)	8	27
25	W1	233/243 (96%)	224 (96%)	9 (4%)	32	56
25	W2	233/243 (96%)	224 (96%)	9 (4%)	32	56
25	W3	233/243 (96%)	224 (96%)	9 (4%)	32	56
25	W4	233/243 (96%)	223 (96%)	10 (4%)	29	53
26	X1	424/628 (68%)	414 (98%)	10 (2%)	49	69
26	X2	424/628 (68%)	414 (98%)	10 (2%)	49	69
26	X3	424/628 (68%)	414 (98%)	10 (2%)	49	69
26	X4	424/628 (68%)	414 (98%)	10 (2%)	49	69
27	Y1	269/303 (89%)	261 (97%)	8 (3%)	41	63
27	Y2	269/303 (89%)	261 (97%)	8 (3%)	41	63
27	Y3	269/303 (89%)	261 (97%)	8 (3%)	41	63
27	Y4	269/303 (89%)	261 (97%)	8 (3%)	41	63
28	Z1	639/970 (66%)	616 (96%)	23 (4%)	35	59
28	Z2	639/970 (66%)	616 (96%)	23 (4%)	35	59

Continued on next page...

Continued from previous page...

Mol	Chain	Analysed	Rotameric	Outliers	Percentiles	
28	Z3	639/970 (66%)	616 (96%)	23 (4%)	35	59
28	Z4	639/970 (66%)	616 (96%)	23 (4%)	35	59
29	a1	293/335 (88%)	288 (98%)	5 (2%)	60	78
29	a2	293/335 (88%)	288 (98%)	5 (2%)	60	78
29	a3	293/335 (88%)	288 (98%)	5 (2%)	60	78
29	a4	293/335 (88%)	288 (98%)	5 (2%)	60	78
30	b1	299/337 (89%)	278 (93%)	21 (7%)	15	40
30	b2	299/337 (89%)	278 (93%)	21 (7%)	15	40
30	b3	299/337 (89%)	278 (93%)	21 (7%)	15	40
30	b4	299/337 (89%)	278 (93%)	21 (7%)	15	40
All	All	37655/45001 (84%)	36794 (98%)	861 (2%)	53	70

5 of 861 residues with a non-rotameric sidechain are listed below:

Mol	Chain	Res	Type
24	V2	346	THR
25	W2	275	ASP
30	b2	27	SER
24	V2	443	THR
24	V2	341	LEU

Sometimes sidechains can be flipped to improve hydrogen bonding and reduce clashes. 5 of 218 such sidechains are listed below:

Mol	Chain	Res	Type
22	T1	862	HIS
24	V3	536	GLN
28	Z4	410	ASN
22	T2	862	HIS
23	U1	97	HIS

5.3.3 RNA [i](#)

There are no RNA molecules in this entry.

5.4 Non-standard residues in protein, DNA, RNA chains [i](#)

There are no non-standard protein/DNA/RNA residues in this entry.

5.5 Carbohydrates [i](#)

There are no monosaccharides in this entry.

5.6 Ligand geometry [i](#)

There are no ligands in this entry.

5.7 Other polymers [i](#)

There are no such residues in this entry.

5.8 Polymer linkage issues [i](#)

There are no chain breaks in this entry.

6 Map visualisation [i](#)

This section contains visualisations of the EMDB entry EMD-14322. These allow visual inspection of the internal detail of the map and identification of artifacts.

No raw map or half-maps were deposited for this entry and therefore no images, graphs, etc. pertaining to the raw map can be shown.

6.1 Orthogonal projections [i](#)

6.1.1 Primary map

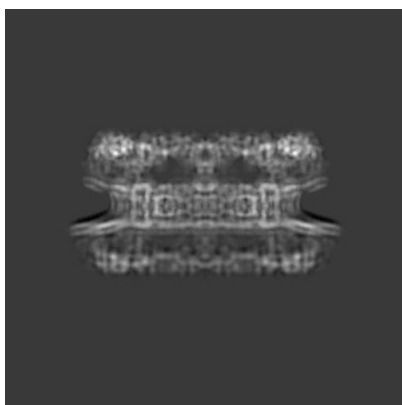

X

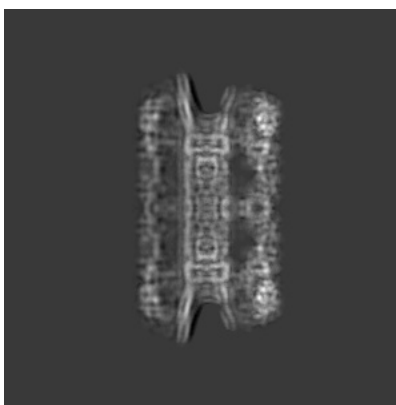

Y

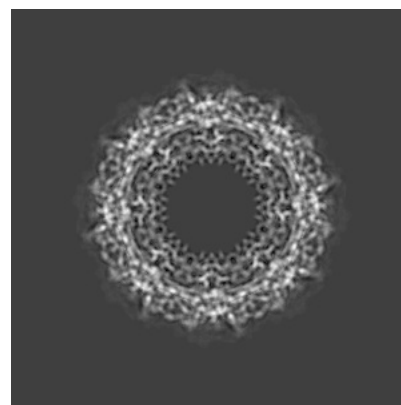

Z

The images above show the map projected in three orthogonal directions.

6.2 Central slices [i](#)

6.2.1 Primary map



X Index: 288



Y Index: 288



Z Index: 288

The images above show central slices of the map in three orthogonal directions.

6.3 Largest variance slices [i](#)

6.3.1 Primary map



X Index: 404



Y Index: 172

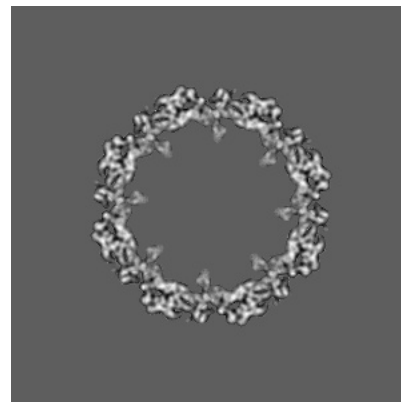

Z Index: 370

The images above show the largest variance slices of the map in three orthogonal directions.

6.4 Orthogonal surface views [i](#)

6.4.1 Primary map

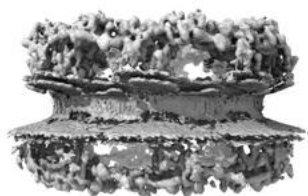

X



Y

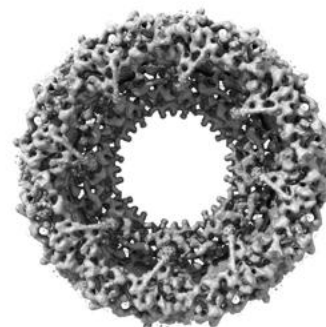

Z

The images above show the 3D surface view of the map at the recommended contour level 3.5. These images, in conjunction with the slice images, may facilitate assessment of whether an appropriate contour level has been provided.

6.5 Mask visualisation

This section was not generated. No masks/segmentation were deposited.

7 Map analysis [i](#)

This section contains the results of statistical analysis of the map.

7.1 Map-value distribution [i](#)

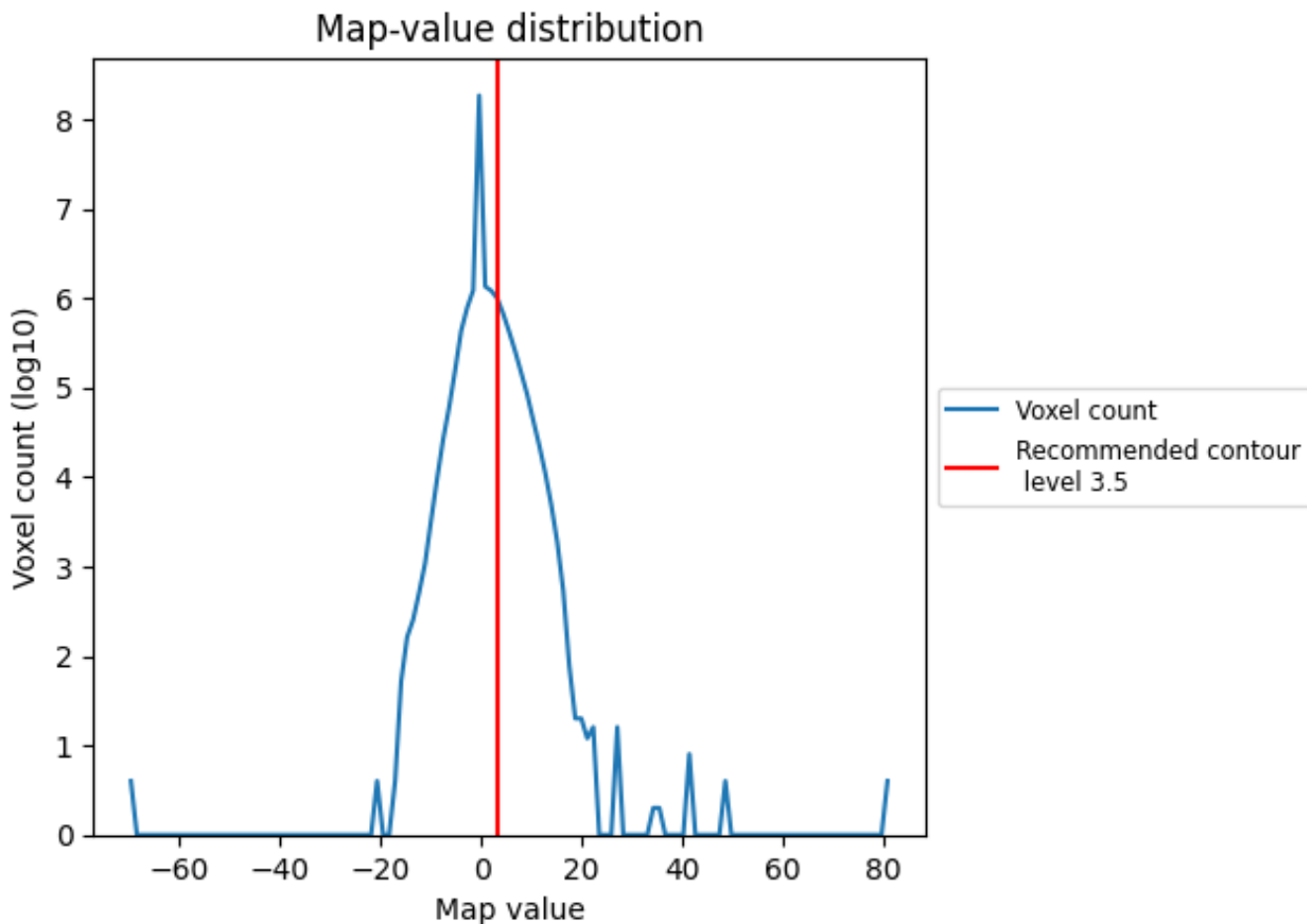

The map-value distribution is plotted in 128 intervals along the x-axis. The y-axis is logarithmic. A spike in this graph at zero usually indicates that the volume has been masked.

7.2 Volume estimate [\(i\)](#)

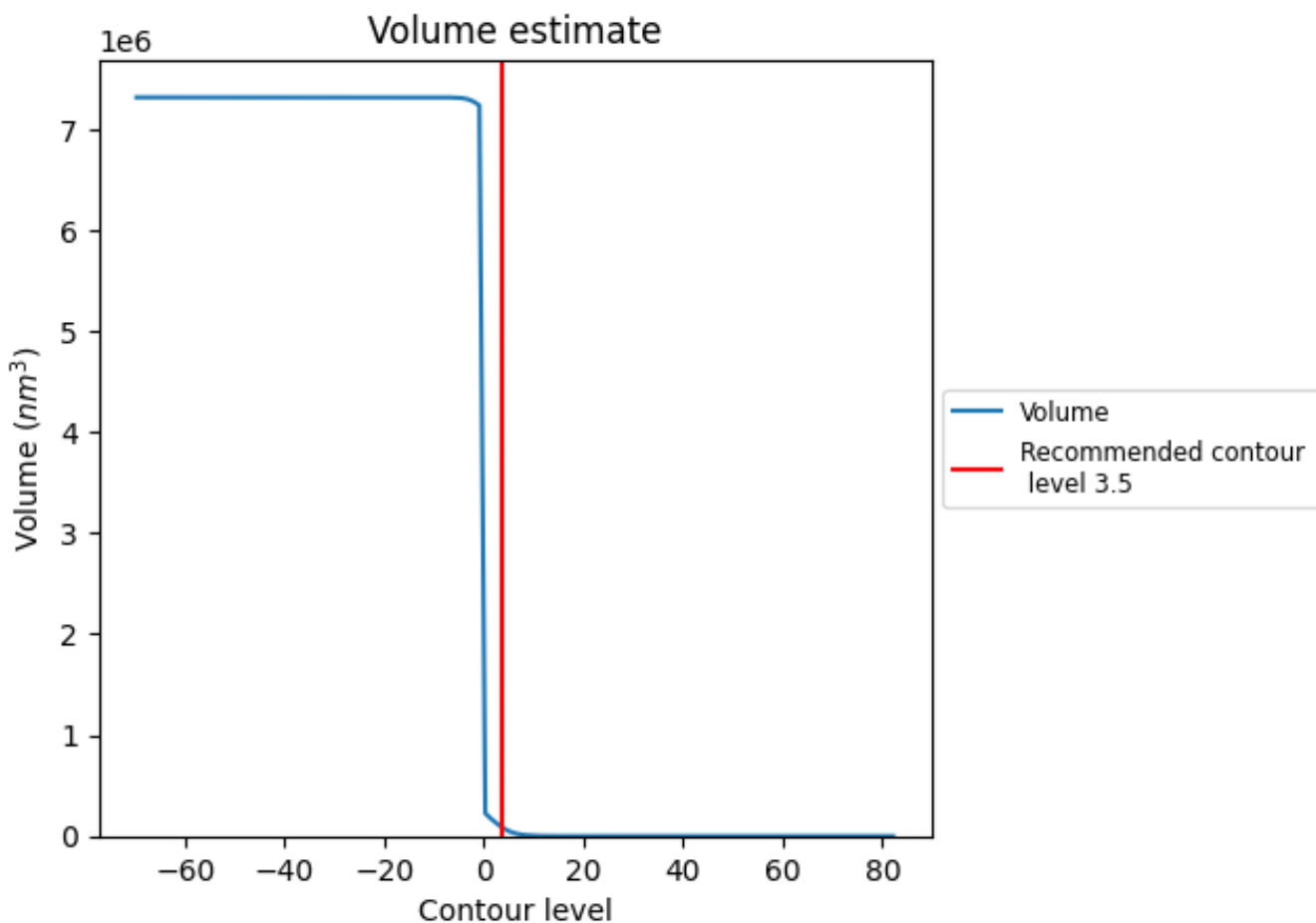

The volume at the recommended contour level is 93549 nm³; this corresponds to an approximate mass of 84505 kDa.

The volume estimate graph shows how the enclosed volume varies with the contour level. The recommended contour level is shown as a vertical line and the intersection between the line and the curve gives the volume of the enclosed surface at the given level.

7.3 Rotationally averaged power spectrum [i](#)

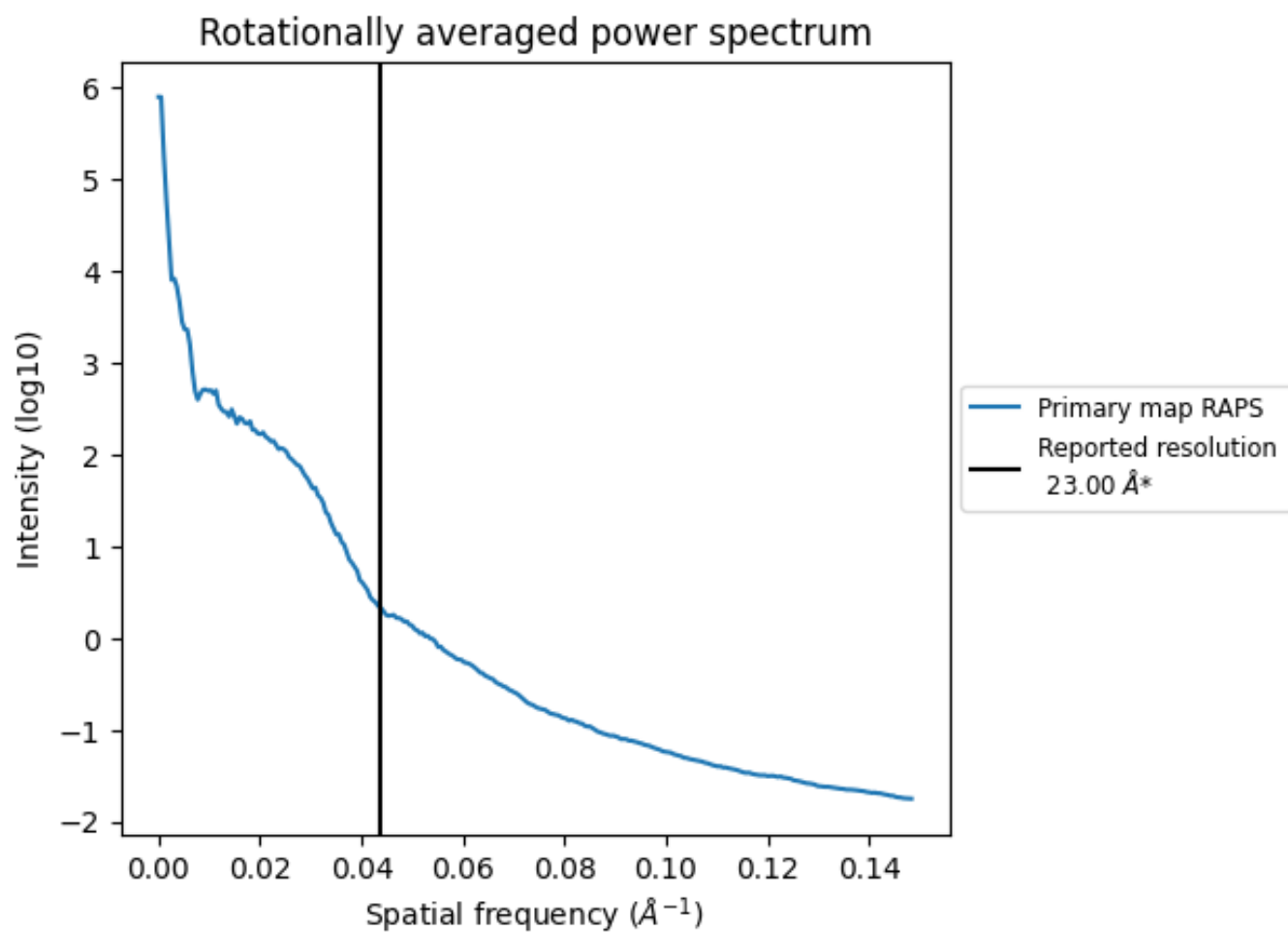

*Reported resolution corresponds to spatial frequency of 0.043 Å⁻¹

8 Fourier-Shell correlation

This section was not generated. No FSC curve or half-maps provided.

9 Map-model fit [i](#)

This section contains information regarding the fit between EMDB map EMD-14322 and PDB model 7TBJ. Per-residue inclusion information can be found in section 3 on page 17.

9.1 Map-model overlays

9.1.1 Map-model overlay [i](#)

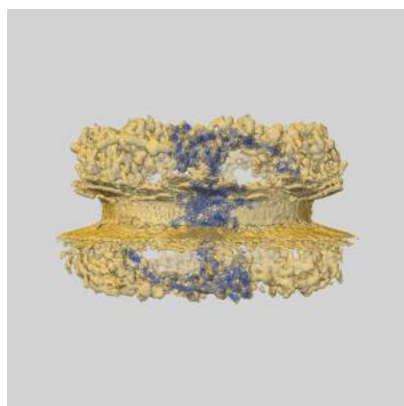

X

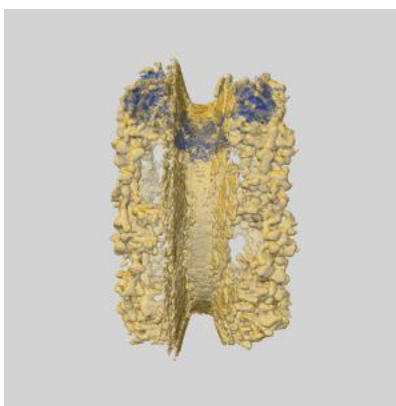

Y

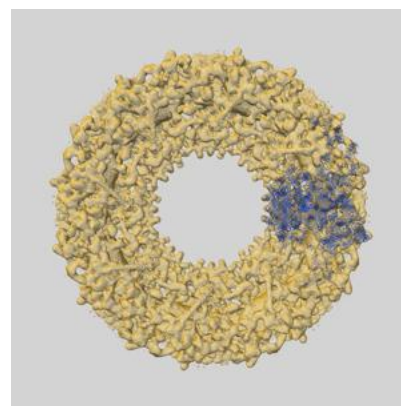

Z

9.1.2 Map-model assembly overlay [i](#)

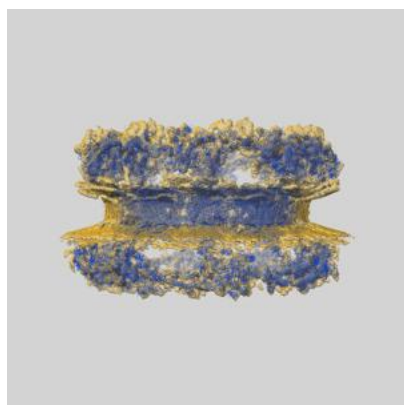

X

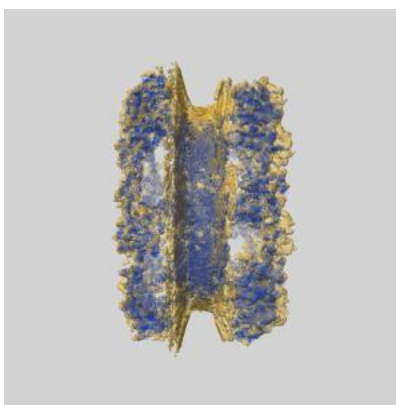

Y

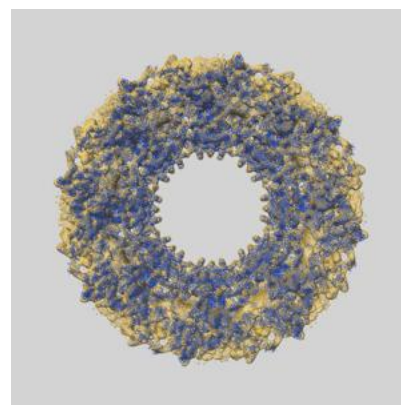

Z

The images above show the 3D surface view of the map at the recommended contour level 3.5 at 50% transparency in yellow overlaid with a ribbon representation of the model coloured in blue. These images allow for the visual assessment of the quality of fit between the atomic model and the map.

9.2 Q-score mapped to coordinate model [\(i\)](#)

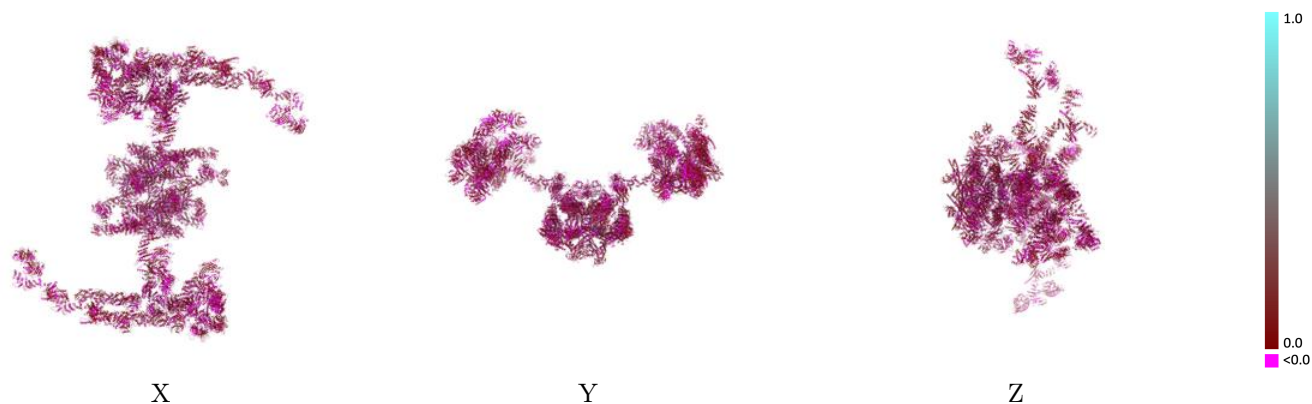

The images above show the model with each residue coloured according to its Q-score. This shows their resolvability in the map with higher Q-score values reflecting better resolvability. Please note: Q-score is calculating the resolvability of atoms, and thus high values are only expected at resolutions at which atoms can be resolved. Low Q-score values may therefore be expected for many entries.

9.3 Atom inclusion mapped to coordinate model [\(i\)](#)

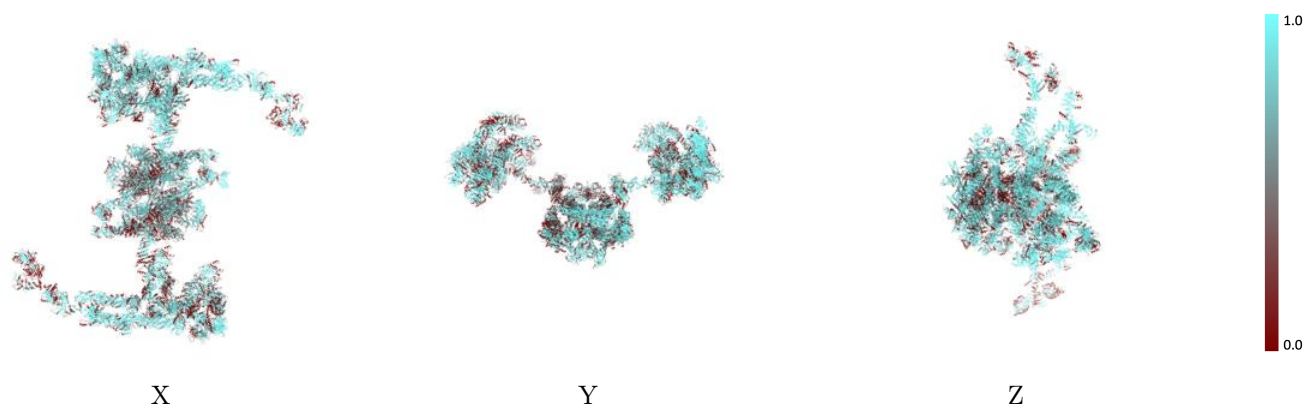

The images above show the model with each residue coloured according to its atom inclusion. This shows to what extent they are inside the map at the recommended contour level (3.5).



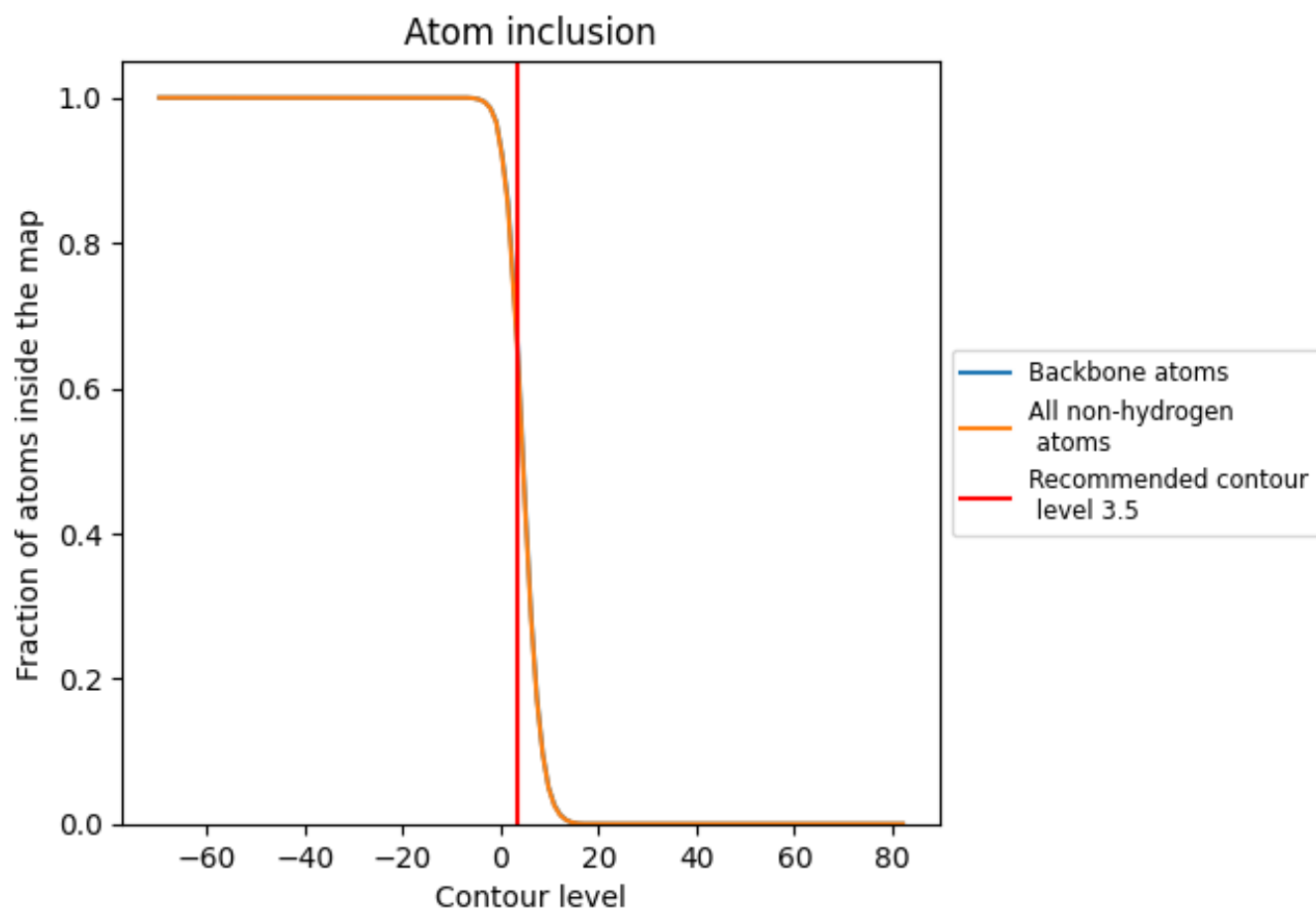



































































9.4 Atom inclusion [i](#)



At the recommended contour level, 66% of all backbone atoms, 65% of all non-hydrogen atoms, are inside the map.

9.5 Map-model fit summary





















































































The table lists the average atom inclusion at the recommended contour level (3.5) and Q-score for the entire model and for each chain.

Chain	Atom inclusion	Q-score
All	 0.6467	 0.0380
A1	 0.6916	 0.0430
A2	 0.3830	 0.0190
A3	 0.6641	 0.0450
A4	 0.4331	 0.0280
A5	 0.7311	 0.0460
A6	 0.4681	 0.0430
B1	 0.0000	 -0.0460
B2	 0.0092	 -0.0370
B3	 0.0000	 0.0070
B4	 0.0917	 0.0130
B5	 0.0826	 -0.0330
B6	 0.0092	 -0.0100
C1	 0.3529	 0.0440
C2	 0.5871	 0.0120
C3	 0.1176	 0.0320
C4	 0.3161	 0.0530
C5	 0.9559	 0.0590
C6	 0.4044	 0.0310
D1	 0.7763	 0.0550
D2	 0.7525	 0.0520
D3	 0.7202	 0.0420
D4	 0.4602	 0.0450
D5	 0.8304	 0.0650
D6	 0.7241	 0.0560
D7	 0.5018	 0.0260
E1	 0.6833	 0.0250
E2	 0.5000	 -0.0320
E3	 0.4000	 0.0590
E4	 0.2333	 0.0450
E5	 0.2833	 -0.0510
E6	 0.6500	 -0.0050
E7	 0.0167	 -0.0360
F1	 0.6834	 0.0410
F2	 0.5174	 0.0400























































































Continued on next page...

Continued from previous page...

Chain	Atom inclusion	Q-score
G1	 0.5246	 -0.0020
G2	 0.4169	 0.0080
H1	 0.4787	 0.0300
H2	 0.3085	 0.0530
I1	 0.6302	 0.0290
I2	 0.6244	 0.0350
I3	 0.7452	 0.0450
I4	 0.5337	 0.0360
I5	 0.7087	 0.0330
J1	 0.5578	 0.0060
J2	 0.6694	 0.0090
J3	 0.5801	 -0.0120
J4	 0.5436	 0.0240
J5	 0.7059	 0.0110
K1	 0.1250	 -0.0050
K2	 0.1250	 -0.0300
K3	 0.3750	 0.0010
K4	 0.0139	 -0.0060
K5	 0.3611	 -0.0030
L1	 0.0000	 -0.0780
L2	 0.0000	 -0.0120
L3	 0.2667	 -0.0820
L4	 0.0000	 -0.0270
L5	 0.8000	 0.0520
M1	 0.7065	 0.0410
M2	 0.7548	 0.0580
M3	 0.6620	 0.0360
M4	 0.7623	 0.0690
N1	 0.7249	 0.0480
N2	 0.7653	 0.0650
N3	 0.6888	 0.0400
N4	 0.7227	 0.0560
O1	 0.7135	 0.0490
O2	 0.6492	 0.0480
O3	 0.7229	 0.0560
O4	 0.6279	 0.0490
P1	 0.7624	 0.0680
P2	 0.7862	 0.0620
P3	 0.8122	 0.0670
P4	 0.7251	 0.0540
Q1	 0.9922	 0.0740
Q2	 0.9884	 0.0710









Continued on next page...

Continued from previous page...

Chain	Atom inclusion	Q-score
Q3	 0.9688	 0.0810
Q4	 0.9568	 0.0660
R1	 0.5875	 0.0100
R2	 0.6931	 0.0350
R3	 0.4686	 0.0400
R4	 0.5644	 0.0110
S1	 0.5781	 0.0370
S2	 0.6117	 0.0320
S3	 0.4214	 0.0320
S4	 0.4224	 0.0280
T1	 0.7541	 0.0460
T2	 0.7923	 0.0580
T3	 0.6969	 0.0410
T4	 0.7122	 0.0520
U1	 0.8161	 0.0450
U2	 0.8907	 0.0620
U3	 0.7916	 0.0490
U4	 0.7940	 0.0550
V1	 0.8959	 0.0590
V2	 0.8698	 0.0560
V3	 0.8052	 0.0570
V4	 0.7489	 0.0440
W1	 0.8666	 0.0440
W2	 0.7865	 0.0340
W3	 0.8115	 0.0500
W4	 0.6560	 0.0230
X1	 0.7948	 0.0330
X2	 0.8330	 0.0380
X3	 0.6600	 0.0310
X4	 0.5716	 0.0220
Y1	 0.6241	 0.0280
Y2	 0.6589	 0.0230
Y3	 0.5471	 0.0220
Y4	 0.5647	 0.0250
Z1	 0.6386	 0.0160
Z2	 0.7333	 0.0240
Z3	 0.4488	 0.0190
Z4	 0.5051	 0.0200
a1	 0.9263	 0.0530
a2	 0.7788	 0.0430
a3	 0.8273	 0.0500
a4	 0.7589	 0.0490

Continued on next page...

Continued from previous page...

Chain	Atom inclusion	Q-score
b1	 0.6778	 0.0320
b2	 0.5547	 0.0240
b3	 0.5231	 0.0100
b4	 0.5681	 0.0180