



wwPDB EM Validation Summary Report ⓘ

Dec 11, 2022 – 08:18 am GMT

PDB ID : 6RXX
EMDB ID : EMD-10054
Title : Cryo-EM structure of the 90S pre-ribosome (Kre33-Noc4) from *Chaetomium thermophilum*, state C, Poly-Ala
Authors : Cheng, J.; Kellner, N.; Griesel, S.; Berninghausen, O.; Beckmann, R.; Hurt, E.
Deposited on : 2019-06-10
Resolution : 7.10 Å(reported)

This is a wwPDB EM Validation Summary Report for a publicly released PDB entry.

We welcome your comments at validation@mail.wwpdb.org

A user guide is available at

<https://www.wwpdb.org/validation/2017/EMValidationReportHelp>

with specific help available everywhere you see the ⓘ symbol.

The types of validation reports are described at

<http://www.wwpdb.org/validation/2017/FAQs#types>.

The following versions of software and data (see [references ⓘ](#)) were used in the production of this report:

EMDB validation analysis : 0.0.1.dev43
MolProbity : 4.02b-467
Percentile statistics : 20191225.v01 (using entries in the PDB archive December 25th 2019)
MapQ : 1.9.9
Ideal geometry (proteins) : Engh & Huber (2001)
Ideal geometry (DNA, RNA) : Parkinson et al. (1996)
Validation Pipeline (wwPDB-VP) : 2.31.3

1 Overall quality at a glance

The following experimental techniques were used to determine the structure:
ELECTRON MICROSCOPY

The reported resolution of this entry is 7.10 Å.

Percentile scores (ranging between 0-100) for global validation metrics of the entry are shown in the following graphic. The table shows the number of entries on which the scores are based.

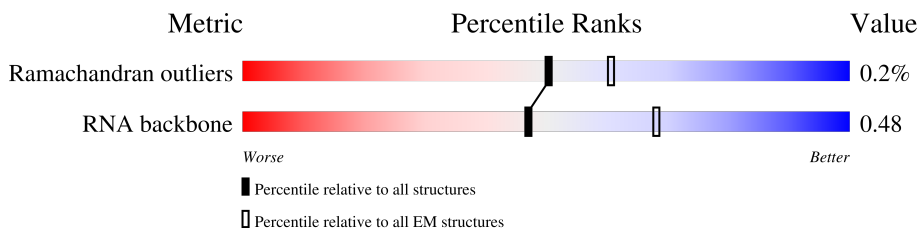

Metric	Whole archive (#Entries)	EM structures (#Entries)
Ramachandran outliers	154571	4023
RNA backbone	4643	859

The table below summarises the geometric issues observed across the polymeric chains and their fit to the map. The red, orange, yellow and green segments of the bar indicate the fraction of residues that contain outliers for ≥ 3 , 2, 1 and 0 types of geometric quality criteria respectively. A grey segment represents the fraction of residues that are not modelled. The numeric value for each fraction is indicated below the corresponding segment, with a dot representing fractions $\leq 5\%$. The upper red bar (where present) indicates the fraction of residues that have poor fit to the EM map (all-atom inclusion $< 40\%$). The numeric value is given above the bar.

Mol	Chain	Length	Quality of chain
1	UA	904	
2	UC	648	
3	UF	414	
4	UG	558	
5	UK	270	
6	UL	962	
7	UM	912	
8	UN	938	
9	UR	618	











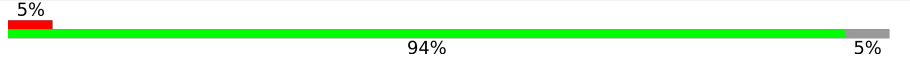
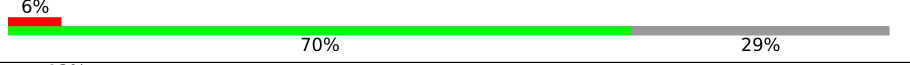

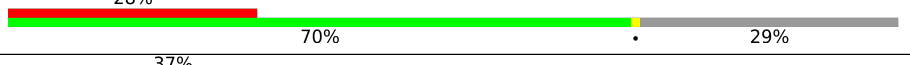
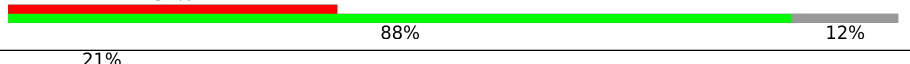
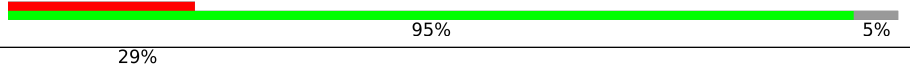

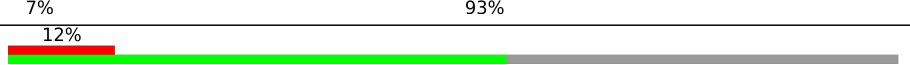
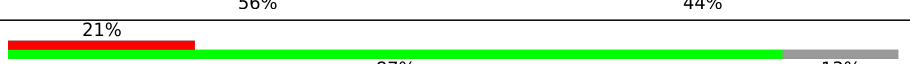

Continued on next page...

Continued from previous page...

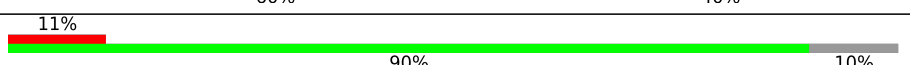
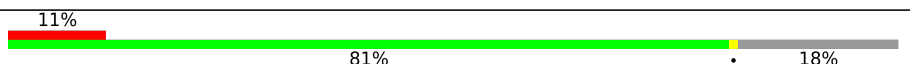
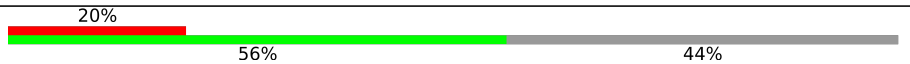
Mol	Chain	Length	Quality of chain
10	UU	1049	7% 86% 14%
11	UX	193	26% 98% .
12	CJ	183	15% 98% .
13	CK	297	17% 100%
14	CL	785	6% 29% 71%
15	CM	446	5% 100%
16	CN	252	28% 90% 10%
16	CO	252	33% 84% 15%
17	CP	322	31% 62% 38%
18	CQ	259	54% 67% 32%
19	Ca	255	16% 88% 12%
20	Cc	212	6% 90% 9%
21	Ce	203	19% 78% 22%
22	Cg	190	13% 84% 16%
23	Ch	151	14% 93% 6% ..
24	Ci	150	17% 77% 23%
25	Cj	143	14% 88% 12%
26	Cm	130	11% 97% .
27	Cn	145	. 66% 34%
28	Cp	68	7% 90% 10%
29	Cq	82	21% 95% ...
30	CU	311	48% 57% 43%
31	C1	1859	9% 41% 21% 34%
32	UV	1171	37% 90% 9%
33	CV	322	20% 45% 54%

Continued on next page...

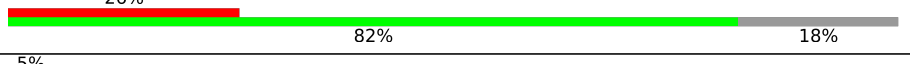
Continued from previous page...

Mol	Chain	Length	Quality of chain
34	Cl	156	
35	CH	411	
36	CI	1163	
37	CR	1073	
37	CS	1073	
38	Cb	264	
39	Cd	239	
40	Cf	202	
41	Ck	161	
42	Co	136	
43	CW	668	
44	UT	2612	
45	CZ	609	
46	UB	907	
47	UD	884	
48	UJ	1802	
49	UO	557	
50	UQ	960	
51	CX	480	
52	UE	410	
52	UI	410	
53	UP	364	
54	UH	930	
55	US	549	
56	CA	313	

Continued on next page...

Continued from previous page...

Mol	Chain	Length	Quality of chain
56	CB	313	
57	CC	523	
58	CD	582	
59	CE	127	
59	CF	127	
60	CG	630	
61	CT	203	
62	C2	232	
63	Cr	153	

2 Entry composition [i](#)

There are 64 unique types of molecules in this entry. The entry contains 146382 atoms, of which 0 are hydrogens and 0 are deuteriums.

In the tables below, the AltConf column contains the number of residues with at least one atom in alternate conformation and the Trace column contains the number of residues modelled with at most 2 atoms.

- Molecule 1 is a protein called Periodic tryptophan protein 2-like protein.

Mol	Chain	Residues	Atoms				AltConf	Trace
			Total	C	N	O		
1	UA	839	4136	2458	839	839	0	0

- Molecule 2 is a protein called Utp3.

Mol	Chain	Residues	Atoms				AltConf	Trace
			Total	C	N	O		
2	UC	74	361	213	74	74	0	0

- Molecule 3 is a protein called Utp6.

Mol	Chain	Residues	Atoms				AltConf	Trace
			Total	C	N	O		
3	UF	331	1644	982	331	331	0	0

- Molecule 4 is a protein called Utp7.

Mol	Chain	Residues	Atoms				AltConf	Trace
			Total	C	N	O		
4	UG	479	2361	1403	479	479	0	0

- Molecule 5 is a protein called U3 small nucleolar RNA-associated protein 11.

Mol	Chain	Residues	Atoms				AltConf	Trace
			Total	C	N	O		
5	UK	217	1070	636	217	217	0	0

- Molecule 6 is a protein called Utp12.

Mol	Chain	Residues	Atoms				AltConf	Trace
			Total	C	N	O		
6	UL	785	3877	2307	785	785	0	0

- Molecule 7 is a protein called Utp13.

Mol	Chain	Residues	Atoms				AltConf	Trace
			Total	C	N	O		
7	UM	729	3602	2144	729	729	0	0

- Molecule 8 is a protein called Utp14.

Mol	Chain	Residues	Atoms				AltConf	Trace
			Total	C	N	O		
8	UN	177	880	526	177	177	0	0

- Molecule 9 is a protein called Utp18.

Mol	Chain	Residues	Atoms				AltConf	Trace
			Total	C	N	O		
9	UR	447	2198	1304	447	447	0	0

- Molecule 10 is a protein called Putative U3 snoRNP protein.

Mol	Chain	Residues	Atoms				AltConf	Trace
			Total	C	N	O		
10	UU	902	4424	2620	902	902	0	0

- Molecule 11 is a protein called Utp24.

Mol	Chain	Residues	Atoms				AltConf	Trace
			Total	C	N	O		
11	UX	190	942	562	190	190	0	0

- Molecule 12 is a protein called Imp3.

Mol	Chain	Residues	Atoms				AltConf	Trace
			Total	C	N	O		
12	CJ	179	890	532	179	179	0	0

- Molecule 13 is a protein called Putative U3 small nucleolar ribonucleoprotein.

Mol	Chain	Residues	Atoms				AltConf	Trace
			Total	C	N	O		
13	CK	297	1472	878	297	297	0	0

- Molecule 14 is a protein called Putative U3 small nucleolar ribonucleoprotein protein.

Mol	Chain	Residues	Atoms				AltConf	Trace
14	CL	231	Total	C	N	O	0	0
			1142	680	231	231		

- Molecule 15 is a protein called Sof1.

Mol	Chain	Residues	Atoms				AltConf	Trace
15	CM	445	Total	C	N	O	0	0
			2201	1311	445	445		

- Molecule 16 is a protein called Emg1.

Mol	Chain	Residues	Atoms				AltConf	Trace
16	CN	226	Total	C	N	O	0	0
			1122	670	226	226		
16	CO	215	Total	C	N	O	0	0
			1067	637	215	215		

- Molecule 17 is a protein called KRR1 small subunit processome component.

Mol	Chain	Residues	Atoms				AltConf	Trace
17	CP	201	Total	C	N	O	0	0
			995	593	201	201		

- Molecule 18 is a protein called Pre-rRNA-processing protein PNO1.

Mol	Chain	Residues	Atoms				AltConf	Trace
18	CQ	175	Total	C	N	O	0	0
			864	514	175	175		

- Molecule 19 is a protein called 40S ribosomal protein S1.

Mol	Chain	Residues	Atoms				AltConf	Trace
19	Ca	225	Total	C	N	O	0	0
			1115	665	225	225		

- Molecule 20 is a protein called 40S ribosomal protein s5-like protein.

Mol	Chain	Residues	Atoms				AltConf	Trace
20	Cc	192	Total	C	N	O	0	0
			953	569	192	192		

- Molecule 21 is a protein called 40S ribosomal protein S7.

Mol	Chain	Residues	Atoms				AltConf	Trace
21	Ce	159	Total	C	N	O	0	0
			786	468	159	159		

- Molecule 22 is a protein called 40S ribosomal protein s9-like protein.

Mol	Chain	Residues	Atoms				AltConf	Trace
22	Cg	159	Total	C	N	O	0	0
			785	467	159	159		

- Molecule 23 is a protein called 40S ribosomal protein S13-like protein.

Mol	Chain	Residues	Atoms				AltConf	Trace
23	Ch	150	Total	C	N	O	0	0
			741	441	150	150		

- Molecule 24 is a protein called 40S ribosomal protein S14-like protein.

Mol	Chain	Residues	Atoms				AltConf	Trace
24	Ci	115	Total	C	N	O	0	0
			563	333	115	115		

- Molecule 25 is a protein called 40S ribosomal protein S16-like protein.

Mol	Chain	Residues	Atoms				AltConf	Trace
25	Cj	126	Total	C	N	O	0	0
			622	370	126	126		

- Molecule 26 is a protein called 40S ribosomal protein S22-like protein.

Mol	Chain	Residues	Atoms				AltConf	Trace
26	Cm	126	Total	C	N	O	0	0
			620	368	126	126		

- Molecule 27 is a protein called 40S ribosomal protein s23-like protein.

Mol	Chain	Residues	Atoms				AltConf	Trace
27	Cn	96	Total	C	N	O	0	0
			469	277	96	96		

- Molecule 28 is a protein called 40S ribosomal protein S28-like protein.

Mol	Chain	Residues	Atoms				AltConf	Trace
			Total	C	N	O		
28	Cp	61	300	178	61	61	0	0

- Molecule 29 is a protein called Ribosomal protein s27-like protein.

Mol	Chain	Residues	Atoms				AltConf	Trace
			Total	C	N	O		
29	Cq	81	400	238	81	81	0	0

- Molecule 30 is a protein called Faf1.

Mol	Chain	Residues	Atoms				AltConf	Trace
			Total	C	N	O		
30	CU	176	871	519	176	176	0	0

- Molecule 31 is a RNA chain called 35S ribosomal RNA.

Mol	Chain	Residues	Atoms					AltConf	Trace
			Total	C	N	O	P		
31	C1	1221	26044	11631	4650	8542	1221	0	0

- Molecule 32 is a protein called U3 small nucleolar RNA-associated protein 22.

Mol	Chain	Residues	Atoms				AltConf	Trace
			Total	C	N	O		
32	UV	1061	5244	3122	1061	1061	0	0

- Molecule 33 is a protein called Rrp7.

Mol	Chain	Residues	Atoms				AltConf	Trace
			Total	C	N	O		
33	CV	148	732	436	148	148	0	0

- Molecule 34 is a protein called Putative ribosomal protein.

Mol	Chain	Residues	Atoms				AltConf	Trace
			Total	C	N	O		
34	Cl	80	395	235	80	80	0	0

- Molecule 35 is a protein called RNA 3'-terminal phosphate cyclase-like protein.

Mol	Chain	Residues	Atoms				AltConf	Trace
			Total	C	N	O		
35	CH	389	1902	1124	389	389	0	0

- Molecule 36 is a protein called Bms1.

Mol	Chain	Residues	Atoms				AltConf	Trace
			Total	C	N	O		
36	CI	822	4061	2417	822	822	0	0

- Molecule 37 is a protein called Kre33.

Mol	Chain	Residues	Atoms				AltConf	Trace
			Total	C	N	O		
37	CR	760	3755	2235	760	760	0	0
37	CS	760	3755	2235	760	760	0	0

- Molecule 38 is a protein called 40S ribosomal protein S4.

Mol	Chain	Residues	Atoms				AltConf	Trace
			Total	C	N	O		
38	Cb	232	1140	676	232	232	0	0

- Molecule 39 is a protein called 40S ribosomal protein S6.

Mol	Chain	Residues	Atoms				AltConf	Trace
			Total	C	N	O		
39	Cd	226	1112	660	226	226	0	0

- Molecule 40 is a protein called 40S ribosomal protein S8.

Mol	Chain	Residues	Atoms				AltConf	Trace
			Total	C	N	O		
40	Cf	174	852	504	174	174	0	0

- Molecule 41 is a protein called 40S ribosomal protein S11-like protein.

Mol	Chain	Residues	Atoms				AltConf	Trace
			Total	C	N	O		
41	Ck	140	691	411	140	140	0	0

- Molecule 42 is a protein called 40S ribosomal protein S24.

Mol	Chain	Residues	Atoms				AltConf	Trace
42	Co	92	Total	C	N	O	0	0
			453	269	92	92		

- Molecule 43 is a protein called Ribosome biogenesis protein ENP2.

Mol	Chain	Residues	Atoms				AltConf	Trace
43	CW	382	Total	C	N	O	0	0
			1880	1116	382	382		

- Molecule 44 is a protein called Utp20.

Mol	Chain	Residues	Atoms				AltConf	Trace
44	UT	2018	Total	C	N	O	0	0
			10012	5976	2018	2018		

- Molecule 45 is a protein called Bfr2.

Mol	Chain	Residues	Atoms				AltConf	Trace
45	CZ	42	Total	C	N	O	0	0
			207	123	42	42		

- Molecule 46 is a protein called Utp2.

Mol	Chain	Residues	Atoms				AltConf	Trace
46	UB	508	Total	C	N	O	0	0
			2521	1505	508	508		

- Molecule 47 is a protein called Utp4.

Mol	Chain	Residues	Atoms				AltConf	Trace
47	UD	772	Total	C	N	O	0	0
			3799	2255	772	772		

- Molecule 48 is a protein called UTP10.

Mol	Chain	Residues	Atoms				AltConf	Trace
48	UJ	1090	Total	C	N	O	0	0
			5405	3225	1090	1090		

- Molecule 49 is a protein called Utp15.

Mol	Chain	Residues	Atoms				AltConf	Trace
49	UO	504	Total	C	N	O	0	0
			2486	1478	504	504		

- Molecule 50 is a protein called Utp17.

Mol	Chain	Residues	Atoms				AltConf	Trace
50	UQ	789	Total	C	N	O	0	0
			3899	2321	789	789		

- Molecule 51 is a protein called Enp1.

Mol	Chain	Residues	Atoms				AltConf	Trace
51	CX	267	Total	C	N	O	0	0
			1325	791	267	267		

- Molecule 52 is a protein called Utp5.

Mol	Chain	Residues	Atoms				AltConf	Trace
52	UI	125	Total	C	N	O	0	0
			616	366	125	125		
52	UE	125	Total	C	N	O	0	0
			616	366	125	125		

- Molecule 53 is a protein called Utp16.

Mol	Chain	Residues	Atoms				AltConf	Trace
53	UP	54	Total	C	N	O	0	0
			265	157	54	54		

- Molecule 54 is a protein called Utp8.

Mol	Chain	Residues	Atoms				AltConf	Trace
54	UH	359	Total	C	N	O	0	0
			1771	1053	359	359		

- Molecule 55 is a protein called Noc4.

Mol	Chain	Residues	Atoms				AltConf	Trace
55	US	451	Total	C	N	O	0	0
			2245	1343	451	451		

- Molecule 56 is a protein called Nop1.

Mol	Chain	Residues	Atoms				AltConf	Trace
56	CA	242	Total	C	N	O	0	0
			1189	705	242	242		
56	CB	222	Total	C	N	O	0	0
			1092	648	222	222		

- Molecule 57 is a protein called Putative nucleolar protein.

Mol	Chain	Residues	Atoms				AltConf	Trace
57	CC	387	Total	C	N	O	0	0
			1911	1137	387	387		

- Molecule 58 is a protein called Nop58.

Mol	Chain	Residues	Atoms				AltConf	Trace
58	CD	420	Total	C	N	O	0	0
			2073	1233	420	420		

- Molecule 59 is a protein called Snu13.

Mol	Chain	Residues	Atoms				AltConf	Trace
59	CE	121	Total	C	N	O	0	0
			601	359	121	121		
59	CF	120	Total	C	N	O	0	0
			596	356	120	120		

- Molecule 60 is a protein called Rrp9.

Mol	Chain	Residues	Atoms				AltConf	Trace
60	CG	416	Total	C	N	O	0	0
			2049	1217	416	416		

- Molecule 61 is a protein called Fcf2.

Mol	Chain	Residues	Atoms				AltConf	Trace
61	CT	131	Total	C	N	O	0	0
			647	385	131	131		

- Molecule 62 is a RNA chain called U3 snoRNA.

Mol	Chain	Residues	Atoms					AltConf	Trace
62	C2	229	Total	C	N	O	P	0	0
			4869	2172	851	1617	229		

- Molecule 63 is a protein called 40S ribosomal protein S19-like protein.

Mol	Chain	Residues	Atoms				AltConf	Trace
			Total	C	N	O		
63	Cr	142	697	413	142	142	0	0

- Molecule 64 is ZINC ION (three-letter code: ZN) (formula: Zn).

Mol	Chain	Residues	Atoms		AltConf
			Total	Zn	
64	UX	1	1	1	0
64	Cq	1	1	1	0

3 Residue-property plots [i](#)

These plots are drawn for all protein, RNA, DNA and oligosaccharide chains in the entry. The first graphic for a chain summarises the proportions of the various outlier classes displayed in the second graphic. The second graphic shows the sequence view annotated by issues in geometry and atom inclusion in map density. Residues are color-coded according to the number of geometric quality criteria for which they contain at least one outlier: green = 0, yellow = 1, orange = 2 and red = 3 or more. A red diamond above a residue indicates a poor fit to the EM map for this residue (all-atom inclusion < 40%). Stretches of 2 or more consecutive residues without any outlier are shown as a green connector. Residues present in the sample, but not in the model, are shown in grey.

- Molecule 1: Periodic tryptophan protein 2-like protein

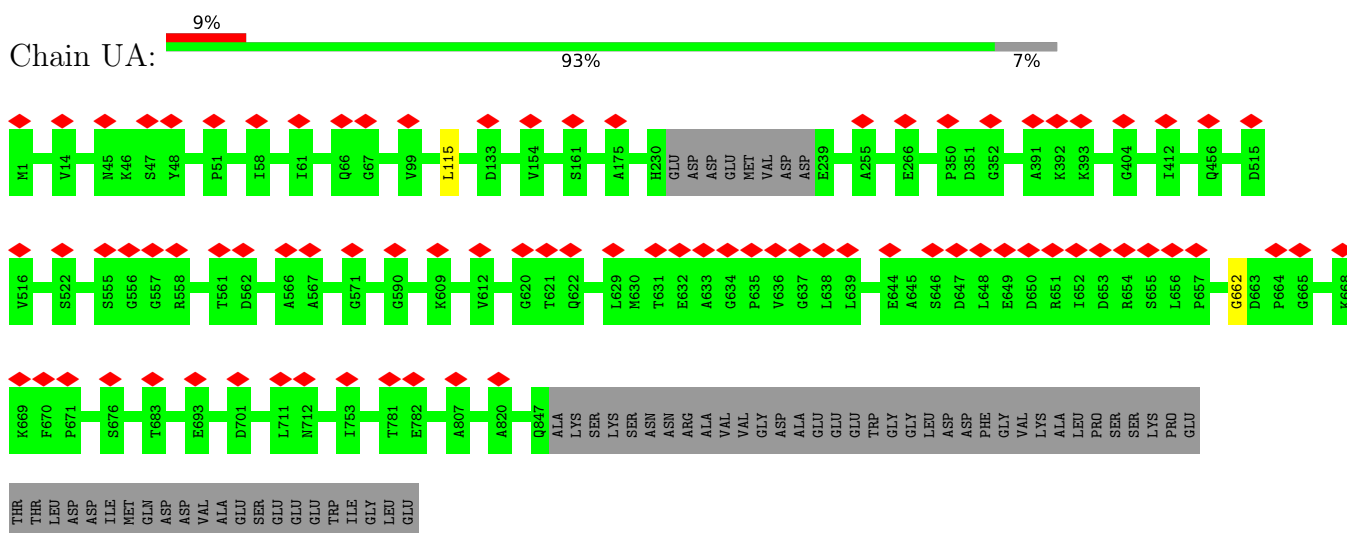

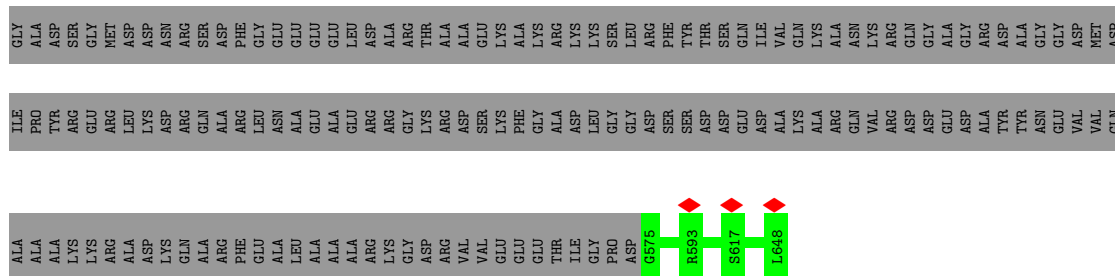

• Molecule 3: Utp6

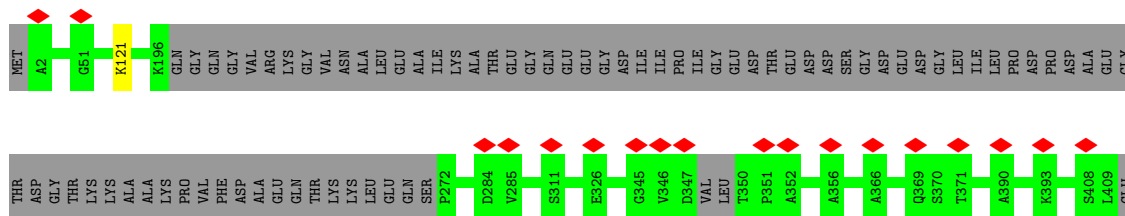
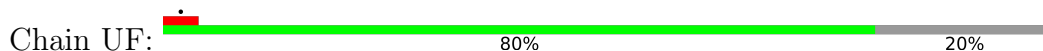

• Molecule 4: Utp7

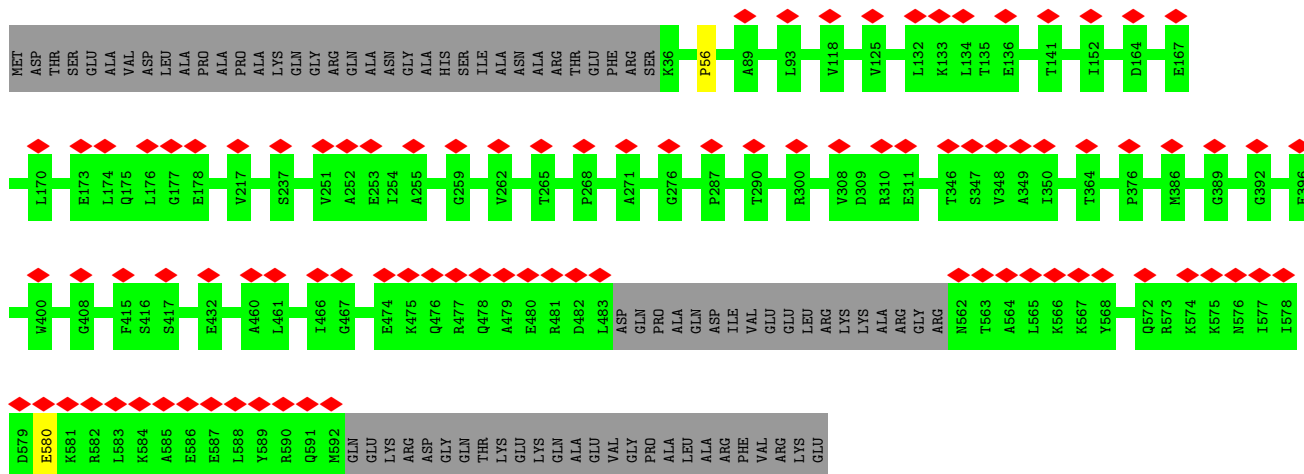
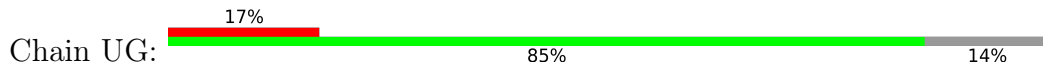

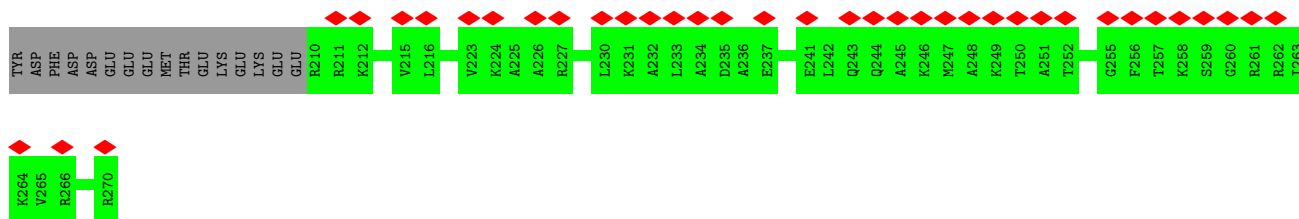

• Molecule 6: Utp12

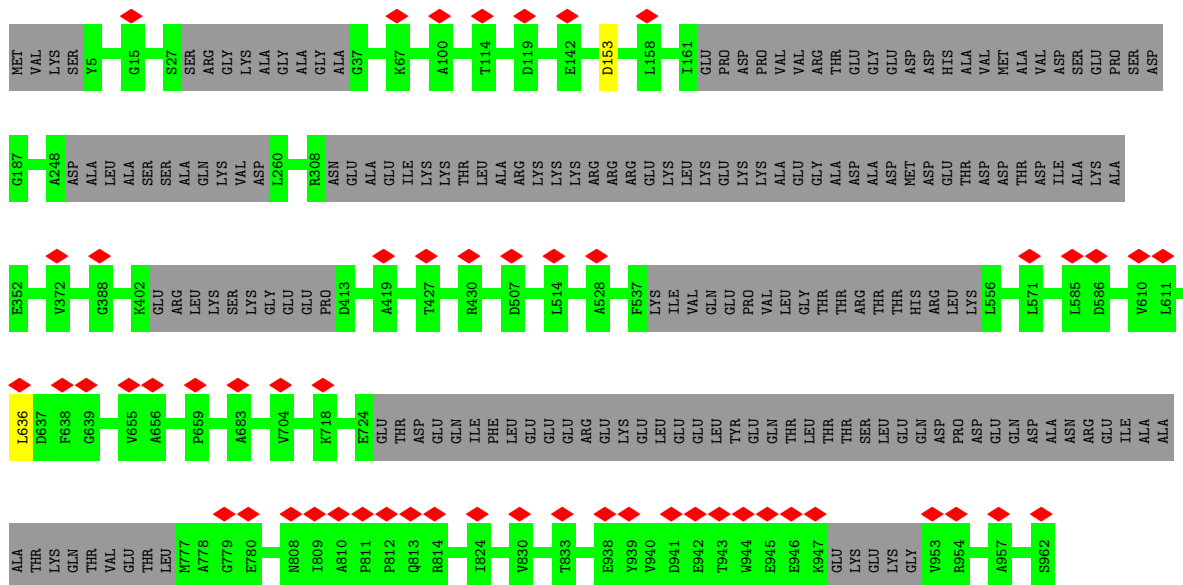
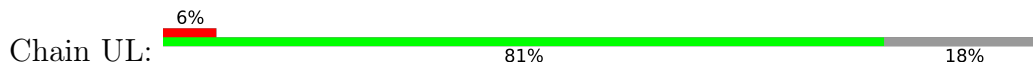

• Molecule 7: Utp13

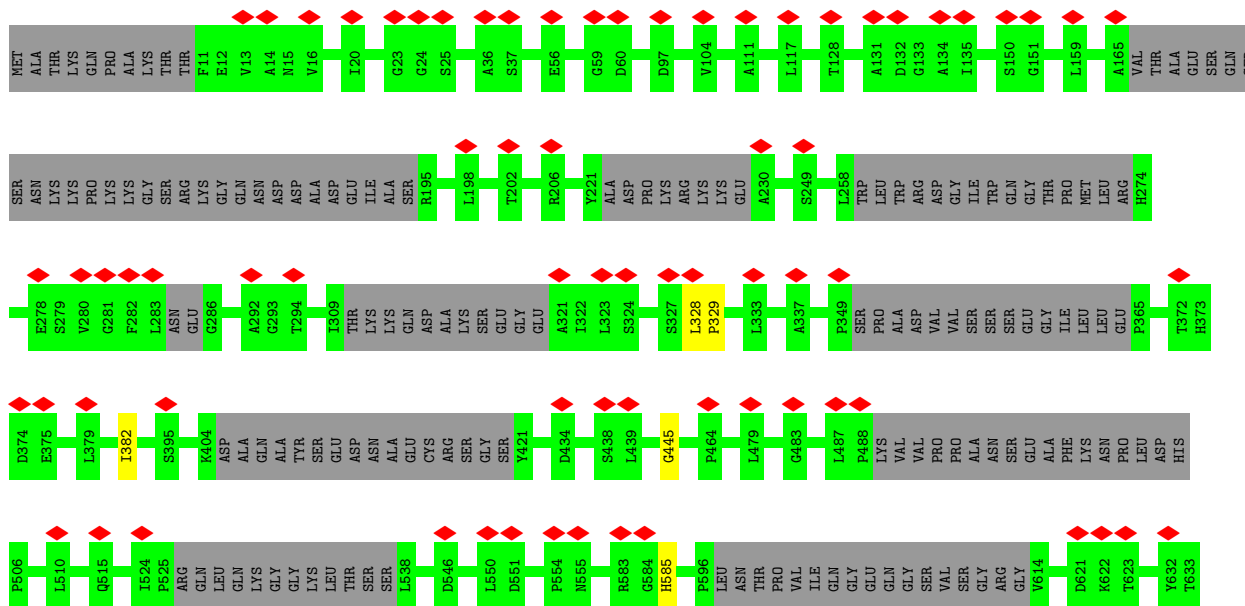
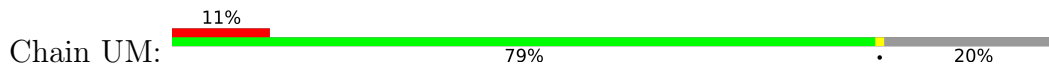

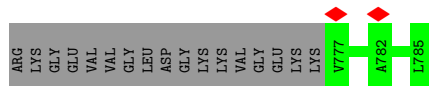
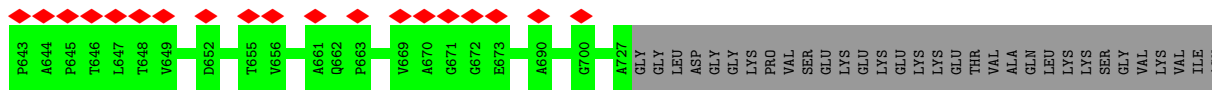

• Molecule 15: Sof1

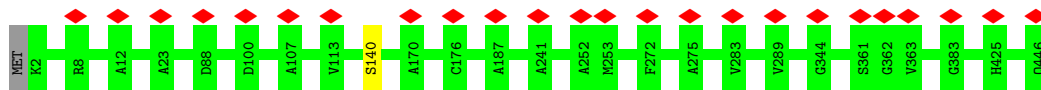

• Molecule 16: Emg1

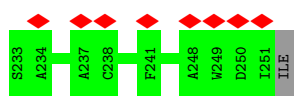
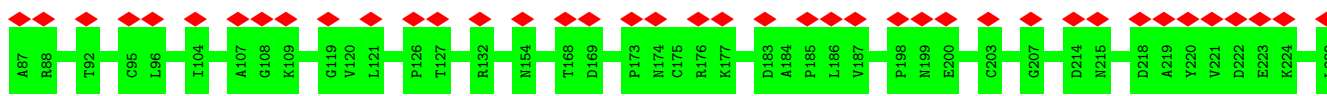
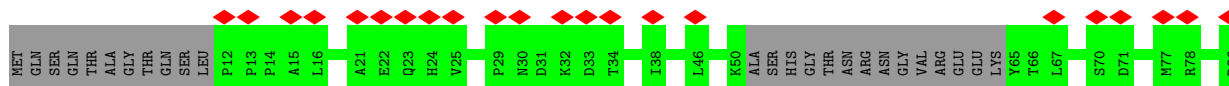
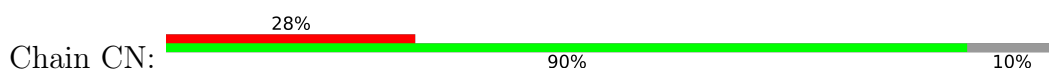

• Molecule 16: Emg1

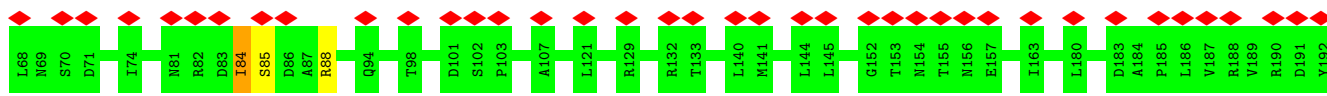
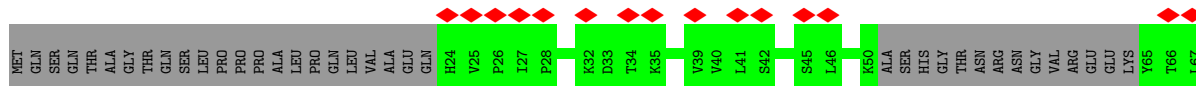
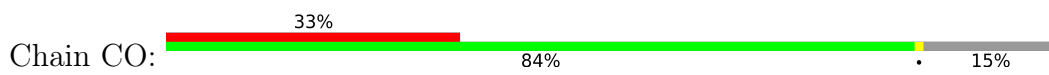

• Molecule 17: KRR1 small subunit processome component



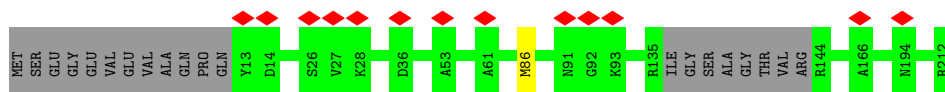

- Molecule 21: 40S ribosomal protein S7

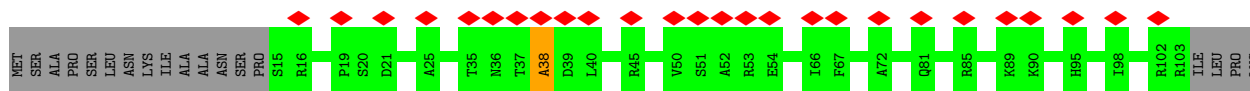
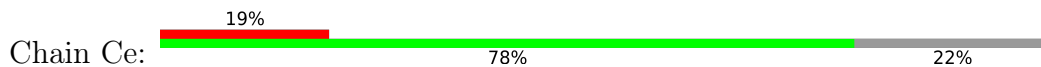

- Molecule 22: 40S ribosomal protein s9-like protein

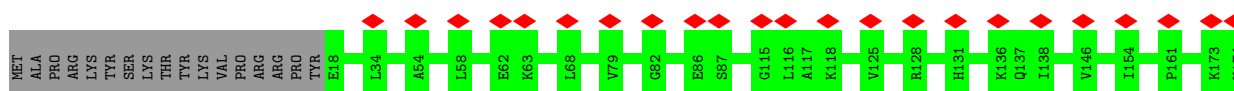
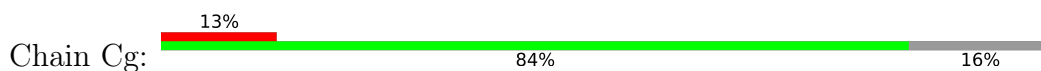

- Molecule 23: 40S ribosomal protein S13-like protein

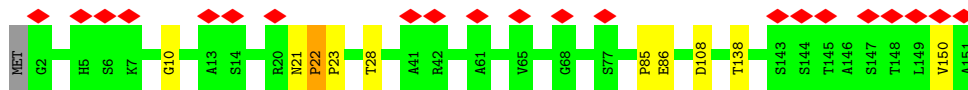

- Molecule 24: 40S ribosomal protein S14-like protein

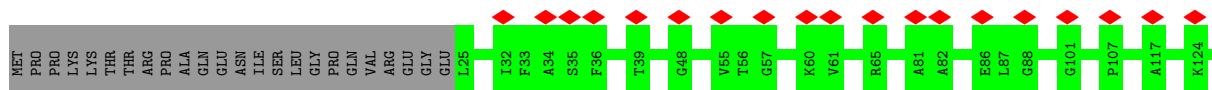
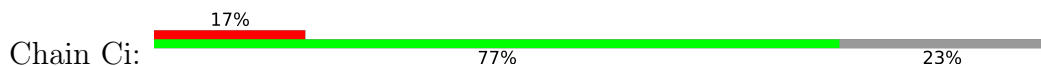

- Molecule 25: 40S ribosomal protein S16-like protein

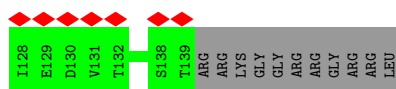
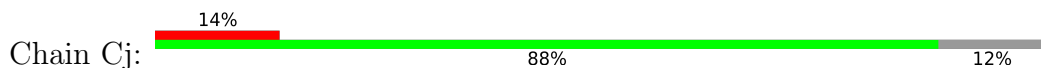

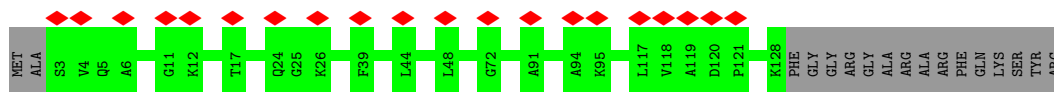

• Molecule 26: 40S ribosomal protein S22-like protein

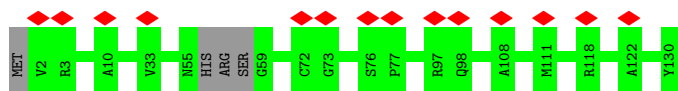

• Molecule 27: 40S ribosomal protein s23-like protein

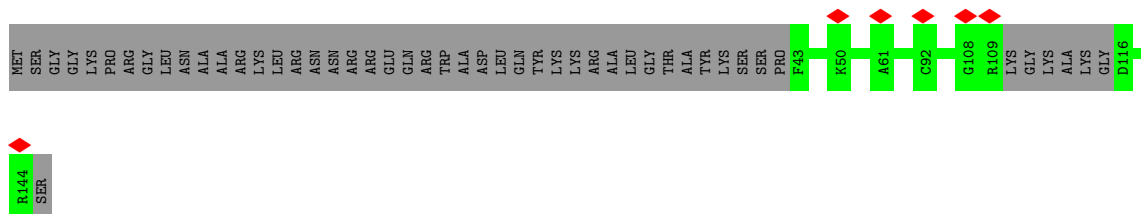

• Molecule 28: 40S ribosomal protein S28-like protein

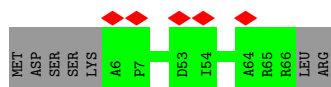

• Molecule 29: Ribosomal protein s27-like protein

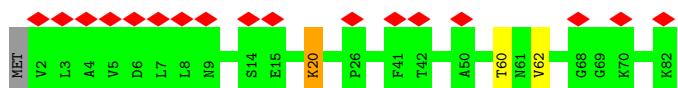

• Molecule 30: Faf1

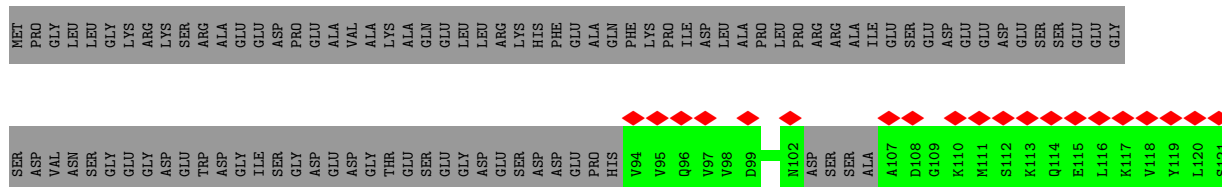

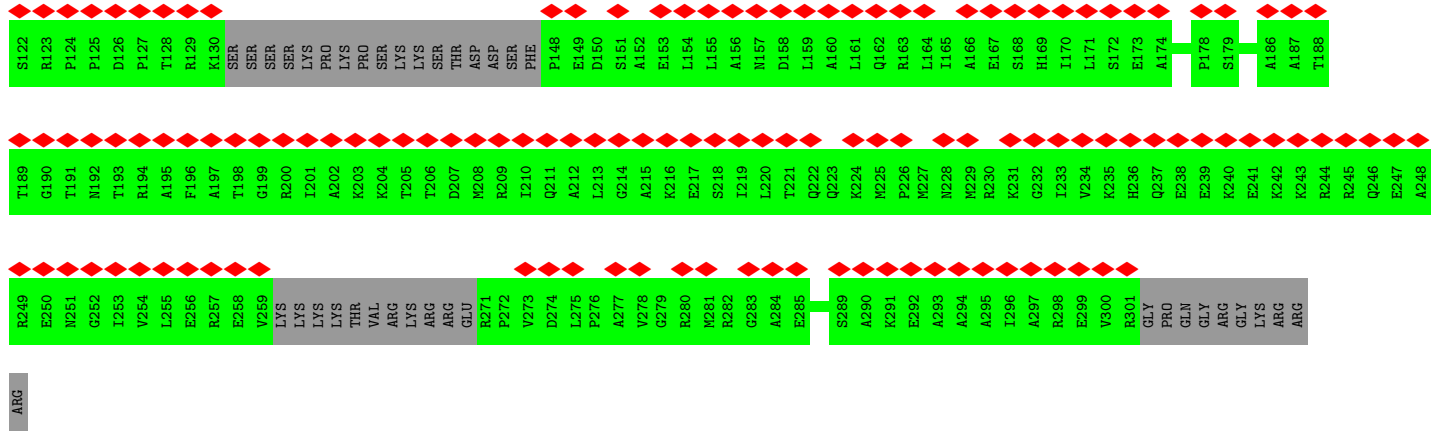

• Molecule 31: 35S ribosomal RNA

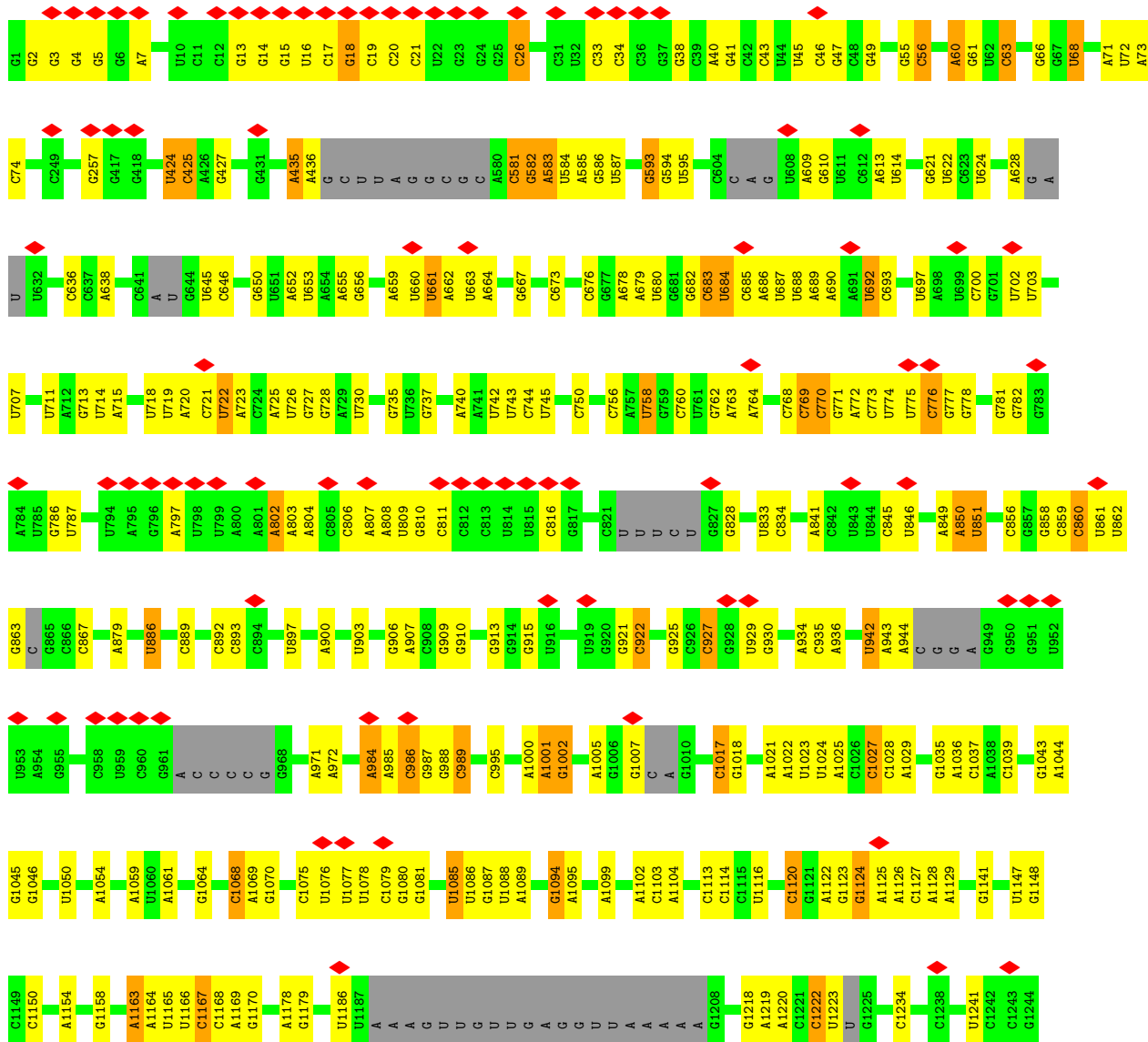

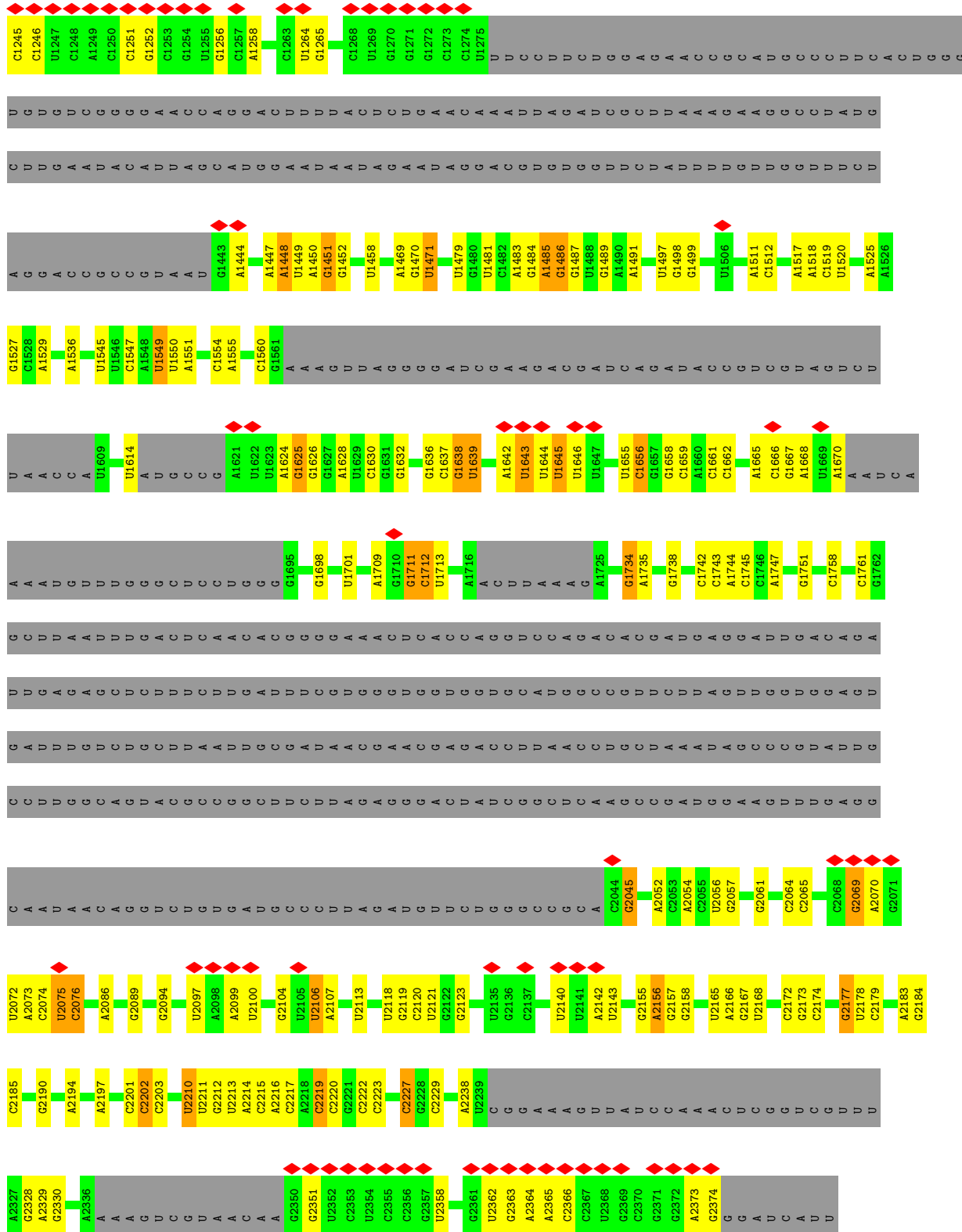

● Molecule 32: U3 small nucleolar RNA-associated protein 22



• Molecule 38: 40S ribosomal protein S4

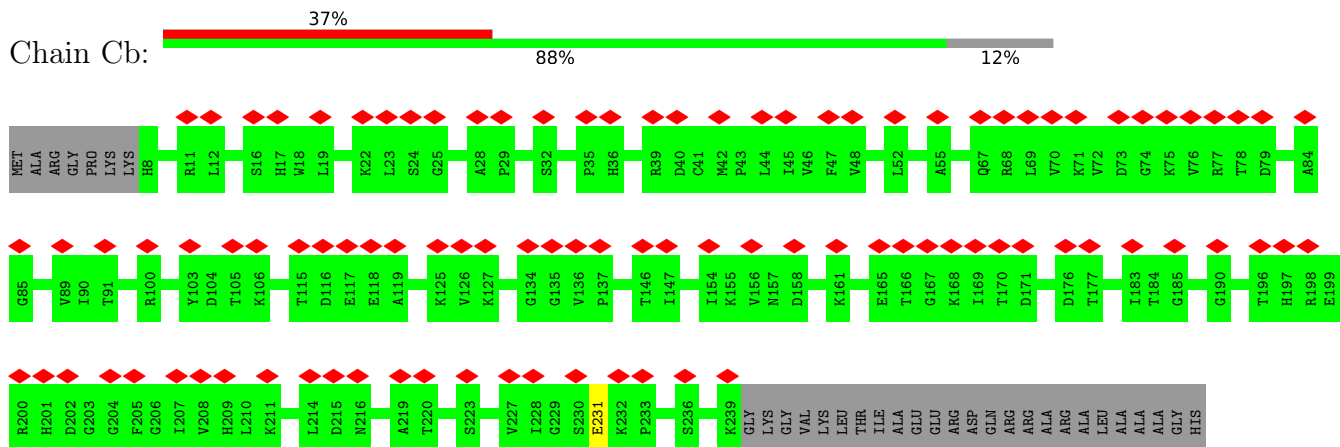

• Molecule 39: 40S ribosomal protein S6

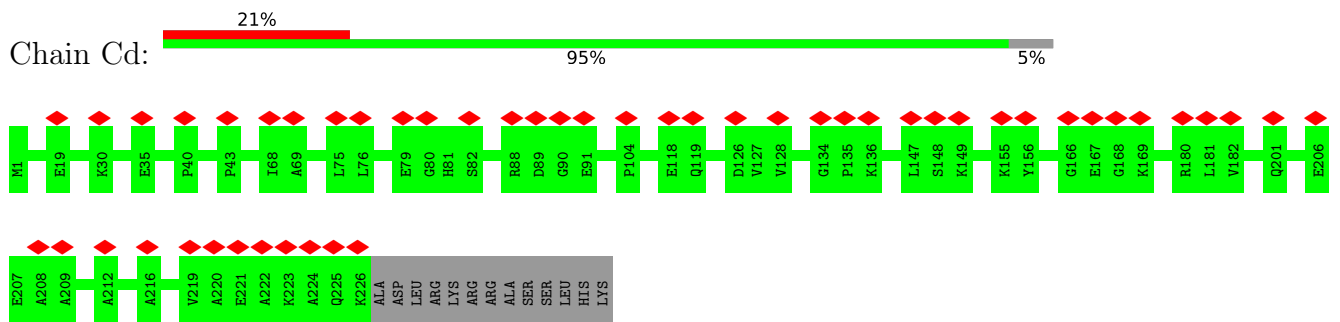

• Molecule 40: 40S ribosomal protein S8

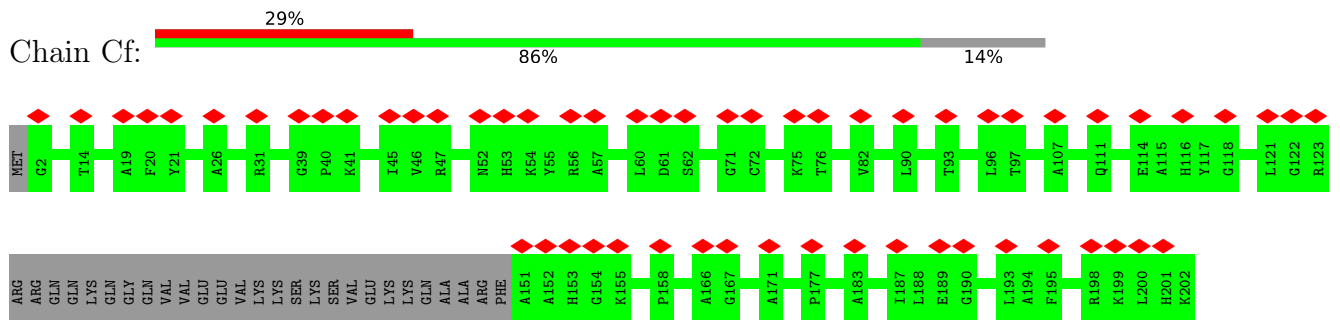

• Molecule 41: 40S ribosomal protein S11-like protein

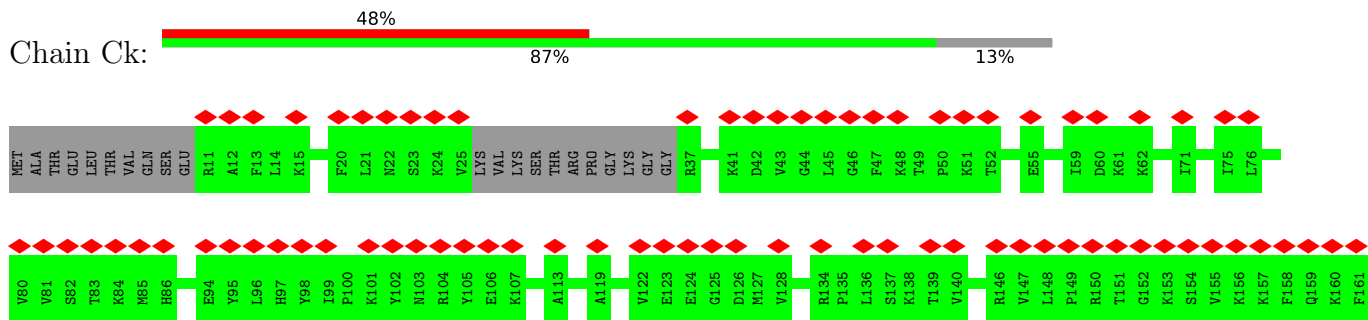

• Molecule 42: 40S ribosomal protein S24

L368	V369	S370	L371	G372	T373	Q374	A375	K376	E379	V380	M381	S399	R400	D404	A405	L406	I407	P408	A409	M410	S411	T412	F413	Q414	T415	T418	K419	E420	M423	K424	D435	Q436	M437	A438	E439	R440	F441	R442	K447	Q450	K451	F452	I453	V454	W457	S458	Q459	G460	M462				
E463	D464	L465	L466	C467	V468	L469	I470	P471	E475	S476	G477	G478	L479	P480	A481	P482	G483	S484	K485	E486	I487	F488	P489	D496	Q497	D507	T508	PHE	PRO	GLU	SER	GLY	PHE	GLY	LYS	ASP	PRO	GLU	TRP	THR	ARG	ASP	LYS	C527	L535	T542	V543	H544	P545	S546	T547	N548	
S549	R550	I551	E552	E553	V554	L555	L556	K557	R564	PRO	SER	SER	SER	LEU	PRO	THR	ASP	A574	N575	L586	R587	K590	A591	P592	G593	S594	D596	P597	S598	A607	F610	L621	Q625	E626	I627	GLU	K628	ALA	LYS	GLY	LYS	ASN	THR	PRO	GLU	SER	ASP	SER	GLY	ALA	GLU		
SER	SER	H645	E646	L651	C654	L655	I656	L659	E665	L668	A669	E675	V676	L677	D678	F679	T680	P681	S683	N684	N685	S688	Q692	E695	M696	P697	Q701	R704	A705	L715	S718	E721	L722	Q722	D723	G736	T739	V740	P741	L742	A743	P744	V745										
M746	A749	M753	M768	I769	D772	D775	W781	S782	G783	P788	ALA	ASP	M792	H793	G794	P795	E800	N803	H806	L807	T808	E809	A813	Q816	G822	E831	G832	Q833	A843	A847	L848	K849	A850	L851	A852	A853	L854	P855	W856	R861													
K864	P867	T873	D874	ASP	GLU	THR	PRO	GLU	ASP	ILE	GLU	GLU	GLU	PRO	GLU	SER	GLY	GLU	G893	S894	V906	F907	S911	R914	V915	L926	L929	L930	G933	Q938	A941	I945	Y956	Q957	E958	E961	K970	L973	T974	P975	L976												
F977	D980	S989	E990	V991	Y1000	A1010	R1020	L1021	A1022	I1023	I1024	R1025	E1030	D1031	S1034	I1038	G1039	L1040	P1042	L1043	R1044	A1045	I1046	R1047	V1048	V1049	D1050	E1051	Q1052	G1053	V1054	R1055	E1056	S1057	V1058	A1060	H1061	K961	P1063	L1064	P1065	P1066	R1067	L1076	V1079	I1080							
L1083	E1088	P1089	L1094	C1101	L1102	C1106	R1107	K1108	L1109	GLY	VAL	SER	ALA	GLU	GLU	PRO	GLU	SER	GLY	G1126	T1136	K1139	S1140	L1141	S1142	F1145	Q1146	M1147	A1148	P1149	D1150	F1151	M1152	L1159	M1160	V1161	K1162	E1163	L1164	I1165	S1166	P1167	R1168	I1169	E1170								
K1171	L1172	E1175	S1176	S1181	A1182	R1185	A1188	T1189	W1190	S1191	S1192	P1198	F1199	L1200	V1202	D1203	K1204	R1205	E1212	S1215	L1216	E1217	K1218	D1229	I1230	L1231	K1232	I1235	N1236	L1237	A1238	E1242	S1245	Q1246	F1247	N1248	E1249	L1250	I1251	K1252	T1253	E1254	L1255	L1256	D1257	P1258	N1259						
T1260	D1261	L1262	I1263	L1264	K1265	T1266	I1267	G1268	G1269	V1270	L1271	H1272	G1273	S1191	Q1274	S1275	E1280	S1283	S1284	A1285	V1286	D1287	T1288	A1293	I1296	E1297	V1298	S1299	S1300	H1301	I1302	Q1303	D1304	M1305	L1306	E1307	I1308	A1309	L1317	V1320	V1324	A1327	I1328	L1338	D1339	D1340	L1341	Q1342	N1343	Q1345			
E1346	L1347	Q1348	R1349	K1350	V1351	Y1352	S1353	T1354	F1359	G1360	F1361	F1362	K1363	D1364	K1365	Q1369	D1376	V1377	F1378	A1379	R1380	L1381	E1382	VAL	W1384	A1385	Q1386	E1387	V1388	S1389	R1393	E1400	GLN	ARG	LEU	ASP	GLU	PRO	D1407	Y1408	M1409	T1410	R1411	L1412	A1413	M1416	S1417	I1418	T1419	K1420	ASP	ARG	ASP
I458	PRO	PHE	L1427	L1428	D1429	Q1430	P1433	L1434	V1435	H1436	M1437	Q1443	E1446	E1447	A1456	D1457	V1469	W1470	A1471	T1472	P1473	D1474	Q1475	A1476	A1477	D1480	V1481	L1482	A1483	M1484	I1485	I1486	L1487	P1488	A1489	I1490	Y1491	A1492	G1493	S1494	R1495	L1496	P1497	S1498	E1499	T1500	R1507	L1516	E1520	L1521			
V1522	ALA	ASP	THR	CYS	LEU	VAL	PRO	GLU	SER	GLU	ASP	SER	ALA	PHE	PHE	HIS	MET	SER	PRO	A1547	V1548	W1549	S1549	R1550	L1555	R1556	V1557	D1563	E1566	F1567	R1568	S1569	K1570	H1571	I1572	S1573	Q1574	I1584	F1585	D1586	ARG	PRO	GLU	GLY	GLY	ASP	ASP	HIS	G1595	A1598			

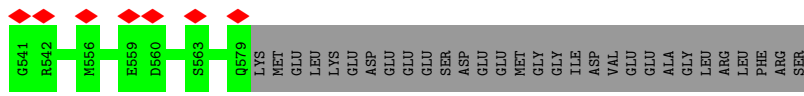
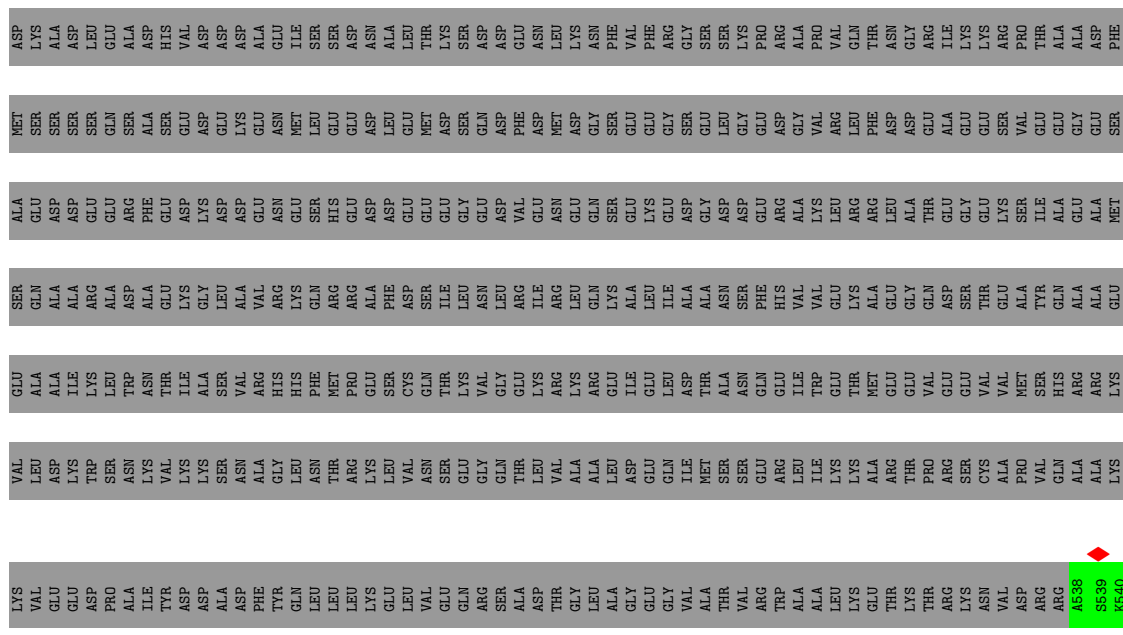

● Molecule 46: Utp2

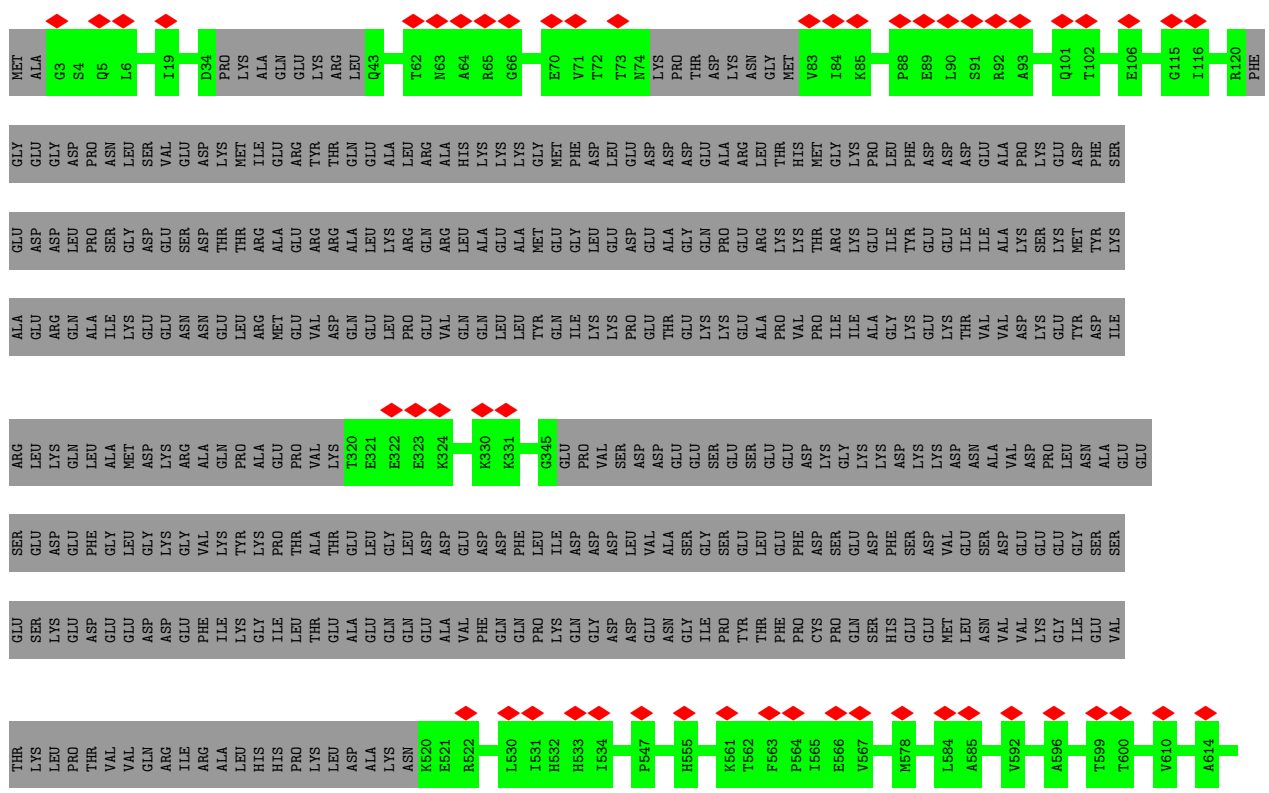

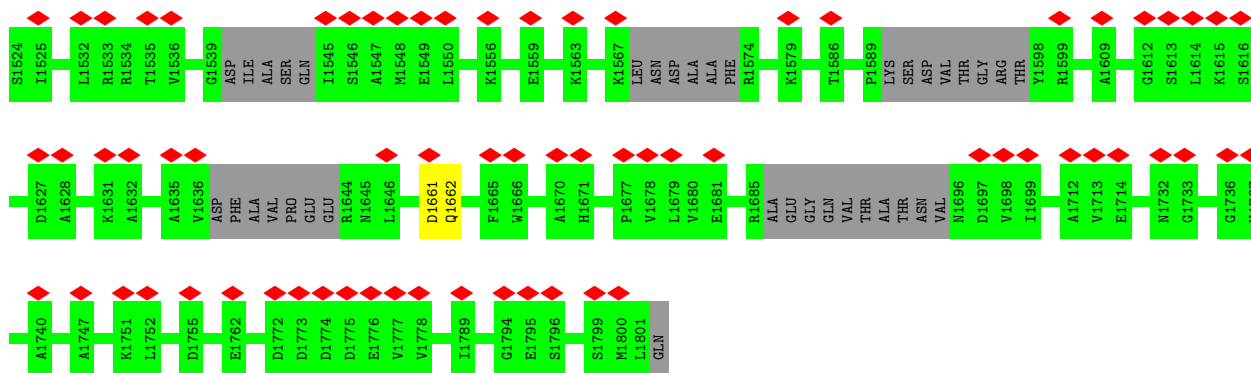

• Molecule 49: Utp15

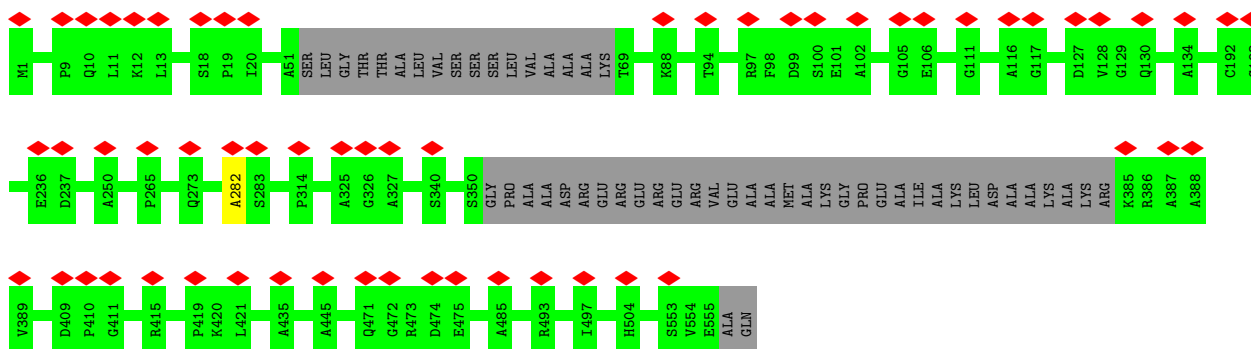

• Molecule 50: Utp17

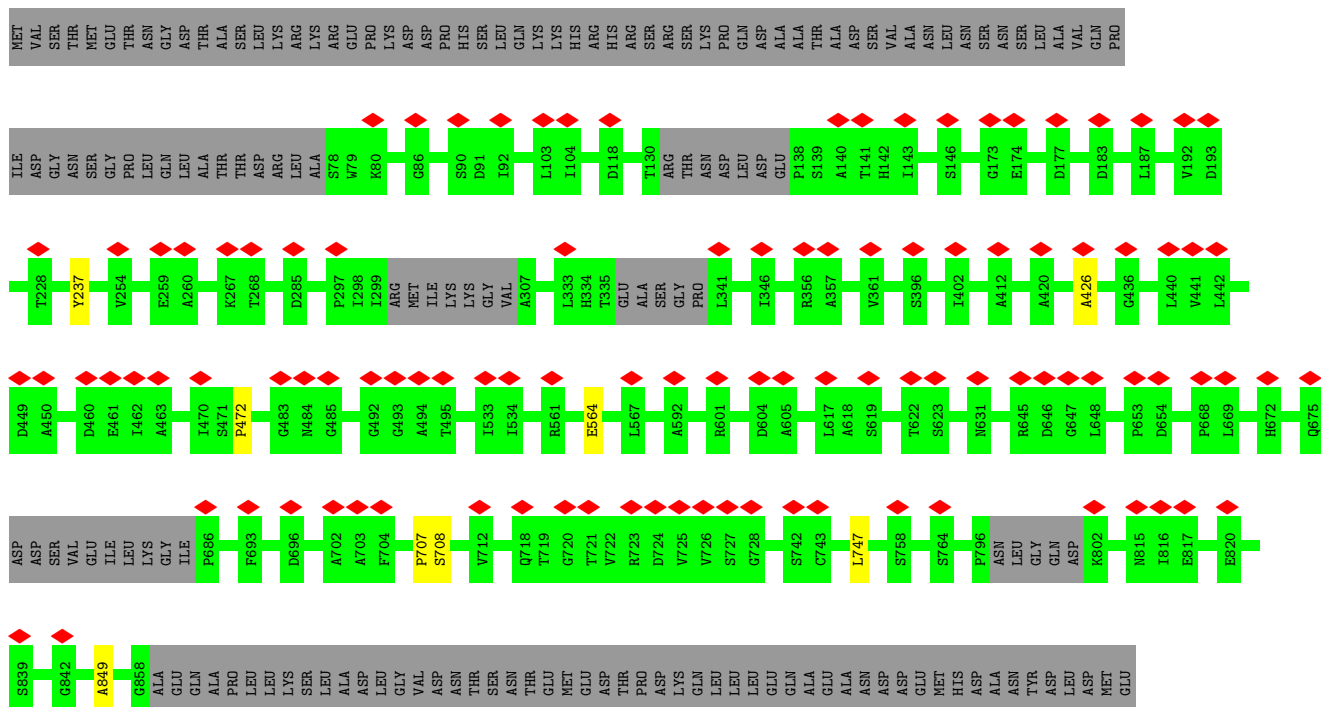
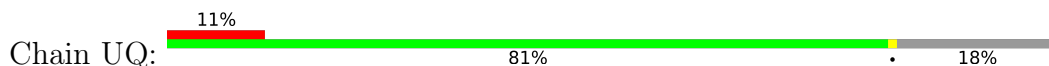

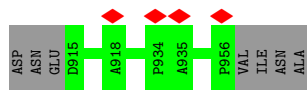

• Molecule 51: Enp1

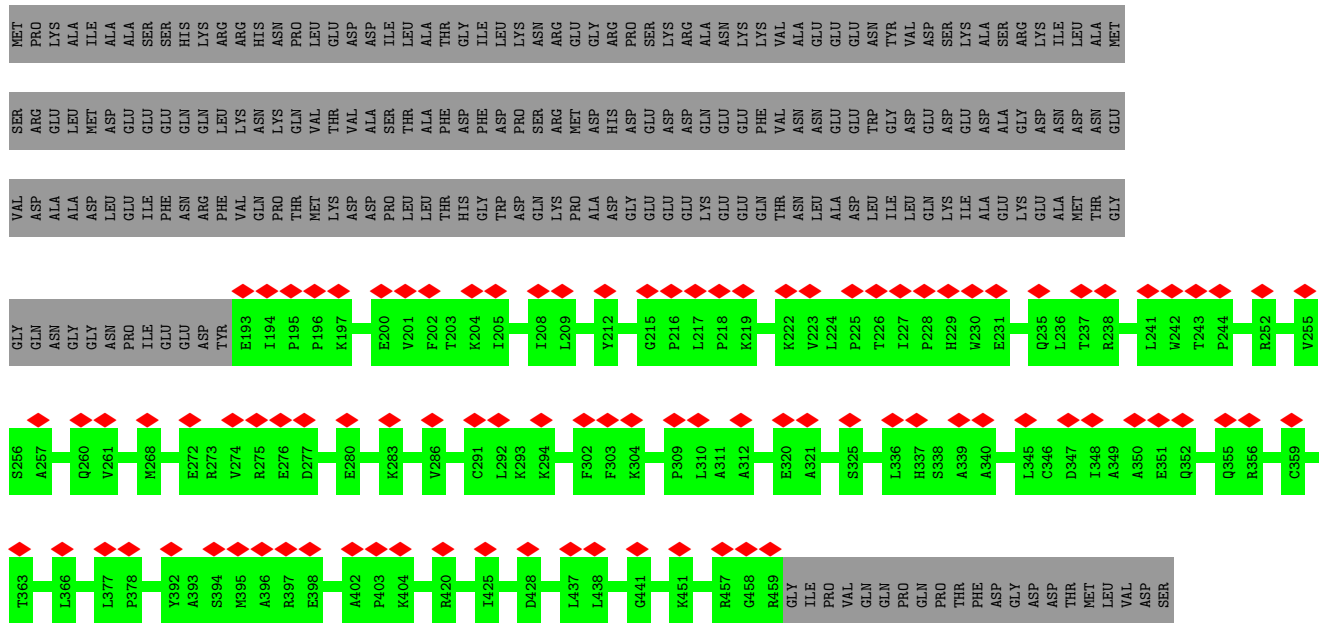

• Molecule 52: Utp5

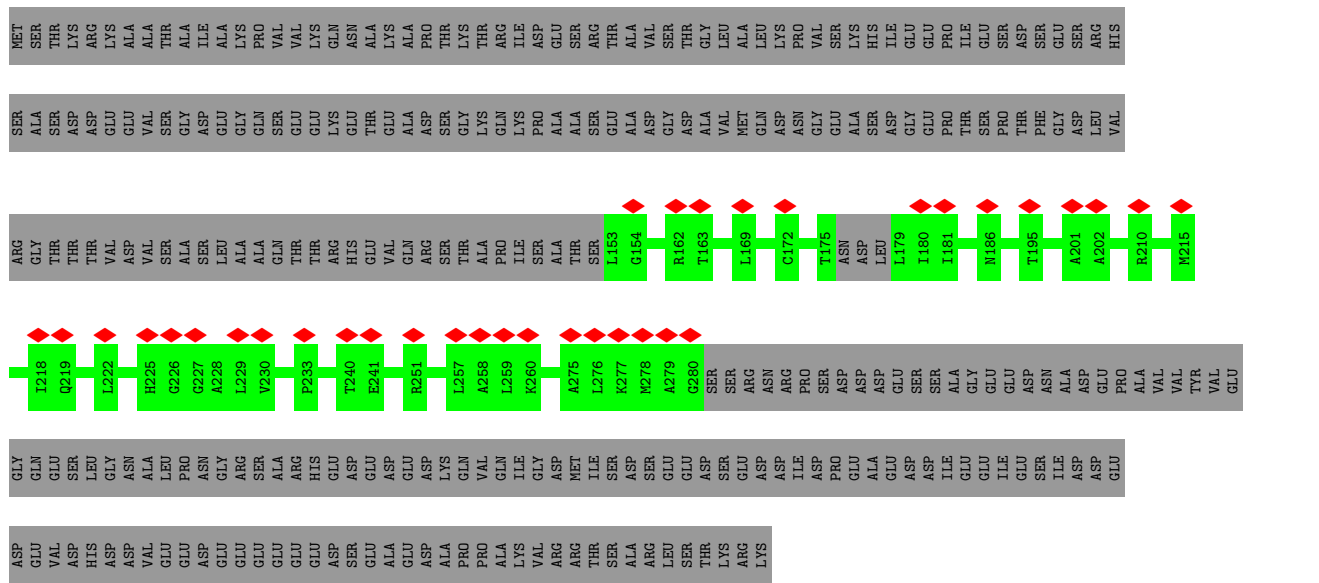

• Molecule 52: Utp5



4 Experimental information

Property	Value	Source
EM reconstruction method	SINGLE PARTICLE	Depositor
Imposed symmetry	POINT, C1	Depositor
Number of particles used	9041	Depositor
Resolution determination method	FSC 0.143 CUT-OFF	Depositor
CTF correction method	PHASE FLIPPING AND AMPLITUDE CORRECTION	Depositor
Microscope	FEI TITAN KRIOS	Depositor
Voltage (kV)	300	Depositor
Electron dose ($e^-/\text{\AA}^2$)	28	Depositor
Minimum defocus (nm)	Not provided	
Maximum defocus (nm)	Not provided	
Magnification	Not provided	
Image detector	FEI FALCON II (4k x 4k)	Depositor
Maximum map value	0.171	Depositor
Minimum map value	-0.104	Depositor
Average map value	0.001	Depositor
Map value standard deviation	0.008	Depositor
Recommended contour level	0.03	Depositor
Map size (Å)	520.32, 520.32, 520.32	wwPDB
Map dimensions	480, 480, 480	wwPDB
Map angles (°)	90.0, 90.0, 90.0	wwPDB
Pixel spacing (Å)	1.084, 1.084, 1.084	Depositor

5 Model quality i

5.1 Standard geometry i

Bond lengths and bond angles in the following residue types are not validated in this section:
ZN

The Z score for a bond length (or angle) is the number of standard deviations the observed value is removed from the expected value. A bond length (or angle) with $|Z| > 5$ is considered an outlier worth inspection. RMSZ is the root-mean-square of all Z scores of the bond lengths (or angles).

Mol	Chain	Bond lengths		Bond angles	
		RMSZ	# Z >5	RMSZ	# Z >5
1	UA	0.35	0/4134	0.61	1/5749 (0.0%)
2	UC	0.33	0/360	0.50	0/497
3	UF	0.29	0/1641	0.48	0/2286
4	UG	0.34	0/2359	0.58	0/3279
5	UK	0.32	0/1067	0.44	0/1480
6	UL	0.31	0/3868	0.59	0/5372
7	UM	0.28	0/3590	0.57	0/4981
8	UN	0.32	0/877	0.52	0/1220
9	UR	0.33	0/2193	0.55	0/3040
10	UU	0.34	0/4418	0.57	0/6124
11	UX	0.32	0/941	0.56	0/1311
12	CJ	0.33	0/889	0.51	0/1240
13	CK	0.35	0/1471	0.57	0/2050
14	CL	0.31	0/1139	0.49	0/1582
15	CM	0.34	0/2200	0.59	0/3064
16	CN	0.29	0/1120	0.51	0/1560
16	CO	0.29	0/1065	0.56	0/1483
17	CP	0.30	0/993	0.54	0/1381
18	CQ	0.26	0/862	0.50	0/1197
19	Ca	0.30	0/1114	0.58	0/1552
20	Cc	0.29	0/951	0.49	0/1324
21	Ce	0.32	0/784	0.62	1/1089 (0.1%)
22	Cg	0.32	0/784	0.50	0/1090
23	Ch	0.57	0/740	0.76	0/1029
24	Ci	0.31	0/562	0.50	0/778
25	Cj	0.32	0/621	0.56	0/863
26	Cm	0.30	0/618	0.54	0/856
27	Cn	0.30	0/467	0.54	0/644
28	Cp	0.31	0/299	0.52	0/414
29	Cq	0.70	0/399	1.23	1/554 (0.2%)
30	CU	0.27	0/867	0.52	0/1202
31	C1	0.61	5/29104 (0.0%)	1.24	309/45308 (0.7%)

Mol	Chain	Bond lengths		Bond angles	
		RMSZ	# Z >5	RMSZ	# Z >5
32	UV	0.32	0/5242	0.59	1/7299 (0.0%)
33	CV	0.47	1/730 (0.1%)	0.76	3/1014 (0.3%)
34	Cl	0.27	0/394	0.56	0/547
35	CH	0.32	0/1899	0.55	0/2628
36	CI	0.33	0/4056	0.55	0/5641
37	CR	0.30	0/3748	0.63	0/5209
37	CS	0.30	0/3748	0.63	0/5209
38	Cb	0.29	0/1139	0.58	0/1581
39	Cd	0.31	0/1111	0.54	0/1543
40	Cf	0.31	0/850	0.55	0/1176
41	Ck	0.27	0/689	0.55	0/956
42	Co	0.31	0/452	0.57	0/627
43	CW	0.30	0/1879	0.62	0/2611
44	UT	0.30	0/9990	0.54	0/13904
45	CZ	0.29	0/206	0.64	0/285
46	UB	0.29	0/2515	0.48	0/3500
47	UD	0.31	0/3790	0.56	0/5255
48	UJ	0.29	0/5391	0.52	0/7498
49	UO	0.32	0/2483	0.56	0/3451
50	UQ	0.32	0/3892	0.61	2/5410 (0.0%)
51	CX	0.26	0/1324	0.48	0/1846
52	UE	0.29	0/614	0.50	0/851
52	UI	0.24	0/614	0.40	0/851
53	UP	0.29	0/264	0.54	0/365
54	UH	0.29	0/1766	0.50	0/2450
55	US	0.29	0/2241	0.52	0/3125
56	CA	0.33	0/1187	0.56	0/1646
56	CB	0.28	0/1090	0.52	0/1512
57	CC	0.31	0/1909	0.52	0/2655
58	CD	0.31	0/2071	0.52	0/2880
59	CE	0.34	0/600	0.54	0/836
59	CF	0.34	0/595	0.56	0/829
60	CG	0.30	0/2042	0.57	0/2829
61	CT	0.31	0/645	0.54	0/895
62	C2	0.65	0/5434	1.40	69/8459 (0.8%)
63	Cr	0.70	0/696	1.21	2/965 (0.2%)
All	All	0.41	6/149793 (0.0%)	0.80	389/213937 (0.2%)

Chiral center outliers are detected by calculating the chiral volume of a chiral center and verifying if the center is modelled as a planar moiety or with the opposite hand. A planarity outlier is detected by checking planarity of atoms in a peptide group, atoms in a mainchain group or atoms of a sidechain that are expected to be planar.

Mol	Chain	#Chirality outliers	#Planarity outliers
1	UA	0	1
6	UL	0	2
7	UM	0	4
9	UR	0	1
10	UU	0	3
13	CK	0	1
15	CM	0	1
16	CO	0	2
18	CQ	0	1
20	Cc	0	1
21	Ce	0	1
23	Ch	0	1
32	UV	0	3
33	CV	0	2
34	CI	0	1
35	CH	0	1
36	CI	0	2
37	CR	0	3
37	CS	0	3
38	Cb	0	1
43	CW	0	2
44	UT	0	10
47	UD	0	1
48	UJ	0	2
49	UO	0	1
50	UQ	0	4
52	UE	0	1
55	US	0	1
56	CB	0	1
59	CF	0	1
60	CG	0	1
63	Cr	0	1
All	All	0	61

The worst 5 of 6 bond length outliers are listed below:

Mol	Chain	Res	Type	Atoms	Z	Observed(Å)	Ideal(Å)
31	C1	2076	C	C1'-N1	5.83	1.57	1.48
31	C1	2094	G	C1'-N9	-5.69	1.38	1.46
31	C1	2075	U	C1'-N1	5.68	1.57	1.48
31	C1	1081	G	C2-N3	-5.57	1.28	1.32
33	CV	91	HIS	N-CA	5.49	1.57	1.46

The worst 5 of 389 bond angle outliers are listed below:

Mol	Chain	Res	Type	Atoms	Z	Observed(°)	Ideal(°)
62	C2	2	G	O5'-P-OP1	-30.50	74.10	110.70
62	C2	2	G	OP1-P-OP2	-27.22	78.76	119.60
62	C2	2	G	O5'-P-OP2	18.20	132.55	110.70
62	C2	1	A	OP1-P-O3'	13.82	135.61	105.20
62	C2	1	A	OP2-P-O3'	-13.12	76.34	105.20

There are no chirality outliers.

5 of 61 planarity outliers are listed below:

Mol	Chain	Res	Type	Group
1	UA	115	LEU	Peptide
6	UL	153	ASP	Peptide
6	UL	636	LEU	Peptide
7	UM	328	LEU	Peptide
7	UM	382	ILE	Peptide

5.2 Too-close contacts [i](#)

Due to software issues we are unable to calculate clashes - this section is therefore empty.

5.3 Torsion angles [i](#)

5.3.1 Protein backbone [i](#)

In the following table, the Percentiles column shows the percent Ramachandran outliers of the chain as a percentile score with respect to all PDB entries followed by that with respect to all EM entries.

The Analysed column shows the number of residues for which the backbone conformation was analysed, and the total number of residues.

Mol	Chain	Analysed	Favoured	Allowed	Outliers	Percentiles	
1	UA	835/904 (92%)	768 (92%)	67 (8%)	0	100	100
2	UC	72/648 (11%)	64 (89%)	8 (11%)	0	100	100
3	UF	325/414 (78%)	310 (95%)	14 (4%)	1 (0%)	41	77
4	UG	475/558 (85%)	441 (93%)	32 (7%)	2 (0%)	34	72
5	UK	211/270 (78%)	210 (100%)	1 (0%)	0	100	100
6	UL	767/962 (80%)	711 (93%)	56 (7%)	0	100	100

Continued on next page...

Continued from previous page...

Mol	Chain	Analysed	Favoured	Allowed	Outliers	Percentiles	
7	UM	705/912 (77%)	656 (93%)	48 (7%)	1 (0%)	51	86
8	UN	171/938 (18%)	167 (98%)	3 (2%)	1 (1%)	25	66
9	UR	437/618 (71%)	416 (95%)	21 (5%)	0	100	100
10	UU	890/1049 (85%)	833 (94%)	57 (6%)	0	100	100
11	UX	188/193 (97%)	176 (94%)	12 (6%)	0	100	100
12	CJ	177/183 (97%)	166 (94%)	11 (6%)	0	100	100
13	CK	295/297 (99%)	284 (96%)	11 (4%)	0	100	100
14	CL	225/785 (29%)	212 (94%)	12 (5%)	1 (0%)	34	72
15	CM	443/446 (99%)	416 (94%)	27 (6%)	0	100	100
16	CN	222/252 (88%)	210 (95%)	12 (5%)	0	100	100
16	CO	211/252 (84%)	198 (94%)	11 (5%)	2 (1%)	17	57
17	CP	197/322 (61%)	191 (97%)	6 (3%)	0	100	100
18	CQ	171/259 (66%)	164 (96%)	7 (4%)	0	100	100
19	Ca	223/255 (88%)	212 (95%)	11 (5%)	0	100	100
20	Cc	188/212 (89%)	179 (95%)	9 (5%)	0	100	100
21	Ce	155/203 (76%)	139 (90%)	16 (10%)	0	100	100
22	Cg	157/190 (83%)	152 (97%)	5 (3%)	0	100	100
23	Ch	148/151 (98%)	127 (86%)	11 (7%)	10 (7%)	1	15
24	Ci	113/150 (75%)	107 (95%)	6 (5%)	0	100	100
25	Cj	124/143 (87%)	116 (94%)	8 (6%)	0	100	100
26	Cm	122/130 (94%)	117 (96%)	5 (4%)	0	100	100
27	Cn	92/145 (63%)	89 (97%)	3 (3%)	0	100	100
28	Cp	59/68 (87%)	55 (93%)	4 (7%)	0	100	100
29	Cq	79/82 (96%)	64 (81%)	12 (15%)	3 (4%)	3	24
30	CU	168/311 (54%)	156 (93%)	12 (7%)	0	100	100
32	UV	1057/1171 (90%)	975 (92%)	80 (8%)	2 (0%)	47	81
33	CV	144/322 (45%)	131 (91%)	10 (7%)	3 (2%)	7	36
34	Cl	78/156 (50%)	73 (94%)	5 (6%)	0	100	100
35	CH	383/411 (93%)	346 (90%)	36 (9%)	1 (0%)	41	77
36	CI	812/1163 (70%)	761 (94%)	49 (6%)	2 (0%)	47	81
37	CR	746/1073 (70%)	682 (91%)	60 (8%)	4 (0%)	29	69

Continued on next page...

Continued from previous page...

Mol	Chain	Analysed	Favoured	Allowed	Outliers	Percentiles	
37	CS	746/1073 (70%)	682 (91%)	60 (8%)	4 (0%)	29	69
38	Cb	230/264 (87%)	204 (89%)	26 (11%)	0	100	100
39	Cd	224/239 (94%)	211 (94%)	13 (6%)	0	100	100
40	Cf	170/202 (84%)	164 (96%)	6 (4%)	0	100	100
41	Ck	136/161 (84%)	129 (95%)	7 (5%)	0	100	100
42	Co	90/136 (66%)	82 (91%)	8 (9%)	0	100	100
43	CW	380/668 (57%)	349 (92%)	31 (8%)	0	100	100
44	UT	1974/2612 (76%)	1859 (94%)	109 (6%)	6 (0%)	41	77
45	CZ	40/609 (7%)	32 (80%)	8 (20%)	0	100	100
46	UB	496/907 (55%)	464 (94%)	32 (6%)	0	100	100
47	UD	754/884 (85%)	721 (96%)	33 (4%)	0	100	100
48	UJ	1062/1802 (59%)	1010 (95%)	52 (5%)	0	100	100
49	UO	498/557 (89%)	475 (95%)	23 (5%)	0	100	100
50	UQ	775/960 (81%)	712 (92%)	61 (8%)	2 (0%)	41	77
51	CX	265/480 (55%)	255 (96%)	10 (4%)	0	100	100
52	UE	121/410 (30%)	117 (97%)	4 (3%)	0	100	100
52	UI	121/410 (30%)	121 (100%)	0	0	100	100
53	UP	52/364 (14%)	46 (88%)	5 (10%)	1 (2%)	8	38
54	UH	349/930 (38%)	340 (97%)	9 (3%)	0	100	100
55	US	443/549 (81%)	415 (94%)	28 (6%)	0	100	100
56	CA	238/313 (76%)	225 (94%)	13 (6%)	0	100	100
56	CB	218/313 (70%)	204 (94%)	14 (6%)	0	100	100
57	CC	383/523 (73%)	367 (96%)	16 (4%)	0	100	100
58	CD	416/582 (72%)	393 (94%)	23 (6%)	0	100	100
59	CE	119/127 (94%)	111 (93%)	8 (7%)	0	100	100
59	CF	118/127 (93%)	110 (93%)	7 (6%)	1 (1%)	19	60
60	CG	402/630 (64%)	375 (93%)	27 (7%)	0	100	100
61	CT	127/203 (63%)	119 (94%)	8 (6%)	0	100	100
63	Cr	140/153 (92%)	122 (87%)	13 (9%)	5 (4%)	3	25
All	All	22952/33786 (68%)	21488 (94%)	1412 (6%)	52 (0%)	50	81

5 of 52 Ramachandran outliers are listed below:

Mol	Chain	Res	Type
16	CO	85	SER
23	Ch	23	PRO
23	Ch	86	GLU
23	Ch	150	VAL
29	Cq	20	LYS

5.3.2 Protein sidechains [i](#)

There are no protein residues with a non-rotameric sidechain to report in this entry.

5.3.3 RNA [i](#)

Mol	Chain	Analysed	Backbone Outliers	Pucker Outliers
31	C1	1197/1859 (64%)	376 (31%)	25 (2%)
62	C2	225/232 (96%)	67 (29%)	4 (1%)
All	All	1422/2091 (68%)	443 (31%)	29 (2%)

5 of 443 RNA backbone outliers are listed below:

Mol	Chain	Res	Type
31	C1	4	G
31	C1	5	G
31	C1	7	A
31	C1	13	G
31	C1	14	G

5 of 29 RNA pucker outliers are listed below:

Mol	Chain	Res	Type
31	C1	1264	U
62	C2	91	G
31	C1	1712	C
31	C1	2219	C
31	C1	1638	G

5.4 Non-standard residues in protein, DNA, RNA chains [i](#)

There are no non-standard protein/DNA/RNA residues in this entry.

5.5 Carbohydrates [i](#)

There are no monosaccharides in this entry.

5.6 Ligand geometry [i](#)

Of 2 ligands modelled in this entry, 2 are monoatomic - leaving 0 for Mogul analysis.

There are no bond length outliers.

There are no bond angle outliers.

There are no chirality outliers.

There are no torsion outliers.

There are no ring outliers.

No monomer is involved in short contacts.

5.7 Other polymers [i](#)

There are no such residues in this entry.

5.8 Polymer linkage issues [i](#)

The following chains have linkage breaks:

Mol	Chain	Number of breaks
31	C1	4
62	C2	2

The worst 5 of 6 chain breaks are listed below:

Model	Chain	Residue-1	Atom-1	Residue-2	Atom-2	Distance (Å)
1	C1	74:C	O3'	244:G	P	56.87
1	C1	257:G	O3'	417:G	P	43.92
1	C2	206:G	O3'	240:C	P	18.77
1	C2	105:C	O3'	110:A	P	16.05
1	C1	34:C	O3'	36:C	P	5.49

6 Map visualisation [i](#)

This section contains visualisations of the EMDB entry EMD-10054. These allow visual inspection of the internal detail of the map and identification of artifacts.

No raw map or half-maps were deposited for this entry and therefore no images, graphs, etc. pertaining to the raw map can be shown.

6.1 Orthogonal projections [i](#)

6.1.1 Primary map

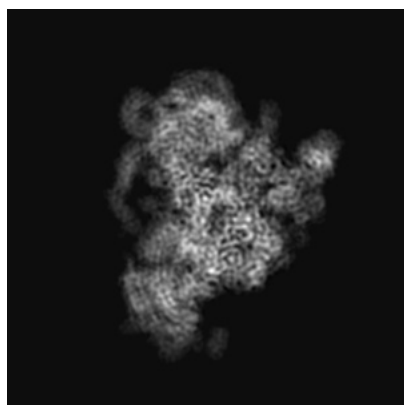

X

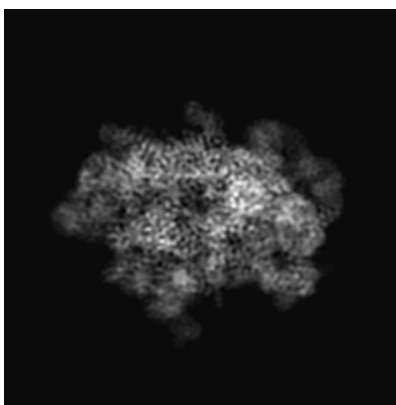

Y

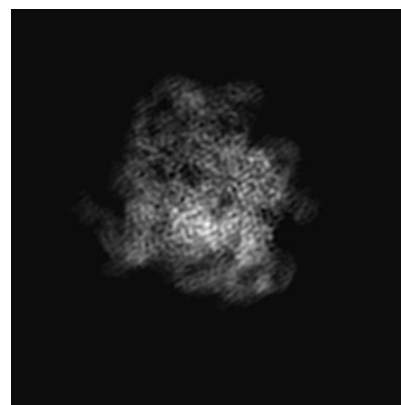

Z

The images above show the map projected in three orthogonal directions.

6.2 Central slices [i](#)

6.2.1 Primary map

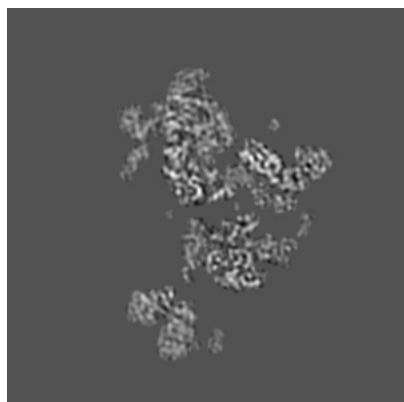

X Index: 240

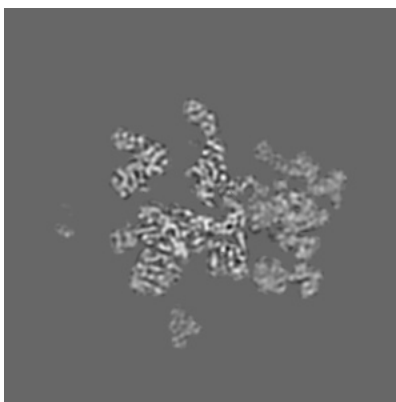

Y Index: 240

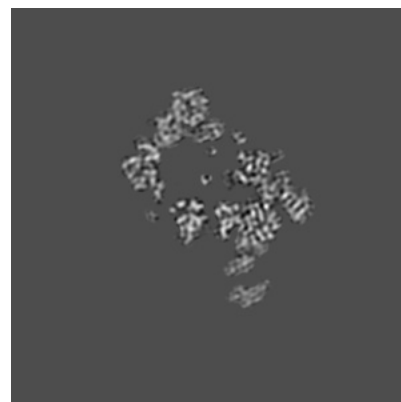

Z Index: 240

The images above show central slices of the map in three orthogonal directions.

6.3 Largest variance slices [i](#)

6.3.1 Primary map

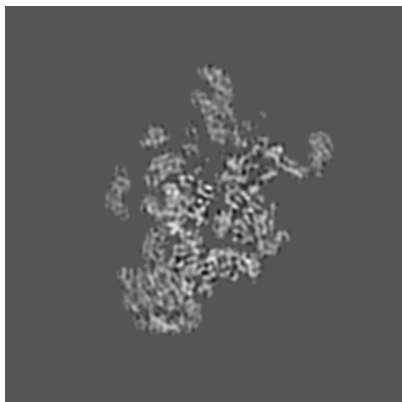

X Index: 279

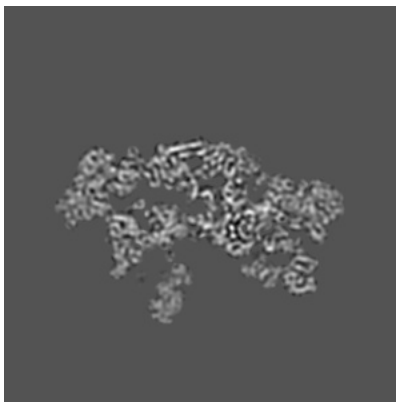

Y Index: 213



Z Index: 247

The images above show the largest variance slices of the map in three orthogonal directions.

6.4 Orthogonal surface views [i](#)

6.4.1 Primary map



X

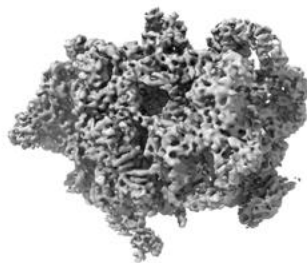

Y

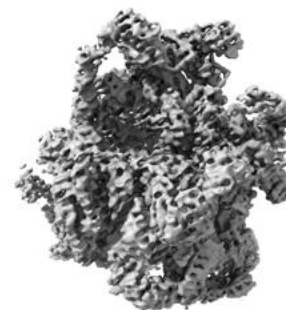

Z

The images above show the 3D surface view of the map at the recommended contour level 0.03. These images, in conjunction with the slice images, may facilitate assessment of whether an appropriate contour level has been provided.

6.5 Mask visualisation

This section was not generated. No masks/segmentation were deposited.

7 Map analysis [i](#)

This section contains the results of statistical analysis of the map.

7.1 Map-value distribution [i](#)

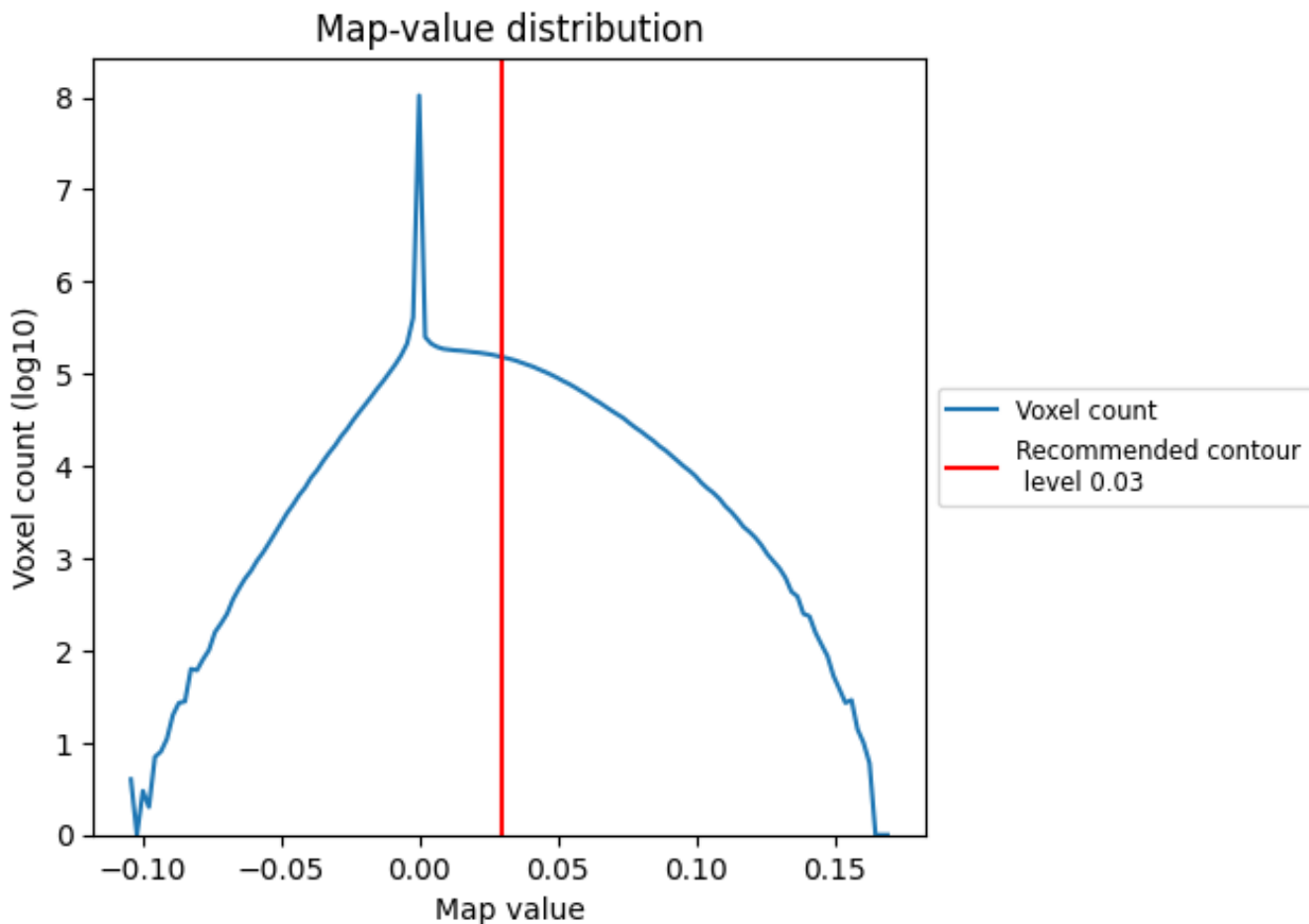

The map-value distribution is plotted in 128 intervals along the x-axis. The y-axis is logarithmic. A spike in this graph at zero usually indicates that the volume has been masked.

7.2 Volume estimate [\(i\)](#)

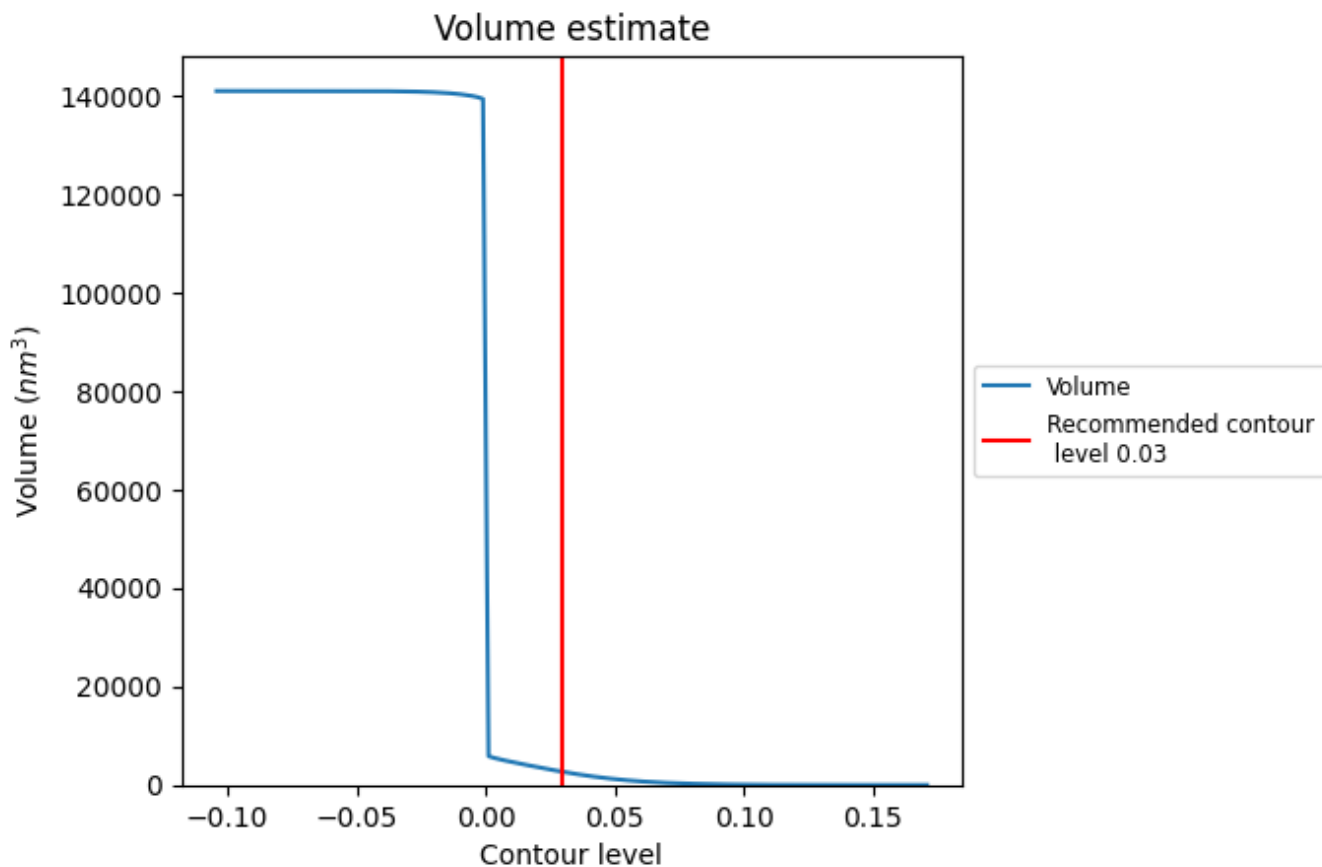

The volume at the recommended contour level is 2664 nm³; this corresponds to an approximate mass of 2407 kDa.

The volume estimate graph shows how the enclosed volume varies with the contour level. The recommended contour level is shown as a vertical line and the intersection between the line and the curve gives the volume of the enclosed surface at the given level.

7.3 Rotationally averaged power spectrum [i](#)

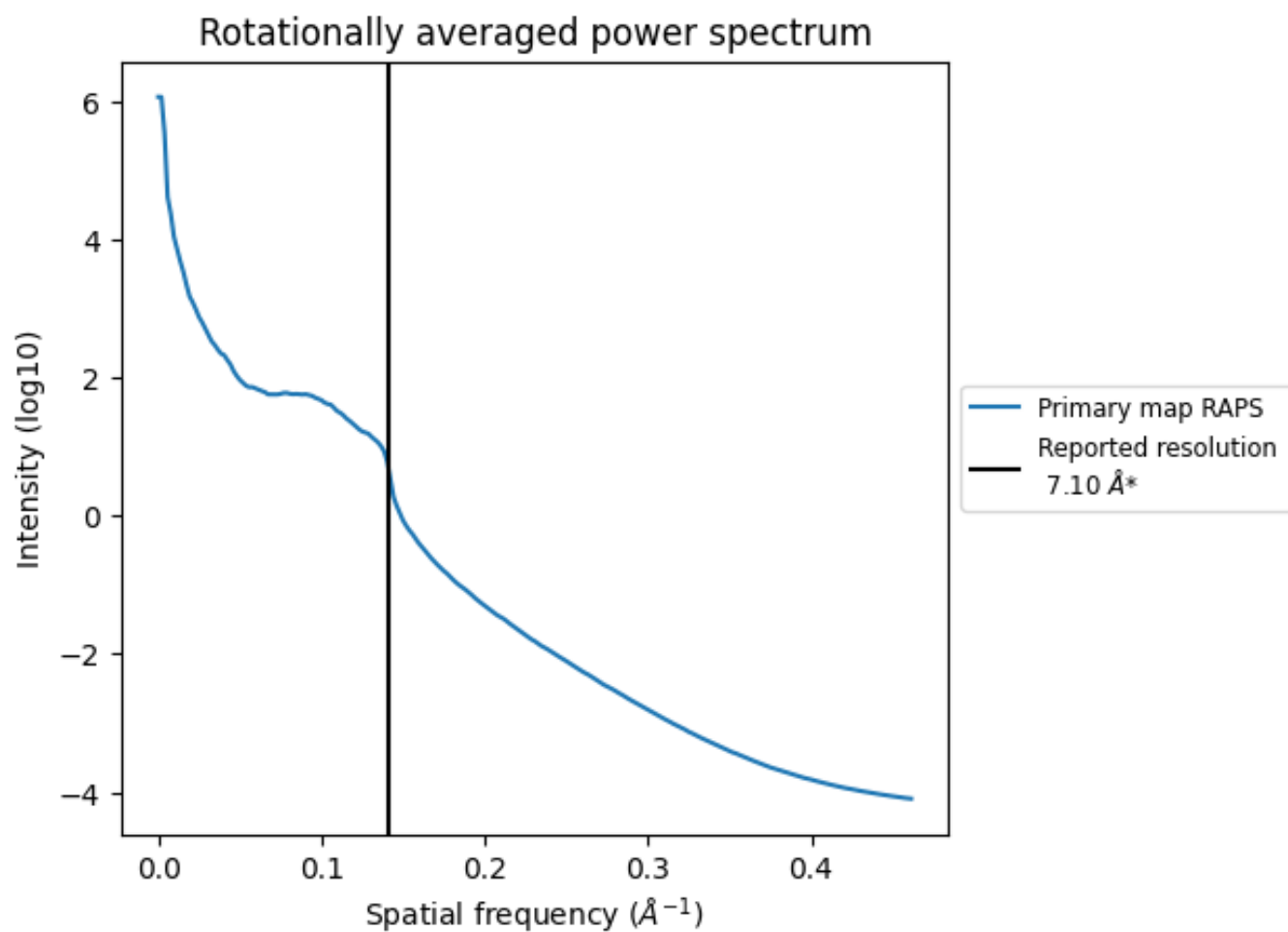

*Reported resolution corresponds to spatial frequency of 0.141\AA^{-1}

8 Fourier-Shell correlation [i](#)

Fourier-Shell Correlation (FSC) is the most commonly used method to estimate the resolution of single-particle and subtomogram-averaged maps. The shape of the curve depends on the imposed symmetry, mask and whether or not the two 3D reconstructions used were processed from a common reference. The reported resolution is shown as a black line. A curve is displayed for the half-bit criterion in addition to lines showing the 0.143 gold standard cut-off and 0.5 cut-off.

8.1 FSC [i](#)

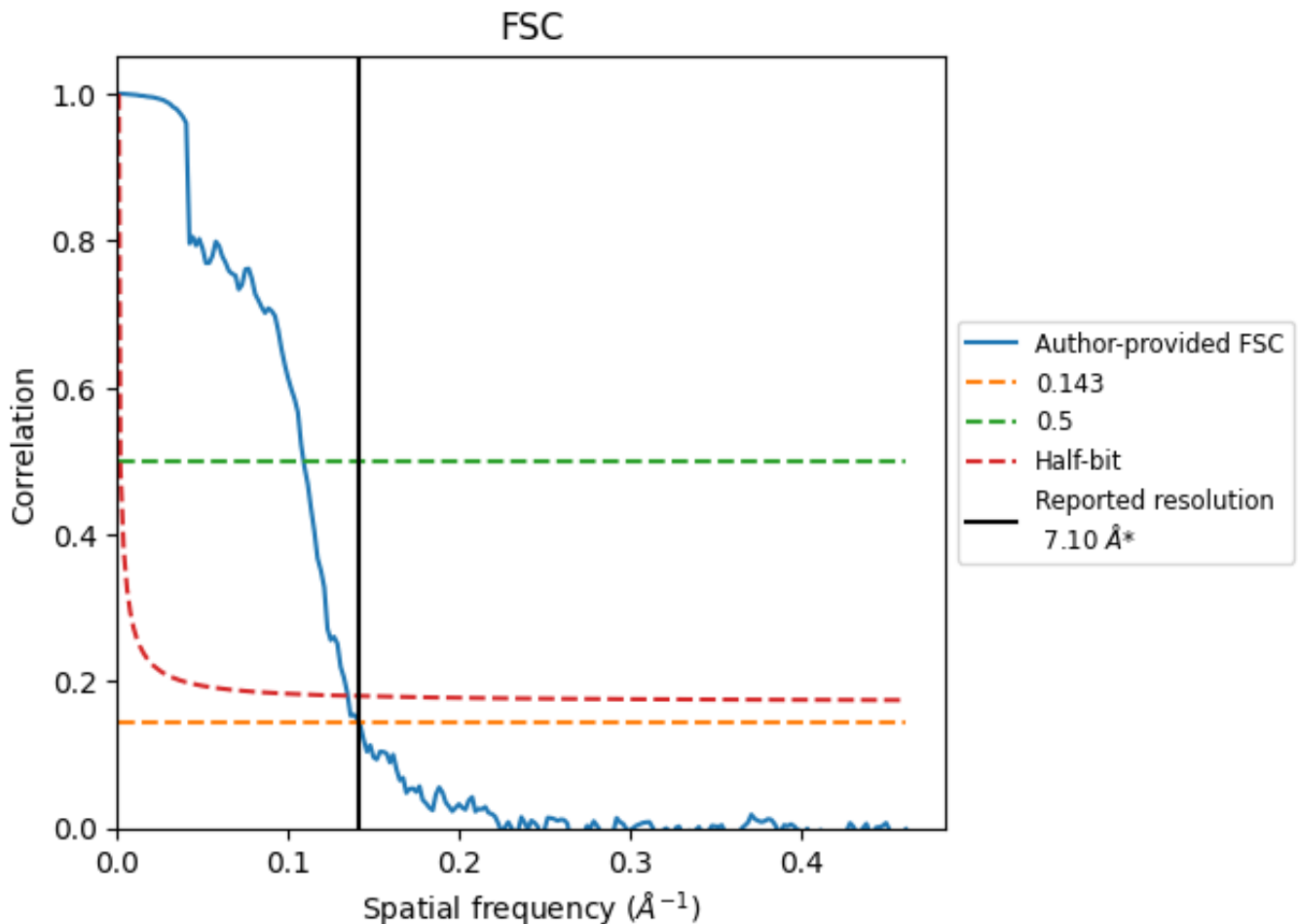

*Reported resolution corresponds to spatial frequency of 0.141 Å⁻¹

8.2 Resolution estimates [i](#)

Resolution estimate (Å)	Estimation criterion (FSC cut-off)		
	0.143	0.5	Half-bit
Reported by author	7.10	-	-
Author-provided FSC curve	7.07	9.17	7.42
Unmasked-calculated*	-	-	-

*Resolution estimate based on FSC curve calculated by comparison of deposited half-maps.

9 Map-model fit [i](#)

This section contains information regarding the fit between EMDB map EMD-10054 and PDB model 6RXX. Per-residue inclusion information can be found in section 3 on page 16.

9.1 Map-model overlay [i](#)

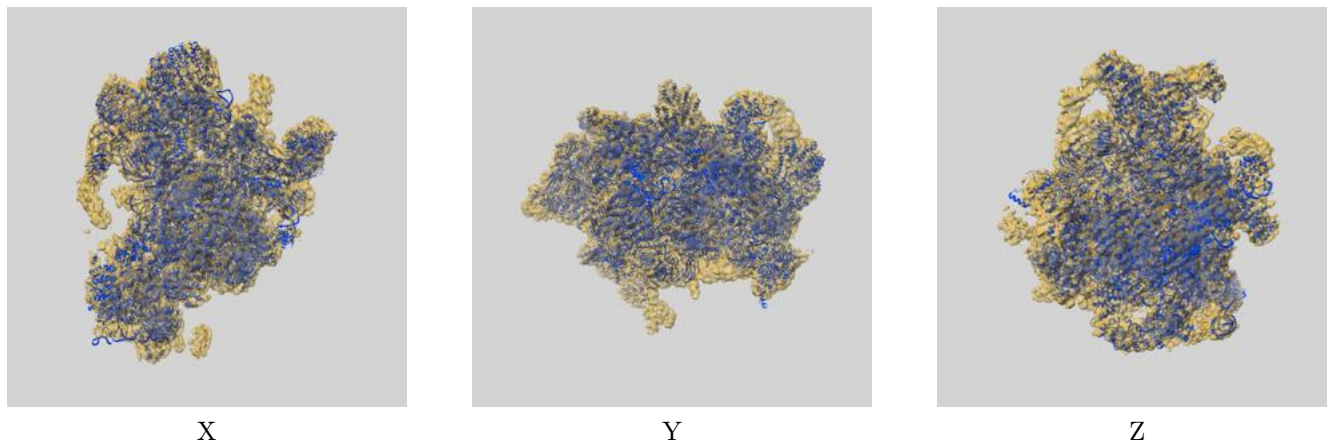

The images above show the 3D surface view of the map at the recommended contour level 0.03 at 50% transparency in yellow overlaid with a ribbon representation of the model coloured in blue. These images allow for the visual assessment of the quality of fit between the atomic model and the map.

9.2 Q-score mapped to coordinate model [i](#)

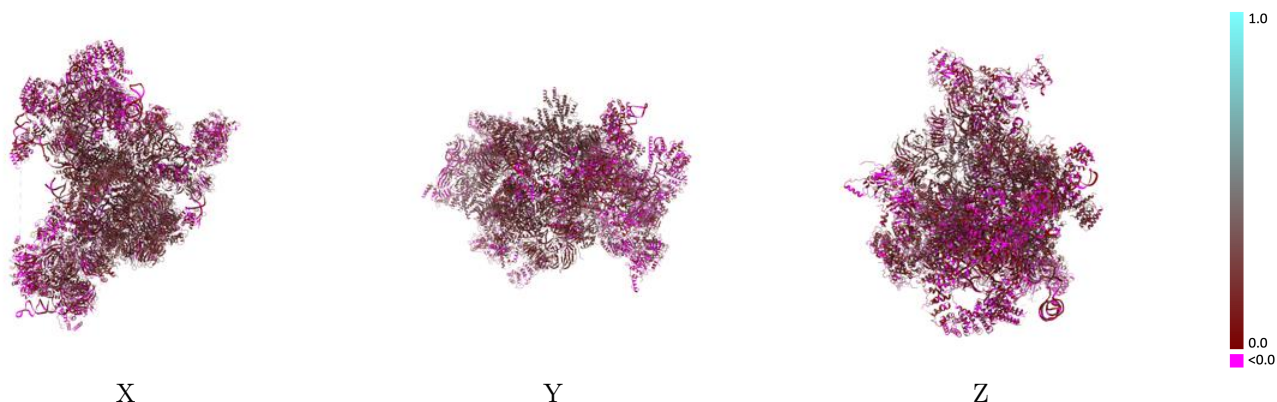

The images above show the model with each residue coloured according to its Q-score. This shows their resolvability in the map with higher Q-score values reflecting better resolvability. Please note: Q-score is calculating the resolvability of atoms, and thus high values are only expected at resolutions at which atoms can be resolved. Low Q-score values may therefore be expected for many entries.

9.3 Atom inclusion mapped to coordinate model [i](#)

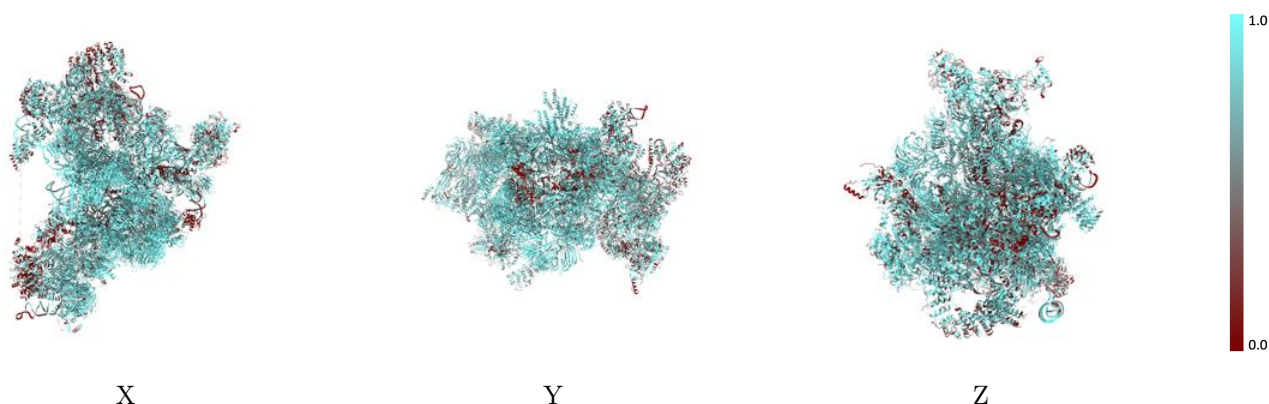

The images above show the model with each residue coloured according to its atom inclusion. This shows to what extent they are inside the map at the recommended contour level (0.03).



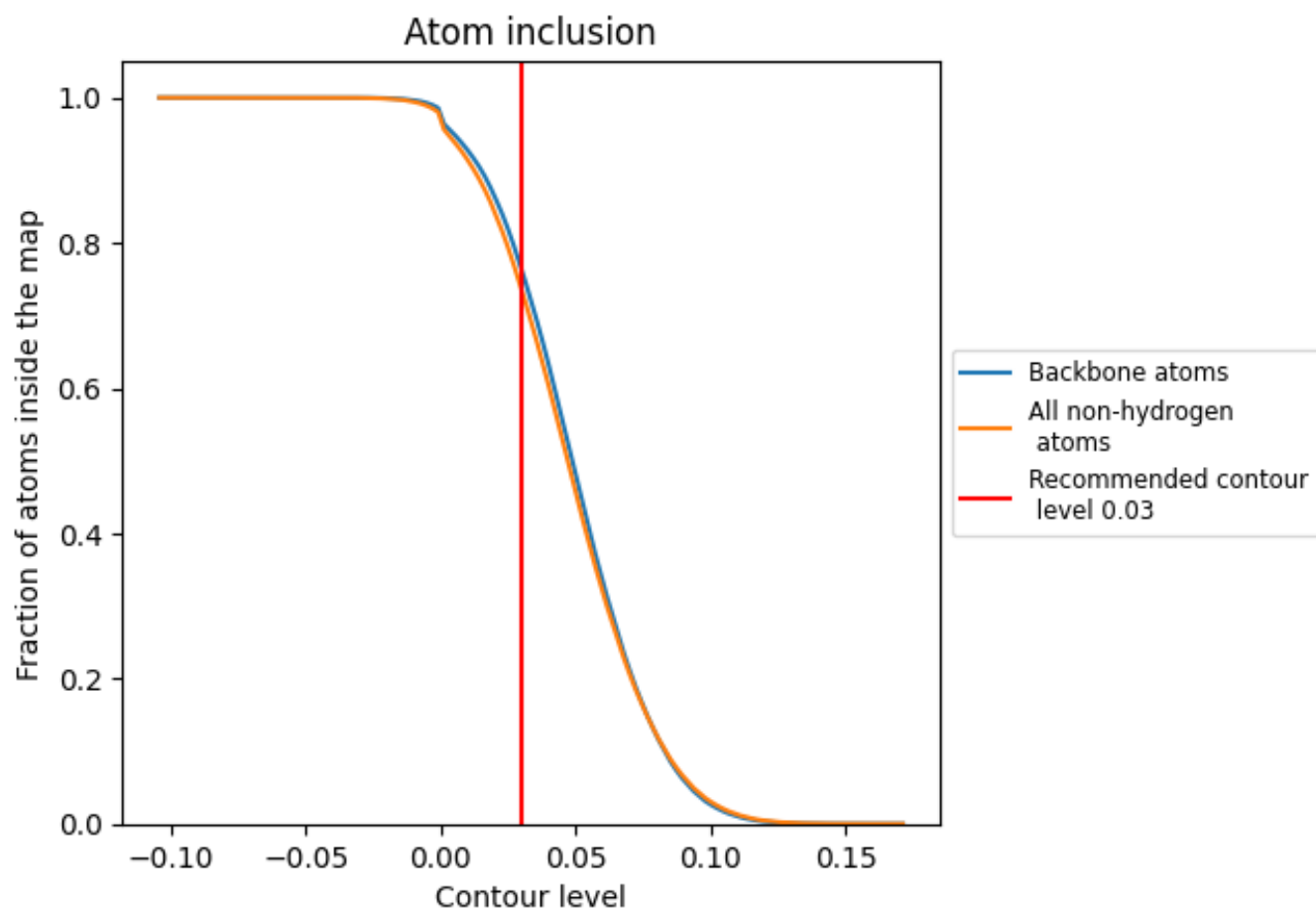



































































9.4 Atom inclusion [i](#)



At the recommended contour level, 76% of all backbone atoms, 73% of all non-hydrogen atoms, are inside the map.

9.5 Map-model fit summary





































































The table lists the average atom inclusion at the recommended contour level (0.03) and Q-score for the entire model and for each chain.

Chain	Atom inclusion	Q-score
All	 0.7343	 0.1560
C1	 0.7617	 0.1390
C2	 0.7891	 0.1470
CA	 0.8520	 0.2410
CB	 0.4954	 0.0480
CC	 0.8760	 0.2410
CD	 0.6946	 0.1650
CE	 0.6755	 0.1340
CF	 0.8020	 0.1880
CG	 0.7789	 0.1600
CH	 0.8764	 0.2290
CI	 0.8594	 0.2360
CJ	 0.7888	 0.2200
CK	 0.7636	 0.2260
CL	 0.7443	 0.2110
CM	 0.8642	 0.2390
CN	 0.6791	 0.1520
CO	 0.5951	 0.0800
CP	 0.5045	 0.1520
CQ	 0.2072	 0.0590
CR	 0.7824	 0.1690
CS	 0.5923	 0.0780
CT	 0.8068	 0.2310
CU	 0.1676	 0.0390
CV	 0.5902	 0.0810
CW	 0.6394	 0.1150
CX	 0.6181	 0.0520
CZ	 0.7343	 0.1480
Ca	 0.7749	 0.1940
Cb	 0.5737	 0.0950
Cc	 0.8583	 0.2280
Cd	 0.7428	 0.1650
Ce	 0.7354	 0.1770
Cf	 0.6350	 0.0500
Cg	 0.8204	 0.2110



Continued on next page...

Continued from previous page...

Chain	Atom inclusion	Q-score
Ch	 0.8124	 0.2250
Ci	 0.7265	 0.1540
Cj	 0.7830	 0.2250
Ck	 0.4703	 0.0310
Cl	 0.4709	 0.0900
Cm	 0.8129	 0.2230
Cn	 0.8380	 0.2450
Co	 0.9029	 0.2100
Cp	 0.8467	 0.2140
Cq	 0.7805	 0.1910
Cr	 0.6657	 0.1870
UA	 0.8426	 0.2220
UB	 0.7493	 0.1500
UC	 0.8864	 0.2630
UD	 0.7278	 0.1210
UE	 0.8474	 0.2050
UF	 0.9039	 0.2370
UG	 0.7476	 0.1850
UH	 0.7470	 0.1370
UI	 0.6883	 0.1450
UJ	 0.6259	 0.1430
UK	 0.5093	 0.1030
UL	 0.8875	 0.2260
UM	 0.8170	 0.1760
UN	 0.8011	 0.2300
UO	 0.8258	 0.2060
UP	 0.6075	 0.1550
UQ	 0.8179	 0.1600
UR	 0.7853	 0.1700
US	 0.6641	 0.1290
UT	 0.6005	 0.0860
UU	 0.8603	 0.2110
UV	 0.5873	 0.0900
UX	 0.6628	 0.1970