



wwPDB X-ray Structure Validation Summary Report ⓘ

May 13, 2024 – 03:33 pm BST

PDB ID : 8Q5W
Title : MgADP-bound Fe protein of the molybdenum nitrogenase from *Methanocaldococcus infernus*
Authors : Maslac, N.; Wagner, T.
Deposited on : 2023-08-09
Resolution : 2.49 Å (reported)

This is a wwPDB X-ray Structure Validation Summary Report for a publicly released PDB entry.

We welcome your comments at validation@mail.wwpdb.org

A user guide is available at

<https://www.wwpdb.org/validation/2017/XrayValidationReportHelp>

with specific help available everywhere you see the ⓘ symbol.

The types of validation reports are described at

<http://www.wwpdb.org/validation/2017/FAQs#types>.

The following versions of software and data (see [references ⓘ](#)) were used in the production of this report:

MolProbity : 4.02b-467
Mogul : 1.8.4, CSD as541be (2020)
Xtriage (Phenix) : 1.13
EDS : 2.36.2
buster-report : 1.1.7 (2018)
Percentile statistics : 20191225.v01 (using entries in the PDB archive December 25th 2019)
Refmac : 5.8.0158
CCP4 : 7.0.044 (Gargrove)
Ideal geometry (proteins) : Engh & Huber (2001)
Ideal geometry (DNA, RNA) : Parkinson et al. (1996)
Validation Pipeline (wwPDB-VP) : 2.36.2

1 Overall quality at a glance

The following experimental techniques were used to determine the structure:

X-RAY DIFFRACTION

The reported resolution of this entry is 2.49 Å.

Percentile scores (ranging between 0-100) for global validation metrics of the entry are shown in the following graphic. The table shows the number of entries on which the scores are based.

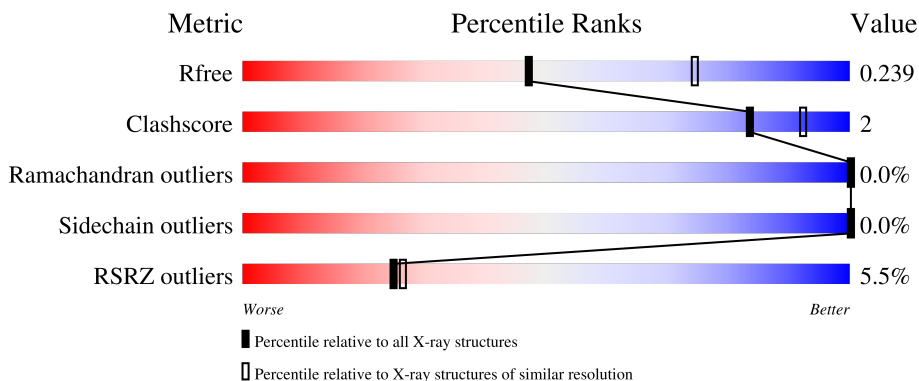

Metric	Whole archive (#Entries)	Similar resolution (#Entries, resolution range(Å))
R_{free}	130704	4661 (2.50-2.50)
Clashscore	141614	5346 (2.50-2.50)
Ramachandran outliers	138981	5231 (2.50-2.50)
Sidechain outliers	138945	5233 (2.50-2.50)
RSRZ outliers	127900	4559 (2.50-2.50)

The table below summarises the geometric issues observed across the polymeric chains and their fit to the electron density. The red, orange, yellow and green segments of the lower bar indicate the fraction of residues that contain outliers for ≥ 3 , 2, 1 and 0 types of geometric quality criteria respectively. A grey segment represents the fraction of residues that are not modelled. The numeric value for each fraction is indicated below the corresponding segment, with a dot representing fractions $\leq 5\%$. The upper red bar (where present) indicates the fraction of residues that have poor fit to the electron density. The numeric value is given above the bar.

Mol	Chain	Length	Quality of chain
1	A	284	 2% 95%
1	B	284	 4% 92% 7%
1	C	284	 4% 95%
1	D	284	 20% 89% 8%
1	E	284	 14% 90% 8%

Continued on next page...

Continued from previous page...

Mol	Chain	Length	Quality of chain
1	F	284	 2% 94% 5%
1	G	284	 4% 94% 5%
1	H	284	 5% 93% 6%
1	I	284	 2% 92% 6%
1	J	284	 5% 91% 7%
1	K	284	 2% 91% 8%
1	L	284	 2% 92% 6%

The following table lists non-polymeric compounds, carbohydrate monomers and non-standard residues in protein, DNA, RNA chains that are outliers for geometric or electron-density-fit criteria:

Mol	Type	Chain	Res	Chirality	Geometry	Clashes	Electron density
4	NO3	L	403	-	-	-	X

2 Entry composition [i](#)

There are 9 unique types of molecules in this entry. The entry contains 26165 atoms, of which 0 are hydrogens and 0 are deuteriums.

In the tables below, the ZeroOcc column contains the number of atoms modelled with zero occupancy, the AltConf column contains the number of residues with at least one atom in alternate conformation and the Trace column contains the number of residues modelled with at most 2 atoms.

- Molecule 1 is a protein called Nitrogenase iron protein.

Mol	Chain	Residues	Atoms					ZeroOcc	AltConf	Trace
			Total	C	N	O	S			
1	A	280	2138	1358	354	408	18	0	0	0
1	B	280	2144	1364	354	408	18	0	0	0
1	C	279	2130	1352	353	407	18	0	0	0
1	D	277	2113	1340	351	404	18	0	0	0
1	E	279	2133	1355	353	407	18	0	0	0
1	F	280	2144	1364	354	408	18	0	0	0
1	G	281	2150	1367	355	410	18	0	0	0
1	H	280	2144	1364	354	408	18	0	0	0
1	I	280	2138	1358	354	408	18	0	0	0
1	J	279	2132	1355	353	406	18	0	0	0
1	K	281	2150	1367	355	410	18	0	0	0
1	L	280	2144	1364	354	408	18	0	0	0

- Molecule 2 is ADENOSINE-5'-DIPHOSPHATE (three-letter code: ADP) (formula: $C_{10}H_{15}N_5O_{10}P_2$) (labeled as "Ligand of Interest" by depositor).

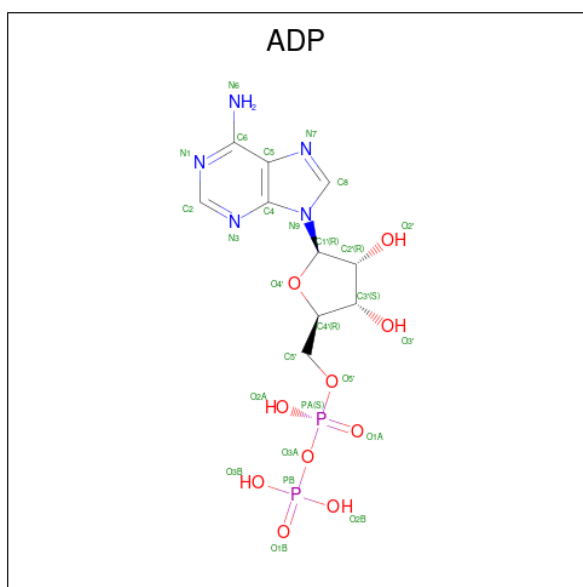

Mol	Chain	Residues	Atoms					ZeroOcc	AltConf
			Total	C	N	O	P		
2	A	1	Total	C	N	O	P	0	0
			27	10	5	10	2		
2	B	1	Total	C	N	O	P	0	0
			27	10	5	10	2		
2	C	1	Total	C	N	O	P	0	0
			27	10	5	10	2		
2	D	1	Total	C	N	O	P	0	0
			27	10	5	10	2		
2	E	1	Total	C	N	O	P	0	0
			27	10	5	10	2		
2	F	1	Total	C	N	O	P	0	0
			27	10	5	10	2		
2	G	1	Total	C	N	O	P	0	0
			27	10	5	10	2		
2	H	1	Total	C	N	O	P	0	0
			27	10	5	10	2		
2	I	1	Total	C	N	O	P	0	0
			27	10	5	10	2		
2	J	1	Total	C	N	O	P	0	0
			27	10	5	10	2		
2	K	1	Total	C	N	O	P	0	0
			27	10	5	10	2		
2	L	1	Total	C	N	O	P	0	0
			27	10	5	10	2		

- Molecule 3 is MAGNESIUM ION (three-letter code: MG) (formula: Mg) (labeled as "Ligand of Interest" by depositor).

Mol	Chain	Residues	Atoms	ZeroOcc	AltConf
3	A	1	Total Mg 1 1	0	0
3	B	1	Total Mg 1 1	0	0
3	C	1	Total Mg 1 1	0	0
3	D	1	Total Mg 1 1	0	0
3	E	1	Total Mg 1 1	0	0
3	F	1	Total Mg 1 1	0	0
3	G	1	Total Mg 1 1	0	0
3	H	1	Total Mg 1 1	0	0
3	I	1	Total Mg 1 1	0	0
3	J	1	Total Mg 1 1	0	0
3	K	1	Total Mg 1 1	0	0
3	L	1	Total Mg 1 1	0	0

- Molecule 4 is NITRATE ION (three-letter code: NO3) (formula: NO₃).

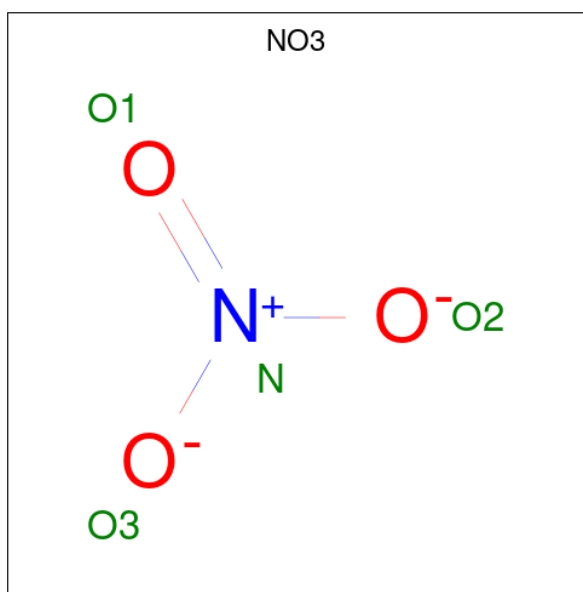

Mol	Chain	Residues	Atoms	ZeroOcc	AltConf
4	A	1	Total N O 4 1 3	0	0
4	A	1	Total N O 4 1 3	0	0
4	A	1	Total N O 4 1 3	0	0
4	F	1	Total N O 4 1 3	0	0
4	F	1	Total N O 4 1 3	0	0
4	H	1	Total N O 4 1 3	0	0
4	I	1	Total N O 4 1 3	0	0
4	I	1	Total N O 4 1 3	0	0
4	K	1	Total N O 4 1 3	0	0
4	L	1	Total N O 4 1 3	0	0

- Molecule 5 is 1,2-ETHANEDIOL (three-letter code: EDO) (formula: C₂H₆O₂).

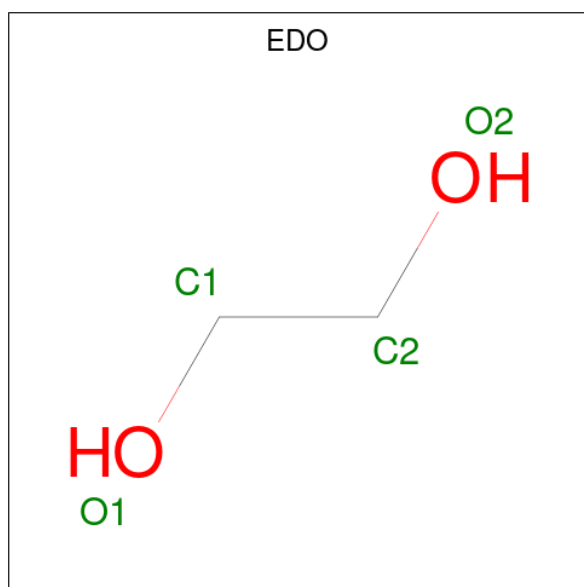

Mol	Chain	Residues	Atoms	ZeroOcc	AltConf
5	A	1	Total C O 4 2 2	0	0
5	G	1	Total C O 4 2 2	0	0

Continued on next page...

Continued from previous page...

Mol	Chain	Residues	Atoms	ZeroOcc	AltConf
5	G	1	Total C O 4 2 2	0	0
5	H	1	Total C O 4 2 2	0	0
5	I	1	Total C O 4 2 2	0	0
5	I	1	Total C O 4 2 2	0	0

- Molecule 6 is IRON/SULFUR CLUSTER (three-letter code: SF4) (formula: Fe₄S₄) (labeled as "Ligand of Interest" by depositor).

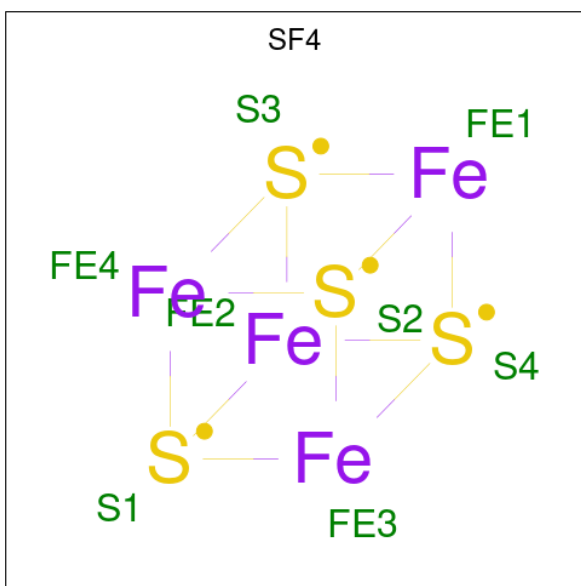

Mol	Chain	Residues	Atoms	ZeroOcc	AltConf
6	B	1	Total Fe S 8 4 4	0	0
6	C	1	Total Fe S 8 4 4	0	0
6	E	1	Total Fe S 8 4 4	0	0
6	H	1	Total Fe S 8 4 4	0	0
6	I	1	Total Fe S 8 4 4	0	0
6	K	1	Total Fe S 8 4 4	0	0

- Molecule 7 is CHLORIDE ION (three-letter code: CL) (formula: Cl).

Mol	Chain	Residues	Atoms	ZeroOcc	AltConf
7	E	1	Total Cl 1 1	0	0
7	G	1	Total Cl 1 1	0	0
7	J	1	Total Cl 1 1	0	0
7	L	1	Total Cl 1 1	0	0

- Molecule 8 is GLYCEROL (three-letter code: GOL) (formula: C₃H₈O₃).

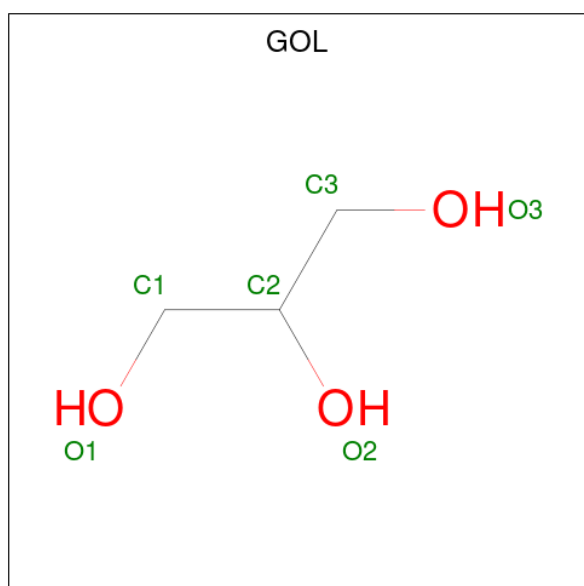

Mol	Chain	Residues	Atoms	ZeroOcc	AltConf
8	I	1	Total C O 6 3 3	0	0
8	K	1	Total C O 6 3 3	0	0

- Molecule 9 is water.

Mol	Chain	Residues	Atoms	ZeroOcc	AltConf
9	A	11	Total O 11 11	0	0
9	B	1	Total O 1 1	0	0
9	C	2	Total O 2 2	0	0
9	D	2	Total O 2 2	0	0

Continued on next page...

Continued from previous page...

Mol	Chain	Residues	Atoms	ZeroOcc	AltConf
9	E	1	Total O 1 1	0	0
9	F	1	Total O 1 1	0	0
9	G	5	Total O 5 5	0	0
9	H	2	Total O 2 2	0	0
9	I	5	Total O 5 5	0	0
9	J	1	Total O 1 1	0	0
9	K	2	Total O 2 2	0	0
9	L	8	Total O 8 8	0	0

3 Residue-property plots [i](#)

These plots are drawn for all protein, RNA, DNA and oligosaccharide chains in the entry. The first graphic for a chain summarises the proportions of the various outlier classes displayed in the second graphic. The second graphic shows the sequence view annotated by issues in geometry and electron density. Residues are color-coded according to the number of geometric quality criteria for which they contain at least one outlier: green = 0, yellow = 1, orange = 2 and red = 3 or more. A red dot above a residue indicates a poor fit to the electron density ($RSRZ > 2$). Stretches of 2 or more consecutive residues without any outlier are shown as a green connector. Residues present in the sample, but not in the model, are shown in grey.

- Molecule 1: Nitrogenase iron protein

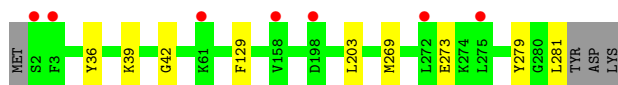

- Molecule 1: Nitrogenase iron protein

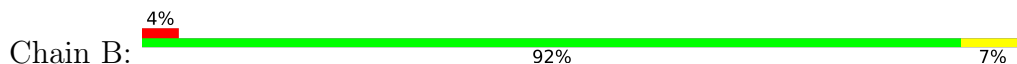

- Molecule 1: Nitrogenase iron protein



- Molecule 1: Nitrogenase iron protein

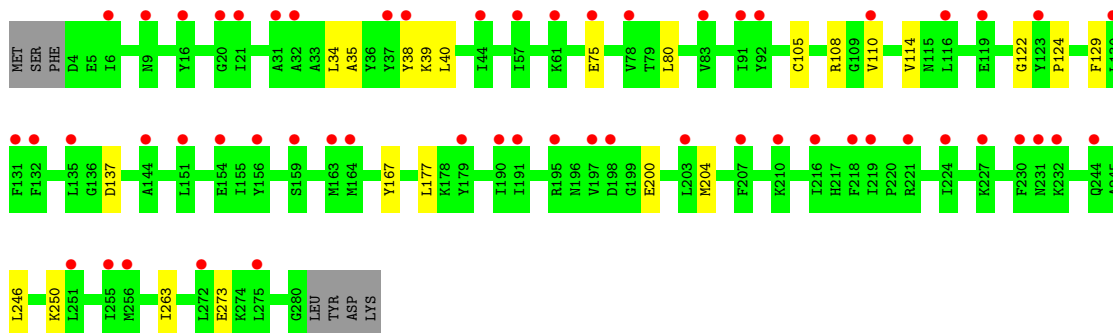
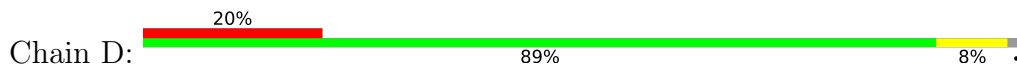

- Molecule 1: Nitrogenase iron protein

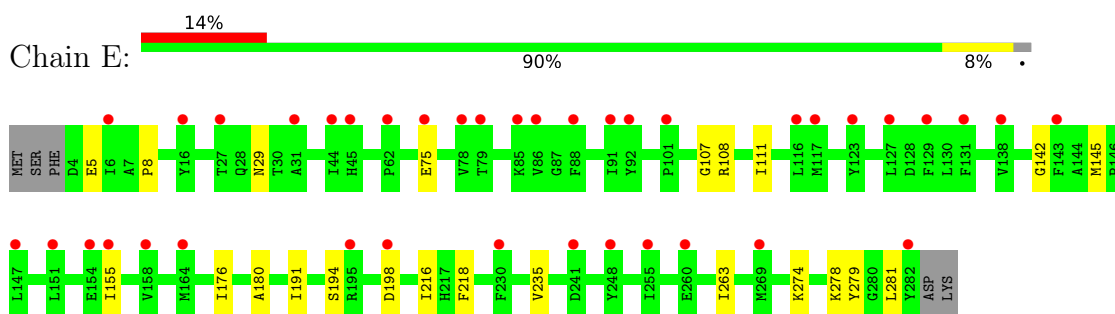

- Molecule 1: Nitrogenase iron protein

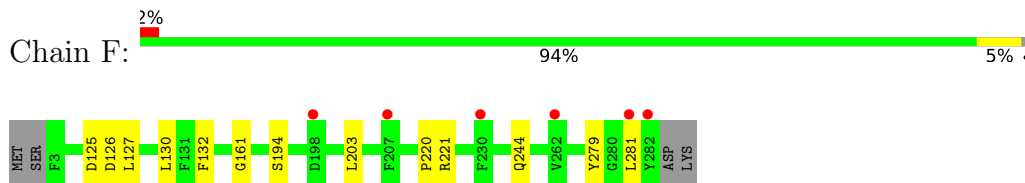

- Molecule 1: Nitrogenase iron protein

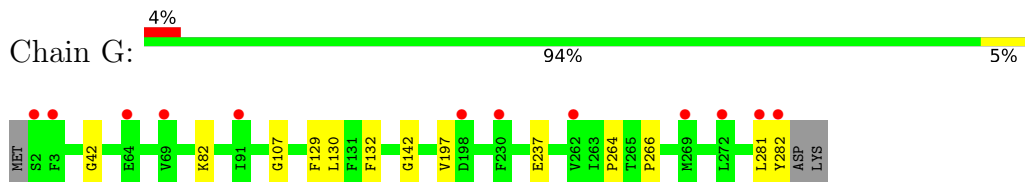

- Molecule 1: Nitrogenase iron protein

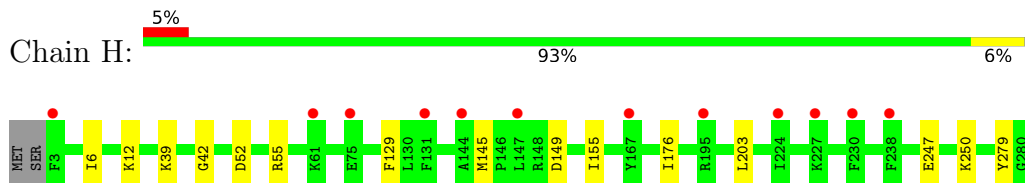

- Molecule 1: Nitrogenase iron protein

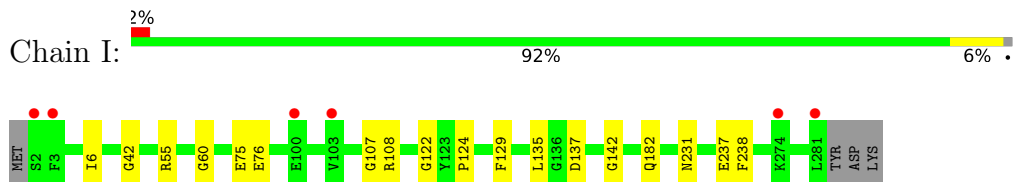

- Molecule 1: Nitrogenase iron protein

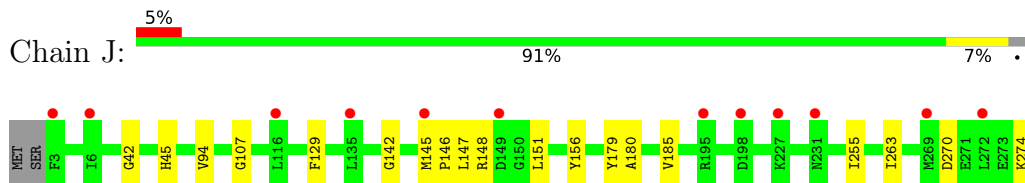

- Molecule 1: Nitrogenase iron protein

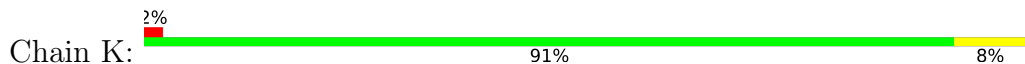



- Molecule 1: Nitrogenase iron protein

Chain L: 92% 6%



4 Data and refinement statistics

Property	Value	Source
Space group	P 21 21 21	Depositor
Cell constants a, b, c, α , β , γ	147.95Å 156.73Å 206.45Å 90.00° 90.00° 90.00°	Depositor
Resolution (Å)	49.26 – 2.49 120.26 – 2.49	Depositor EDS
% Data completeness (in resolution range)	54.4 (49.26-2.49) 54.4 (120.26-2.49)	Depositor EDS
R_{merge}	0.18	Depositor
R_{sym}	(Not available)	Depositor
$\langle I/\sigma(I) \rangle$ ¹	1.55 (at 2.48Å)	Xtrriage
Refinement program	PHENIX (1.20.1_4487: ???)	Depositor
R, R_{free}	0.221 , 0.242 0.220 , 0.239	Depositor DCC
R_{free} test set	4422 reflections (4.85%)	wwPDB-VP
Wilson B-factor (Å ²)	66.9	Xtrriage
Anisotropy	0.064	Xtrriage
Bulk solvent k_{sol} (e/Å ³), B_{sol} (Å ²)	0.29 , 18.5	EDS
L-test for twinning ²	$\langle L \rangle = 0.47$, $\langle L^2 \rangle = 0.30$	Xtrriage
Estimated twinning fraction	No twinning to report.	Xtrriage
F_o, F_c correlation	0.92	EDS
Total number of atoms	26165	wwPDB-VP
Average B, all atoms (Å ²)	79.0	wwPDB-VP

Xtrriage's analysis on translational NCS is as follows: *The analyses of the Patterson function reveals a significant off-origin peak that is 35.83 % of the origin peak, indicating pseudo-translational symmetry. The chance of finding a peak of this or larger height randomly in a structure without pseudo-translational symmetry is equal to 5.4891e-04. The detected translational NCS is most likely also responsible for the elevated intensity ratio.*

¹Intensities estimated from amplitudes.

²Theoretical values of $\langle |L| \rangle$, $\langle L^2 \rangle$ for acentric reflections are 0.5, 0.333 respectively for untwinned datasets, and 0.375, 0.2 for perfectly twinned datasets.

5 Model quality [i](#)

5.1 Standard geometry [i](#)

Bond lengths and bond angles in the following residue types are not validated in this section: MG, ADP, GOL, CL, NO3, SF4, EDO

The Z score for a bond length (or angle) is the number of standard deviations the observed value is removed from the expected value. A bond length (or angle) with $|Z| > 5$ is considered an outlier worth inspection. RMSZ is the root-mean-square of all Z scores of the bond lengths (or angles).

Mol	Chain	Bond lengths		Bond angles	
		RMSZ	# Z >5	RMSZ	# Z >5
1	A	0.30	0/2174	0.47	0/2925
1	B	0.32	0/2181	0.47	0/2935
1	C	0.28	0/2166	0.47	0/2914
1	D	0.33	0/2148	0.50	0/2890
1	E	0.35	0/2169	0.51	0/2919
1	F	0.32	0/2181	0.47	0/2935
1	G	0.30	0/2187	0.47	0/2943
1	H	0.29	0/2181	0.47	0/2935
1	I	0.29	0/2174	0.47	0/2925
1	J	0.30	0/2168	0.48	0/2917
1	K	0.33	0/2187	0.48	0/2943
1	L	0.29	0/2181	0.46	0/2935
All	All	0.31	0/26097	0.48	0/35116

There are no bond length outliers.

There are no bond angle outliers.

There are no chirality outliers.

There are no planarity outliers.

5.2 Too-close contacts [i](#)

In the following table, the Non-H and H(model) columns list the number of non-hydrogen atoms and hydrogen atoms in the chain respectively. The H(added) column lists the number of hydrogen atoms added and optimized by MolProbity. The Clashes column lists the number of clashes within the asymmetric unit, whereas Symm-Clashes lists symmetry-related clashes.

Mol	Chain	Non-H	H(model)	H(added)	Clashes	Symm-Clashes
1	A	2138	0	2153	6	0

Continued on next page...

Continued from previous page...

Mol	Chain	Non-H	H(model)	H(added)	Clashes	Symm-Clashes
1	B	2144	0	2157	14	0
1	C	2130	0	2142	7	0
1	D	2113	0	2128	16	0
1	E	2133	0	2147	14	0
1	F	2144	0	2157	7	0
1	G	2150	0	2162	10	0
1	H	2144	0	2157	11	0
1	I	2138	0	2153	12	0
1	J	2132	0	2148	11	0
1	K	2150	0	2162	15	0
1	L	2144	0	2157	12	0
2	A	27	0	12	0	0
2	B	27	0	12	0	0
2	C	27	0	12	0	0
2	D	27	0	12	0	0
2	E	27	0	12	0	0
2	F	27	0	12	0	0
2	G	27	0	12	0	0
2	H	27	0	12	0	0
2	I	27	0	12	0	0
2	J	27	0	12	0	0
2	K	27	0	12	1	0
2	L	27	0	12	0	0
3	A	1	0	0	0	0
3	B	1	0	0	0	0
3	C	1	0	0	0	0
3	D	1	0	0	0	0
3	E	1	0	0	0	0
3	F	1	0	0	0	0
3	G	1	0	0	0	0
3	H	1	0	0	0	0
3	I	1	0	0	0	0
3	J	1	0	0	0	0
3	K	1	0	0	0	0
3	L	1	0	0	0	0
4	A	12	0	0	0	0
4	F	8	0	0	0	0
4	H	4	0	0	0	0
4	I	8	0	0	1	0
4	K	4	0	0	0	0
4	L	4	0	0	0	0
5	A	4	0	6	0	0

Continued on next page...

Continued from previous page...

Mol	Chain	Non-H	H(model)	H(added)	Clashes	Symm-Clashes
5	G	8	0	12	0	0
5	H	4	0	6	0	0
5	I	8	0	12	0	0
6	B	8	0	0	0	0
6	C	8	0	0	0	0
6	E	8	0	0	0	0
6	H	8	0	0	0	0
6	I	8	0	0	0	0
6	K	8	0	0	0	0
7	E	1	0	0	1	0
7	G	1	0	0	0	0
7	J	1	0	0	0	0
7	L	1	0	0	0	0
8	I	6	0	8	0	0
8	K	6	0	8	0	0
9	A	11	0	0	0	0
9	B	1	0	0	0	0
9	C	2	0	0	0	0
9	D	2	0	0	0	0
9	E	1	0	0	0	0
9	F	1	0	0	0	0
9	G	5	0	0	0	0
9	H	2	0	0	0	0
9	I	5	0	0	0	0
9	J	1	0	0	0	0
9	K	2	0	0	0	0
9	L	8	0	0	0	0
All	All	26165	0	26019	126	0

The all-atom clashscore is defined as the number of clashes found per 1000 atoms (including hydrogen atoms). The all-atom clashscore for this structure is 2.

The worst 5 of 126 close contacts within the same asymmetric unit are listed below, sorted by their clash magnitude.

Atom-1	Atom-2	Interatomic distance (Å)	Clash overlap (Å)
1:C:238:PHE:CZ	1:E:108:ARG:HB2	2.29	0.67
1:E:108:ARG:NH2	7:E:301:CL:CL	2.74	0.58
1:J:281:LEU:HD23	1:J:281:LEU:N	2.24	0.53
1:D:177:LEU:HD23	1:D:263:ILE:CG2	2.42	0.50
1:K:122:GLY:O	1:K:124:PRO:HD3	2.12	0.50

There are no symmetry-related clashes.

5.3 Torsion angles [i](#)

5.3.1 Protein backbone [i](#)

In the following table, the Percentiles column shows the percent Ramachandran outliers of the chain as a percentile score with respect to all X-ray entries followed by that with respect to entries of similar resolution.

The Analysed column shows the number of residues for which the backbone conformation was analysed, and the total number of residues.

Mol	Chain	Analysed	Favoured	Allowed	Outliers	Percentiles	
1	A	278/284 (98%)	274 (99%)	4 (1%)	0	100	100
1	B	278/284 (98%)	274 (99%)	4 (1%)	0	100	100
1	C	277/284 (98%)	274 (99%)	3 (1%)	0	100	100
1	D	275/284 (97%)	269 (98%)	6 (2%)	0	100	100
1	E	277/284 (98%)	275 (99%)	2 (1%)	0	100	100
1	F	278/284 (98%)	272 (98%)	5 (2%)	1 (0%)	34	54
1	G	279/284 (98%)	274 (98%)	5 (2%)	0	100	100
1	H	278/284 (98%)	274 (99%)	4 (1%)	0	100	100
1	I	278/284 (98%)	274 (99%)	4 (1%)	0	100	100
1	J	277/284 (98%)	271 (98%)	6 (2%)	0	100	100
1	K	279/284 (98%)	275 (99%)	4 (1%)	0	100	100
1	L	278/284 (98%)	273 (98%)	5 (2%)	0	100	100
All	All	3332/3408 (98%)	3279 (98%)	52 (2%)	1 (0%)	100	100

All (1) Ramachandran outliers are listed below:

Mol	Chain	Res	Type
1	F	126	ASP

5.3.2 Protein sidechains [i](#)

In the following table, the Percentiles column shows the percent sidechain outliers of the chain as a percentile score with respect to all X-ray entries followed by that with respect to entries of similar resolution.

The Analysed column shows the number of residues for which the sidechain conformation was

analysed, and the total number of residues.

Mol	Chain	Analysed	Rotameric	Outliers	Percentiles	
1	A	228/232 (98%)	228 (100%)	0	100	100
1	B	228/232 (98%)	228 (100%)	0	100	100
1	C	227/232 (98%)	227 (100%)	0	100	100
1	D	225/232 (97%)	225 (100%)	0	100	100
1	E	227/232 (98%)	227 (100%)	0	100	100
1	F	228/232 (98%)	228 (100%)	0	100	100
1	G	229/232 (99%)	229 (100%)	0	100	100
1	H	228/232 (98%)	228 (100%)	0	100	100
1	I	228/232 (98%)	227 (100%)	1 (0%)	91	97
1	J	227/232 (98%)	227 (100%)	0	100	100
1	K	229/232 (99%)	229 (100%)	0	100	100
1	L	228/232 (98%)	228 (100%)	0	100	100
All	All	2732/2784 (98%)	2731 (100%)	1 (0%)	100	100

All (1) residues with a non-rotameric sidechain are listed below:

Mol	Chain	Res	Type
1	I	231	ASN

Sometimes sidechains can be flipped to improve hydrogen bonding and reduce clashes. There are no such sidechains identified.

5.3.3 RNA [i](#)

There are no RNA molecules in this entry.

5.4 Non-standard residues in protein, DNA, RNA chains [i](#)

There are no non-standard protein/DNA/RNA residues in this entry.

5.5 Carbohydrates [i](#)

There are no monosaccharides in this entry.

5.6 Ligand geometry

Of 52 ligands modelled in this entry, 16 are monoatomic - leaving 36 for Mogul analysis.

In the following table, the Counts columns list the number of bonds (or angles) for which Mogul statistics could be retrieved, the number of bonds (or angles) that are observed in the model and the number of bonds (or angles) that are defined in the Chemical Component Dictionary. The Link column lists molecule types, if any, to which the group is linked. The Z score for a bond length (or angle) is the number of standard deviations the observed value is removed from the expected value. A bond length (or angle) with $|Z| > 2$ is considered an outlier worth inspection. RMSZ is the root-mean-square of all Z scores of the bond lengths (or angles).

Mol	Type	Chain	Res	Link	Bond lengths			Bond angles		
					Counts	RMSZ	# Z > 2	Counts	RMSZ	# Z > 2
6	SF4	K	301	1	0,12,12	-	-	-	-	-
4	NO3	I	305	-	1,3,3	0.30	0	0,3,3	-	-
2	ADP	I	302	3	24,29,29	0.95	1 (4%)	29,45,45	1.29	4 (13%)
8	GOL	I	306	-	5,5,5	0.08	0	5,5,5	0.31	0
4	NO3	L	403	-	1,3,3	0.20	0	0,3,3	-	-
2	ADP	A	501	3	24,29,29	0.99	1 (4%)	29,45,45	1.27	4 (13%)
4	NO3	F	403	-	1,3,3	0.13	0	0,3,3	-	-
2	ADP	E	303	-	24,29,29	0.97	1 (4%)	29,45,45	1.31	4 (13%)
4	NO3	I	307	-	1,3,3	0.37	0	0,3,3	-	-
4	NO3	A	503	-	1,3,3	0.18	0	0,3,3	-	-
2	ADP	K	302	3	24,29,29	0.96	1 (4%)	29,45,45	1.31	4 (13%)
5	EDO	A	505	-	3,3,3	0.06	0	2,2,2	0.15	0
5	EDO	I	304	-	3,3,3	0.05	0	2,2,2	0.18	0
5	EDO	G	504	-	3,3,3	0.06	0	2,2,2	0.20	0
4	NO3	F	404	-	1,3,3	0.09	0	0,3,3	-	-
6	SF4	E	302	1	0,12,12	-	-	-	-	-
2	ADP	J	401	3	24,29,29	0.93	1 (4%)	29,45,45	1.32	3 (10%)
2	ADP	G	501	3	24,29,29	0.95	1 (4%)	29,45,45	1.28	3 (10%)
6	SF4	B	301	1	0,12,12	-	-	-	-	-
6	SF4	I	301	1	0,12,12	-	-	-	-	-
4	NO3	A	504	-	1,3,3	0.27	0	0,3,3	-	-
2	ADP	B	302	3	24,29,29	0.98	1 (4%)	29,45,45	1.30	4 (13%)
5	EDO	I	308	-	3,3,3	0.06	0	2,2,2	0.20	0
2	ADP	H	302	3	24,29,29	0.95	1 (4%)	29,45,45	1.32	4 (13%)
4	NO3	K	304	-	1,3,3	0.05	0	0,3,3	-	-
2	ADP	C	302	3	24,29,29	0.96	1 (4%)	29,45,45	1.29	4 (13%)
2	ADP	D	401	3	24,29,29	0.95	1 (4%)	29,45,45	1.30	3 (10%)
5	EDO	G	503	-	3,3,3	0.06	0	2,2,2	0.18	0
6	SF4	C	301	1	0,12,12	-	-	-	-	-
6	SF4	H	301	1	0,12,12	-	-	-	-	-

Mol	Type	Chain	Res	Link	Bond lengths			Bond angles		
					Counts	RMSZ	# Z > 2	Counts	RMSZ	# Z > 2
8	GOL	K	305	-	5,5,5	0.09	0	5,5,5	0.33	0
4	NO3	A	506	-	1,3,3	0.25	0	0,3,3	-	-
2	ADP	F	401	3	24,29,29	0.95	1 (4%)	29,45,45	1.31	4 (13%)
4	NO3	H	305	-	1,3,3	0.20	0	0,3,3	-	-
2	ADP	L	401	3	24,29,29	0.93	1 (4%)	29,45,45	1.29	3 (10%)
5	EDO	H	304	-	3,3,3	0.05	0	2,2,2	0.15	0

In the following table, the Chirals column lists the number of chiral outliers, the number of chiral centers analysed, the number of these observed in the model and the number defined in the Chemical Component Dictionary. Similar counts are reported in the Torsion and Rings columns. '-' means no outliers of that kind were identified.

Mol	Type	Chain	Res	Link	Chirals	Torsions	Rings
6	SF4	K	301	1	-	-	0/6/5/5
2	ADP	I	302	3	-	0/12/32/32	0/3/3/3
8	GOL	I	306	-	-	2/4/4/4	-
2	ADP	A	501	3	-	1/12/32/32	0/3/3/3
2	ADP	E	303	-	-	0/12/32/32	0/3/3/3
2	ADP	K	302	3	-	0/12/32/32	0/3/3/3
5	EDO	A	505	-	-	0/1/1/1	-
5	EDO	I	304	-	-	1/1/1/1	-
5	EDO	G	504	-	-	1/1/1/1	-
6	SF4	E	302	1	-	-	0/6/5/5
2	ADP	J	401	3	-	0/12/32/32	0/3/3/3
2	ADP	G	501	3	-	0/12/32/32	0/3/3/3
6	SF4	B	301	1	-	-	0/6/5/5
6	SF4	I	301	1	-	-	0/6/5/5
2	ADP	B	302	3	-	0/12/32/32	0/3/3/3
5	EDO	I	308	-	-	1/1/1/1	-
2	ADP	H	302	3	-	0/12/32/32	0/3/3/3
2	ADP	C	302	3	-	0/12/32/32	0/3/3/3
2	ADP	D	401	3	-	0/12/32/32	0/3/3/3
5	EDO	G	503	-	-	1/1/1/1	-
6	SF4	C	301	1	-	-	0/6/5/5
6	SF4	H	301	1	-	-	0/6/5/5
8	GOL	K	305	-	-	2/4/4/4	-
2	ADP	F	401	3	-	0/12/32/32	0/3/3/3
5	EDO	H	304	-	-	0/1/1/1	-
2	ADP	L	401	3	-	0/12/32/32	0/3/3/3

The worst 5 of 12 bond length outliers are listed below:

Mol	Chain	Res	Type	Atoms	Z	Observed(Å)	Ideal(Å)
2	A	501	ADP	C5-C4	2.49	1.47	1.40
2	E	303	ADP	C5-C4	2.45	1.47	1.40
2	F	401	ADP	C5-C4	2.45	1.47	1.40
2	K	302	ADP	C5-C4	2.41	1.47	1.40
2	H	302	ADP	C5-C4	2.41	1.47	1.40

The worst 5 of 44 bond angle outliers are listed below:

Mol	Chain	Res	Type	Atoms	Z	Observed(°)	Ideal(°)
2	H	302	ADP	N3-C2-N1	-3.99	122.45	128.68
2	F	401	ADP	N3-C2-N1	-3.98	122.46	128.68
2	K	302	ADP	N3-C2-N1	-3.94	122.52	128.68
2	E	303	ADP	N3-C2-N1	-3.93	122.54	128.68
2	D	401	ADP	N3-C2-N1	-3.90	122.58	128.68

There are no chirality outliers.

5 of 9 torsion outliers are listed below:

Mol	Chain	Res	Type	Atoms
8	K	305	GOL	O1-C1-C2-C3
8	K	305	GOL	O1-C1-C2-O2
8	I	306	GOL	O1-C1-C2-C3
5	I	308	EDO	O1-C1-C2-O2
5	G	503	EDO	O1-C1-C2-O2

There are no ring outliers.

2 monomers are involved in 2 short contacts:

Mol	Chain	Res	Type	Clashes	Symm-Clashes
4	I	305	NO3	1	0
2	K	302	ADP	1	0

The following is a two-dimensional graphical depiction of Mogul quality analysis of bond lengths, bond angles, torsion angles, and ring geometry for all instances of the Ligand of Interest. In addition, ligands with molecular weight > 250 and outliers as shown on the validation Tables will also be included. For torsion angles, if less than 5% of the Mogul distribution of torsion angles is within 10 degrees of the torsion angle in question, then that torsion angle is considered an outlier. Any bond that is central to one or more torsion angles identified as an outlier by Mogul will be highlighted in the graph. For rings, the root-mean-square deviation (RMSD) between the ring in question and similar rings identified by Mogul is calculated over all ring torsion angles. If the average RMSD is greater than 60 degrees and the minimal RMSD between the ring in question and any Mogul-identified rings is also greater than 60 degrees, then that ring is considered an outlier. The outliers are highlighted in purple. The color gray indicates Mogul did not find sufficient

equivalents in the CSD to analyse the geometry.

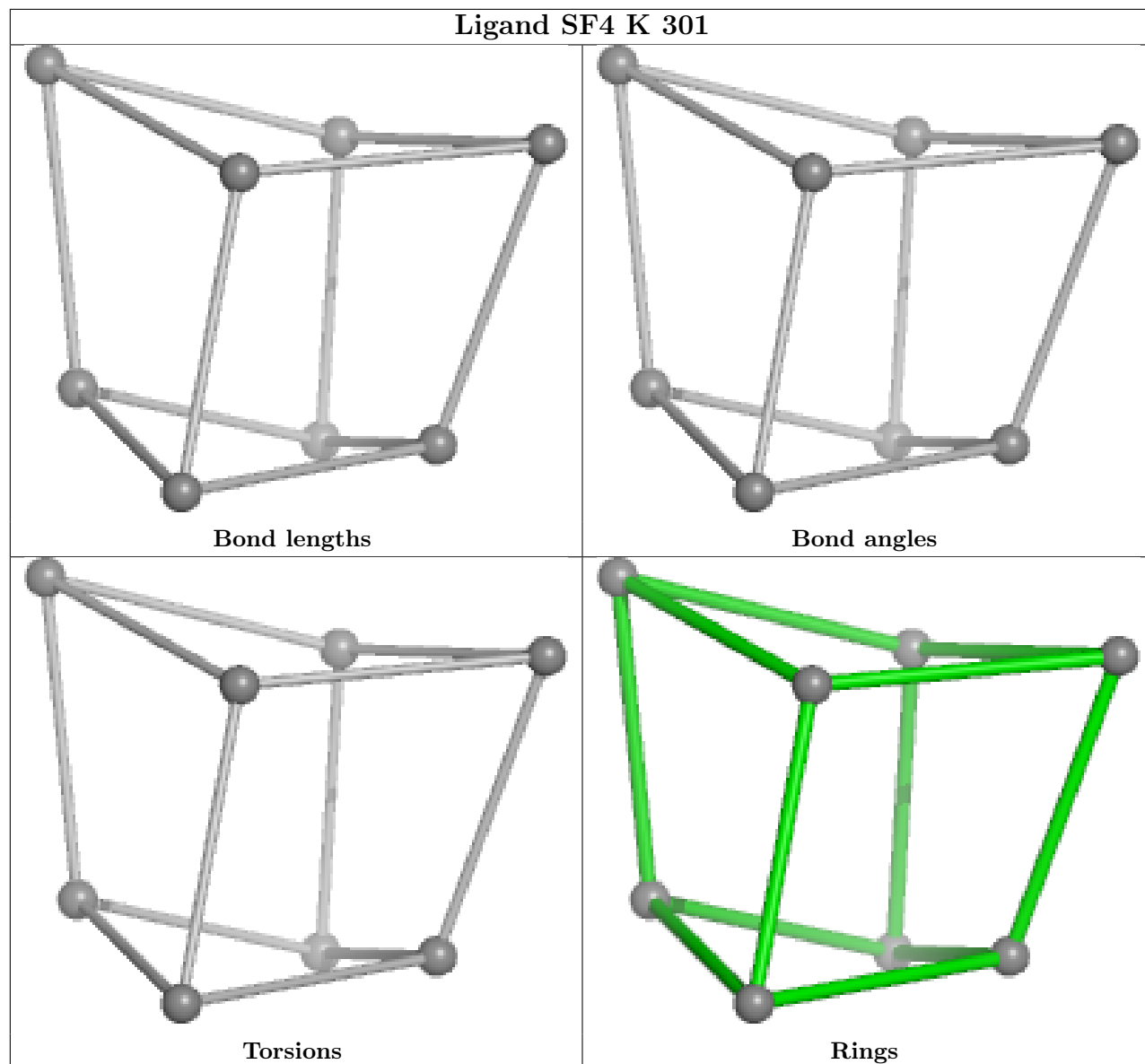

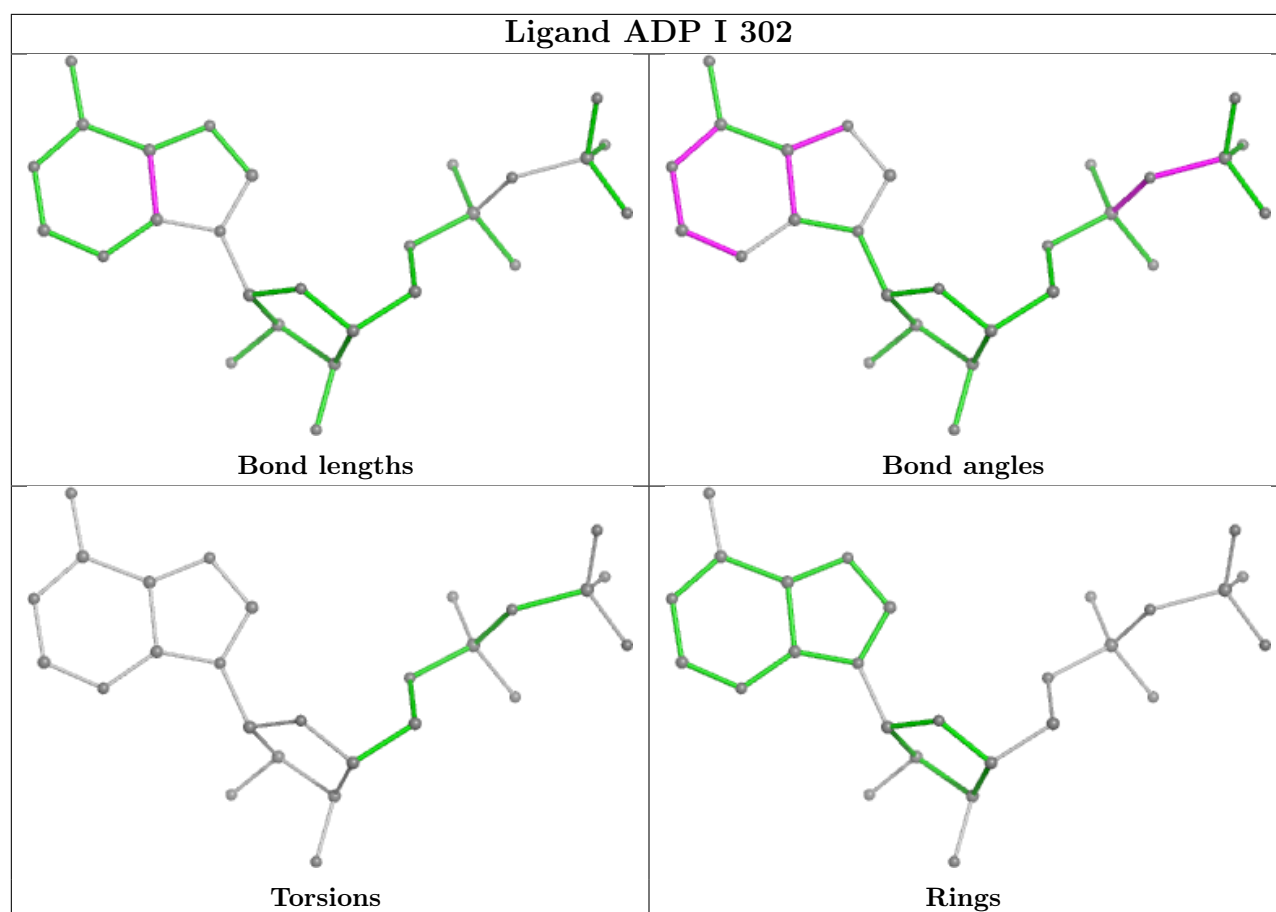

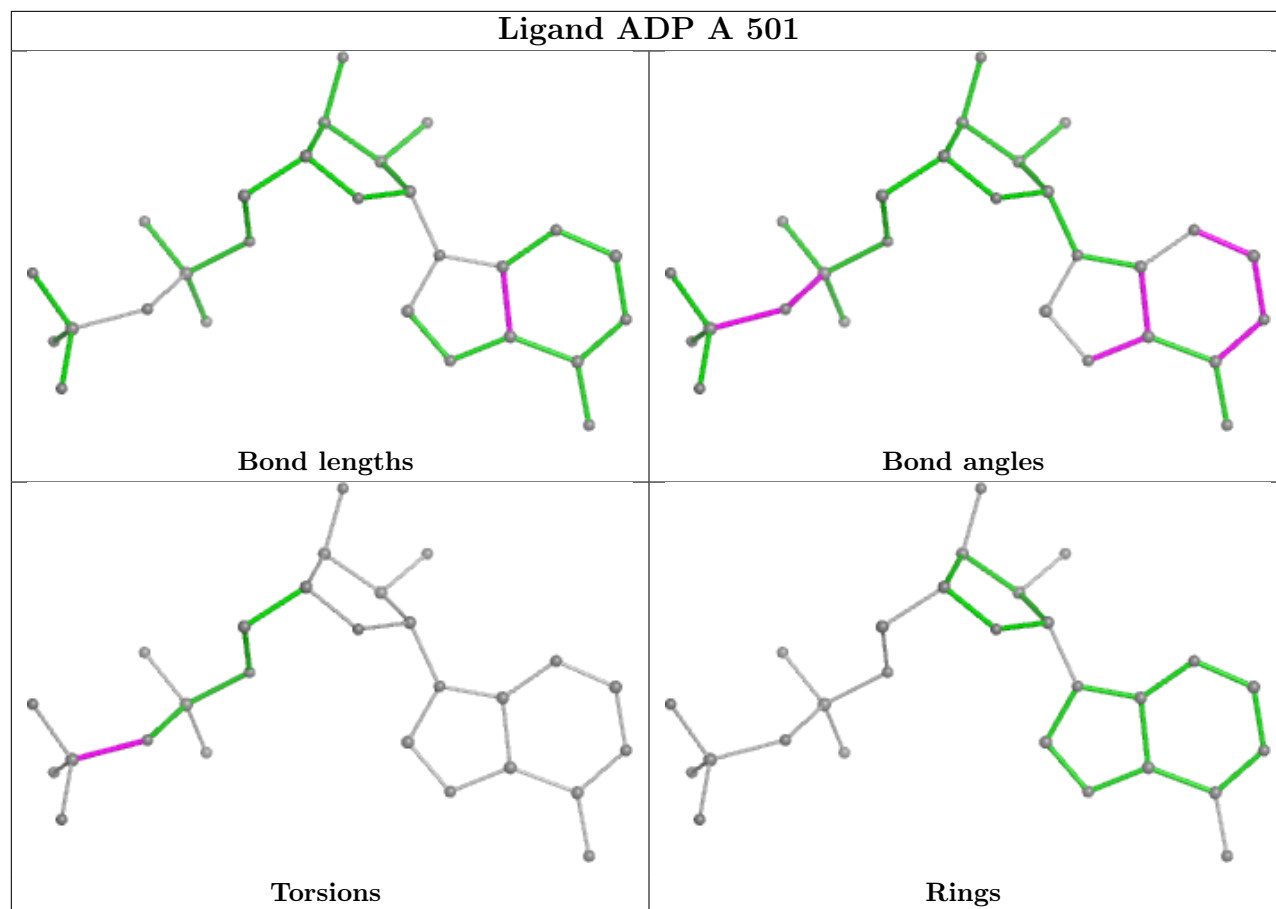

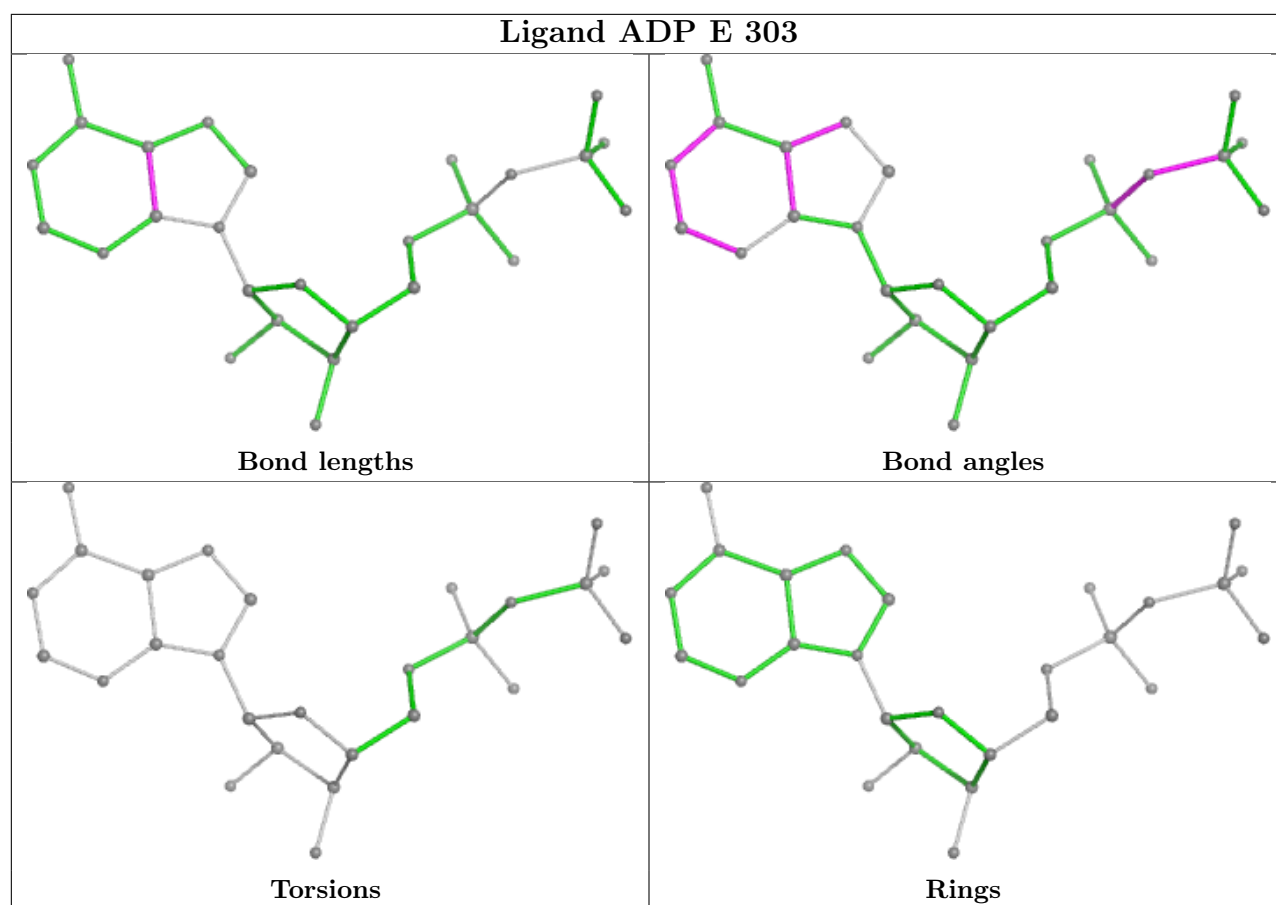

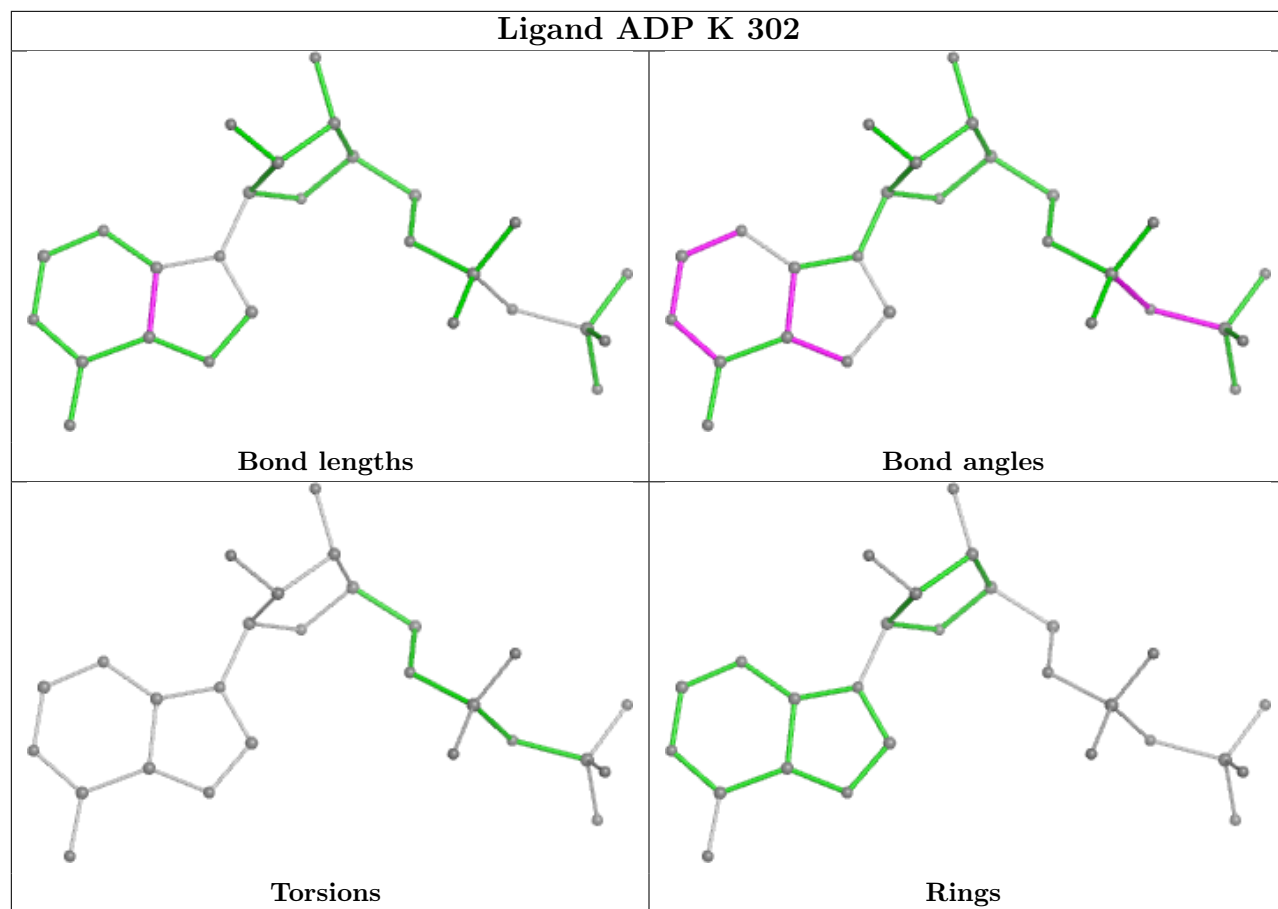

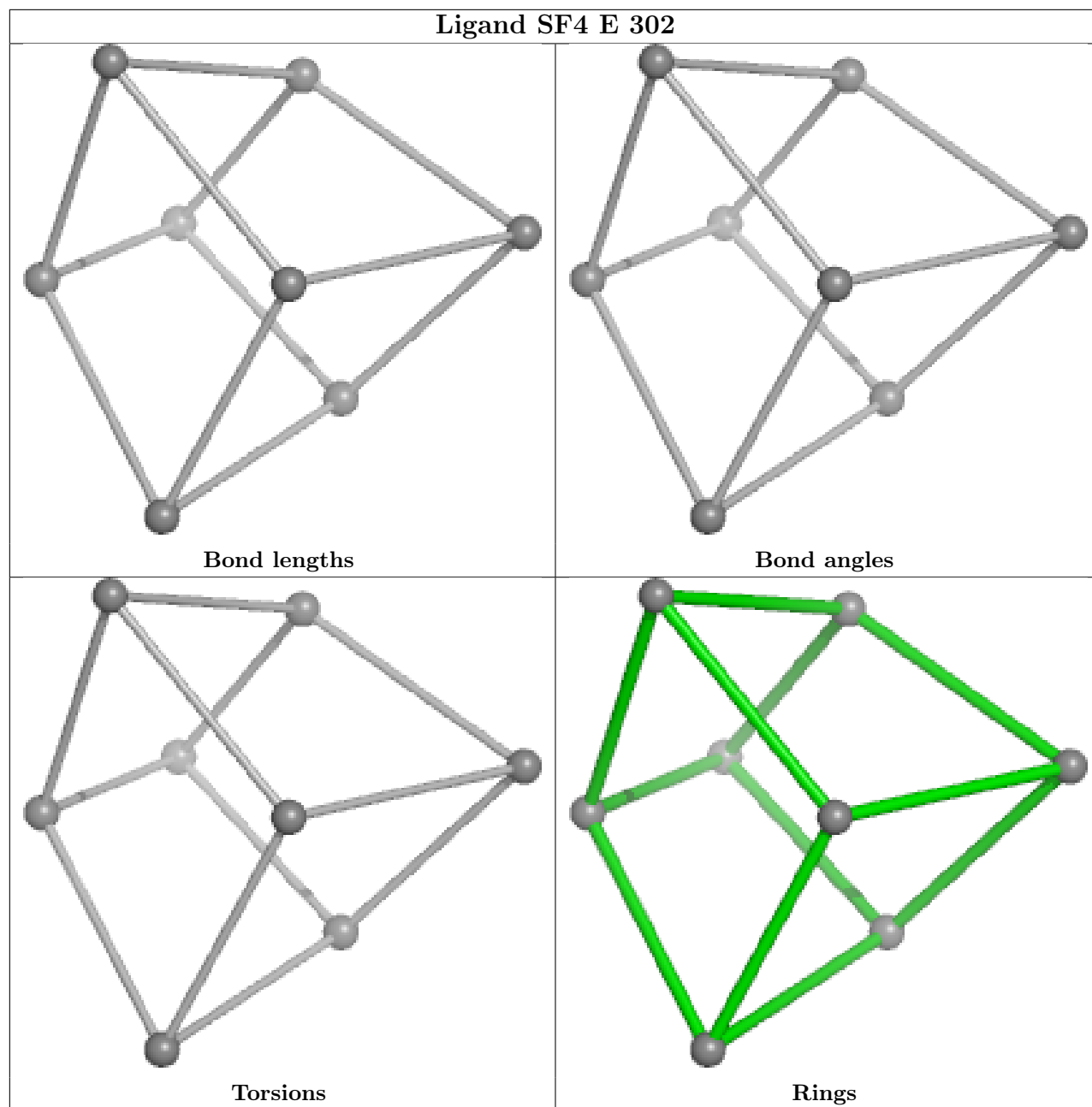

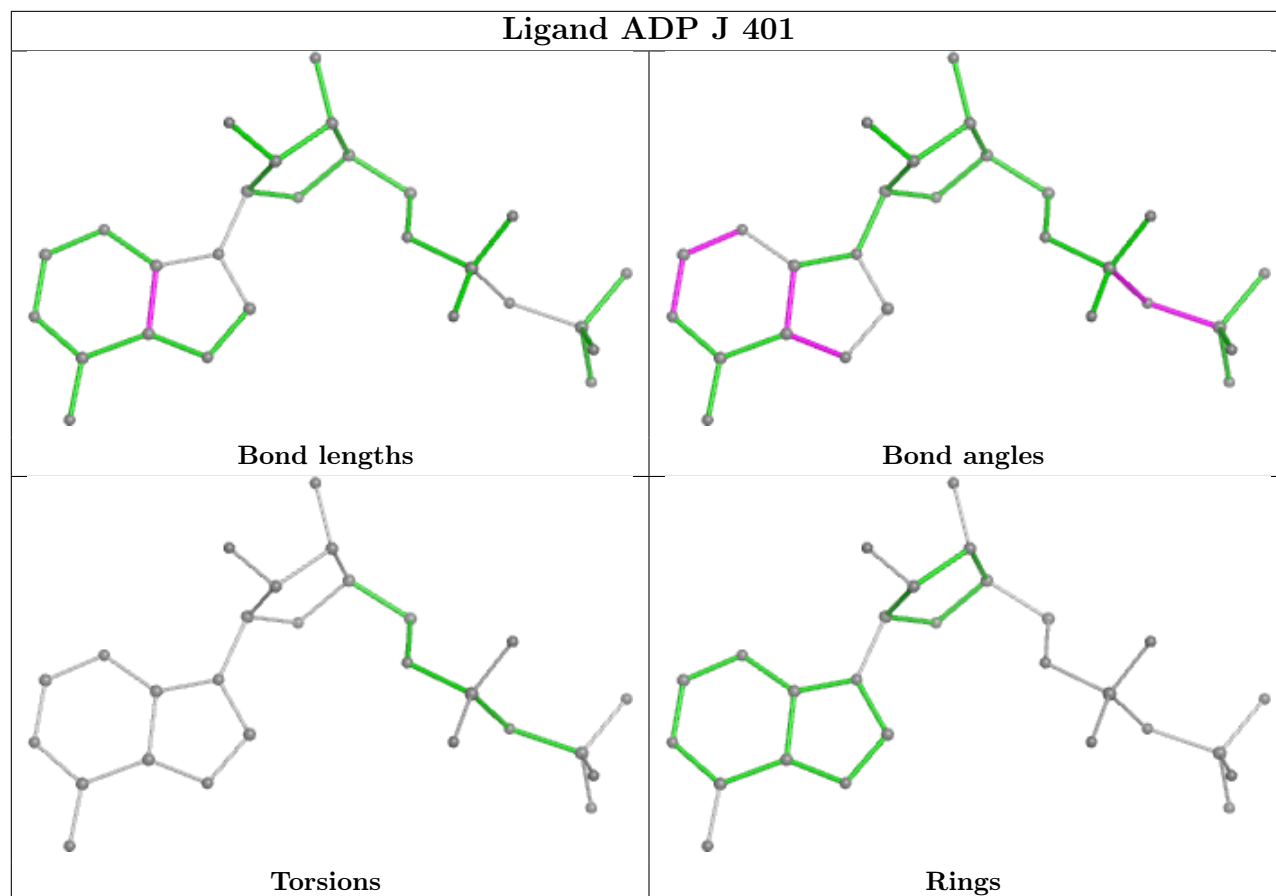

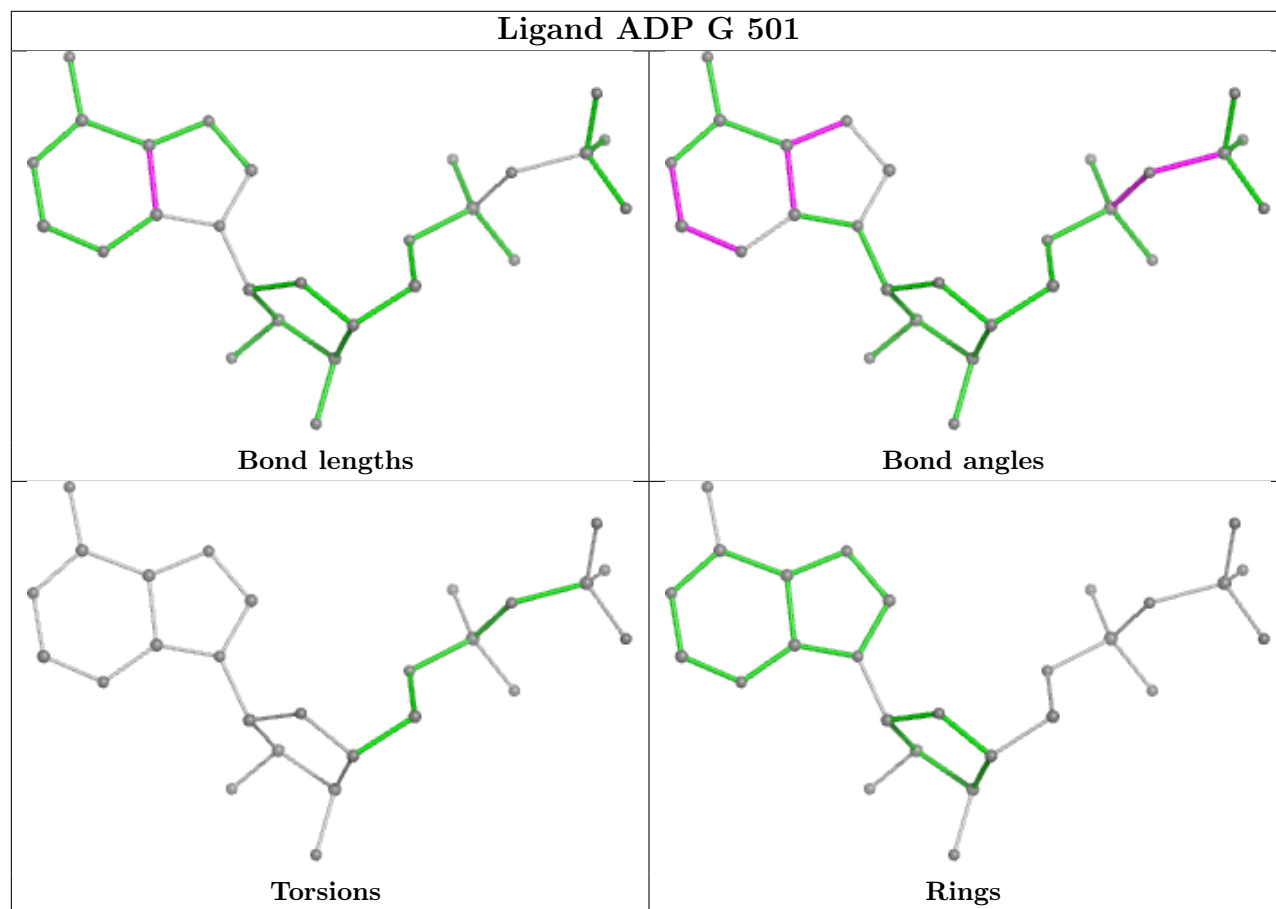

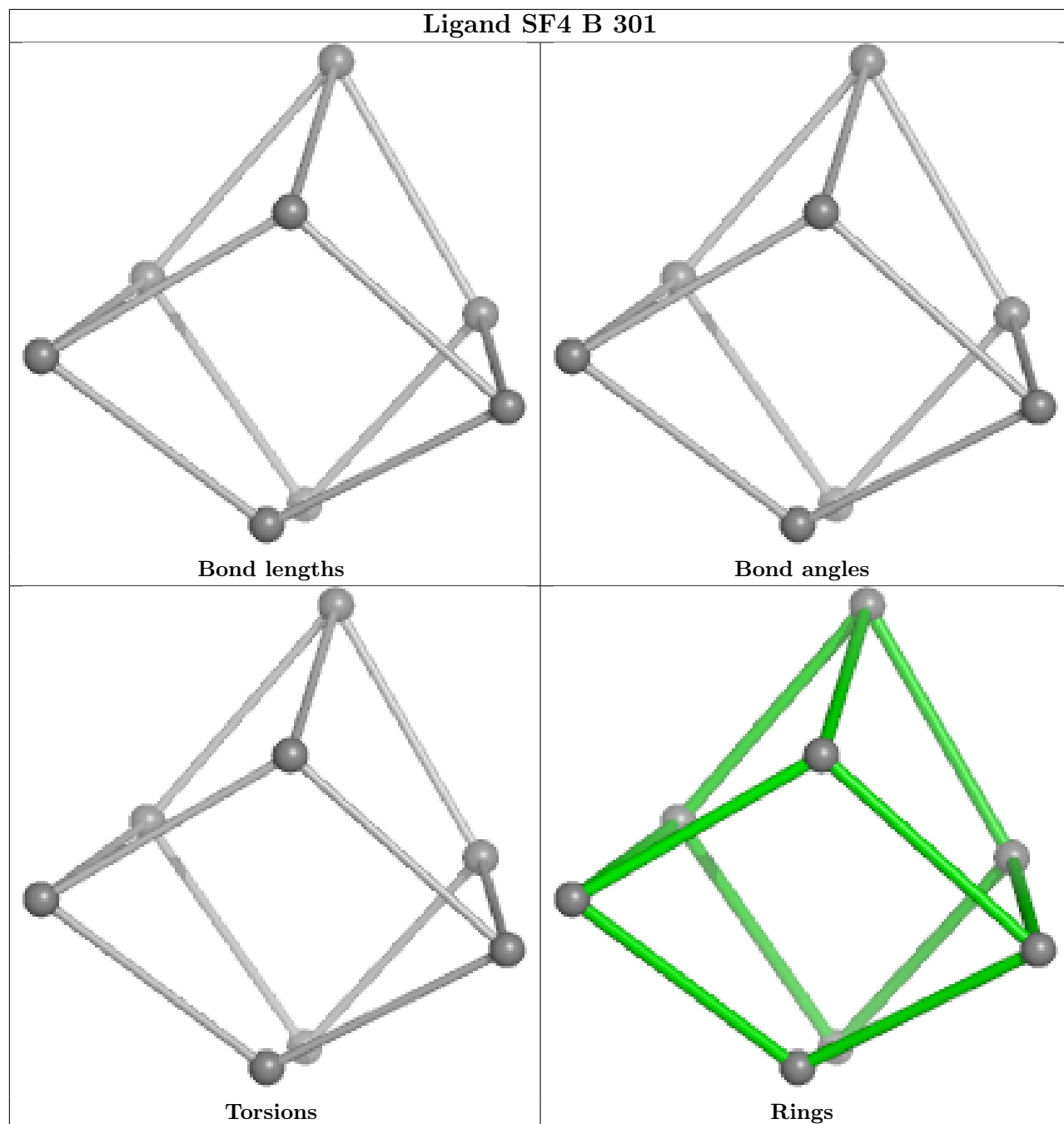

Ligand SF4 I 301

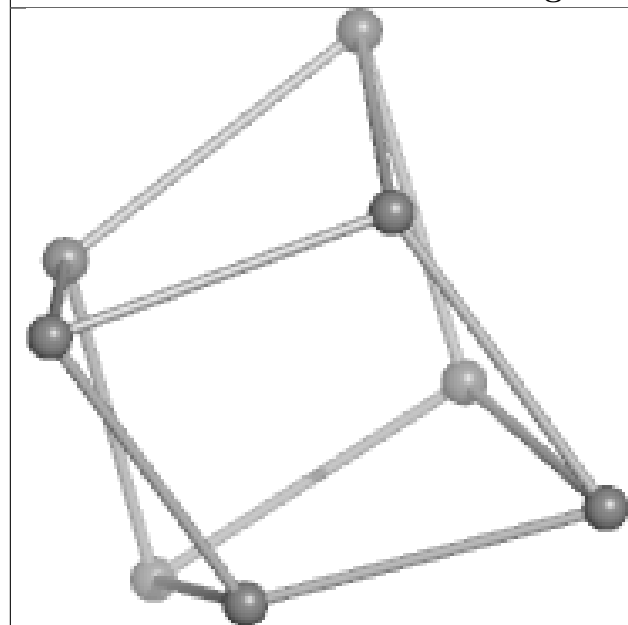

Bond lengths

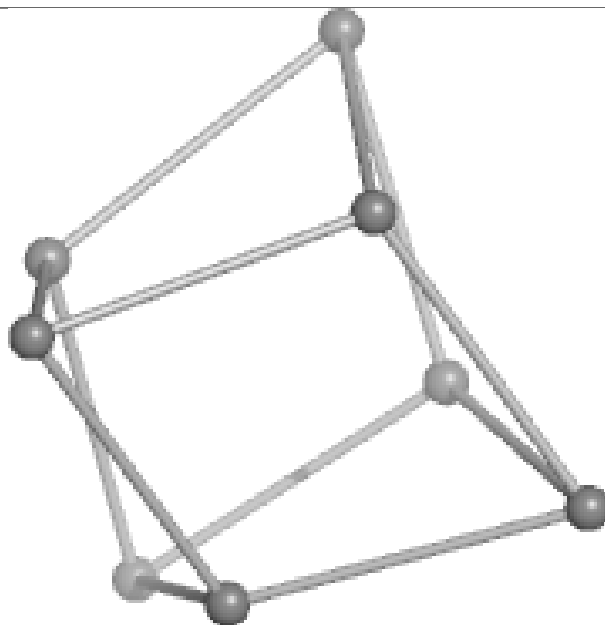

Bond angles

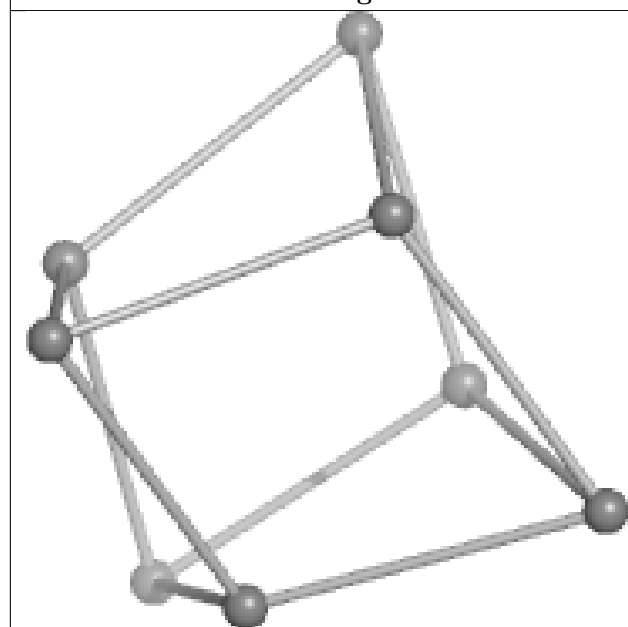

Torsions

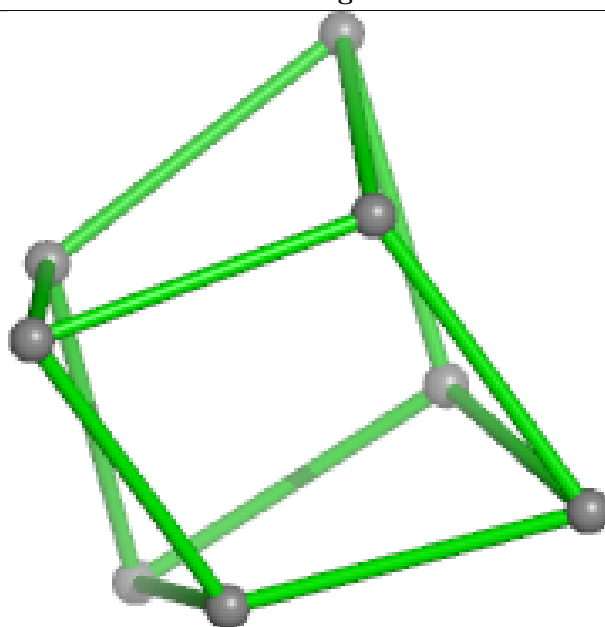

Rings

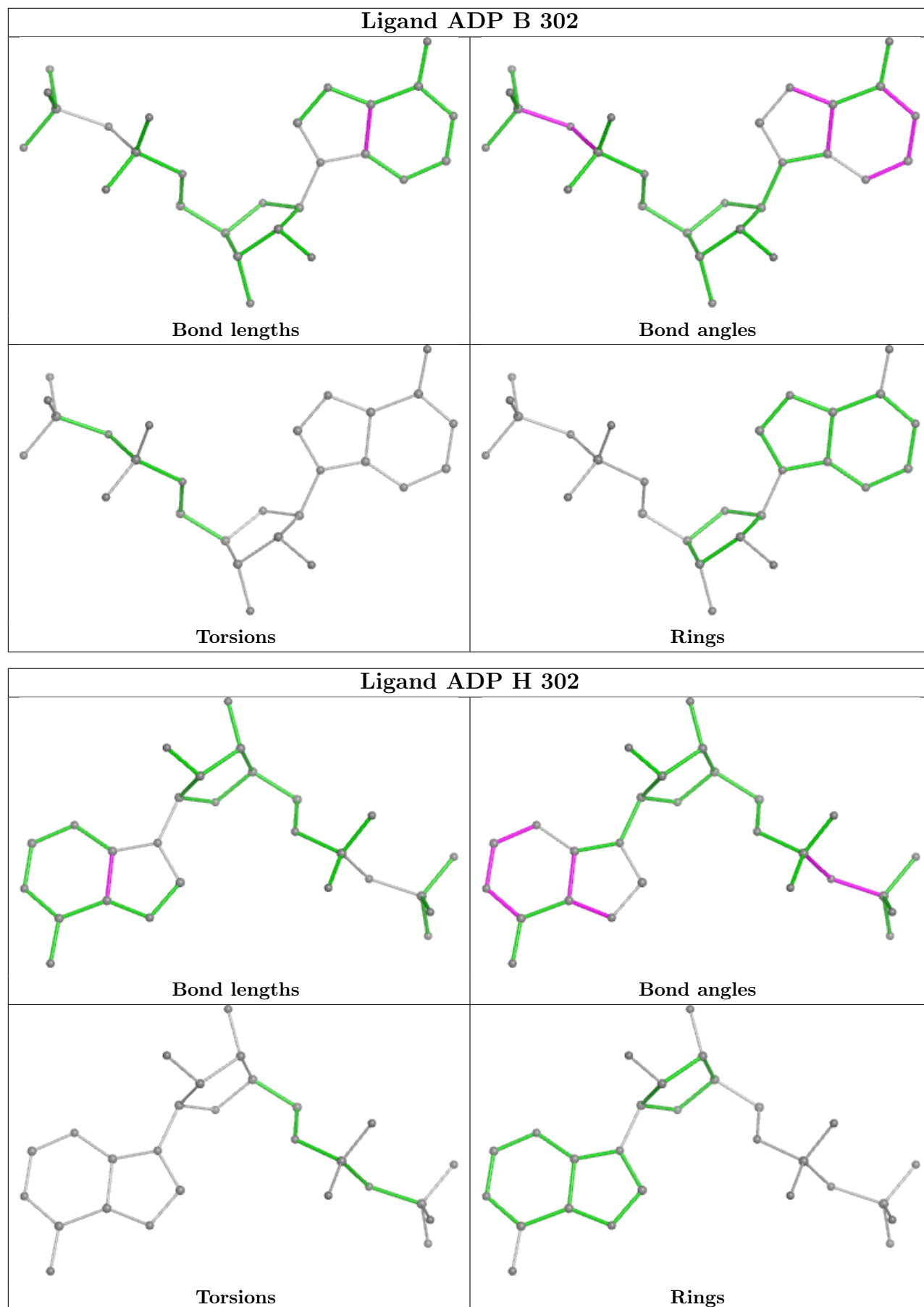

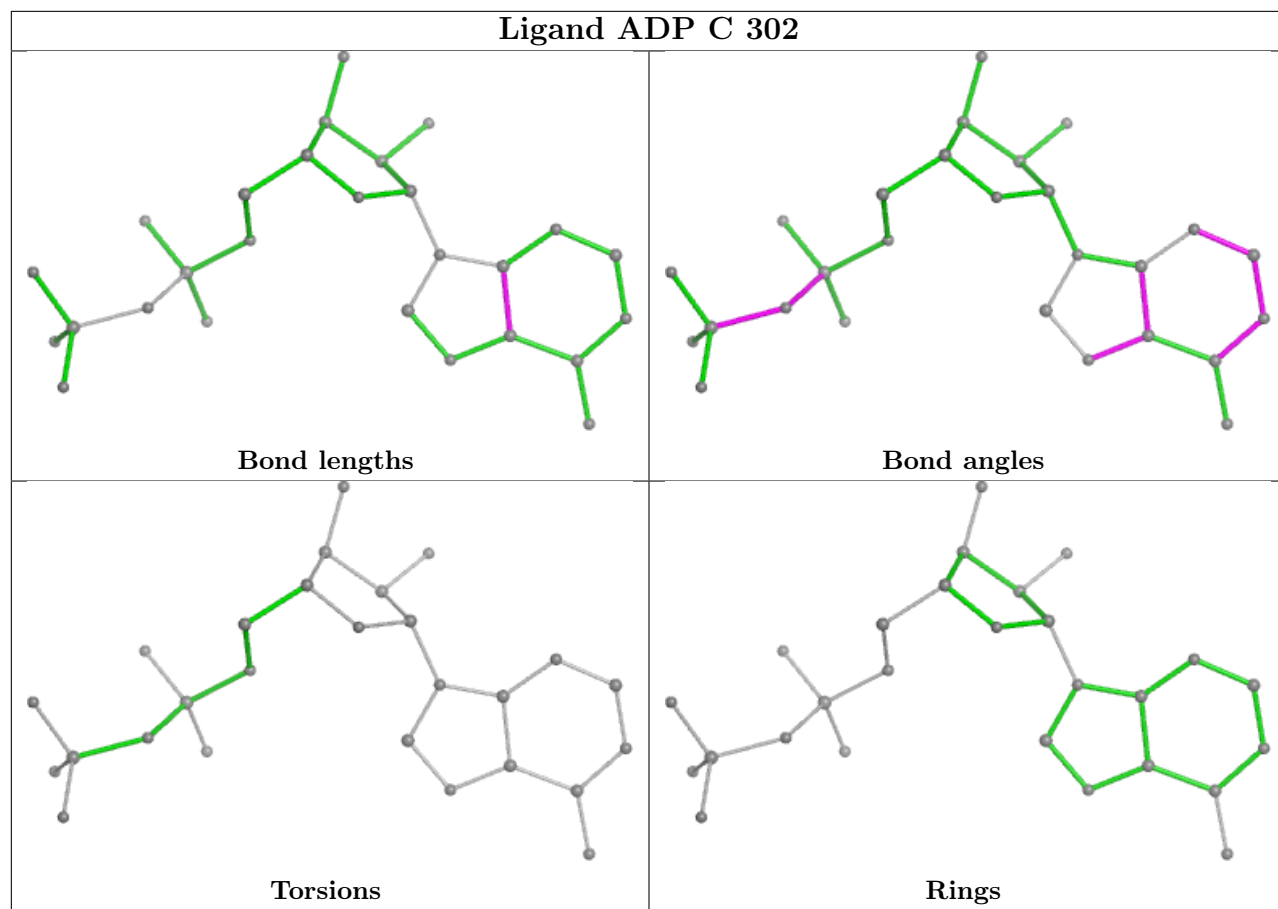

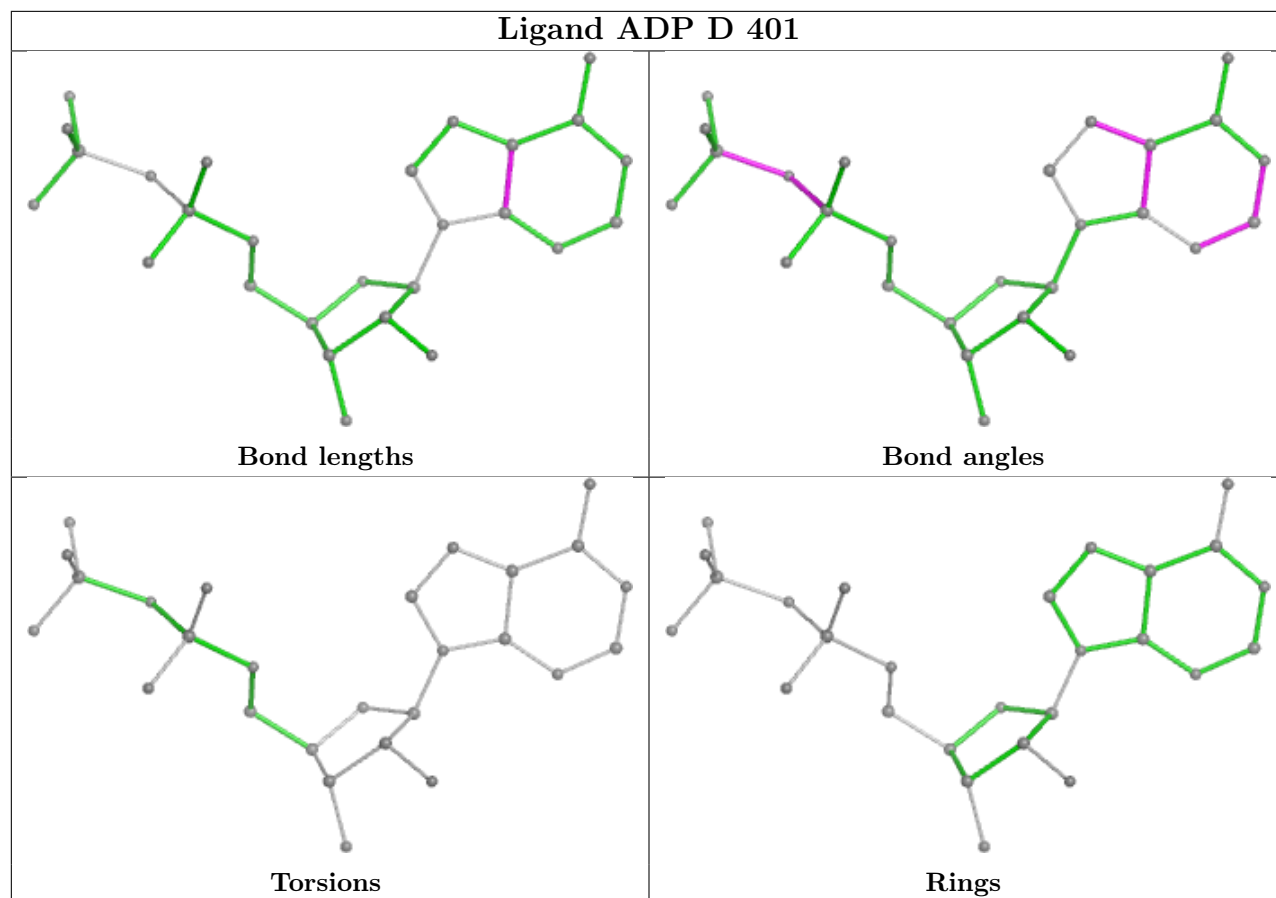

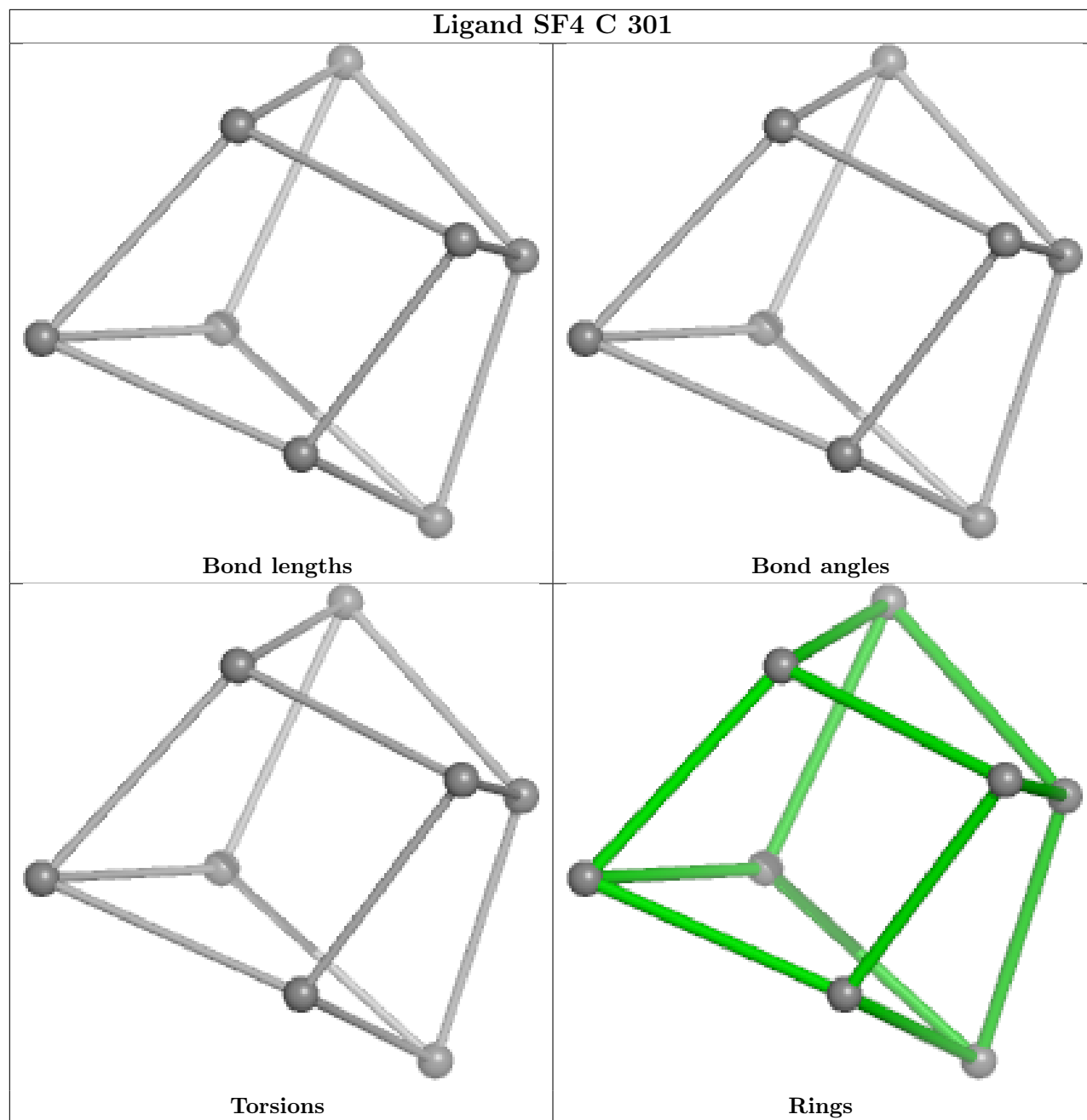

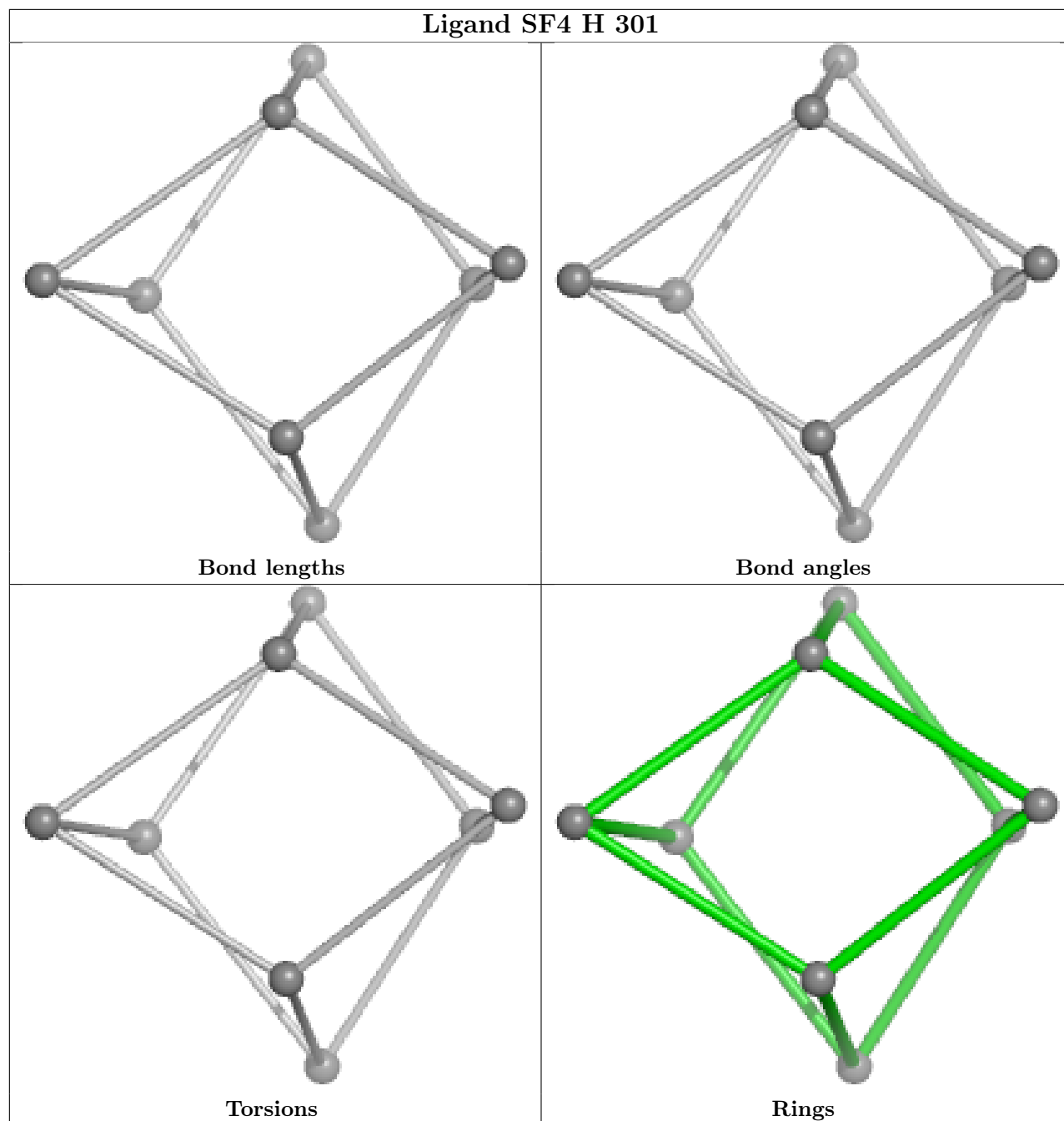

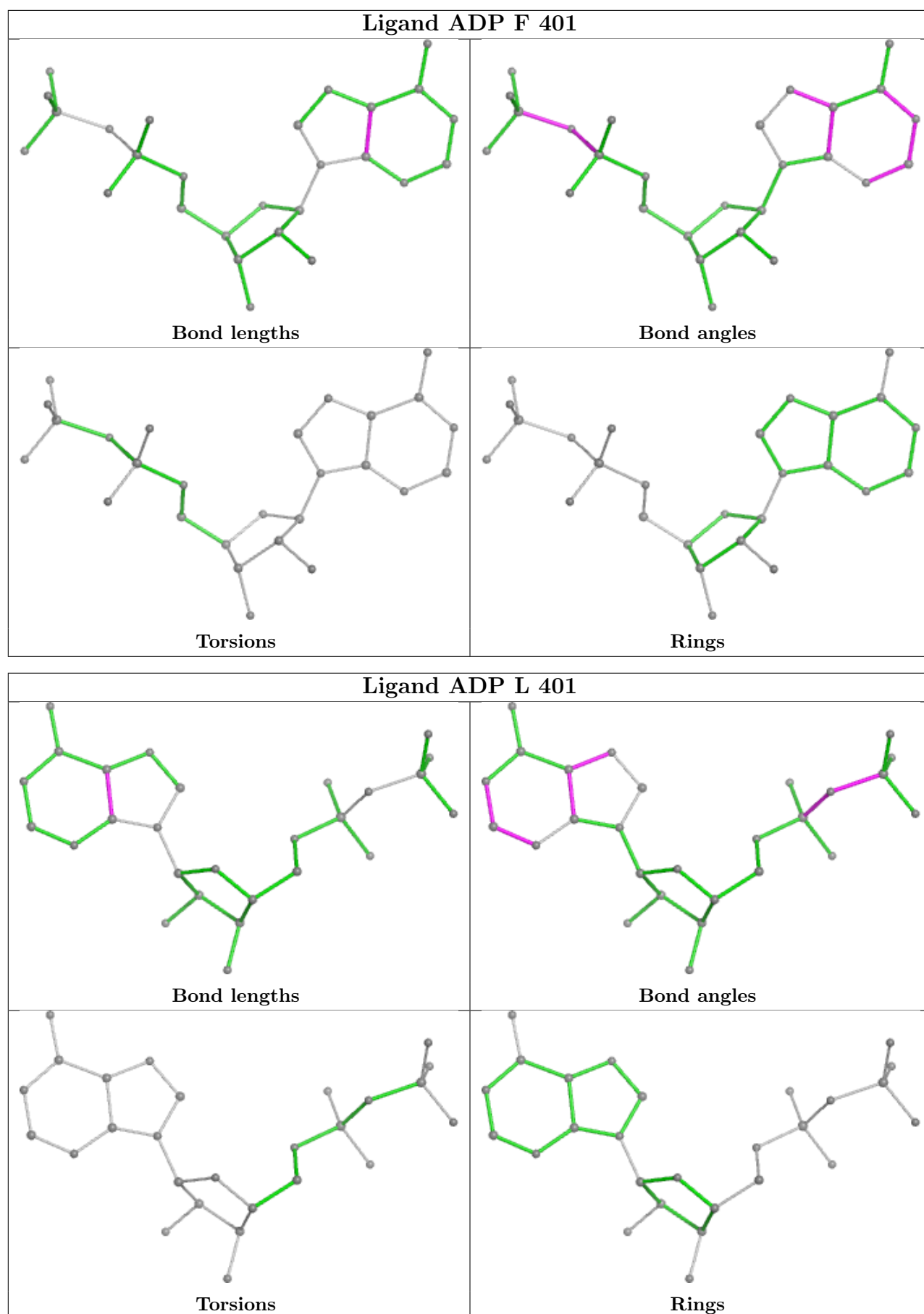

5.7 Other polymers [i](#)

There are no such residues in this entry.

5.8 Polymer linkage issues [i](#)

There are no chain breaks in this entry.

6 Fit of model and data [i](#)

6.1 Protein, DNA and RNA chains [i](#)

In the following table, the column labelled ‘#RSRZ> 2’ contains the number (and percentage) of RSRZ outliers, followed by percent RSRZ outliers for the chain as percentile scores relative to all X-ray entries and entries of similar resolution. The OWAB column contains the minimum, median, 95th percentile and maximum values of the occupancy-weighted average B-factor per residue. The column labelled ‘Q< 0.9’ lists the number of (and percentage) of residues with an average occupancy less than 0.9.

Mol	Chain	Analysed	<RSRZ>	#RSRZ>2	OWAB(Å ²)	Q<0.9
1	A	280/284 (98%)	0.45	7 (2%) 57 61	48, 60, 91, 123	0
1	B	280/284 (98%)	0.43	11 (3%) 39 42	54, 75, 102, 121	0
1	C	279/284 (98%)	0.46	12 (4%) 35 38	52, 77, 125, 151	0
1	D	277/284 (97%)	1.04	56 (20%) 1 0	57, 118, 154, 182	0
1	E	279/284 (98%)	0.89	39 (13%) 2 2	65, 114, 148, 167	0
1	F	280/284 (98%)	0.37	6 (2%) 63 66	51, 69, 103, 132	0
1	G	281/284 (98%)	0.44	12 (4%) 35 38	48, 61, 93, 122	0
1	H	280/284 (98%)	0.39	13 (4%) 32 34	48, 72, 102, 139	0
1	I	280/284 (98%)	0.25	6 (2%) 63 66	46, 58, 90, 118	0
1	J	279/284 (98%)	0.49	13 (4%) 31 33	50, 85, 116, 140	0
1	K	281/284 (98%)	0.31	6 (2%) 63 66	48, 69, 96, 180	0
1	L	280/284 (98%)	0.29	3 (1%) 80 82	46, 58, 84, 117	0
All	All	3356/3408 (98%)	0.48	184 (5%) 25 26	46, 73, 129, 182	0

The worst 5 of 184 RSRZ outliers are listed below:

Mol	Chain	Res	Type	RSRZ
1	J	3	PHE	13.5
1	D	44	ILE	10.1
1	K	3	PHE	8.3
1	D	224	ILE	7.5
1	E	230	PHE	7.2

6.2 Non-standard residues in protein, DNA, RNA chains [i](#)

There are no non-standard protein/DNA/RNA residues in this entry.

6.3 Carbohydrates [i](#)

There are no monosaccharides in this entry.

6.4 Ligands [i](#)

In the following table, the Atoms column lists the number of modelled atoms in the group and the number defined in the chemical component dictionary. The B-factors column lists the minimum, median, 95th percentile and maximum values of B factors of atoms in the group. The column labelled 'Q< 0.9' lists the number of atoms with occupancy less than 0.9.

Mol	Type	Chain	Res	Atoms	RSCC	RSR	B-factors(Å ²)	Q<0.9
4	NO3	L	403	4/4	0.53	0.67	86,87,90,105	0
8	GOL	K	305	6/6	0.69	0.35	69,77,81,82	0
5	EDO	I	308	4/4	0.70	0.33	55,57,62,65	0
4	NO3	H	305	4/4	0.76	0.13	88,90,90,91	0
5	EDO	G	504	4/4	0.76	0.26	76,77,77,81	0
7	CL	L	404	1/1	0.77	0.11	72,72,72,72	0
4	NO3	K	304	4/4	0.83	0.41	67,70,72,80	0
4	NO3	A	504	4/4	0.83	0.63	66,71,73,73	0
5	EDO	A	505	4/4	0.84	0.37	60,61,62,69	0
4	NO3	I	305	4/4	0.85	0.47	75,79,83,88	0
4	NO3	A	503	4/4	0.85	0.58	84,86,87,88	0
7	CL	E	301	1/1	0.86	0.20	73,73,73,73	0
5	EDO	G	503	4/4	0.88	0.42	70,71,71,72	0
8	GOL	I	306	6/6	0.88	0.10	78,79,80,82	0
4	NO3	A	506	4/4	0.88	0.51	62,64,66,83	0
4	NO3	F	404	4/4	0.89	0.19	64,68,69,72	0
2	ADP	D	401	27/27	0.90	0.13	99,110,121,125	0
3	MG	D	402	1/1	0.90	0.35	105,105,105,105	0
5	EDO	H	304	4/4	0.92	0.59	71,72,72,73	0
3	MG	C	303	1/1	0.92	0.30	63,63,63,63	0
4	NO3	I	307	4/4	0.93	0.13	61,62,62,64	0
2	ADP	E	303	27/27	0.93	0.14	84,93,106,110	0
3	MG	E	304	1/1	0.93	0.26	88,88,88,88	0
3	MG	J	402	1/1	0.93	0.28	66,66,66,66	0
5	EDO	I	304	4/4	0.94	0.24	56,56,59,64	0
3	MG	F	402	1/1	0.94	0.37	58,58,58,58	0
3	MG	I	303	1/1	0.95	0.38	50,50,50,50	0
3	MG	L	402	1/1	0.95	0.37	50,50,50,50	0
7	CL	J	403	1/1	0.95	0.18	71,71,71,71	0
2	ADP	F	401	27/27	0.96	0.17	58,62,72,74	0
2	ADP	H	302	27/27	0.96	0.14	53,56,62,64	0
3	MG	A	502	1/1	0.96	0.32	49,49,49,49	0

Continued on next page...

Continued from previous page...

Mol	Type	Chain	Res	Atoms	RSCC	RSR	B-factors(\AA^2)	Q<0.9
2	ADP	B	302	27/27	0.96	0.16	59,65,71,73	0
2	ADP	C	302	27/27	0.96	0.17	65,69,75,76	0
4	NO3	F	403	4/4	0.97	0.50	67,73,75,76	0
3	MG	K	303	1/1	0.97	0.37	54,54,54,54	0
2	ADP	J	401	27/27	0.97	0.14	65,68,81,86	0
3	MG	H	303	1/1	0.97	0.35	56,56,56,56	0
2	ADP	L	401	27/27	0.97	0.16	43,49,56,57	0
2	ADP	A	501	27/27	0.97	0.17	42,53,58,59	0
6	SF4	B	301	8/8	0.98	0.25	44,51,53,53	0
6	SF4	C	301	8/8	0.98	0.23	56,57,60,62	0
6	SF4	H	301	8/8	0.98	0.24	46,51,54,54	0
6	SF4	K	301	8/8	0.98	0.26	46,49,52,56	0
2	ADP	I	302	27/27	0.98	0.18	43,50,53,55	0
7	CL	G	505	1/1	0.98	0.24	71,71,71,71	0
2	ADP	G	501	27/27	0.98	0.17	38,51,54,55	0
3	MG	B	303	1/1	0.98	0.38	61,61,61,61	0
3	MG	G	502	1/1	0.98	0.31	49,49,49,49	0
2	ADP	K	302	27/27	0.98	0.14	47,58,65,66	0
6	SF4	I	301	8/8	0.99	0.21	53,54,57,58	0
6	SF4	E	302	8/8	0.99	0.26	65,71,74,86	0

The following is a graphical depiction of the model fit to experimental electron density of all instances of the Ligand of Interest. In addition, ligands with molecular weight > 250 and outliers as shown on the geometry validation Tables will also be included. Each fit is shown from different orientation to approximate a three-dimensional view.

Electron density around ADP D 401:

$2mF_o-DF_c$ (at 0.7 rmsd) in gray
 mF_o-DF_c (at 3 rmsd) in purple (negative)
and green (positive)

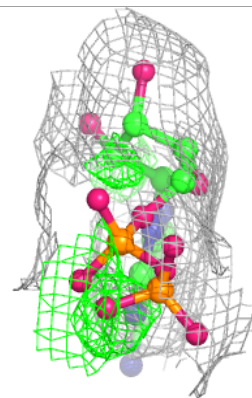
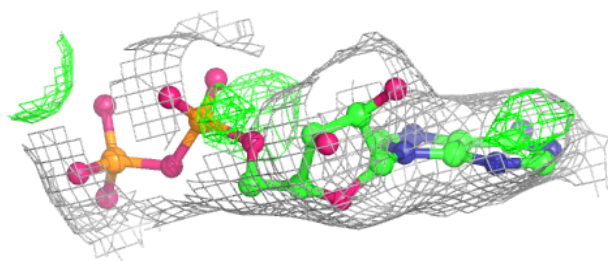
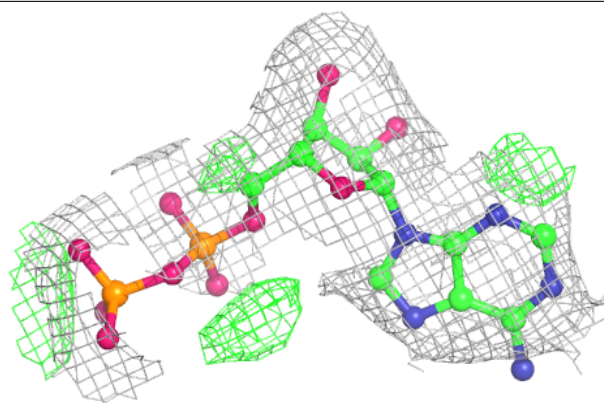

Electron density around MG D 402:

$2mF_o-DF_c$ (at 0.7 rmsd) in gray
 mF_o-DF_c (at 3 rmsd) in purple (negative)
and green (positive)

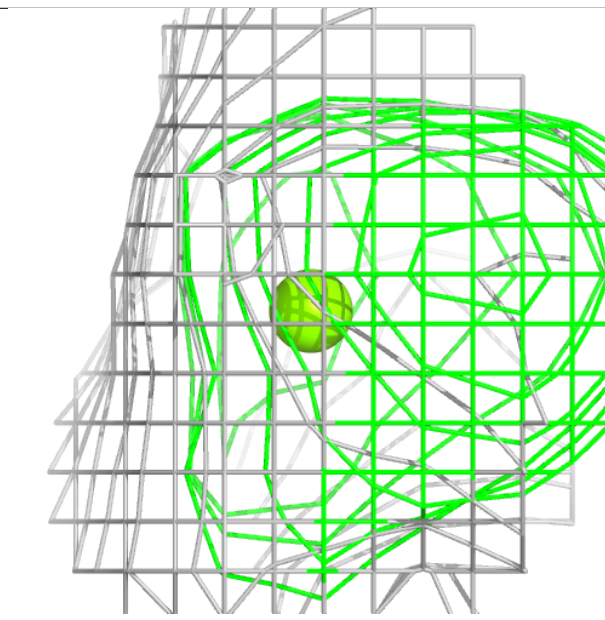
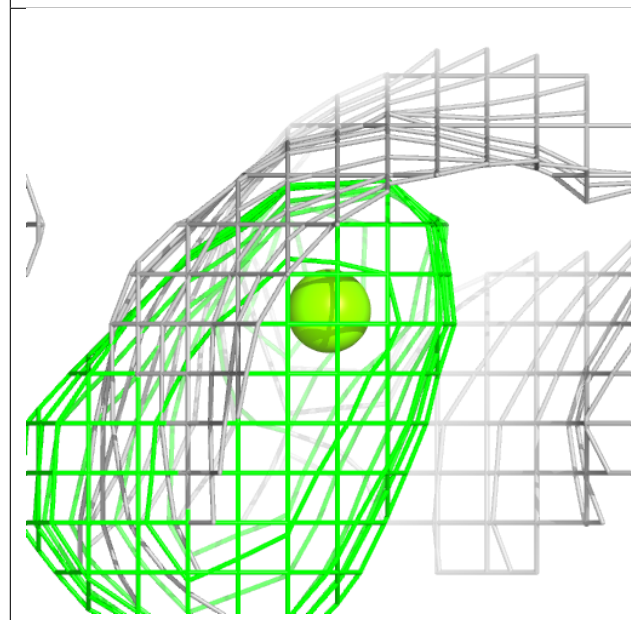
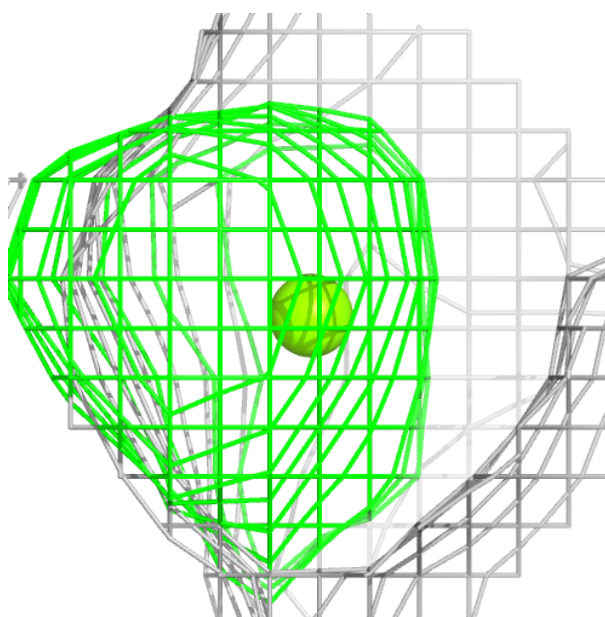

Electron density around MG C 303:

$2mF_o-DF_c$ (at 0.7 rmsd) in gray
 mF_o-DF_c (at 3 rmsd) in purple (negative)
and green (positive)

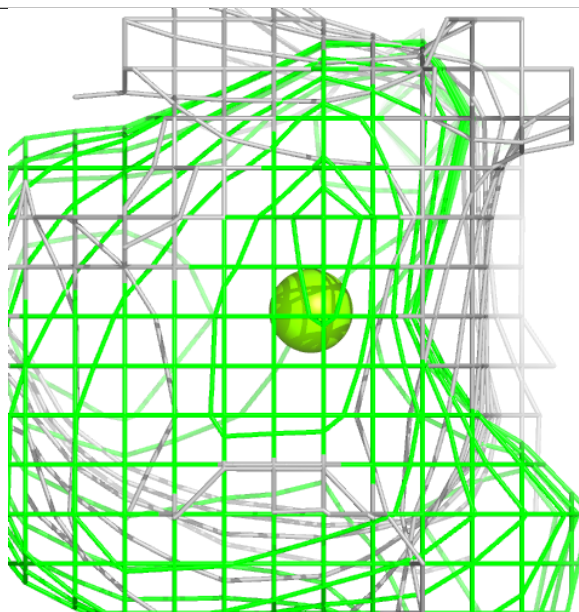
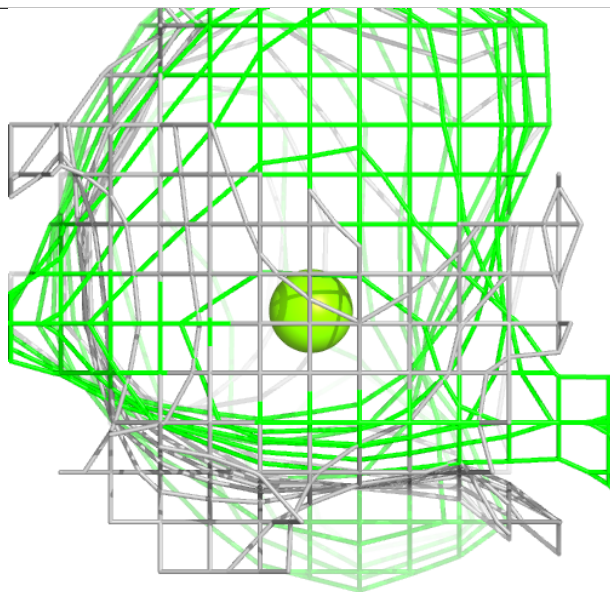
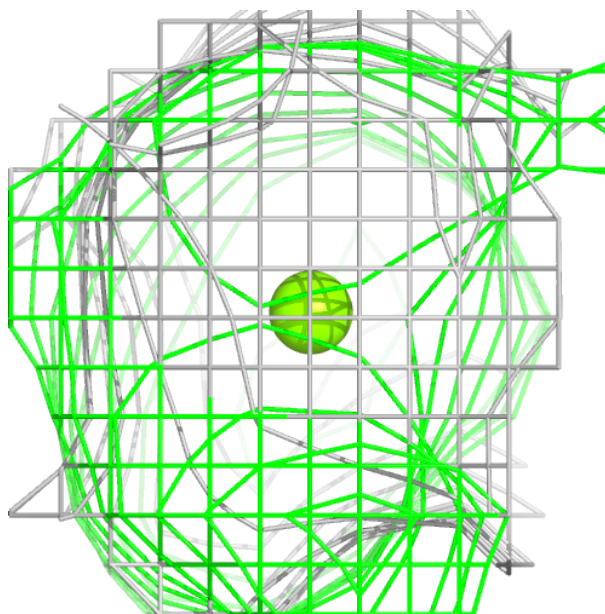

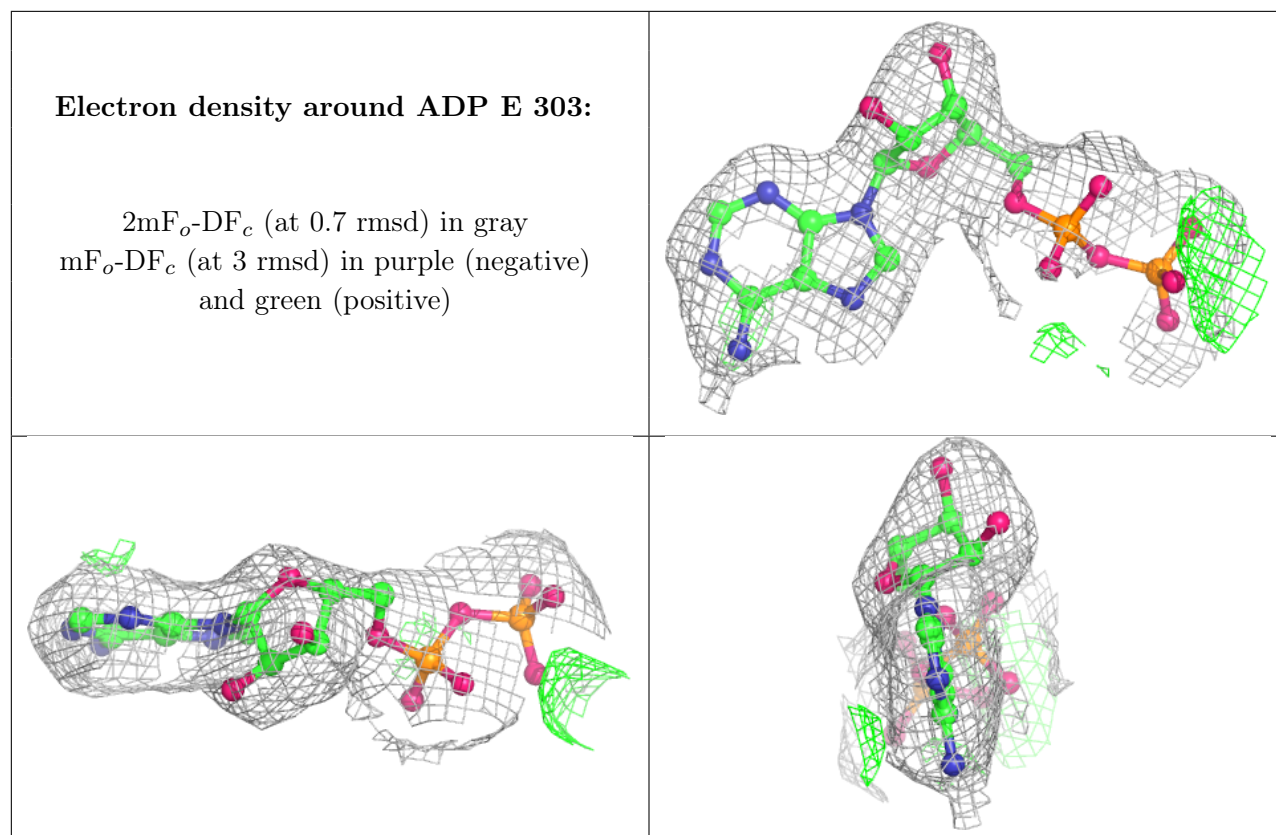

Electron density around MG E 304:

$2mF_o-DF_c$ (at 0.7 rmsd) in gray
 mF_o-DF_c (at 3 rmsd) in purple (negative)
and green (positive)

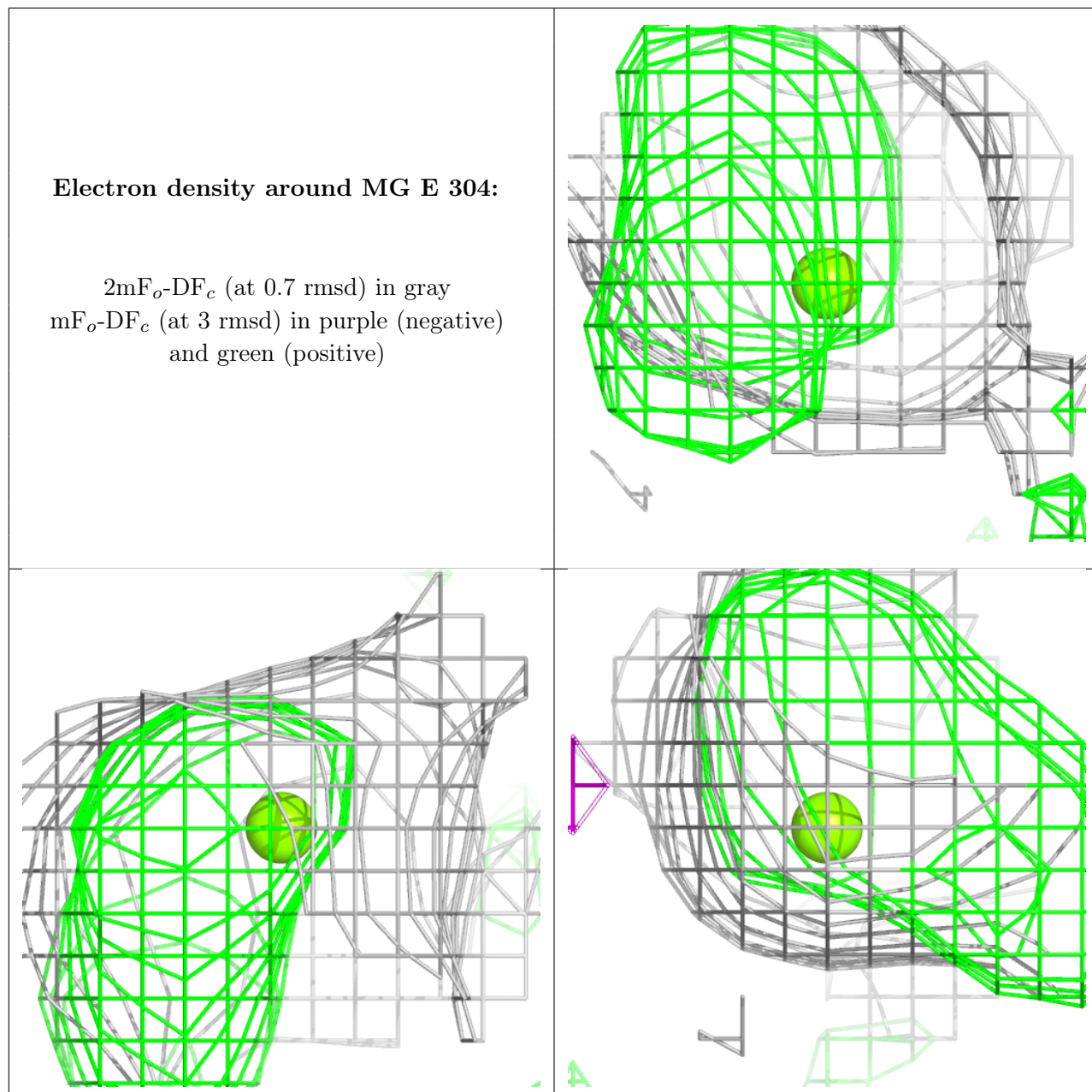

Electron density around MG J 402:

$2mF_o-DF_c$ (at 0.7 rmsd) in gray
 mF_o-DF_c (at 3 rmsd) in purple (negative)
and green (positive)

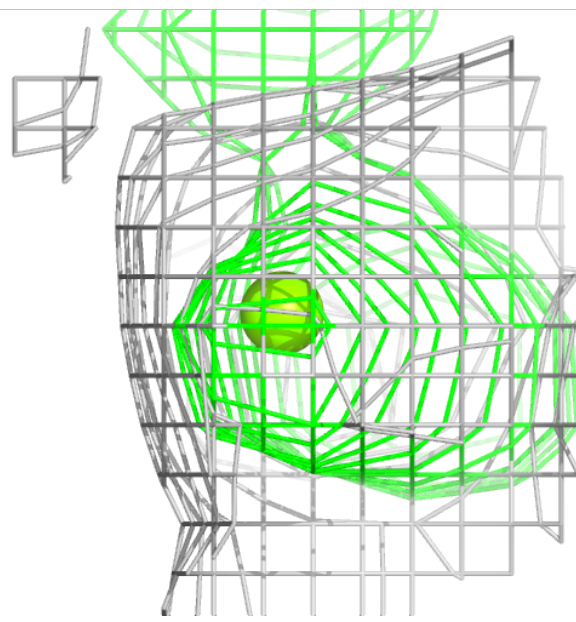
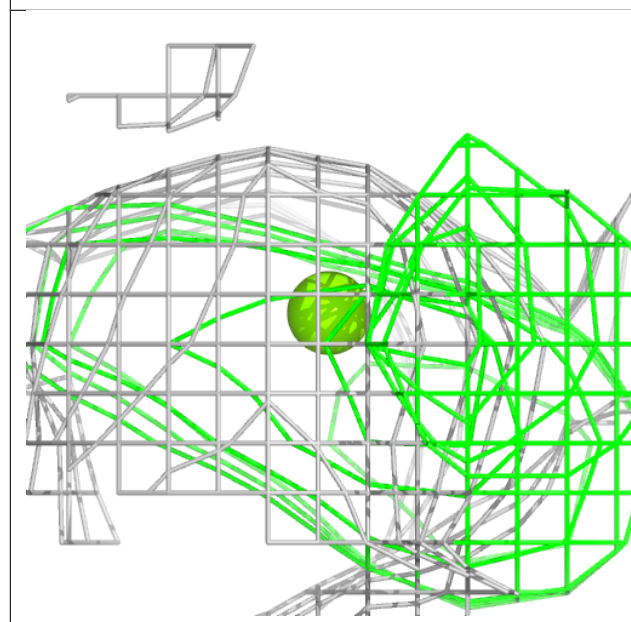
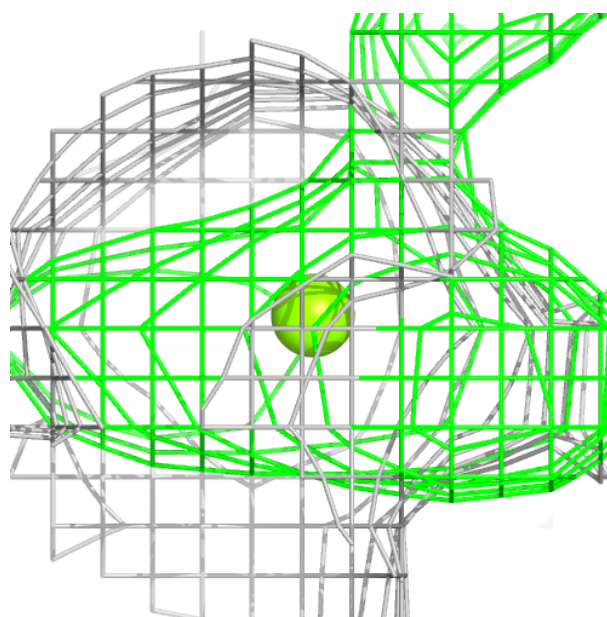

Electron density around MG F 402:

$2mF_o-DF_c$ (at 0.7 rmsd) in gray
 mF_o-DF_c (at 3 rmsd) in purple (negative)
and green (positive)

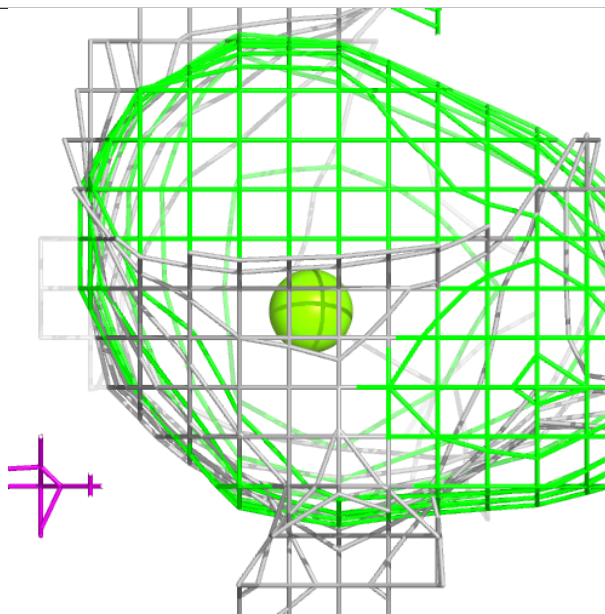
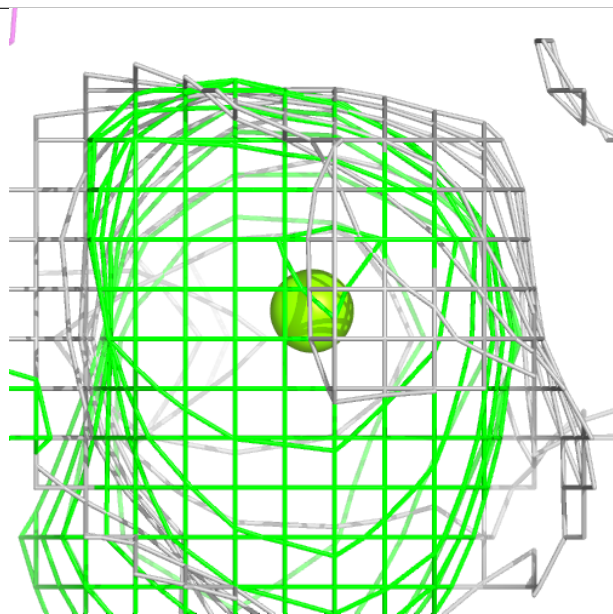
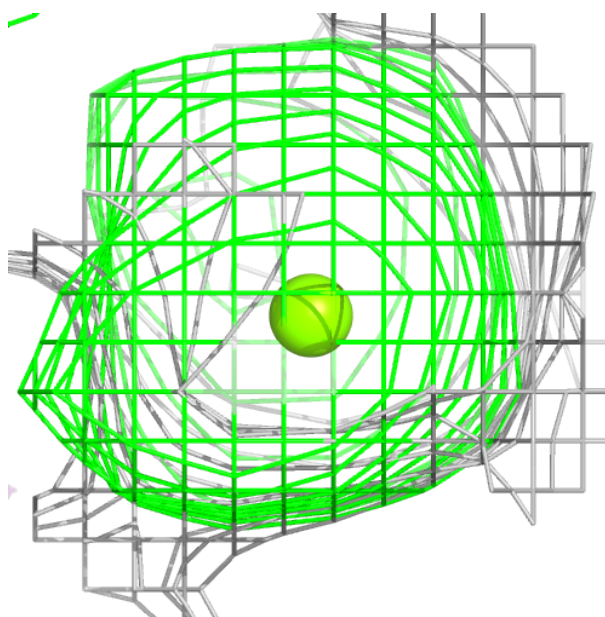

Electron density around MG I 303:

$2mF_o-DF_c$ (at 0.7 rmsd) in gray
 mF_o-DF_c (at 3 rmsd) in purple (negative)
and green (positive)

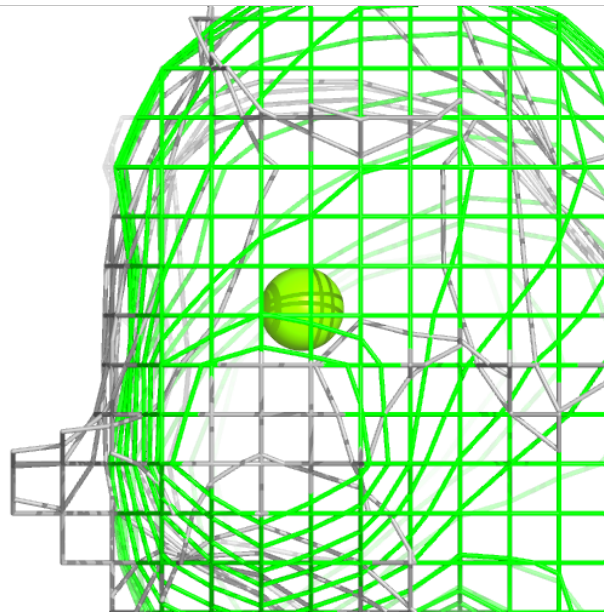
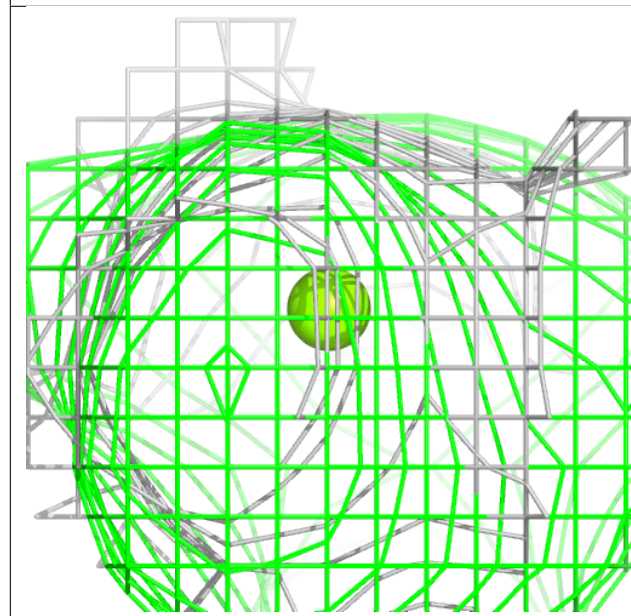
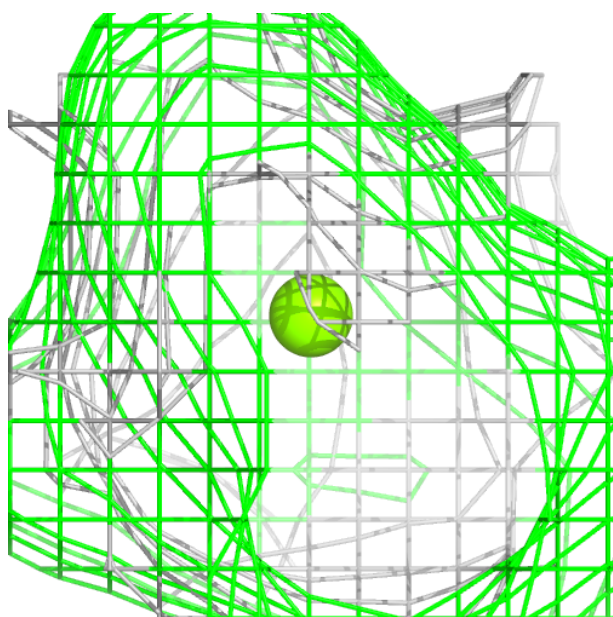

Electron density around MG L 402:

$2mF_o-DF_c$ (at 0.7 rmsd) in gray
 mF_o-DF_c (at 3 rmsd) in purple (negative)
and green (positive)

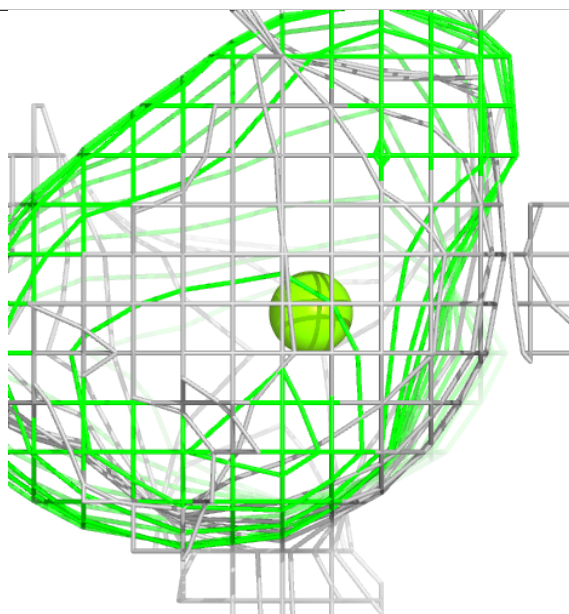
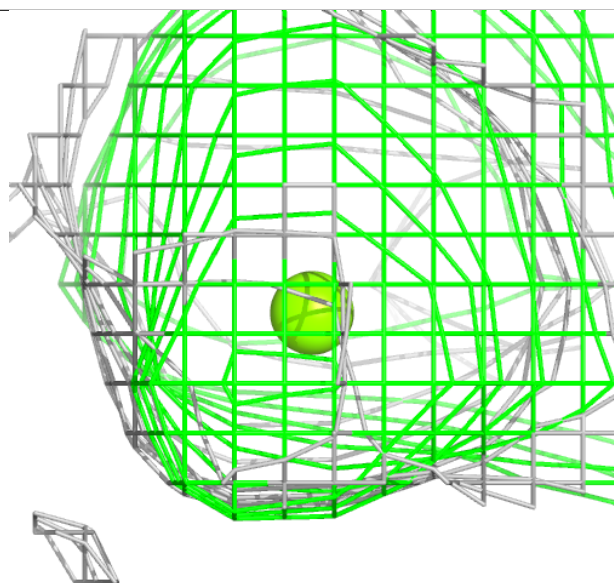
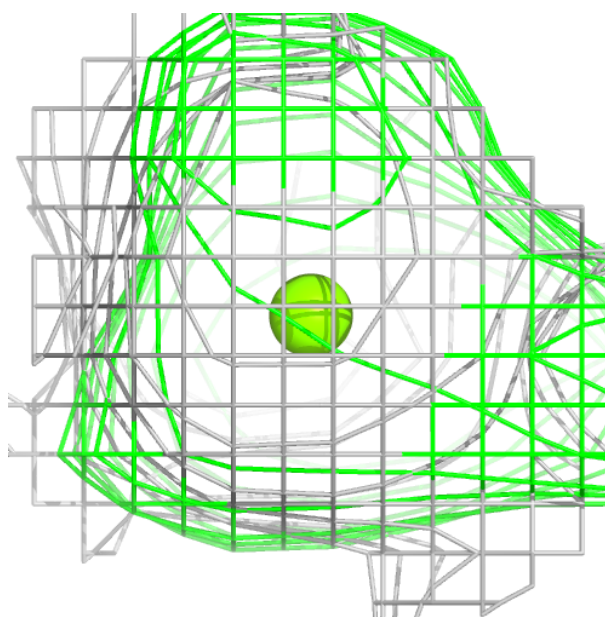

Electron density around ADP F 401:

$2mF_o-DF_c$ (at 0.7 rmsd) in gray
 mF_o-DF_c (at 3 rmsd) in purple (negative)
and green (positive)

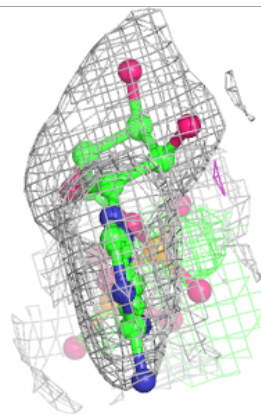
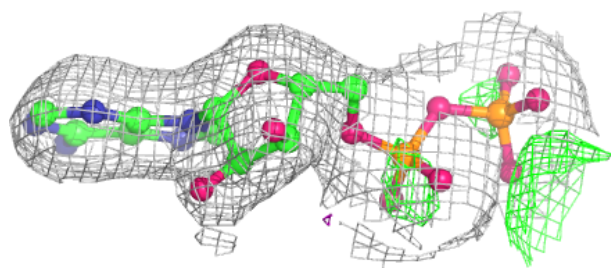
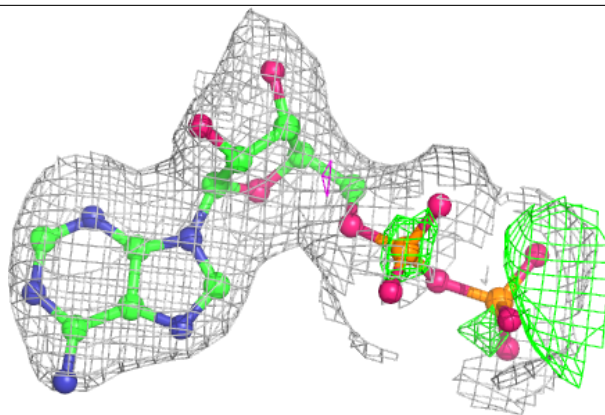
**Electron density around ADP H 302:**

$2mF_o-DF_c$ (at 0.7 rmsd) in gray
 mF_o-DF_c (at 3 rmsd) in purple (negative)
and green (positive)

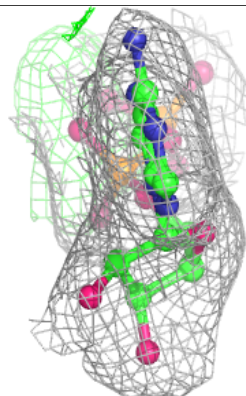
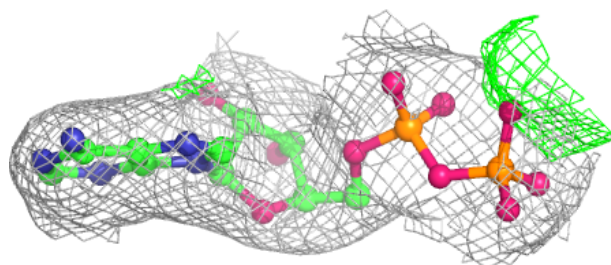
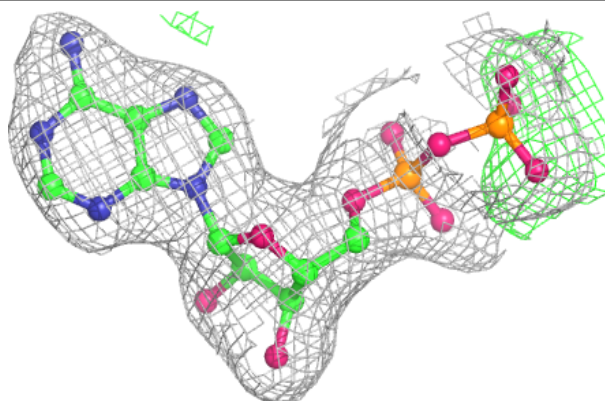

Electron density around MG A 502:

$2mF_o-DF_c$ (at 0.7 rmsd) in gray
 mF_o-DF_c (at 3 rmsd) in purple (negative)
and green (positive)

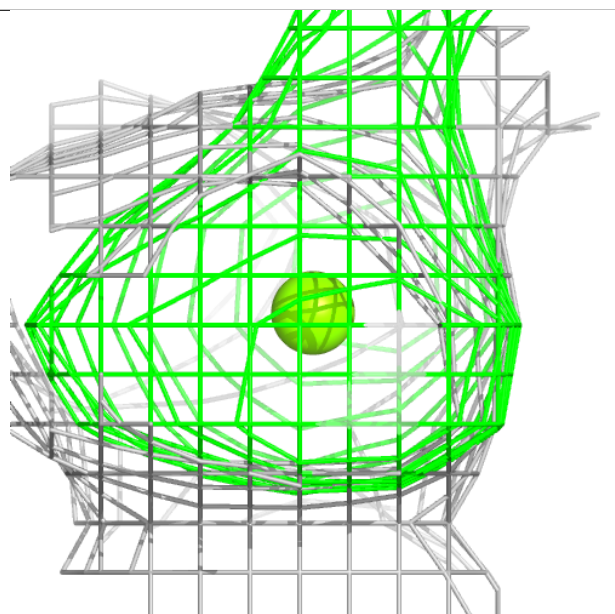
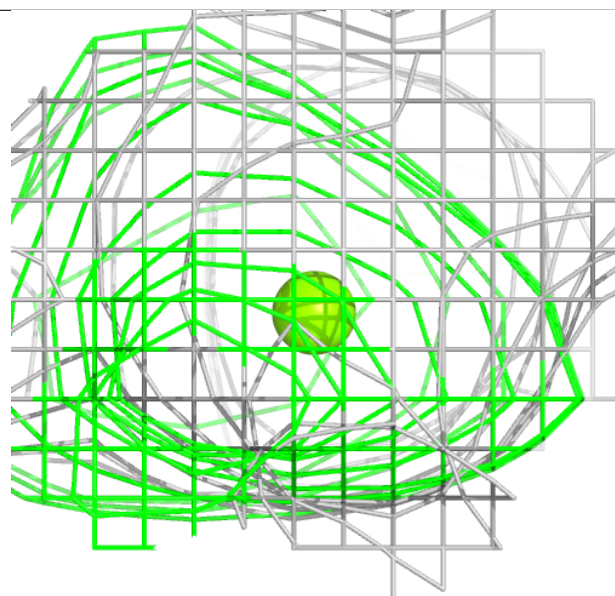
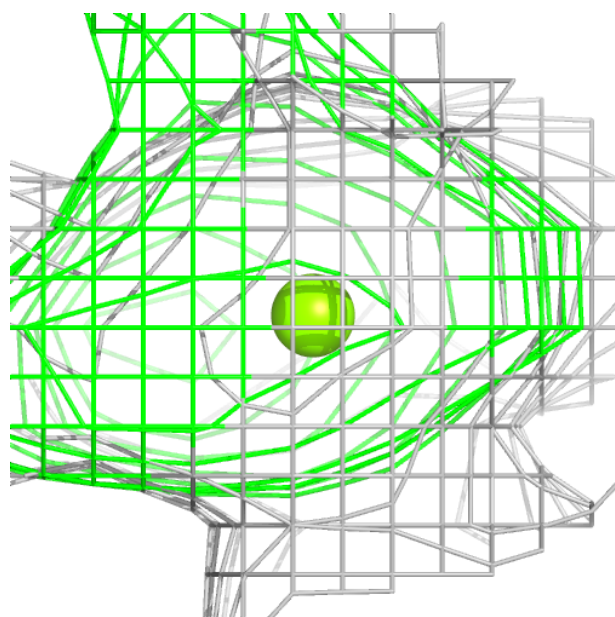

Electron density around ADP B 302:

$2mF_o-DF_c$ (at 0.7 rmsd) in gray
 mF_o-DF_c (at 3 rmsd) in purple (negative)
and green (positive)

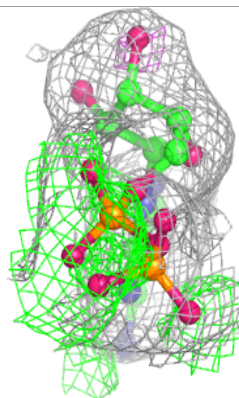
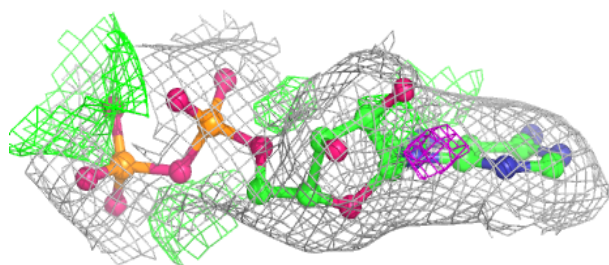
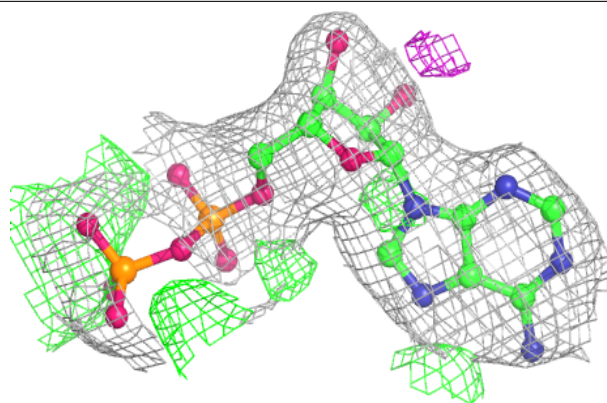
**Electron density around ADP C 302:**

$2mF_o-DF_c$ (at 0.7 rmsd) in gray
 mF_o-DF_c (at 3 rmsd) in purple (negative)
and green (positive)

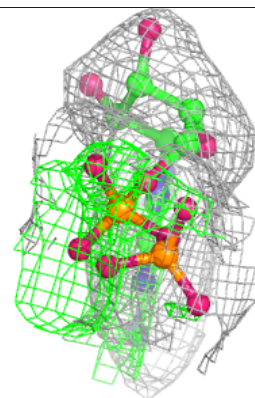
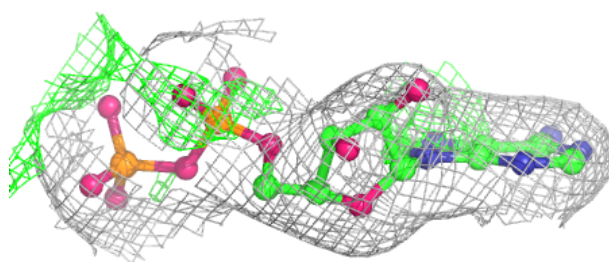
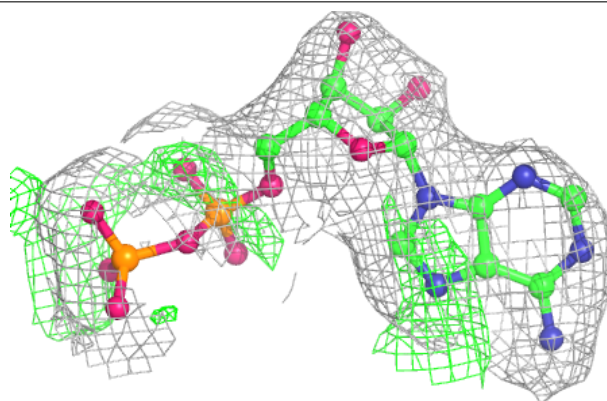

Electron density around MG K 303:

$2mF_o-DF_c$ (at 0.7 rmsd) in gray
 mF_o-DF_c (at 3 rmsd) in purple (negative)
and green (positive)

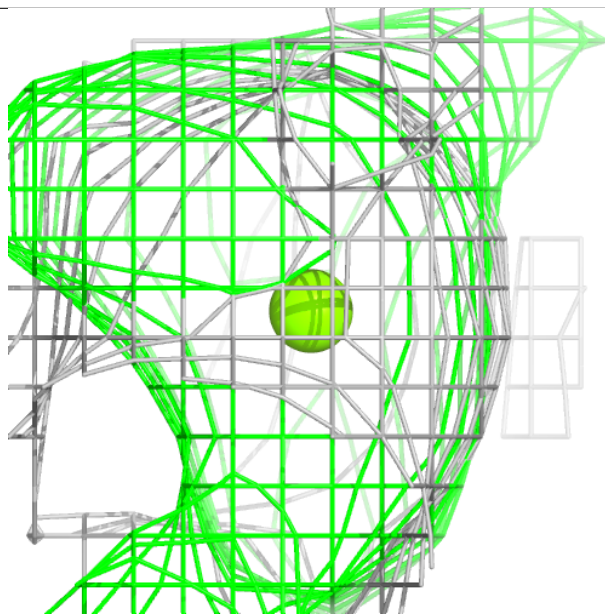
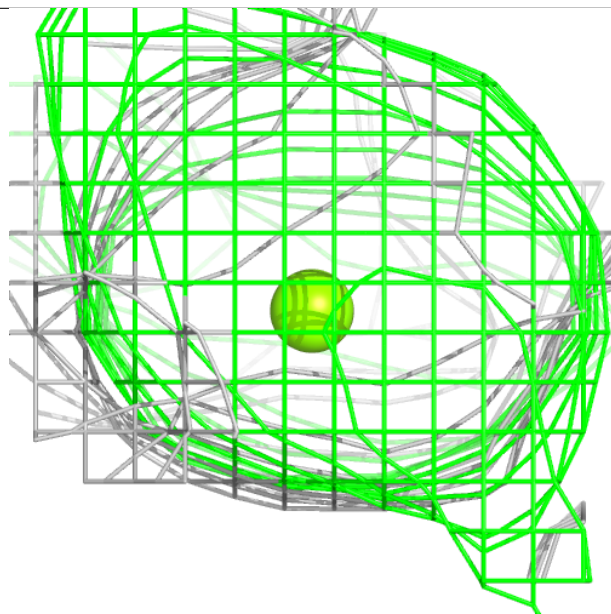
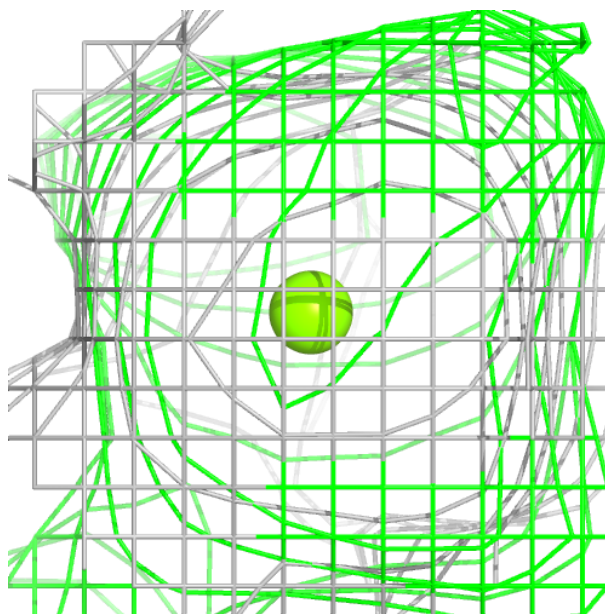

Electron density around ADP J 401:

$2mF_o-DF_c$ (at 0.7 rmsd) in gray
 mF_o-DF_c (at 3 rmsd) in purple (negative)
and green (positive)

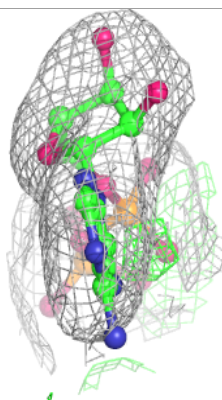
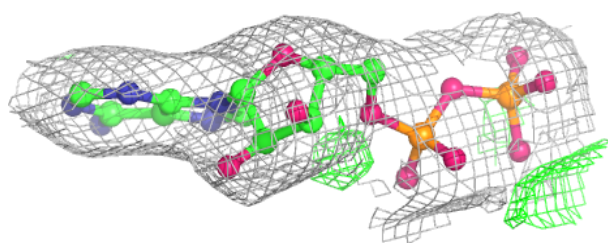
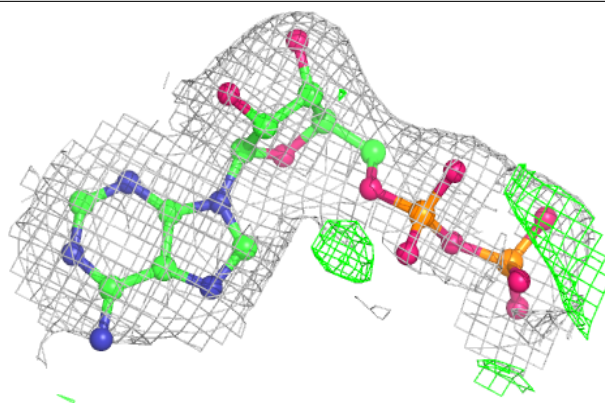

Electron density around MG H 303:

$2mF_o-DF_c$ (at 0.7 rmsd) in gray
 mF_o-DF_c (at 3 rmsd) in purple (negative)
and green (positive)

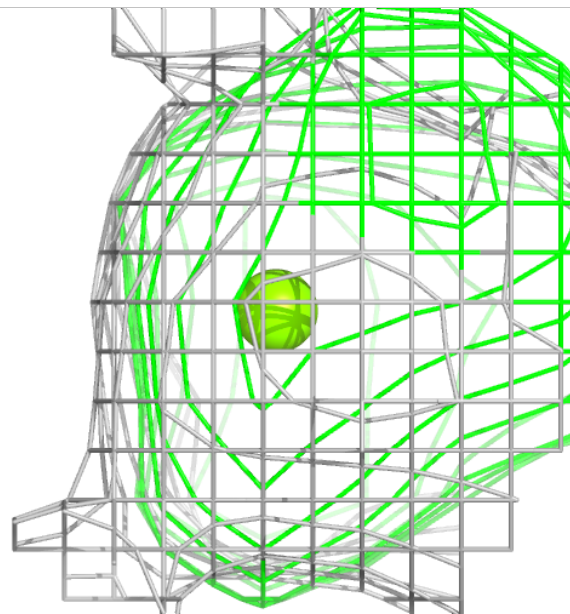
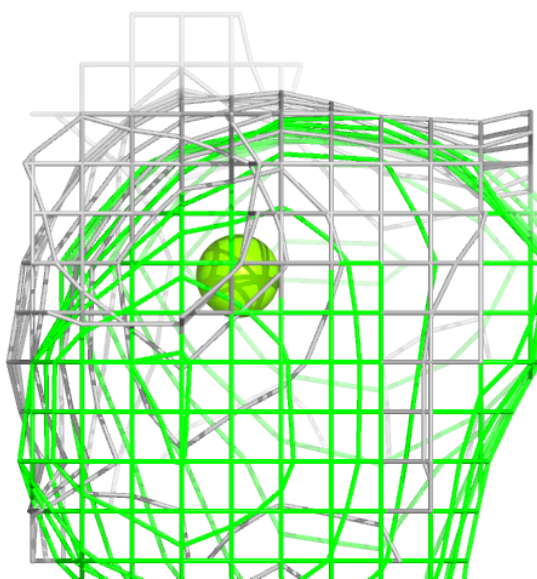
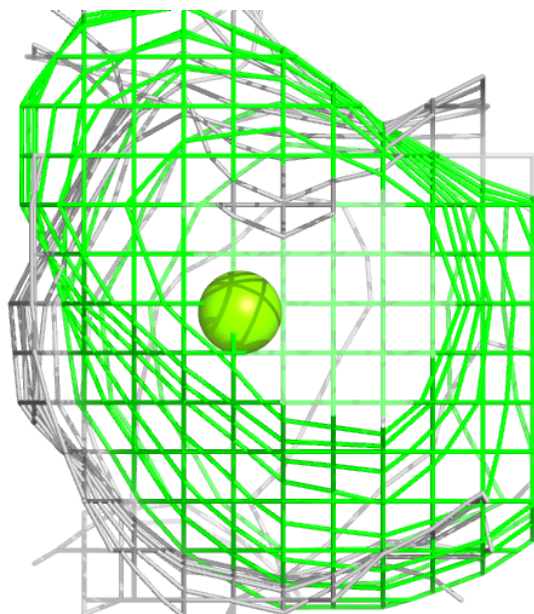

Electron density around ADP L 401:

$2mF_o-DF_c$ (at 0.7 rmsd) in gray
 mF_o-DF_c (at 3 rmsd) in purple (negative)
and green (positive)

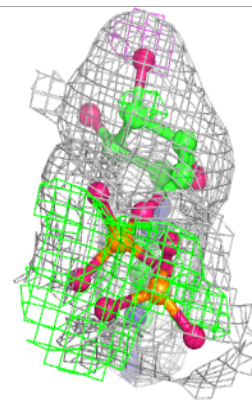
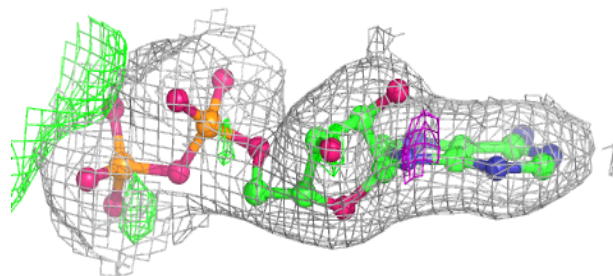
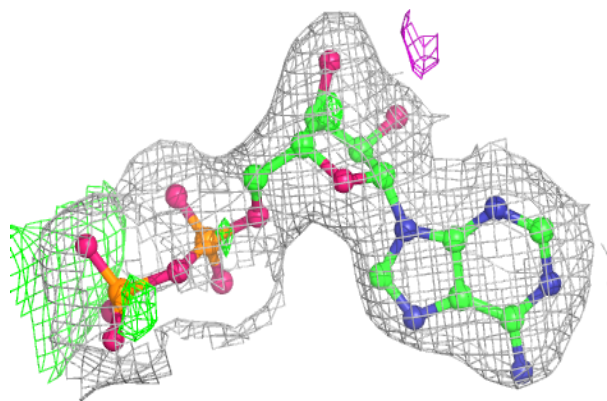
**Electron density around ADP A 501:**

$2mF_o-DF_c$ (at 0.7 rmsd) in gray
 mF_o-DF_c (at 3 rmsd) in purple (negative)
and green (positive)

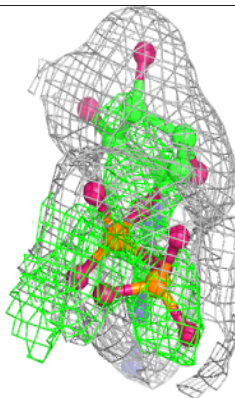
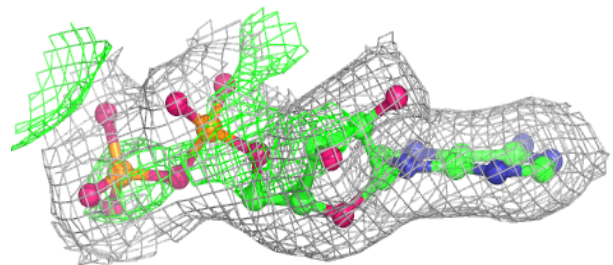
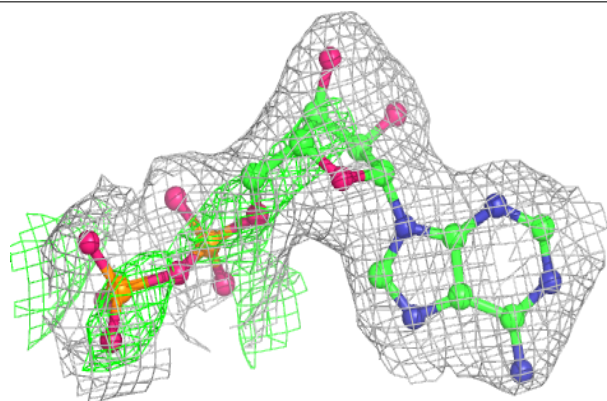

Electron density around SF4 B 301:

$2mF_o-DF_c$ (at 0.7 rmsd) in gray
 mF_o-DF_c (at 3 rmsd) in purple (negative)
and green (positive)

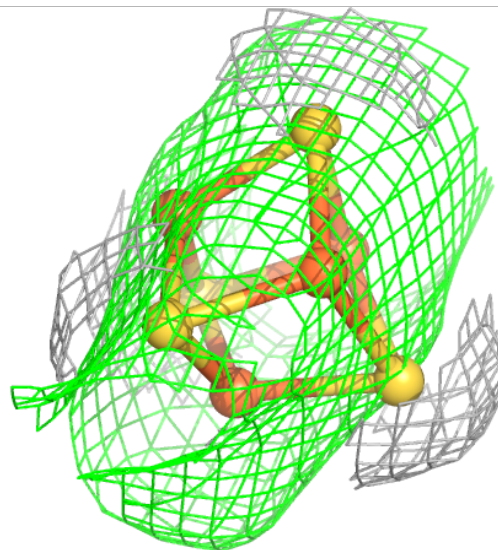
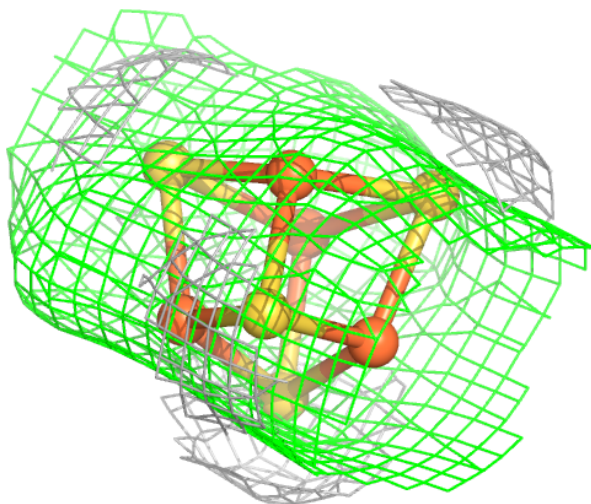
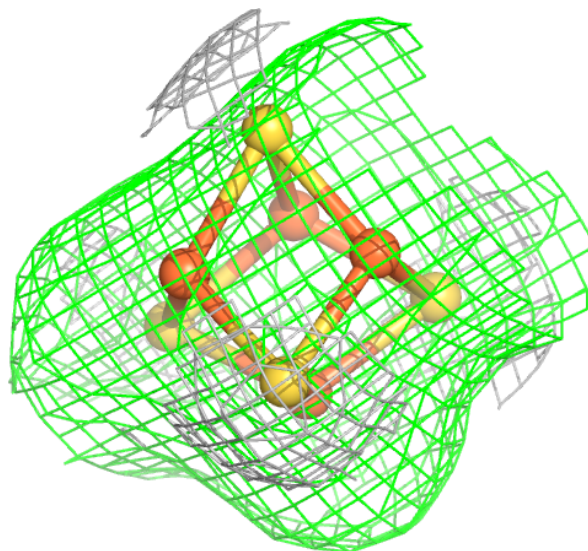

Electron density around SF4 C 301:

$2mF_o-DF_c$ (at 0.7 rmsd) in gray
 mF_o-DF_c (at 3 rmsd) in purple (negative)
and green (positive)

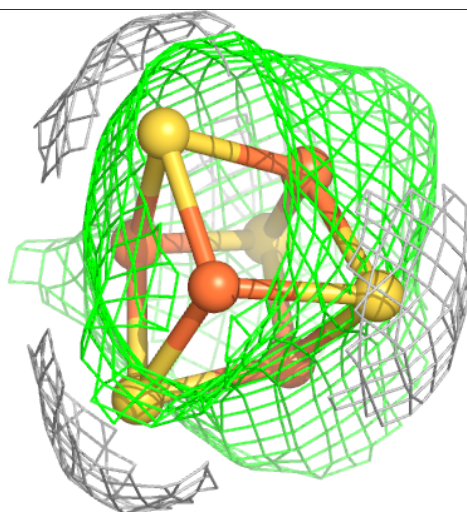
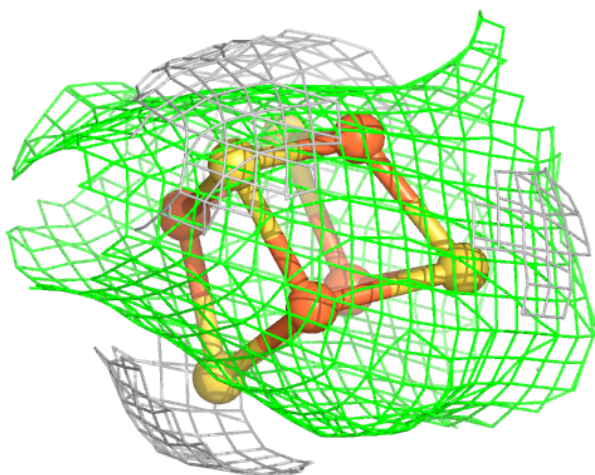
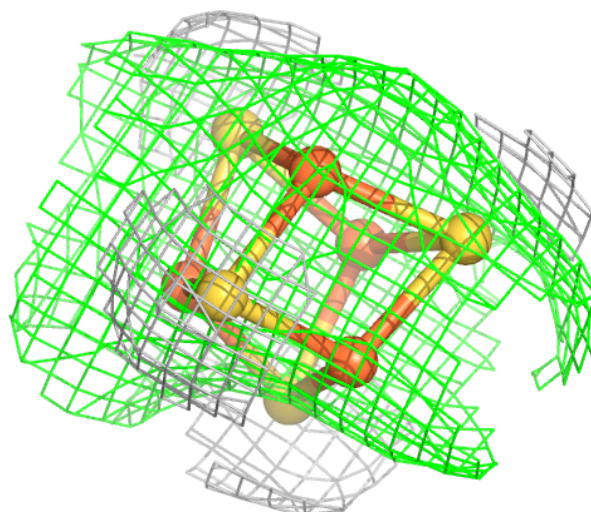

Electron density around SF4 H 301:

$2mF_o-DF_c$ (at 0.7 rmsd) in gray
 mF_o-DF_c (at 3 rmsd) in purple (negative)
and green (positive)

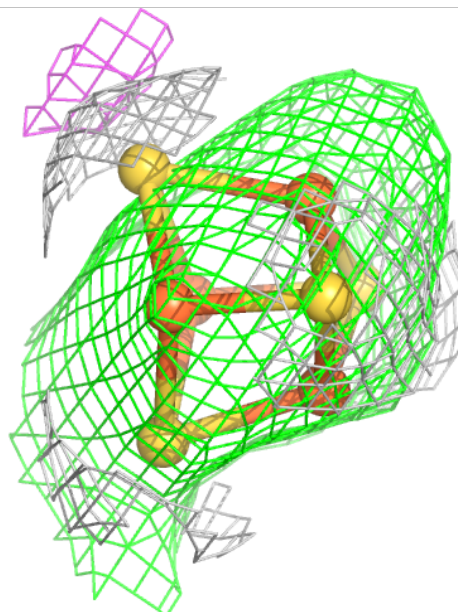
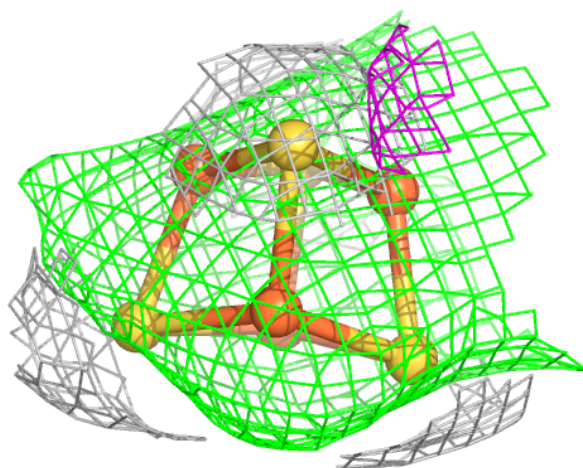
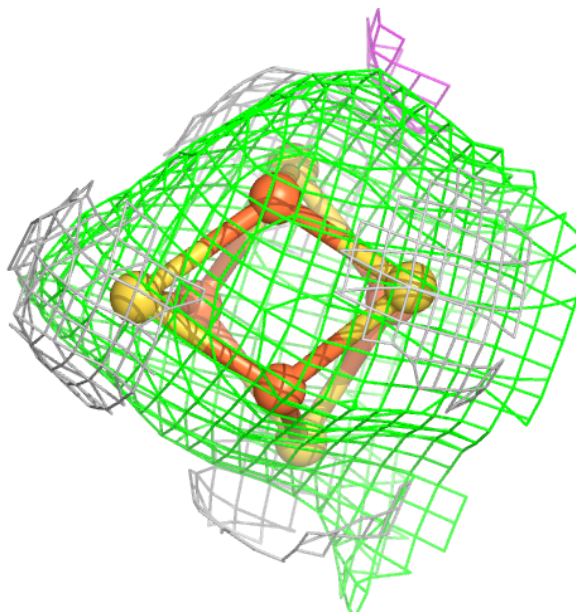

Electron density around SF4 K 301:

$2mF_o-DF_c$ (at 0.7 rmsd) in gray
 mF_o-DF_c (at 3 rmsd) in purple (negative)
and green (positive)

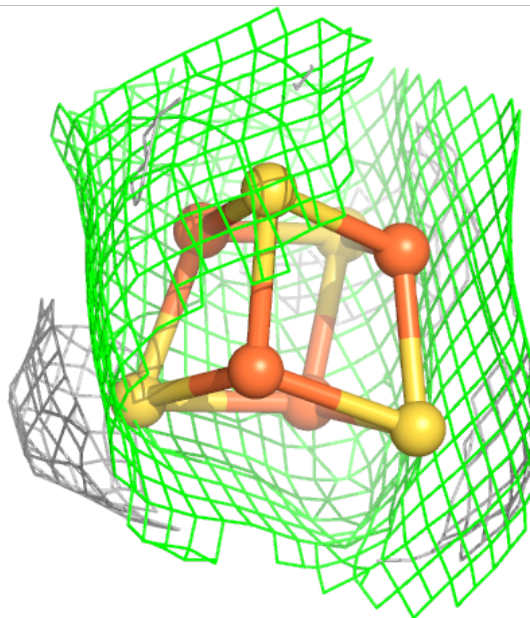
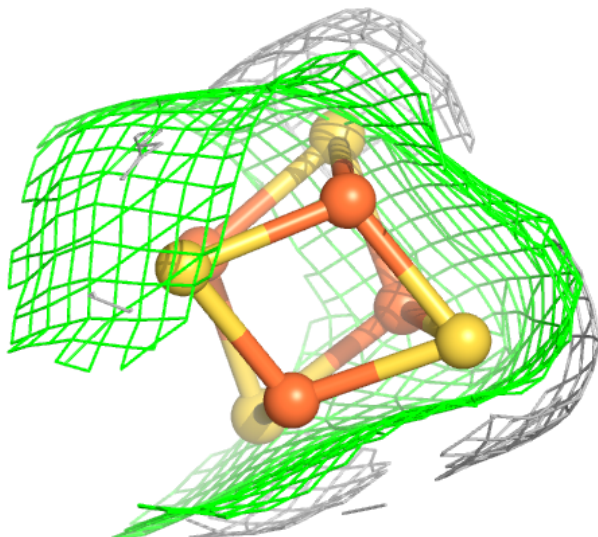
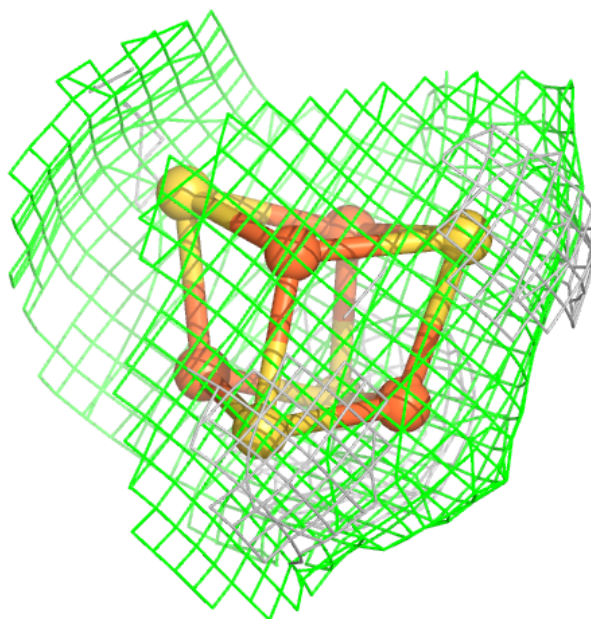

Electron density around ADP I 302:

$2mF_o-DF_c$ (at 0.7 rmsd) in gray
 mF_o-DF_c (at 3 rmsd) in purple (negative)
and green (positive)

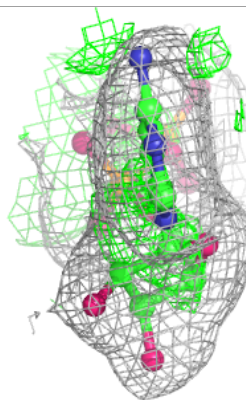
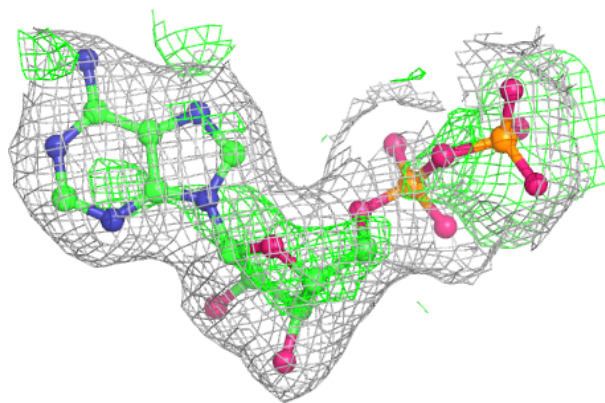
**Electron density around ADP G 501:**

$2mF_o-DF_c$ (at 0.7 rmsd) in gray
 mF_o-DF_c (at 3 rmsd) in purple (negative)
and green (positive)

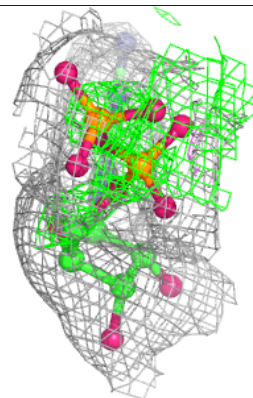
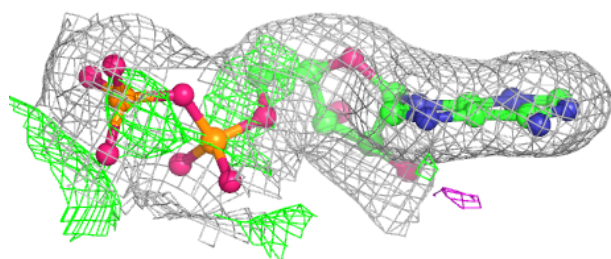
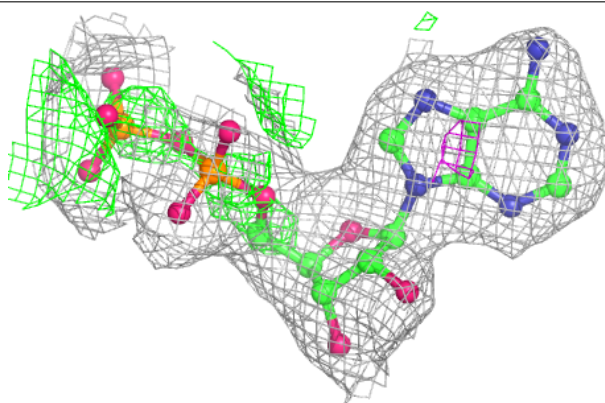

Electron density around MG B 303:

$2mF_o-DF_c$ (at 0.7 rmsd) in gray
 mF_o-DF_c (at 3 rmsd) in purple (negative)
and green (positive)

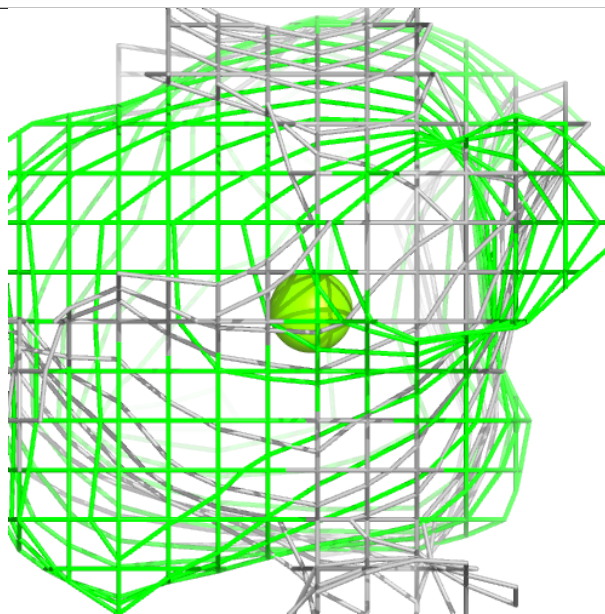
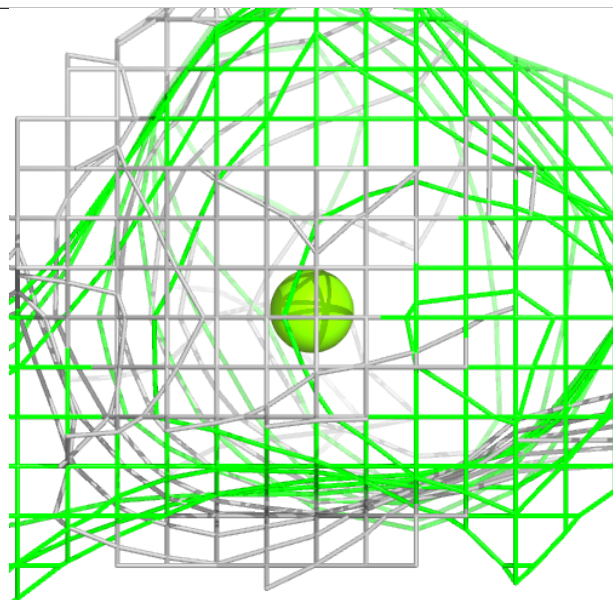
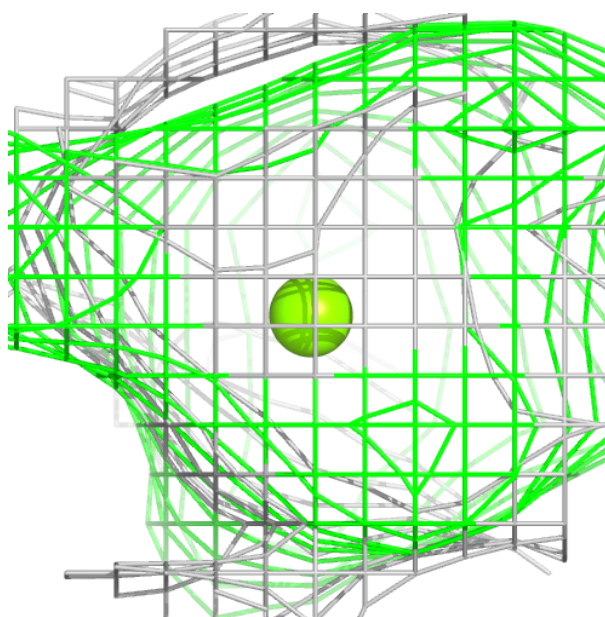

Electron density around MG G 502:

$2mF_o-DF_c$ (at 0.7 rmsd) in gray
 mF_o-DF_c (at 3 rmsd) in purple (negative)
and green (positive)

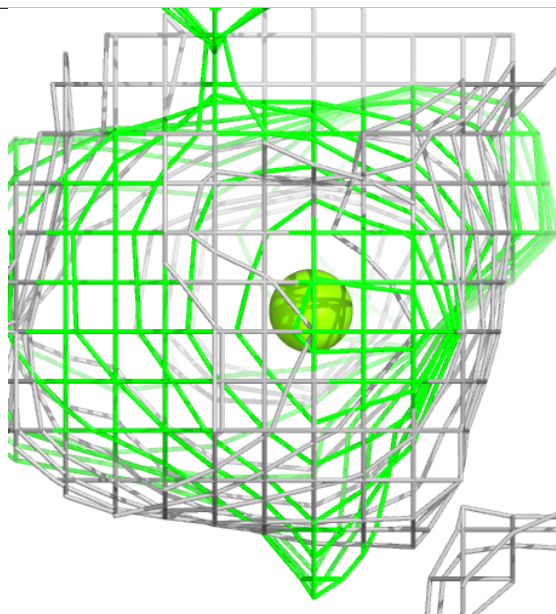
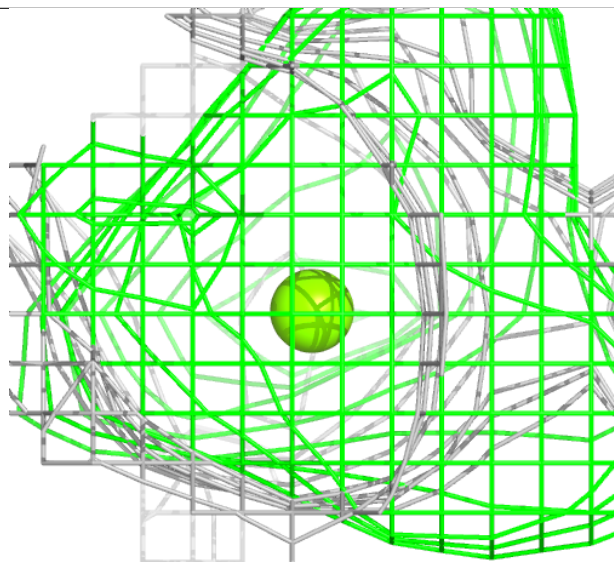
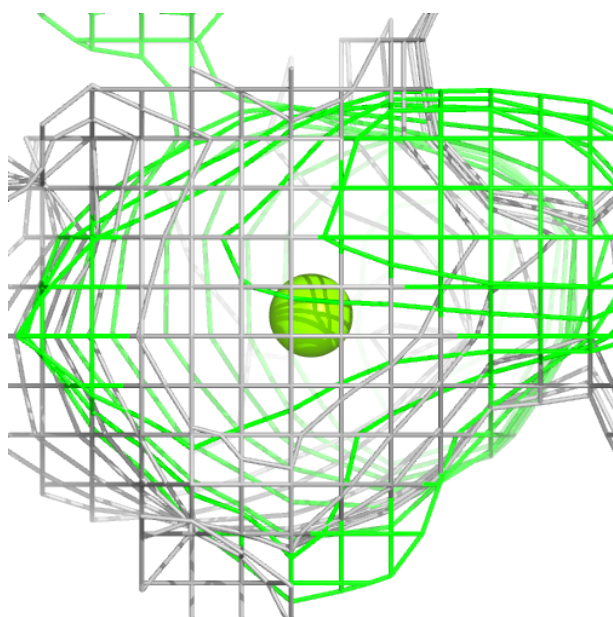

Electron density around ADP K 302:

$2mF_o-DF_c$ (at 0.7 rmsd) in gray
 mF_o-DF_c (at 3 rmsd) in purple (negative)
and green (positive)

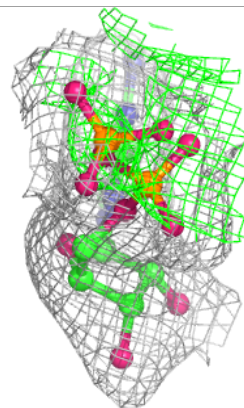
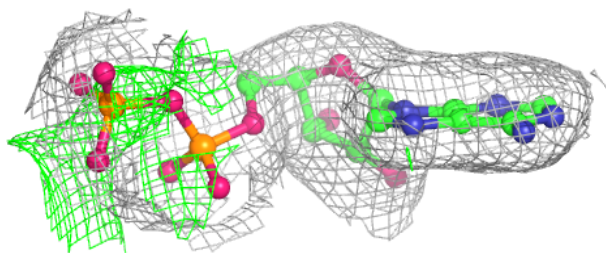
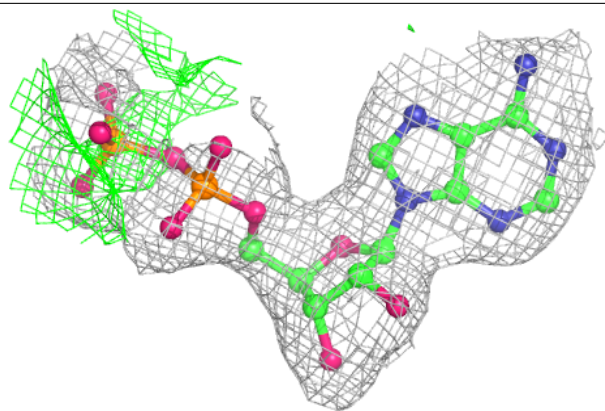

Electron density around SF4 I 301:

$2mF_o-DF_c$ (at 0.7 rmsd) in gray
 mF_o-DF_c (at 3 rmsd) in purple (negative)
and green (positive)

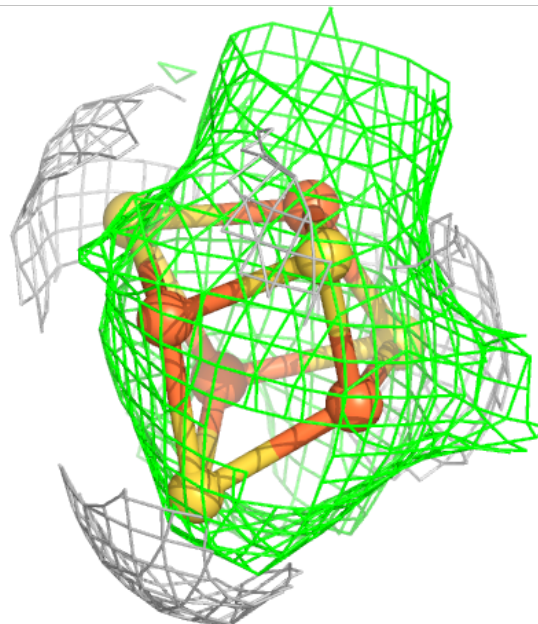
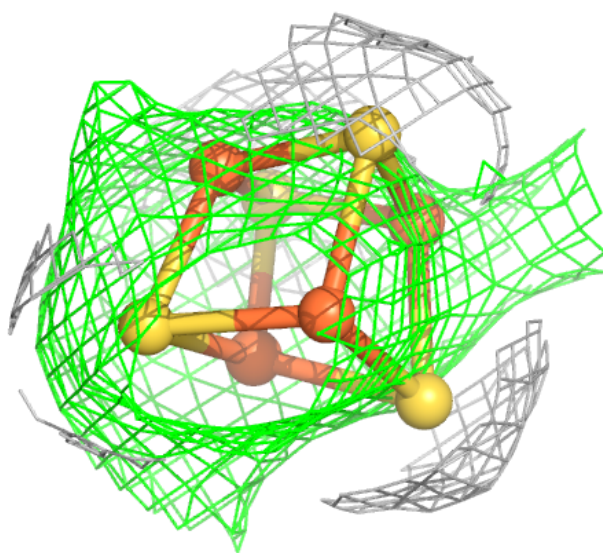
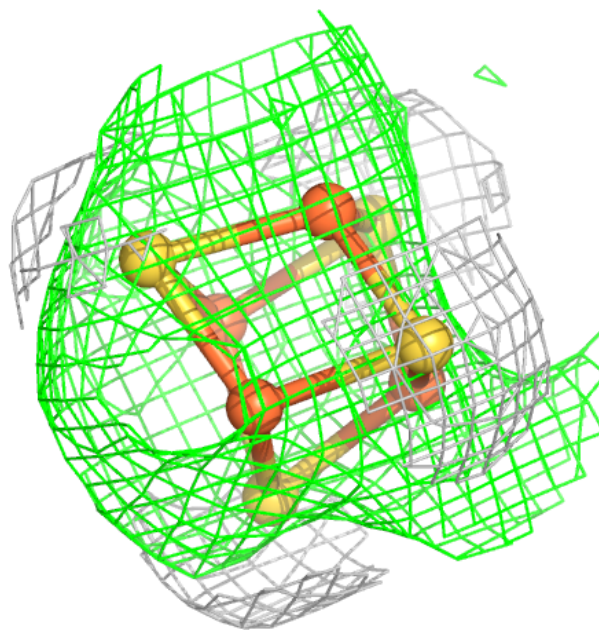

Electron density around SF4 E 302:

$2mF_o-DF_c$ (at 0.7 rmsd) in gray
 mF_o-DF_c (at 3 rmsd) in purple (negative)
and green (positive)

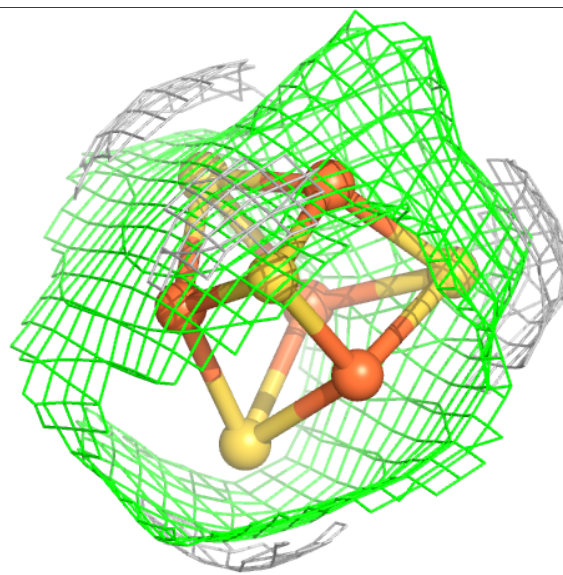
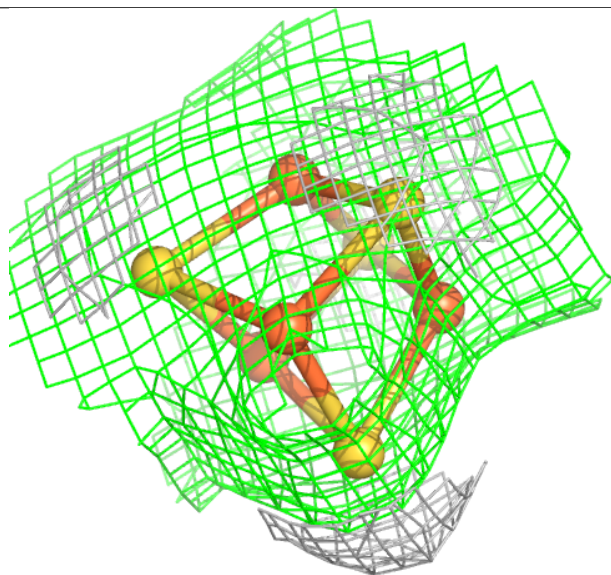
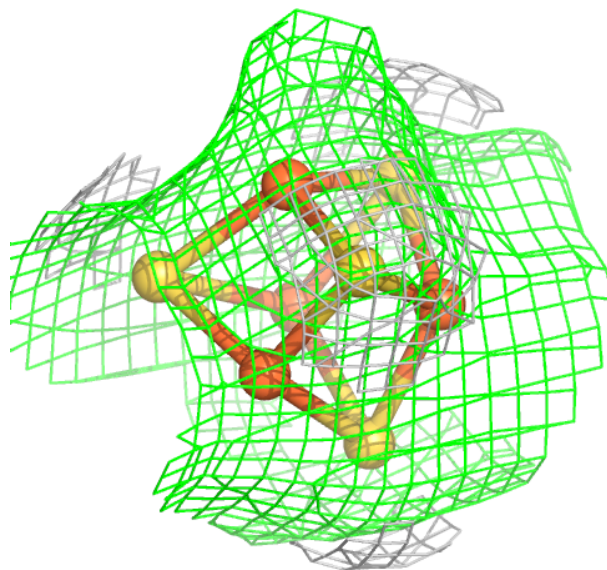

6.5 Other polymers [i](#)

There are no such residues in this entry.