



wwPDB X-ray Structure Validation Summary Report ⓘ

Oct 4, 2023 – 11:08 AM EDT

PDB ID : 6P1X
Title : Structure of HIV-1 Reverse Transcriptase (RT) in complex with dsDNA and L-ddCTP
Authors : Bertoletti, N.; Anderson, K.S.
Deposited on : 2019-05-20
Resolution : 2.55 Å(reported)

This is a wwPDB X-ray Structure Validation Summary Report for a publicly released PDB entry.

We welcome your comments at validation@mail.wwpdb.org

A user guide is available at

<https://www.wwpdb.org/validation/2017/XrayValidationReportHelp>

with specific help available everywhere you see the ⓘ symbol.

The types of validation reports are described at

<http://www.wwpdb.org/validation/2017/FAQs#types>.

The following versions of software and data (see [references ⓘ](#)) were used in the production of this report:

MolProbity : 4.02b-467
Mogul : 1.8.5 (274361), CSD as541be (2020)
Xtriage (Phenix) : 1.13
EDS : 2.35.1
buster-report : 1.1.7 (2018)
Percentile statistics : 20191225.v01 (using entries in the PDB archive December 25th 2019)
Refmac : 5.8.0158
CCP4 : 7.0.044 (Gargrove)
Ideal geometry (proteins) : Engh & Huber (2001)
Ideal geometry (DNA, RNA) : Parkinson et al. (1996)
Validation Pipeline (wwPDB-VP) : 2.35.1

1 Overall quality at a glance

The following experimental techniques were used to determine the structure:

X-RAY DIFFRACTION



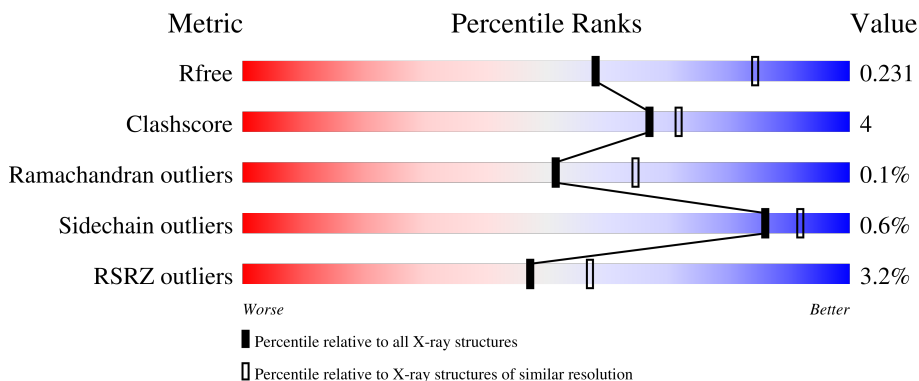

The reported resolution of this entry is 2.55 Å.

Percentile scores (ranging between 0-100) for global validation metrics of the entry are shown in the following graphic. The table shows the number of entries on which the scores are based.

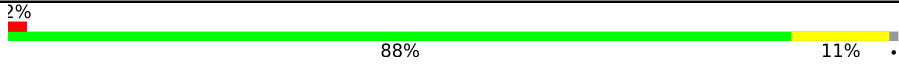

Metric	Whole archive (#Entries)	Similar resolution (#Entries, resolution range(Å))
R_{free}	130704	1279 (2.58-2.54)
Clashscore	141614	1327 (2.58-2.54)
Ramachandran outliers	138981	1312 (2.58-2.54)
Sidechain outliers	138945	1312 (2.58-2.54)
RSRZ outliers	127900	1269 (2.58-2.54)

The table below summarises the geometric issues observed across the polymeric chains and their fit to the electron density. The red, orange, yellow and green segments of the lower bar indicate the fraction of residues that contain outliers for ≥ 3 , 2, 1 and 0 types of geometric quality criteria respectively. A grey segment represents the fraction of residues that are not modelled. The numeric value for each fraction is indicated below the corresponding segment, with a dot representing fractions $\leq 5\%$. The upper red bar (where present) indicates the fraction of residues that have poor fit to the electron density. The numeric value is given above the bar.

Mol	Chain	Length	Quality of chain
1	A	560	 2% 88% 11%
2	B	452	 4% 82% 8% 10%
3	P	21	 76% 10% 14%
4	T	27	 7% 63% 26% 11%

2 Entry composition

There are 8 unique types of molecules in this entry. The entry contains 8618 atoms, of which 0 are hydrogens and 0 are deuteriums.

In the tables below, the ZeroOcc column contains the number of atoms modelled with zero occupancy, the AltConf column contains the number of residues with at least one atom in alternate conformation and the Trace column contains the number of residues modelled with at most 2 atoms.

- Molecule 1 is a protein called Reverse transcriptase/ribonuclease H.

Mol	Chain	Residues	Atoms					ZeroOcc	AltConf	Trace
			Total	C	N	O	S			
1	A	557	4440	2874	745	813	8	0	0	0

There are 2 discrepancies between the modelled and reference sequences:

Chain	Residue	Modelled	Actual	Comment	Reference
A	258	CYS	GLN	engineered mutation	UNP P04585
A	280	SER	CYS	engineered mutation	UNP P04585

- Molecule 2 is a protein called p51 RT.

Mol	Chain	Residues	Atoms					ZeroOcc	AltConf	Trace
			Total	C	N	O	S			
2	B	406	3233	2098	537	593	5	0	0	0

There are 13 discrepancies between the modelled and reference sequences:

Chain	Residue	Modelled	Actual	Comment	Reference
B	-11	MET	-	expression tag	UNP P04585
B	-10	GLY	-	expression tag	UNP P04585
B	-9	SER	-	expression tag	UNP P04585
B	-8	SER	-	expression tag	UNP P04585
B	-7	HIS	-	expression tag	UNP P04585
B	-6	HIS	-	expression tag	UNP P04585
B	-5	HIS	-	expression tag	UNP P04585
B	-4	HIS	-	expression tag	UNP P04585
B	-3	HIS	-	expression tag	UNP P04585
B	-2	HIS	-	expression tag	UNP P04585
B	-1	SER	-	expression tag	UNP P04585
B	0	SER	-	expression tag	UNP P04585
B	280	SER	CYS	engineered mutation	UNP P04585



Mol	Chain	Residues	Atoms	ZeroOcc	AltConf
7	P	1	Total O S 5 4 1	0	0
7	T	1	Total O S 5 4 1	0	0
7	T	1	Total O S 5 4 1	0	0

- Molecule 8 is water.

Mol	Chain	Residues	Atoms	ZeroOcc	AltConf
8	A	22	Total O 22 22	0	0
8	B	7	Total O 7 7	0	0
8	P	3	Total O 3 3	0	0
8	T	1	Total O 1 1	0	0

3 Residue-property plots [i](#)

These plots are drawn for all protein, RNA, DNA and oligosaccharide chains in the entry. The first graphic for a chain summarises the proportions of the various outlier classes displayed in the second graphic. The second graphic shows the sequence view annotated by issues in geometry and electron density. Residues are color-coded according to the number of geometric quality criteria for which they contain at least one outlier: green = 0, yellow = 1, orange = 2 and red = 3 or more. A red dot above a residue indicates a poor fit to the electron density ($RSRZ > 2$). Stretches of 2 or more consecutive residues without any outlier are shown as a green connector. Residues present in the sample, but not in the model, are shown in grey.

- Molecule 1: Reverse transcriptase/ribonuclease H

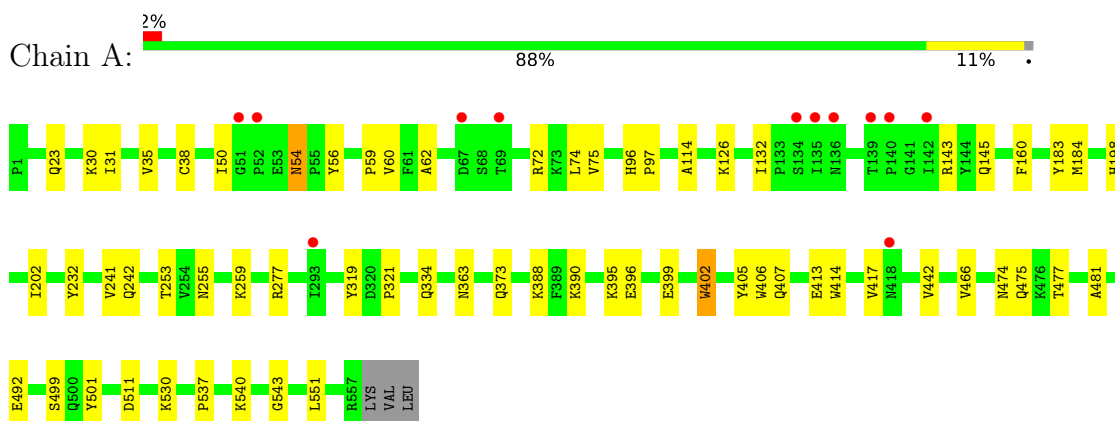

- Molecule 2: p51 RT

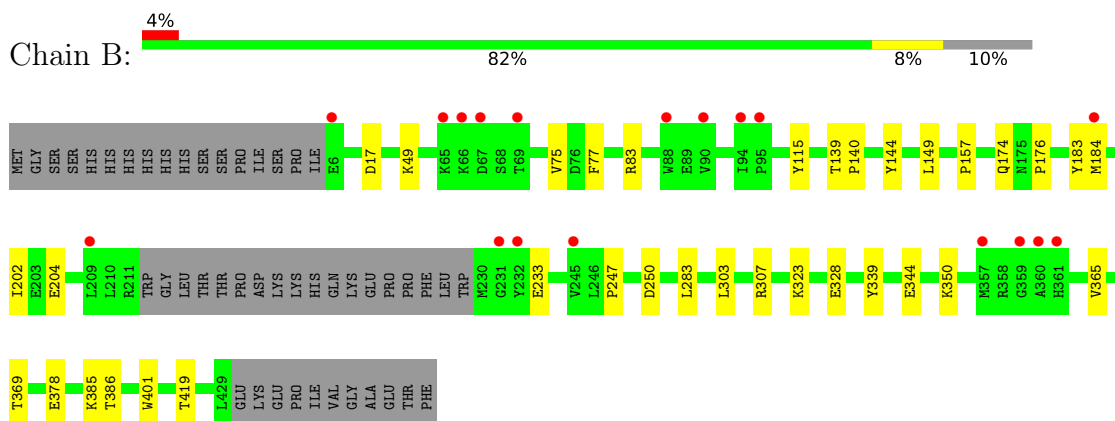

- Molecule 3: DNA Primer 20-mer

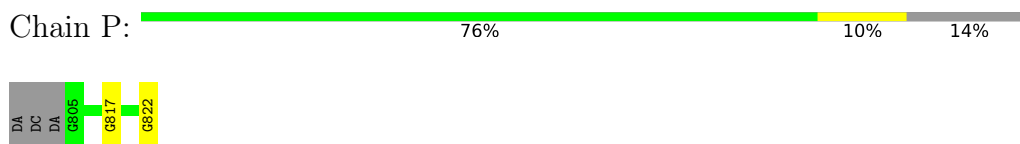

- Molecule 4: DNA template 27-mer





4 Data and refinement statistics i

Property	Value	Source
Space group	C 2 2 21	Depositor
Cell constants a, b, c, α , β , γ	169.21Å 171.50Å 107.31Å 90.00° 90.00° 90.00°	Depositor
Resolution (Å)	29.75 – 2.55 29.75 – 2.55	Depositor EDS
% Data completeness (in resolution range)	99.4 (29.75-2.55) 99.6 (29.75-2.55)	Depositor EDS
R_{merge}	(Not available)	Depositor
R_{sym}	0.12	Depositor
$\langle I/\sigma(I) \rangle$ ¹	1.03 (at 2.54Å)	Xtrriage
Refinement program	PHENIX (1.14_3260: ???)	Depositor
R, R_{free}	0.188 , 0.230 0.188 , 0.231	Depositor DCC
R_{free} test set	2534 reflections (5.00%)	wwPDB-VP
Wilson B-factor (Å ²)	52.5	Xtrriage
Anisotropy	0.385	Xtrriage
Bulk solvent k_{sol} (e/Å ³), B_{sol} (Å ²)	0.30 , 36.9	EDS
L-test for twinning ²	$\langle L \rangle = 0.50$, $\langle L^2 \rangle = 0.33$	Xtrriage
Estimated twinning fraction	0.007 for -k,-h,-l	Xtrriage
F_o, F_c correlation	0.95	EDS
Total number of atoms	8618	wwPDB-VP
Average B, all atoms (Å ²)	56.0	wwPDB-VP

Xtrriage's analysis on translational NCS is as follows: *The largest off-origin peak in the Patterson function is 4.16% of the height of the origin peak. No significant pseudotranslation is detected.*

¹Intensities estimated from amplitudes.

²Theoretical values of $\langle |L| \rangle$, $\langle L^2 \rangle$ for acentric reflections are 0.5, 0.333 respectively for untwinned datasets, and 0.375, 0.2 for perfectly twinned datasets.

5 Model quality [i](#)

5.1 Standard geometry [i](#)

Bond lengths and bond angles in the following residue types are not validated in this section: DDG, G47, MG, NQ4, SO4

The Z score for a bond length (or angle) is the number of standard deviations the observed value is removed from the expected value. A bond length (or angle) with $|Z| > 5$ is considered an outlier worth inspection. RMSZ is the root-mean-square of all Z scores of the bond lengths (or angles).

Mol	Chain	Bond lengths		Bond angles	
		RMSZ	# Z >5	RMSZ	# Z >5
1	A	0.39	0/4557	0.56	0/6208
2	B	0.37	0/3323	0.55	1/4535 (0.0%)
3	P	0.84	0/358	0.97	0/547
4	T	0.85	0/561	0.90	0/865
All	All	0.46	0/8799	0.61	1/12155 (0.0%)

Chiral center outliers are detected by calculating the chiral volume of a chiral center and verifying if the center is modelled as a planar moiety or with the opposite hand. A planarity outlier is detected by checking planarity of atoms in a peptide group, atoms in a mainchain group or atoms of a sidechain that are expected to be planar.

Mol	Chain	#Chirality outliers	#Planarity outliers
1	A	0	1

There are no bond length outliers.

All (1) bond angle outliers are listed below:

Mol	Chain	Res	Type	Atoms	Z	Observed($^{\circ}$)	Ideal($^{\circ}$)
2	B	385	LYS	C-N-CA	-5.19	108.72	121.70

There are no chirality outliers.

All (1) planarity outliers are listed below:

Mol	Chain	Res	Type	Group
1	A	183	TYR	Peptide

5.2 Too-close contacts [i](#)

In the following table, the Non-H and H(model) columns list the number of non-hydrogen atoms and hydrogen atoms in the chain respectively. The H(added) column lists the number of hydrogen atoms added and optimized by MolProbity. The Clashes column lists the number of clashes within the asymmetric unit, whereas Symm-Clashes lists symmetry-related clashes.

Mol	Chain	Non-H	H(model)	H(added)	Clashes	Symm-Clashes
1	A	4440	0	4412	40	0
2	B	3233	0	3145	21	0
3	P	369	0	206	0	0
4	T	499	0	267	7	0
5	A	2	0	0	0	0
6	A	27	0	0	0	0
7	P	5	0	0	0	0
7	T	10	0	0	0	0
8	A	22	0	0	0	0
8	B	7	0	0	0	0
8	P	3	0	0	0	0
8	T	1	0	0	0	0
All	All	8618	0	8030	64	0

The all-atom clashscore is defined as the number of clashes found per 1000 atoms (including hydrogen atoms). The all-atom clashscore for this structure is 4.

The worst 5 of 64 close contacts within the same asymmetric unit are listed below, sorted by their clash magnitude.

Atom-1	Atom-2	Interatomic distance (Å)	Clash overlap (Å)
1:A:60:VAL:HG12	1:A:75:VAL:HG22	1.68	0.74
1:A:23:GLN:HE22	1:A:60:VAL:H	1.37	0.70
1:A:492:GLU:HG2	1:A:530:LYS:HB2	1.75	0.69
2:B:157:PRO:HG3	2:B:184:MET:HA	1.81	0.62
1:A:474:ASN:O	1:A:477:THR:HG22	2.02	0.59

There are no symmetry-related clashes.

5.3 Torsion angles [i](#)

5.3.1 Protein backbone [i](#)

In the following table, the Percentiles column shows the percent Ramachandran outliers of the chain as a percentile score with respect to all X-ray entries followed by that with respect to entries of similar resolution.

The Analysed column shows the number of residues for which the backbone conformation was analysed, and the total number of residues.

Mol	Chain	Analysed	Favoured	Allowed	Outliers	Percentiles	
1	A	555/560 (99%)	532 (96%)	22 (4%)	1 (0%)	47	58
2	B	402/452 (89%)	390 (97%)	12 (3%)	0	100	100
All	All	957/1012 (95%)	922 (96%)	34 (4%)	1 (0%)	51	65

All (1) Ramachandran outliers are listed below:

Mol	Chain	Res	Type
1	A	184	MET

5.3.2 Protein sidechains [i](#)

In the following table, the Percentiles column shows the percent sidechain outliers of the chain as a percentile score with respect to all X-ray entries followed by that with respect to entries of similar resolution.

The Analysed column shows the number of residues for which the sidechain conformation was analysed, and the total number of residues.

Mol	Chain	Analysed	Rotameric	Outliers	Percentiles	
1	A	471/500 (94%)	466 (99%)	5 (1%)	73	83
2	B	338/411 (82%)	338 (100%)	0	100	100
All	All	809/911 (89%)	804 (99%)	5 (1%)	86	92

All (5) residues with a non-rotameric sidechain are listed below:

Mol	Chain	Res	Type
1	A	54	ASN
1	A	126	LYS
1	A	253	THR
1	A	402	TRP
1	A	499	SER

Sometimes sidechains can be flipped to improve hydrogen bonding and reduce clashes. 5 of 13 such sidechains are listed below:

Mol	Chain	Res	Type
1	A	509	GLN
1	A	520	GLN

Continued on next page...

Continued from previous page...

Mol	Chain	Res	Type
2	B	394	GLN
2	B	182	GLN
2	B	334	GLN

5.3.3 RNA [i](#)

There are no RNA molecules in this entry.

5.4 Non-standard residues in protein, DNA, RNA chains [i](#)

2 non-standard protein/DNA/RNA residues are modelled in this entry.

In the following table, the Counts columns list the number of bonds (or angles) for which Mogul statistics could be retrieved, the number of bonds (or angles) that are observed in the model and the number of bonds (or angles) that are defined in the Chemical Component Dictionary. The Link column lists molecule types, if any, to which the group is linked. The Z score for a bond length (or angle) is the number of standard deviations the observed value is removed from the expected value. A bond length (or angle) with $|Z| > 2$ is considered an outlier worth inspection. RMSZ is the root-mean-square of all Z scores of the bond lengths (or angles).

Mol	Type	Chain	Res	Link	Bond lengths			Bond angles		
					Counts	RMSZ	# Z > 2	Counts	RMSZ	# Z > 2
3	G47	P	817	1,3,4	19,27,28	0.89	1 (5%)	17,38,41	1.14	2 (11%)
3	DDG	P	822	3,4	17,23,24	1.00	1 (5%)	15,33,36	1.62	4 (26%)

In the following table, the Chirals column lists the number of chiral outliers, the number of chiral centers analysed, the number of these observed in the model and the number defined in the Chemical Component Dictionary. Similar counts are reported in the Torsion and Rings columns. '-' means no outliers of that kind were identified.

Mol	Type	Chain	Res	Link	Chirals	Torsions	Rings
3	G47	P	817	1,3,4	-	2/7/25/26	0/3/3/3
3	DDG	P	822	3,4	-	0/3/18/19	0/3/3/3

All (2) bond length outliers are listed below:

Mol	Chain	Res	Type	Atoms	Z	Observed(Å)	Ideal(Å)
3	P	822	DDG	C6-N1	-2.47	1.34	1.37
3	P	817	G47	C6-N1	-2.21	1.34	1.37

The worst 5 of 6 bond angle outliers are listed below:

Mol	Chain	Res	Type	Atoms	Z	Observed(°)	Ideal(°)
3	P	822	DDG	C2'-C1'-N9	-3.43	106.02	112.48
3	P	822	DDG	C8-N7-C5	2.56	107.87	102.99
3	P	822	DDG	C5-C6-N1	2.55	118.46	113.95
3	P	817	G47	C5-C6-N1	2.19	117.81	113.95
3	P	817	G47	O6-C6-C5	-2.08	120.31	124.37

There are no chirality outliers.

All (2) torsion outliers are listed below:

Mol	Chain	Res	Type	Atoms
3	P	817	G47	N1-C2-N2-C6A
3	P	817	G47	N3-C2-N2-C6A

There are no ring outliers.

No monomer is involved in short contacts.

5.5 Carbohydrates [i](#)

There are no monosaccharides in this entry.

5.6 Ligand geometry [i](#)

Of 6 ligands modelled in this entry, 2 are monoatomic - leaving 4 for Mogul analysis.

In the following table, the Counts columns list the number of bonds (or angles) for which Mogul statistics could be retrieved, the number of bonds (or angles) that are observed in the model and the number of bonds (or angles) that are defined in the Chemical Component Dictionary. The Link column lists molecule types, if any, to which the group is linked. The Z score for a bond length (or angle) is the number of standard deviations the observed value is removed from the expected value. A bond length (or angle) with $|Z| > 2$ is considered an outlier worth inspection. RMSZ is the root-mean-square of all Z scores of the bond lengths (or angles).

Mol	Type	Chain	Res	Link	Bond lengths			Bond angles		
					Counts	RMSZ	# Z > 2	Counts	RMSZ	# Z > 2
7	SO4	P	901	-	4,4,4	0.14	0	6,6,6	0.07	0
6	NQ4	A	603	5	24,28,28	0.57	0	33,43,43	0.91	2 (6%)
7	SO4	T	802	-	4,4,4	0.14	0	6,6,6	0.07	0
7	SO4	T	801	-	4,4,4	0.14	0	6,6,6	0.15	0

In the following table, the Chirals column lists the number of chiral outliers, the number of chiral centers analysed, the number of these observed in the model and the number defined in the

Chemical Component Dictionary. Similar counts are reported in the Torsion and Rings columns. '-' means no outliers of that kind were identified.

Mol	Type	Chain	Res	Link	Chirals	Torsions	Rings
6	NQ4	A	603	5	-	2/22/31/31	0/2/2/2

There are no bond length outliers.

All (2) bond angle outliers are listed below:

Mol	Chain	Res	Type	Atoms	Z	Observed(°)	Ideal(°)
6	A	603	NQ4	P1-O6-P2	3.00	143.14	132.83
6	A	603	NQ4	O7-P2-O6	2.60	113.36	104.64

There are no chirality outliers.

All (2) torsion outliers are listed below:

Mol	Chain	Res	Type	Atoms
6	A	603	NQ4	P1-O3-P-O1
6	A	603	NQ4	P1-O3-P-O2

There are no ring outliers.

No monomer is involved in short contacts.

The following is a two-dimensional graphical depiction of Mogul quality analysis of bond lengths, bond angles, torsion angles, and ring geometry for all instances of the Ligand of Interest. In addition, ligands with molecular weight > 250 and outliers as shown on the validation Tables will also be included. For torsion angles, if less than 5% of the Mogul distribution of torsion angles is within 10 degrees of the torsion angle in question, then that torsion angle is considered an outlier. Any bond that is central to one or more torsion angles identified as an outlier by Mogul will be highlighted in the graph. For rings, the root-mean-square deviation (RMSD) between the ring in question and similar rings identified by Mogul is calculated over all ring torsion angles. If the average RMSD is greater than 60 degrees and the minimal RMSD between the ring in question and any Mogul-identified rings is also greater than 60 degrees, then that ring is considered an outlier. The outliers are highlighted in purple. The color gray indicates Mogul did not find sufficient equivalents in the CSD to analyse the geometry.

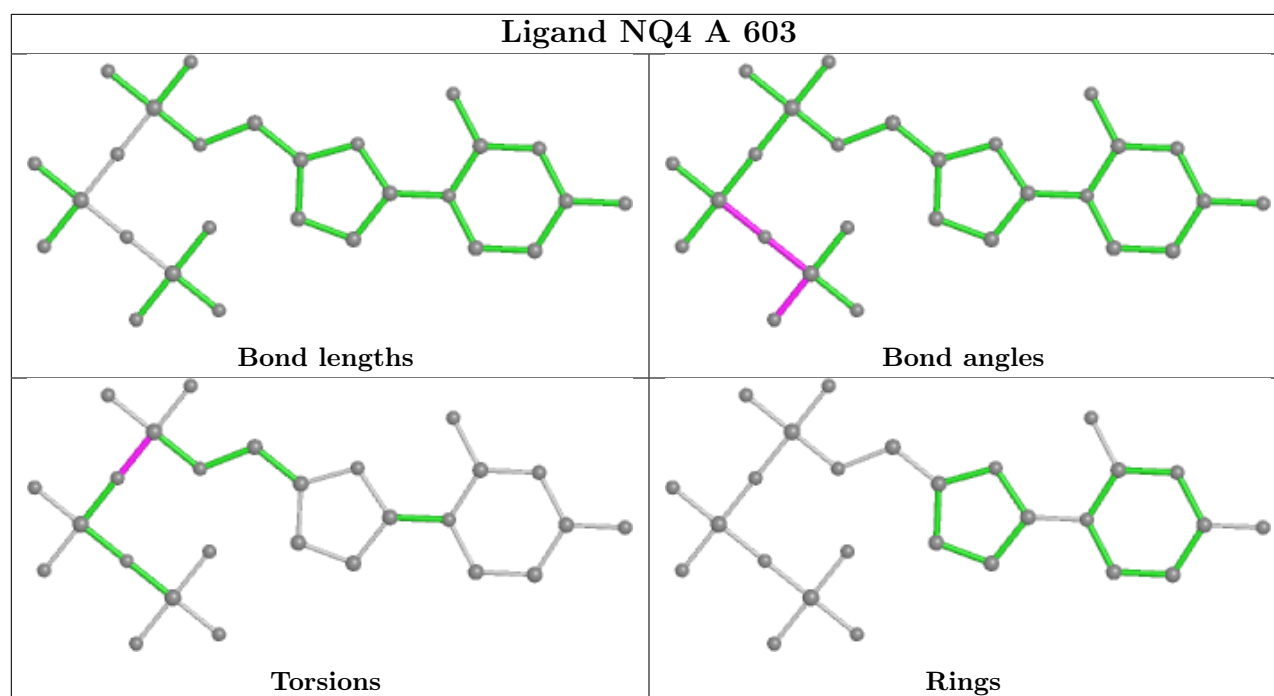

5.7 Other polymers [i](#)

There are no such residues in this entry.

5.8 Polymer linkage issues [i](#)

There are no chain breaks in this entry.

6 Fit of model and data [i](#)

6.1 Protein, DNA and RNA chains [i](#)

In the following table, the column labelled ‘#RSRZ > 2’ contains the number (and percentage) of RSRZ outliers, followed by percent RSRZ outliers for the chain as percentile scores relative to all X-ray entries and entries of similar resolution. The OWAB column contains the minimum, median, 95th percentile and maximum values of the occupancy-weighted average B-factor per residue. The column labelled ‘Q < 0.9’ lists the number of (and percentage) of residues with an average occupancy less than 0.9.

Mol	Chain	Analysed	<RSRZ>	#RSRZ>2	OWAB(Å ²)	Q<0.9
1	A	557/560 (99%)	-0.10	12 (2%) 62 70	30, 49, 83, 167	0
2	B	406/452 (89%)	0.12	18 (4%) 34 43	33, 57, 98, 126	0
3	P	16/21 (76%)	-0.36	0 100 100	42, 61, 70, 87	0
4	T	24/27 (88%)	0.08	2 (8%) 11 15	42, 67, 96, 128	0
All	All	1003/1060 (94%)	-0.01	32 (3%) 47 57	30, 52, 93, 167	0

The worst 5 of 32 RSRZ outliers are listed below:

Mol	Chain	Res	Type	RSRZ
2	B	88	TRP	4.9
2	B	361	HIS	4.3
2	B	67	ASP	4.2
2	B	359	GLY	3.8
2	B	90	VAL	3.6

6.2 Non-standard residues in protein, DNA, RNA chains [i](#)

In the following table, the Atoms column lists the number of modelled atoms in the group and the number defined in the chemical component dictionary. The B-factors column lists the minimum, median, 95th percentile and maximum values of B factors of atoms in the group. The column labelled ‘Q < 0.9’ lists the number of atoms with occupancy less than 0.9.

Mol	Type	Chain	Res	Atoms	RSCC	RSR	B-factors(Å ²)	Q<0.9
3	G47	P	817	25/26	0.93	0.14	44,53,64,70	0
3	DDG	P	822	21/22	0.98	0.15	35,37,42,48	0

6.3 Carbohydrates [i](#)

There are no monosaccharides in this entry.

6.4 Ligands [i](#)

In the following table, the Atoms column lists the number of modelled atoms in the group and the number defined in the chemical component dictionary. The B-factors column lists the minimum, median, 95th percentile and maximum values of B factors of atoms in the group. The column labelled 'Q< 0.9' lists the number of atoms with occupancy less than 0.9.

Mol	Type	Chain	Res	Atoms	RSCC	RSR	B-factors(Å ²)	Q<0.9
7	SO4	T	802	5/5	0.85	0.42	141,142,143,143	0
5	MG	A	601	1/1	0.90	0.20	50,50,50,50	0
7	SO4	P	901	5/5	0.91	0.14	119,120,121,122	0
7	SO4	T	801	5/5	0.93	0.12	98,99,101,101	0
6	NQ4	A	603	27/27	0.94	0.17	41,56,89,90	0
5	MG	A	602	1/1	0.97	0.12	30,30,30,30	0

The following is a graphical depiction of the model fit to experimental electron density of all instances of the Ligand of Interest. In addition, ligands with molecular weight > 250 and outliers as shown on the geometry validation Tables will also be included. Each fit is shown from different orientation to approximate a three-dimensional view.

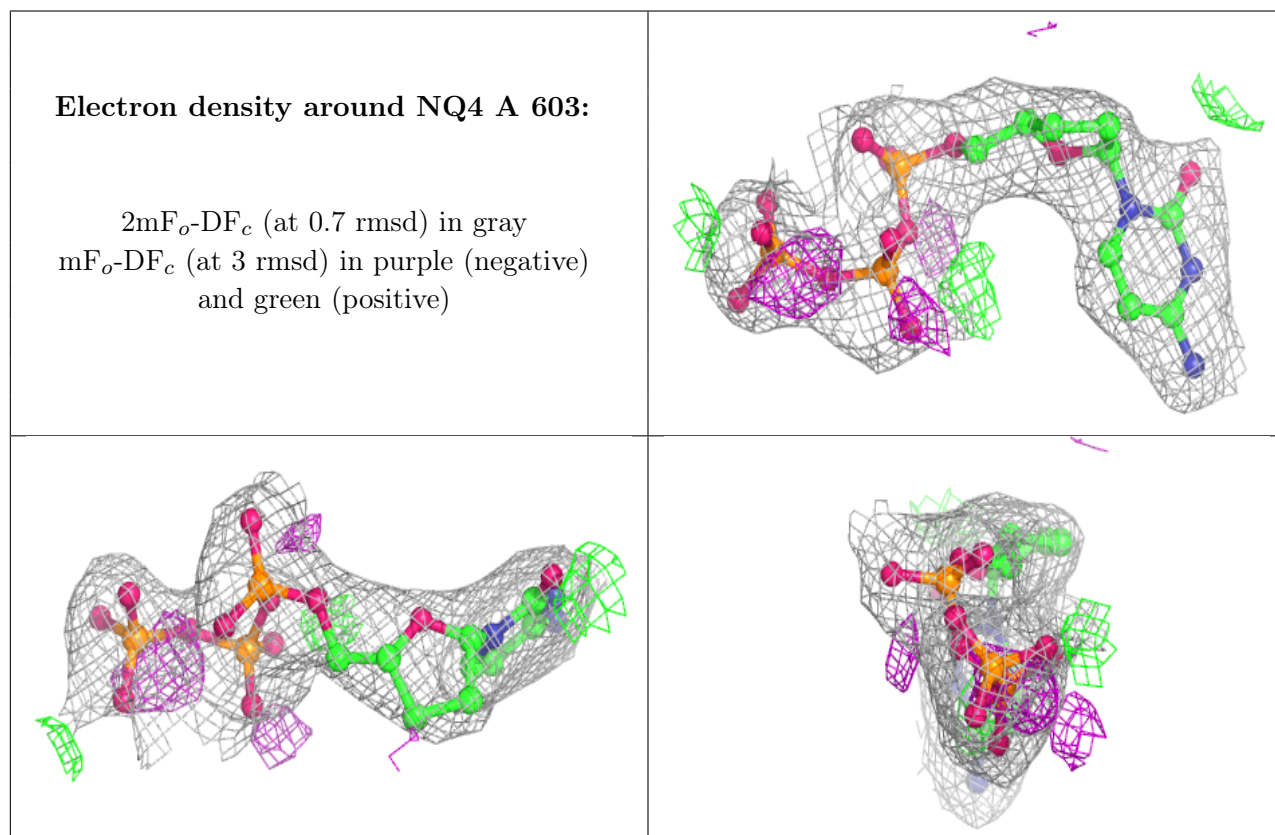

6.5 Other polymers [i](#)

There are no such residues in this entry.