



wwPDB EM Validation Summary Report ⓘ

Mar 4, 2024 – 12:27 AM EST

PDB ID : 6O9L
EMDB ID : EMD-3307
Title : Human holo-PIC in the closed state
Authors : Yan, C.L.; Dodd, T.; He, Y.; Tainer, J.A.; Tsutakawa, S.E.; Ivanov, I.
Deposited on : 2019-03-14
Resolution : 7.20 Å (reported)

This is a wwPDB EM Validation Summary Report for a publicly released PDB entry.

We welcome your comments at validation@mail.wwpdb.org

A user guide is available at

<https://www.wwpdb.org/validation/2017/EMValidationReportHelp>

with specific help available everywhere you see the ⓘ symbol.

The types of validation reports are described at

<http://www.wwpdb.org/validation/2017/FAQs#types>.

The following versions of software and data (see [references ⓘ](#)) were used in the production of this report:

EMDB validation analysis : 0.0.1.dev70
Mogul : 1.8.5 (274361), CSD as541be (2020)
MolProbity : 4.02b-467
Percentile statistics : 20191225.v01 (using entries in the PDB archive December 25th 2019)
MapQ : 1.9.13
Ideal geometry (proteins) : Engh & Huber (2001)
Ideal geometry (DNA, RNA) : Parkinson et al. (1996)
Validation Pipeline (wwPDB-VP) : 2.36

1 Overall quality at a glance

The following experimental techniques were used to determine the structure:

ELECTRON MICROSCOPY

The reported resolution of this entry is 7.20 Å.

Percentile scores (ranging between 0-100) for global validation metrics of the entry are shown in the following graphic. The table shows the number of entries on which the scores are based.

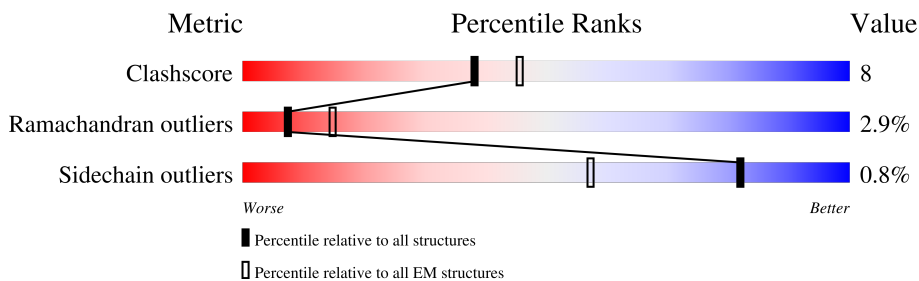

Metric	Whole archive (#Entries)	EM structures (#Entries)
Clashscore	158937	4297
Ramachandran outliers	154571	4023
Sidechain outliers	154315	3826

The table below summarises the geometric issues observed across the polymeric chains and their fit to the map. The red, orange, yellow and green segments of the bar indicate the fraction of residues that contain outliers for ≥ 3 , 2, 1 and 0 types of geometric quality criteria respectively. A grey segment represents the fraction of residues that are not modelled. The numeric value for each fraction is indicated below the corresponding segment, with a dot representing fractions $\leq 5\%$. The upper red bar (where present) indicates the fraction of residues that have poor fit to the EM map (all-atom inclusion $< 40\%$). The numeric value is given above the bar.

Mol	Chain	Length	Quality of chain
1	A	1970	
2	B	1174	
3	C	275	
4	D	142	
5	E	210	
6	F	127	
7	G	172	
8	H	150	

Continued on next page...

Continued from previous page...

Mol	Chain	Length	Quality of chain
9	I	125	17% 86% 12%
10	J	67	76% 22%
11	K	117	6% 85% 15%
12	L	58	67% 10% 21%
13	M	316	26% 74% 22%
14	N	376	6% 24% 6% 70%
15	O	109	12% 77% 14% 9%
16	P	339	44% 10% 45%
17	Q	439	65% 82% 14%
18	R	291	13% 51% 6% 42%
19	S	517	17% 26% 6% 66%
20	T	249	28% 79% 16% 5%
21	U	301	17% 47% 8% 44%
22	0	760	33% 68% 25%
23	1	548	76% 79% 19%
24	2	462	53% 74% 23%
25	3	309	81% 79% 18%
26	4	308	41% 77% 17%
27	5	71	66% 87% 6% 7%
28	6	395	31% 71% 25%
29	7	782	38% 61% 18% 19%
30	8	346	86% 63% 22% 14%
31	9	323	85% 75% 10% 15%
32	X	65	9% 82% 18%
33	Y	65	5% 85% 15%

2 Entry composition [i](#)

There are 36 unique types of molecules in this entry. The entry contains 81800 atoms, of which 0 are hydrogens and 0 are deuteriums.

In the tables below, the AltConf column contains the number of residues with at least one atom in alternate conformation and the Trace column contains the number of residues modelled with at most 2 atoms.

- Molecule 1 is a protein called DNA-directed RNA polymerase II subunit RPB1.

Mol	Chain	Residues	Atoms					AltConf	Trace
			Total	C	N	O	S		
1	A	1476	11693	7341	2085	2193	74	0	0

- Molecule 2 is a protein called DNA-directed RNA polymerase II subunit RPB2.

Mol	Chain	Residues	Atoms					AltConf	Trace
			Total	C	N	O	S		
2	B	1165	9317	5878	1637	1738	64	0	0

- Molecule 3 is a protein called DNA-directed RNA polymerase II subunit RPB3.

Mol	Chain	Residues	Atoms					AltConf	Trace
			Total	C	N	O	S		
3	C	275	2213	1386	380	440	7	0	0

- Molecule 4 is a protein called DNA-directed RNA polymerase II subunit RPB4.

Mol	Chain	Residues	Atoms					AltConf	Trace
			Total	C	N	O	S		
4	D	129	1062	665	179	214	4	0	0

- Molecule 5 is a protein called DNA-directed RNA polymerase II subunit RPB5.

Mol	Chain	Residues	Atoms					AltConf	Trace
			Total	C	N	O	S		
5	E	210	1723	1088	301	325	9	0	0

- Molecule 6 is a protein called DNA-directed RNA polymerases I, II, and III subunit RPABC2.

Mol	Chain	Residues	Atoms					AltConf	Trace
			Total	C	N	O	S		
6	F	86	689	437	120	127	5	0	0

- Molecule 7 is a protein called DNA-directed RNA polymerase II subunit RPB7.

Mol	Chain	Residues	Atoms					AltConf	Trace
			Total	C	N	O	S		
7	G	171	1351	875	219	249	8	0	0

- Molecule 8 is a protein called DNA-directed RNA polymerases I, II, and III subunit RPABC3.

Mol	Chain	Residues	Atoms					AltConf	Trace
			Total	C	N	O	S		
8	H	150	1205	764	196	239	6	0	0

- Molecule 9 is a protein called DNA-directed RNA polymerase II subunit RPB9.

Mol	Chain	Residues	Atoms					AltConf	Trace
			Total	C	N	O	S		
9	I	125	1013	626	177	198	12	0	0

- Molecule 10 is a protein called DNA-directed RNA polymerases I, II, and III subunit RPABC5.

Mol	Chain	Residues	Atoms					AltConf	Trace
			Total	C	N	O	S		
10	J	67	533	345	90	92	6	0	0

- Molecule 11 is a protein called DNA-directed RNA polymerase II subunit RPB11-a.

Mol	Chain	Residues	Atoms					AltConf	Trace
			Total	C	N	O	S		
11	K	117	936	603	154	177	2	0	0

- Molecule 12 is a protein called DNA-directed RNA polymerases I, II, and III subunit RPABC4.

Mol	Chain	Residues	Atoms					AltConf	Trace
			Total	C	N	O	S		
12	L	46	388	241	75	66	6	0	0

- Molecule 13 is a protein called Transcription initiation factor IIB.

Mol	Chain	Residues	Atoms					AltConf	Trace
			Total	C	N	O	S		
13	M	310	2391	1490	426	457	18	0	0

- Molecule 14 is a protein called Transcription initiation factor IIA subunit 1.

Mol	Chain	Residues	Atoms					AltConf	Trace
			Total	C	N	O	S		
14	N	113	930	585	152	189	4	0	0

- Molecule 15 is a protein called Transcription initiation factor IIA subunit 2.

Mol	Chain	Residues	Atoms					AltConf	Trace
			Total	C	N	O	S		
15	O	99	806	510	142	151	3	0	0

- Molecule 16 is a protein called TATA-box-binding protein.

Mol	Chain	Residues	Atoms					AltConf	Trace
			Total	C	N	O	S		
16	P	185	1462	946	257	252	7	0	0

- Molecule 17 is a protein called General transcription factor IIE subunit 1.

Mol	Chain	Residues	Atoms					AltConf	Trace
			Total	C	N	O	S		
17	Q	430	3398	2100	590	688	20	0	0

- Molecule 18 is a protein called Transcription initiation factor IIE subunit beta.

Mol	Chain	Residues	Atoms					AltConf	Trace
			Total	C	N	O	S		
18	R	168	1377	878	238	257	4	0	0

- Molecule 19 is a protein called General transcription factor IIF subunit 1.

Mol	Chain	Residues	Atoms					AltConf	Trace
			Total	C	N	O	S		
19	S	176	1461	921	268	268	4	0	0

- Molecule 20 is a protein called General transcription factor IIF subunit 2.

Mol	Chain	Residues	Atoms					AltConf	Trace
			Total	C	N	O	S		
20	T	237	1893	1192	341	357	3	0	0

- Molecule 21 is a protein called Transcription elongation factor A protein 1.

Mol	Chain	Residues	Atoms					AltConf	Trace
			Total	C	N	O	S		
21	U	170	1343	818	247	263	15	0	0

- Molecule 22 is a protein called TFIIF basal transcription factor complex helicase XPD subunit.

Mol	Chain	Residues	Atoms					AltConf	Trace
			Total	C	N	O	S		
22	0	732	5895	3766	1029	1072	28	0	0

- Molecule 23 is a protein called General transcription factor IIH subunit 1.

Mol	Chain	Residues	Atoms					AltConf	Trace
			Total	C	N	O	S		
23	1	546	4342	2727	762	832	21	0	0

- Molecule 24 is a protein called General transcription factor IIH subunit 4, p52.

Mol	Chain	Residues	Atoms					AltConf	Trace
			Total	C	N	O	S		
24	2	453	3613	2323	634	642	14	0	0

- Molecule 25 is a protein called CDK-activating kinase assembly factor MAT1.

Mol	Chain	Residues	Atoms					AltConf	Trace
			Total	C	N	O	S		
25	3	309	2513	1580	438	481	14	0	0

- Molecule 26 is a protein called General transcription factor IIH subunit 3.

Mol	Chain	Residues	Atoms					AltConf	Trace
			Total	C	N	O	S		
26	4	295	2307	1477	385	426	19	0	0

- Molecule 27 is a protein called General transcription factor IIH subunit 5.

Mol	Chain	Residues	Atoms					AltConf	Trace
			Total	C	N	O	S		
27	5	66	522	336	83	100	3	0	0

- Molecule 28 is a protein called General transcription factor IIH subunit 2.

Mol	Chain	Residues	Atoms					AltConf	Trace
			Total	C	N	O	S		
28	6	385	3024	1909	524	564	27	0	0

- Molecule 29 is a protein called TFIIH basal transcription factor complex helicase XPB subunit.

Mol	Chain	Residues	Atoms					AltConf	Trace
			Total	C	N	O	S		
29	7	634	5095	3247	881	937	30	0	0

- Molecule 30 is a protein called Cyclin-dependent kinase 7.

Mol	Chain	Residues	Atoms					AltConf	Trace
			Total	C	N	O	S		
30	8	299	2378	1535	406	426	11	0	0

- Molecule 31 is a protein called Cyclin-H.

Mol	Chain	Residues	Atoms					AltConf	Trace
			Total	C	N	O	S		
31	9	276	2241	1438	380	406	17	0	0

- Molecule 32 is a DNA chain called DNA (65-MER).

Mol	Chain	Residues	Atoms					AltConf	Trace
			Total	C	N	O	P		
32	X	65	1343	633	261	385	64	0	0

- Molecule 33 is a DNA chain called DNA (65-MER).

Mol	Chain	Residues	Atoms					AltConf	Trace
			Total	C	N	O	P		
33	Y	65	1316	625	236	391	64	0	0

- Molecule 34 is MAGNESIUM ION (three-letter code: MG) (formula: Mg).

Mol	Chain	Residues	Atoms		AltConf
34	A	1	Total	Mg	0
			1	1	
34	B	1	Total	Mg	0
			1	1	

- Molecule 35 is ZINC ION (three-letter code: ZN) (formula: Zn).

Mol	Chain	Residues	Atoms	AltConf
35	A	2	Total Zn 2 2	0
35	B	1	Total Zn 1 1	0
35	C	1	Total Zn 1 1	0
35	I	2	Total Zn 2 2	0
35	J	1	Total Zn 1 1	0
35	L	1	Total Zn 1 1	0
35	M	1	Total Zn 1 1	0
35	Q	1	Total Zn 1 1	0
35	U	1	Total Zn 1 1	0
35	3	2	Total Zn 2 2	0
35	4	1	Total Zn 1 1	0
35	6	3	Total Zn 3 3	0

- Molecule 36 is IRON/SULFUR CLUSTER (three-letter code: SF4) (formula: Fe₄S₄).

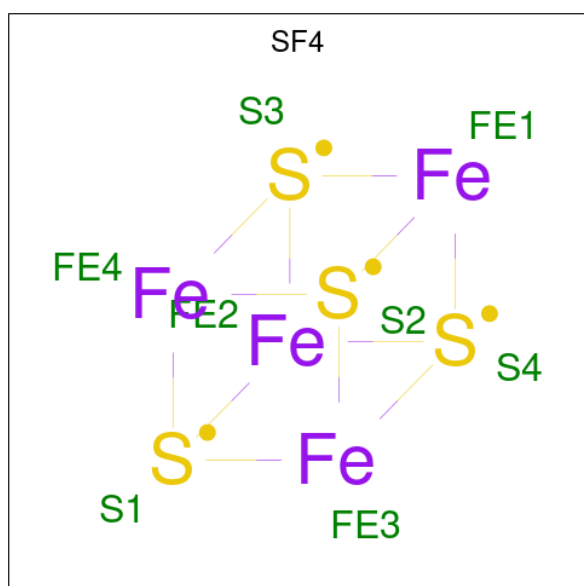

Mol	Chain	Residues	Atoms			AltConf
			Total	Fe	S	
36	0	1	8	4	4	0

3 Residue-property plots

These plots are drawn for all protein, RNA, DNA and oligosaccharide chains in the entry. The first graphic for a chain summarises the proportions of the various outlier classes displayed in the second graphic. The second graphic shows the sequence view annotated by issues in geometry and atom inclusion in map density. Residues are color-coded according to the number of geometric quality criteria for which they contain at least one outlier: green = 0, yellow = 1, orange = 2 and red = 3 or more. A red diamond above a residue indicates a poor fit to the EM map for this residue (all-atom inclusion < 40%). Stretches of 2 or more consecutive residues without any outlier are shown as a green connector. Residues present in the sample, but not in the model, are shown in grey.

- Molecule 1: DNA-directed RNA polymerase II subunit RPB1



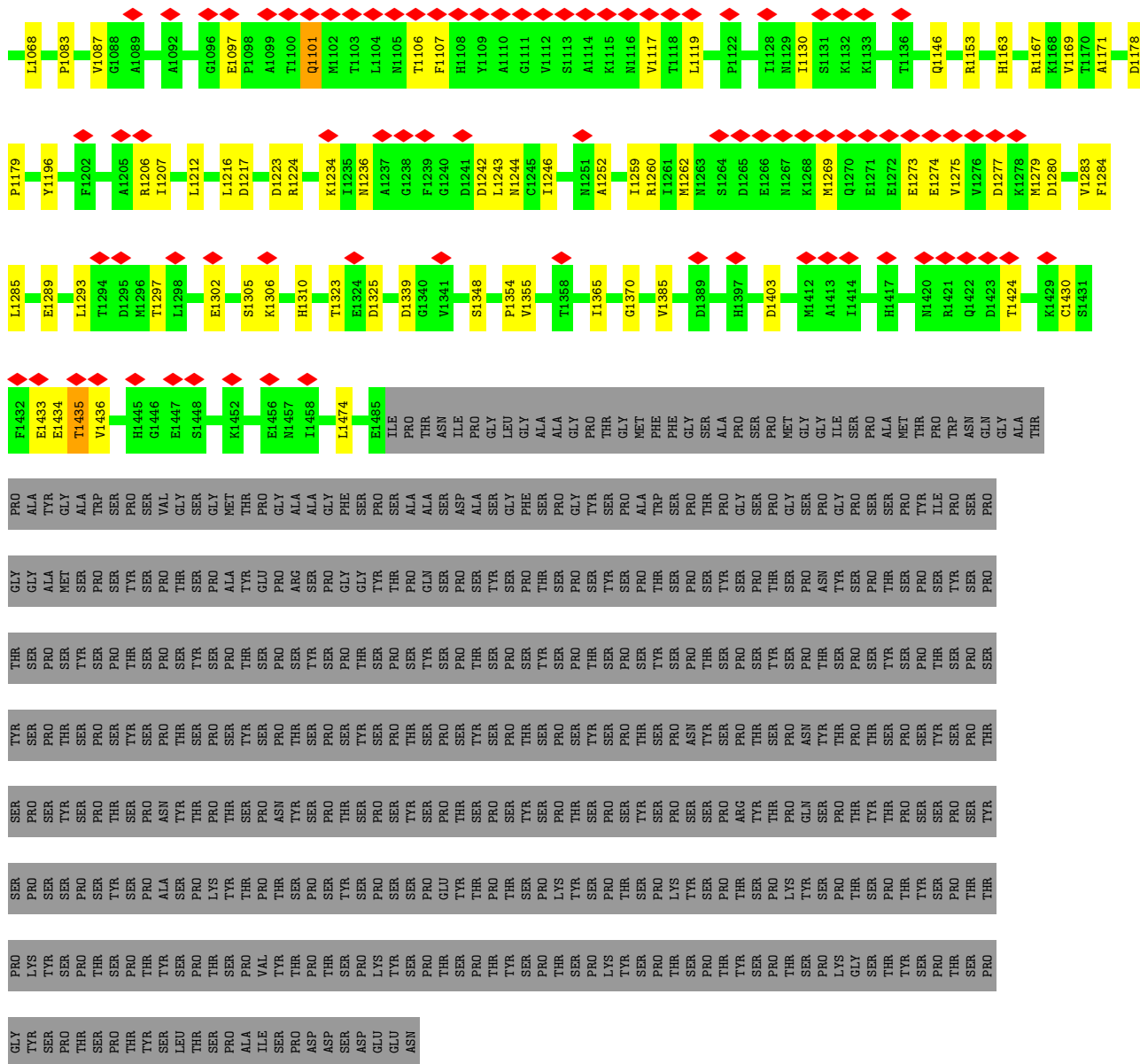

● Molecule 2: DNA-directed RNA polymerase II subunit RPB2

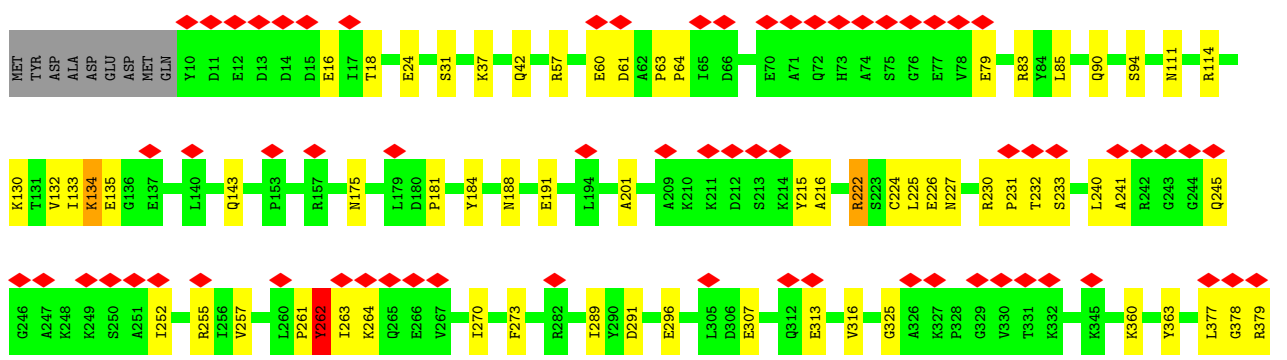
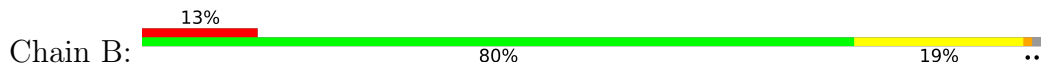

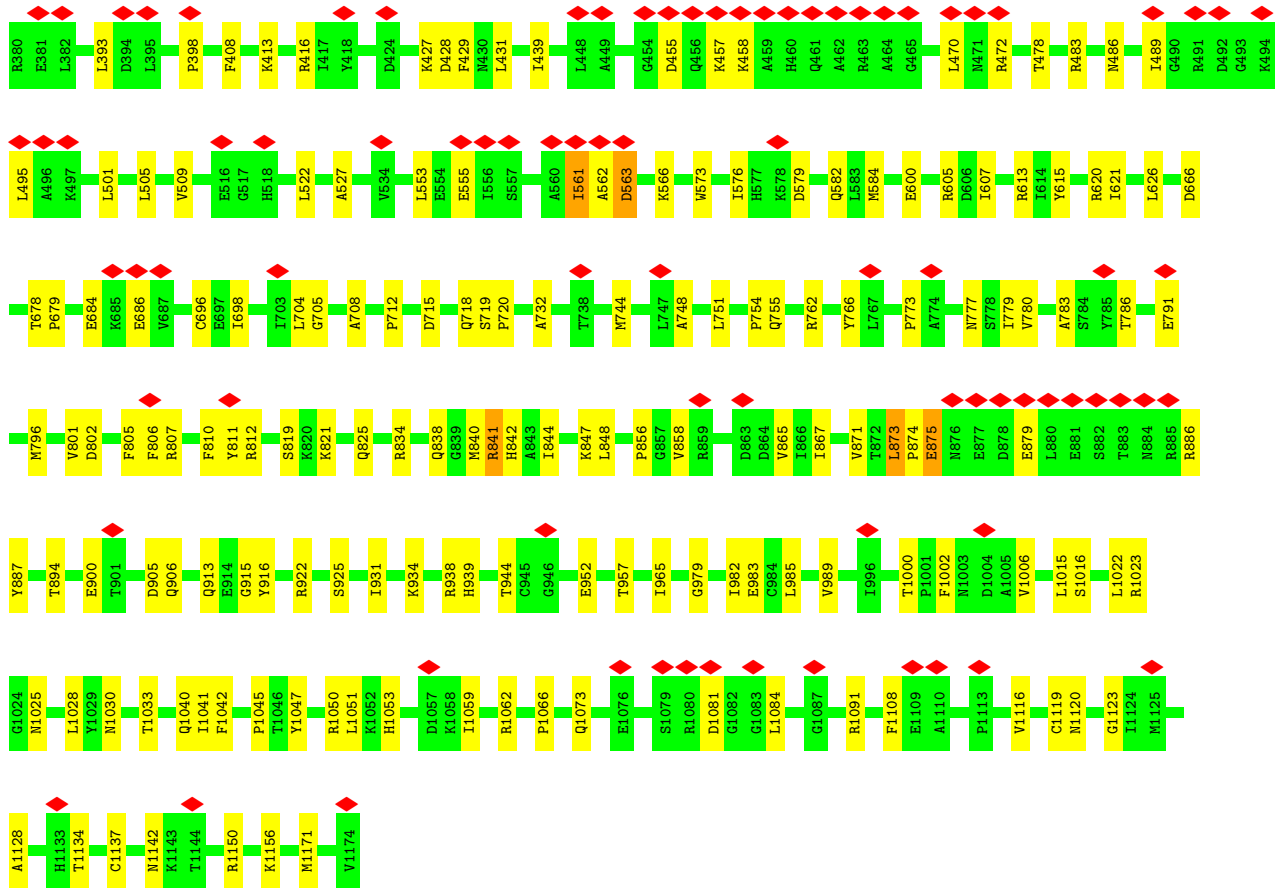

• Molecule 3: DNA-directed RNA polymerase II subunit RPB3

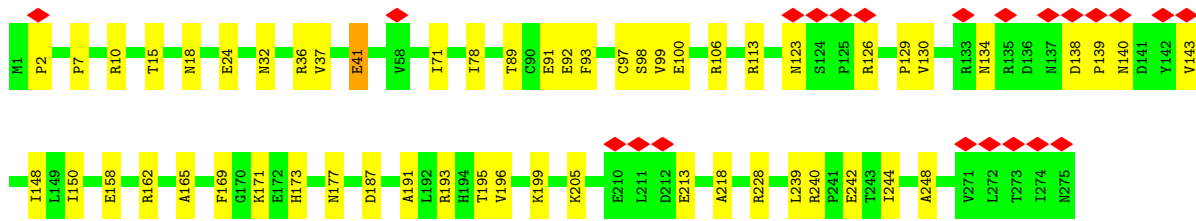
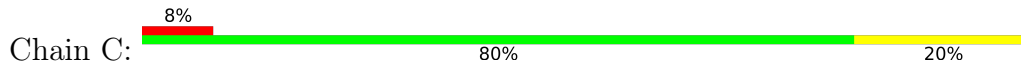

• Molecule 4: DNA-directed RNA polymerase II subunit RPB4

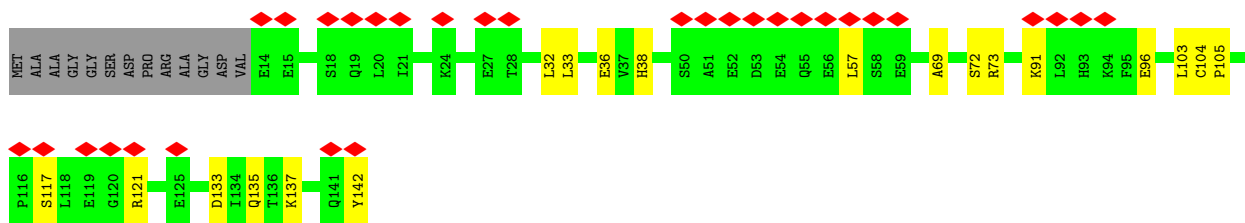
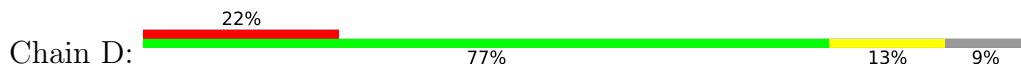

• Molecule 5: DNA-directed RNA polymerase II subunit RPB5

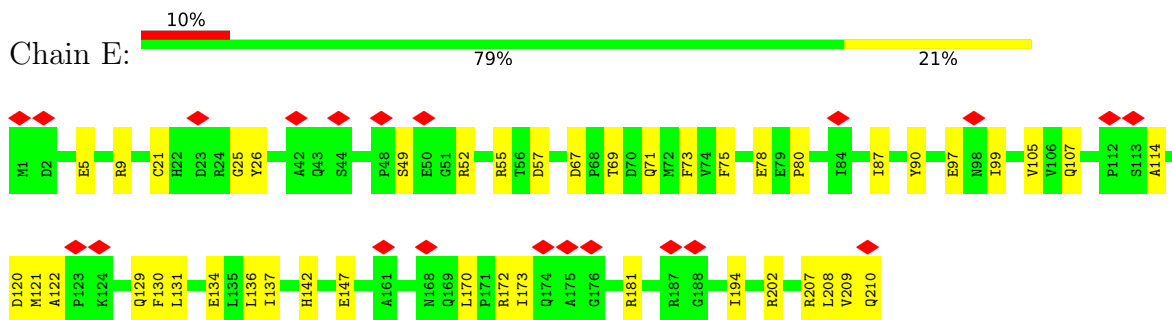

- Molecule 6: DNA-directed RNA polymerases I, II, and III subunit RPABC2

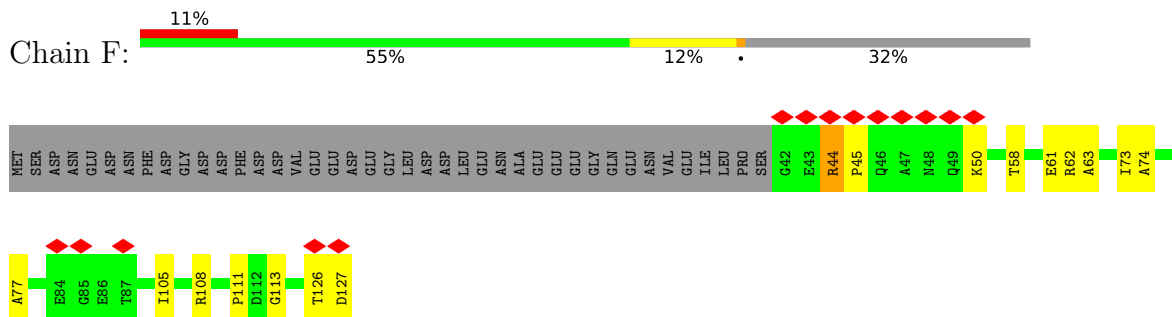

- Molecule 7: DNA-directed RNA polymerase II subunit RPB7

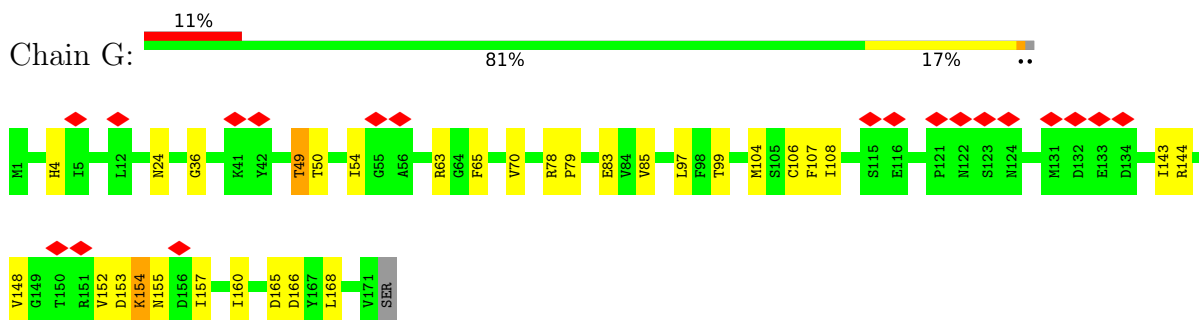

- Molecule 8: DNA-directed RNA polymerases I, II, and III subunit RPABC3

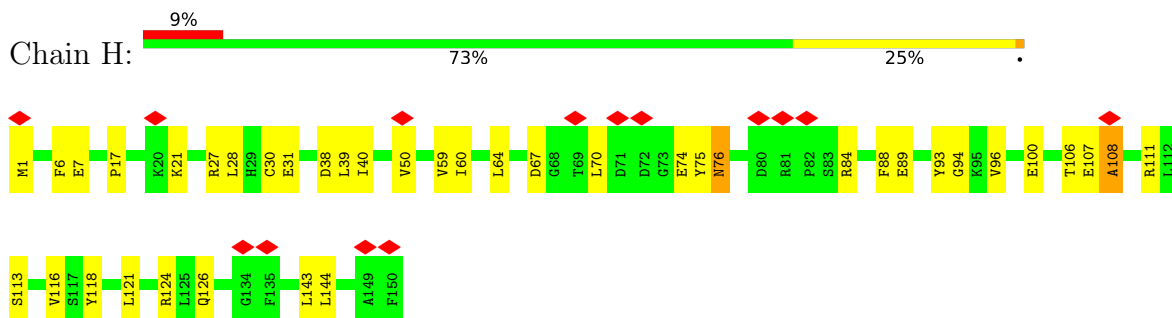

- Molecule 9: DNA-directed RNA polymerase II subunit RPB9

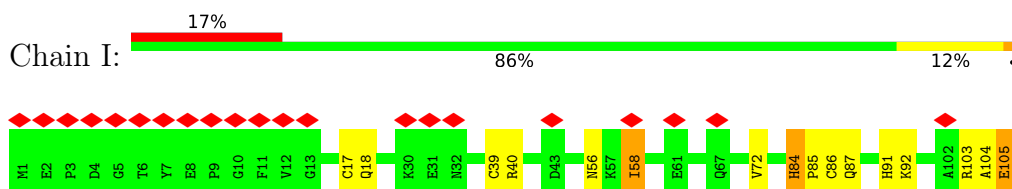

- Molecule 10: DNA-directed RNA polymerases I, II, and III subunit RPABC5

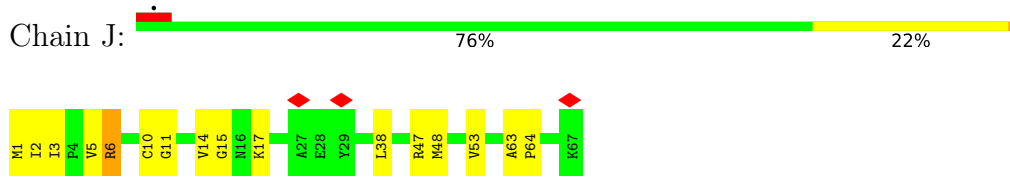

- Molecule 11: DNA-directed RNA polymerase II subunit RPB11-a

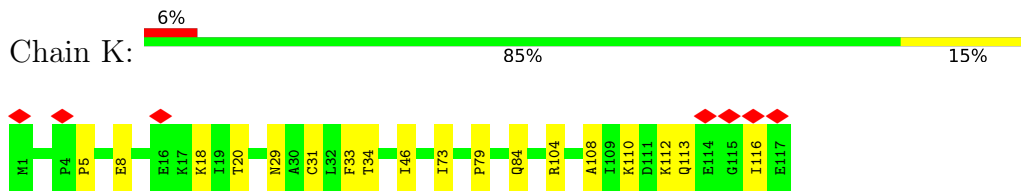

- Molecule 12: DNA-directed RNA polymerases I, II, and III subunit RPABC4

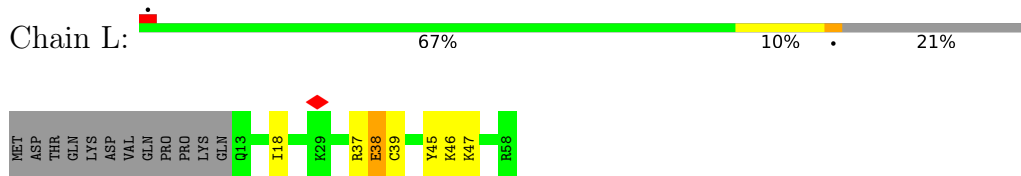

- Molecule 13: Transcription initiation factor IIB

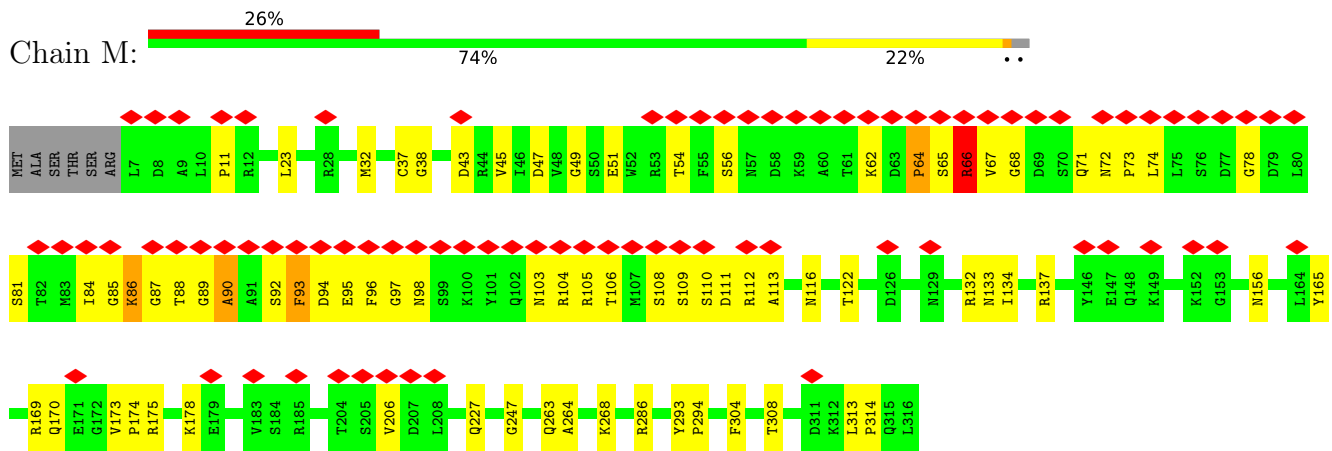

- Molecule 14: Transcription initiation factor IIA subunit 1

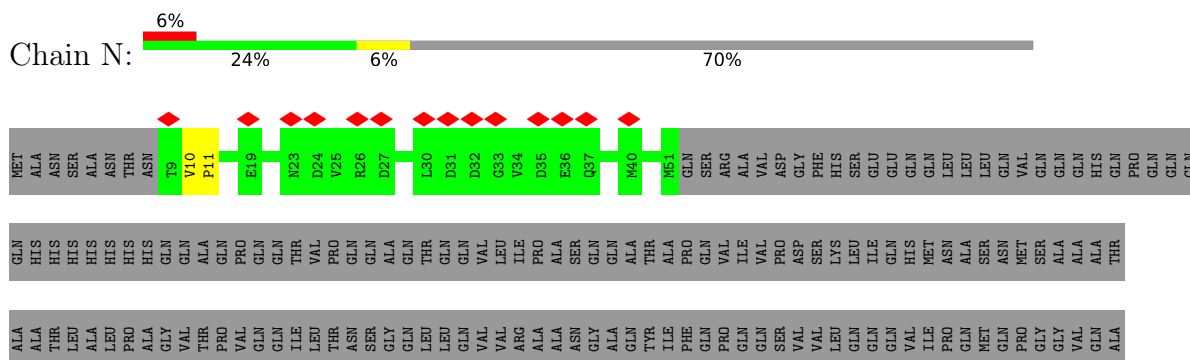

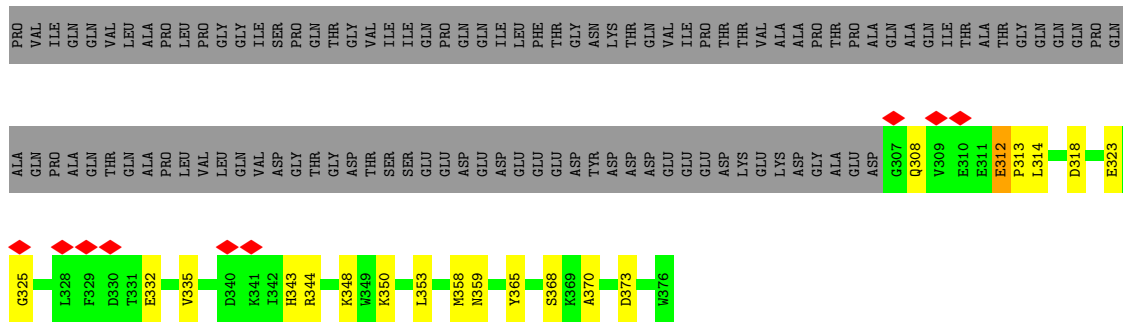

Molecule 15: Transcription initiation factor IIA subunit 2

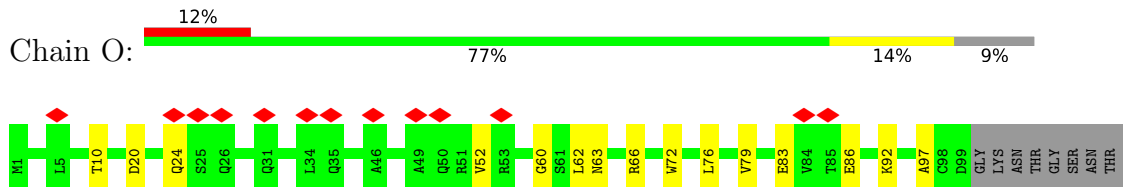

Molecule 16: TATA-box-binding protein

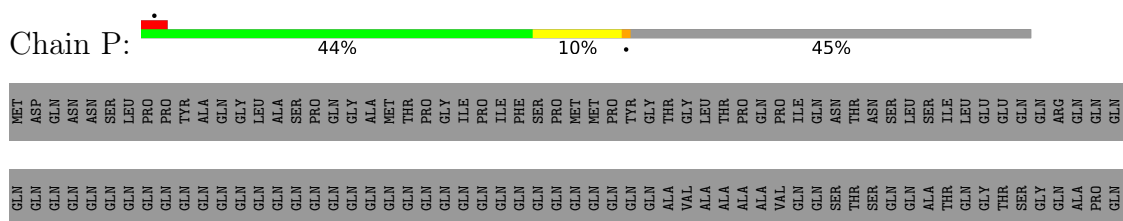

Molecule 17: General transcription factor IIE subunit 1

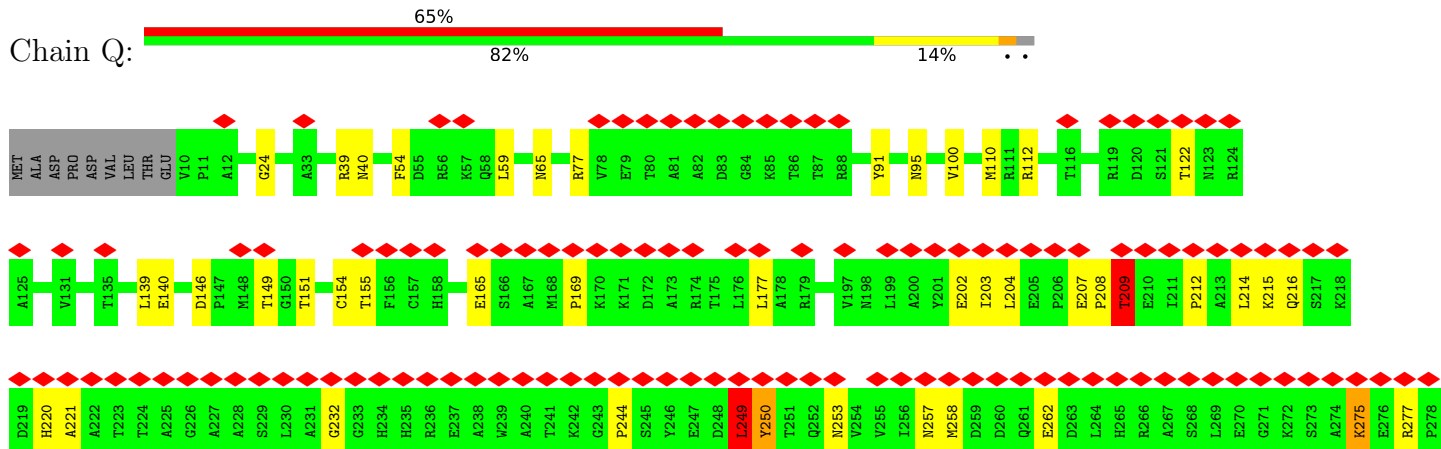

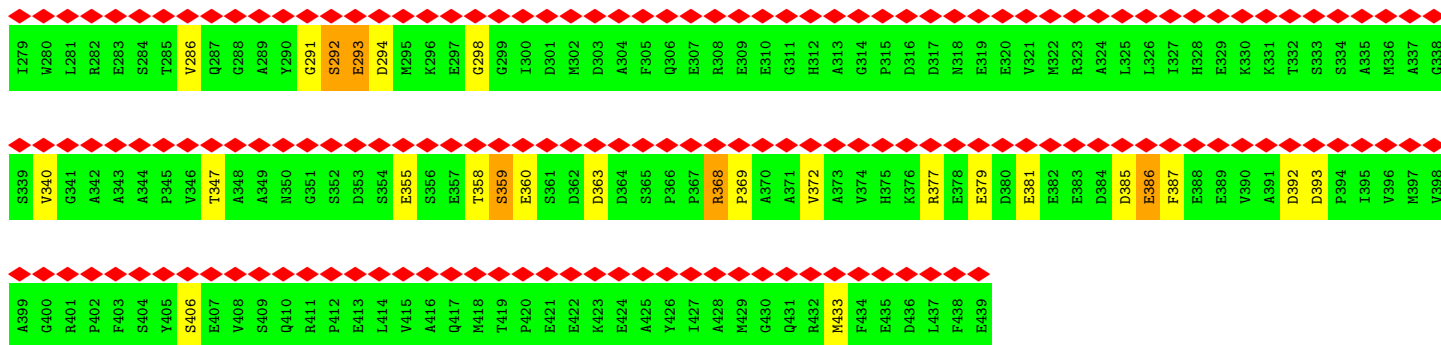

• Molecule 18: Transcription initiation factor IIE subunit beta

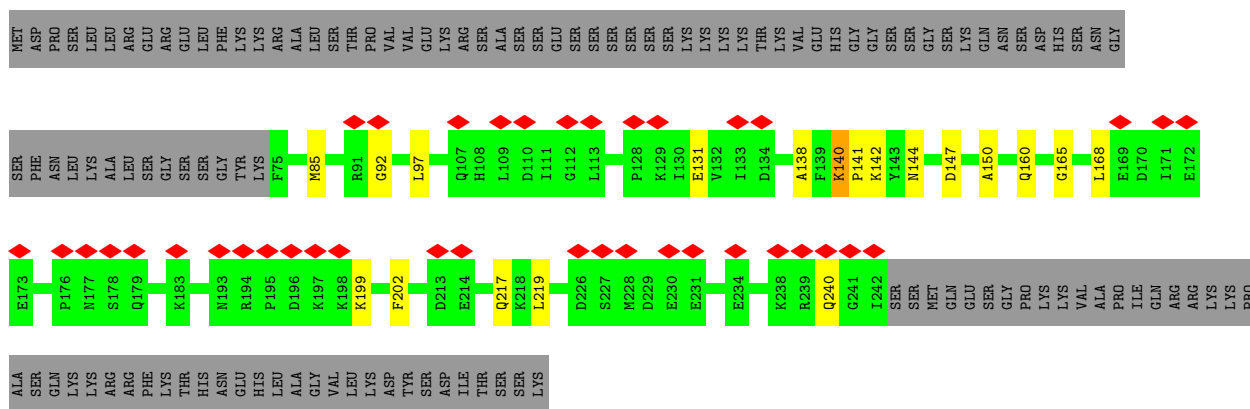

• Molecule 19: General transcription factor IIF subunit 1

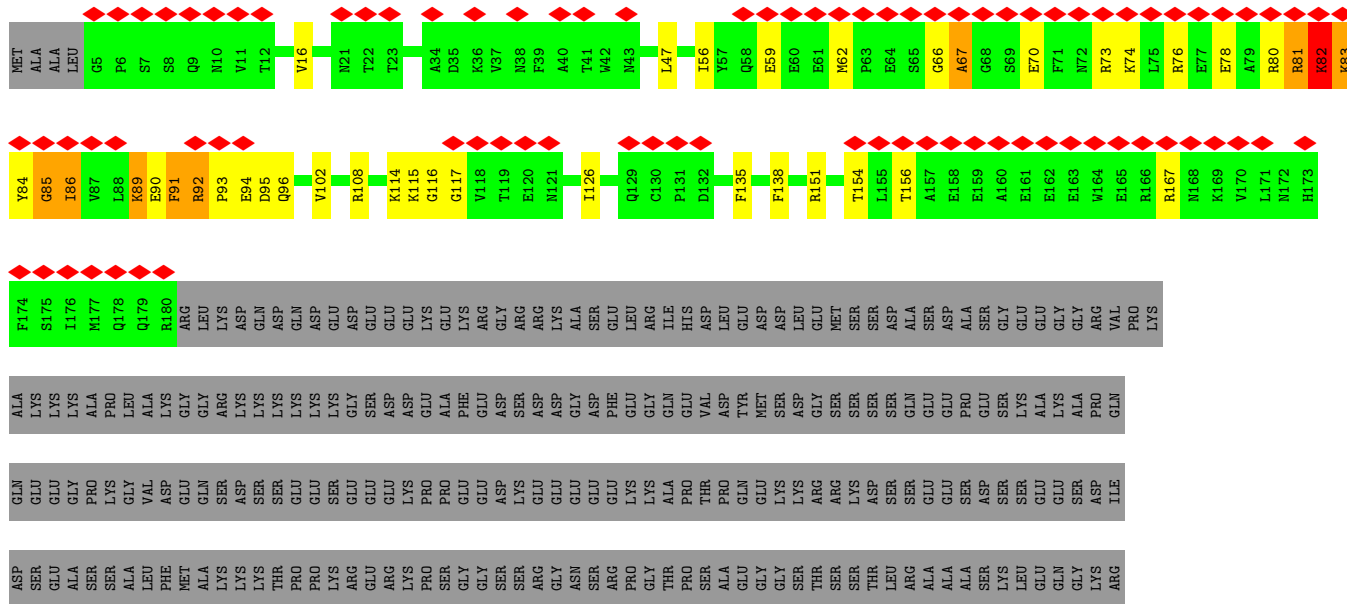

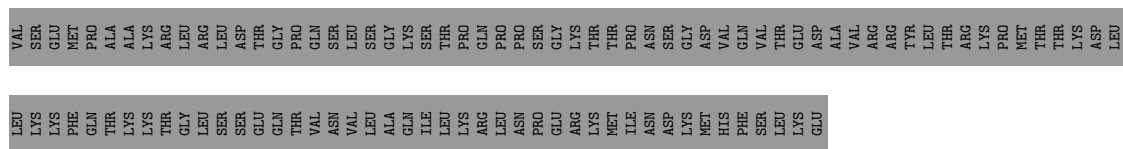

● Molecule 20: General transcription factor IIF subunit 2

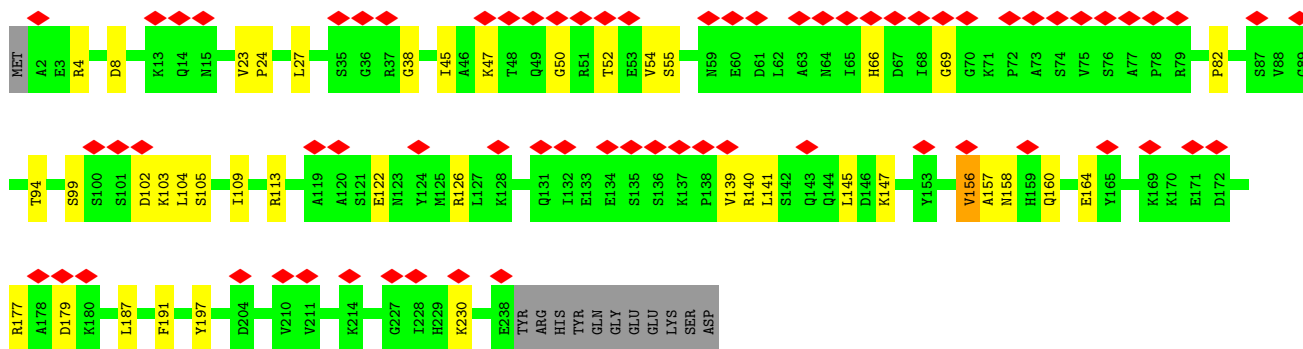
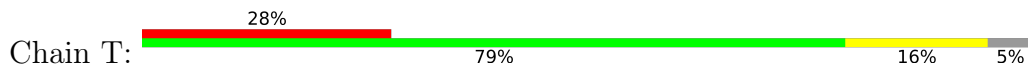

● Molecule 21: Transcription elongation factor A protein 1

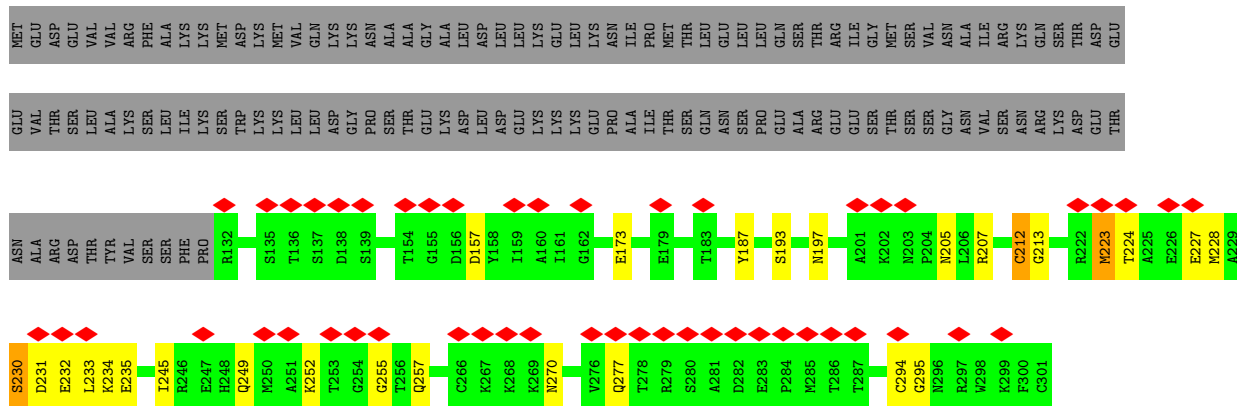

● Molecule 22: TFIIF basal transcription factor complex helicase XPD subunit

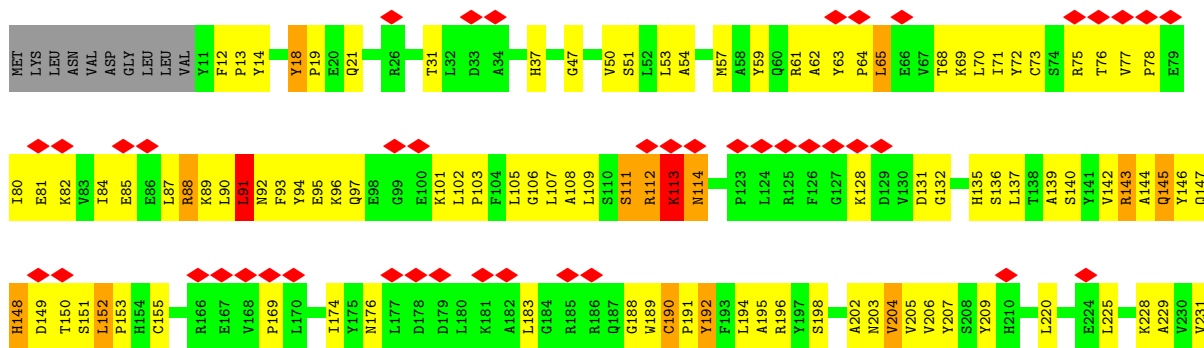

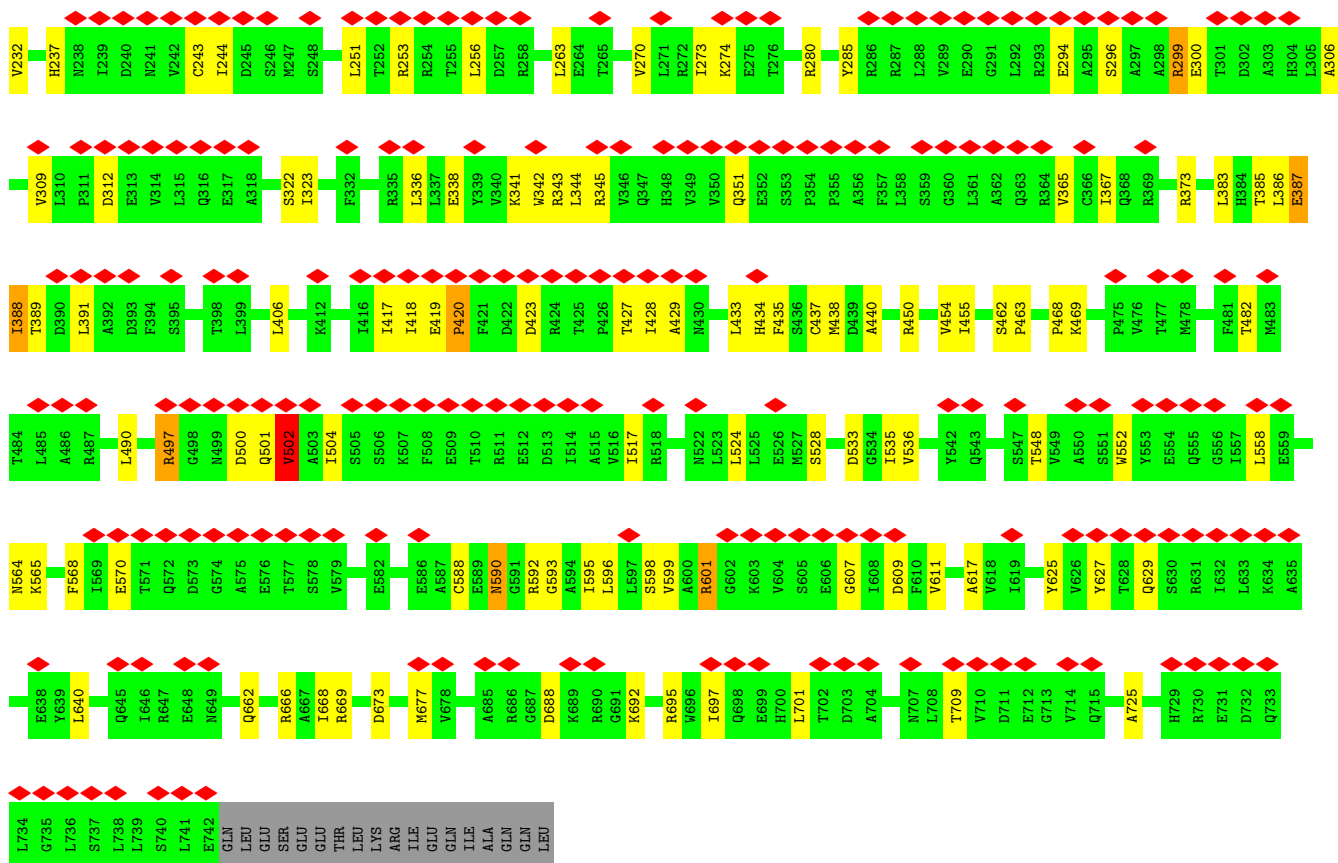

• Molecule 23: General transcription factor IIH subunit 1

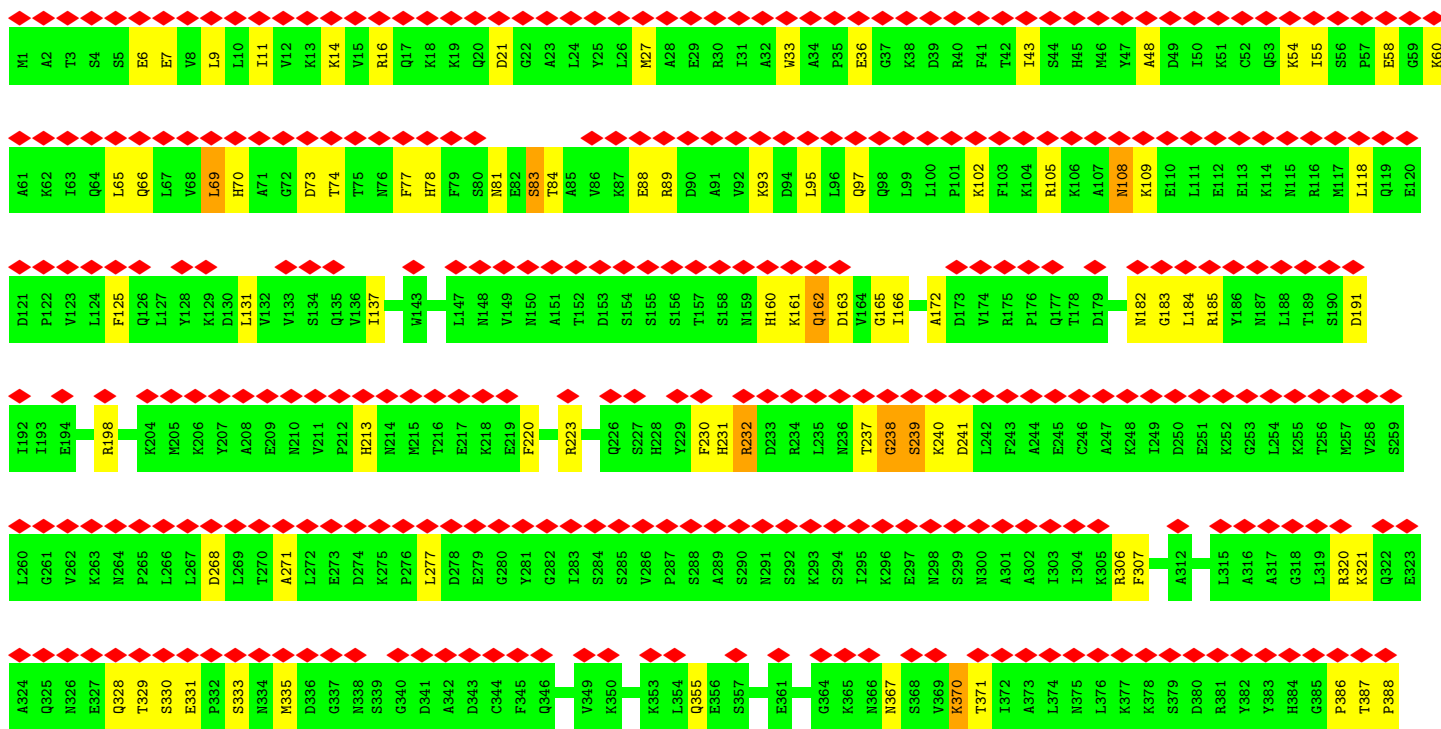
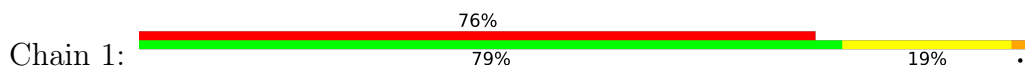

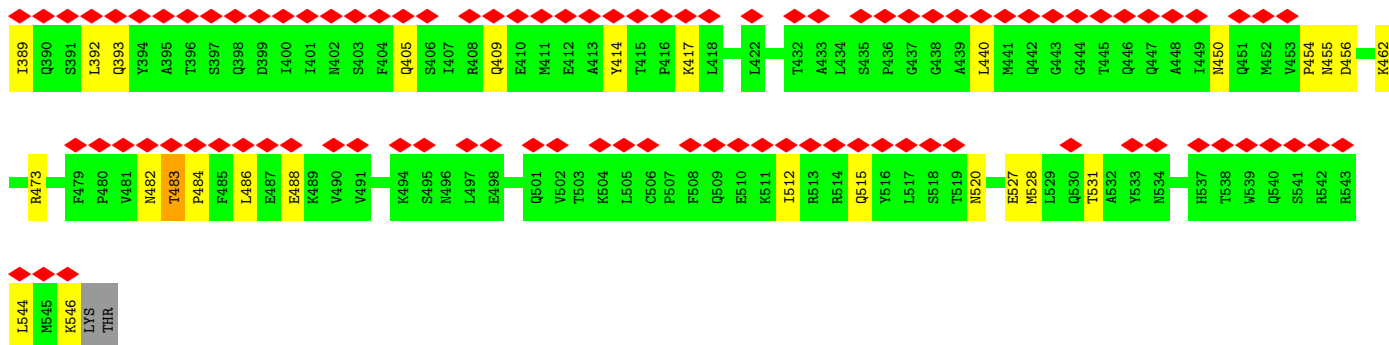

• Molecule 24: General transcription factor IIH subunit 4, p52

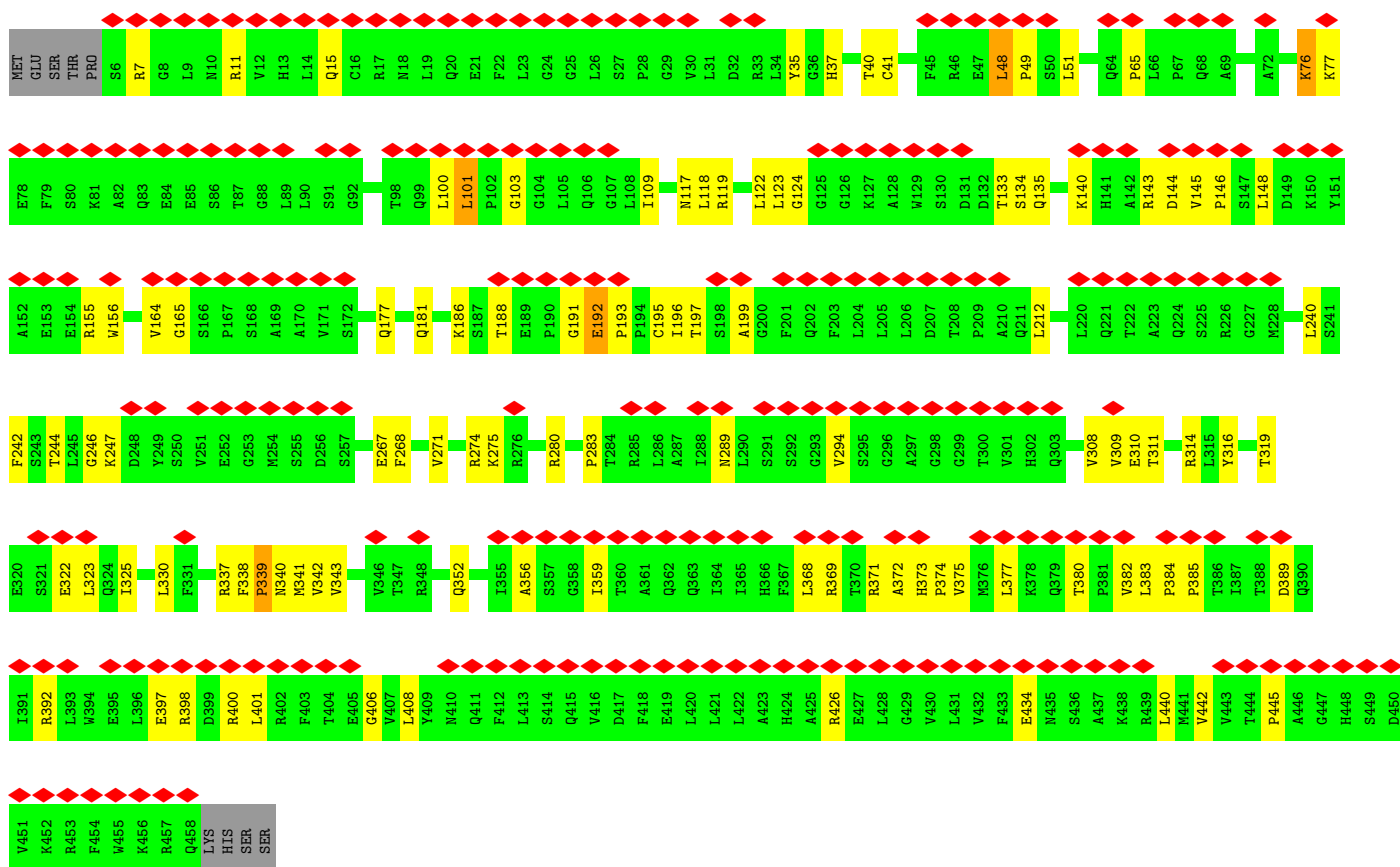
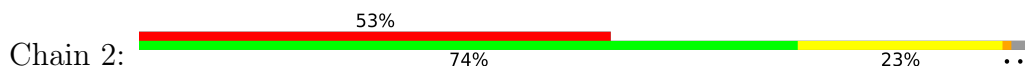

• Molecule 25: CDK-activating kinase assembly factor MAT1

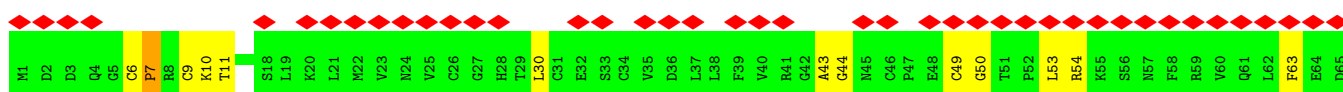
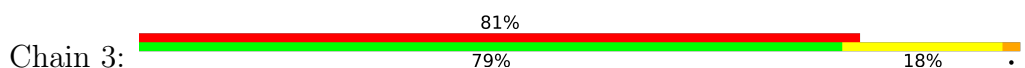

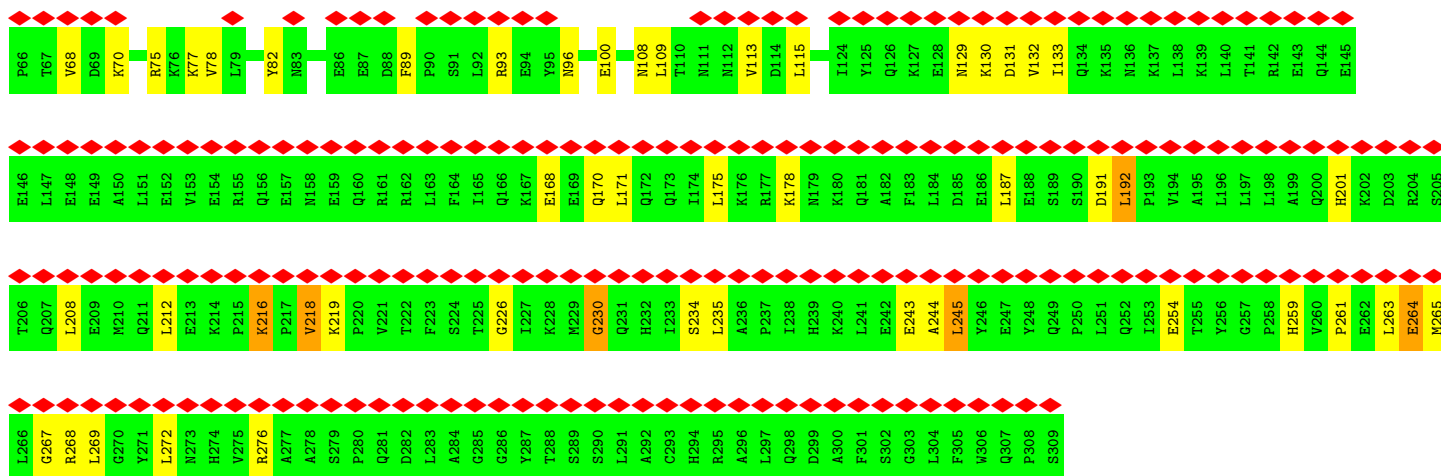

• Molecule 26: General transcription factor IIH subunit 3

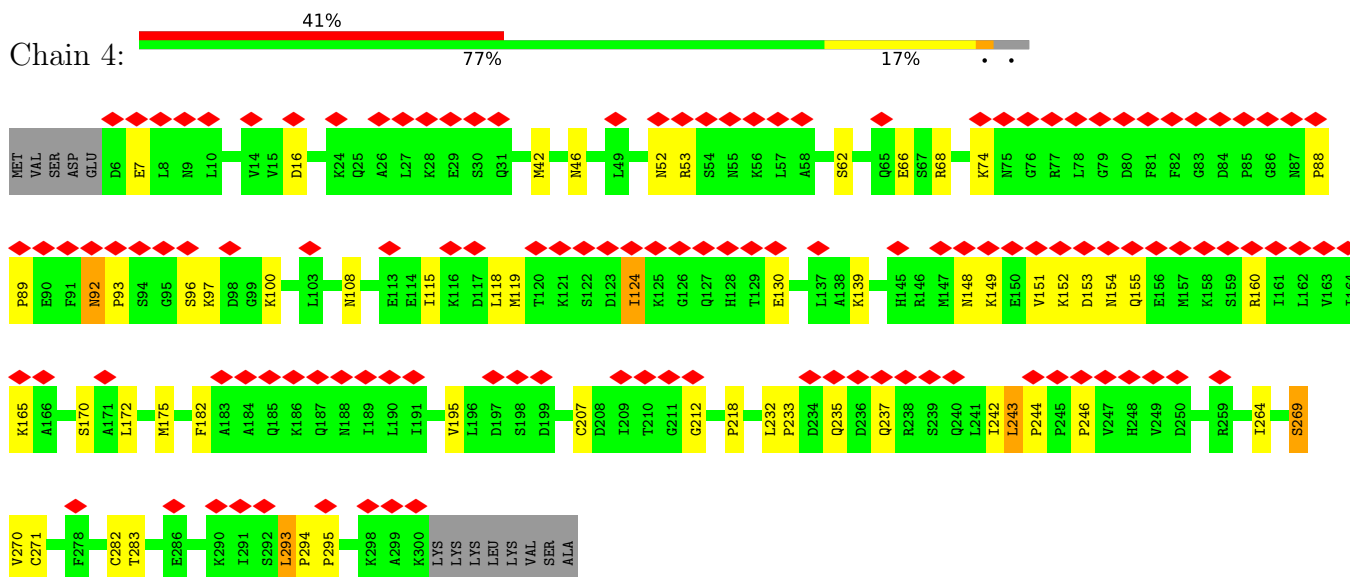

• Molecule 27: General transcription factor IIH subunit 5

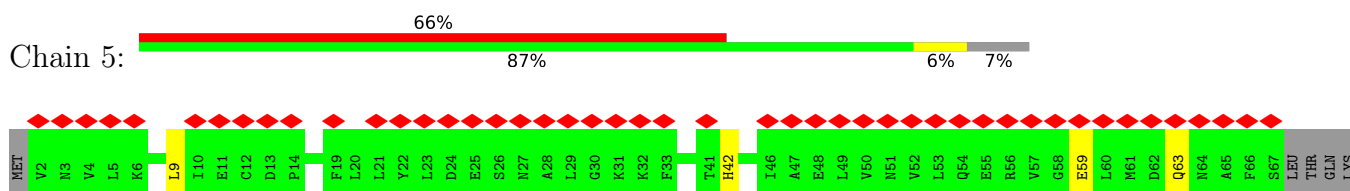

• Molecule 28: General transcription factor IIH subunit 2

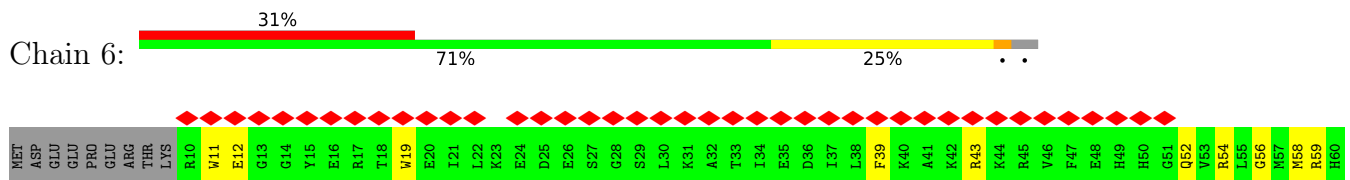

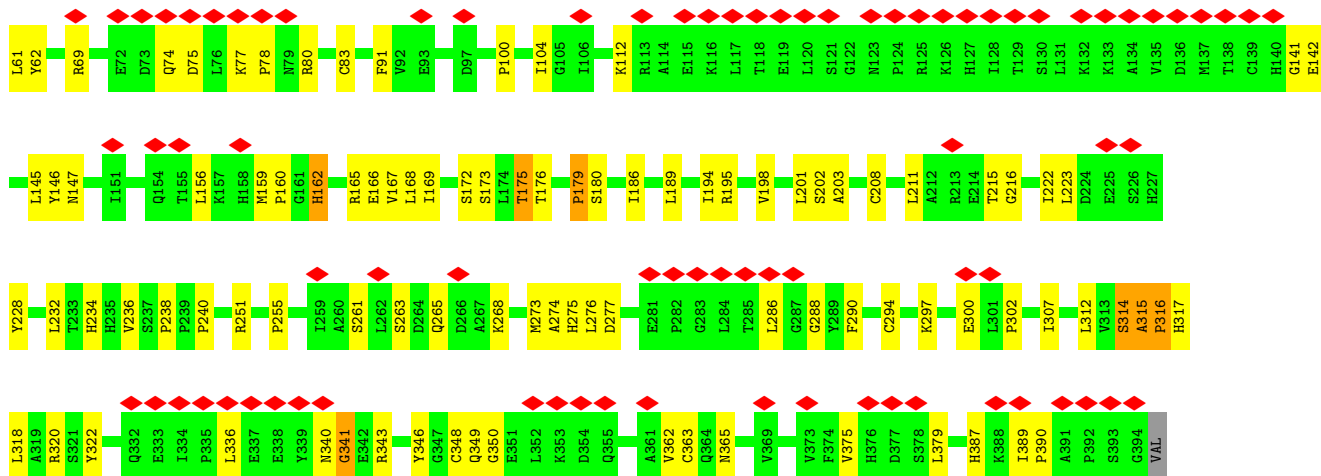

• Molecule 29: TFIID basal transcription factor complex helicase XPB subunit

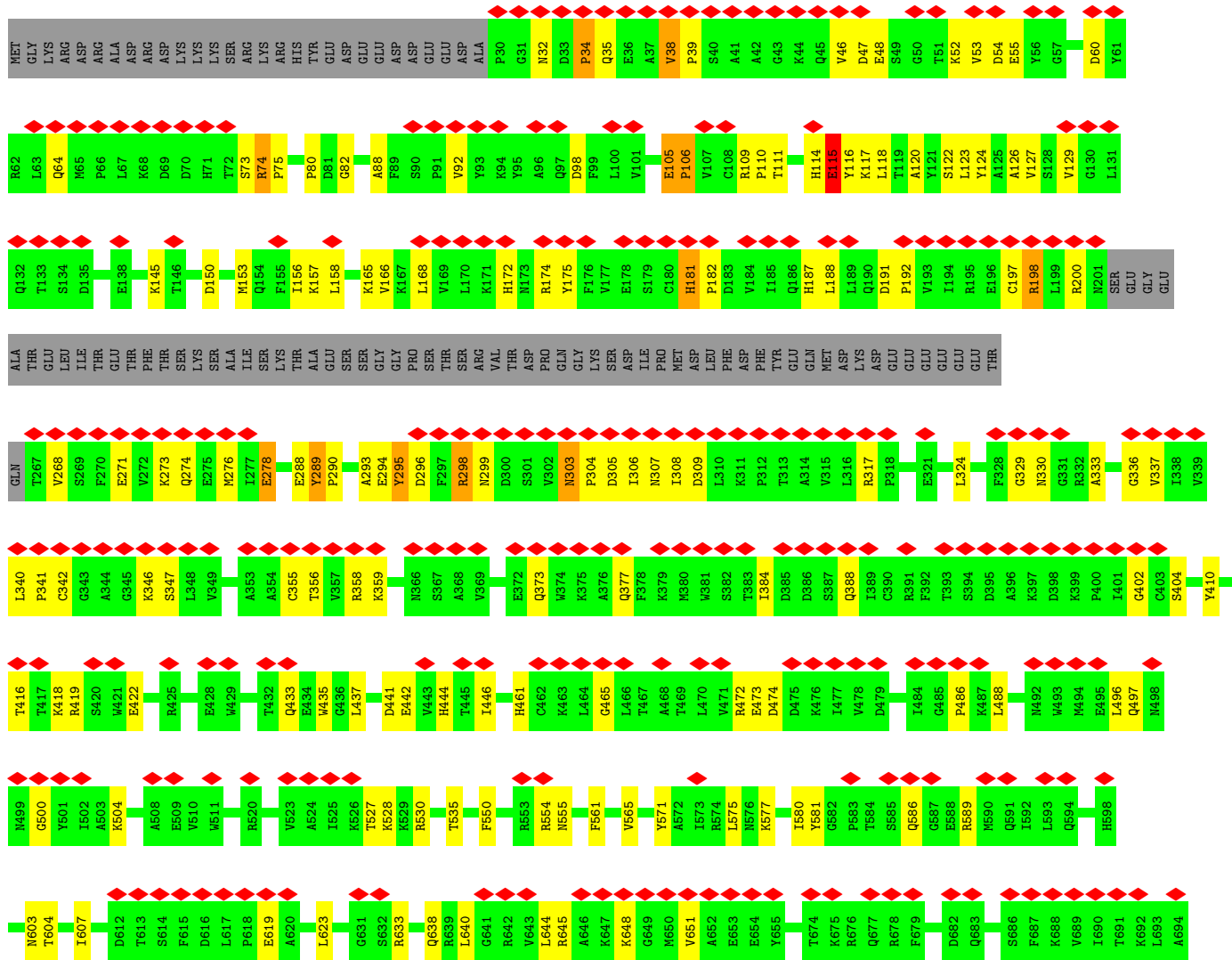

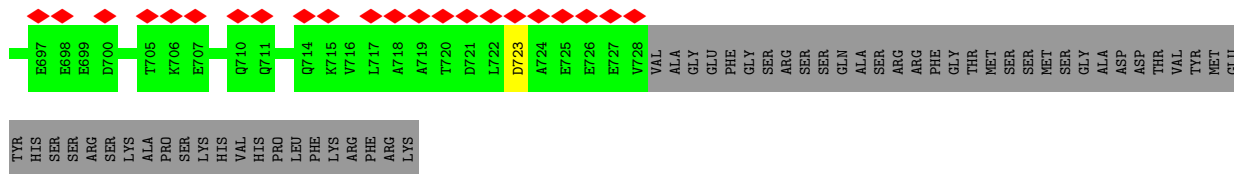

• Molecule 30: Cyclin-dependent kinase 7

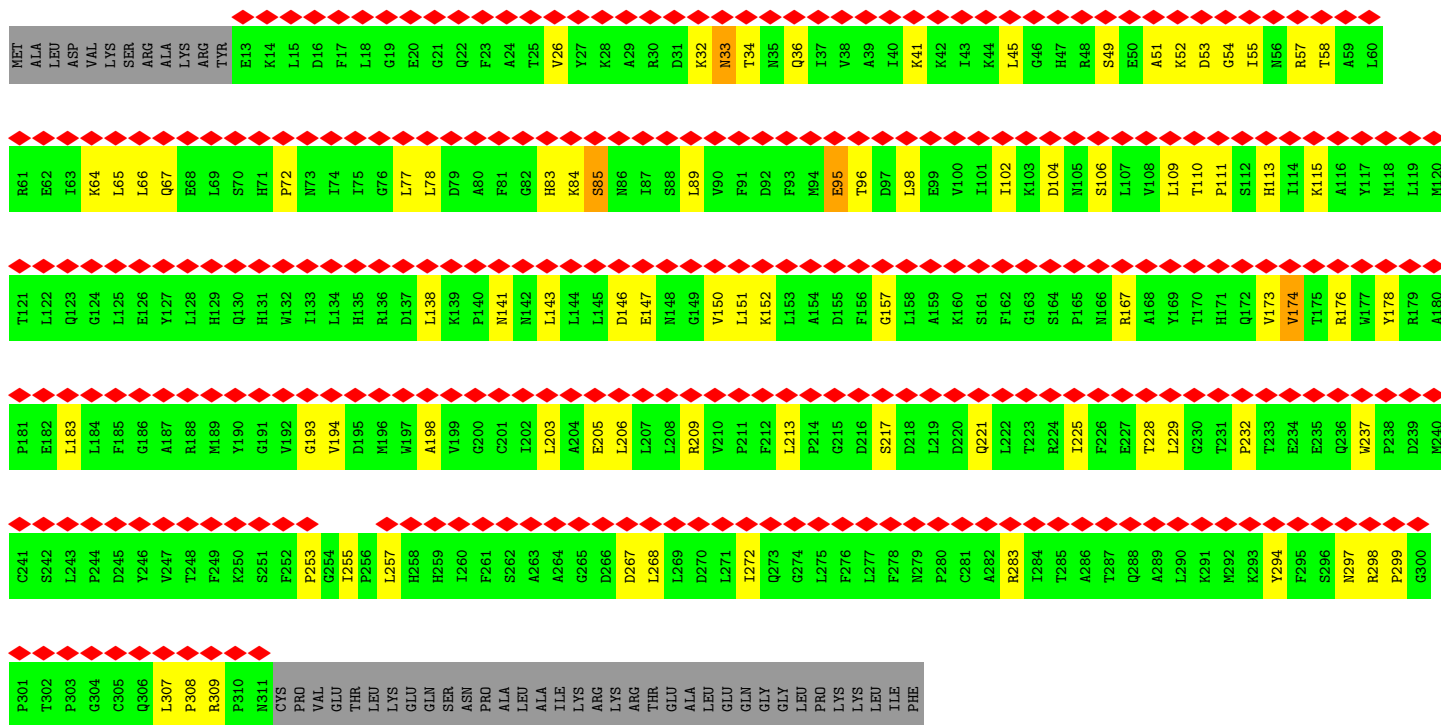
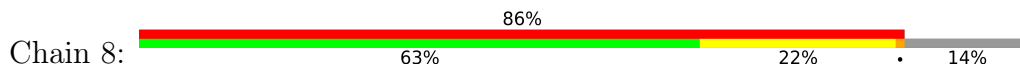

• Molecule 31: Cyclin-H

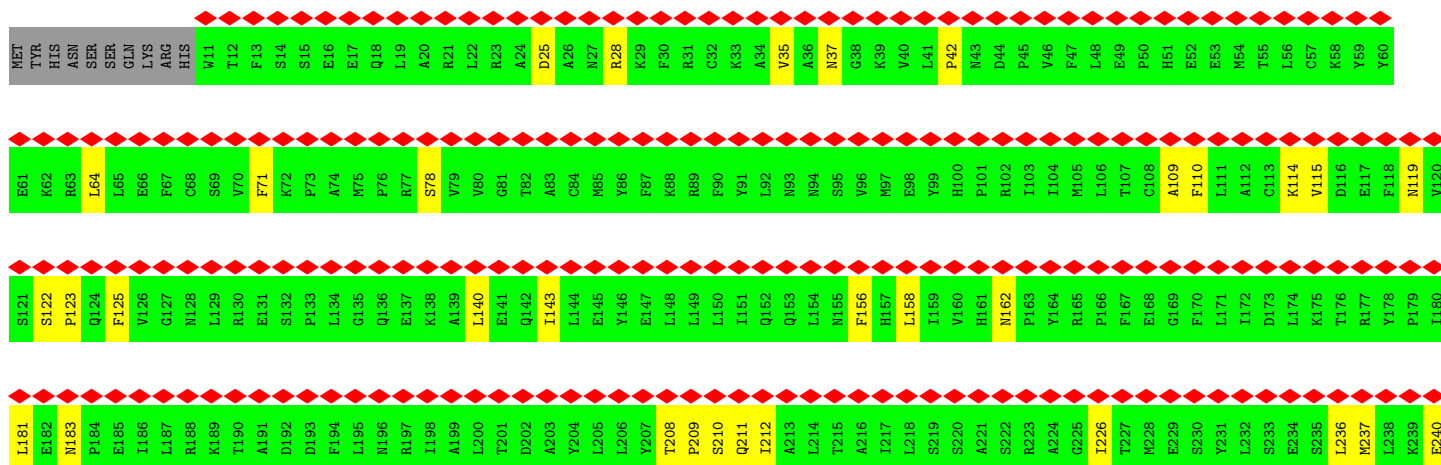
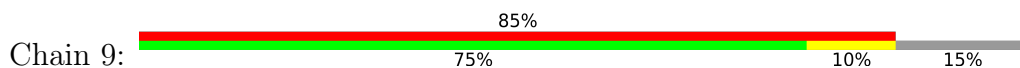

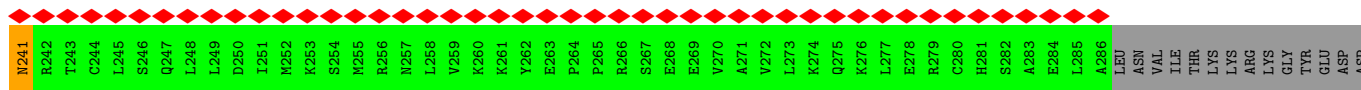

• Molecule 32: DNA (65-MER)

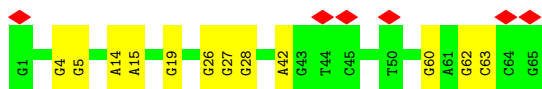
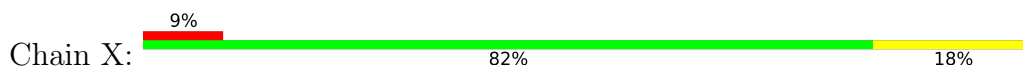

• Molecule 33: DNA (65-MER)

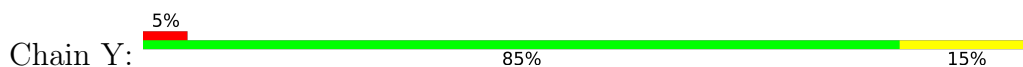

4 Experimental information

Property	Value	Source
EM reconstruction method	SINGLE PARTICLE	Depositor
Imposed symmetry	POINT, Not provided	
Number of particles used	24290	Depositor
Resolution determination method	Not provided	
CTF correction method	Not provided	
Microscope	FEI TITAN	Depositor
Voltage (kV)	300	Depositor
Electron dose ($e^-/\text{\AA}^2$)	46	Depositor
Minimum defocus (nm)	Not provided	
Maximum defocus (nm)	Not provided	
Magnification	Not provided	
Image detector	GATAN K2 SUMMIT (4k x 4k)	Depositor
Maximum map value	0.218	Depositor
Minimum map value	-0.111	Depositor
Average map value	0.001	Depositor
Map value standard deviation	0.007	Depositor
Recommended contour level	0.045	Depositor
Map size (\AA)	506.88, 506.88, 506.88	wwPDB
Map dimensions	192, 192, 192	wwPDB
Map angles ($^\circ$)	90.0, 90.0, 90.0	wwPDB
Pixel spacing (\AA)	2.64, 2.64, 2.64	Depositor

5 Model quality [i](#)

5.1 Standard geometry [i](#)

Bond lengths and bond angles in the following residue types are not validated in this section: ZN, SF4, MG

The Z score for a bond length (or angle) is the number of standard deviations the observed value is removed from the expected value. A bond length (or angle) with $|Z| > 5$ is considered an outlier worth inspection. RMSZ is the root-mean-square of all Z scores of the bond lengths (or angles).

Mol	Chain	Bond lengths		Bond angles	
		RMSZ	# $ Z > 5$	RMSZ	# $ Z > 5$
1	A	0.23	0/11908	0.39	0/16076
2	B	0.23	0/9503	0.40	0/12831
3	C	0.22	0/2259	0.39	0/3073
4	D	0.23	0/1077	0.35	0/1446
5	E	0.22	0/1753	0.38	0/2368
6	F	0.23	0/700	0.38	0/946
7	G	0.25	0/1382	0.41	0/1874
8	H	0.24	0/1227	0.41	0/1654
9	I	0.23	0/1038	0.40	0/1407
10	J	0.23	0/542	0.39	0/730
11	K	0.23	0/955	0.37	0/1292
12	L	0.22	0/394	0.42	0/524
13	M	0.23	0/2429	0.40	0/3281
14	N	0.22	0/945	0.38	0/1274
15	O	0.23	0/816	0.38	0/1105
16	P	0.24	0/1489	0.41	0/2005
17	Q	0.23	0/3459	0.40	0/4670
18	R	0.22	0/1400	0.36	0/1880
19	S	0.24	0/1496	0.43	0/2013
20	T	0.23	0/1926	0.38	0/2595
21	U	0.23	0/1358	0.43	0/1820
22	0	0.45	1/6022 (0.0%)	0.62	4/8155 (0.0%)
23	1	0.23	0/4422	0.39	0/5964
24	2	0.24	0/3697	0.39	0/5011
25	3	0.23	0/2557	0.39	0/3444
26	4	0.24	0/2354	0.40	0/3189
27	5	0.23	0/528	0.37	0/713
28	6	0.23	0/3094	0.39	0/4188
29	7	0.23	0/5202	0.40	0/7029
30	8	0.23	0/2437	0.38	0/3306
31	9	0.23	0/2288	0.37	0/3091
32	X	0.45	0/1510	0.78	0/2332

Mol	Chain	Bond lengths		Bond angles	
		RMSZ	# Z >5	RMSZ	# Z >5
33	Y	0.45	0/1472	0.82	0/2267
All	All	0.26	1/83639 (0.0%)	0.44	4/113553 (0.0%)

Chiral center outliers are detected by calculating the chiral volume of a chiral center and verifying if the center is modelled as a planar moiety or with the opposite hand. A planarity outlier is detected by checking planarity of atoms in a peptide group, atoms in a mainchain group or atoms of a sidechain that are expected to be planar.

Mol	Chain	#Chirality outliers	#Planarity outliers
22	0	0	1

All (1) bond length outliers are listed below:

Mol	Chain	Res	Type	Atoms	Z	Observed(Å)	Ideal(Å)
22	0	155	CYS	C-N	5.02	1.45	1.34

All (4) bond angle outliers are listed below:

Mol	Chain	Res	Type	Atoms	Z	Observed(°)	Ideal(°)
22	0	89	LYS	N-CA-C	6.49	128.53	111.00
22	0	91	LEU	N-CA-CB	5.46	121.32	110.40
22	0	388	ILE	N-CA-C	-5.19	97.00	111.00
22	0	192	TYR	CZ-CE2-CD2	-5.17	115.15	119.80

There are no chirality outliers.

All (1) planarity outliers are listed below:

Mol	Chain	Res	Type	Group
22	0	18	TYR	Peptide

5.2 Too-close contacts

In the following table, the Non-H and H(model) columns list the number of non-hydrogen atoms and hydrogen atoms in the chain respectively. The H(added) column lists the number of hydrogen atoms added and optimized by MolProbity. The Clashes column lists the number of clashes within the asymmetric unit, whereas Symm-Clashes lists symmetry-related clashes.

Mol	Chain	Non-H	H(model)	H(added)	Clashes	Symm-Clashes
1	A	11693	0	11776	179	0
2	B	9317	0	9311	156	0

Continued on next page...

Continued from previous page...

Mol	Chain	Non-H	H(model)	H(added)	Clashes	Symm-Clashes
3	C	2213	0	2155	24	0
4	D	1062	0	1042	11	0
5	E	1723	0	1745	24	0
6	F	689	0	715	12	0
7	G	1351	0	1358	19	0
8	H	1205	0	1168	21	0
9	I	1013	0	937	11	0
10	J	533	0	556	9	0
11	K	936	0	955	10	0
12	L	388	0	395	7	0
13	M	2391	0	2411	74	0
14	N	930	0	888	16	0
15	O	806	0	818	9	0
16	P	1462	0	1549	22	0
17	Q	3398	0	3264	37	0
18	R	1377	0	1402	12	0
19	S	1461	0	1429	50	0
20	T	1893	0	1928	22	0
21	U	1343	0	1339	14	0
22	0	5895	0	5921	278	0
23	1	4342	0	4346	107	0
24	2	3613	0	3657	59	0
25	3	2513	0	2518	37	0
26	4	2307	0	2334	38	0
27	5	522	0	528	3	0
28	6	3024	0	2994	71	0
29	7	5095	0	5127	80	0
30	8	2378	0	2397	51	0
31	9	2241	0	2279	22	0
32	X	1343	0	727	9	0
33	Y	1316	0	730	9	0
34	A	1	0	0	0	0
34	B	1	0	0	0	0
35	3	2	0	0	0	0
35	4	1	0	0	0	0
35	6	3	0	0	0	0
35	A	2	0	0	0	0
35	B	1	0	0	0	0
35	C	1	0	0	0	0
35	I	2	0	0	0	0
35	J	1	0	0	0	0
35	L	1	0	0	0	0

Continued on next page...

Continued from previous page...

Mol	Chain	Non-H	H(model)	H(added)	Clashes	Symm-Clashes
35	M	1	0	0	0	0
35	Q	1	0	0	0	0
35	U	1	0	0	0	0
36	0	8	0	0	0	0
All	All	81800	0	80699	1302	0

The all-atom clashscore is defined as the number of clashes found per 1000 atoms (including hydrogen atoms). The all-atom clashscore for this structure is 8.

The worst 5 of 1302 close contacts within the same asymmetric unit are listed below, sorted by their clash magnitude.

Atom-1	Atom-2	Interatomic distance (Å)	Clash overlap (Å)
22:0:59:TYR:CE2	22:0:68:THR:HG23	1.20	1.66
22:0:59:TYR:CE2	22:0:68:THR:CG2	1.76	1.60
22:0:77:VAL:CG1	23:1:268:ASP:HB2	1.34	1.51
23:1:223:ARG:HD3	23:1:237:THR:CG2	1.46	1.42
22:0:113:LYS:HD3	23:1:271:ALA:CB	1.47	1.42

There are no symmetry-related clashes.

5.3 Torsion angles [i](#)

5.3.1 Protein backbone [i](#)

In the following table, the Percentiles column shows the percent Ramachandran outliers of the chain as a percentile score with respect to all PDB entries followed by that with respect to all EM entries.

The Analysed column shows the number of residues for which the backbone conformation was analysed, and the total number of residues.

Mol	Chain	Analysed	Favoured	Allowed	Outliers	Percentiles	
1	A	1474/1970 (75%)	1256 (85%)	180 (12%)	38 (3%)	5	31
2	B	1163/1174 (99%)	1003 (86%)	140 (12%)	20 (2%)	9	42
3	C	273/275 (99%)	222 (81%)	40 (15%)	11 (4%)	3	23
4	D	127/142 (89%)	114 (90%)	12 (9%)	1 (1%)	19	60
5	E	208/210 (99%)	184 (88%)	19 (9%)	5 (2%)	6	33
6	F	84/127 (66%)	77 (92%)	6 (7%)	1 (1%)	13	50

Continued on next page...

Continued from previous page...

Mol	Chain	Analysed	Favoured	Allowed	Outliers	Percentiles	
7	G	169/172 (98%)	153 (90%)	14 (8%)	2 (1%)	13	50
8	H	148/150 (99%)	107 (72%)	36 (24%)	5 (3%)	3	26
9	I	123/125 (98%)	93 (76%)	27 (22%)	3 (2%)	6	33
10	J	65/67 (97%)	54 (83%)	8 (12%)	3 (5%)	2	21
11	K	115/117 (98%)	106 (92%)	8 (7%)	1 (1%)	17	57
12	L	44/58 (76%)	32 (73%)	11 (25%)	1 (2%)	6	34
13	M	308/316 (98%)	252 (82%)	45 (15%)	11 (4%)	3	25
14	N	109/376 (29%)	96 (88%)	12 (11%)	1 (1%)	17	57
15	O	97/109 (89%)	90 (93%)	7 (7%)	0	100	100
16	P	183/339 (54%)	159 (87%)	21 (12%)	3 (2%)	9	44
17	Q	428/439 (98%)	321 (75%)	84 (20%)	23 (5%)	2	19
18	R	166/291 (57%)	148 (89%)	16 (10%)	2 (1%)	13	50
19	S	174/517 (34%)	138 (79%)	26 (15%)	10 (6%)	1	18
20	T	235/249 (94%)	198 (84%)	30 (13%)	7 (3%)	4	28
21	U	168/301 (56%)	135 (80%)	24 (14%)	9 (5%)	2	19
22	0	730/760 (96%)	610 (84%)	95 (13%)	25 (3%)	3	26
23	1	544/548 (99%)	470 (86%)	57 (10%)	17 (3%)	4	27
24	2	451/462 (98%)	370 (82%)	66 (15%)	15 (3%)	4	26
25	3	307/309 (99%)	245 (80%)	50 (16%)	12 (4%)	3	23
26	4	293/308 (95%)	250 (85%)	33 (11%)	10 (3%)	3	26
27	5	64/71 (90%)	61 (95%)	3 (5%)	0	100	100
28	6	383/395 (97%)	321 (84%)	51 (13%)	11 (3%)	4	29
29	7	630/782 (81%)	472 (75%)	124 (20%)	34 (5%)	2	19
30	8	297/346 (86%)	249 (84%)	40 (14%)	8 (3%)	5	31
31	9	274/323 (85%)	247 (90%)	26 (10%)	1 (0%)	34	72
All	All	9834/11828 (83%)	8233 (84%)	1311 (13%)	290 (3%)	7	29

5 of 290 Ramachandran outliers are listed below:

Mol	Chain	Res	Type
1	A	531	ASN
1	A	935	GLN
1	A	1130	ILE

Continued on next page...

Continued from previous page...

Mol	Chain	Res	Type
2	B	841	ARG
7	G	154	LYS

5.3.2 Protein sidechains [i](#)

In the following table, the Percentiles column shows the percent sidechain outliers of the chain as a percentile score with respect to all PDB entries followed by that with respect to all EM entries.

The Analysed column shows the number of residues for which the sidechain conformation was analysed, and the total number of residues.

Mol	Chain	Analysed	Rotameric	Outliers	Percentiles
1	A	1299/1748 (74%)	1293 (100%)	6 (0%)	88 93
2	B	1020/1028 (99%)	1017 (100%)	3 (0%)	92 95
3	C	252/252 (100%)	249 (99%)	3 (1%)	71 83
4	D	119/126 (94%)	119 (100%)	0	100 100
5	E	192/192 (100%)	192 (100%)	0	100 100
6	F	74/111 (67%)	74 (100%)	0	100 100
7	G	152/153 (99%)	151 (99%)	1 (1%)	84 90
8	H	131/131 (100%)	130 (99%)	1 (1%)	81 89
9	I	112/112 (100%)	112 (100%)	0	100 100
10	J	56/56 (100%)	56 (100%)	0	100 100
11	K	106/106 (100%)	106 (100%)	0	100 100
12	L	43/55 (78%)	43 (100%)	0	100 100
13	M	263/268 (98%)	259 (98%)	4 (2%)	65 80
14	N	105/324 (32%)	105 (100%)	0	100 100
15	O	90/98 (92%)	89 (99%)	1 (1%)	73 84
16	P	159/293 (54%)	159 (100%)	0	100 100
17	Q	365/373 (98%)	360 (99%)	5 (1%)	67 80
18	R	151/261 (58%)	151 (100%)	0	100 100
19	S	154/448 (34%)	150 (97%)	4 (3%)	46 66
20	T	207/218 (95%)	205 (99%)	2 (1%)	76 86
21	U	148/266 (56%)	146 (99%)	2 (1%)	67 80
22	0	638/664 (96%)	627 (98%)	11 (2%)	60 78

Continued on next page...

Continued from previous page...

Mol	Chain	Analysed	Rotameric	Outliers	Percentiles	
23	1	482/484 (100%)	475 (98%)	7 (2%)	65	80
24	2	390/399 (98%)	386 (99%)	4 (1%)	76	86
25	3	283/283 (100%)	280 (99%)	3 (1%)	73	84
26	4	260/272 (96%)	259 (100%)	1 (0%)	91	94
27	5	59/64 (92%)	59 (100%)	0	100	100
28	6	342/352 (97%)	340 (99%)	2 (1%)	86	92
29	7	558/688 (81%)	550 (99%)	8 (1%)	67	80
30	8	259/299 (87%)	259 (100%)	0	100	100
31	9	250/296 (84%)	247 (99%)	3 (1%)	71	83
All	All	8719/10420 (84%)	8648 (99%)	71 (1%)	82	89

5 of 71 residues with a non-rotameric sidechain are listed below:

Mol	Chain	Res	Type
26	4	74	LYS
28	6	159	MET
29	7	299	ASN
19	S	82	LYS
17	Q	277	ARG

Sometimes sidechains can be flipped to improve hydrogen bonding and reduce clashes. 5 of 80 such sidechains are listed below:

Mol	Chain	Res	Type
24	2	15	GLN
29	7	551	HIS
25	3	232	HIS
28	6	365	ASN
30	8	221	GLN

5.3.3 RNA [i](#)

There are no RNA molecules in this entry.

5.4 Non-standard residues in protein, DNA, RNA chains [i](#)

There are no non-standard protein/DNA/RNA residues in this entry.

5.5 Carbohydrates [i](#)

There are no monosaccharides in this entry.

5.6 Ligand geometry [i](#)

Of 20 ligands modelled in this entry, 19 are monoatomic - leaving 1 for Mogul analysis.

In the following table, the Counts columns list the number of bonds (or angles) for which Mogul statistics could be retrieved, the number of bonds (or angles) that are observed in the model and the number of bonds (or angles) that are defined in the Chemical Component Dictionary. The Link column lists molecule types, if any, to which the group is linked. The Z score for a bond length (or angle) is the number of standard deviations the observed value is removed from the expected value. A bond length (or angle) with $|Z| > 2$ is considered an outlier worth inspection. RMSZ is the root-mean-square of all Z scores of the bond lengths (or angles).

Mol	Type	Chain	Res	Link	Bond lengths			Bond angles		
					Counts	RMSZ	# Z > 2	Counts	RMSZ	# Z > 2
36	SF4	0	1000	22	0,12,12	-	-	-		

In the following table, the Chirals column lists the number of chiral outliers, the number of chiral centers analysed, the number of these observed in the model and the number defined in the Chemical Component Dictionary. Similar counts are reported in the Torsion and Rings columns. '-' means no outliers of that kind were identified.

Mol	Type	Chain	Res	Link	Chirals	Torsions	Rings
36	SF4	0	1000	22	-	-	0/6/5/5

There are no bond length outliers.

There are no bond angle outliers.

There are no chirality outliers.

There are no torsion outliers.

There are no ring outliers.

No monomer is involved in short contacts.

5.7 Other polymers [i](#)

There are no such residues in this entry.

5.8 Polymer linkage issues

There are no chain breaks in this entry.

6 Map visualisation [i](#)

This section contains visualisations of the EMDB entry EMD-3307. These allow visual inspection of the internal detail of the map and identification of artifacts.

No raw map or half-maps were deposited for this entry and therefore no images, graphs, etc. pertaining to the raw map can be shown.

6.1 Orthogonal projections [i](#)

6.1.1 Primary map

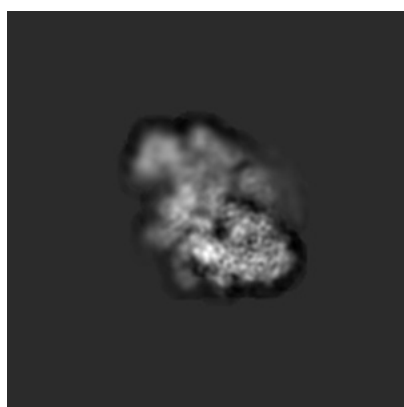

X

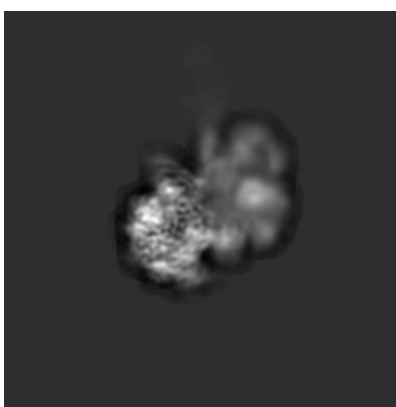

Y

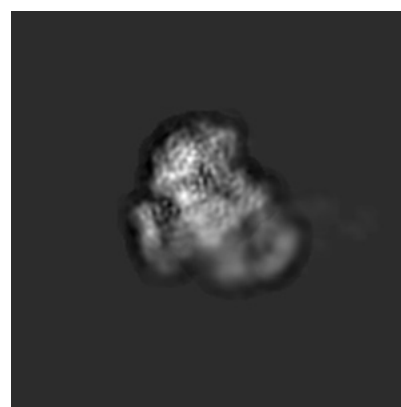

Z

The images above show the map projected in three orthogonal directions.

6.2 Central slices [i](#)

6.2.1 Primary map

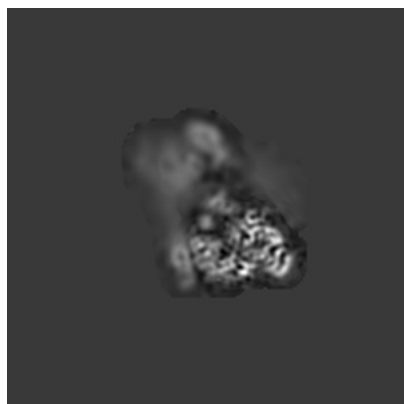

X Index: 96



Y Index: 96

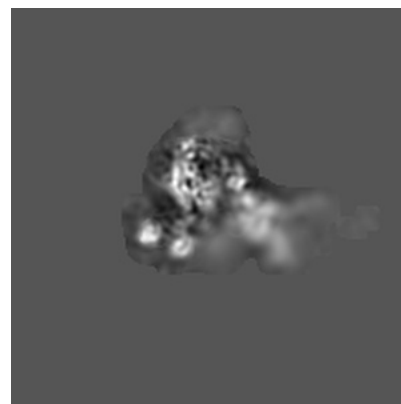

Z Index: 96

The images above show central slices of the map in three orthogonal directions.

6.3 Largest variance slices [i](#)

6.3.1 Primary map

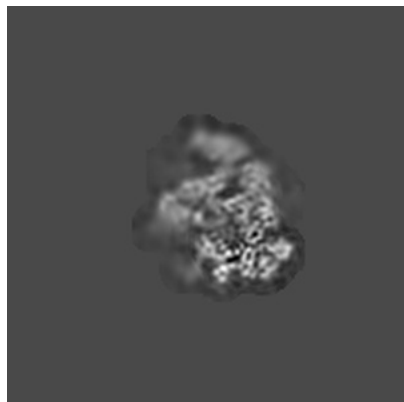

X Index: 83

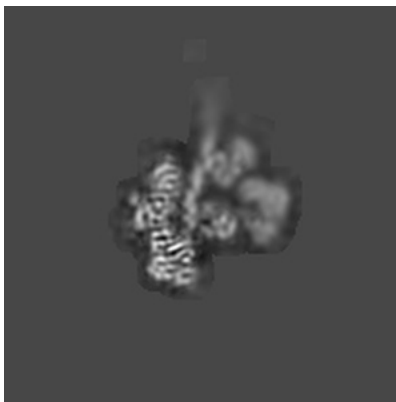

Y Index: 96

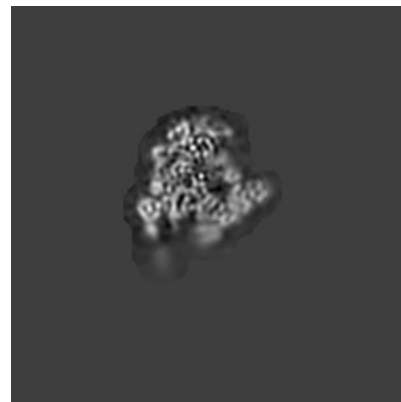

Z Index: 75

The images above show the largest variance slices of the map in three orthogonal directions.

6.4 Orthogonal standard-deviation projections (False-color) [i](#)

6.4.1 Primary map



X



Y

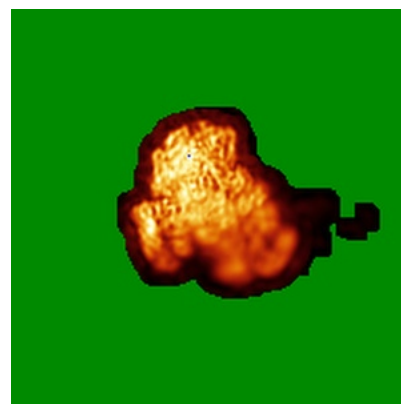

Z

The images above show the map standard deviation projections with false color in three orthogonal directions. Minimum values are shown in green, max in blue, and dark to light orange shades represent small to large values respectively.

6.5 Orthogonal surface views [i](#)

6.5.1 Primary map

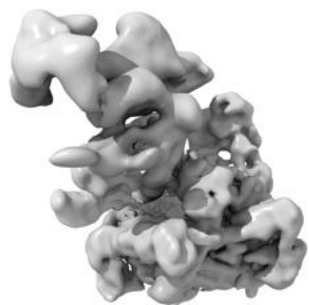

X

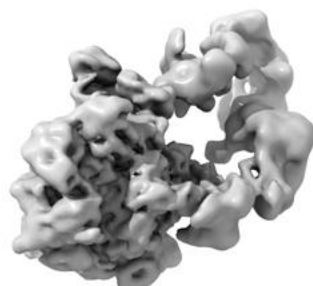

Y

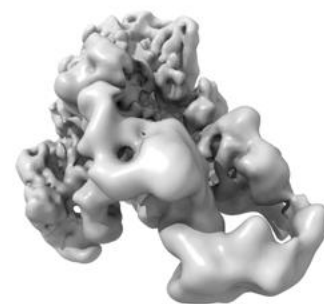

Z

The images above show the 3D surface view of the map at the recommended contour level 0.045. These images, in conjunction with the slice images, may facilitate assessment of whether an appropriate contour level has been provided.

6.6 Mask visualisation [i](#)

This section was not generated. No masks/segmentation were deposited.

7 Map analysis [i](#)

This section contains the results of statistical analysis of the map.

7.1 Map-value distribution [i](#)

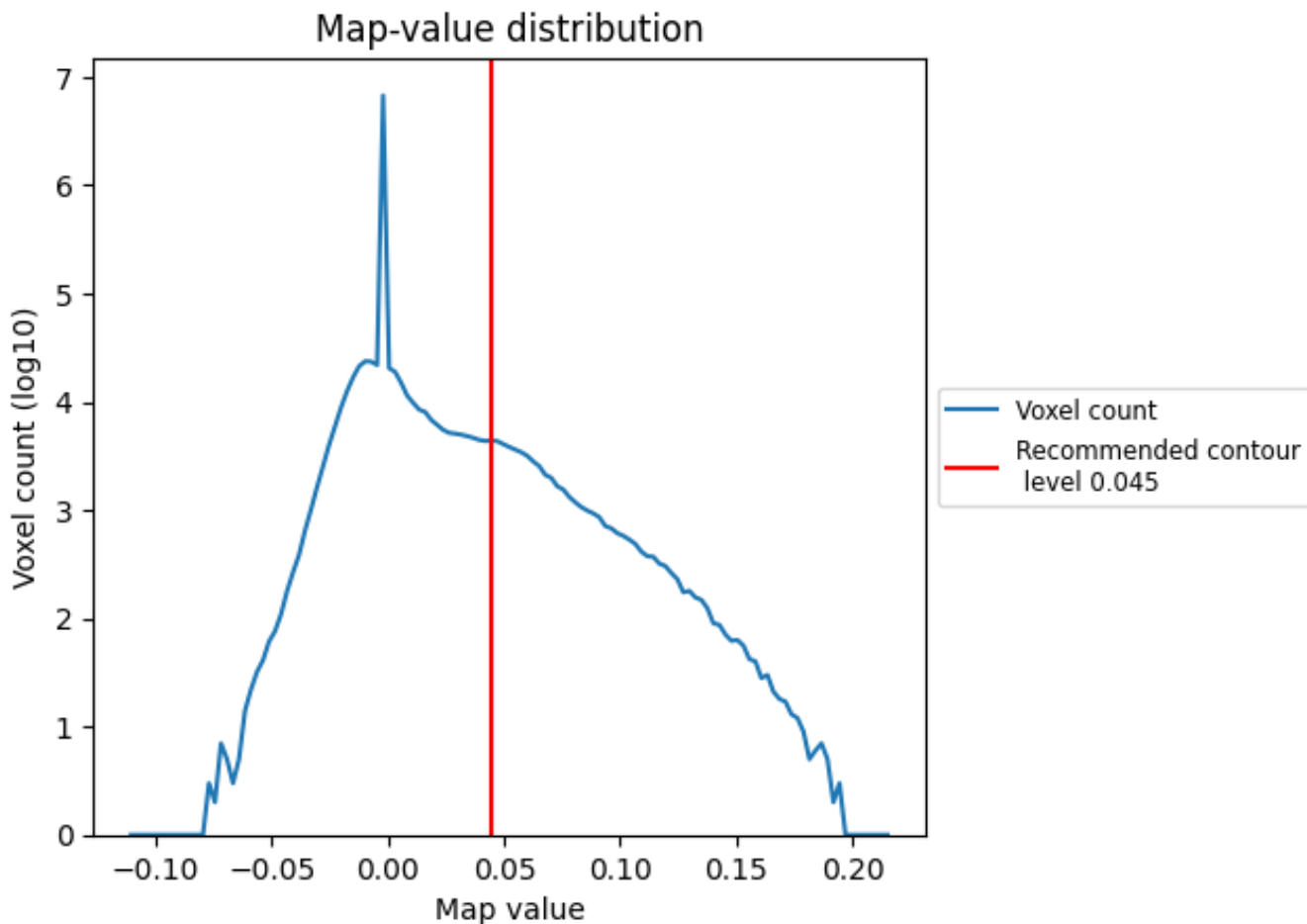

The map-value distribution is plotted in 128 intervals along the x-axis. The y-axis is logarithmic. A spike in this graph at zero usually indicates that the volume has been masked.

7.2 Volume estimate [\(i\)](#)

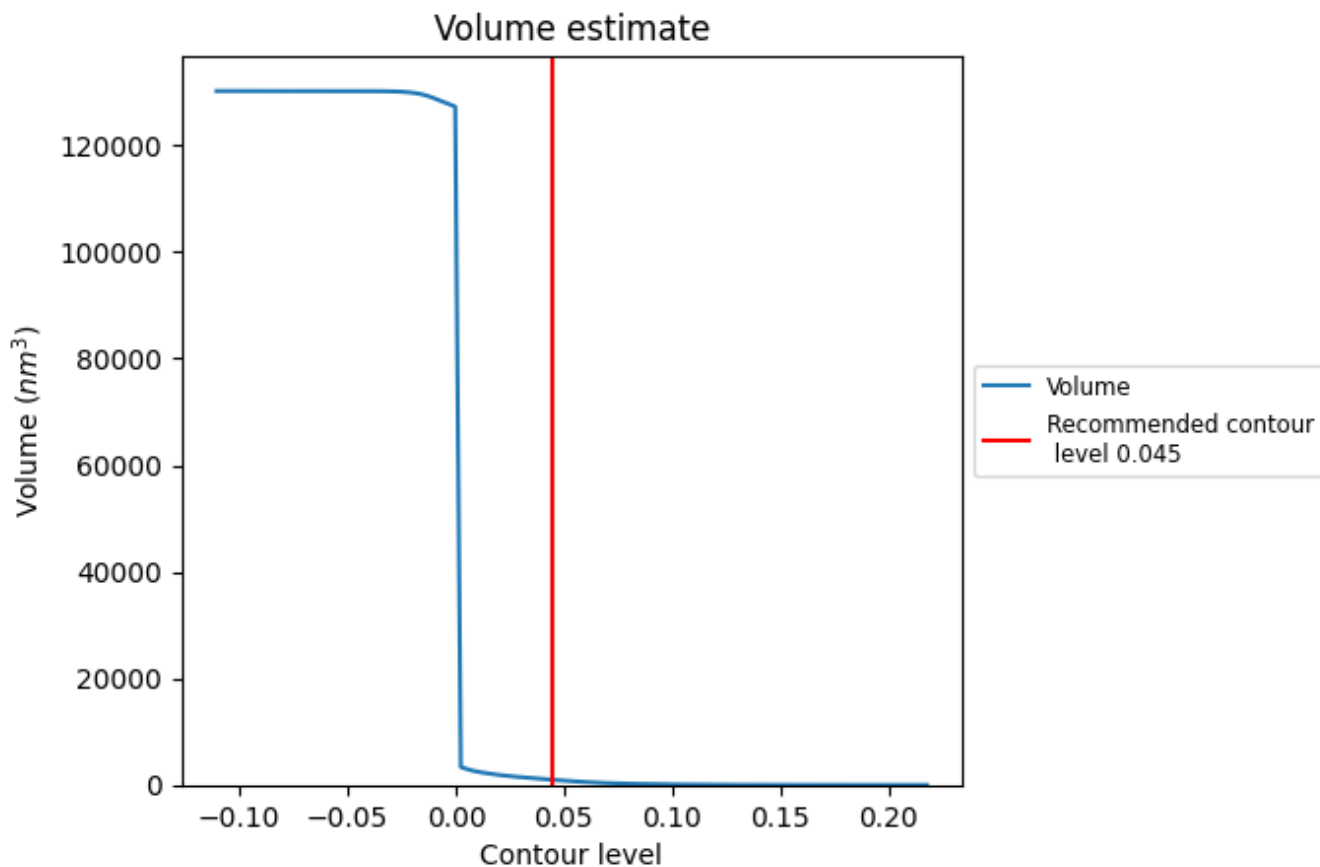

The volume at the recommended contour level is 965 nm³; this corresponds to an approximate mass of 872 kDa.

The volume estimate graph shows how the enclosed volume varies with the contour level. The recommended contour level is shown as a vertical line and the intersection between the line and the curve gives the volume of the enclosed surface at the given level.

7.3 Rotationally averaged power spectrum [i](#)

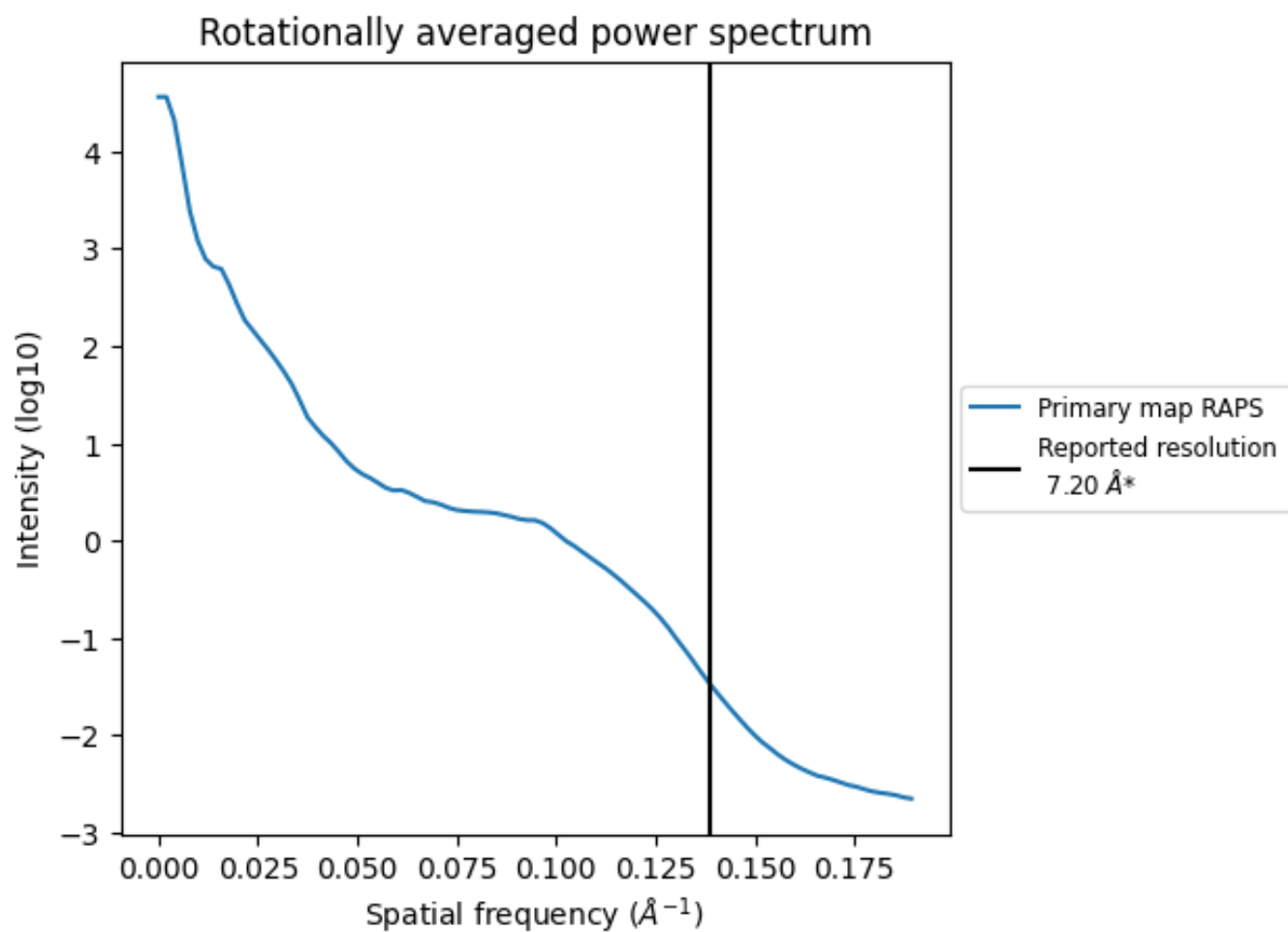

*Reported resolution corresponds to spatial frequency of 0.139 Å⁻¹

8 Fourier-Shell correlation [i](#)

Fourier-Shell Correlation (FSC) is the most commonly used method to estimate the resolution of single-particle and subtomogram-averaged maps. The shape of the curve depends on the imposed symmetry, mask and whether or not the two 3D reconstructions used were processed from a common reference. The reported resolution is shown as a black line. A curve is displayed for the half-bit criterion in addition to lines showing the 0.143 gold standard cut-off and 0.5 cut-off.

8.1 FSC [i](#)

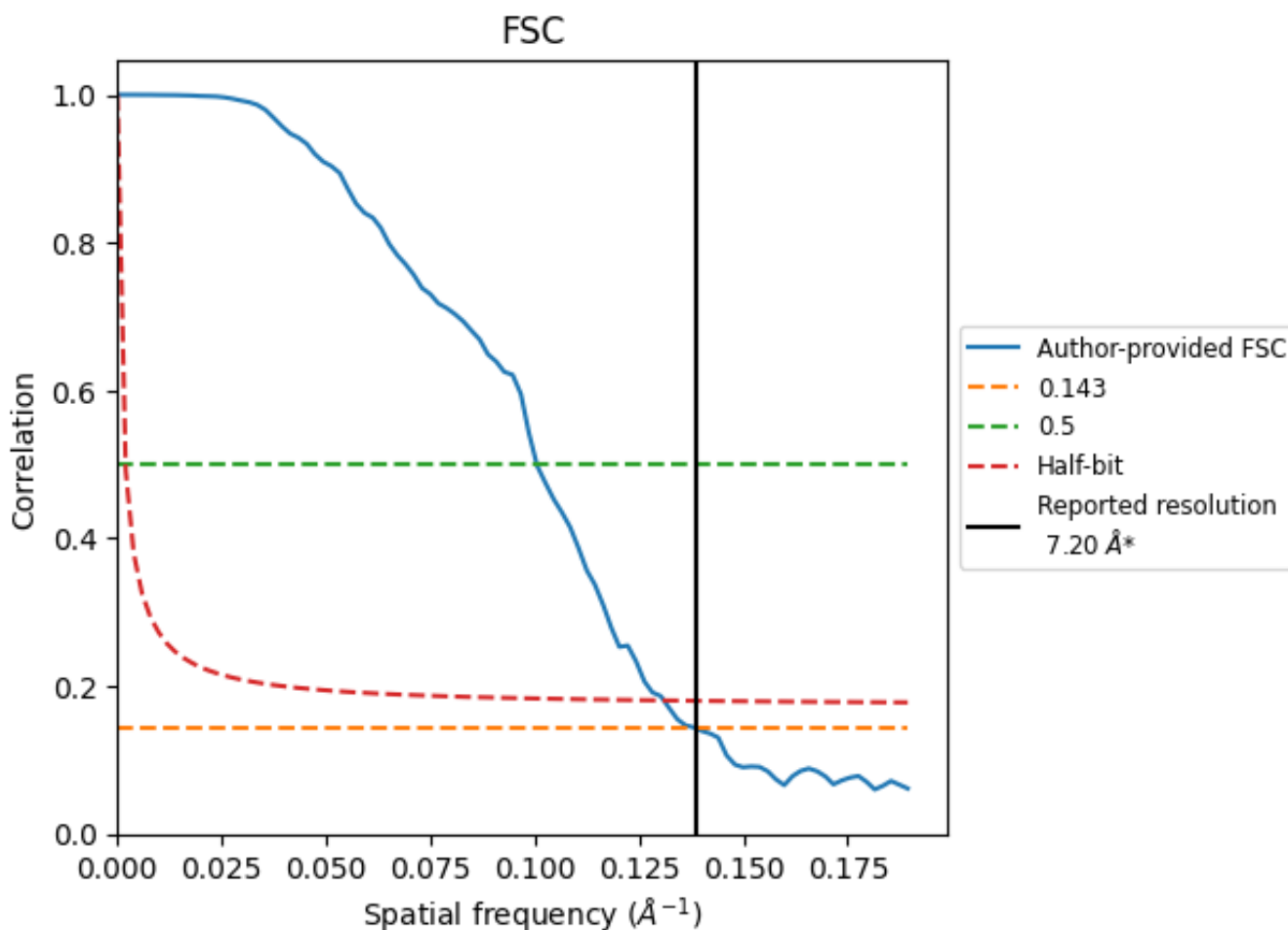

*Reported resolution corresponds to spatial frequency of 0.139 Å⁻¹

8.2 Resolution estimates [i](#)

Resolution estimate (Å)	Estimation criterion (FSC cut-off)		
	0.143	0.5	Half-bit
Reported by author	-	-	-
Author-provided FSC curve	7.23	9.95	7.64
Unmasked-calculated*	-	-	-

*Resolution estimate based on FSC curve calculated by comparison of deposited half-maps.

9 Map-model fit [i](#)

This section contains information regarding the fit between EMDB map EMD-3307 and PDB model 6O9L. Per-residue inclusion information can be found in section 3 on page 11.

9.1 Map-model overlay [i](#)

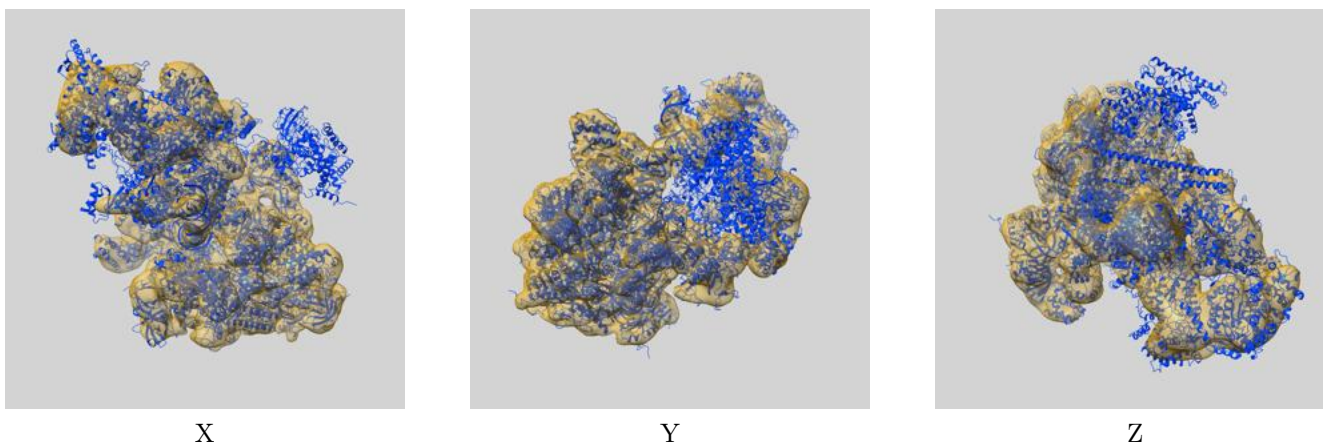

The images above show the 3D surface view of the map at the recommended contour level 0.045 at 50% transparency in yellow overlaid with a ribbon representation of the model coloured in blue. These images allow for the visual assessment of the quality of fit between the atomic model and the map.

9.2 Q-score mapped to coordinate model [i](#)

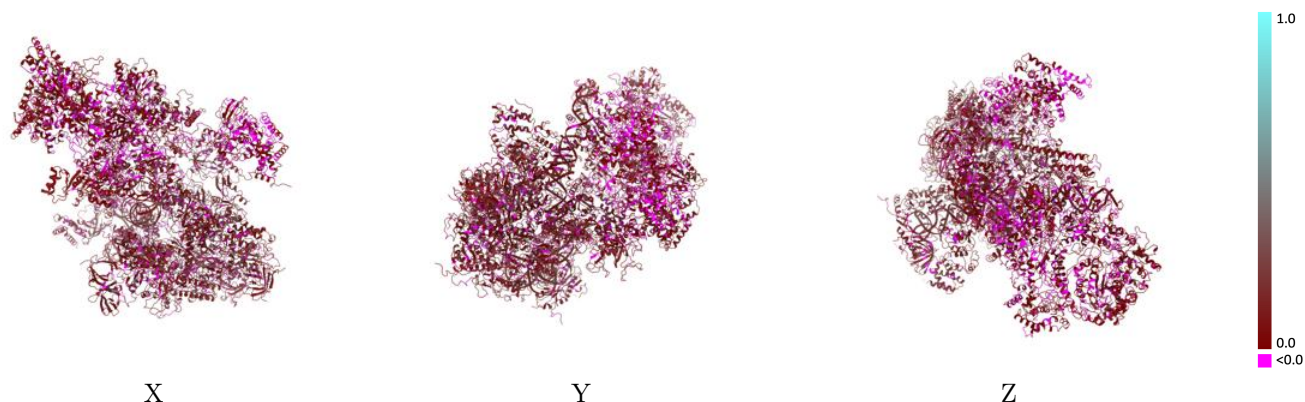

The images above show the model with each residue coloured according to its Q-score. This shows their resolvability in the map with higher Q-score values reflecting better resolvability. Please note: Q-score is calculating the resolvability of atoms, and thus high values are only expected at resolutions at which atoms can be resolved. Low Q-score values may therefore be expected for many entries.

9.3 Atom inclusion mapped to coordinate model [i](#)

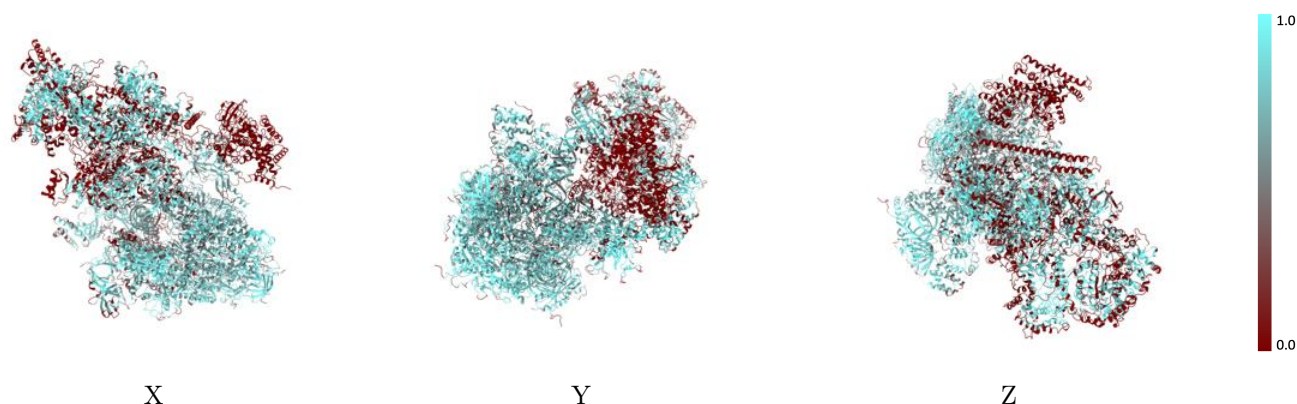

The images above show the model with each residue coloured according to its atom inclusion. This shows to what extent they are inside the map at the recommended contour level (0.045).



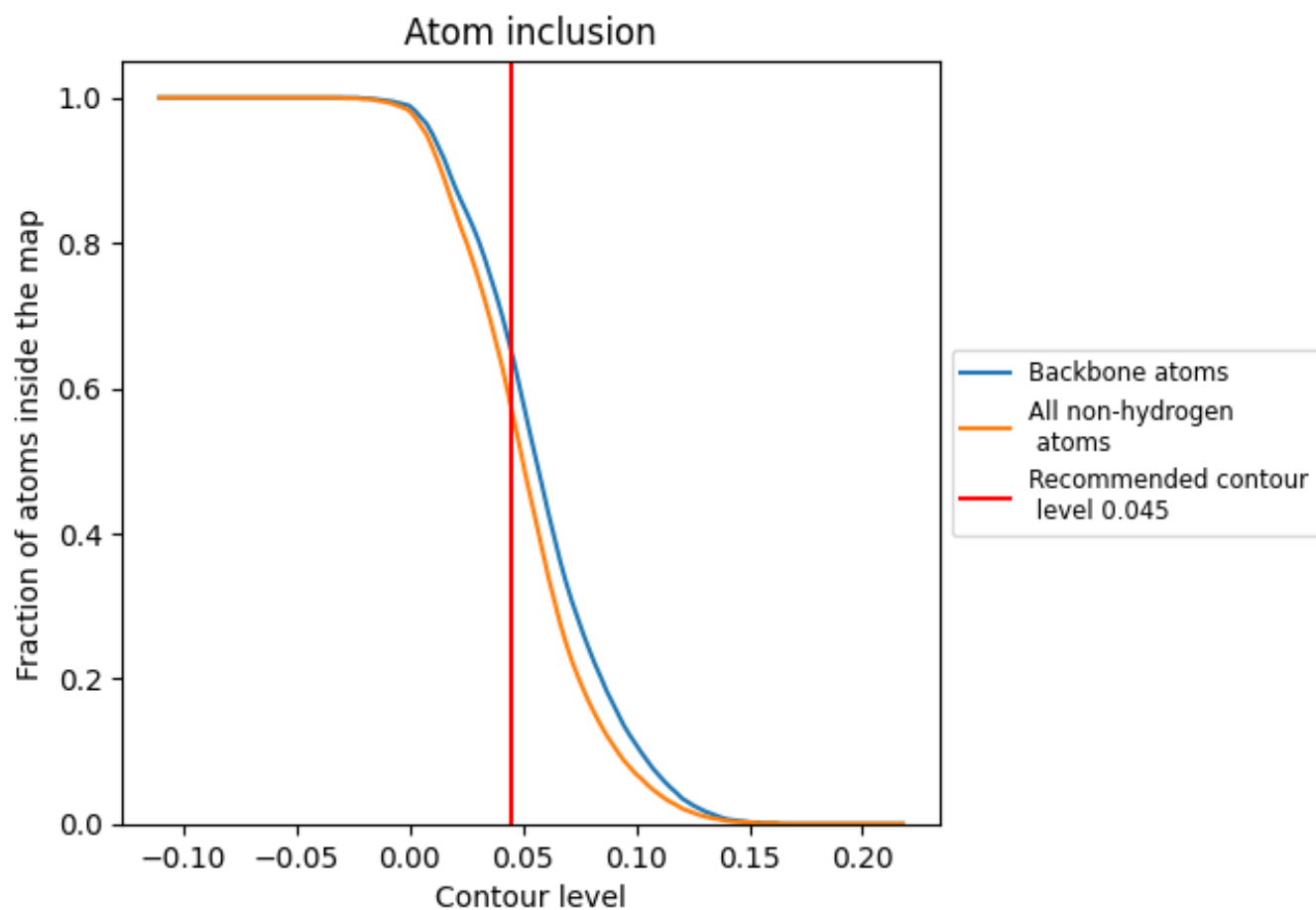

































































9.4 Atom inclusion [i](#)



At the recommended contour level, 65% of all backbone atoms, 57% of all non-hydrogen atoms, are inside the map.

9.5 Map-model fit summary

The table lists the average atom inclusion at the recommended contour level (0.045) and Q-score for the entire model and for each chain.

Chain	Atom inclusion	Q-score
All	 0.5710	 0.0860
0	 0.6280	 0.0630
1	 0.2340	 0.0320
2	 0.4390	 0.0610
3	 0.1870	 0.0530
4	 0.5390	 0.0560
5	 0.2470	 0.0480
6	 0.6480	 0.0500
7	 0.5080	 0.0540
8	 0.0060	 0.0220
9	 0.0000	 0.0200
A	 0.6700	 0.1180
B	 0.7070	 0.1170
C	 0.8330	 0.1230
D	 0.7080	 0.0990
E	 0.7460	 0.1290
F	 0.7140	 0.1150
G	 0.7890	 0.1010
H	 0.8020	 0.1240
I	 0.7570	 0.1070
J	 0.8120	 0.1160
K	 0.8270	 0.1510
L	 0.8360	 0.1440
M	 0.6330	 0.1020
N	 0.7420	 0.0970
O	 0.7940	 0.1030
P	 0.8560	 0.1030
Q	 0.3210	 0.0560
R	 0.6960	 0.0960
S	 0.4760	 0.0690
T	 0.6340	 0.1010
U	 0.6190	 0.1070
X	 0.7490	 0.1370
Y	 0.7790	 0.1420

