



Full wwPDB X-ray Structure Validation Report ⓘ

Dec 21, 2021 – 12:11 pm GMT

PDB ID : 7NGE
Title : Crystal structure of L-Trp/Indoleamine 2,3-dioxygenase 1 (hIDO1) complex with the JK-loop refined in the closed conformation
Authors : Mirgaux, M.; Wouters, J.
Deposited on : 2021-02-09
Resolution : 2.30 Å(reported)

This is a Full wwPDB X-ray Structure Validation Report for a publicly released PDB entry.

We welcome your comments at validation@mail.wwpdb.org

A user guide is available at

<https://www.wwpdb.org/validation/2017/XrayValidationReportHelp>

with specific help available everywhere you see the ⓘ symbol.

The following versions of software and data (see [references ⓘ](#)) were used in the production of this report:

MolProbity : 4.02b-467
Mogul : 1.8.4, CSD as541be (2020)
Xtriage (Phenix) : 1.13
EDS : 2.24
buster-report : 1.1.7 (2018)
Percentile statistics : 20191225.v01 (using entries in the PDB archive December 25th 2019)
Refmac : 5.8.0267
CCP4 : 7.1.010 (Gargrove)
Ideal geometry (proteins) : Engh & Huber (2001)
Ideal geometry (DNA, RNA) : Parkinson et al. (1996)
Validation Pipeline (wwPDB-VP) : 2.24

1 Overall quality at a glance

The following experimental techniques were used to determine the structure:

X-RAY DIFFRACTION

The reported resolution of this entry is 2.30 Å.

Percentile scores (ranging between 0-100) for global validation metrics of the entry are shown in the following graphic. The table shows the number of entries on which the scores are based.

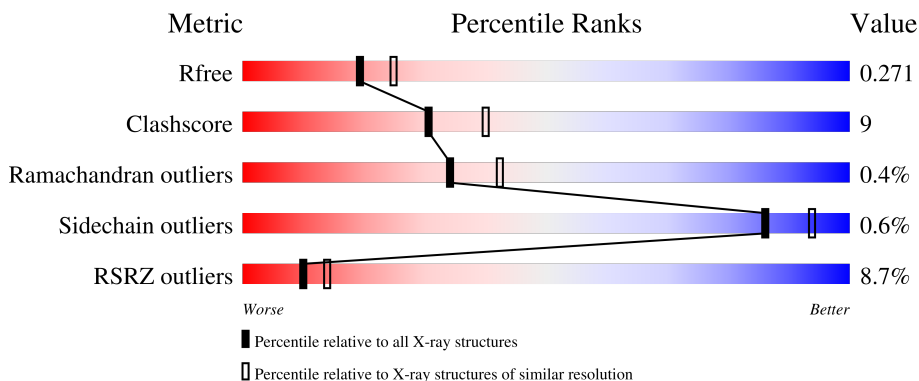

Metric	Whole archive (#Entries)	Similar resolution (#Entries, resolution range(Å))
R_{free}	130704	5042 (2.30-2.30)
Clashscore	141614	5643 (2.30-2.30)
Ramachandran outliers	138981	5575 (2.30-2.30)
Sidechain outliers	138945	5575 (2.30-2.30)
RSRZ outliers	127900	4938 (2.30-2.30)

The table below summarises the geometric issues observed across the polymeric chains and their fit to the electron density. The red, orange, yellow and green segments of the lower bar indicate the fraction of residues that contain outliers for ≥ 3 , 2, 1 and 0 types of geometric quality criteria respectively. A grey segment represents the fraction of residues that are not modelled. The numeric value for each fraction is indicated below the corresponding segment, with a dot representing fractions $\leq 5\%$. The upper red bar (where present) indicates the fraction of residues that have poor fit to the electron density. The numeric value is given above the bar.

Mol	Chain	Length	Quality of chain
1	A	405	
1	B	405	
1	C	405	
1	D	405	

The following table lists non-polymeric compounds, carbohydrate monomers and non-standard

residues in protein, DNA, RNA chains that are outliers for geometric or electron-density-fit criteria:

Mol	Type	Chain	Res	Chirality	Geometry	Clashes	Electron density
2	TRP	A	501	-	-	X	-
4	GOL	B	503	-	-	X	-

2 Entry composition [i](#)

There are 9 unique types of molecules in this entry. The entry contains 12992 atoms, of which 0 are hydrogens and 0 are deuteriums.

In the tables below, the ZeroOcc column contains the number of atoms modelled with zero occupancy, the AltConf column contains the number of residues with at least one atom in alternate conformation and the Trace column contains the number of residues modelled with at most 2 atoms.

- Molecule 1 is a protein called Indoleamine 2,3-dioxygenase 1.

Mol	Chain	Residues	Atoms					ZeroOcc	AltConf	Trace
			Total	C	N	O	S			
1	A	386	Total 3055	C 1959	N 521	O 558	S 17	13	2	0
1	B	368	Total 2907	C 1868	N 497	O 525	S 17	0	0	0
1	C	377	Total 2969	C 1905	N 507	O 540	S 17	0	0	0
1	D	368	Total 2912	C 1873	N 496	O 526	S 17	0	0	0

There are 72 discrepancies between the modelled and reference sequences:

Chain	Residue	Modelled	Actual	Comment	Reference
A	-1	MET	-	initiating methionine	UNP P14902
A	0	GLY	-	expression tag	UNP P14902
A	1	SER	-	expression tag	UNP P14902
A	2	SER	-	expression tag	UNP P14902
A	3	HIS	-	expression tag	UNP P14902
A	4	HIS	-	expression tag	UNP P14902
A	5	HIS	-	expression tag	UNP P14902
A	6	HIS	-	expression tag	UNP P14902
A	7	HIS	-	expression tag	UNP P14902
A	8	HIS	-	expression tag	UNP P14902
A	9	SER	-	expression tag	UNP P14902
A	10	SER	-	expression tag	UNP P14902
A	11	GLY	-	expression tag	UNP P14902
A	12	SER	-	expression tag	UNP P14902
A	13	ALA	-	expression tag	UNP P14902
A	14	ALA	-	expression tag	UNP P14902
A	116	ALA	LYS	engineered mutation	UNP P14902
A	117	ALA	LYS	engineered mutation	UNP P14902
B	-1	MET	-	initiating methionine	UNP P14902
B	0	GLY	-	expression tag	UNP P14902
B	1	SER	-	expression tag	UNP P14902

Continued on next page...

Continued from previous page...

Chain	Residue	Modelled	Actual	Comment	Reference
B	2	SER	-	expression tag	UNP P14902
B	3	HIS	-	expression tag	UNP P14902
B	4	HIS	-	expression tag	UNP P14902
B	5	HIS	-	expression tag	UNP P14902
B	6	HIS	-	expression tag	UNP P14902
B	7	HIS	-	expression tag	UNP P14902
B	8	HIS	-	expression tag	UNP P14902
B	9	SER	-	expression tag	UNP P14902
B	10	SER	-	expression tag	UNP P14902
B	11	GLY	-	expression tag	UNP P14902
B	12	SER	-	expression tag	UNP P14902
B	13	ALA	-	expression tag	UNP P14902
B	14	ALA	-	expression tag	UNP P14902
B	116	ALA	LYS	engineered mutation	UNP P14902
B	117	ALA	LYS	engineered mutation	UNP P14902
C	-1	MET	-	initiating methionine	UNP P14902
C	0	GLY	-	expression tag	UNP P14902
C	1	SER	-	expression tag	UNP P14902
C	2	SER	-	expression tag	UNP P14902
C	3	HIS	-	expression tag	UNP P14902
C	4	HIS	-	expression tag	UNP P14902
C	5	HIS	-	expression tag	UNP P14902
C	6	HIS	-	expression tag	UNP P14902
C	7	HIS	-	expression tag	UNP P14902
C	8	HIS	-	expression tag	UNP P14902
C	9	SER	-	expression tag	UNP P14902
C	10	SER	-	expression tag	UNP P14902
C	11	GLY	-	expression tag	UNP P14902
C	12	SER	-	expression tag	UNP P14902
C	13	ALA	-	expression tag	UNP P14902
C	14	ALA	-	expression tag	UNP P14902
C	116	ALA	LYS	engineered mutation	UNP P14902
C	117	ALA	LYS	engineered mutation	UNP P14902
D	-1	MET	-	initiating methionine	UNP P14902
D	0	GLY	-	expression tag	UNP P14902
D	1	SER	-	expression tag	UNP P14902
D	2	SER	-	expression tag	UNP P14902
D	3	HIS	-	expression tag	UNP P14902
D	4	HIS	-	expression tag	UNP P14902
D	5	HIS	-	expression tag	UNP P14902
D	6	HIS	-	expression tag	UNP P14902
D	7	HIS	-	expression tag	UNP P14902

Continued on next page...

Continued from previous page...

Chain	Residue	Modelled	Actual	Comment	Reference
D	8	HIS	-	expression tag	UNP P14902
D	9	SER	-	expression tag	UNP P14902
D	10	SER	-	expression tag	UNP P14902
D	11	GLY	-	expression tag	UNP P14902
D	12	SER	-	expression tag	UNP P14902
D	13	ALA	-	expression tag	UNP P14902
D	14	ALA	-	expression tag	UNP P14902
D	116	ALA	LYS	engineered mutation	UNP P14902
D	117	ALA	LYS	engineered mutation	UNP P14902

- Molecule 2 is TRYPTOPHAN (three-letter code: TRP) (formula: $C_{11}H_{12}N_2O_2$) (labeled as "Ligand of Interest" by depositor).

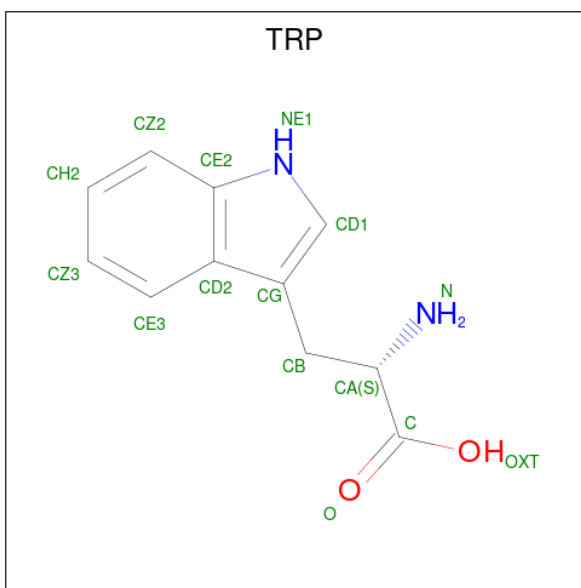

Mol	Chain	Residues	Atoms			ZeroOcc	AltConf	
2	A	1	Total	C	N	O	0	0
			15	11	2	2		
2	B	1	Total	C	N	O	0	0
			15	11	2	2		
2	B	1	Total	C	N	O	0	0
			15	11	2	2		
2	C	1	Total	C	N	O	0	0
			15	11	2	2		

- Molecule 3 is N'-Formylkynurenine (three-letter code: NFK) (formula: $C_{11}H_{12}N_2O_4$) (labeled as "Ligand of Interest" by depositor).

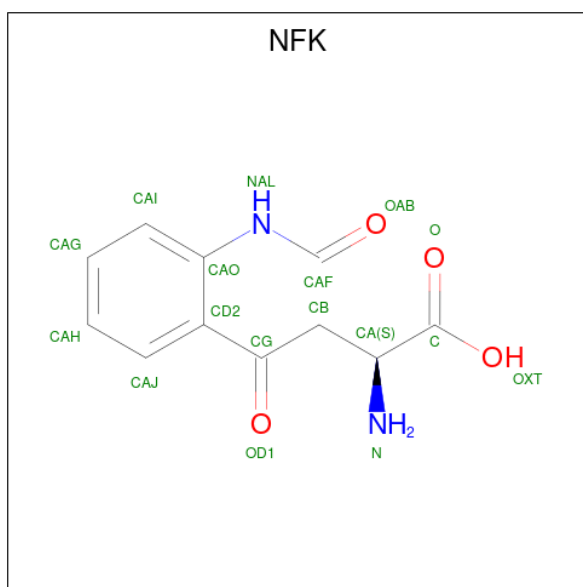

Mol	Chain	Residues	Atoms			ZeroOcc	AltConf	
			Total	C	N			O
3	A	1	17	11	2	4	0	0
3	D	1	17	11	2	4	0	0

- Molecule 4 is GLYCEROL (three-letter code: GOL) (formula: C₃H₈O₃).



Mol	Chain	Residues	Atoms			ZeroOcc	AltConf
			Total	C	O		
4	A	1	6	3	3	0	0
4	A	1	6	3	3	0	0

Continued on next page...

Continued from previous page...

Mol	Chain	Residues	Atoms			ZeroOcc	AltConf
4	A	1	Total 6	C 3	O 3	0	0
4	A	1	Total 6	C 3	O 3	0	0
4	A	1	Total 6	C 3	O 3	0	0
4	A	1	Total 6	C 3	O 3	0	0
4	A	1	Total 6	C 3	O 3	0	0
4	A	1	Total 6	C 3	O 3	0	0
4	B	1	Total 6	C 3	O 3	0	0
4	B	1	Total 6	C 3	O 3	0	0
4	B	1	Total 6	C 3	O 3	0	0
4	B	1	Total 6	C 3	O 3	0	0
4	B	1	Total 6	C 3	O 3	0	0
4	B	1	Total 6	C 3	O 3	0	0
4	B	1	Total 6	C 3	O 3	0	0
4	B	1	Total 6	C 3	O 3	0	0
4	B	1	Total 6	C 3	O 3	0	0
4	C	1	Total 6	C 3	O 3	0	0
4	C	1	Total 6	C 3	O 3	0	0
4	C	1	Total 6	C 3	O 3	0	0
4	C	1	Total 6	C 3	O 3	0	0
4	C	1	Total 6	C 3	O 3	0	0
4	C	1	Total 6	C 3	O 3	0	0
4	C	1	Total 6	C 3	O 3	0	0

Continued on next page...

Continued from previous page...

Mol	Chain	Residues	Atoms			ZeroOcc	AltConf
4	C	1	Total	C	O	0	0
			6	3	3		
4	C	1	Total	C	O	0	0
			6	3	3		
4	C	1	Total	C	O	0	0
			6	3	3		
4	C	1	Total	C	O	0	0
			6	3	3		
4	D	1	Total	C	O	0	0
			6	3	3		
4	D	1	Total	C	O	0	0
			6	3	3		
4	D	1	Total	C	O	0	0
			6	3	3		
4	D	1	Total	C	O	0	0
			6	3	3		

- Molecule 5 is PROTOPORPHYRIN IX CONTAINING FE (three-letter code: HEM) (formula: $C_{34}H_{32}FeN_4O_4$) (labeled as "Ligand of Interest" by depositor).

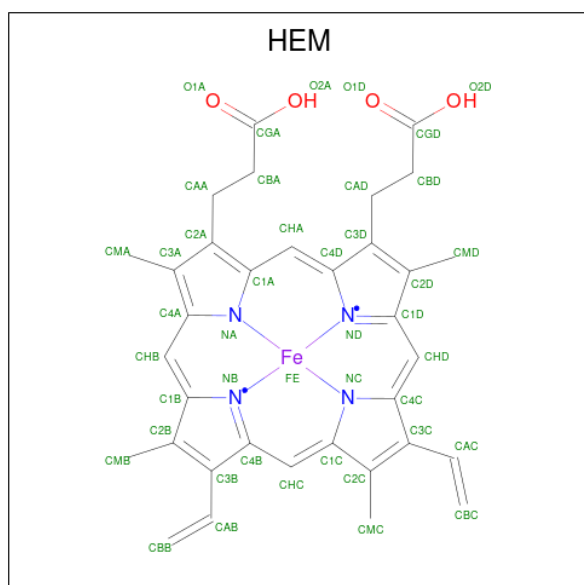

Mol	Chain	Residues	Atoms				ZeroOcc	AltConf	
5	A	1	Total	C	Fe	N	O	0	0
			43	34	1	4	4		

Continued on next page...

Continued from previous page...

Mol	Chain	Residues	Atoms				ZeroOcc	AltConf	
5	B	1	Total	C	Fe	N	O	0	0
			43	34	1	4	4		
5	C	1	Total	C	Fe	N	O	0	0
			43	34	1	4	4		
5	D	1	Total	C	Fe	N	O	0	0
			43	34	1	4	4		

- Molecule 6 is SODIUM ION (three-letter code: NA) (formula: Na).

Mol	Chain	Residues	Atoms		ZeroOcc	AltConf
6	A	1	Total	Na	0	0
			1	1		

- Molecule 7 is PHOSPHATE ION (three-letter code: PO4) (formula: O₄P).

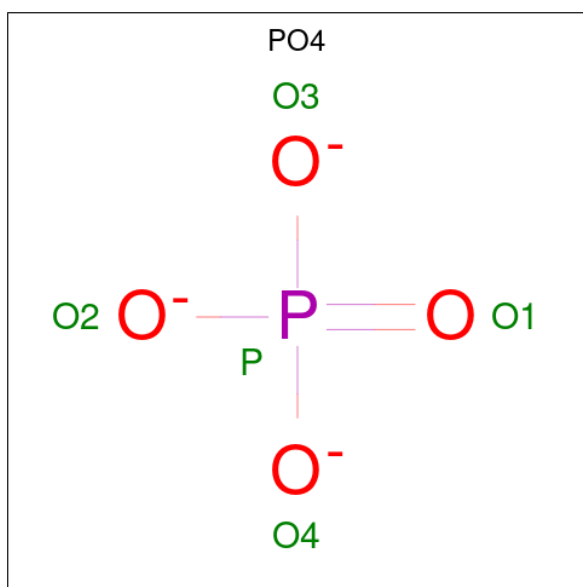

Mol	Chain	Residues	Atoms		ZeroOcc	AltConf
7	B	1	Total	O P	0	0
			5	4 1		
7	B	1	Total	O P	0	0
			5	4 1		
7	C	1	Total	O P	0	0
			5	4 1		

- Molecule 8 is CHLORIDE ION (three-letter code: CL) (formula: Cl).

Mol	Chain	Residues	Atoms	ZeroOcc	AltConf
8	C	1	Total Cl 1 1	0	0

- Molecule 9 is water.

Mol	Chain	Residues	Atoms	ZeroOcc	AltConf
9	A	174	Total O 174 174	0	0
9	B	176	Total O 176 176	0	0
9	C	162	Total O 162 162	0	0
9	D	156	Total O 156 156	0	0

3 Residue-property plots [i](#)

These plots are drawn for all protein, RNA, DNA and oligosaccharide chains in the entry. The first graphic for a chain summarises the proportions of the various outlier classes displayed in the second graphic. The second graphic shows the sequence view annotated by issues in geometry and electron density. Residues are color-coded according to the number of geometric quality criteria for which they contain at least one outlier: green = 0, yellow = 1, orange = 2 and red = 3 or more. A red dot above a residue indicates a poor fit to the electron density ($RSRZ > 2$). Stretches of 2 or more consecutive residues without any outlier are shown as a green connector. Residues present in the sample, but not in the model, are shown in grey.

- Molecule 1: Indoleamine 2,3-dioxygenase 1

Chain A: 

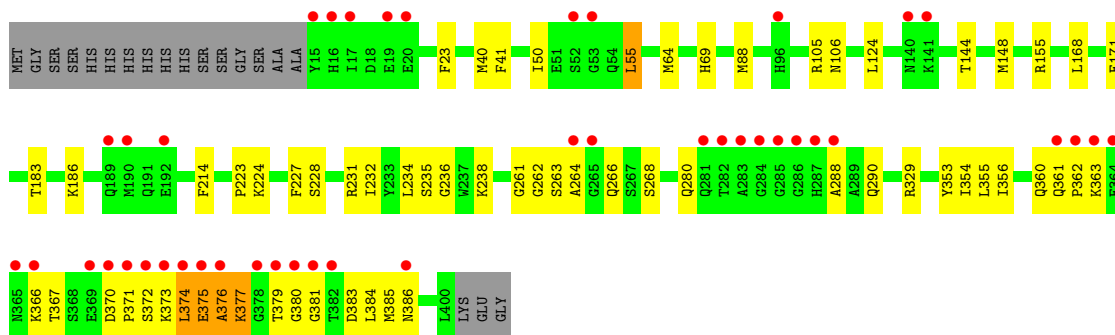

- Molecule 1: Indoleamine 2,3-dioxygenase 1

Chain B: 

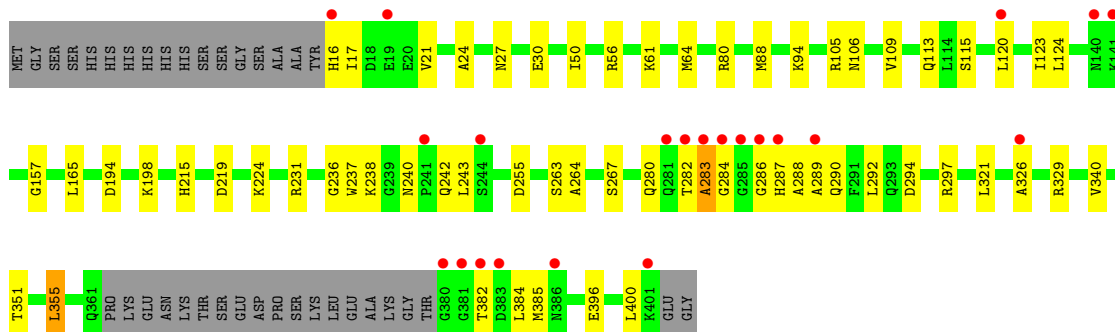

- Molecule 1: Indoleamine 2,3-dioxygenase 1

Chain C: 



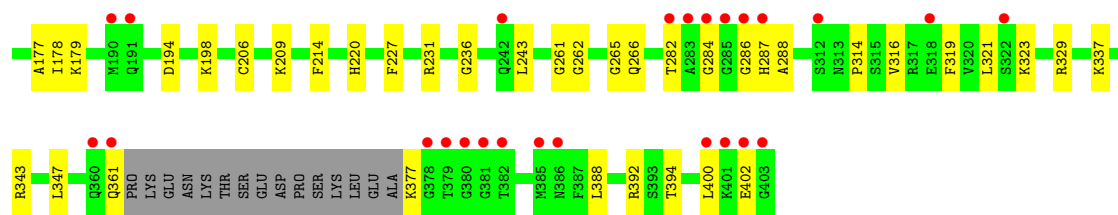

● Molecule 1: Indoleamine 2,3-dioxygenase 1

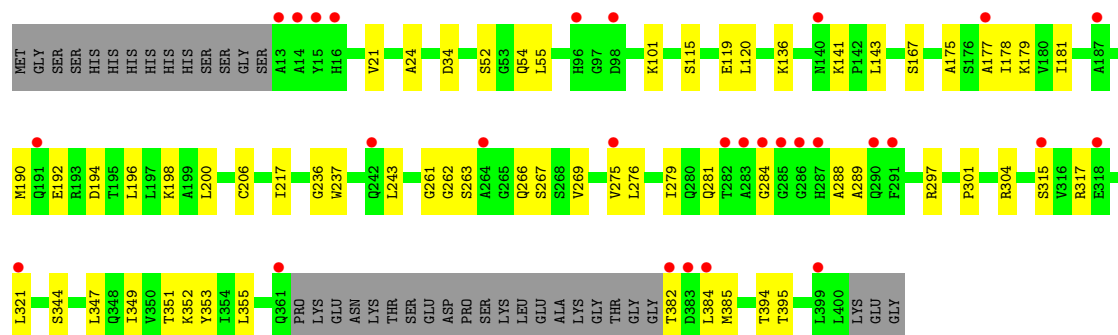
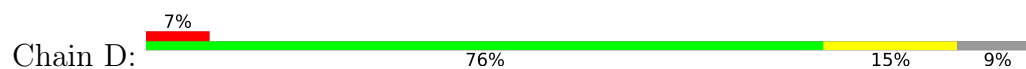

4 Data and refinement statistics

Property	Value	Source
Space group	P 21 21 2	Depositor
Cell constants a, b, c, α , β , γ	81.36Å 114.67Å 219.67Å 90.00° 90.00° 90.00°	Depositor
Resolution (Å)	46.87 – 2.30 46.87 – 2.30	Depositor EDS
% Data completeness (in resolution range)	99.6 (46.87-2.30) 99.6 (46.87-2.30)	Depositor EDS
R_{merge}	0.21	Depositor
R_{sym}	(Not available)	Depositor
$\langle I/\sigma(I) \rangle$ ¹	1.01 (at 2.29Å)	Xtrriage
Refinement program	PHENIX 1.18.2_3874	Depositor
R, R_{free}	0.215 , 0.271 0.215 , 0.271	Depositor DCC
R_{free} test set	1958 reflections (2.14%)	wwPDB-VP
Wilson B-factor (Å ²)	47.0	Xtrriage
Anisotropy	0.424	Xtrriage
Bulk solvent k_{sol} (e/Å ³), B_{sol} (Å ²)	(Not available) , (Not available)	EDS
L-test for twinning ²	$\langle L \rangle = 0.51$, $\langle L^2 \rangle = 0.34$	Xtrriage
Estimated twinning fraction	No twinning to report.	Xtrriage
F_o, F_c correlation	0.96	EDS
Total number of atoms	12992	wwPDB-VP
Average B, all atoms (Å ²)	54.0	wwPDB-VP

Xtrriage's analysis on translational NCS is as follows: *The analyses of the Patterson function reveals a significant off-origin peak that is 46.40 % of the origin peak, indicating pseudo-translational symmetry. The chance of finding a peak of this or larger height randomly in a structure without pseudo-translational symmetry is equal to 1.1510e-04. The detected translational NCS is most likely also responsible for the elevated intensity ratio.*

¹Intensities estimated from amplitudes.

²Theoretical values of $\langle |L| \rangle$, $\langle L^2 \rangle$ for acentric reflections are 0.5, 0.333 respectively for untwinned datasets, and 0.375, 0.2 for perfectly twinned datasets.

5 Model quality [i](#)

5.1 Standard geometry [i](#)

Bond lengths and bond angles in the following residue types are not validated in this section: CL, PO4, HEM, NFK, GOL, NA

The Z score for a bond length (or angle) is the number of standard deviations the observed value is removed from the expected value. A bond length (or angle) with $|Z| > 5$ is considered an outlier worth inspection. RMSZ is the root-mean-square of all Z scores of the bond lengths (or angles).

Mol	Chain	Bond lengths		Bond angles	
		RMSZ	# Z >5	RMSZ	# Z >5
1	A	0.45	0/3130	0.64	1/4236 (0.0%)
1	B	0.45	0/2974	0.63	2/4025 (0.0%)
1	C	0.47	0/3037	0.62	3/4108 (0.1%)
1	D	0.46	0/2980	0.62	0/4036
All	All	0.46	0/12121	0.63	6/16405 (0.0%)

Chiral center outliers are detected by calculating the chiral volume of a chiral center and verifying if the center is modelled as a planar moiety or with the opposite hand. A planarity outlier is detected by checking planarity of atoms in a peptide group, atoms in a mainchain group or atoms of a sidechain that are expected to be planar.

Mol	Chain	#Chirality outliers	#Planarity outliers
1	A	0	2

There are no bond length outliers.

All (6) bond angle outliers are listed below:

Mol	Chain	Res	Type	Atoms	Z	Observed(°)	Ideal(°)
1	B	355	LEU	CB-CG-CD2	-6.88	99.30	111.00
1	C	72	ASP	CB-CG-OD1	-6.16	112.76	118.30
1	C	149	ASP	CB-CG-OD1	-6.00	112.90	118.30
1	A	55	LEU	CA-CB-CG	-5.92	101.69	115.30
1	B	80	ARG	CG-CD-NE	-5.72	99.80	111.80
1	C	149	ASP	CB-CG-OD2	5.65	123.38	118.30

There are no chirality outliers.

All (2) planarity outliers are listed below:

Mol	Chain	Res	Type	Group
1	A	280	GLN	Peptide
1	A	376	ALA	Peptide

5.2 Too-close contacts [i](#)

In the following table, the Non-H and H(model) columns list the number of non-hydrogen atoms and hydrogen atoms in the chain respectively. The H(added) column lists the number of hydrogen atoms added and optimized by MolProbity. The Clashes column lists the number of clashes within the asymmetric unit, whereas Symm-Clashes lists symmetry-related clashes.

Mol	Chain	Non-H	H(model)	H(added)	Clashes	Symm-Clashes
1	A	3055	0	3063	66	0
1	B	2907	0	2918	51	0
1	C	2969	0	2974	44	0
1	D	2912	0	2918	42	0
2	A	15	0	9	6	0
2	B	30	0	18	5	0
2	C	15	0	9	0	0
3	A	17	0	0	3	0
3	D	17	0	0	0	0
4	A	48	0	64	4	0
4	B	48	0	64	9	0
4	C	72	0	96	7	0
4	D	30	0	40	4	0
5	A	43	0	30	8	0
5	B	43	0	30	5	0
5	C	43	0	30	3	0
5	D	43	0	30	8	0
6	A	1	0	0	0	0
7	B	10	0	0	0	0
7	C	5	0	0	0	0
8	C	1	0	0	0	0
9	A	174	0	0	11	1
9	B	176	0	0	9	0
9	C	162	0	0	6	0
9	D	156	0	0	2	1
All	All	12992	0	12293	225	1

The all-atom clashscore is defined as the number of clashes found per 1000 atoms (including hydrogen atoms). The all-atom clashscore for this structure is 9.

All (225) close contacts within the same asymmetric unit are listed below, sorted by their clash magnitude.

Atom-1	Atom-2	Interatomic distance (Å)	Clash overlap (Å)
1:D:353:TYR:HB2	5:D:507:HEM:HBC1	1.56	0.87
5:C:514:HEM:HBB2	5:C:514:HEM:HHC	1.58	0.85
1:A:363:LYS:HG3	1:A:374:LEU:HD12	1.61	0.83
1:D:382:THR:HG22	1:D:384:LEU:H	1.46	0.81
1:B:286:GLY:O	1:B:290:GLN:NE2	2.14	0.80
1:A:354:ILE:HG13	5:A:511:HEM:HBC1	1.64	0.79
1:A:366:LYS:HB3	1:A:370:ASP:HB3	1.65	0.78
1:B:157:GLY:HA2	2:B:502:TRP:HE1	1.49	0.77
5:A:511:HEM:HHC	5:A:511:HEM:HBB2	1.68	0.75
4:B:503:GOL:O3	4:B:503:GOL:O1	1.98	0.73
1:C:314:PRO:HD3	4:C:512:GOL:H32	1.69	0.72
4:C:505:GOL:O1	9:C:601:HOH:O	2.05	0.72
1:B:294:ASP:O	1:B:297:ARG:HG2	1.90	0.72
1:D:349:ILE:HG22	5:D:507:HEM:HBC2	1.72	0.71
1:A:261:GLY:H	1:A:377[B]:LYS:HB2	1.56	0.71
4:D:503:GOL:O1	9:D:601:HOH:O	2.07	0.70
1:B:292:LEU:HD21	5:B:511:HEM:HBD2	1.73	0.70
1:A:379:THR:HG22	1:A:381:GLY:H	1.58	0.68
1:B:267:SER:N	9:B:602:HOH:O	2.22	0.68
1:C:227:PHE:O	1:C:377:LYS:NZ	2.26	0.67
1:A:262[B]:GLY:O	1:A:377[B]:LYS:NZ	2.28	0.66
1:A:261:GLY:H	1:A:377[A]:LYS:HB2	1.59	0.66
1:A:373:LYS:HG3	1:A:376:ALA:HB3	1.77	0.66
5:A:511:HEM:HBC2	5:A:511:HEM:HHD	1.77	0.66
4:C:503:GOL:O3	4:C:503:GOL:O1	2.09	0.66
1:A:238:LYS:NZ	9:A:603:HOH:O	2.29	0.66
1:B:215:HIS:NE2	4:B:510:GOL:H12	2.11	0.66
1:B:231:ARG:HD3	9:B:727:HOH:O	1.97	0.64
1:D:297:ARG:NH2	9:D:602:HOH:O	2.21	0.64
1:B:64:MET:HB2	1:B:106:ASN:ND2	2.13	0.64
4:B:505:GOL:O3	4:B:505:GOL:O1	2.14	0.64
1:B:64:MET:HE1	1:B:109:VAL:HG11	1.80	0.63
1:B:64:MET:HE2	4:B:503:GOL:H12	1.81	0.63
1:B:88:MET:HE1	1:B:123:ILE:HG13	1.81	0.63
1:A:355:LEU:HD11	1:A:371:PRO:HG3	1.79	0.62
1:D:136:LYS:HE3	1:D:143:LEU:HD23	1.80	0.62
2:A:501:TRP:HD1	5:A:511:HEM:C4C	2.18	0.61
3:A:502:NFK:OAB	9:A:601:HOH:O	2.16	0.61
1:B:290:GLN:N	1:B:290:GLN:OE1	2.28	0.60
1:B:236:GLY:H	4:B:509:GOL:H2	1.66	0.60
1:D:317:ARG:O	1:D:321:LEU:HD23	2.02	0.60
5:D:507:HEM:HBB2	5:D:507:HEM:HMB1	1.84	0.60

Continued on next page...

Continued from previous page...

Atom-1	Atom-2	Interatomic distance (Å)	Clash overlap (Å)
1:C:236:GLY:H	4:C:508:GOL:H31	1.67	0.59
1:D:262:GLY:HA3	1:D:266:GLN:NE2	2.17	0.59
5:B:511:HEM:HMB1	5:B:511:HEM:HBB2	1.85	0.59
1:B:238:LYS:NZ	9:B:608:HOH:O	2.35	0.59
1:D:344:SER:HA	1:D:347:LEU:HD12	1.85	0.59
1:B:27:ASN:HB3	4:B:506:GOL:H11	1.83	0.59
1:A:384:LEU:HD23	1:A:384:LEU:H	1.67	0.59
1:C:177:ALA:HB2	1:C:206:CYS:HB2	1.85	0.59
1:A:288:ALA:O	1:A:290:GLN:N	2.36	0.59
1:D:353:TYR:HB2	5:D:507:HEM:CBC	2.29	0.58
1:A:88:MET:HE3	1:A:124:LEU:H	1.68	0.58
1:B:113:GLN:HE22	4:B:503:GOL:H2	1.68	0.58
5:C:514:HEM:HMC2	5:C:514:HEM:HBC2	1.86	0.58
1:A:371:PRO:C	1:A:373:LYS:H	2.07	0.57
1:A:55:LEU:HB3	4:A:510:GOL:H31	1.86	0.57
1:D:167:SER:HA	5:D:507:HEM:HBB1	1.87	0.57
1:D:281:GLN:HA	1:D:394:THR:HG21	1.85	0.57
1:A:235:SER:HA	1:A:377[B]:LYS:HB3	1.86	0.56
1:A:360:GLN:C	1:A:362:PRO:HD3	2.25	0.56
1:C:84:GLY:O	1:C:88:MET:HG2	2.06	0.56
1:C:284:GLY:HA3	1:C:288:ALA:HB3	1.87	0.56
1:A:262[A]:GLY:HA3	9:A:664:HOH:O	2.05	0.56
1:C:12:SER:HB2	1:C:19:GLU:HG2	1.86	0.56
1:D:167:SER:HA	5:D:507:HEM:CBB	2.36	0.56
1:B:194:ASP:O	1:B:198:LYS:HG2	2.06	0.56
1:C:179:LYS:NZ	9:C:611:HOH:O	2.40	0.55
1:C:321:LEU:HD21	1:C:400:LEU:HD22	1.88	0.55
1:D:177:ALA:HB2	1:D:206:CYS:HB2	1.88	0.55
1:A:373:LYS:O	1:A:374:LEU:HB2	2.07	0.55
1:B:287:HIS:HA	1:B:290:GLN:HE22	1.72	0.55
1:C:19:GLU:OE2	9:C:602:HOH:O	2.18	0.55
1:B:64:MET:CE	4:B:503:GOL:H12	2.37	0.55
1:A:224:LYS:NZ	9:A:604:HOH:O	2.31	0.55
1:A:371:PRO:O	1:A:383:ASP:HA	2.07	0.55
1:B:351:THR:HA	1:B:355:LEU:HD22	1.89	0.54
2:A:501:TRP:HD1	5:A:511:HEM:NC	2.04	0.54
1:D:267:SER:OG	1:D:269:VAL:HG22	2.08	0.54
1:D:136:LYS:HE2	1:D:141:LYS:O	2.07	0.54
1:B:280:GLN:HB3	1:B:282:THR:HG22	1.91	0.53
1:C:262:GLY:HA2	9:C:712:HOH:O	2.08	0.53
1:A:234:LEU:HD23	2:A:501:TRP:CE3	2.44	0.53

Continued on next page...

Continued from previous page...

Atom-1	Atom-2	Interatomic distance (Å)	Clash overlap (Å)
1:C:231:ARG:HE	1:C:377:LYS:HE3	1.74	0.53
1:A:263:SER:HB2	1:A:377[B]:LYS:HZ1	1.73	0.53
1:A:261:GLY:N	1:A:377[B]:LYS:HB2	2.25	0.52
1:B:242:GLN:NE2	9:B:613:HOH:O	2.41	0.52
1:C:316:VAL:H	4:C:510:GOL:H32	1.75	0.52
2:B:501:TRP:NE1	9:B:601:HOH:O	2.14	0.52
1:A:263:SER:HB2	1:A:377[A]:LYS:HE2	1.92	0.52
4:A:506:GOL:O1	4:A:506:GOL:O3	2.27	0.52
1:C:329:ARG:NE	1:C:402:GLU:HB2	2.24	0.52
1:D:236:GLY:HA3	1:D:261:GLY:N	2.24	0.52
1:B:355:LEU:HD21	1:B:385:MET:SD	2.50	0.51
1:A:227:PHE:HZ	1:A:363:LYS:HB3	1.74	0.51
1:A:231:ARG:NH1	1:A:373:LYS:O	2.42	0.51
1:D:21:VAL:HB	1:D:24:ALA:HB3	1.93	0.51
1:A:235:SER:HA	1:A:377[A]:LYS:HB3	1.92	0.51
1:C:14:ALA:O	1:C:17:ILE:N	2.33	0.51
5:B:511:HEM:HBD1	5:B:511:HEM:HMD1	1.93	0.50
1:B:284:GLY:HA2	1:B:289:ALA:HB3	1.92	0.50
1:A:183:THR:HA	1:A:186:LYS:HD3	1.92	0.50
1:B:224:LYS:NZ	9:B:610:HOH:O	2.38	0.50
3:A:502:NFK:N	3:A:502:NFK:OD1	2.42	0.50
1:B:283:ALA:O	1:B:288:ALA:HB3	2.12	0.50
1:C:343:ARG:HB2	1:C:392:ARG:HG3	1.94	0.50
1:D:351:THR:HA	1:D:355:LEU:HB2	1.94	0.50
1:D:237:TRP:HB3	1:D:243:LEU:HD12	1.94	0.49
1:A:64:MET:HB2	1:A:106:ASN:ND2	2.27	0.49
1:A:383:ASP:OD2	1:A:385:MET:HB2	2.12	0.49
1:C:337:LYS:NZ	9:C:612:HOH:O	2.43	0.49
1:D:315:SER:HA	4:D:502:GOL:H11	1.94	0.49
1:B:219:ASP:OD1	1:C:220:HIS:ND1	2.38	0.49
1:A:383:ASP:HB3	1:A:386:ASN:HB2	1.95	0.49
1:B:264:ALA:HB1	5:B:511:HEM:CGA	2.43	0.49
1:B:64:MET:HE1	1:B:109:VAL:CG1	2.42	0.49
1:A:370:ASP:OD1	9:A:602:HOH:O	2.20	0.49
1:B:115:SER:HB3	1:B:120:LEU:O	2.12	0.49
5:D:507:HEM:HBB2	5:D:507:HEM:CMB	2.42	0.49
1:A:264:ALA:HB2	9:A:665:HOH:O	2.12	0.49
5:A:511:HEM:HBC2	5:A:511:HEM:CHD	2.42	0.49
1:A:371:PRO:HD2	1:A:383:ASP:OD1	2.13	0.48
1:A:231:ARG:CZ	1:A:376:ALA:HB2	2.43	0.48
1:B:237:TRP:HB3	1:B:243:LEU:HD13	1.96	0.48

Continued on next page...

Continued from previous page...

Atom-1	Atom-2	Interatomic distance (Å)	Clash overlap (Å)
1:A:263:SER:HB2	1:A:377[B]:LYS:CE	2.44	0.48
1:A:262[B]:GLY:HA3	9:A:664:HOH:O	2.14	0.48
1:B:287:HIS:CA	1:B:290:GLN:HE22	2.26	0.48
1:B:263:SER:N	9:B:618:HOH:O	2.46	0.48
1:D:179:LYS:HE3	1:D:179:LYS:HB2	1.64	0.48
1:C:55:LEU:O	1:C:55:LEU:HG	2.12	0.47
1:A:363:LYS:HE3	1:A:375:GLU:HB3	1.95	0.47
1:B:326:ALA:HA	1:B:329:ARG:HH21	1.80	0.47
1:A:40:MET:HG3	4:A:505:GOL:H2	1.96	0.47
3:A:502:NFK:CAJ	1:D:352:LYS:HZ2	2.28	0.47
1:A:41:PHE:HA	4:A:505:GOL:H32	1.95	0.47
1:C:173:ALA:HB1	1:C:209:LYS:HG3	1.96	0.47
1:A:227:PHE:CZ	1:A:363:LYS:HB3	2.49	0.47
1:C:80:ARG:HH21	1:C:125:VAL:HG22	1.80	0.46
1:C:361:GLN:HE22	1:C:377:LYS:N	2.13	0.46
1:A:263:SER:HA	2:A:501:TRP:CE2	2.50	0.46
1:A:361:GLN:HG3	1:A:361:GLN:O	2.15	0.46
1:B:321:LEU:HD21	1:B:400:LEU:HD22	1.96	0.46
1:D:304:ARG:HE	4:D:505:GOL:H11	1.79	0.46
1:A:23:PHE:CE2	1:A:268:SER:HB2	2.50	0.46
1:A:329:ARG:NH1	9:A:615:HOH:O	2.48	0.46
1:B:94:LYS:HG3	2:B:501:TRP:HZ2	1.81	0.46
1:D:196:LEU:O	1:D:200:LEU:HG	2.16	0.46
1:A:168:LEU:O	1:A:171:GLU:HB3	2.16	0.46
1:B:16:HIS:O	1:B:17:ILE:HD13	2.16	0.46
1:D:101:LYS:HG2	1:D:243:LEU:CD2	2.46	0.46
5:C:514:HEM:HBC2	5:C:514:HEM:CMC	2.46	0.45
1:C:265:GLY:O	9:C:603:HOH:O	2.21	0.45
1:D:284:GLY:HA2	1:D:288:ALA:HB3	1.97	0.45
1:D:353:TYR:CB	5:D:507:HEM:HBC1	2.38	0.45
1:B:382:THR:HG22	1:B:384:LEU:H	1.81	0.45
1:A:144:THR:O	1:A:148:MET:HG3	2.17	0.45
1:A:223:PRO:HA	1:A:353:TYR:CD1	2.52	0.45
1:A:232:ILE:HD12	1:A:232:ILE:H	1.81	0.45
1:A:261:GLY:N	1:A:377[A]:LYS:HB2	2.28	0.45
1:D:178:ILE:O	1:D:181:ILE:HG12	2.17	0.45
2:A:501:TRP:HA	5:A:511:HEM:HMD2	1.99	0.44
1:A:106:ASN:HB2	9:A:633:HOH:O	2.18	0.44
1:B:88:MET:HE3	1:B:124:LEU:H	1.81	0.44
1:D:119:GLU:HB2	1:D:301:PRO:HG3	1.98	0.44
1:C:377:LYS:HE2	1:C:377:LYS:HB3	1.56	0.44

Continued on next page...

Continued from previous page...

Atom-1	Atom-2	Interatomic distance (Å)	Clash overlap (Å)
1:A:224:LYS:O	1:A:228:SER:HB2	2.17	0.44
1:C:319:PHE:O	1:C:323:LYS:HG2	2.18	0.44
1:B:61:LYS:HE2	9:B:741:HOH:O	2.17	0.44
1:C:72:ASP:N	1:C:72:ASP:OD1	2.46	0.44
1:A:105:ARG:NH1	9:A:616:HOH:O	2.49	0.44
1:A:236:GLY:H	1:A:377[B]:LYS:CB	2.30	0.44
1:C:286:GLY:O	1:C:287:HIS:ND1	2.52	0.43
1:C:329:ARG:HE	1:C:402:GLU:HB2	1.82	0.43
5:B:511:HEM:HBB2	5:B:511:HEM:CMB	2.47	0.43
1:A:374:LEU:HB3	1:A:375:GLU:H	1.52	0.43
1:B:56:ARG:HD2	2:B:501:TRP:CD2	2.54	0.43
1:C:24:ALA:HA	1:C:131:LEU:HD22	2.01	0.43
1:D:275:VAL:O	4:D:502:GOL:H12	2.19	0.43
1:B:50:ILE:HA	2:B:501:TRP:HH2	1.84	0.43
1:C:282:THR:H	1:C:394:THR:HG21	1.84	0.43
1:C:44:LYS:HE2	1:C:152:PHE:CE2	2.54	0.43
1:C:262:GLY:O	1:C:266:GLN:NE2	2.52	0.43
1:B:287:HIS:HA	1:B:290:GLN:NE2	2.33	0.42
1:B:340:VAL:HG21	1:B:396:GLU:HB3	2.00	0.42
1:D:284:GLY:HA3	1:D:289:ALA:H	1.84	0.42
1:D:217:ILE:HG21	1:D:349:ILE:HD12	1.99	0.42
1:D:355:LEU:HD11	1:D:385:MET:HG3	2.02	0.42
1:D:194:ASP:O	1:D:198:LYS:HG3	2.19	0.42
1:A:50:ILE:HG21	1:A:155:ARG:HD3	2.01	0.42
1:B:255:ASP:OD1	1:B:255:ASP:N	2.51	0.42
1:C:17:ILE:HG21	1:C:178:ILE:HG21	2.00	0.42
1:C:126:TYR:HB2	1:C:266:GLN:HB2	2.01	0.42
1:C:261:GLY:H	4:C:508:GOL:H2	1.84	0.42
1:C:177:ALA:HB2	1:C:206:CYS:CB	2.50	0.42
1:C:347:LEU:HD21	1:C:388:LEU:HB2	2.02	0.42
1:A:356:ILE:O	1:A:360:GLN:HG3	2.20	0.42
1:C:100:ARG:HA	1:C:100:ARG:HD3	1.91	0.42
1:B:165:LEU:HD23	1:B:165:LEU:HA	1.85	0.41
1:D:284:GLY:CA	1:D:289:ALA:H	2.33	0.41
1:B:240:ASN:OD1	1:B:242:GLN:HB2	2.20	0.41
1:C:206:CYS:O	1:C:209:LYS:HG2	2.20	0.41
1:A:263:SER:HA	2:A:501:TRP:CD2	2.56	0.41
1:D:190:MET:HB2	1:D:192:GLU:HG2	2.01	0.41
1:B:21:VAL:HB	1:B:24:ALA:HB3	2.03	0.41
1:D:181:ILE:HG23	1:D:276:LEU:HD13	2.02	0.41
1:A:69:HIS:HD2	9:A:759:HOH:O	2.04	0.41

Continued on next page...

Continued from previous page...

Atom-1	Atom-2	Interatomic distance (Å)	Clash overlap (Å)
1:A:262[A]:GLY:HA2	1:A:266:GLN:NE2	2.35	0.41
1:D:279:ILE:HD13	1:D:395:THR:HG23	2.03	0.41
1:A:263:SER:HB2	1:A:377[B]:LYS:NZ	2.34	0.41
1:B:294:ASP:OD1	1:B:297:ARG:HD3	2.21	0.41
1:C:23:PHE:O	1:C:131:LEU:HD13	2.20	0.41
1:C:25:LEU:HD12	1:C:26:PRO:HD2	2.01	0.41
1:D:52:SER:OG	1:D:54:GLN:HG3	2.21	0.41
1:D:175:ALA:HA	1:D:178:ILE:HD12	2.02	0.41
1:D:115:SER:HB3	1:D:120:LEU:O	2.20	0.41
1:B:105:ARG:NH1	9:B:619:HOH:O	2.48	0.40
1:A:374:LEU:O	1:A:376:ALA:N	2.50	0.40
1:A:384:LEU:HD12	5:A:511:HEM:HMD3	2.03	0.40
1:C:101:LYS:HG2	1:C:243:LEU:HD21	2.03	0.40
1:B:30:GLU:OE2	4:B:506:GOL:O2	2.39	0.40
1:C:316:VAL:H	4:C:510:GOL:C3	2.34	0.40
1:A:372:SER:O	1:A:380:GLY:HA3	2.22	0.40
1:C:194:ASP:O	1:C:198:LYS:HG3	2.22	0.40
1:D:55:LEU:O	1:D:55:LEU:HG	2.16	0.40

All (1) symmetry-related close contacts are listed below. The label for Atom-2 includes the symmetry operator and encoded unit-cell translations to be applied.

Atom-1	Atom-2	Interatomic distance (Å)	Clash overlap (Å)
9:A:680:HOH:O	9:D:634:HOH:O[4_575]	2.17	0.03

5.3 Torsion angles [i](#)

5.3.1 Protein backbone [i](#)

In the following table, the Percentiles column shows the percent Ramachandran outliers of the chain as a percentile score with respect to all X-ray entries followed by that with respect to entries of similar resolution.

The Analysed column shows the number of residues for which the backbone conformation was analysed, and the total number of residues.

Mol	Chain	Analysed	Favoured	Allowed	Outliers	Percentiles
1	A	386/405 (95%)	357 (92%)	26 (7%)	3 (1%)	19 23
1	B	364/405 (90%)	351 (96%)	12 (3%)	1 (0%)	41 50

Continued on next page...

Continued from previous page...

Mol	Chain	Analysed	Favoured	Allowed	Outliers	Percentiles	
1	C	373/405 (92%)	353 (95%)	20 (5%)	0	100	100
1	D	364/405 (90%)	342 (94%)	20 (6%)	2 (0%)	29	35
All	All	1487/1620 (92%)	1403 (94%)	78 (5%)	6 (0%)	34	42

All (6) Ramachandran outliers are listed below:

Mol	Chain	Res	Type
1	A	374	LEU
1	A	375	GLU
1	D	34	ASP
1	A	367	THR
1	B	283	ALA
1	D	263	SER

5.3.2 Protein sidechains [i](#)

In the following table, the Percentiles column shows the percent sidechain outliers of the chain as a percentile score with respect to all X-ray entries followed by that with respect to entries of similar resolution.

The Analysed column shows the number of residues for which the sidechain conformation was analysed, and the total number of residues.

Mol	Chain	Analysed	Rotameric	Outliers	Percentiles	
1	A	333/346 (96%)	330 (99%)	3 (1%)	78	89
1	B	316/346 (91%)	316 (100%)	0	100	100
1	C	321/346 (93%)	319 (99%)	2 (1%)	86	94
1	D	316/346 (91%)	316 (100%)	0	100	100
All	All	1286/1384 (93%)	1281 (100%)	5 (0%)	86	96

All (5) residues with a non-rotameric sidechain are listed below:

Mol	Chain	Res	Type
1	A	214	PHE
1	A	377[A]	LYS
1	A	377[B]	LYS
1	C	149	ASP
1	C	214	PHE

Sometimes sidechains can be flipped to improve hydrogen bonding and reduce clashes. All (6) such sidechains are listed below:

Mol	Chain	Res	Type
1	A	106	ASN
1	B	106	ASN
1	C	212	GLN
1	D	63	ASN
1	D	212	GLN
1	D	348	GLN

5.3.3 RNA [i](#)

There are no RNA molecules in this entry.

5.4 Non-standard residues in protein, DNA, RNA chains [i](#)

There are no non-standard protein/DNA/RNA residues in this entry.

5.5 Carbohydrates [i](#)

There are no monosaccharides in this entry.

5.6 Ligand geometry [i](#)

Of 48 ligands modelled in this entry, 2 are monoatomic - leaving 46 for Mogul analysis.

In the following table, the Counts columns list the number of bonds (or angles) for which Mogul statistics could be retrieved, the number of bonds (or angles) that are observed in the model and the number of bonds (or angles) that are defined in the Chemical Component Dictionary. The Link column lists molecule types, if any, to which the group is linked. The Z score for a bond length (or angle) is the number of standard deviations the observed value is removed from the expected value. A bond length (or angle) with $|Z| > 2$ is considered an outlier worth inspection. RMSZ is the root-mean-square of all Z scores of the bond lengths (or angles).

Mol	Type	Chain	Res	Link	Bond lengths			Bond angles		
					Counts	RMSZ	# Z > 2	Counts	RMSZ	# Z > 2
4	GOL	C	510	-	5,5,5	1.21	0	5,5,5	0.84	0
3	NFK	A	502	-	14,17,17	2.78	4 (28%)	16,22,22	2.46	6 (37%)
4	GOL	D	504	-	5,5,5	0.91	0	5,5,5	0.95	0
4	GOL	B	505	-	5,5,5	0.72	0	5,5,5	1.03	0
5	HEM	D	507	1	27,50,50	1.69	5 (18%)	17,82,82	2.13	8 (47%)
4	GOL	A	504	-	5,5,5	0.88	0	5,5,5	0.95	0

Mol	Type	Chain	Res	Link	Bond lengths			Bond angles		
					Counts	RMSZ	# Z > 2	Counts	RMSZ	# Z > 2
2	TRP	B	502	-	12,16,16	1.36	1 (8%)	12,22,22	1.58	2 (16%)
4	GOL	A	510	-	5,5,5	1.26	0	5,5,5	0.94	0
5	HEM	C	514	1	27,50,50	1.78	5 (18%)	17,82,82	1.81	7 (41%)
4	GOL	B	509	-	5,5,5	0.72	0	5,5,5	1.12	0
7	PO4	B	512	-	4,4,4	0.86	0	6,6,6	0.35	0
4	GOL	A	507	-	5,5,5	0.93	0	5,5,5	1.08	0
4	GOL	A	505	-	5,5,5	0.83	0	5,5,5	1.05	0
4	GOL	C	509	-	5,5,5	0.81	0	5,5,5	0.94	0
4	GOL	B	503	-	5,5,5	1.17	0	5,5,5	2.07	2 (40%)
4	GOL	C	502	-	5,5,5	1.44	1 (20%)	5,5,5	0.82	0
4	GOL	D	506	-	5,5,5	0.85	0	5,5,5	1.04	0
7	PO4	B	513	-	4,4,4	0.89	0	6,6,6	0.43	0
4	GOL	C	508	-	5,5,5	0.89	0	5,5,5	1.01	0
4	GOL	B	504	-	5,5,5	1.07	0	5,5,5	0.91	0
4	GOL	A	506	-	5,5,5	0.84	0	5,5,5	0.98	0
4	GOL	C	507	-	5,5,5	0.92	0	5,5,5	0.92	0
4	GOL	B	507	-	5,5,5	0.73	0	5,5,5	1.14	0
4	GOL	B	508	-	5,5,5	0.76	0	5,5,5	0.99	0
2	TRP	C	501	-	12,16,16	1.41	2 (16%)	12,22,22	0.77	0
4	GOL	C	511	-	5,5,5	0.83	0	5,5,5	1.02	0
5	HEM	B	511	1	27,50,50	1.81	6 (22%)	17,82,82	2.11	6 (35%)
4	GOL	D	503	-	5,5,5	0.68	0	5,5,5	1.38	1 (20%)
4	GOL	B	510	-	5,5,5	0.72	0	5,5,5	1.18	1 (20%)
4	GOL	C	505	-	5,5,5	0.68	0	5,5,5	1.15	0
7	PO4	C	516	-	4,4,4	0.90	0	6,6,6	0.47	0
4	GOL	A	508	-	5,5,5	0.78	0	5,5,5	1.13	1 (20%)
4	GOL	C	512	-	5,5,5	0.91	0	5,5,5	1.00	0
4	GOL	C	506	-	5,5,5	0.69	0	5,5,5	1.06	0
2	TRP	A	501	-	12,16,16	1.38	1 (8%)	12,22,22	0.71	0
4	GOL	B	506	-	5,5,5	1.16	0	5,5,5	0.87	0
4	GOL	A	509	-	5,5,5	0.92	0	5,5,5	1.05	0
5	HEM	A	511	1	27,50,50	1.93	4 (14%)	17,82,82	2.20	7 (41%)
4	GOL	C	503	-	5,5,5	0.55	0	5,5,5	1.30	1 (20%)
3	NFK	D	501	-	14,17,17	2.78	4 (28%)	16,22,22	1.96	4 (25%)
4	GOL	C	513	-	5,5,5	0.79	0	5,5,5	0.99	0
4	GOL	C	504	-	5,5,5	1.08	0	5,5,5	0.88	0
4	GOL	A	503	-	5,5,5	0.99	0	5,5,5	0.96	0
4	GOL	D	502	-	5,5,5	1.02	0	5,5,5	0.93	0
4	GOL	D	505	-	5,5,5	0.81	0	5,5,5	1.11	0
2	TRP	B	501	-	12,16,16	1.26	1 (8%)	12,22,22	0.70	0

In the following table, the Chirals column lists the number of chiral outliers, the number of chiral centers analysed, the number of these observed in the model and the number defined in the Chemical Component Dictionary. Similar counts are reported in the Torsion and Rings columns. '-' means no outliers of that kind were identified.

Mol	Type	Chain	Res	Link	Chirals	Torsions	Rings
4	GOL	C	510	-	-	2/4/4/4	-
3	NFK	A	502	-	-	5/11/15/15	0/1/1/1
4	GOL	D	504	-	-	1/4/4/4	-
4	GOL	B	505	-	-	2/4/4/4	-
5	HEM	D	507	1	-	0/6/54/54	-
4	GOL	A	504	-	-	3/4/4/4	-
2	TRP	B	502	-	-	1/3/8/8	0/2/2/2
4	GOL	A	510	-	-	2/4/4/4	-
5	HEM	C	514	1	-	0/6/54/54	-
4	GOL	B	509	-	-	1/4/4/4	-
4	GOL	A	507	-	-	2/4/4/4	-
4	GOL	A	505	-	-	2/4/4/4	-
4	GOL	C	509	-	-	4/4/4/4	-
4	GOL	B	503	-	-	0/4/4/4	-
4	GOL	C	502	-	-	1/4/4/4	-
4	GOL	D	506	-	-	2/4/4/4	-
4	GOL	C	508	-	-	4/4/4/4	-
4	GOL	B	504	-	-	1/4/4/4	-
4	GOL	A	506	-	-	2/4/4/4	-
4	GOL	C	507	-	-	0/4/4/4	-
4	GOL	B	507	-	-	2/4/4/4	-
4	GOL	B	508	-	-	0/4/4/4	-
2	TRP	C	501	-	-	2/3/8/8	0/2/2/2
4	GOL	C	511	-	-	3/4/4/4	-
5	HEM	B	511	1	-	2/6/54/54	-
4	GOL	D	503	-	-	2/4/4/4	-
4	GOL	B	510	-	-	4/4/4/4	-
4	GOL	C	505	-	-	0/4/4/4	-
4	GOL	A	508	-	-	2/4/4/4	-
4	GOL	C	512	-	-	2/4/4/4	-
4	GOL	C	506	-	-	0/4/4/4	-
2	TRP	A	501	-	-	2/3/8/8	0/2/2/2
4	GOL	B	506	-	-	0/4/4/4	-
4	GOL	A	509	-	-	0/4/4/4	-

Continued on next page...

Continued from previous page...

Mol	Type	Chain	Res	Link	Chirals	Torsions	Rings
5	HEM	A	511	1	-	0/6/54/54	-
4	GOL	C	503	-	-	0/4/4/4	-
3	NFK	D	501	-	-	6/11/15/15	0/1/1/1
4	GOL	C	513	-	-	2/4/4/4	-
4	GOL	C	504	-	-	0/4/4/4	-
4	GOL	A	503	-	-	4/4/4/4	-
4	GOL	D	502	-	-	2/4/4/4	-
4	GOL	D	505	-	-	4/4/4/4	-
2	TRP	B	501	-	-	2/3/8/8	0/2/2/2

All (34) bond length outliers are listed below:

Mol	Chain	Res	Type	Atoms	Z	Observed(Å)	Ideal(Å)
3	D	501	NFK	CAF-NAL	9.07	1.46	1.34
3	A	502	NFK	CAF-NAL	8.80	1.46	1.34
5	A	511	HEM	C3C-C2C	-5.17	1.33	1.40
5	A	511	HEM	C3B-C2B	-4.99	1.33	1.40
5	C	514	HEM	C3B-C2B	-4.20	1.34	1.40
5	B	511	HEM	C3C-C2C	-3.94	1.34	1.40
5	D	507	HEM	C3C-C2C	-3.93	1.34	1.40
5	C	514	HEM	C3C-C2C	-3.78	1.35	1.40
5	B	511	HEM	C3B-C2B	-3.64	1.35	1.40
5	D	507	HEM	C3B-C2B	-3.59	1.35	1.40
5	B	511	HEM	C3C-CAC	3.46	1.54	1.47
5	A	511	HEM	C3B-CAB	3.43	1.54	1.47
5	C	514	HEM	C3C-CAC	3.41	1.54	1.47
5	B	511	HEM	C3B-CAB	3.37	1.54	1.47
3	A	502	NFK	CAO-NAL	3.27	1.46	1.41
3	A	502	NFK	CD2-CG	3.14	1.54	1.48
2	B	502	TRP	CB-CG	3.09	1.59	1.51
5	D	507	HEM	C3C-CAC	3.03	1.54	1.47
3	D	501	NFK	CD2-CG	2.97	1.54	1.48
2	A	501	TRP	CB-CG	2.87	1.59	1.51
5	C	514	HEM	C3B-CAB	2.86	1.53	1.47
5	A	511	HEM	C3C-CAC	2.74	1.53	1.47
2	C	501	TRP	CB-CG	2.68	1.58	1.51
2	B	501	TRP	CB-CG	2.67	1.58	1.51
4	C	502	GOL	C1-C2	2.51	1.62	1.51
5	D	507	HEM	C3B-CAB	2.40	1.52	1.47
5	B	511	HEM	CAA-C2A	2.40	1.55	1.52
3	D	501	NFK	OD1-CG	-2.31	1.18	1.22

Continued on next page...

Continued from previous page...

Mol	Chain	Res	Type	Atoms	Z	Observed(Å)	Ideal(Å)
3	A	502	NFK	OD1-CG	-2.29	1.18	1.22
3	D	501	NFK	CAO-NAL	2.19	1.44	1.41
5	C	514	HEM	CAD-C3D	2.19	1.56	1.52
5	B	511	HEM	CAD-C3D	2.15	1.56	1.52
5	D	507	HEM	CAA-C2A	2.08	1.55	1.52
2	C	501	TRP	CA-N	-2.03	1.42	1.47

All (46) bond angle outliers are listed below:

Mol	Chain	Res	Type	Atoms	Z	Observed(°)	Ideal(°)
3	D	501	NFK	CAO-NAL-CAF	-4.89	117.37	126.63
3	A	502	NFK	OAB-CAF-NAL	-4.60	119.93	125.80
3	A	502	NFK	CAO-NAL-CAF	-4.43	118.24	126.63
5	A	511	HEM	CAD-CBD-CGD	-4.15	105.70	112.67
5	D	507	HEM	C2C-C3C-C4C	4.15	109.80	106.90
5	C	514	HEM	CBA-CAA-C2A	-3.99	105.13	112.49
2	B	502	TRP	CB-CG-CD1	-3.95	123.09	127.97
3	D	501	NFK	CAI-CAO-NAL	-3.90	116.74	122.59
3	A	502	NFK	CB-CG-CD2	3.69	124.99	119.86
5	A	511	HEM	C1D-C2D-C3D	3.63	109.52	107.00
5	B	511	HEM	CMD-C2D-C1D	-3.55	123.00	128.46
5	A	511	HEM	C2C-C3C-C4C	3.52	109.35	106.90
3	A	502	NFK	CAI-CAO-NAL	-3.48	117.36	122.59
2	B	502	TRP	CB-CG-CD2	3.38	131.51	126.25
5	B	511	HEM	CMB-C2B-C3B	3.34	130.92	124.68
5	A	511	HEM	CBA-CAA-C2A	-3.23	106.53	112.49
5	B	511	HEM	CMA-C3A-C4A	-3.22	123.52	128.46
5	D	507	HEM	CMA-C3A-C4A	-3.16	123.61	128.46
3	D	501	NFK	CB-CA-C	3.11	115.73	110.69
3	A	502	NFK	CD2-CAO-NAL	3.09	123.27	119.52
5	C	514	HEM	C2C-C3C-C4C	3.07	109.04	106.90
3	A	502	NFK	OD1-CG-CB	-3.01	117.27	120.76
5	A	511	HEM	CMD-C2D-C1D	-2.86	124.07	128.46
5	D	507	HEM	C4A-C3A-C2A	2.77	108.92	107.00
5	D	507	HEM	CMB-C2B-C3B	2.69	129.71	124.68
5	B	511	HEM	C4A-C3A-C2A	2.57	108.78	107.00
4	B	503	GOL	C3-C2-C1	-2.54	101.82	111.70
5	A	511	HEM	C3C-C4C-NC	-2.43	106.35	110.94
4	C	503	GOL	C3-C2-C1	-2.43	102.26	111.70
4	B	503	GOL	O2-C2-C3	2.43	119.82	109.12
5	D	507	HEM	C3C-C4C-NC	-2.38	106.45	110.94
5	B	511	HEM	C2C-C3C-C4C	2.38	108.56	106.90

Continued on next page...

Continued from previous page...

Mol	Chain	Res	Type	Atoms	Z	Observed(°)	Ideal(°)
5	D	507	HEM	C1D-C2D-C3D	2.37	108.65	107.00
5	D	507	HEM	CBD-CAD-C3D	-2.30	108.24	112.48
5	D	507	HEM	CBA-CAA-C2A	-2.28	108.29	112.49
5	B	511	HEM	CBD-CAD-C3D	2.27	116.66	112.48
5	C	514	HEM	C4A-C3A-C2A	2.23	108.55	107.00
5	C	514	HEM	C3C-C4C-NC	-2.22	106.74	110.94
5	C	514	HEM	CMD-C2D-C1D	-2.17	125.12	128.46
3	D	501	NFK	CD2-CAO-NAL	2.17	122.16	119.52
5	A	511	HEM	C4A-C3A-C2A	2.12	108.47	107.00
4	D	503	GOL	C3-C2-C1	-2.11	103.50	111.70
5	C	514	HEM	C1D-C2D-C3D	2.10	108.46	107.00
4	A	508	GOL	C3-C2-C1	-2.09	103.59	111.70
4	B	510	GOL	C3-C2-C1	-2.06	103.70	111.70
5	C	514	HEM	CMC-C2C-C3C	2.03	128.48	124.68

There are no chirality outliers.

All (76) torsion outliers are listed below:

Mol	Chain	Res	Type	Atoms
2	A	501	TRP	N-CA-CB-CG
2	A	501	TRP	C-CA-CB-CG
2	B	501	TRP	N-CA-CB-CG
2	B	501	TRP	C-CA-CB-CG
2	B	502	TRP	CA-CB-CG-CD1
2	C	501	TRP	N-CA-CB-CG
2	C	501	TRP	C-CA-CB-CG
3	A	502	NFK	CAO-CD2-CG-CB
3	A	502	NFK	CAO-CD2-CG-OD1
4	A	503	GOL	O1-C1-C2-C3
4	A	504	GOL	O1-C1-C2-C3
4	A	506	GOL	C1-C2-C3-O3
4	A	507	GOL	O1-C1-C2-C3
4	B	505	GOL	O1-C1-C2-C3
4	B	510	GOL	O1-C1-C2-C3
4	C	502	GOL	C1-C2-C3-O3
4	C	509	GOL	O1-C1-C2-O2
4	C	510	GOL	C1-C2-C3-O3
4	C	512	GOL	O1-C1-C2-C3
4	D	502	GOL	O1-C1-C2-C3
4	D	503	GOL	O1-C1-C2-C3
5	B	511	HEM	C2D-C3D-CAD-CBD
5	B	511	HEM	C4D-C3D-CAD-CBD

Continued on next page...

Continued from previous page...

Mol	Chain	Res	Type	Atoms
4	A	503	GOL	O2-C2-C3-O3
4	A	504	GOL	O1-C1-C2-O2
4	A	506	GOL	O2-C2-C3-O3
4	B	505	GOL	O1-C1-C2-O2
4	C	508	GOL	O1-C1-C2-O2
4	A	503	GOL	C1-C2-C3-O3
4	A	505	GOL	O1-C1-C2-C3
4	A	508	GOL	O1-C1-C2-C3
4	A	510	GOL	C1-C2-C3-O3
4	B	507	GOL	O1-C1-C2-C3
4	B	509	GOL	O1-C1-C2-C3
4	B	510	GOL	C1-C2-C3-O3
4	C	508	GOL	O1-C1-C2-C3
4	C	508	GOL	C1-C2-C3-O3
4	C	509	GOL	O1-C1-C2-C3
4	C	509	GOL	C1-C2-C3-O3
4	C	511	GOL	C1-C2-C3-O3
4	D	504	GOL	O1-C1-C2-C3
4	D	505	GOL	O1-C1-C2-C3
4	D	505	GOL	C1-C2-C3-O3
4	D	506	GOL	O1-C1-C2-C3
4	A	503	GOL	O1-C1-C2-O2
4	A	508	GOL	O1-C1-C2-O2
4	A	510	GOL	O2-C2-C3-O3
4	B	510	GOL	O1-C1-C2-O2
4	C	510	GOL	O2-C2-C3-O3
4	C	511	GOL	O2-C2-C3-O3
4	C	512	GOL	O1-C1-C2-O2
4	D	502	GOL	O1-C1-C2-O2
3	D	501	NFK	N-CA-CB-CG
4	A	505	GOL	O1-C1-C2-O2
4	A	507	GOL	O1-C1-C2-O2
4	B	507	GOL	O1-C1-C2-O2
4	D	505	GOL	O1-C1-C2-O2
4	A	504	GOL	O2-C2-C3-O3
4	B	510	GOL	O2-C2-C3-O3
3	D	501	NFK	CAI-CAO-NAL-CAF
3	A	502	NFK	CAI-CAO-NAL-CAF
4	C	508	GOL	O2-C2-C3-O3
4	C	509	GOL	O2-C2-C3-O3
3	D	501	NFK	CA-CB-CG-OD1
3	D	501	NFK	CA-CB-CG-CD2

Continued on next page...

Continued from previous page...

Mol	Chain	Res	Type	Atoms
3	A	502	NFK	CD2-CAO-NAL-CAF
3	D	501	NFK	CD2-CAO-NAL-CAF
4	B	504	GOL	O1-C1-C2-C3
4	D	506	GOL	O1-C1-C2-O2
3	A	502	NFK	N-CA-CB-CG
4	C	511	GOL	O1-C1-C2-C3
4	C	513	GOL	O1-C1-C2-C3
4	D	503	GOL	O1-C1-C2-O2
4	D	505	GOL	O2-C2-C3-O3
3	D	501	NFK	C-CA-CB-CG
4	C	513	GOL	O1-C1-C2-O2

There are no ring outliers.

24 monomers are involved in 59 short contacts:

Mol	Chain	Res	Type	Clashes	Symm-Clashes
4	C	510	GOL	2	0
3	A	502	NFK	3	0
4	B	505	GOL	1	0
5	D	507	HEM	8	0
2	B	502	TRP	1	0
4	A	510	GOL	1	0
5	C	514	HEM	3	0
4	B	509	GOL	1	0
4	A	505	GOL	2	0
4	B	503	GOL	4	0
4	C	508	GOL	2	0
4	A	506	GOL	1	0
5	B	511	HEM	5	0
4	D	503	GOL	1	0
4	B	510	GOL	1	0
4	C	505	GOL	1	0
4	C	512	GOL	1	0
2	A	501	TRP	6	0
4	B	506	GOL	2	0
5	A	511	HEM	8	0
4	C	503	GOL	1	0
4	D	502	GOL	2	0
4	D	505	GOL	1	0
2	B	501	TRP	4	0

The following is a two-dimensional graphical depiction of Mogul quality analysis of bond lengths,

bond angles, torsion angles, and ring geometry for all instances of the Ligand of Interest. In addition, ligands with molecular weight > 250 and outliers as shown on the validation Tables will also be included. For torsion angles, if less than 5% of the Mogul distribution of torsion angles is within 10 degrees of the torsion angle in question, then that torsion angle is considered an outlier. Any bond that is central to one or more torsion angles identified as an outlier by Mogul will be highlighted in the graph. For rings, the root-mean-square deviation (RMSD) between the ring in question and similar rings identified by Mogul is calculated over all ring torsion angles. If the average RMSD is greater than 60 degrees and the minimal RMSD between the ring in question and any Mogul-identified rings is also greater than 60 degrees, then that ring is considered an outlier. The outliers are highlighted in purple. The color gray indicates Mogul did not find sufficient equivalents in the CSD to analyse the geometry.

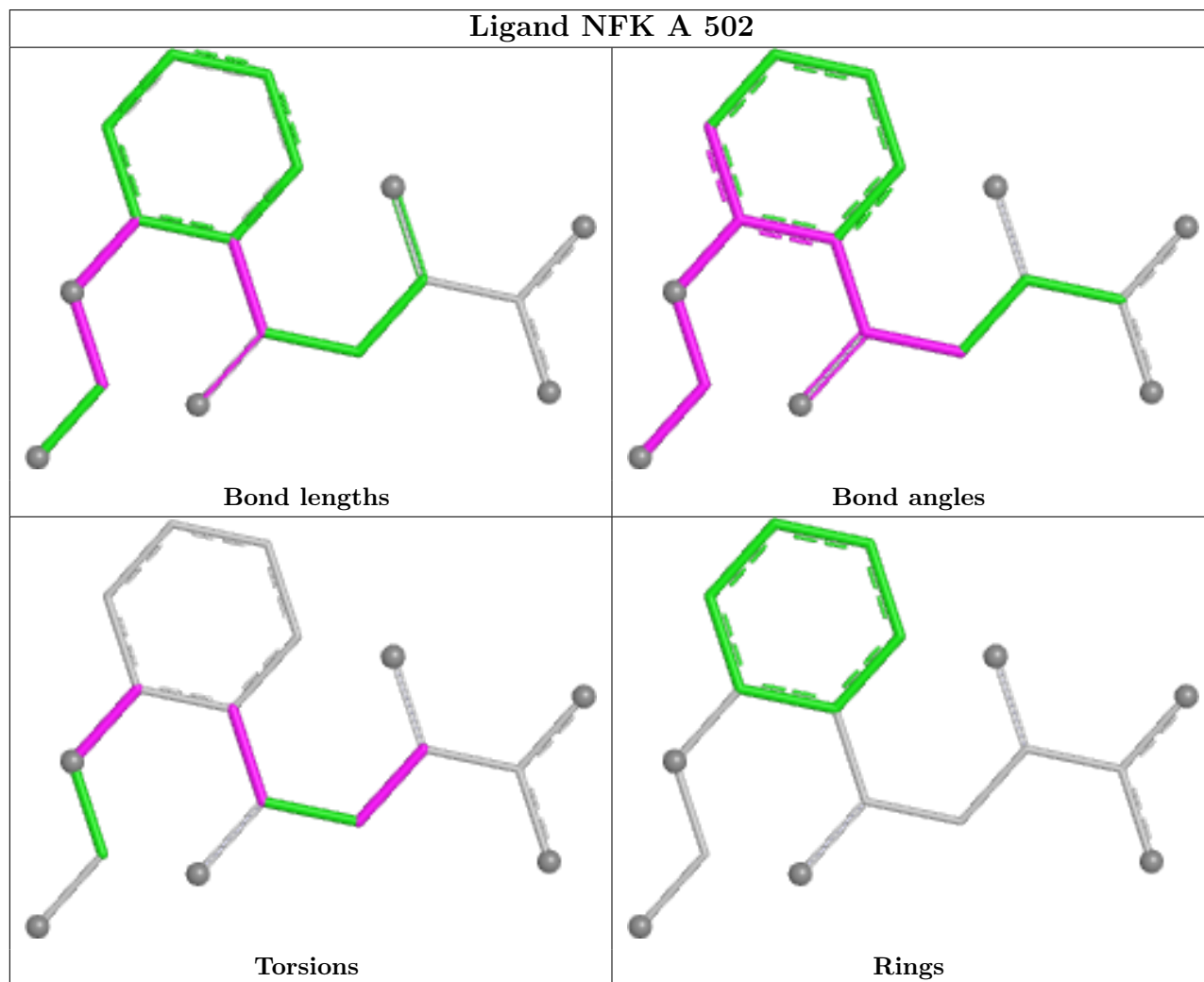

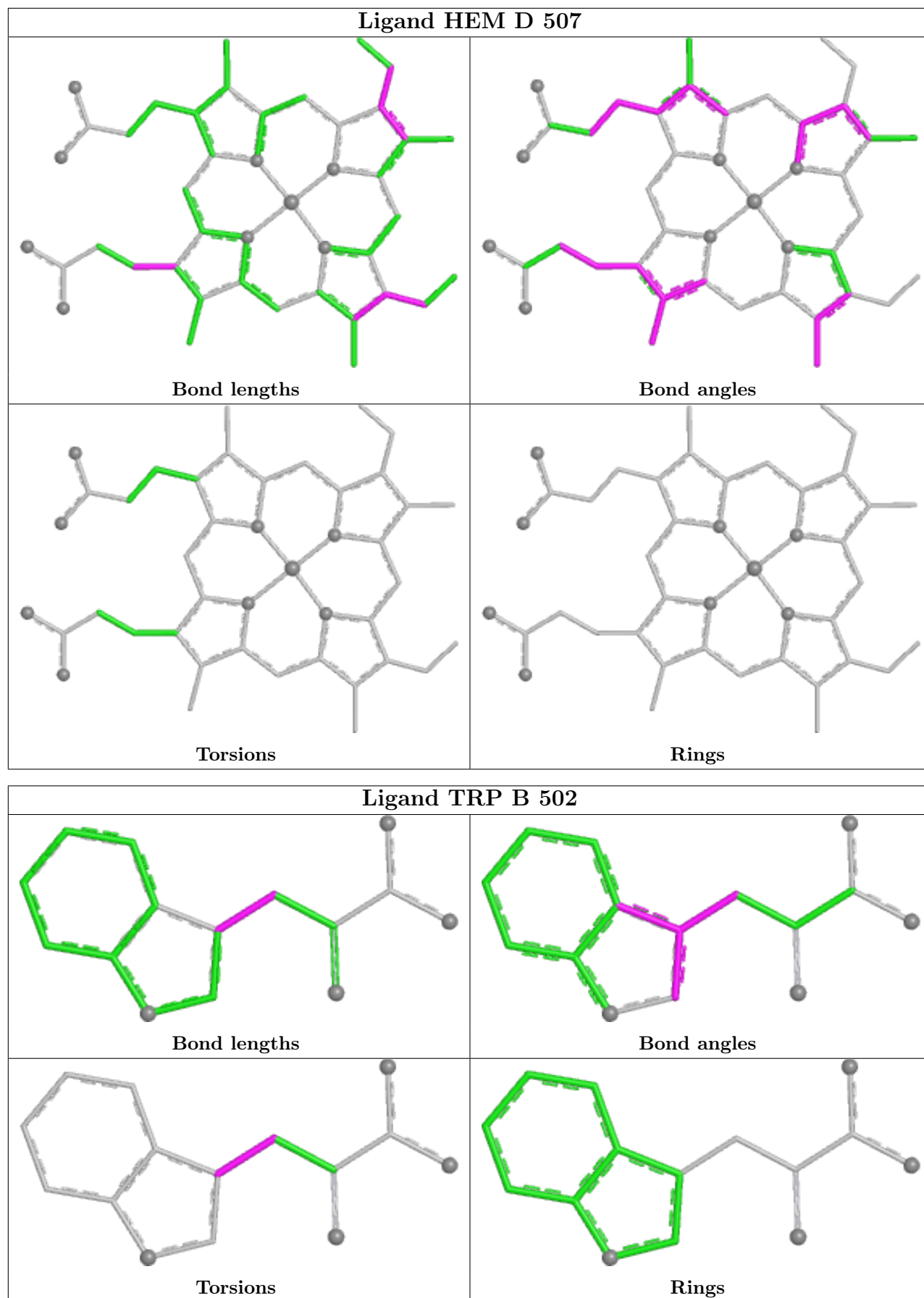

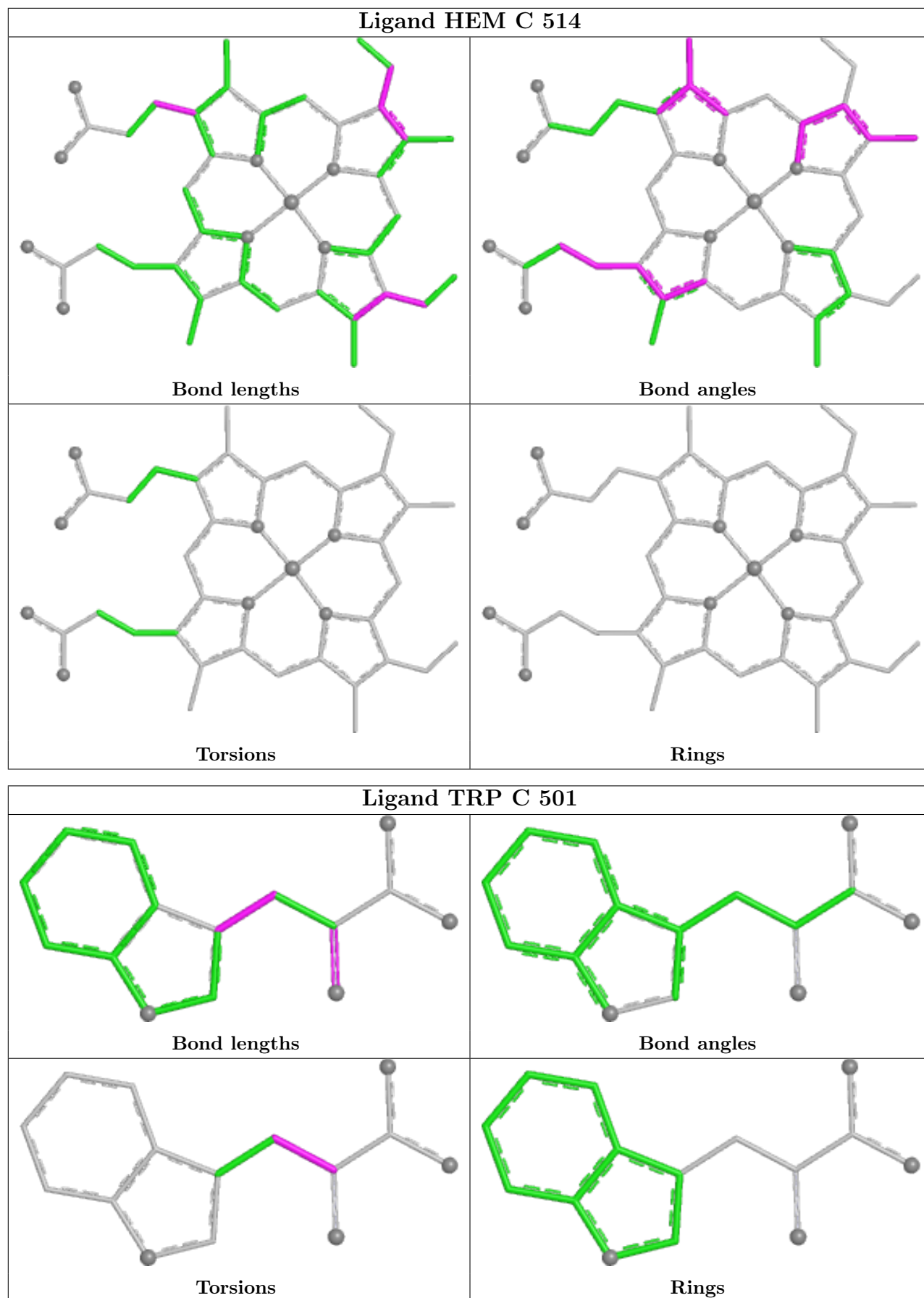

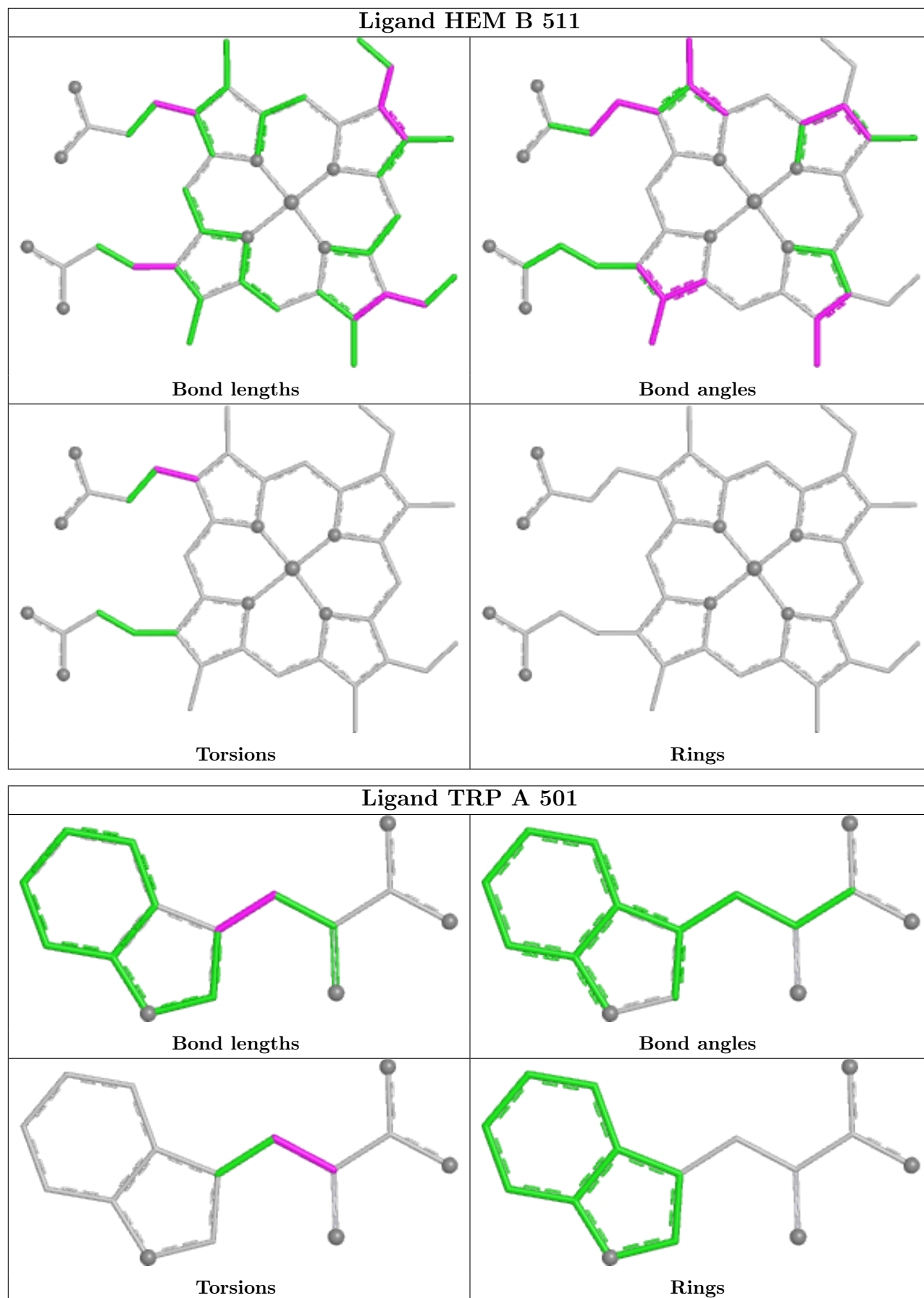

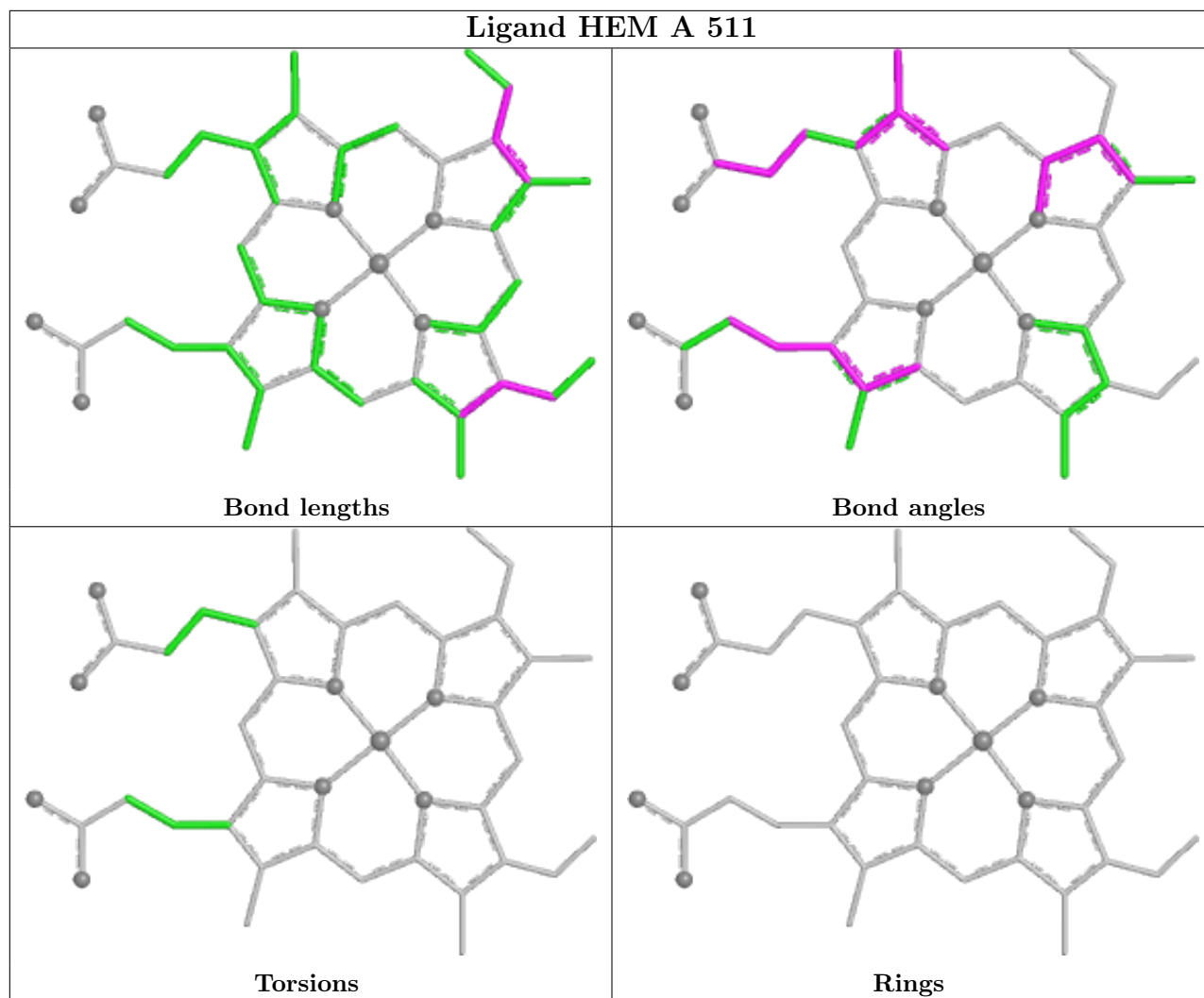

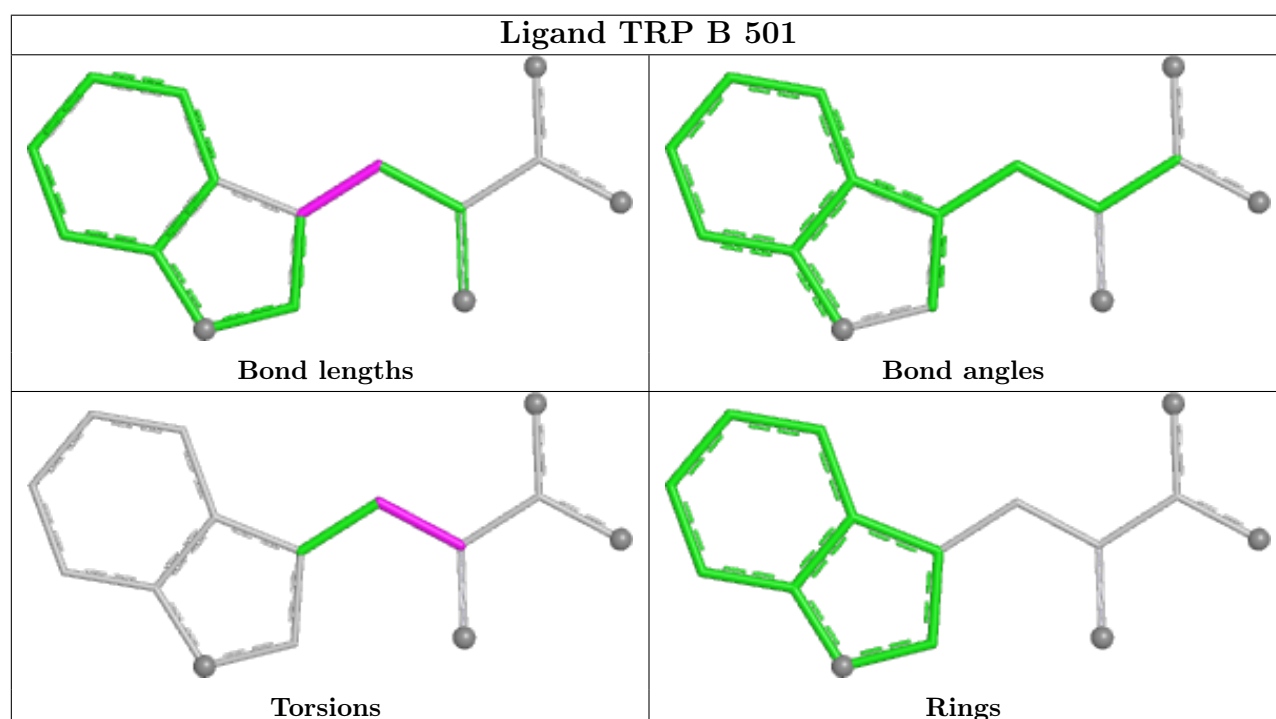
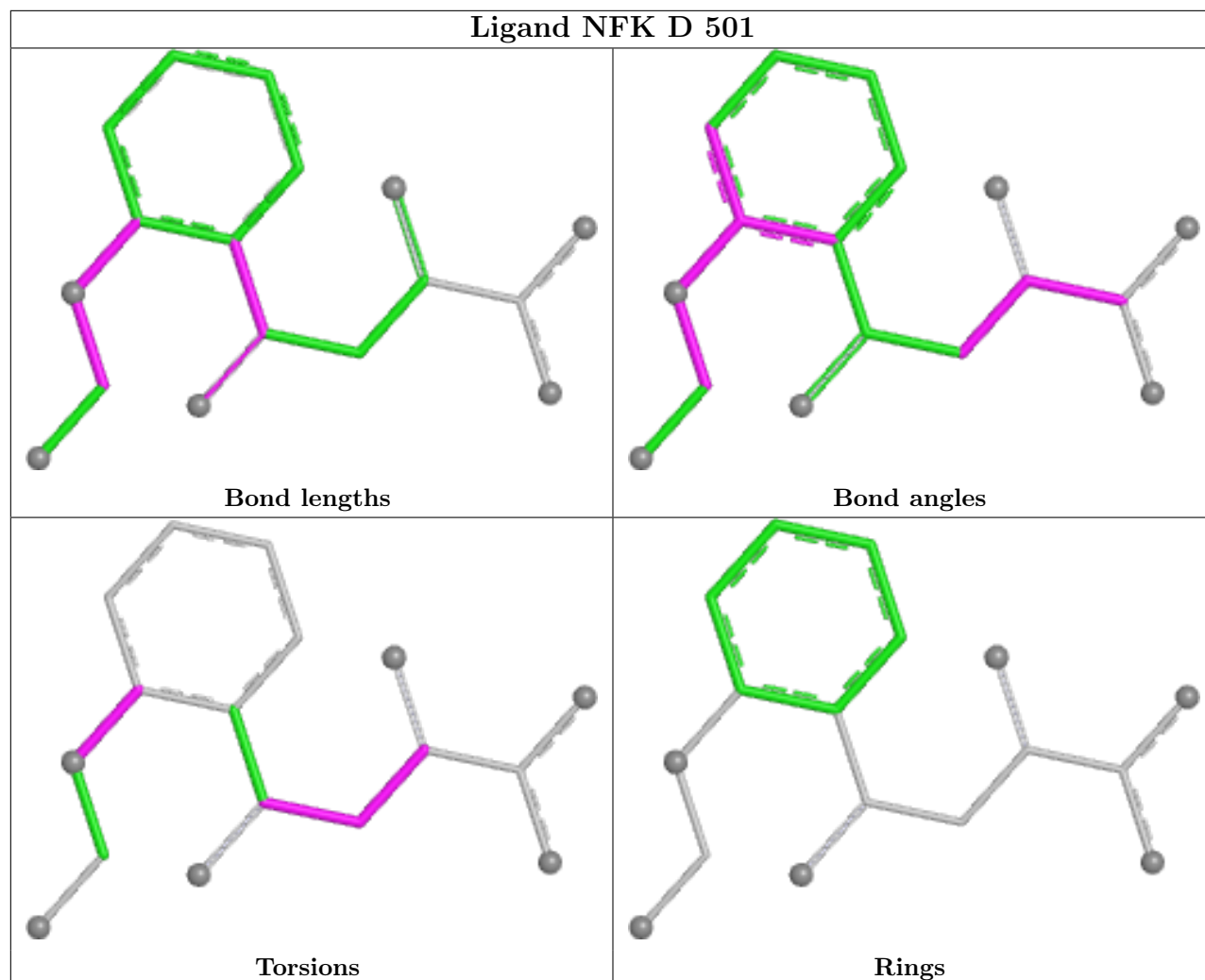

5.7 Other polymers [i](#)

There are no such residues in this entry.

5.8 Polymer linkage issues [i](#)

There are no chain breaks in this entry.

6 Fit of model and data

6.1 Protein, DNA and RNA chains

In the following table, the column labelled ‘#RSRZ > 2’ contains the number (and percentage) of RSRZ outliers, followed by percent RSRZ outliers for the chain as percentile scores relative to all X-ray entries and entries of similar resolution. The OWAB column contains the minimum, median, 95th percentile and maximum values of the occupancy-weighted average B-factor per residue. The column labelled ‘Q < 0.9’ lists the number of (and percentage) of residues with an average occupancy less than 0.9.

Mol	Chain	Analysed	<RSRZ>	#RSRZ>2	OWAB(Å ²)	Q<0.9
1	A	384/405 (94%)	0.64	43 (11%) 5 7	34, 52, 91, 110	7 (1%)
1	B	368/405 (90%)	0.43	22 (5%) 21 28	33, 52, 79, 117	0
1	C	377/405 (93%)	0.58	36 (9%) 8 11	33, 51, 83, 106	0
1	D	368/405 (90%)	0.50	29 (7%) 12 17	34, 53, 79, 99	0
All	All	1497/1620 (92%)	0.54	130 (8%) 10 14	33, 52, 82, 117	7 (0%)

All (130) RSRZ outliers are listed below:

Mol	Chain	Res	Type	RSRZ
1	A	283	ALA	10.2
1	D	282	THR	9.8
1	A	378	GLY	9.8
1	C	282	THR	9.0
1	C	379	THR	8.7
1	A	362	PRO	8.5
1	A	282	THR	8.4
1	B	286	GLY	8.3
1	C	286	GLY	8.1
1	A	366	LYS	7.8
1	B	287	HIS	7.4
1	D	284	GLY	7.4
1	C	382	THR	7.2
1	B	283	ALA	6.8
1	A	371	PRO	6.7
1	A	364	GLU	6.6
1	A	286	GLY	6.6
1	C	13	ALA	6.5
1	B	285	GLY	6.4
1	A	372	SER	6.4
1	D	15	TYR	6.4

Continued on next page...

Continued from previous page...

Mol	Chain	Res	Type	RSRZ
1	C	283	ALA	6.4
1	C	403	GLY	6.2
1	C	12	SER	6.1
1	A	374	LEU	6.0
1	A	379	THR	5.9
1	A	369	GLU	5.8
1	D	13	ALA	5.6
1	D	286	GLY	5.6
1	B	380	GLY	5.5
1	D	14	ALA	5.4
1	A	370	ASP	5.3
1	C	284	GLY	5.3
1	B	381	GLY	5.1
1	C	378	GLY	5.0
1	C	15	TYR	5.0
1	C	380	GLY	4.9
1	B	383	ASP	4.7
1	B	289	ALA	4.7
1	D	283	ALA	4.5
1	A	287	HIS	4.4
1	A	15	TYR	4.3
1	D	264	ALA	4.2
1	A	382	THR	4.2
1	C	361	GLN	4.1
1	A	376	ALA	4.1
1	C	14	ALA	4.1
1	C	381	GLY	4.0
1	C	16	HIS	3.9
1	B	284	GLY	3.9
1	A	381	GLY	3.7
1	A	189	GLN	3.7
1	A	363	LYS	3.7
1	A	365	ASN	3.7
1	C	385	MET	3.7
1	B	282	THR	3.6
1	B	244	SER	3.5
1	C	401	LYS	3.5
1	D	285	GLY	3.5
1	A	264	ALA	3.5
1	A	141	LYS	3.5
1	A	20	GLU	3.5
1	A	265	GLY	3.4

Continued on next page...

Continued from previous page...

Mol	Chain	Res	Type	RSRZ
1	C	285	GLY	3.4
1	C	96	HIS	3.3
1	A	281	GLN	3.2
1	D	191	GLN	3.2
1	A	284	GLY	3.2
1	A	16	HIS	3.1
1	A	19	GLU	3.1
1	B	19	GLU	3.0
1	A	375	GLU	3.0
1	A	373	LYS	3.0
1	A	361	GLN	3.0
1	A	380	GLY	3.0
1	D	16	HIS	3.0
1	B	382	THR	2.9
1	C	360	GLN	2.9
1	A	386	ASN	2.8
1	D	321	LEU	2.8
1	A	140	ASN	2.8
1	B	281	GLN	2.8
1	A	288	ALA	2.7
1	D	382	THR	2.7
1	A	52	SER	2.7
1	C	386	ASN	2.7
1	C	287	HIS	2.7
1	D	361	GLN	2.7
1	D	384	LEU	2.7
1	D	315	SER	2.6
1	D	383	ASP	2.6
1	D	96	HIS	2.6
1	D	287	HIS	2.6
1	C	242	GLN	2.6
1	C	402	GLU	2.6
1	C	318	GLU	2.6
1	D	291	PHE	2.5
1	A	285	GLY	2.5
1	A	190	MET	2.5
1	D	399	LEU	2.5
1	D	98	ASP	2.5
1	A	17	ILE	2.5
1	C	312	SER	2.5
1	D	318	GLU	2.4
1	C	400	LEU	2.4

Continued on next page...

Continued from previous page...

Mol	Chain	Res	Type	RSRZ
1	B	386	ASN	2.4
1	D	187	ALA	2.4
1	B	140	ASN	2.3
1	D	242	GLN	2.3
1	D	140	ASN	2.3
1	C	98	ASP	2.3
1	C	21	VAL	2.3
1	A	96	HIS	2.3
1	B	241	PRO	2.3
1	C	19	GLU	2.2
1	B	141	LYS	2.2
1	A	192	GLU	2.2
1	B	401	LYS	2.2
1	D	177	ALA	2.1
1	C	191	GLN	2.1
1	C	190	MET	2.1
1	C	141	LYS	2.1
1	D	290	GLN	2.1
1	A	53	GLY	2.1
1	B	120	LEU	2.0
1	C	97	GLY	2.0
1	B	16	HIS	2.0
1	D	275	VAL	2.0
1	C	322	SER	2.0
1	B	326	ALA	2.0

6.2 Non-standard residues in protein, DNA, RNA chains [i](#)

There are no non-standard protein/DNA/RNA residues in this entry.

6.3 Carbohydrates [i](#)

There are no monosaccharides in this entry.

6.4 Ligands [i](#)

In the following table, the Atoms column lists the number of modelled atoms in the group and the number defined in the chemical component dictionary. The B-factors column lists the minimum, median, 95th percentile and maximum values of B factors of atoms in the group. The column labelled 'Q < 0.9' lists the number of atoms with occupancy less than 0.9.

Mol	Type	Chain	Res	Atoms	RSCC	RSR	B-factors(Å ²)	Q<0.9
2	TRP	B	502	15/15	0.52	0.38	48,56,60,60	15
4	GOL	B	506	6/6	0.63	0.23	57,63,65,66	6
4	GOL	C	502	6/6	0.64	0.32	49,53,55,55	0
4	GOL	C	507	6/6	0.67	0.36	67,73,74,75	0
4	GOL	C	511	6/6	0.67	0.30	64,67,75,76	0
4	GOL	A	509	6/6	0.68	0.32	69,75,78,78	0
2	TRP	B	501	15/15	0.69	0.23	47,55,61,67	15
4	GOL	B	508	6/6	0.70	0.21	63,64,65,66	6
4	GOL	A	504	6/6	0.71	0.28	83,87,89,90	0
3	NFK	D	501	17/17	0.74	0.33	46,54,59,62	17
4	GOL	C	503	6/6	0.76	0.31	48,52,53,54	6
2	TRP	A	501	15/15	0.76	0.34	59,63,72,72	15
3	NFK	A	502	17/17	0.76	0.20	54,61,66,68	17
2	TRP	C	501	15/15	0.79	0.26	52,56,69,69	15
4	GOL	A	510	6/6	0.79	0.28	52,56,59,66	6
4	GOL	C	509	6/6	0.80	0.39	57,59,61,63	0
4	GOL	D	503	6/6	0.80	0.30	41,46,48,58	6
4	GOL	D	505	6/6	0.80	0.17	62,68,71,73	0
4	GOL	C	512	6/6	0.81	0.27	75,76,84,88	0
4	GOL	C	510	6/6	0.81	0.28	59,61,63,69	0
4	GOL	B	510	6/6	0.81	0.16	58,61,65,66	0
7	PO4	B	513	5/5	0.81	0.22	52,58,60,71	5
4	GOL	D	502	6/6	0.82	0.22	61,68,71,76	0
4	GOL	C	504	6/6	0.84	0.24	49,55,56,58	6
4	GOL	A	505	6/6	0.84	0.20	46,49,57,57	6
4	GOL	A	506	6/6	0.85	0.23	45,51,53,57	6
4	GOL	B	507	6/6	0.85	0.20	53,55,57,67	6
4	GOL	B	505	6/6	0.86	0.32	42,43,50,53	6
4	GOL	A	508	6/6	0.87	0.18	49,60,63,63	6
4	GOL	C	508	6/6	0.87	0.18	61,64,72,78	0
6	NA	A	512	1/1	0.88	0.22	67,67,67,67	0
4	GOL	D	506	6/6	0.88	0.40	68,73,75,77	0
7	PO4	C	516	5/5	0.88	0.23	62,62,68,70	5
8	CL	C	515	1/1	0.88	0.13	84,84,84,84	0
4	GOL	A	503	6/6	0.89	0.23	61,65,66,67	0
4	GOL	D	504	6/6	0.89	0.14	48,49,56,61	0
7	PO4	B	512	5/5	0.90	0.17	49,51,59,63	5
4	GOL	A	507	6/6	0.90	0.23	51,54,56,58	6
4	GOL	B	504	6/6	0.90	0.20	48,50,53,56	6
4	GOL	C	513	6/6	0.90	0.14	60,62,68,72	0
4	GOL	C	506	6/6	0.91	0.39	52,59,65,71	0
4	GOL	B	503	6/6	0.91	0.18	45,50,52,53	0
5	HEM	D	507	43/43	0.92	0.16	43,61,73,83	0

Continued on next page...

Continued from previous page...

Mol	Type	Chain	Res	Atoms	RSCC	RSR	B-factors(\AA^2)	Q<0.9
5	HEM	B	511	43/43	0.92	0.17	47,57,68,78	0
5	HEM	A	511	43/43	0.93	0.15	48,58,69,84	0
4	GOL	C	505	6/6	0.94	0.20	41,46,50,51	6
5	HEM	C	514	43/43	0.94	0.17	45,58,70,79	0
4	GOL	B	509	6/6	0.95	0.14	56,59,61,71	0

The following is a graphical depiction of the model fit to experimental electron density of all instances of the Ligand of Interest. In addition, ligands with molecular weight > 250 and outliers as shown on the geometry validation Tables will also be included. Each fit is shown from different orientation to approximate a three-dimensional view.

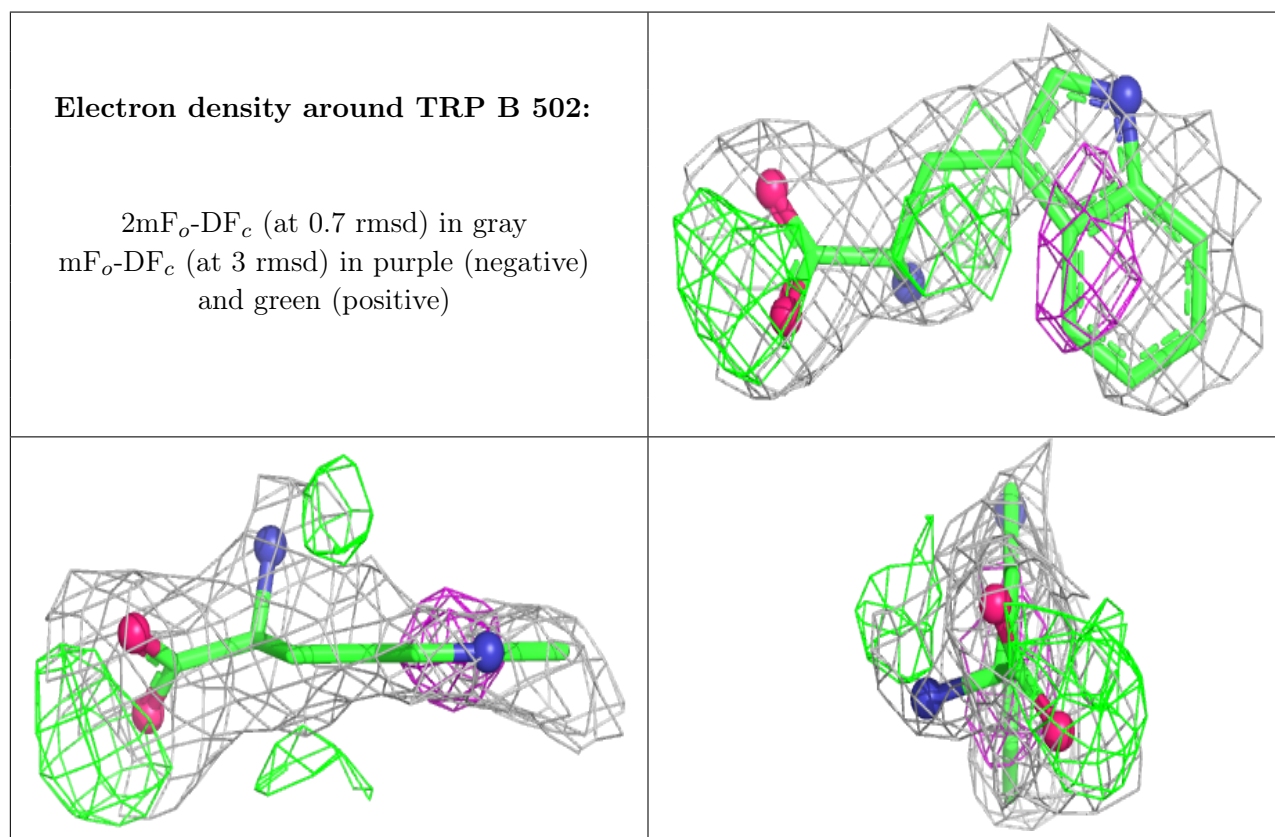

Electron density around TRP B 501:

$2mF_o-DF_c$ (at 0.7 rmsd) in gray
 mF_o-DF_c (at 3 rmsd) in purple (negative)
and green (positive)

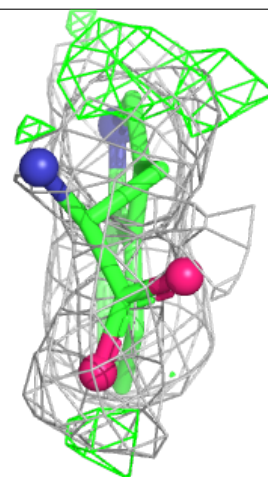
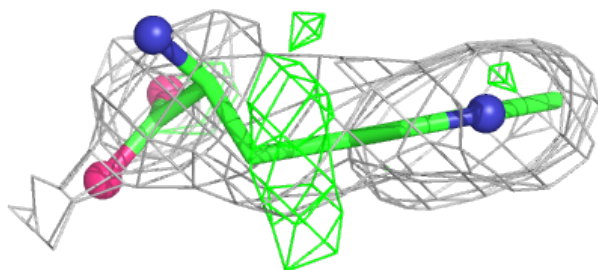
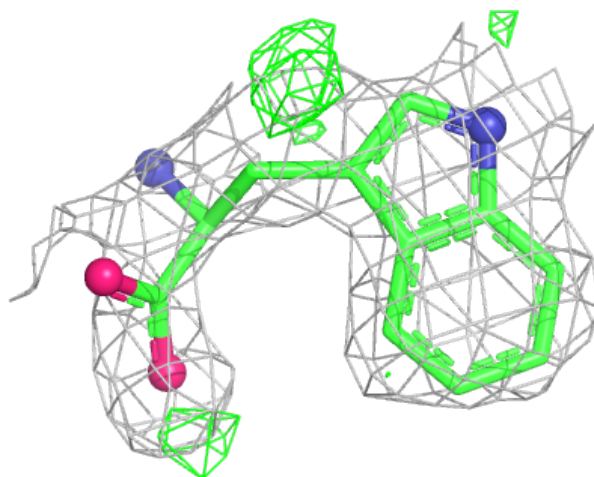

Electron density around NFK D 501:

$2mF_o-DF_c$ (at 0.7 rmsd) in gray
 mF_o-DF_c (at 3 rmsd) in purple (negative)
and green (positive)

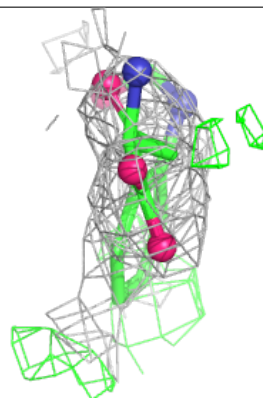
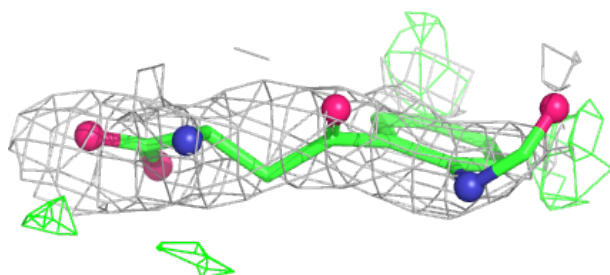
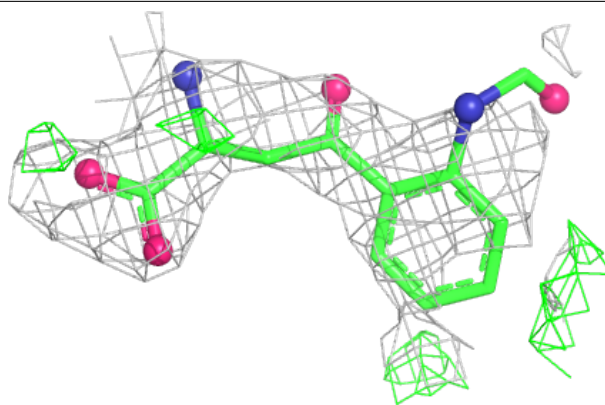
**Electron density around TRP A 501:**

$2mF_o-DF_c$ (at 0.7 rmsd) in gray
 mF_o-DF_c (at 3 rmsd) in purple (negative)
and green (positive)

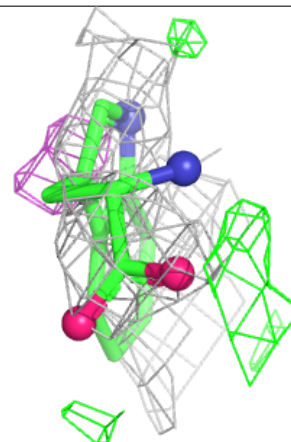
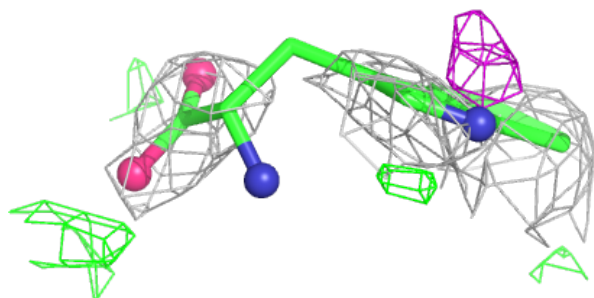
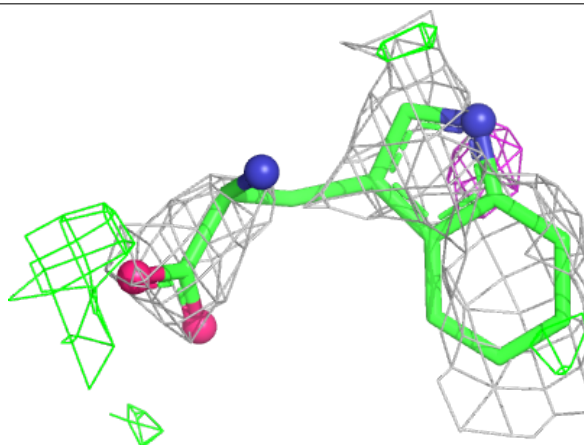

Electron density around NFK A 502:

$2mF_o-DF_c$ (at 0.7 rmsd) in gray
 mF_o-DF_c (at 3 rmsd) in purple (negative)
and green (positive)

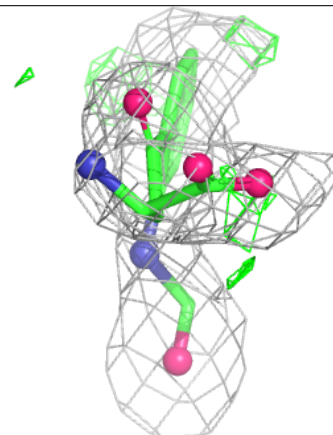
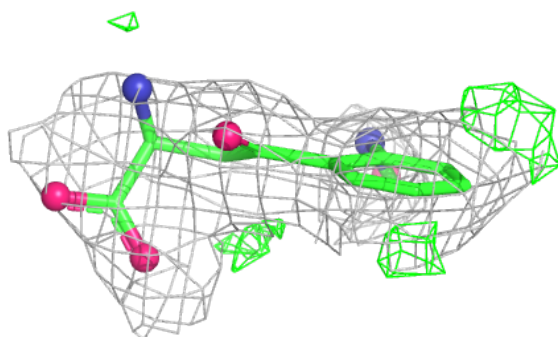
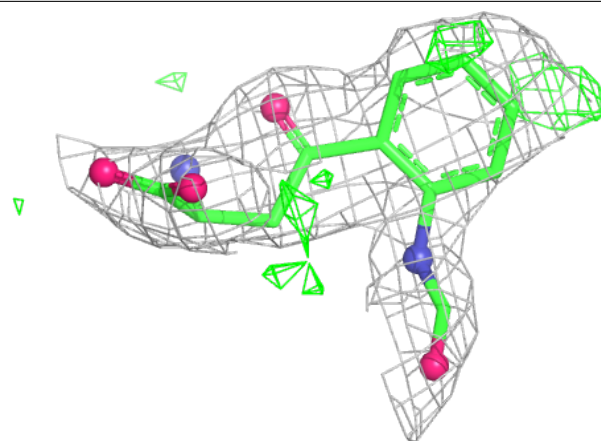
**Electron density around TRP C 501:**

$2mF_o-DF_c$ (at 0.7 rmsd) in gray
 mF_o-DF_c (at 3 rmsd) in purple (negative)
and green (positive)

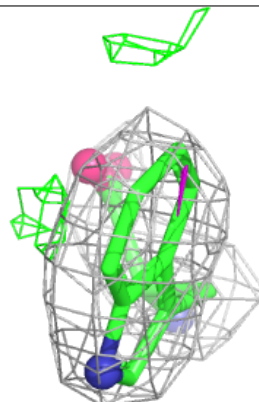
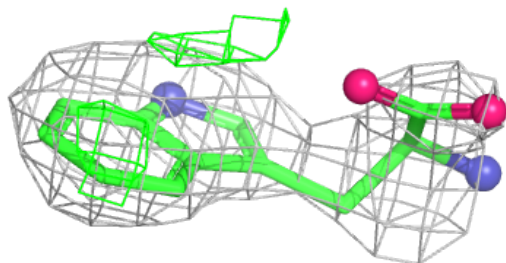
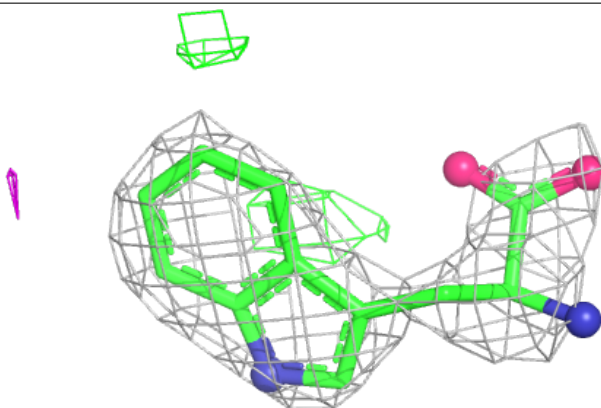

Electron density around HEM D 507:

$2mF_o-DF_c$ (at 0.7 rmsd) in gray
 mF_o-DF_c (at 3 rmsd) in purple (negative)
and green (positive)

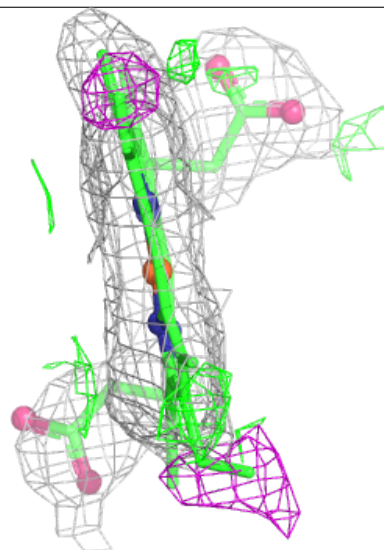
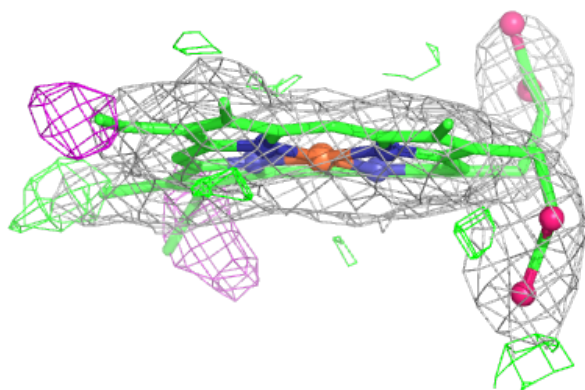
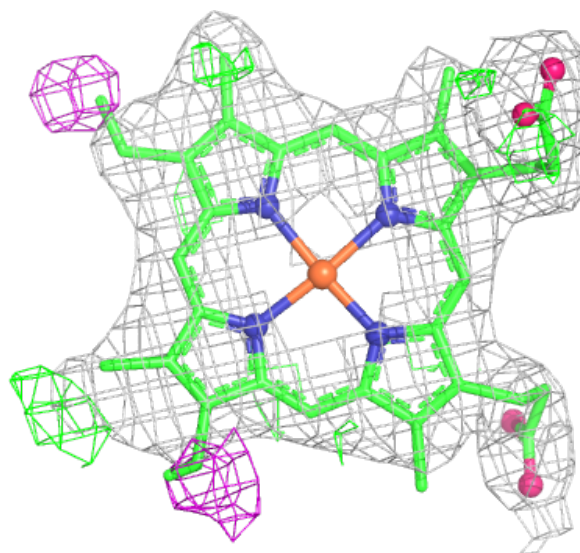

Electron density around HEM B 511:

$2mF_o-DF_c$ (at 0.7 rmsd) in gray
 mF_o-DF_c (at 3 rmsd) in purple (negative)
and green (positive)

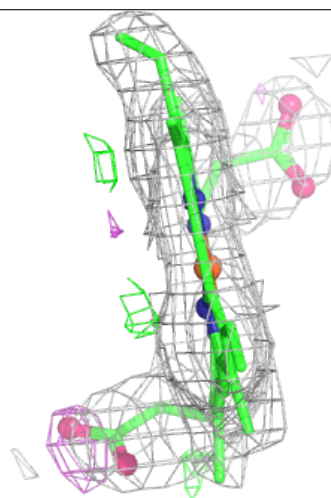
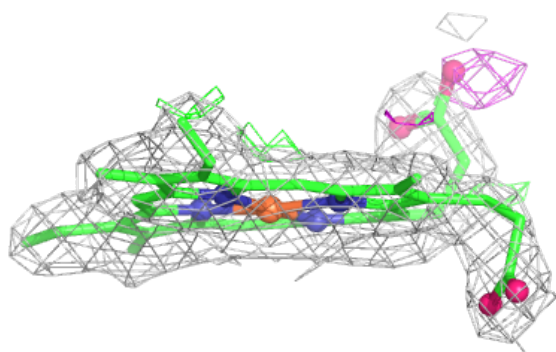
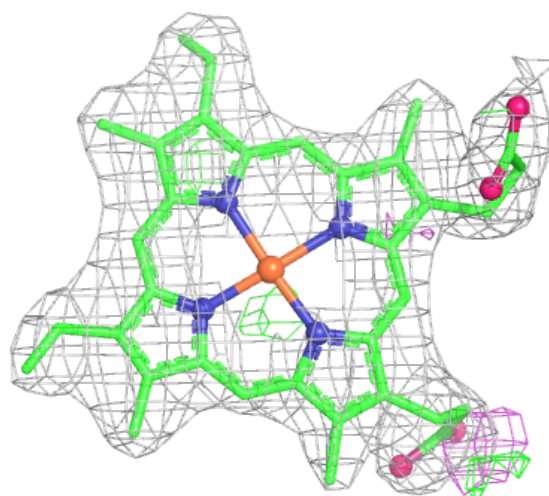

Electron density around HEM A 511:

$2mF_o-DF_c$ (at 0.7 rmsd) in gray
 mF_o-DF_c (at 3 rmsd) in purple (negative)
and green (positive)

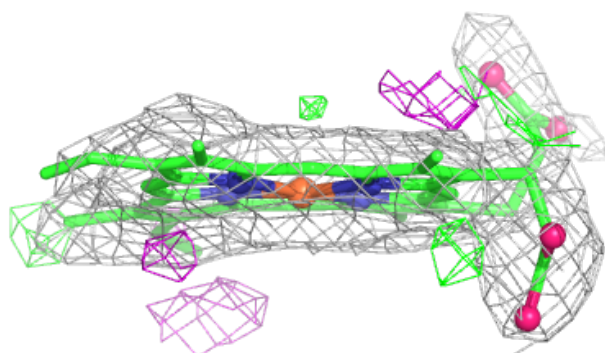
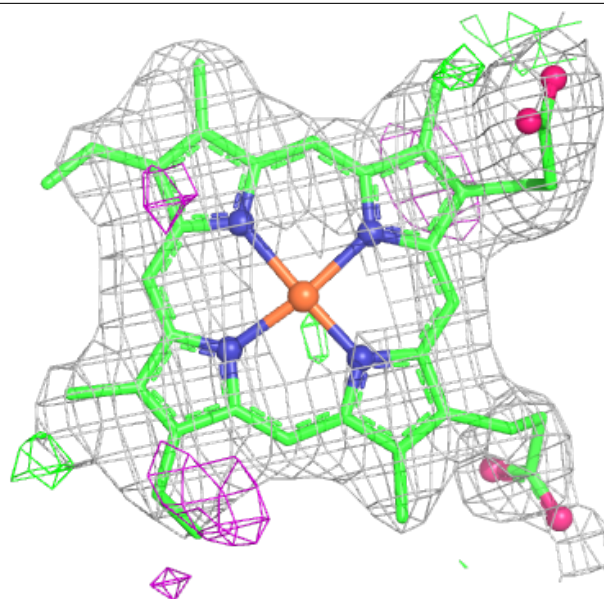

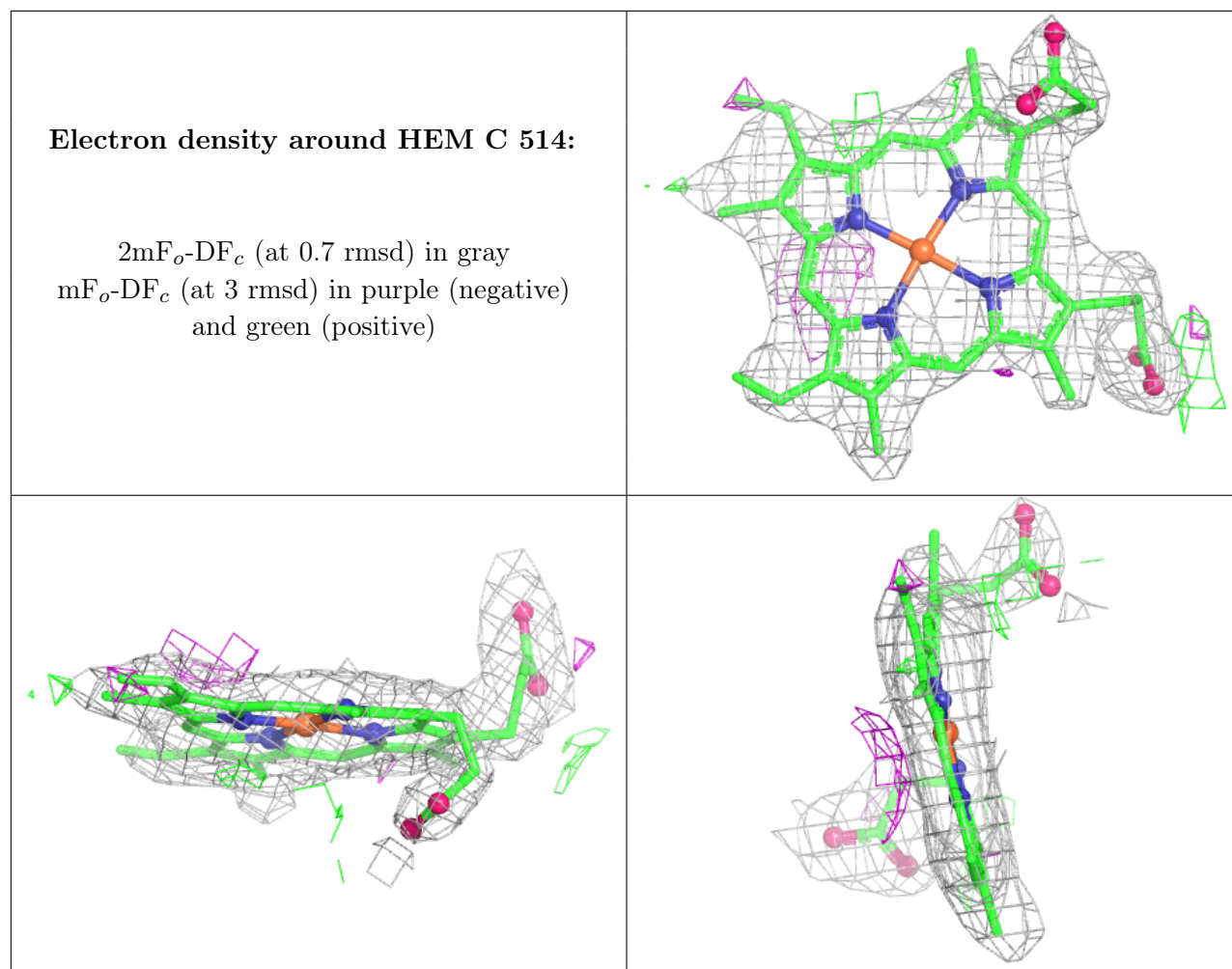

6.5 Other polymers [i](#)

There are no such residues in this entry.