



## wwPDB EM Validation Summary Report ⓘ

Nov 27, 2022 – 05:52 AM EST

PDB ID : 6NFC  
EMDB ID : EMD-7885  
Title : BG505 MD64 N332-GT5 SOSIP trimer in complex with BG18-like precursor HMP42 fragmentantigen binding and base-binding RM20A3 fragment antigen binding  
Authors : Ozorowski, G.; Torres, J.L.; Ward, A.B.  
Deposited on : 2018-12-19  
Resolution : 3.43 Å (reported)  
Based on initial model : 5CEZ

This is a wwPDB EM Validation Summary Report for a publicly released PDB entry.

We welcome your comments at [validation@mail.wwpdb.org](mailto:validation@mail.wwpdb.org)

A user guide is available at

<https://www.wwpdb.org/validation/2017/EMValidationReportHelp>

with specific help available everywhere you see the ⓘ symbol.

The types of validation reports are described at

<http://www.wwpdb.org/validation/2017/FAQs#types>.

---

The following versions of software and data (see [references ⓘ](#)) were used in the production of this report:

EMDB validation analysis : 0.0.1.dev43  
Mogul : 1.8.5 (274361), CSD as541be (2020)  
MolProbity : 4.02b-467  
Percentile statistics : 20191225.v01 (using entries in the PDB archive December 25th 2019)  
MapQ : 1.9.9  
Ideal geometry (proteins) : Engh & Huber (2001)  
Ideal geometry (DNA, RNA) : Parkinson et al. (1996)  
Validation Pipeline (wwPDB-VP) : 2.31.2

# 1 Overall quality at a glance

The following experimental techniques were used to determine the structure:  
*ELECTRON MICROSCOPY*

The reported resolution of this entry is 3.43 Å.

Percentile scores (ranging between 0-100) for global validation metrics of the entry are shown in the following graphic. The table shows the number of entries on which the scores are based.

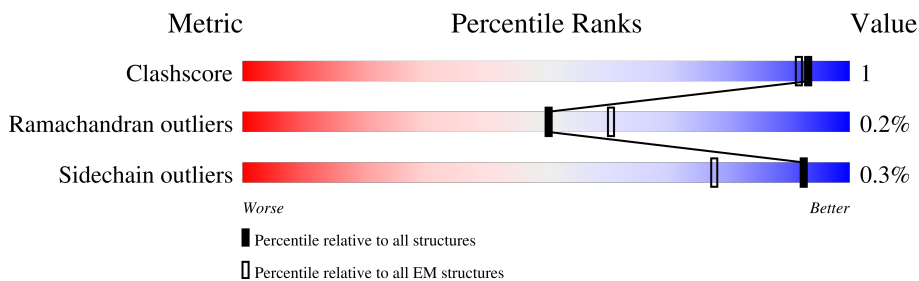

Metric	Whole archive (#Entries)	EM structures (#Entries)
Clashscore	158937	4297
Ramachandran outliers	154571	4023
Sidechain outliers	154315	3826

The table below summarises the geometric issues observed across the polymeric chains and their fit to the map. The red, orange, yellow and green segments of the bar indicate the fraction of residues that contain outliers for  $\geq 3$ , 2, 1 and 0 types of geometric quality criteria respectively. A grey segment represents the fraction of residues that are not modelled. The numeric value for each fraction is indicated below the corresponding segment, with a dot representing fractions  $\leq 5\%$ . The upper red bar (where present) indicates the fraction of residues that have poor fit to the EM map (all-atom inclusion  $< 40\%$ ). The numeric value is given above the bar.

Mol	Chain	Length	Quality of chain
1	C	125	
1	J	125	
1	K	125	
2	D	128	
2	M	128	
2	N	128	
3	A	481	
3	E	481	

Continued on next page...

Continued from previous page...

Mol	Chain	Length	Quality of chain
3	F	481	
4	B	162	
4	G	162	
4	I	162	
5	H	128	
6	L	108	
7	O	2	
7	P	2	
7	R	2	
7	S	2	
7	T	2	
7	U	2	
7	V	2	
7	X	2	
7	Y	2	
7	Z	2	
7	a	2	
7	b	2	
7	d	2	
7	e	2	
7	f	2	
8	Q	4	
8	W	4	
8	c	4	

## 2 Entry composition [i](#)

There are 9 unique types of molecules in this entry. The entry contains 21298 atoms, of which 0 are hydrogens and 0 are deuteriums.

In the tables below, the AltConf column contains the number of residues with at least one atom in alternate conformation and the Trace column contains the number of residues modelled with at most 2 atoms.

- Molecule 1 is a protein called base-binding RM20A3 fragment antigen binding heavy chain.

Mol	Chain	Residues	Atoms					AltConf	Trace
			Total	C	N	O	S		
1	C	123	937	592	160	180	5	0	0
1	J	123	937	592	160	180	5	0	0
1	K	123	937	592	160	180	5	0	0

- Molecule 2 is a protein called base-binding RM20A3 fragment antigen binding light chain.

Mol	Chain	Residues	Atoms					AltConf	Trace
			Total	C	N	O	S		
2	D	109	811	505	136	167	3	0	0
2	M	109	811	505	136	167	3	0	0
2	N	109	811	505	136	167	3	0	0

- Molecule 3 is a protein called HIV-1 Env BG505 MD64 N332-GT5 SOSIP gp120.

Mol	Chain	Residues	Atoms					AltConf	Trace
			Total	C	N	O	S		
3	A	432	3428	2174	600	625	29	0	0
3	E	432	3428	2174	600	625	29	0	0
3	F	432	3428	2174	600	625	29	0	0

- Molecule 4 is a protein called HIV-1 Env BG505 MD64 N332-GT5 SOSIP gp41.

Mol	Chain	Residues	Atoms					AltConf	Trace
			Total	C	N	O	S		
4	B	120	950	597	164	183	6	0	0

*Continued on next page...*

Continued from previous page...

Mol	Chain	Residues	Atoms					AltConf	Trace
4	G	120	Total	C	N	O	S	0	0
			950	597	164	183	6		
4	I	120	Total	C	N	O	S	0	0
			950	597	164	183	6		

- Molecule 5 is a protein called BG18-like precursor HMP42 fragment antigen binding heavy chain.

Mol	Chain	Residues	Atoms					AltConf	Trace
5	H	126	Total	C	N	O	S	0	0
			1013	642	172	192	7		

- Molecule 6 is a protein called BG18-like precursor HMP42 fragment antigen binding light chain.

Mol	Chain	Residues	Atoms					AltConf	Trace
6	L	106	Total	C	N	O	S	0	0
			791	495	128	166	2		

- Molecule 7 is an oligosaccharide called 2-acetamido-2-deoxy-beta-D-glucopyranose-(1-4)-2-acetamido-2-deoxy-beta-D-glucopyranose.



Mol	Chain	Residues	Atoms				AltConf	Trace
7	O	2	Total	C	N	O	0	0
			28	16	2	10		
7	P	2	Total	C	N	O	0	0
			28	16	2	10		
7	R	2	Total	C	N	O	0	0
			28	16	2	10		
7	S	2	Total	C	N	O	0	0
			28	16	2	10		
7	T	2	Total	C	N	O	0	0
			28	16	2	10		
7	U	2	Total	C	N	O	0	0
			28	16	2	10		
7	V	2	Total	C	N	O	0	0
			28	16	2	10		

Continued on next page...

Continued from previous page...

Mol	Chain	Residues	Atoms				AltConf	Trace
7	X	2	Total	C	N	O	0	0
			28	16	2	10		
7	Y	2	Total	C	N	O	0	0
			28	16	2	10		
7	Z	2	Total	C	N	O	0	0
			28	16	2	10		
7	a	2	Total	C	N	O	0	0
			28	16	2	10		
7	b	2	Total	C	N	O	0	0
			28	16	2	10		
7	d	2	Total	C	N	O	0	0
			28	16	2	10		
7	e	2	Total	C	N	O	0	0
			28	16	2	10		
7	f	2	Total	C	N	O	0	0
			28	16	2	10		

- Molecule 8 is an oligosaccharide called alpha-D-mannopyranose-(1-3)-beta-D-mannopyranos e-(1-4)-2-acetamido-2-deoxy-beta-D-glucopyranose-(1-4)-2-acetamido-2-deoxy-beta-D-glucopyranose.



Mol	Chain	Residues	Atoms				AltConf	Trace
8	Q	4	Total	C	N	O	0	0
			50	28	2	20		
8	W	4	Total	C	N	O	0	0
			50	28	2	20		
8	c	4	Total	C	N	O	0	0
			50	28	2	20		

- Molecule 9 is 2-acetamido-2-deoxy-beta-D-glucopyranose (three-letter code: NAG) (formula: C<sub>8</sub>H<sub>15</sub>NO<sub>6</sub>).

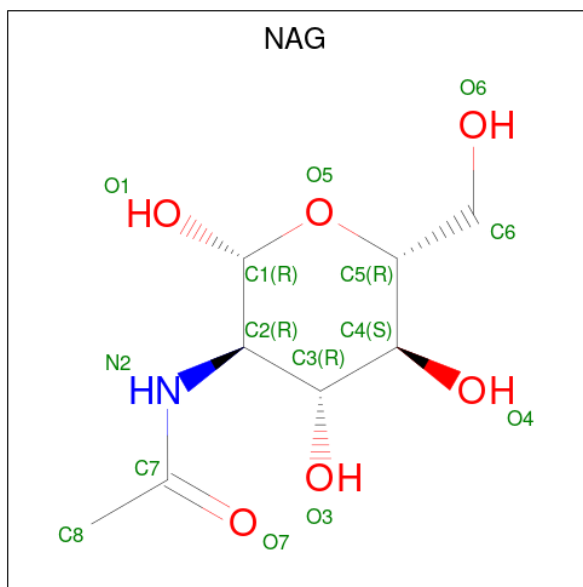

Mol	Chain	Residues	Atoms				AltConf
			Total	C	N	O	
9	A	1	Total	C	N	O	0
			140	80	10	50	
9	A	1	Total	C	N	O	0
			140	80	10	50	
9	A	1	Total	C	N	O	0
			140	80	10	50	
9	A	1	Total	C	N	O	0
			140	80	10	50	
9	A	1	Total	C	N	O	0
			140	80	10	50	
9	A	1	Total	C	N	O	0
			140	80	10	50	
9	A	1	Total	C	N	O	0
			140	80	10	50	
9	A	1	Total	C	N	O	0
			140	80	10	50	
9	A	1	Total	C	N	O	0
			140	80	10	50	
9	B	1	Total	C	N	O	0
			42	24	3	15	
9	B	1	Total	C	N	O	0
			42	24	3	15	
9	B	1	Total	C	N	O	0
			42	24	3	15	
9	E	1	Total	C	N	O	0
			140	80	10	50	

*Continued on next page...*

*Continued from previous page...*

Mol	Chain	Residues	Atoms				AltConf
			Total	C	N	O	
9	E	1	Total 140	C 80	N 10	O 50	0
9	E	1	Total 140	C 80	N 10	O 50	0
9	E	1	Total 140	C 80	N 10	O 50	0
9	E	1	Total 140	C 80	N 10	O 50	0
9	E	1	Total 140	C 80	N 10	O 50	0
9	E	1	Total 140	C 80	N 10	O 50	0
9	E	1	Total 140	C 80	N 10	O 50	0
9	E	1	Total 140	C 80	N 10	O 50	0
9	E	1	Total 140	C 80	N 10	O 50	0
9	E	1	Total 140	C 80	N 10	O 50	0
9	G	1	Total 42	C 24	N 3	O 15	0
9	G	1	Total 42	C 24	N 3	O 15	0
9	G	1	Total 42	C 24	N 3	O 15	0
9	F	1	Total 140	C 80	N 10	O 50	0
9	F	1	Total 140	C 80	N 10	O 50	0
9	F	1	Total 140	C 80	N 10	O 50	0
9	F	1	Total 140	C 80	N 10	O 50	0
9	F	1	Total 140	C 80	N 10	O 50	0
9	F	1	Total 140	C 80	N 10	O 50	0
9	F	1	Total 140	C 80	N 10	O 50	0
9	F	1	Total 140	C 80	N 10	O 50	0
9	F	1	Total 140	C 80	N 10	O 50	0

*Continued on next page...*



*Continued from previous page...*

Mol	Chain	Residues	Atoms				AltConf
			Total	C	N	O	
9	F	1	Total 140	C 80	N 10	O 50	0
9	I	1	Total 42	C 24	N 3	O 15	0
9	I	1	Total 42	C 24	N 3	O 15	0
9	I	1	Total 42	C 24	N 3	O 15	0

### 3 Residue-property plots [i](#)

These plots are drawn for all protein, RNA, DNA and oligosaccharide chains in the entry. The first graphic for a chain summarises the proportions of the various outlier classes displayed in the second graphic. The second graphic shows the sequence view annotated by issues in geometry and atom inclusion in map density. Residues are color-coded according to the number of geometric quality criteria for which they contain at least one outlier: green = 0, yellow = 1, orange = 2 and red = 3 or more. A red diamond above a residue indicates a poor fit to the EM map for this residue (all-atom inclusion < 40%). Stretches of 2 or more consecutive residues without any outlier are shown as a green connector. Residues present in the sample, but not in the model, are shown in grey.

- Molecule 1: base-binding RM20A3 fragment antigen binding heavy chain

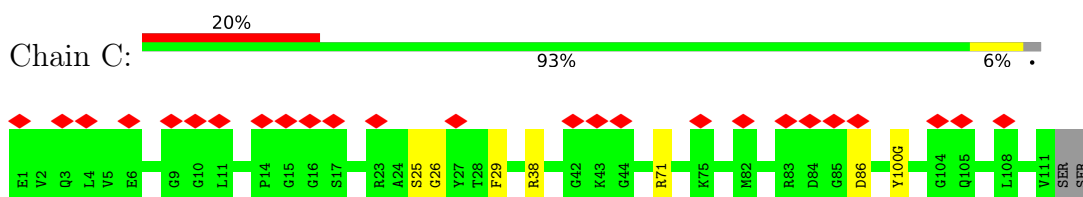

- Molecule 1: base-binding RM20A3 fragment antigen binding heavy chain

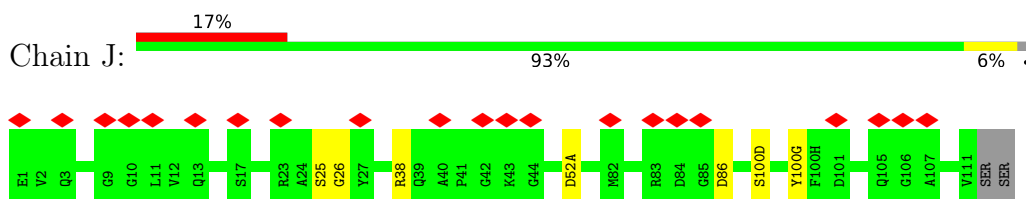

- Molecule 1: base-binding RM20A3 fragment antigen binding heavy chain

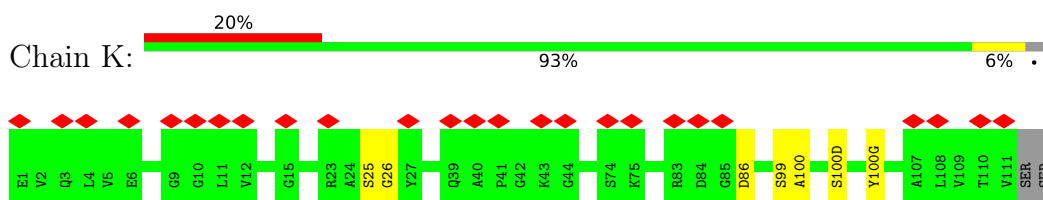

- Molecule 2: base-binding RM20A3 fragment antigen binding light chain

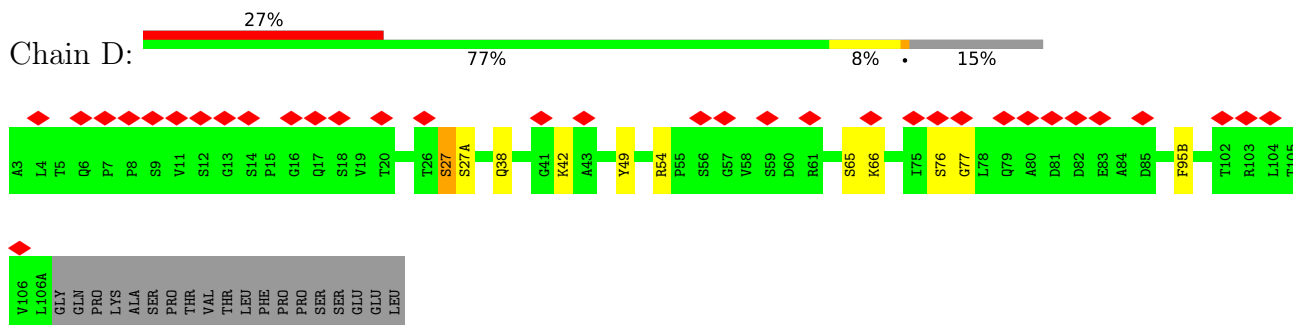

- Molecule 2: base-binding RM20A3 fragment antigen binding light chain

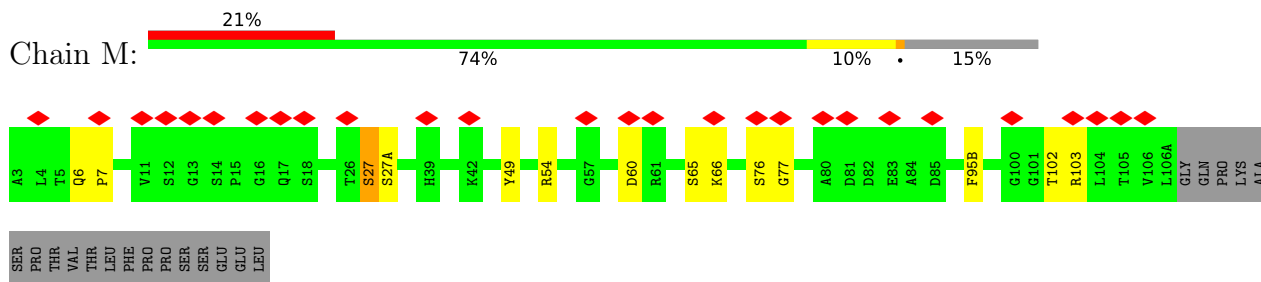

- Molecule 2: base-binding RM20A3 fragment antigen binding light chain

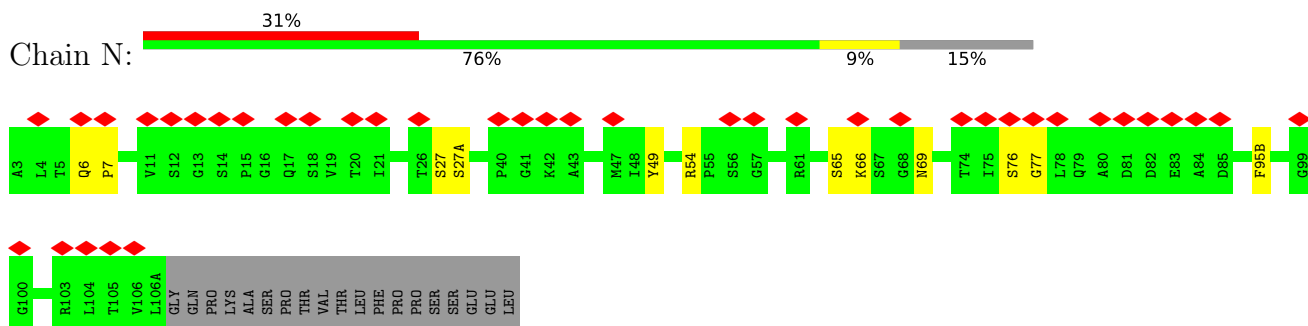

- Molecule 3: HIV-1 Env BG505 MD64 N332-GT5 SOSIP gp120

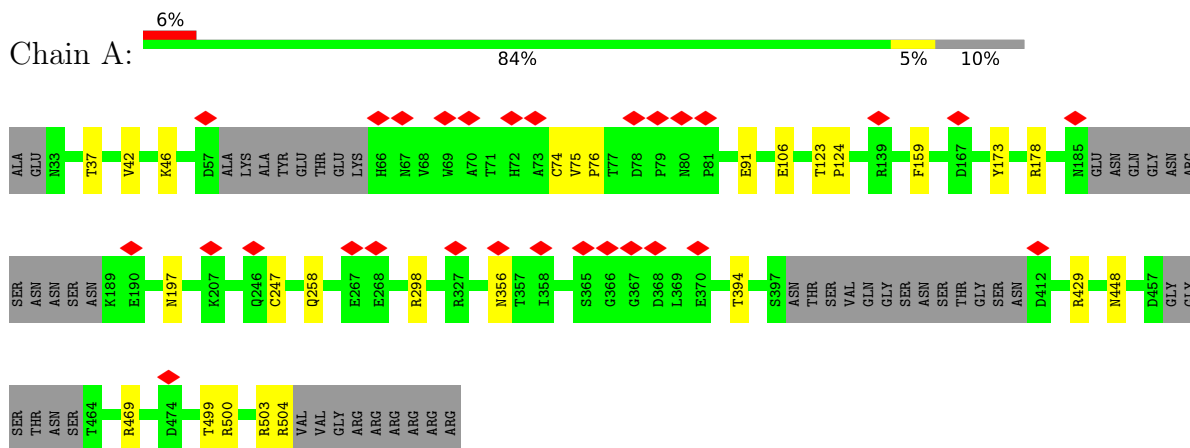

- Molecule 3: HIV-1 Env BG505 MD64 N332-GT5 SOSIP gp120

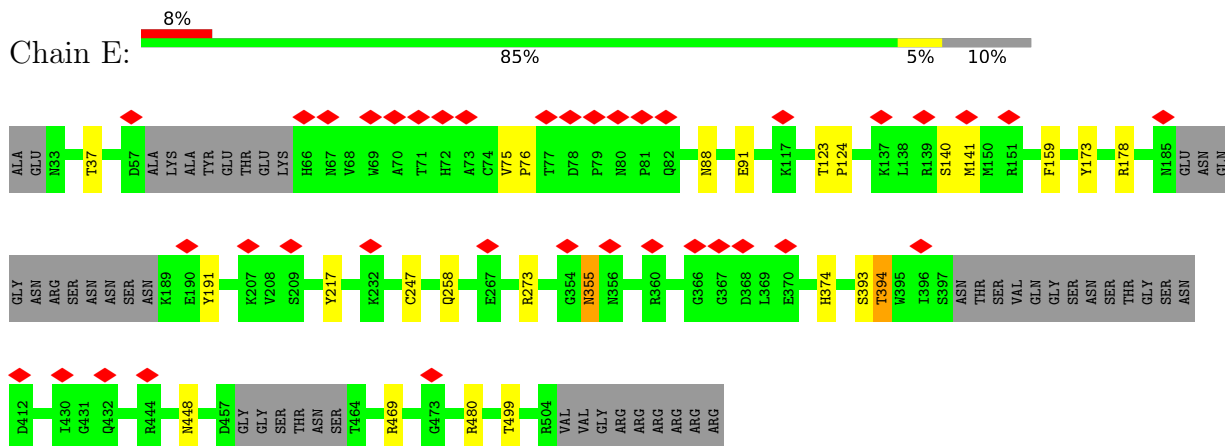

- Molecule 3: HIV-1 Env BG505 MD64 N332-GT5 SOSIP gp120

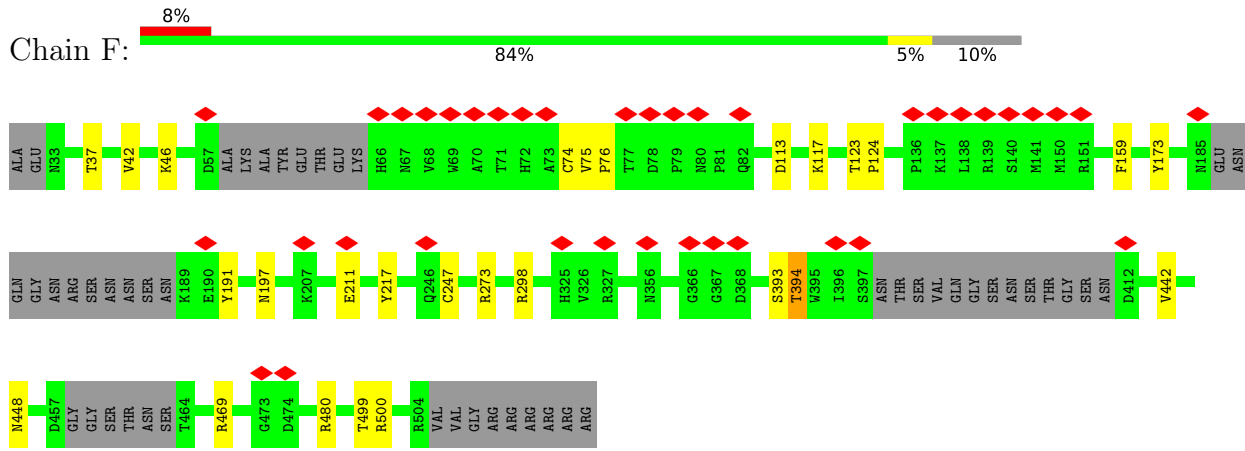

● Molecule 4: HIV-1 Env BG505 MD64 N332-GT5 SOSIP gp41

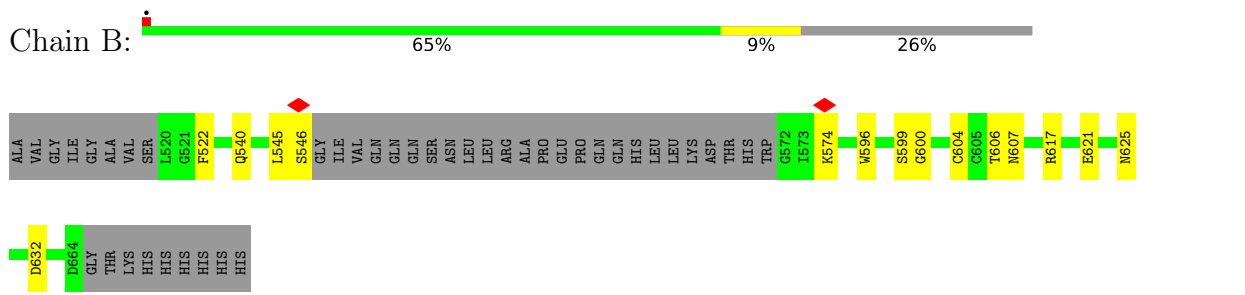

● Molecule 4: HIV-1 Env BG505 MD64 N332-GT5 SOSIP gp41

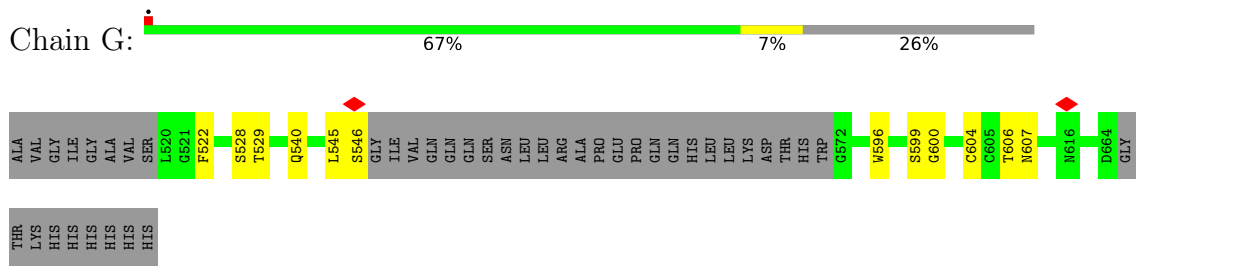

● Molecule 4: HIV-1 Env BG505 MD64 N332-GT5 SOSIP gp41

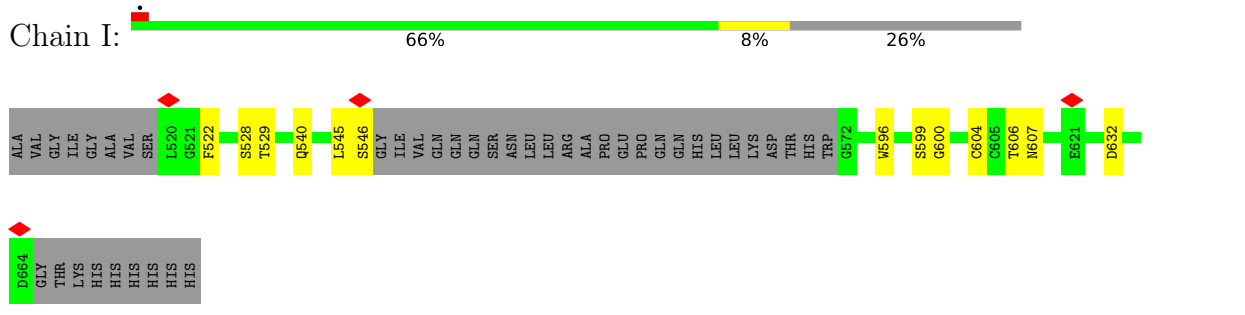

● Molecule 5: BG18-like precursor HMP42 fragment antigen binding heavy chain



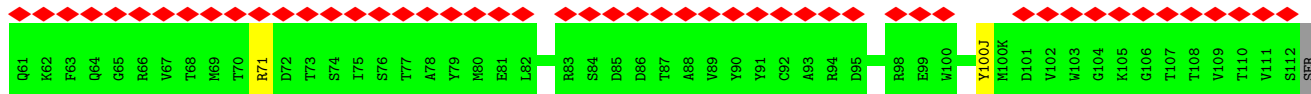
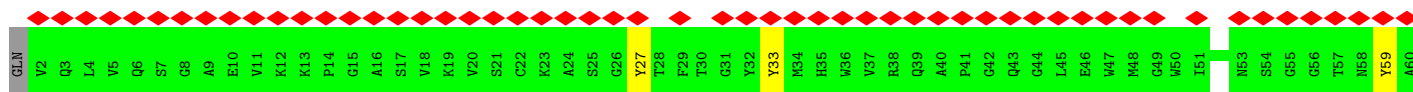

- Molecule 6: BG18-like precursor HMP42 fragment antigen binding light chain

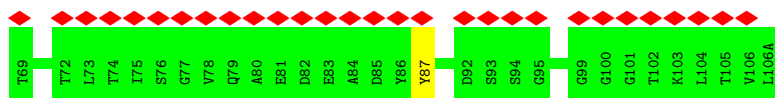
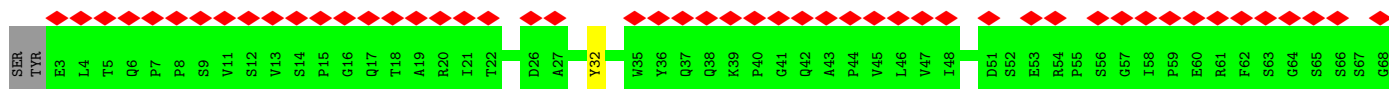
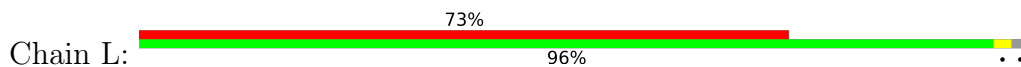

- Molecule 7: 2-acetamido-2-deoxy-beta-D-glucopyranose-(1-4)-2-acetamido-2-deoxy-beta-D-glucopyranose



- Molecule 7: 2-acetamido-2-deoxy-beta-D-glucopyranose-(1-4)-2-acetamido-2-deoxy-beta-D-glucopyranose



- Molecule 7: 2-acetamido-2-deoxy-beta-D-glucopyranose-(1-4)-2-acetamido-2-deoxy-beta-D-glucopyranose



- Molecule 7: 2-acetamido-2-deoxy-beta-D-glucopyranose-(1-4)-2-acetamido-2-deoxy-beta-D-glucopyranose



MAG1  
MAG2

- Molecule 7: 2-acetamido-2-deoxy-beta-D-glucopyranose-(1-4)-2-acetamido-2-deoxy-beta-D-glucopyranose

MAG1  
MAG2

- Molecule 7: 2-acetamido-2-deoxy-beta-D-glucopyranose-(1-4)-2-acetamido-2-deoxy-beta-D-glucopyranose

MAG1  
MAG2

- Molecule 7: 2-acetamido-2-deoxy-beta-D-glucopyranose-(1-4)-2-acetamido-2-deoxy-beta-D-glucopyranose

MAG1  
MAG2

- Molecule 7: 2-acetamido-2-deoxy-beta-D-glucopyranose-(1-4)-2-acetamido-2-deoxy-beta-D-glucopyranose

MAG1  
MAG2

- Molecule 7: 2-acetamido-2-deoxy-beta-D-glucopyranose-(1-4)-2-acetamido-2-deoxy-beta-D-glucopyranose

MAG1  
MAG2

- Molecule 7: 2-acetamido-2-deoxy-beta-D-glucopyranose-(1-4)-2-acetamido-2-deoxy-beta-D-glucopyranose





- Molecule 7: 2-acetamido-2-deoxy-beta-D-glucopyranose-(1-4)-2-acetamido-2-deoxy-beta-D-glucopyranose



- Molecule 7: 2-acetamido-2-deoxy-beta-D-glucopyranose-(1-4)-2-acetamido-2-deoxy-beta-D-glucopyranose



- Molecule 7: 2-acetamido-2-deoxy-beta-D-glucopyranose-(1-4)-2-acetamido-2-deoxy-beta-D-glucopyranose



- Molecule 7: 2-acetamido-2-deoxy-beta-D-glucopyranose-(1-4)-2-acetamido-2-deoxy-beta-D-glucopyranose



- Molecule 7: 2-acetamido-2-deoxy-beta-D-glucopyranose-(1-4)-2-acetamido-2-deoxy-beta-D-glucopyranose



- Molecule 8: alpha-D-mannopyranose-(1-3)-beta-D-mannopyranose-(1-4)-2-acetamido-2-deoxy-beta-D-glucopyranose-(1-4)-2-acetamido-2-deoxy-beta-D-glucopyranose



- Molecule 8: alpha-D-mannopyranose-(1-3)-beta-D-mannopyranose-(1-4)-2-acetamido-2-deoxy-beta-D-glucopyranose-(1-4)-2-acetamido-2-deoxy-beta-D-glucopyranose



- Molecule 8: alpha-D-mannopyranose-(1-3)-beta-D-mannopyranose-(1-4)-2-acetamido-2-deoxy-beta-D-glucopyranose-(1-4)-2-acetamido-2-deoxy-beta-D-glucopyranose





## 4 Experimental information

Property	Value	Source
EM reconstruction method	SINGLE PARTICLE	Depositor
Imposed symmetry	POINT, C1	Depositor
Number of particles used	154118	Depositor
Resolution determination method	FSC 0.143 CUT-OFF	Depositor
CTF correction method	PHASE FLIPPING AND AMPLITUDE CORRECTION	Depositor
Microscope	FEI TITAN KRIOS	Depositor
Voltage (kV)	300	Depositor
Electron dose ( $e^-/\text{\AA}^2$ )	50	Depositor
Minimum defocus (nm)	400	Depositor
Maximum defocus (nm)	2500	Depositor
Magnification	29000	Depositor
Image detector	GATAN K2 SUMMIT (4k x 4k)	Depositor
Maximum map value	0.135	Depositor
Minimum map value	-0.068	Depositor
Average map value	0.000	Depositor
Map value standard deviation	0.004	Depositor
Recommended contour level	0.03	Depositor
Map size ( $\text{\AA}$ )	329.59998, 329.59998, 329.59998	wwPDB
Map dimensions	320, 320, 320	wwPDB
Map angles ( $^\circ$ )	90.0, 90.0, 90.0	wwPDB
Pixel spacing ( $\text{\AA}$ )	1.03, 1.03, 1.03	Depositor

## 5 Model quality i

### 5.1 Standard geometry i

Bond lengths and bond angles in the following residue types are not validated in this section: NAG, MAN, BMA

The Z score for a bond length (or angle) is the number of standard deviations the observed value is removed from the expected value. A bond length (or angle) with  $|Z| > 5$  is considered an outlier worth inspection. RMSZ is the root-mean-square of all Z scores of the bond lengths (or angles).

Mol	Chain	Bond lengths		Bond angles	
		RMSZ	# Z  >5	RMSZ	# Z  >5
1	C	1.17	4/957 (0.4%)	0.98	3/1292 (0.2%)
1	J	1.12	2/957 (0.2%)	0.98	3/1292 (0.2%)
1	K	1.11	2/957 (0.2%)	0.99	2/1292 (0.2%)
2	D	1.05	2/830 (0.2%)	1.00	1/1129 (0.1%)
2	M	1.04	2/830 (0.2%)	1.00	1/1129 (0.1%)
2	N	1.05	2/830 (0.2%)	1.01	1/1129 (0.1%)
3	A	1.17	6/3505 (0.2%)	0.90	6/4756 (0.1%)
3	E	1.13	6/3505 (0.2%)	0.91	9/4756 (0.2%)
3	F	1.13	7/3505 (0.2%)	0.91	8/4756 (0.2%)
4	B	1.30	6/966 (0.6%)	0.82	1/1309 (0.1%)
4	G	1.29	5/966 (0.5%)	0.81	0/1309
4	I	1.31	5/966 (0.5%)	0.81	0/1309
5	H	1.10	1/1041 (0.1%)	1.03	3/1411 (0.2%)
6	L	1.00	1/809 (0.1%)	0.95	1/1103 (0.1%)
All	All	1.15	51/20624 (0.2%)	0.92	39/27972 (0.1%)

The worst 5 of 51 bond length outliers are listed below:

Mol	Chain	Res	Type	Atoms	Z	Observed(Å)	Ideal(Å)
3	A	159	PHE	CB-CG	-9.81	1.34	1.51
3	A	74	CYS	CB-SG	-7.80	1.69	1.82
3	F	247	CYS	CB-SG	-7.06	1.70	1.82
3	A	247	CYS	CB-SG	-7.03	1.70	1.82
4	B	604	CYS	CB-SG	-6.98	1.70	1.82

The worst 5 of 39 bond angle outliers are listed below:

Mol	Chain	Res	Type	Atoms	Z	Observed(°)	Ideal(°)
3	F	298	ARG	NE-CZ-NH2	-8.87	115.86	120.30
5	H	100(J)	TYR	CB-CG-CD1	-8.36	115.98	121.00

*Continued on next page...*

*Continued from previous page...*

Mol	Chain	Res	Type	Atoms	Z	Observed(°)	Ideal(°)
3	F	159	PHE	CB-CA-C	-8.33	93.73	110.40
3	E	159	PHE	CB-CA-C	-8.16	94.07	110.40
3	E	178	ARG	NE-CZ-NH2	-8.10	116.25	120.30

There are no chirality outliers.

There are no planarity outliers.

## 5.2 Too-close contacts [i](#)

In the following table, the Non-H and H(model) columns list the number of non-hydrogen atoms and hydrogen atoms in the chain respectively. The H(added) column lists the number of hydrogen atoms added and optimized by MolProbity. The Clashes column lists the number of clashes within the asymmetric unit, whereas Symm-Clashes lists symmetry-related clashes.

Mol	Chain	Non-H	H(model)	H(added)	Clashes	Symm-Clashes
1	C	937	0	910	1	0
1	J	937	0	910	3	0
1	K	937	0	910	3	0
2	D	811	0	767	4	0
2	M	811	0	767	6	0
2	N	811	0	767	6	0
3	A	3428	0	3387	8	0
3	E	3428	0	3387	7	0
3	F	3428	0	3387	8	0
4	B	950	0	921	6	0
4	G	950	0	921	4	0
4	I	950	0	921	5	0
5	H	1013	0	956	0	0
6	L	791	0	758	0	0
7	O	28	0	25	0	0
7	P	28	0	25	0	0
7	R	28	0	25	0	0
7	S	28	0	25	0	0
7	T	28	0	25	0	0
7	U	28	0	25	0	0
7	V	28	0	25	0	0
7	X	28	0	25	0	0
7	Y	28	0	25	0	0
7	Z	28	0	25	0	0
7	a	28	0	25	0	0
7	b	28	0	25	0	0

*Continued on next page...*

Continued from previous page...

Mol	Chain	Non-H	H(model)	H(added)	Clashes	Symm-Clashes
7	d	28	0	25	0	0
7	e	28	0	25	0	0
7	f	28	0	25	0	0
8	Q	50	0	41	0	0
8	W	50	0	41	0	0
8	c	50	0	41	0	0
9	A	140	0	130	0	0
9	B	42	0	39	0	0
9	E	140	0	130	0	0
9	F	140	0	130	1	0
9	G	42	0	39	0	0
9	I	42	0	39	0	0
All	All	21298	0	20674	56	0

The all-atom clashscore is defined as the number of clashes found per 1000 atoms (including hydrogen atoms). The all-atom clashscore for this structure is 1.

The worst 5 of 56 close contacts within the same asymmetric unit are listed below, sorted by their clash magnitude.

Atom-1	Atom-2	Interatomic distance (Å)	Clash overlap (Å)
1:J:52(A):ASP:N	1:J:52(A):ASP:OD1	2.32	0.61
3:E:355:ASN:N	3:E:355:ASN:OD1	2.33	0.60
3:A:123:THR:N	3:A:124:PRO:CD	2.68	0.56
3:E:123:THR:N	3:E:124:PRO:CD	2.69	0.55
3:E:37:THR:OG1	3:E:499:THR:OG1	2.19	0.55

There are no symmetry-related clashes.

## 5.3 Torsion angles [i](#)

### 5.3.1 Protein backbone [i](#)

In the following table, the Percentiles column shows the percent Ramachandran outliers of the chain as a percentile score with respect to all PDB entries followed by that with respect to all EM entries.

The Analysed column shows the number of residues for which the backbone conformation was analysed, and the total number of residues.

Mol	Chain	Analysed	Favoured	Allowed	Outliers	Percentiles	
1	C	121/125 (97%)	118 (98%)	3 (2%)	0	100	100
1	J	121/125 (97%)	120 (99%)	1 (1%)	0	100	100
1	K	121/125 (97%)	119 (98%)	2 (2%)	0	100	100
2	D	107/128 (84%)	98 (92%)	8 (8%)	1 (1%)	17	54
2	M	107/128 (84%)	97 (91%)	9 (8%)	1 (1%)	17	54
2	N	107/128 (84%)	97 (91%)	10 (9%)	0	100	100
3	A	422/481 (88%)	409 (97%)	12 (3%)	1 (0%)	47	80
3	E	422/481 (88%)	410 (97%)	11 (3%)	1 (0%)	47	80
3	F	422/481 (88%)	410 (97%)	11 (3%)	1 (0%)	47	80
4	B	116/162 (72%)	109 (94%)	7 (6%)	0	100	100
4	G	116/162 (72%)	112 (97%)	4 (3%)	0	100	100
4	I	116/162 (72%)	110 (95%)	6 (5%)	0	100	100
5	H	124/128 (97%)	119 (96%)	5 (4%)	0	100	100
6	L	104/108 (96%)	101 (97%)	3 (3%)	0	100	100
All	All	2526/2924 (86%)	2429 (96%)	92 (4%)	5 (0%)	50	80

All (5) Ramachandran outliers are listed below:

Mol	Chain	Res	Type
3	A	394	THR
3	E	394	THR
3	F	394	THR
2	D	27	SER
2	M	27	SER

### 5.3.2 Protein sidechains [i](#)

In the following table, the Percentiles column shows the percent sidechain outliers of the chain as a percentile score with respect to all PDB entries followed by that with respect to all EM entries.

The Analysed column shows the number of residues for which the sidechain conformation was analysed, and the total number of residues.

Mol	Chain	Analysed	Rotameric	Outliers	Percentiles	
1	C	100/102 (98%)	100 (100%)	0	100	100
1	J	100/102 (98%)	100 (100%)	0	100	100

*Continued on next page...*

Continued from previous page...

Mol	Chain	Analysed	Rotameric	Outliers	Percentiles	
1	K	100/102 (98%)	100 (100%)	0	100	100
2	D	89/106 (84%)	89 (100%)	0	100	100
2	M	89/106 (84%)	89 (100%)	0	100	100
2	N	89/106 (84%)	89 (100%)	0	100	100
3	A	388/428 (91%)	386 (100%)	2 (0%)	88	95
3	E	388/428 (91%)	386 (100%)	2 (0%)	88	95
3	F	388/428 (91%)	386 (100%)	2 (0%)	88	95
4	B	103/138 (75%)	103 (100%)	0	100	100
4	G	103/138 (75%)	103 (100%)	0	100	100
4	I	103/138 (75%)	103 (100%)	0	100	100
5	H	105/107 (98%)	104 (99%)	1 (1%)	76	89
6	L	88/90 (98%)	88 (100%)	0	100	100
All	All	2233/2519 (89%)	2226 (100%)	7 (0%)	92	98

5 of 7 residues with a non-rotameric sidechain are listed below:

Mol	Chain	Res	Type
3	E	355	ASN
3	E	448	ASN
3	F	448	ASN
3	F	197	ASN
5	H	71	ARG

Sometimes sidechains can be flipped to improve hydrogen bonding and reduce clashes. All (2) such sidechains are listed below:

Mol	Chain	Res	Type
3	E	422	GLN
3	F	422	GLN

### 5.3.3 RNA [i](#)

There are no RNA molecules in this entry.

## 5.4 Non-standard residues in protein, DNA, RNA chains [i](#)

There are no non-standard protein/DNA/RNA residues in this entry.

## 5.5 Carbohydrates i

42 monosaccharides are modelled in this entry.

In the following table, the Counts columns list the number of bonds (or angles) for which Mogul statistics could be retrieved, the number of bonds (or angles) that are observed in the model and the number of bonds (or angles) that are defined in the Chemical Component Dictionary. The Link column lists molecule types, if any, to which the group is linked. The Z score for a bond length (or angle) is the number of standard deviations the observed value is removed from the expected value. A bond length (or angle) with  $|Z| > 2$  is considered an outlier worth inspection. RMSZ is the root-mean-square of all Z scores of the bond lengths (or angles).

Mol	Type	Chain	Res	Link	Bond lengths			Bond angles		
					Counts	RMSZ	# Z  > 2	Counts	RMSZ	# Z  > 2
7	NAG	O	1	3,7	14,14,15	2.03	2 (14%)	17,19,21	1.25	1 (5%)
7	NAG	O	2	7	14,14,15	2.20	2 (14%)	17,19,21	0.86	1 (5%)
7	NAG	P	1	3,7	14,14,15	2.03	4 (28%)	17,19,21	1.26	2 (11%)
7	NAG	P	2	7	14,14,15	2.18	2 (14%)	17,19,21	0.86	1 (5%)
8	NAG	Q	1	3,8	14,14,15	2.03	2 (14%)	17,19,21	0.98	2 (11%)
8	NAG	Q	2	8	14,14,15	2.08	3 (21%)	17,19,21	1.10	1 (5%)
8	BMA	Q	3	8	11,11,12	1.81	2 (18%)	15,15,17	1.10	1 (6%)
8	MAN	Q	4	8	11,11,12	1.80	2 (18%)	15,15,17	1.07	2 (13%)
7	NAG	R	1	3,7	14,14,15	2.09	4 (28%)	17,19,21	0.97	1 (5%)
7	NAG	R	2	7	14,14,15	2.21	2 (14%)	17,19,21	0.80	1 (5%)
7	NAG	S	1	3,7	14,14,15	2.00	2 (14%)	17,19,21	1.06	2 (11%)
7	NAG	S	2	7	14,14,15	2.12	3 (21%)	17,19,21	1.15	1 (5%)
7	NAG	T	1	4,7	14,14,15	2.15	3 (21%)	17,19,21	1.16	2 (11%)
7	NAG	T	2	7	14,14,15	2.21	3 (21%)	17,19,21	0.88	1 (5%)
7	NAG	U	1	3,7	14,14,15	2.04	2 (14%)	17,19,21	1.10	1 (5%)
7	NAG	U	2	7	14,14,15	2.22	2 (14%)	17,19,21	0.90	1 (5%)
7	NAG	V	1	3,7	14,14,15	2.03	4 (28%)	17,19,21	2.35	5 (29%)
7	NAG	V	2	7	14,14,15	2.21	2 (14%)	17,19,21	0.87	1 (5%)
8	NAG	W	1	3,8	14,14,15	1.95	2 (14%)	17,19,21	1.22	1 (5%)
8	NAG	W	2	8	14,14,15	2.09	3 (21%)	17,19,21	1.09	2 (11%)
8	BMA	W	3	8	11,11,12	1.86	2 (18%)	15,15,17	0.96	1 (6%)
8	MAN	W	4	8	11,11,12	1.81	2 (18%)	15,15,17	1.12	2 (13%)
7	NAG	X	1	3,7	14,14,15	2.01	3 (21%)	17,19,21	0.99	1 (5%)
7	NAG	X	2	7	14,14,15	2.21	2 (14%)	17,19,21	0.79	1 (5%)
7	NAG	Y	1	3,7	14,14,15	2.04	2 (14%)	17,19,21	0.96	1 (5%)
7	NAG	Y	2	7	14,14,15	2.16	2 (14%)	17,19,21	0.85	1 (5%)

Mol	Type	Chain	Res	Link	Bond lengths			Bond angles		
					Counts	RMSZ	# Z  > 2	Counts	RMSZ	# Z  > 2
7	NAG	Z	1	4,7	14,14,15	2.15	3 (21%)	17,19,21	1.11	2 (11%)
7	NAG	Z	2	7	14,14,15	2.18	2 (14%)	17,19,21	0.83	1 (5%)
7	NAG	a	1	3,7	14,14,15	2.08	2 (14%)	17,19,21	1.16	1 (5%)
7	NAG	a	2	7	14,14,15	2.23	2 (14%)	17,19,21	0.84	1 (5%)
7	NAG	b	1	3,7	14,14,15	2.02	3 (21%)	17,19,21	1.20	1 (5%)
7	NAG	b	2	7	14,14,15	2.17	2 (14%)	17,19,21	0.77	0
8	NAG	c	1	3,8	14,14,15	1.98	2 (14%)	17,19,21	1.13	2 (11%)
8	NAG	c	2	8	14,14,15	2.13	2 (14%)	17,19,21	1.29	2 (11%)
8	BMA	c	3	8	11,11,12	1.86	2 (18%)	15,15,17	1.25	1 (6%)
8	MAN	c	4	8	11,11,12	1.81	2 (18%)	15,15,17	1.16	3 (20%)
7	NAG	d	1	3,7	14,14,15	2.14	4 (28%)	17,19,21	0.86	1 (5%)
7	NAG	d	2	7	14,14,15	2.19	2 (14%)	17,19,21	0.81	0
7	NAG	e	1	3,7	14,14,15	2.00	3 (21%)	17,19,21	0.99	1 (5%)
7	NAG	e	2	7	14,14,15	2.22	2 (14%)	17,19,21	0.77	1 (5%)
7	NAG	f	1	4,7	14,14,15	2.14	3 (21%)	17,19,21	1.15	3 (17%)
7	NAG	f	2	7	14,14,15	2.19	2 (14%)	17,19,21	0.83	1 (5%)

In the following table, the Chirals column lists the number of chiral outliers, the number of chiral centers analysed, the number of these observed in the model and the number defined in the Chemical Component Dictionary. Similar counts are reported in the Torsion and Rings columns. <sup>1,2</sup> means no outliers of that kind were identified.

Mol	Type	Chain	Res	Link	Chirals	Torsions	Rings
7	NAG	O	1	3,7	-	0/6/23/26	0/1/1/1
7	NAG	O	2	7	-	2/6/23/26	0/1/1/1
7	NAG	P	1	3,7	-	0/6/23/26	0/1/1/1
7	NAG	P	2	7	-	2/6/23/26	0/1/1/1
8	NAG	Q	1	3,8	-	0/6/23/26	0/1/1/1
8	NAG	Q	2	8	-	2/6/23/26	0/1/1/1
8	BMA	Q	3	8	-	1/2/19/22	0/1/1/1
8	MAN	Q	4	8	-	1/2/19/22	0/1/1/1
7	NAG	R	1	3,7	-	0/6/23/26	0/1/1/1
7	NAG	R	2	7	-	2/6/23/26	0/1/1/1
7	NAG	S	1	3,7	-	1/6/23/26	0/1/1/1
7	NAG	S	2	7	-	2/6/23/26	0/1/1/1
7	NAG	T	1	4,7	-	1/6/23/26	0/1/1/1
7	NAG	T	2	7	-	1/6/23/26	0/1/1/1
7	NAG	U	1	3,7	-	0/6/23/26	0/1/1/1

Continued on next page...



Continued from previous page...

Mol	Type	Chain	Res	Link	Chirals	Torsions	Rings
7	NAG	U	2	7	-	2/6/23/26	0/1/1/1
7	NAG	V	1	3,7	-	0/6/23/26	0/1/1/1
7	NAG	V	2	7	-	2/6/23/26	0/1/1/1
8	NAG	W	1	3,8	-	0/6/23/26	0/1/1/1
8	NAG	W	2	8	-	2/6/23/26	0/1/1/1
8	BMA	W	3	8	-	1/2/19/22	0/1/1/1
8	MAN	W	4	8	-	1/2/19/22	0/1/1/1
7	NAG	X	1	3,7	-	2/6/23/26	0/1/1/1
7	NAG	X	2	7	-	1/6/23/26	0/1/1/1
7	NAG	Y	1	3,7	-	0/6/23/26	0/1/1/1
7	NAG	Y	2	7	-	2/6/23/26	0/1/1/1
7	NAG	Z	1	4,7	-	2/6/23/26	0/1/1/1
7	NAG	Z	2	7	-	1/6/23/26	0/1/1/1
7	NAG	a	1	3,7	-	0/6/23/26	0/1/1/1
7	NAG	a	2	7	-	1/6/23/26	0/1/1/1
7	NAG	b	1	3,7	-	0/6/23/26	0/1/1/1
7	NAG	b	2	7	-	2/6/23/26	0/1/1/1
8	NAG	c	1	3,8	-	0/6/23/26	0/1/1/1
8	NAG	c	2	8	-	2/6/23/26	0/1/1/1
8	BMA	c	3	8	-	1/2/19/22	0/1/1/1
8	MAN	c	4	8	-	1/2/19/22	0/1/1/1
7	NAG	d	1	3,7	-	0/6/23/26	0/1/1/1
7	NAG	d	2	7	-	1/6/23/26	0/1/1/1
7	NAG	e	1	3,7	-	0/6/23/26	0/1/1/1
7	NAG	e	2	7	-	1/6/23/26	0/1/1/1
7	NAG	f	1	4,7	-	1/6/23/26	0/1/1/1
7	NAG	f	2	7	-	2/6/23/26	0/1/1/1

The worst 5 of 102 bond length outliers are listed below:

Mol	Chain	Res	Type	Atoms	Z	Observed(Å)	Ideal(Å)
7	e	2	NAG	O5-C1	7.17	1.55	1.43
7	V	2	NAG	O5-C1	7.13	1.55	1.43
7	R	2	NAG	O5-C1	7.13	1.55	1.43
7	P	2	NAG	O5-C1	7.10	1.55	1.43
7	a	2	NAG	O5-C1	7.10	1.55	1.43

The worst 5 of 58 bond angle outliers are listed below:

Mol	Chain	Res	Type	Atoms	Z	Observed( $^{\circ}$ )	Ideal( $^{\circ}$ )
7	V	1	NAG	O4-C4-C3	-5.08	98.61	110.35
7	V	1	NAG	O5-C5-C6	-4.72	99.80	107.20
7	V	1	NAG	C1-O5-C5	-3.88	106.93	112.19
7	a	1	NAG	C3-C4-C5	-3.49	104.01	110.24
7	O	1	NAG	C3-C4-C5	-3.47	104.05	110.24

There are no chirality outliers.

5 of 43 torsion outliers are listed below:

Mol	Chain	Res	Type	Atoms
7	O	2	NAG	C4-C5-C6-O6
7	P	2	NAG	C4-C5-C6-O6
7	U	2	NAG	C4-C5-C6-O6
7	V	2	NAG	O5-C5-C6-O6
7	S	2	NAG	C4-C5-C6-O6

There are no ring outliers.

No monomer is involved in short contacts.

The following is a two-dimensional graphical depiction of Mogul quality analysis of bond lengths, bond angles, torsion angles, and ring geometry for oligosaccharide.

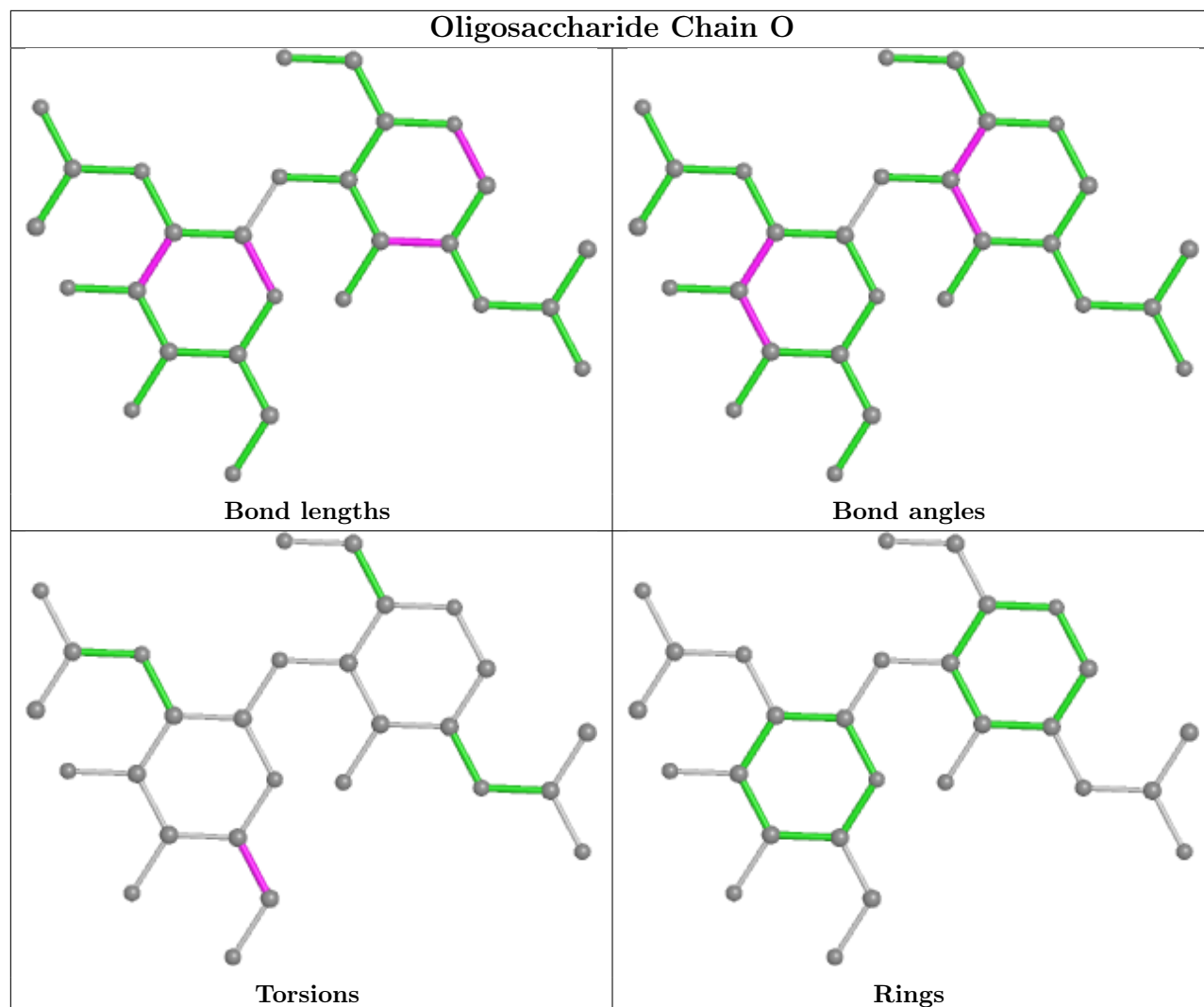

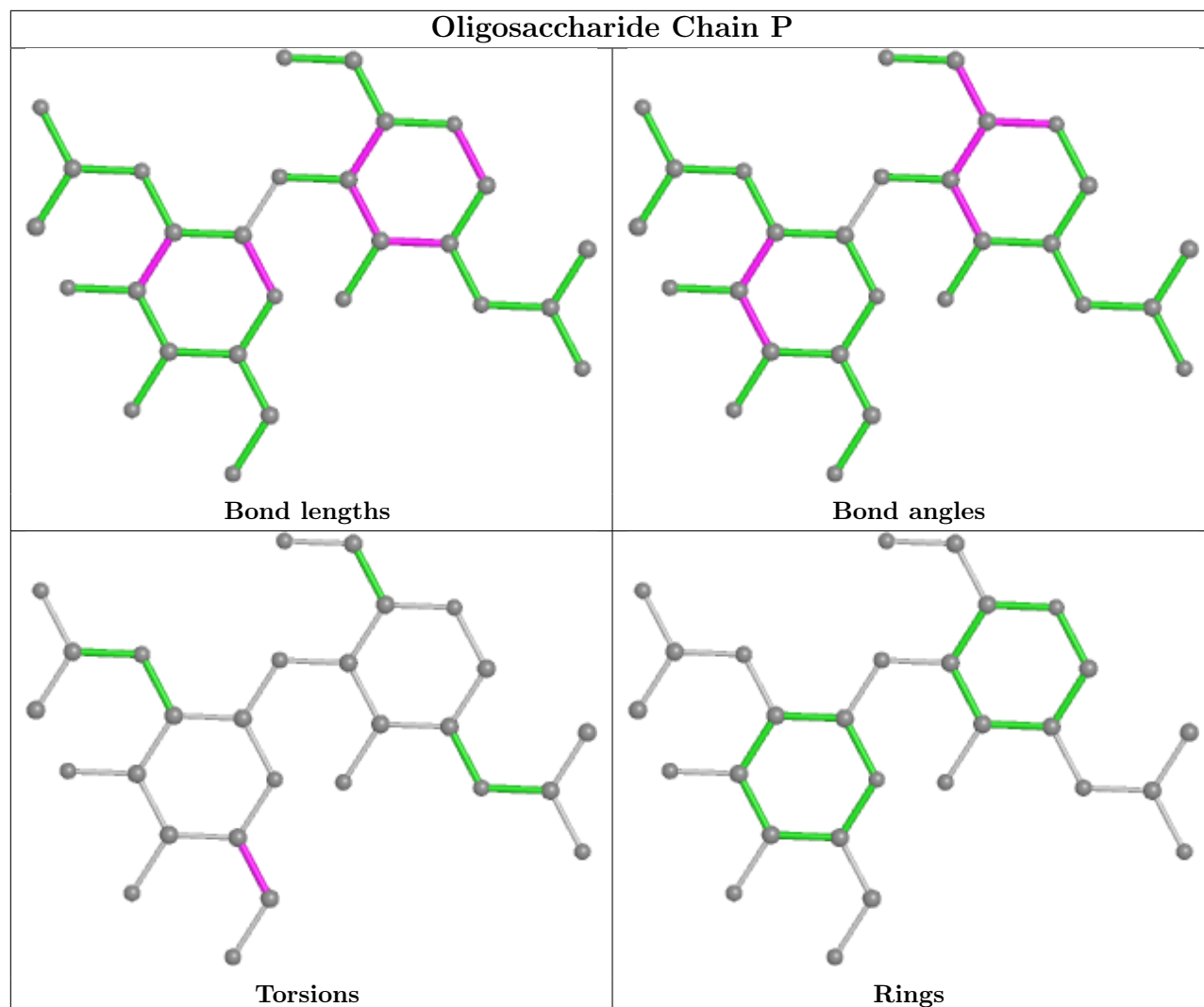

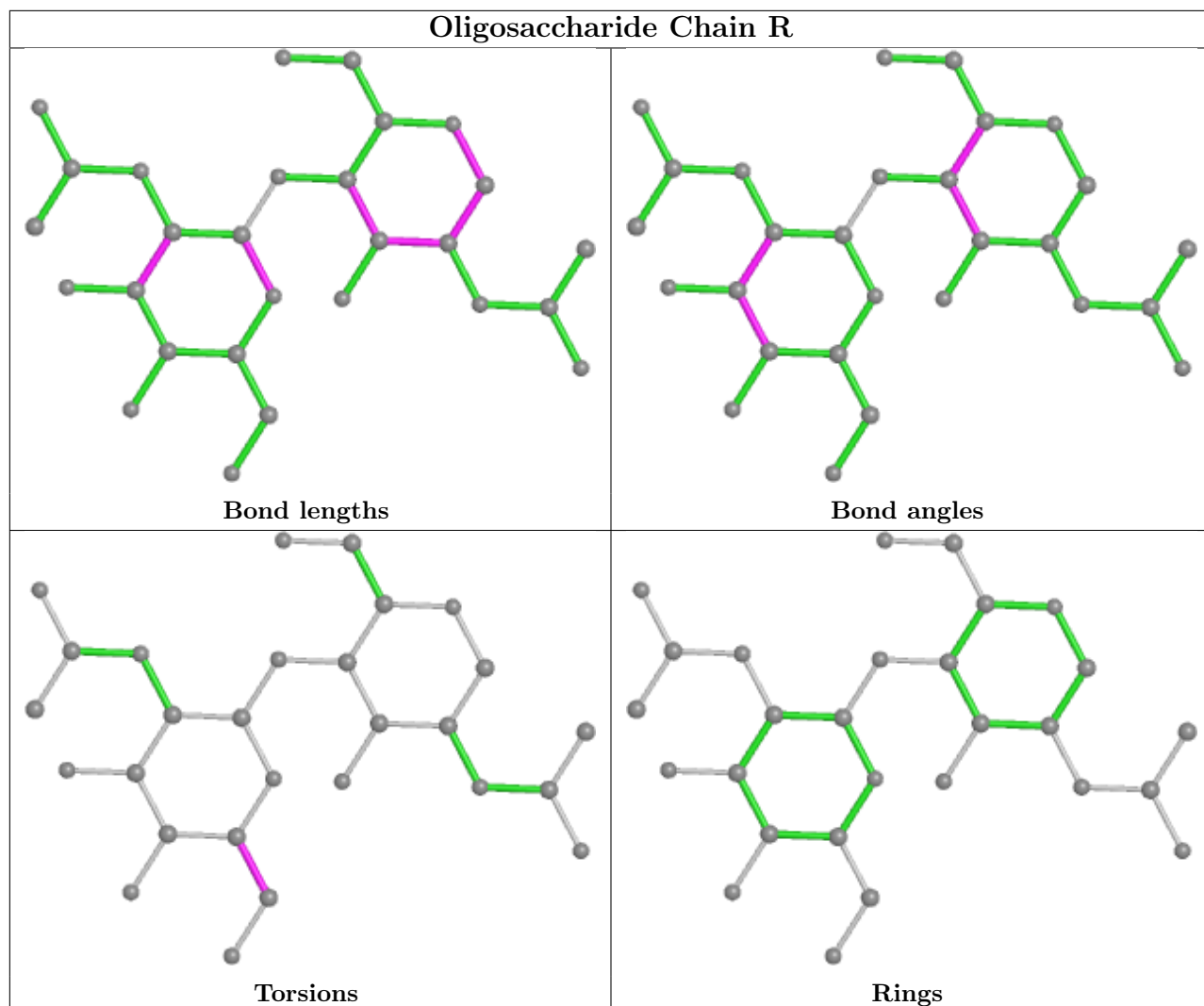

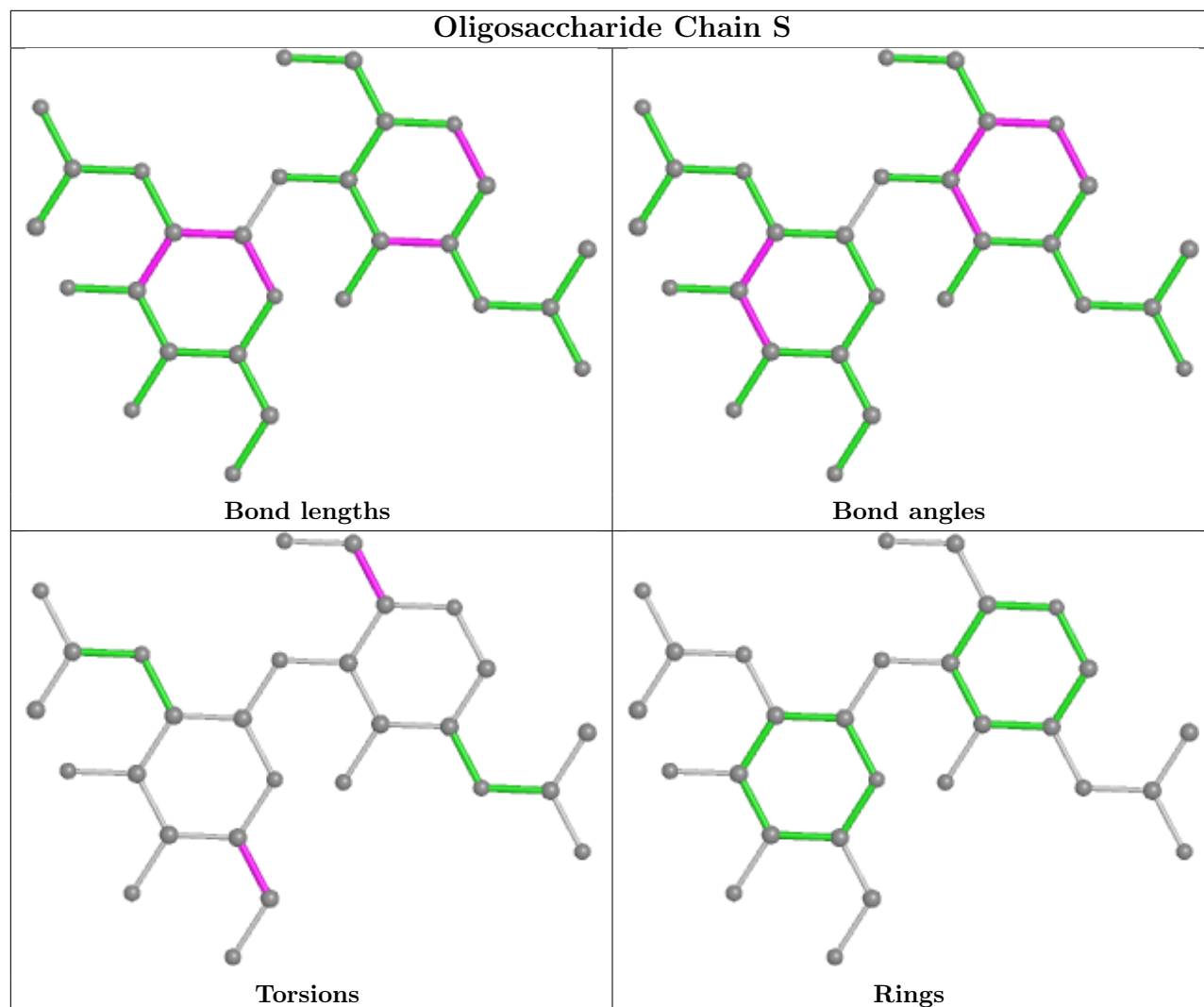

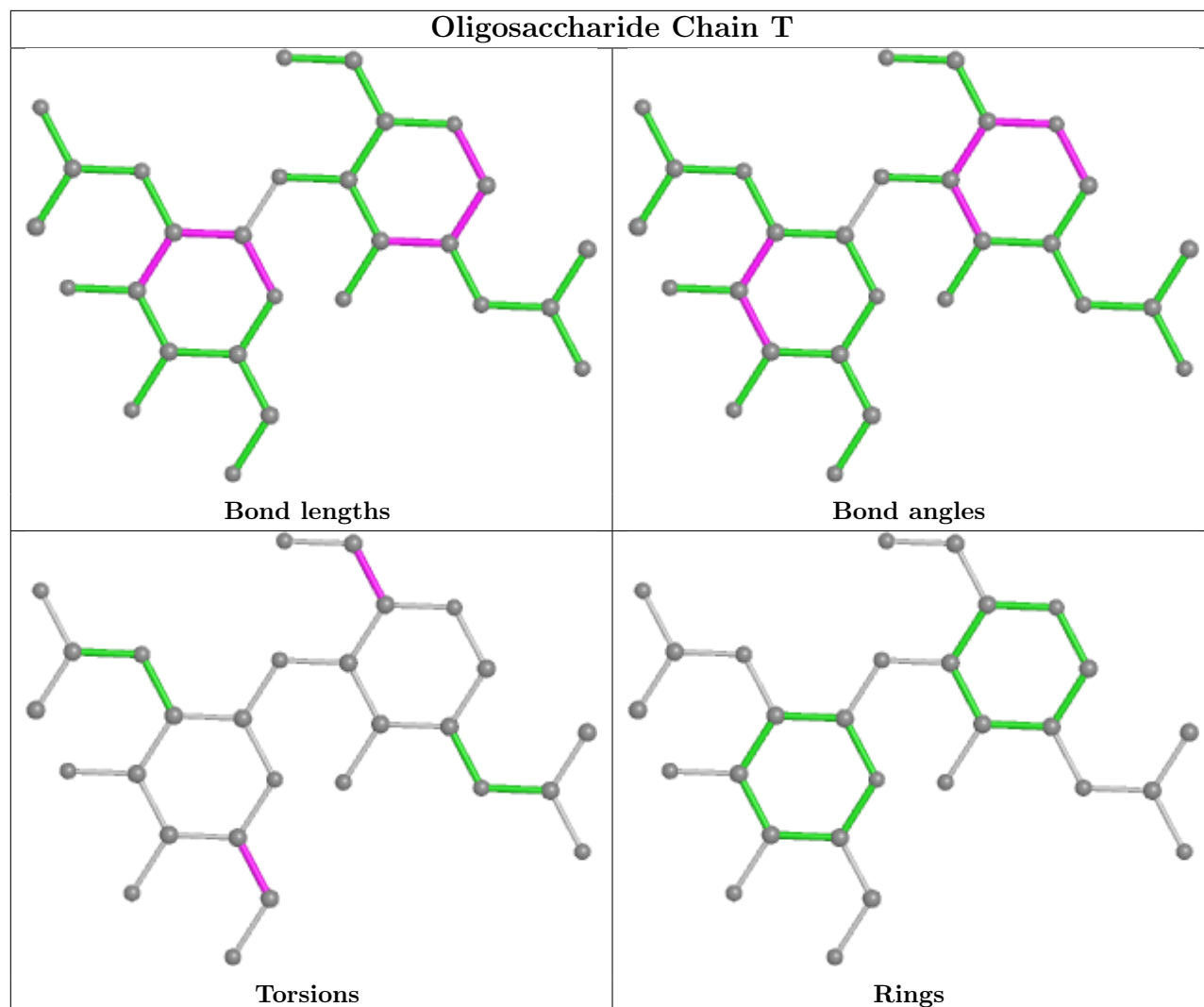

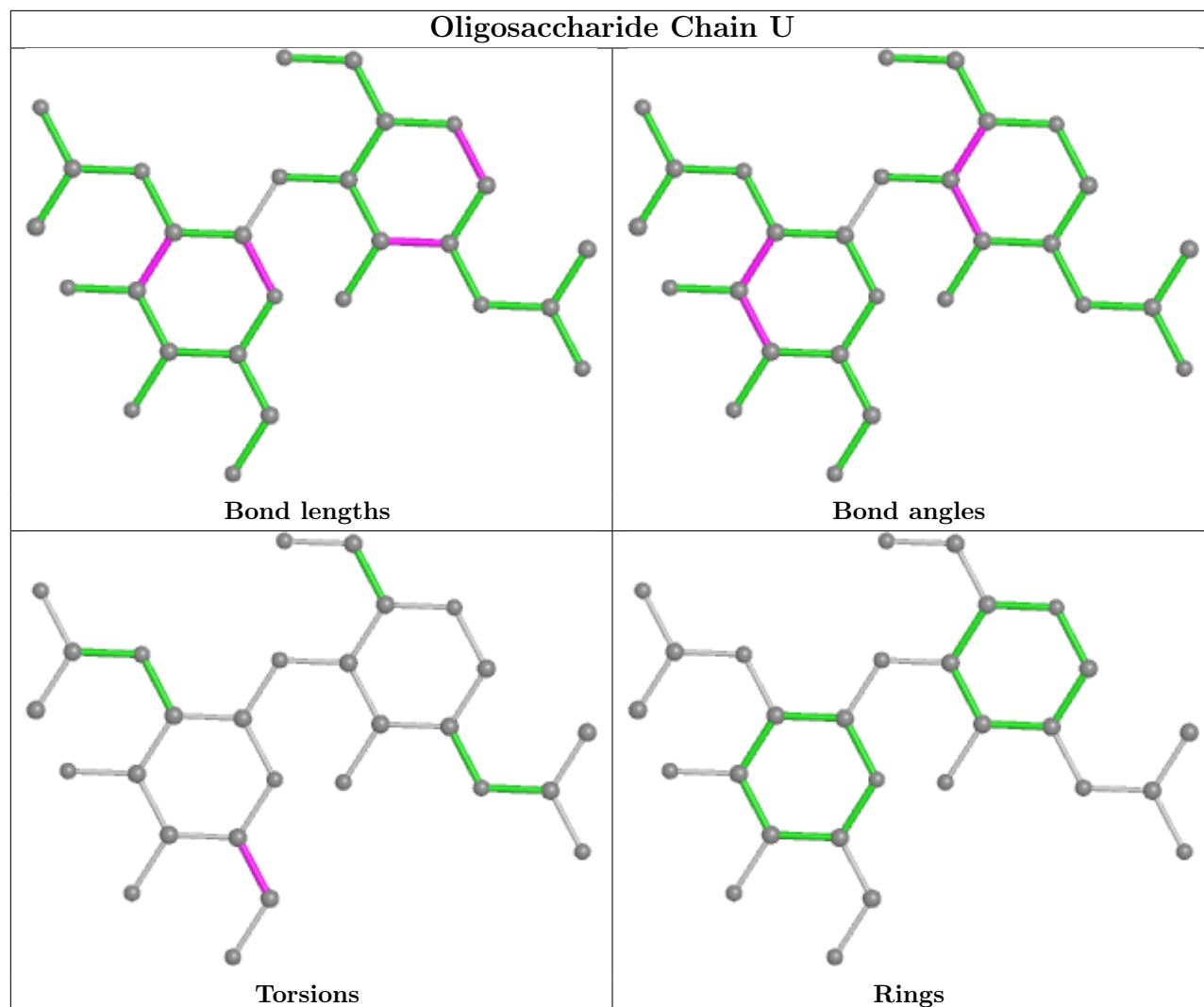



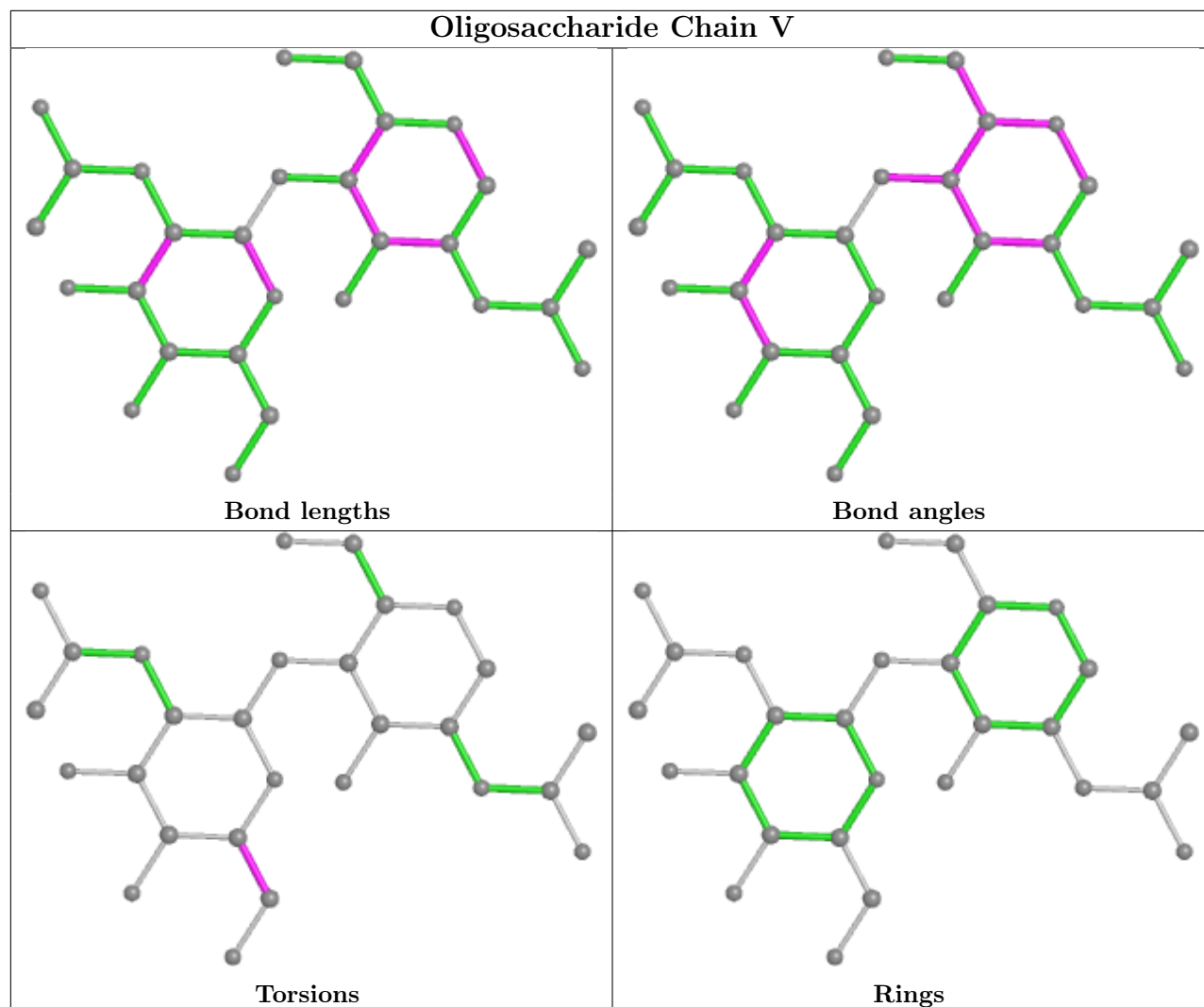

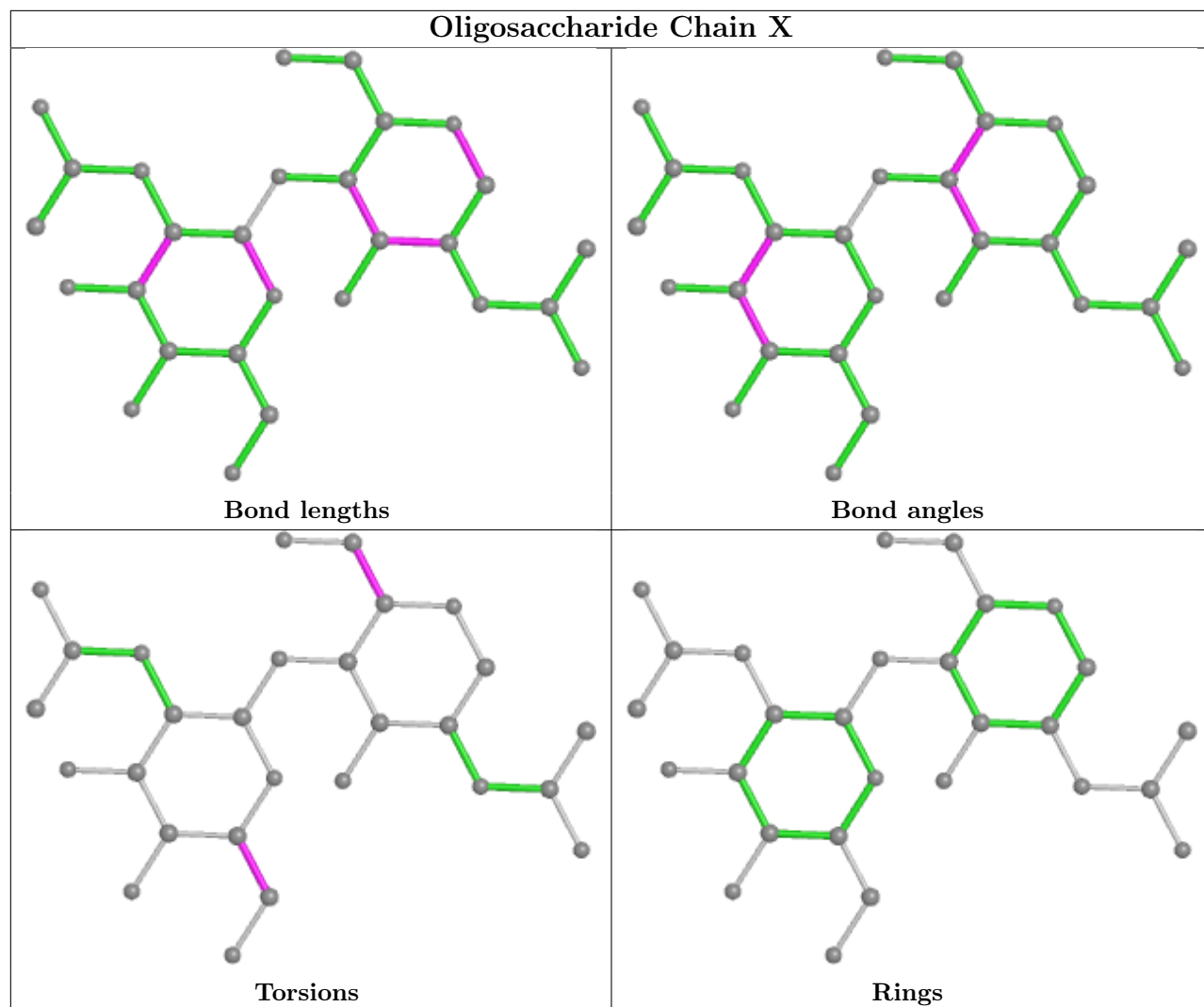

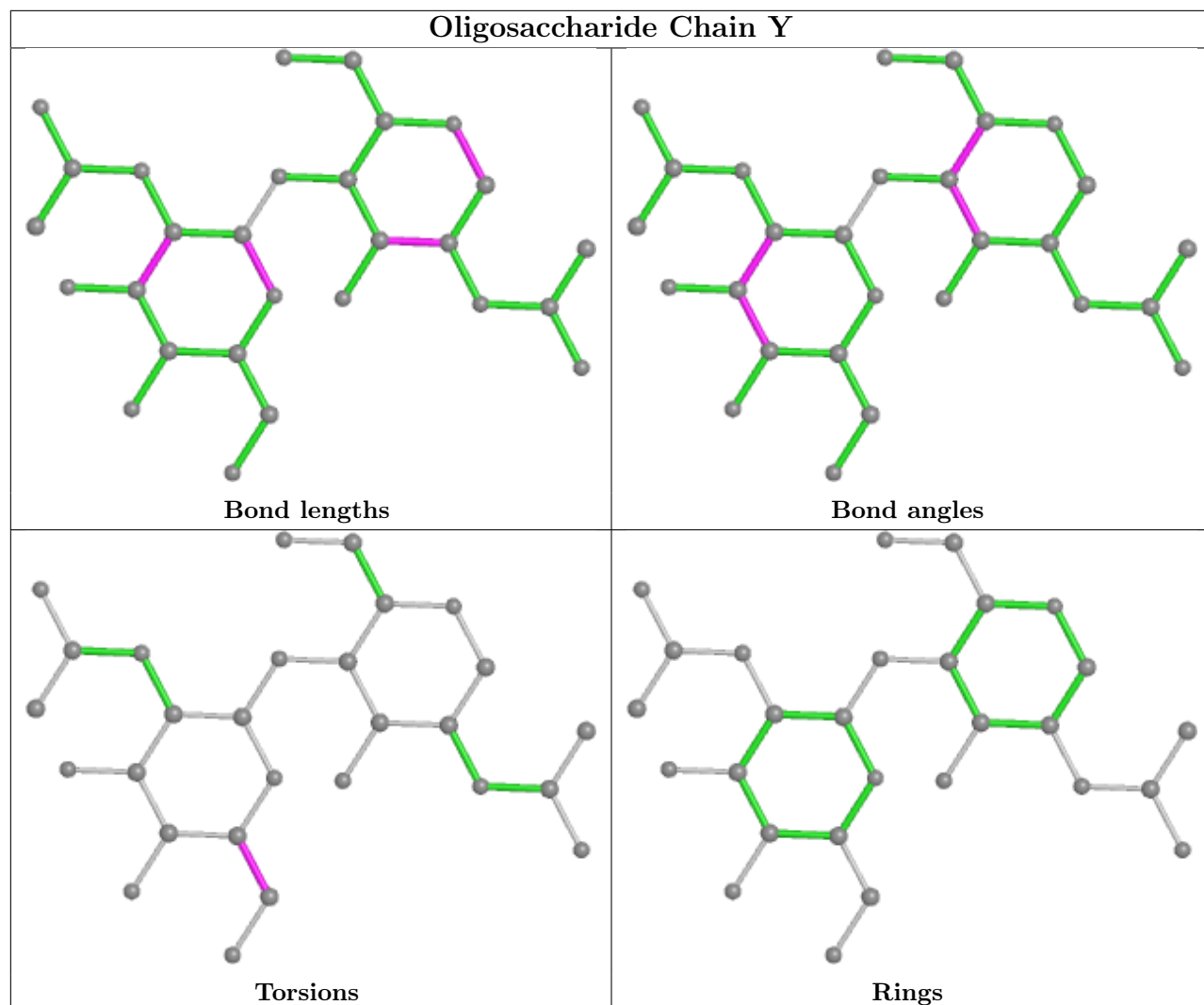

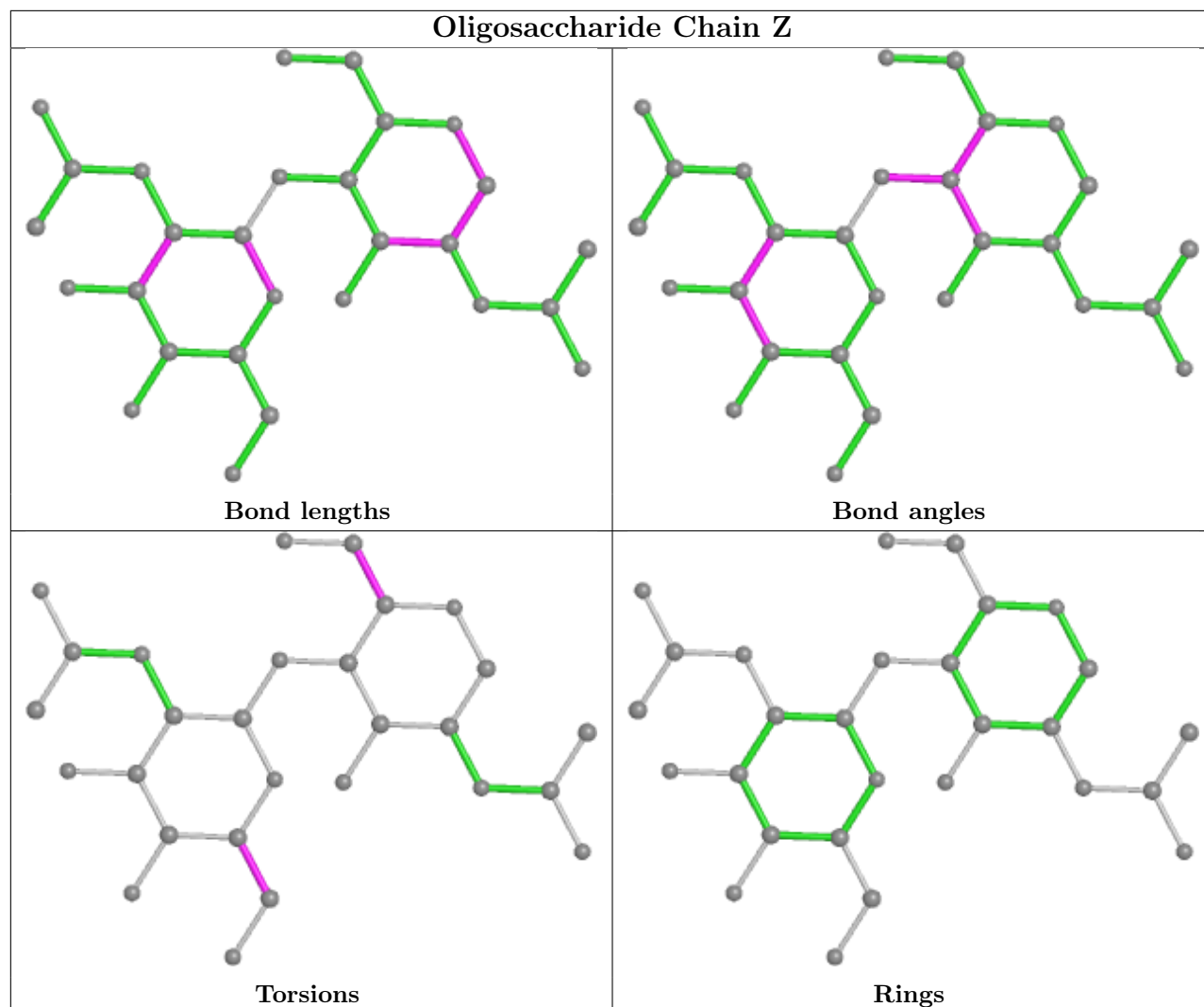

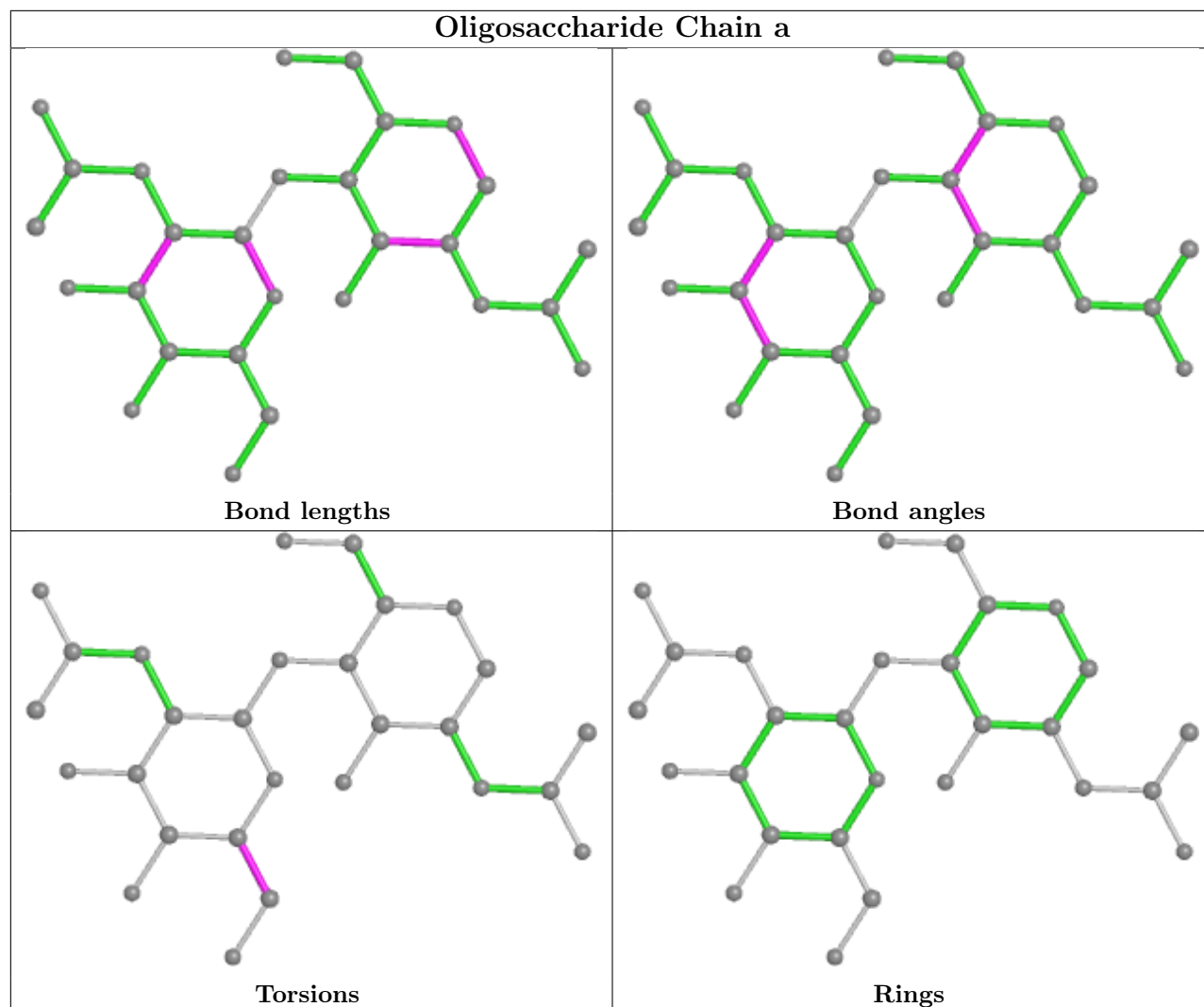

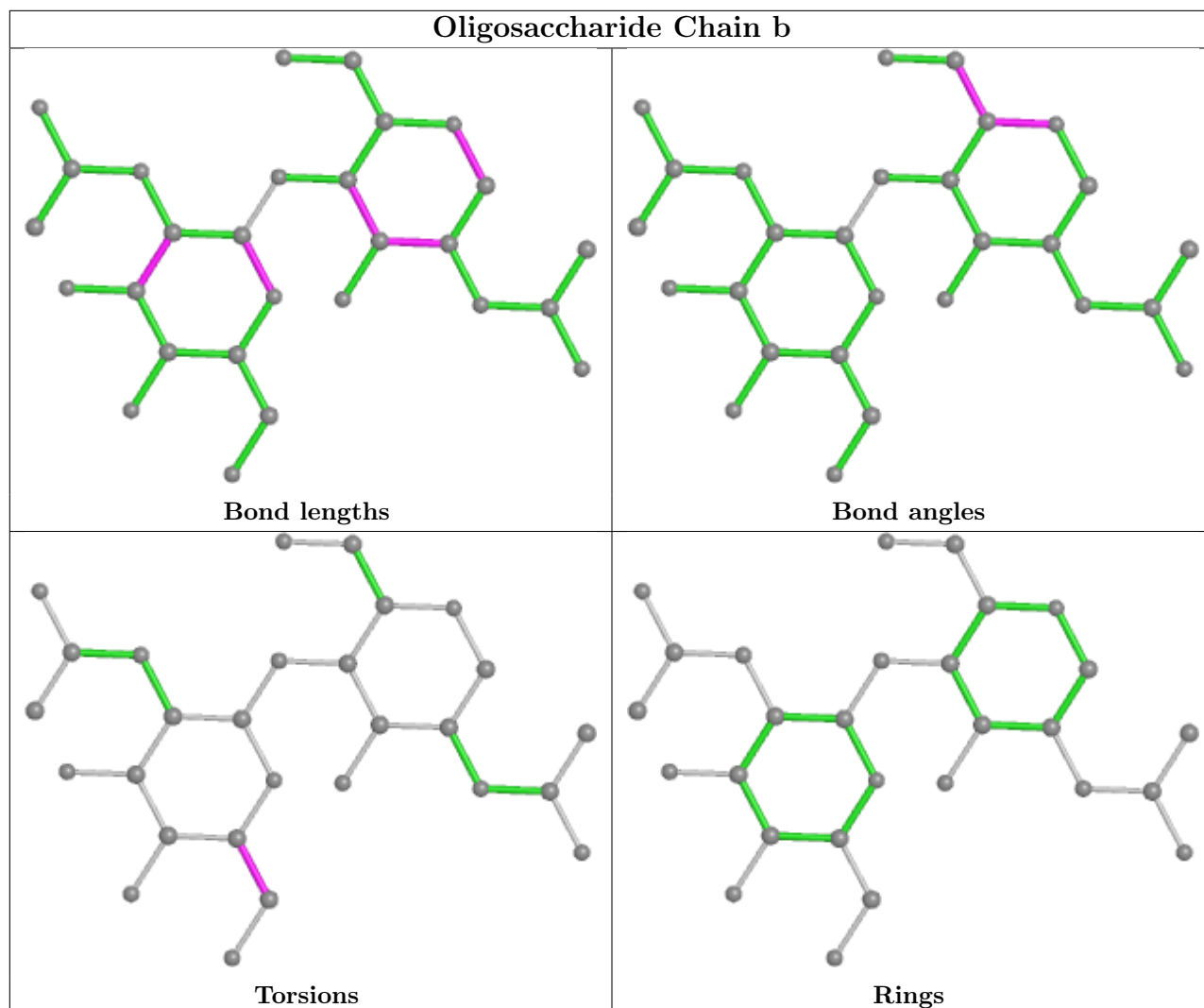

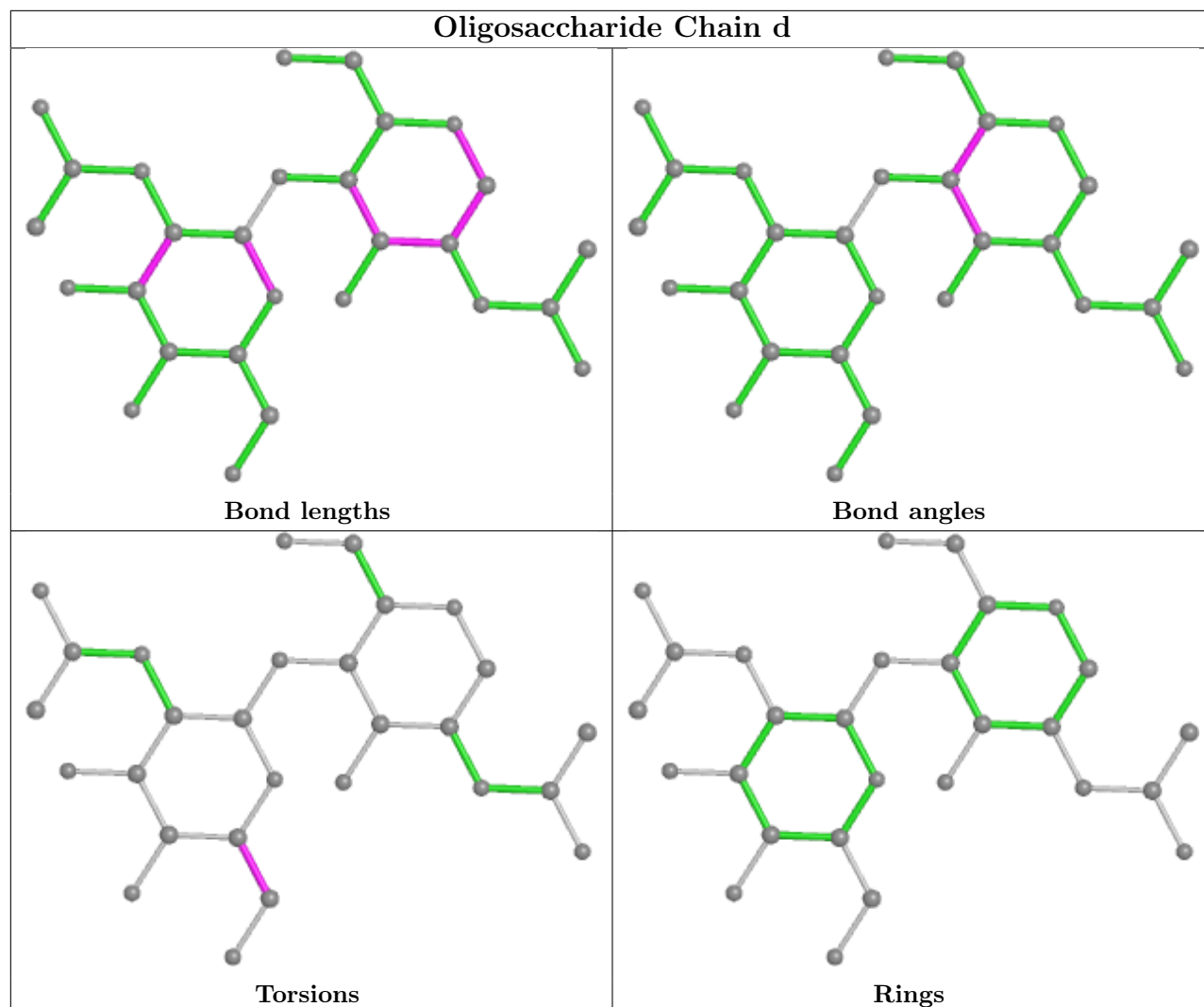

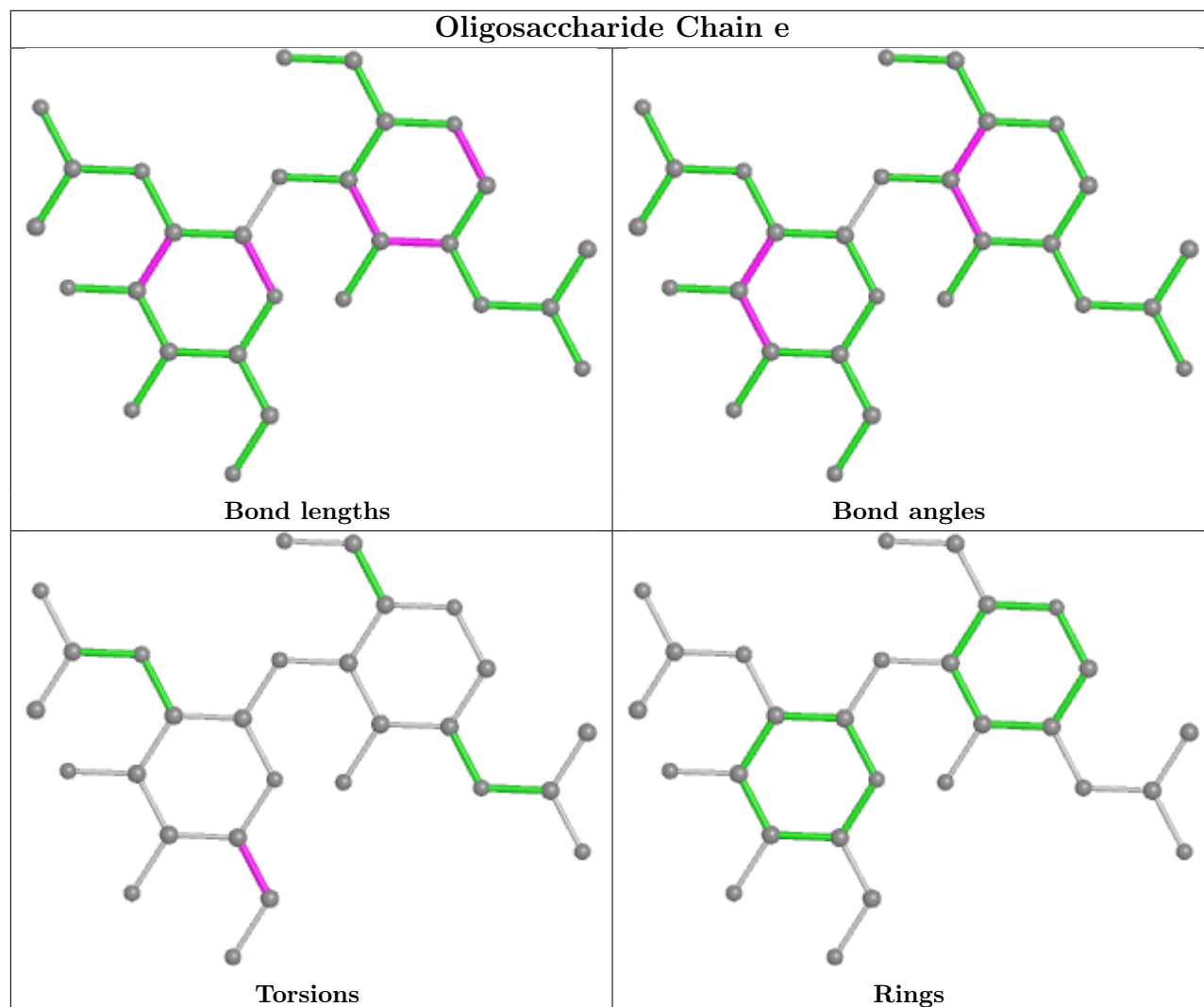



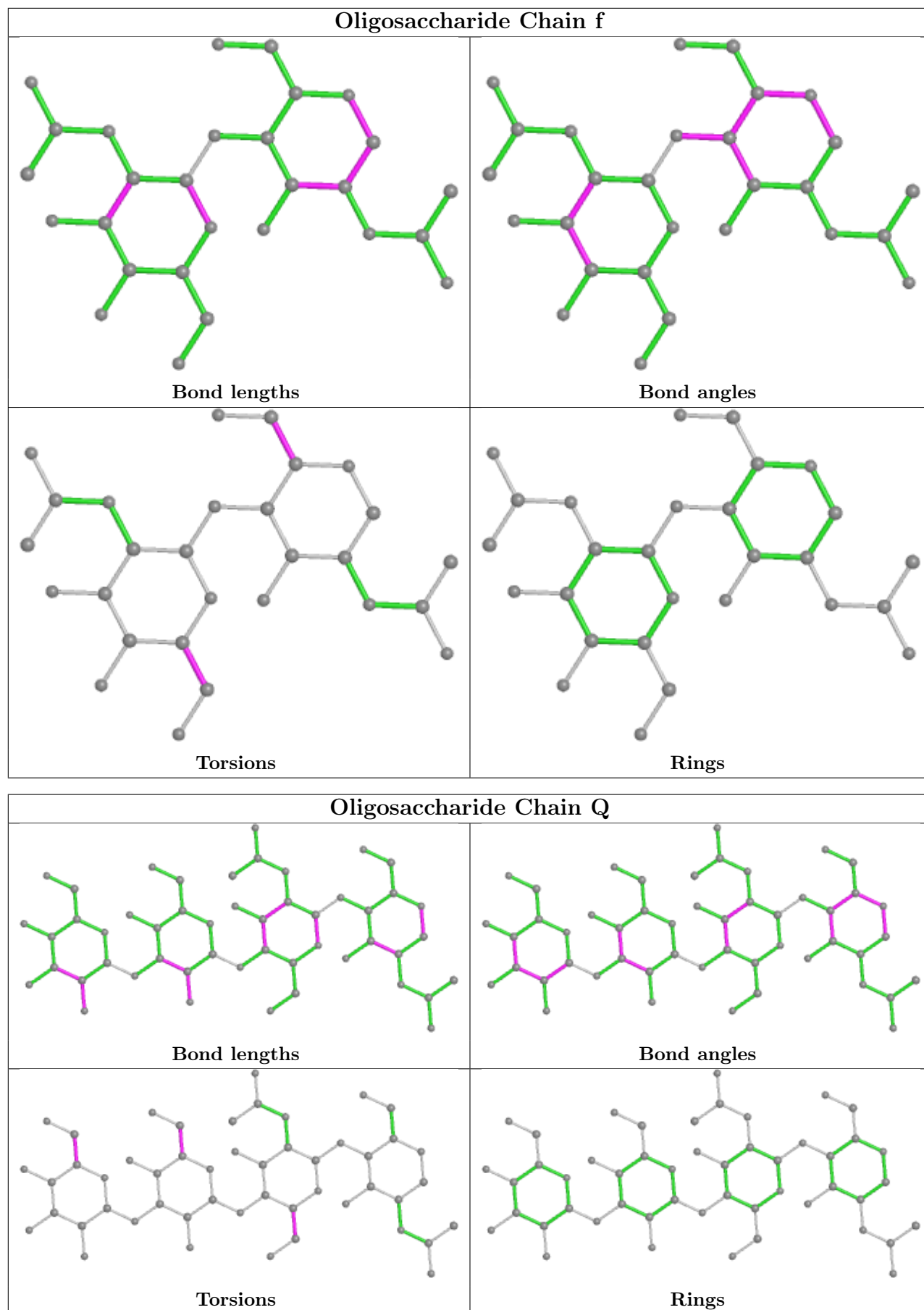

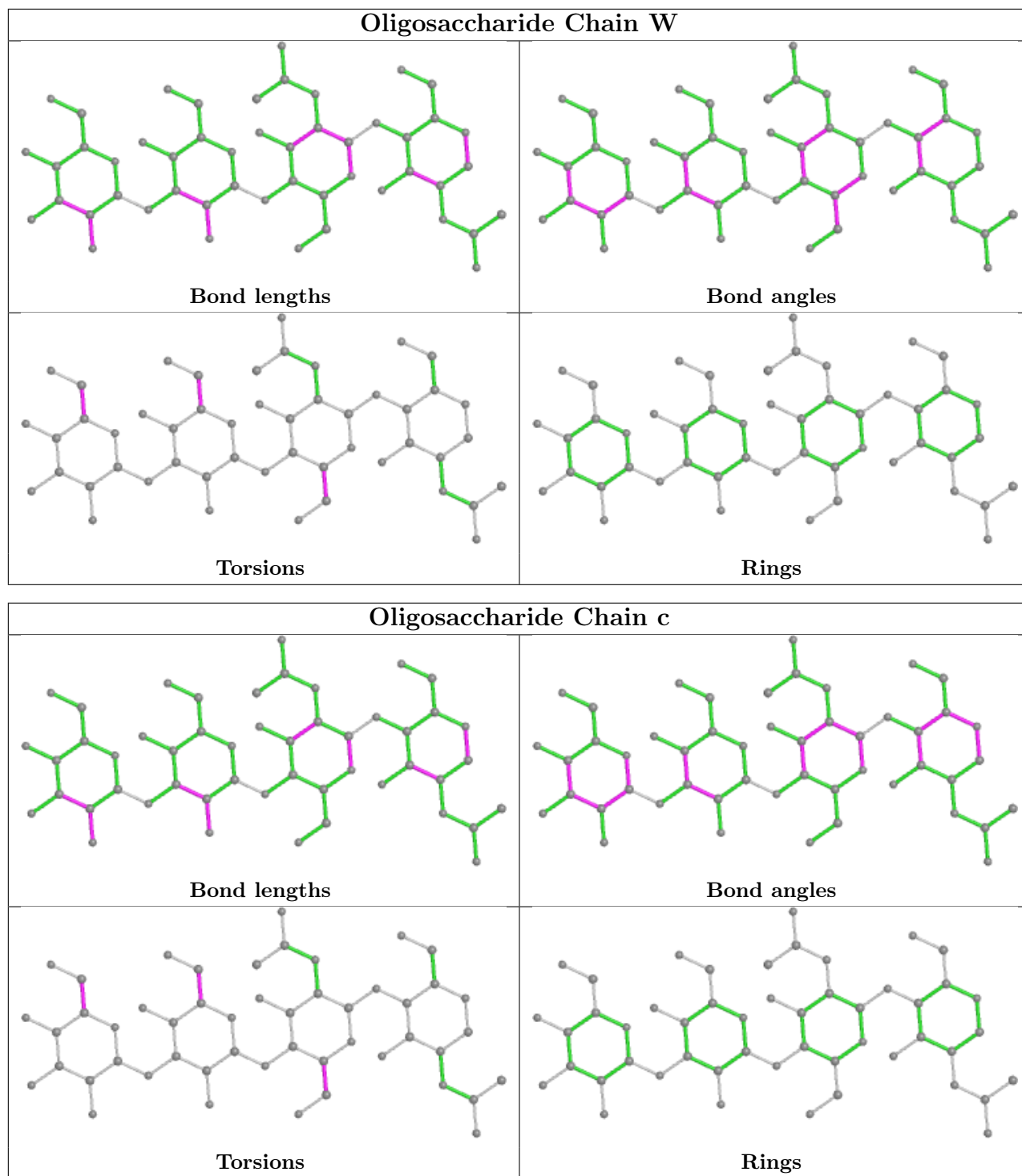

## 5.6 Ligand geometry [i](#)

39 ligands are modelled in this entry.

In the following table, the Counts columns list the number of bonds (or angles) for which Mogul statistics could be retrieved, the number of bonds (or angles) that are observed in the model and the number of bonds (or angles) that are defined in the Chemical Component Dictionary. The

Link column lists molecule types, if any, to which the group is linked. The Z score for a bond length (or angle) is the number of standard deviations the observed value is removed from the expected value. A bond length (or angle) with  $|Z| > 2$  is considered an outlier worth inspection. RMSZ is the root-mean-square of all Z scores of the bond lengths (or angles).

Mol	Type	Chain	Res	Link	Bond lengths			Bond angles		
					Counts	RMSZ	# Z  > 2	Counts	RMSZ	# Z  > 2
9	NAG	F	621	3	14,14,15	2.12	2 (14%)	17,19,21	0.78	0
9	NAG	F	607	3	14,14,15	2.10	2 (14%)	17,19,21	1.19	2 (11%)
9	NAG	F	615	3	14,14,15	2.15	2 (14%)	17,19,21	0.79	0
9	NAG	I	704	4	14,14,15	2.15	3 (21%)	17,19,21	0.80	1 (5%)
9	NAG	A	619	3	14,14,15	2.20	2 (14%)	17,19,21	0.75	0
9	NAG	E	604	3	14,14,15	2.13	2 (14%)	17,19,21	0.79	0
9	NAG	G	704	4	14,14,15	2.12	2 (14%)	17,19,21	0.85	2 (11%)
9	NAG	A	618	3	14,14,15	2.19	2 (14%)	17,19,21	0.66	0
9	NAG	G	705	4	14,14,15	2.15	2 (14%)	17,19,21	0.88	1 (5%)
9	NAG	E	619	3	14,14,15	2.16	2 (14%)	17,19,21	0.69	0
9	NAG	B	704	4	14,14,15	2.16	3 (21%)	17,19,21	0.81	1 (5%)
9	NAG	E	621	3	14,14,15	2.16	2 (14%)	17,19,21	0.84	1 (5%)
9	NAG	E	618	3	14,14,15	2.21	2 (14%)	17,19,21	0.74	0
9	NAG	E	622	3	14,14,15	2.11	3 (21%)	17,19,21	0.97	2 (11%)
9	NAG	A	607	3	14,14,15	2.03	2 (14%)	17,19,21	0.71	0
9	NAG	A	604	3	14,14,15	2.13	2 (14%)	17,19,21	0.78	0
9	NAG	E	620	3	14,14,15	2.14	3 (21%)	17,19,21	0.93	1 (5%)
9	NAG	A	621	3	14,14,15	2.15	2 (14%)	17,19,21	0.88	2 (11%)
9	NAG	A	622	3	14,14,15	2.10	2 (14%)	17,19,21	0.96	1 (5%)
9	NAG	A	620	3	14,14,15	2.15	3 (21%)	17,19,21	0.71	0
9	NAG	F	619	3	14,14,15	2.19	2 (14%)	17,19,21	0.76	0
9	NAG	F	601	3	14,14,15	2.11	2 (14%)	17,19,21	1.05	1 (5%)
9	NAG	E	607	3	14,14,15	2.09	2 (14%)	17,19,21	1.06	2 (11%)
9	NAG	A	601	3	14,14,15	2.13	2 (14%)	17,19,21	0.88	1 (5%)
9	NAG	G	703	4	14,14,15	2.04	1 (7%)	17,19,21	0.85	1 (5%)
9	NAG	E	614	3	14,14,15	2.15	2 (14%)	17,19,21	0.77	0
9	NAG	F	618	3	14,14,15	2.14	2 (14%)	17,19,21	0.60	0
9	NAG	B	703	4	14,14,15	2.12	2 (14%)	17,19,21	1.04	2 (11%)
9	NAG	E	615	3	14,14,15	2.12	2 (14%)	17,19,21	0.78	0
9	NAG	B	705	4	14,14,15	2.13	2 (14%)	17,19,21	0.84	1 (5%)
9	NAG	A	614	3	14,14,15	2.16	2 (14%)	17,19,21	0.80	0

Mol	Type	Chain	Res	Link	Bond lengths			Bond angles		
					Counts	RMSZ	# Z  > 2	Counts	RMSZ	# Z  > 2
9	NAG	F	622	3	14,14,15	2.15	2 (14%)	17,19,21	0.87	1 (5%)
9	NAG	E	601	3	14,14,15	2.11	2 (14%)	17,19,21	1.02	1 (5%)
9	NAG	A	615	3	14,14,15	2.11	2 (14%)	17,19,21	0.70	0
9	NAG	F	614	3	14,14,15	2.16	2 (14%)	17,19,21	0.72	0
9	NAG	F	604	3	14,14,15	2.12	2 (14%)	17,19,21	0.79	0
9	NAG	I	703	4	14,14,15	2.10	2 (14%)	17,19,21	1.27	1 (5%)
9	NAG	F	620	3	14,14,15	2.15	2 (14%)	17,19,21	1.08	2 (11%)
9	NAG	I	705	4	14,14,15	2.13	2 (14%)	17,19,21	0.86	1 (5%)

In the following table, the Chirals column lists the number of chiral outliers, the number of chiral centers analysed, the number of these observed in the model and the number defined in the Chemical Component Dictionary. Similar counts are reported in the Torsion and Rings columns. '-' means no outliers of that kind were identified.

Mol	Type	Chain	Res	Link	Chirals	Torsions	Rings
9	NAG	F	621	3	-	1/6/23/26	0/1/1/1
9	NAG	F	607	3	-	1/6/23/26	0/1/1/1
9	NAG	F	615	3	-	1/6/23/26	0/1/1/1
9	NAG	I	704	4	-	2/6/23/26	0/1/1/1
9	NAG	A	619	3	-	1/6/23/26	0/1/1/1
9	NAG	E	604	3	-	2/6/23/26	0/1/1/1
9	NAG	G	704	4	-	1/6/23/26	0/1/1/1
9	NAG	A	618	3	-	2/6/23/26	0/1/1/1
9	NAG	G	705	4	-	1/6/23/26	0/1/1/1
9	NAG	E	619	3	-	1/6/23/26	0/1/1/1
9	NAG	B	704	4	-	1/6/23/26	0/1/1/1
9	NAG	E	621	3	-	2/6/23/26	0/1/1/1
9	NAG	E	618	3	-	2/6/23/26	0/1/1/1
9	NAG	E	622	3	-	1/6/23/26	0/1/1/1
9	NAG	A	607	3	-	1/6/23/26	0/1/1/1
9	NAG	A	604	3	-	1/6/23/26	0/1/1/1
9	NAG	E	620	3	-	2/6/23/26	0/1/1/1
9	NAG	A	621	3	-	2/6/23/26	0/1/1/1
9	NAG	A	622	3	-	1/6/23/26	0/1/1/1
9	NAG	A	620	3	-	1/6/23/26	0/1/1/1
9	NAG	F	619	3	-	2/6/23/26	0/1/1/1
9	NAG	F	601	3	-	2/6/23/26	0/1/1/1
9	NAG	E	607	3	-	1/6/23/26	0/1/1/1
9	NAG	A	601	3	-	1/6/23/26	0/1/1/1

Continued on next page...

Continued from previous page...

Mol	Type	Chain	Res	Link	Chirals	Torsions	Rings
9	NAG	G	703	4	-	2/6/23/26	0/1/1/1
9	NAG	E	614	3	-	1/6/23/26	0/1/1/1
9	NAG	F	618	3	-	1/6/23/26	0/1/1/1
9	NAG	B	703	4	-	1/6/23/26	0/1/1/1
9	NAG	E	615	3	-	1/6/23/26	0/1/1/1
9	NAG	B	705	4	-	1/6/23/26	0/1/1/1
9	NAG	A	614	3	-	1/6/23/26	0/1/1/1
9	NAG	F	622	3	-	1/6/23/26	0/1/1/1
9	NAG	E	601	3	-	2/6/23/26	0/1/1/1
9	NAG	A	615	3	-	1/6/23/26	0/1/1/1
9	NAG	F	614	3	-	1/6/23/26	0/1/1/1
9	NAG	F	604	3	-	1/6/23/26	0/1/1/1
9	NAG	I	703	4	-	3/6/23/26	0/1/1/1
9	NAG	F	620	3	-	1/6/23/26	0/1/1/1
9	NAG	I	705	4	-	1/6/23/26	0/1/1/1

The worst 5 of 82 bond length outliers are listed below:

Mol	Chain	Res	Type	Atoms	Z	Observed(Å)	Ideal(Å)
9	A	619	NAG	O5-C1	7.24	1.55	1.43
9	F	619	NAG	O5-C1	7.18	1.55	1.43
9	E	619	NAG	O5-C1	7.15	1.55	1.43
9	E	618	NAG	O5-C1	7.13	1.55	1.43
9	A	618	NAG	O5-C1	7.12	1.55	1.43

The worst 5 of 28 bond angle outliers are listed below:

Mol	Chain	Res	Type	Atoms	Z	Observed(°)	Ideal(°)
9	A	622	NAG	C1-O5-C5	-3.12	107.96	112.19
9	E	620	NAG	C1-O5-C5	-3.05	108.06	112.19
9	I	703	NAG	C8-C7-N2	3.02	121.21	116.10
9	F	607	NAG	C1-O5-C5	-2.98	108.16	112.19
9	B	703	NAG	C4-C3-C2	-2.96	106.68	111.02

There are no chirality outliers.

5 of 52 torsion outliers are listed below:

Mol	Chain	Res	Type	Atoms
9	I	704	NAG	O5-C5-C6-O6
9	A	621	NAG	O5-C5-C6-O6
9	E	618	NAG	O5-C5-C6-O6

Continued on next page...

*Continued from previous page...*

Mol	Chain	Res	Type	Atoms
9	E	621	NAG	O5-C5-C6-O6
9	E	601	NAG	O5-C5-C6-O6

There are no ring outliers.

1 monomer is involved in 1 short contact:

Mol	Chain	Res	Type	Clashes	Symm-Clashes
9	F	615	NAG	1	0

## 5.7 Other polymers [i](#)

There are no such residues in this entry.

## 5.8 Polymer linkage issues [i](#)

There are no chain breaks in this entry.

## 6 Map visualisation [i](#)

This section contains visualisations of the EMDB entry EMD-7885. These allow visual inspection of the internal detail of the map and identification of artifacts.

Images derived from a raw map, generated by summing the deposited half-maps, are presented below the corresponding image components of the primary map to allow further visual inspection and comparison with those of the primary map.

### 6.1 Orthogonal projections [i](#)

#### 6.1.1 Primary map

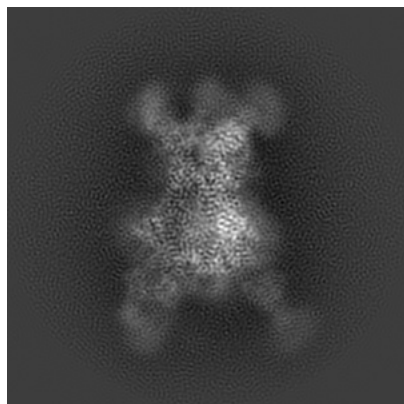

X

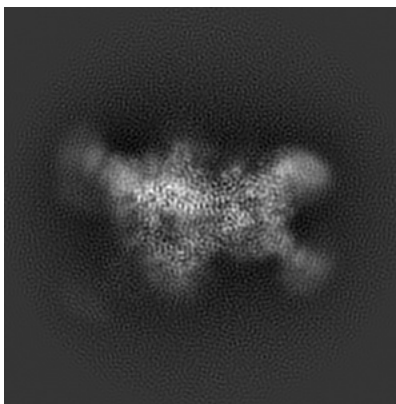

Y

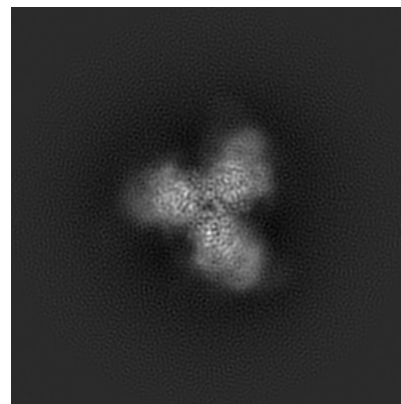

Z

#### 6.1.2 Raw map

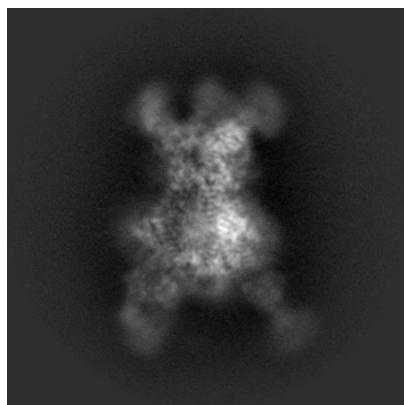

X

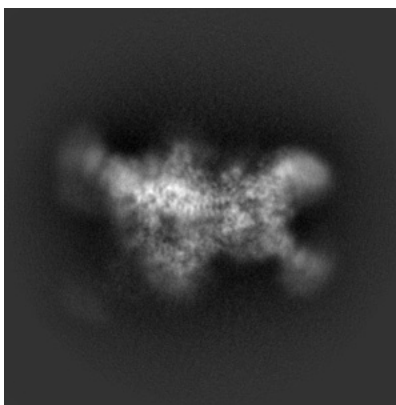

Y

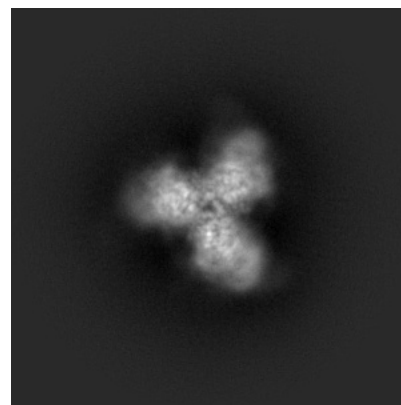

Z

The images above show the map projected in three orthogonal directions.

## 6.2 Central slices [i](#)

### 6.2.1 Primary map

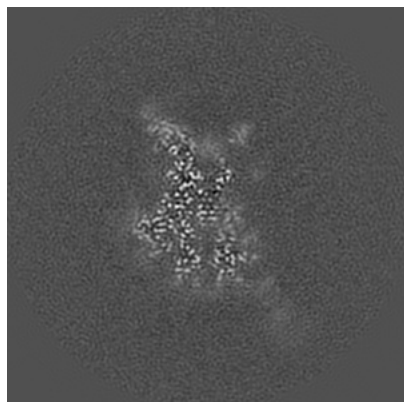

X Index: 160

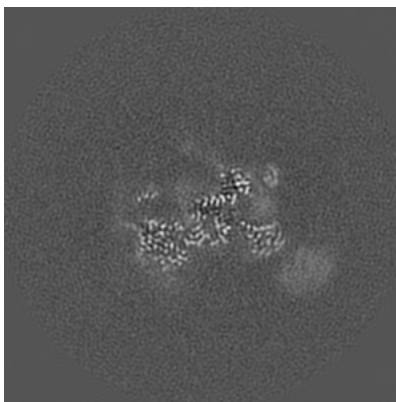

Y Index: 160

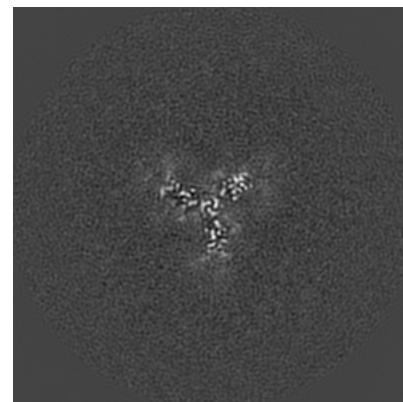

Z Index: 160

### 6.2.2 Raw map

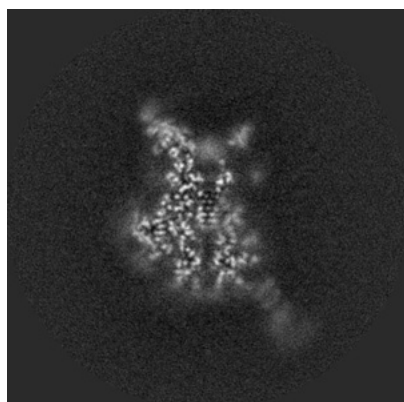

X Index: 160

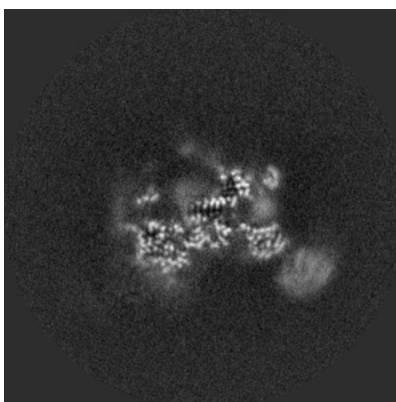

Y Index: 160

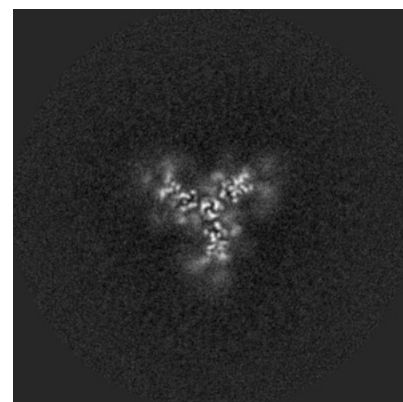

Z Index: 160

The images above show central slices of the map in three orthogonal directions.



## 6.3 Largest variance slices [i](#)

### 6.3.1 Primary map

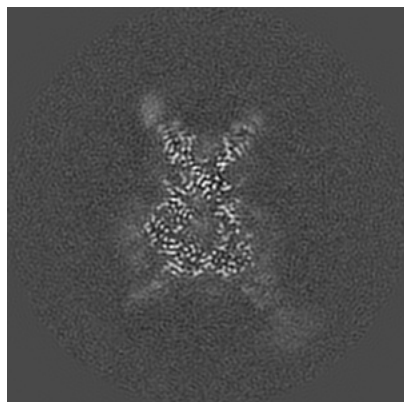

X Index: 168

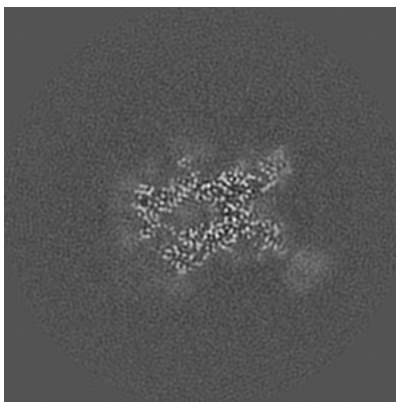

Y Index: 171

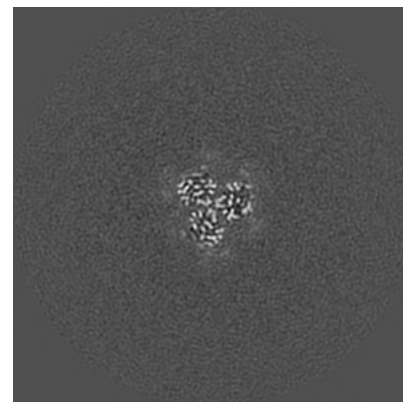

Z Index: 183

### 6.3.2 Raw map

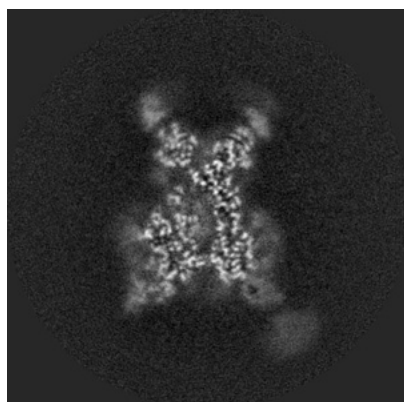

X Index: 172

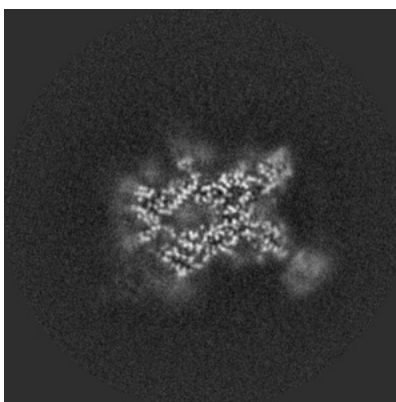

Y Index: 171

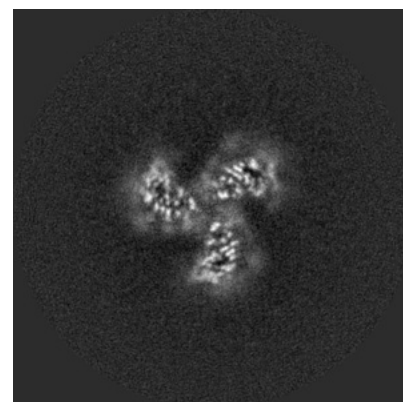

Z Index: 140

The images above show the largest variance slices of the map in three orthogonal directions.

## 6.4 Orthogonal surface views [i](#)

### 6.4.1 Primary map



X

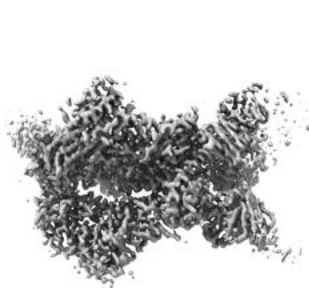

Y



Z

The images above show the 3D surface view of the map at the recommended contour level 0.03. These images, in conjunction with the slice images, may facilitate assessment of whether an appropriate contour level has been provided.

### 6.4.2 Raw map

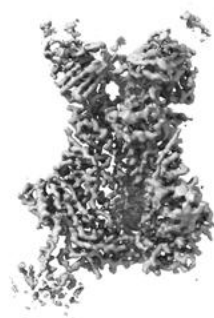

X

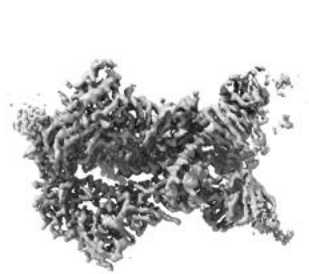

Y

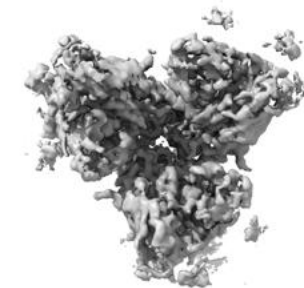

Z

These images show the 3D surface of the raw map. The raw map's contour level was selected so that its surface encloses the same volume as the primary map does at its recommended contour level.

## 6.5 Mask visualisation [i](#)

This section shows the 3D surface view of the primary map at 50% transparency overlaid with the specified mask at 0% transparency

A mask typically either:

- Encompasses the whole structure
- Separates out a domain, a functional unit, a monomer or an area of interest from a larger structure

### 6.5.1 emd\_7885\_msk\_1.map [i](#)

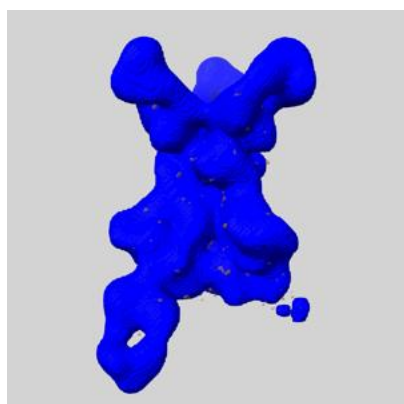

X

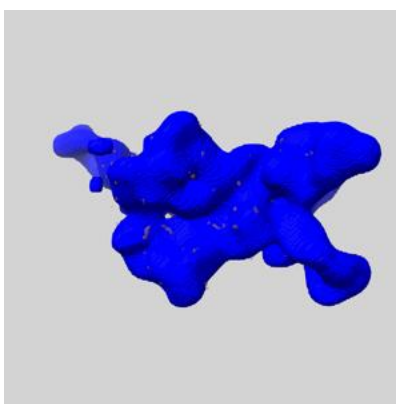

Y

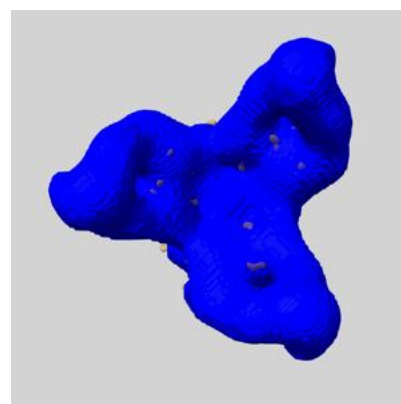

Z

## 7 Map analysis [i](#)

This section contains the results of statistical analysis of the map.

### 7.1 Map-value distribution [i](#)

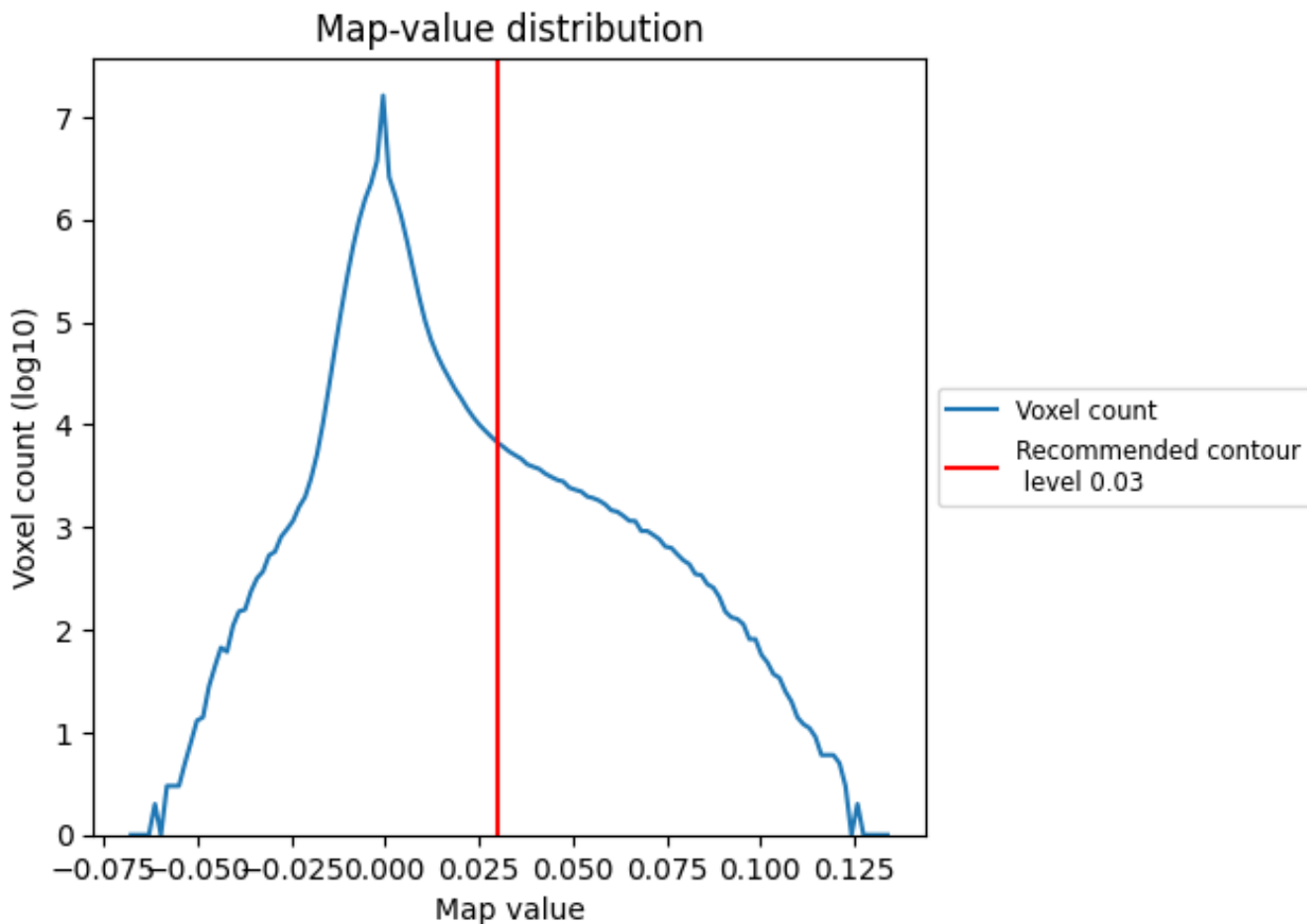

The map-value distribution is plotted in 128 intervals along the x-axis. The y-axis is logarithmic. A spike in this graph at zero usually indicates that the volume has been masked.

## 7.2 Volume estimate [\(i\)](#)

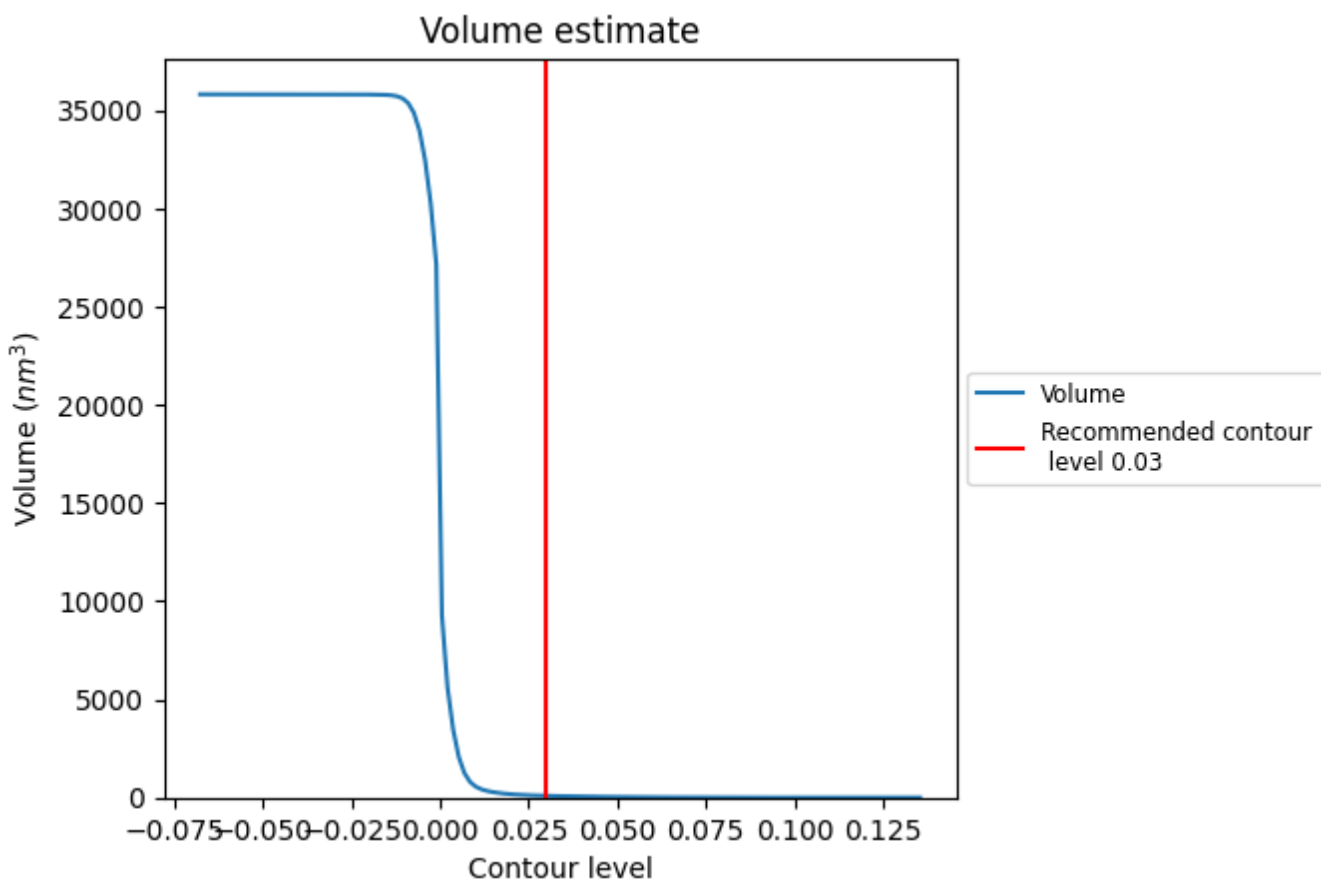

The volume at the recommended contour level is 88 nm<sup>3</sup>; this corresponds to an approximate mass of 80 kDa.

The volume estimate graph shows how the enclosed volume varies with the contour level. The recommended contour level is shown as a vertical line and the intersection between the line and the curve gives the volume of the enclosed surface at the given level.

### 7.3 Rotationally averaged power spectrum [i](#)

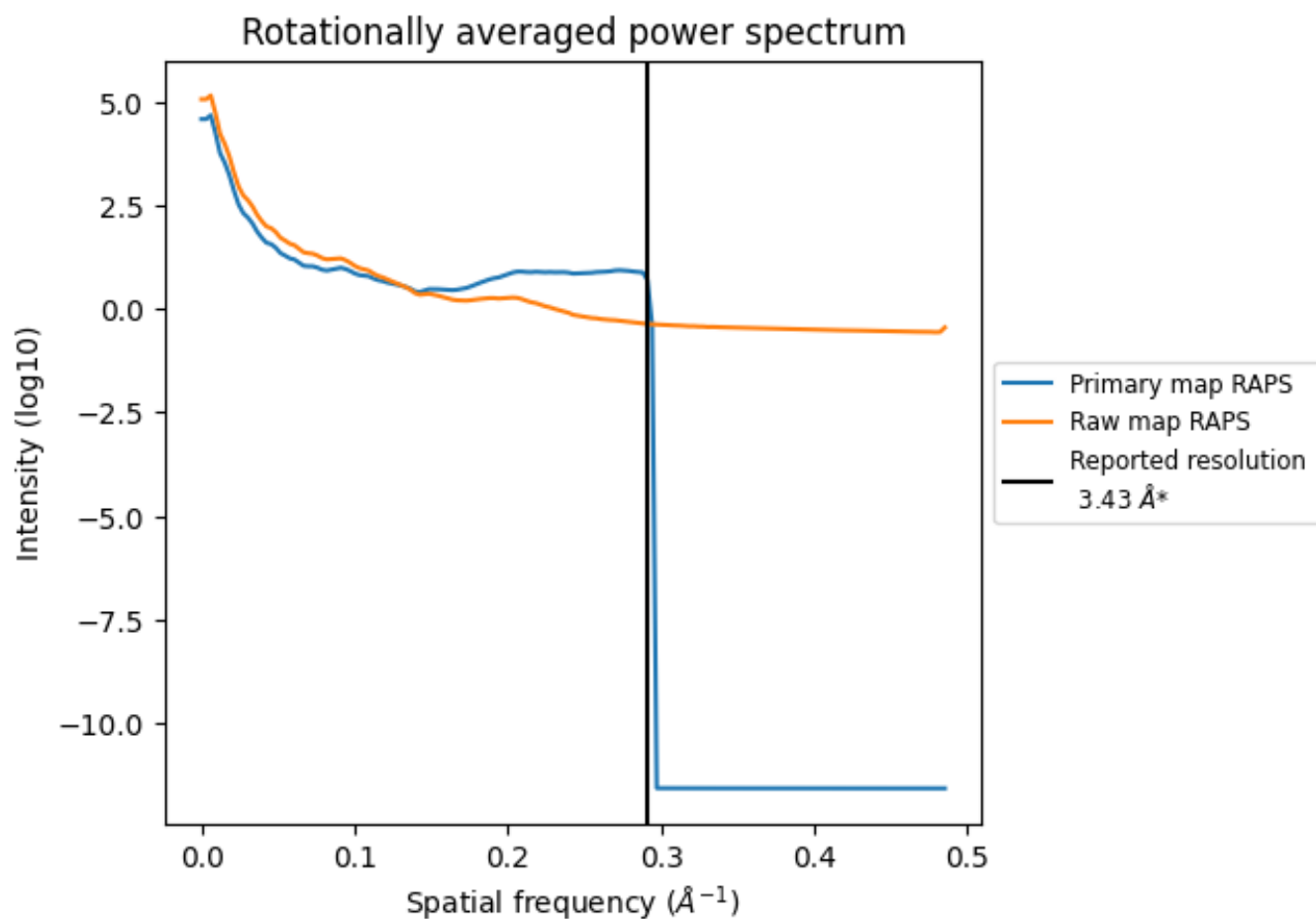

\*Reported resolution corresponds to spatial frequency of 0.292 Å<sup>-1</sup>

## 8 Fourier-Shell correlation [i](#)

Fourier-Shell Correlation (FSC) is the most commonly used method to estimate the resolution of single-particle and subtomogram-averaged maps. The shape of the curve depends on the imposed symmetry, mask and whether or not the two 3D reconstructions used were processed from a common reference. The reported resolution is shown as a black line. A curve is displayed for the half-bit criterion in addition to lines showing the 0.143 gold standard cut-off and 0.5 cut-off.

### 8.1 FSC [i](#)

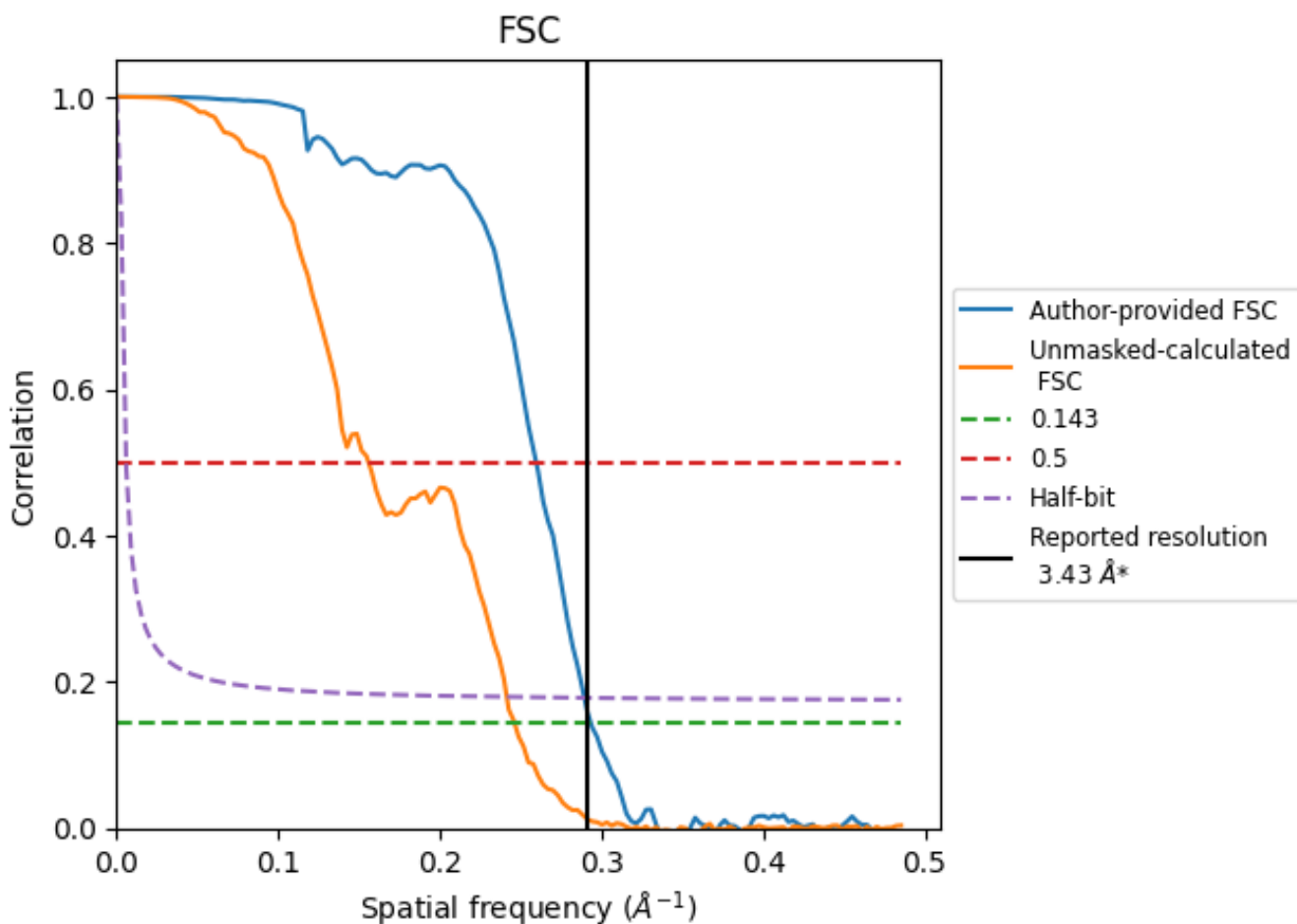

\*Reported resolution corresponds to spatial frequency of 0.292 Å<sup>-1</sup>

## 8.2 Resolution estimates [i](#)

Resolution estimate (Å)	Estimation criterion (FSC cut-off)		
	0.143	0.5	Half-bit
Reported by author	3.43	-	-
Author-provided FSC curve	3.41	3.85	3.45
Unmasked-calculated*	4.06	6.41	4.14

\*Resolution estimate based on FSC curve calculated by comparison of deposited half-maps. The value from deposited half-maps intersecting FSC 0.143 CUT-OFF 4.06 differs from the reported value 3.43 by more than 10 %



## 9 Map-model fit [i](#)

This section contains information regarding the fit between EMDB map EMD-7885 and PDB model 6NFC. Per-residue inclusion information can be found in section 3 on page 10.

### 9.1 Map-model overlay [i](#)

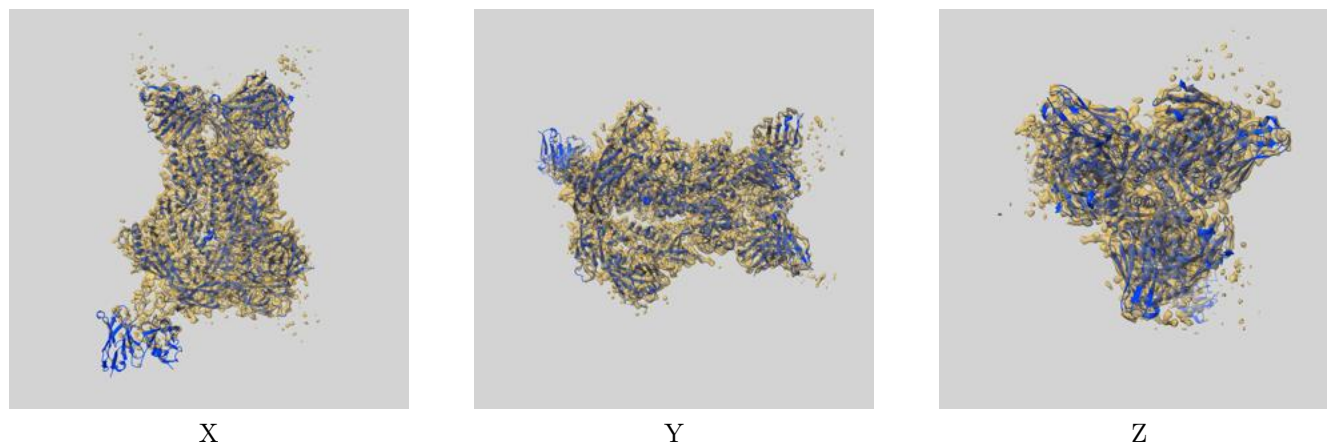

The images above show the 3D surface view of the map at the recommended contour level 0.03 at 50% transparency in yellow overlaid with a ribbon representation of the model coloured in blue. These images allow for the visual assessment of the quality of fit between the atomic model and the map.

## 9.2 Q-score mapped to coordinate model [\(i\)](#)

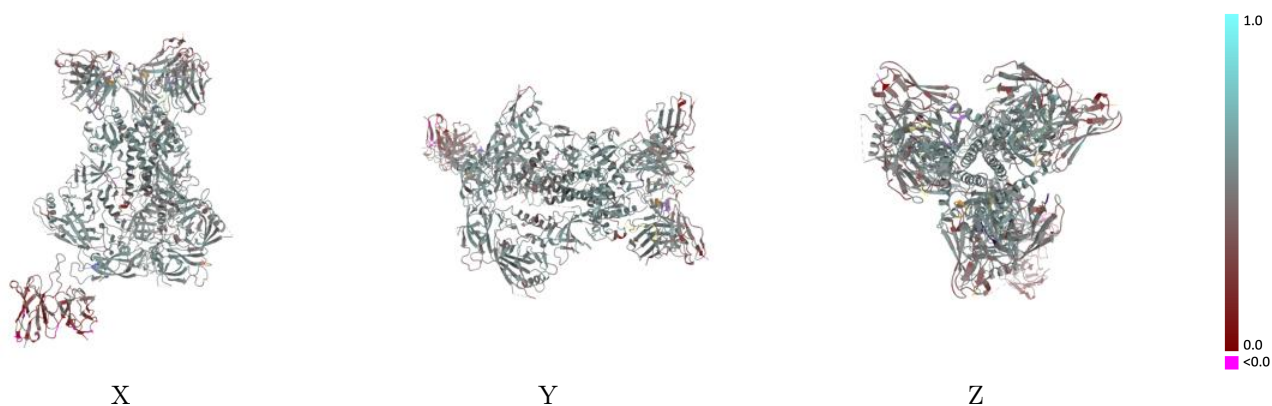

The images above show the model with each residue coloured according to its Q-score. This shows their resolvability in the map with higher Q-score values reflecting better resolvability. Please note: Q-score is calculating the resolvability of atoms, and thus high values are only expected at resolutions at which atoms can be resolved. Low Q-score values may therefore be expected for many entries.

## 9.3 Atom inclusion mapped to coordinate model [\(i\)](#)

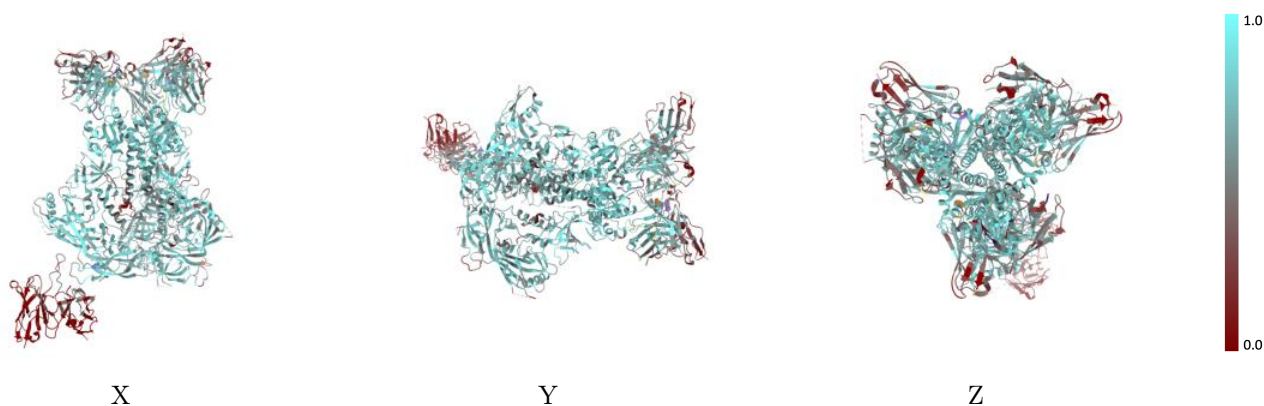

The images above show the model with each residue coloured according to its atom inclusion. This shows to what extent they are inside the map at the recommended contour level (0.03).



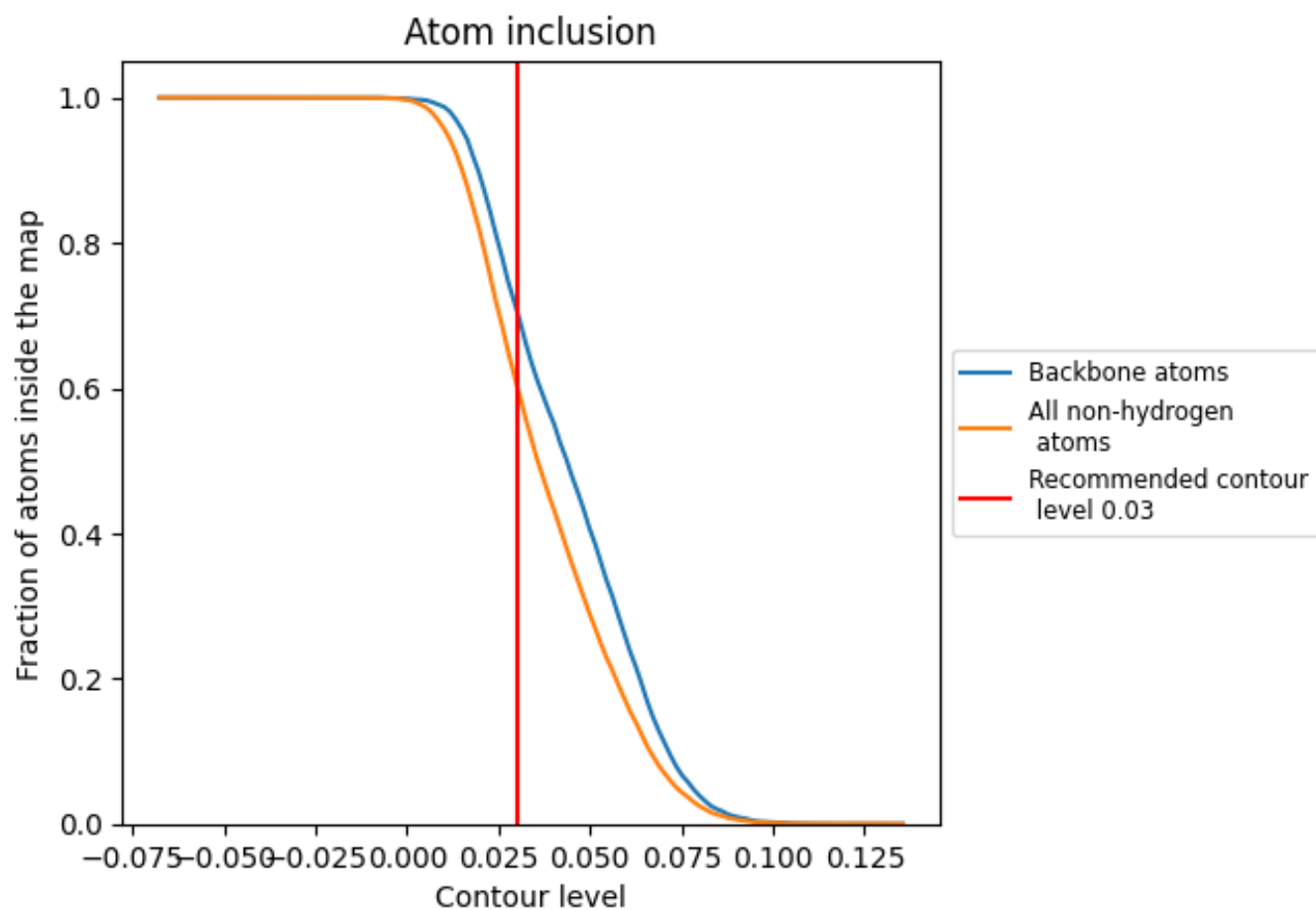































































## 9.4 Atom inclusion [i](#)



At the recommended contour level, 71% of all backbone atoms, 60% of all non-hydrogen atoms, are inside the map.

## 9.5 Map-model fit summary

The table lists the average atom inclusion at the recommended contour level (0.03) and Q-score for the entire model and for each chain.

Chain	Atom inclusion	Q-score
All	 0.6036	 0.4750
A	 0.6919	 0.5110
B	 0.7354	 0.5220
C	 0.5917	 0.4690
D	 0.5113	 0.4260
E	 0.6730	 0.5030
F	 0.6576	 0.5000
G	 0.7354	 0.5240
H	 0.1369	 0.2830
I	 0.7282	 0.5180
J	 0.6190	 0.4770
K	 0.5939	 0.4630
L	 0.1853	 0.3210
M	 0.5126	 0.4370
N	 0.5076	 0.4370
O	 0.6071	 0.5160
P	 0.3571	 0.4330
Q	 0.4400	 0.4660
R	 0.3214	 0.4080
S	 0.6071	 0.5230
T	 0.4286	 0.4980
U	 0.5357	 0.4960
V	 0.3571	 0.4000
W	 0.4400	 0.4510
X	 0.2500	 0.3190
Y	 0.3571	 0.4520
Z	 0.3571	 0.4600
a	 0.4643	 0.4540
b	 0.3214	 0.4400
c	 0.4400	 0.4800
d	 0.2143	 0.4480
e	 0.3214	 0.4140
f	 0.4643	 0.5220

