



Full wwPDB X-ray Structure Validation Report ⓘ

Nov 6, 2023 – 09:41 PM EST

PDB ID : 6MYL
Title : The Prp8 intein-cisplatin complex
Authors : Li, Z.; Li, H.
Deposited on : 2018-11-01
Resolution : 3.06 Å(reported)

This is a Full wwPDB X-ray Structure Validation Report for a publicly released PDB entry.

We welcome your comments at validation@mail.wwpdb.org

A user guide is available at

<https://www.wwpdb.org/validation/2017/XrayValidationReportHelp>

with specific help available everywhere you see the ⓘ symbol.

The types of validation reports are described at

<http://www.wwpdb.org/validation/2017/FAQs#types>.

The following versions of software and data (see [references ⓘ](#)) were used in the production of this report:

MolProbity : 4.02b-467
Mogul : 1.8.5 (274361), CSD as541be (2020)
Xtriage (Phenix) : 1.13
EDS : 2.36
buster-report : 1.1.7 (2018)
Percentile statistics : 20191225.v01 (using entries in the PDB archive December 25th 2019)
Refmac : 5.8.0158
CCP4 : 7.0.044 (Gargrove)
Ideal geometry (proteins) : Engh & Huber (2001)
Ideal geometry (DNA, RNA) : Parkinson et al. (1996)
Validation Pipeline (wwPDB-VP) : 2.36

1 Overall quality at a glance i

The following experimental techniques were used to determine the structure:

X-RAY DIFFRACTION

The reported resolution of this entry is 3.06 Å.

Percentile scores (ranging between 0-100) for global validation metrics of the entry are shown in the following graphic. The table shows the number of entries on which the scores are based.

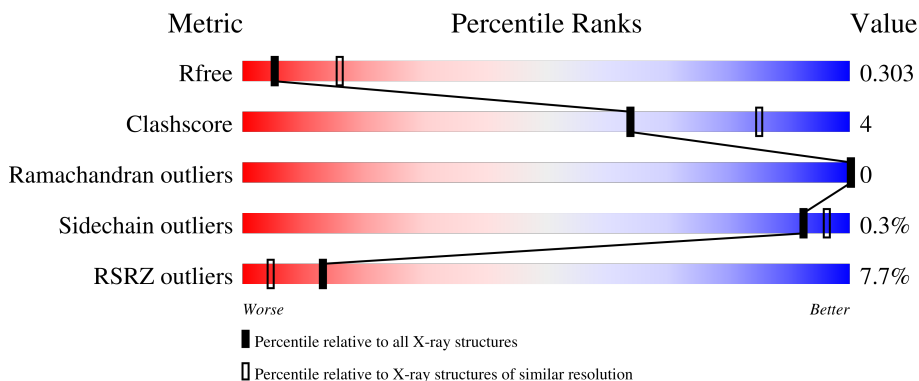

Metric	Whole archive (#Entries)	Similar resolution (#Entries, resolution range(Å))
R_{free}	130704	1754 (3.10-3.02)
Clashscore	141614	1864 (3.10-3.02)
Ramachandran outliers	138981	1794 (3.10-3.02)
Sidechain outliers	138945	1793 (3.10-3.02)
RSRZ outliers	127900	1713 (3.10-3.02)

The table below summarises the geometric issues observed across the polymeric chains and their fit to the electron density. The red, orange, yellow and green segments of the lower bar indicate the fraction of residues that contain outliers for ≥ 3 , 2, 1 and 0 types of geometric quality criteria respectively. A grey segment represents the fraction of residues that are not modelled. The numeric value for each fraction is indicated below the corresponding segment, with a dot representing fractions $\leq 5\%$. The upper red bar (where present) indicates the fraction of residues that have poor fit to the electron density. The numeric value is given above the bar.

Mol	Chain	Length	Quality of chain
1	A	214	<div style="display: flex; align-items: center;"> <div style="width: 4%; height: 10px; background-color: red; margin-right: 5px;"></div> <div style="width: 56%; height: 10px; background-color: green; margin-right: 5px;"></div> <div style="width: 9%; height: 10px; background-color: yellow; margin-right: 5px;"></div> <div style="width: 35%; height: 10px; background-color: grey;"></div> </div> <p style="text-align: center; margin-top: 5px;">4% 56% 9% 35%</p>
1	B	214	<div style="display: flex; align-items: center;"> <div style="width: 5%; height: 10px; background-color: red; margin-right: 5px;"></div> <div style="width: 58%; height: 10px; background-color: green; margin-right: 5px;"></div> <div style="width: 7%; height: 10px; background-color: yellow; margin-right: 5px;"></div> <div style="width: 35%; height: 10px; background-color: grey;"></div> </div> <p style="text-align: center; margin-top: 5px;">5% 58% 7% 35%</p>
1	C	214	<div style="display: flex; align-items: center;"> <div style="width: 7%; height: 10px; background-color: red; margin-right: 5px;"></div> <div style="width: 58%; height: 10px; background-color: green; margin-right: 5px;"></div> <div style="width: 7%; height: 10px; background-color: yellow; margin-right: 5px;"></div> <div style="width: 35%; height: 10px; background-color: grey;"></div> </div> <p style="text-align: center; margin-top: 5px;">7% 58% 7% 35%</p>

2 Entry composition [i](#)

There are 2 unique types of molecules in this entry. The entry contains 3453 atoms, of which 0 are hydrogens and 0 are deuteriums.

In the tables below, the ZeroOcc column contains the number of atoms modelled with zero occupancy, the AltConf column contains the number of residues with at least one atom in alternate conformation and the Trace column contains the number of residues modelled with at most 2 atoms.

- Molecule 1 is a protein called Pre-mRNA-processing-splicing factor 8.

Mol	Chain	Residues	Atoms						ZeroOcc	AltConf	Trace
			Total	C	N	O	S	Se			
1	A	140	1148	718	204	223	2	1	0	0	0
1	B	140	1148	718	204	223	2	1	0	0	0
1	C	140	1148	718	204	223	2	1	0	0	0

There are 129 discrepancies between the modelled and reference sequences:

Chain	Residue	Modelled	Actual	Comment	Reference
A	-42	MSE	-	initiating methionine	UNP A0A095EAP2
A	-41	GLY	-	expression tag	UNP A0A095EAP2
A	-40	SER	-	expression tag	UNP A0A095EAP2
A	-39	SER	-	expression tag	UNP A0A095EAP2
A	-38	HIS	-	expression tag	UNP A0A095EAP2
A	-37	HIS	-	expression tag	UNP A0A095EAP2
A	-36	HIS	-	expression tag	UNP A0A095EAP2
A	-35	HIS	-	expression tag	UNP A0A095EAP2
A	-34	HIS	-	expression tag	UNP A0A095EAP2
A	-33	HIS	-	expression tag	UNP A0A095EAP2
A	-32	SER	-	expression tag	UNP A0A095EAP2
A	-31	SER	-	expression tag	UNP A0A095EAP2
A	-30	GLY	-	expression tag	UNP A0A095EAP2
A	-29	LEU	-	expression tag	UNP A0A095EAP2
A	-28	VAL	-	expression tag	UNP A0A095EAP2
A	-27	PRO	-	expression tag	UNP A0A095EAP2
A	-26	ARG	-	expression tag	UNP A0A095EAP2
A	-25	GLY	-	expression tag	UNP A0A095EAP2
A	-24	SER	-	expression tag	UNP A0A095EAP2
A	-23	HIS	-	expression tag	UNP A0A095EAP2
A	-22	MSE	-	expression tag	UNP A0A095EAP2
A	-21	ALA	-	expression tag	UNP A0A095EAP2
A	-20	SER	-	expression tag	UNP A0A095EAP2

Continued on next page...

Continued from previous page...

Chain	Residue	Modelled	Actual	Comment	Reference
A	-19	MSE	-	expression tag	UNP A0A095EAP2
A	-18	THR	-	expression tag	UNP A0A095EAP2
A	-17	GLY	-	expression tag	UNP A0A095EAP2
A	-16	GLY	-	expression tag	UNP A0A095EAP2
A	-15	GLN	-	expression tag	UNP A0A095EAP2
A	-14	GLN	-	expression tag	UNP A0A095EAP2
A	-13	MSE	-	expression tag	UNP A0A095EAP2
A	-12	GLY	-	expression tag	UNP A0A095EAP2
A	-11	ARG	-	expression tag	UNP A0A095EAP2
A	-10	GLY	-	expression tag	UNP A0A095EAP2
A	-9	SER	-	expression tag	UNP A0A095EAP2
A	-8	GLU	-	expression tag	UNP A0A095EAP2
A	-7	PHE	-	expression tag	UNP A0A095EAP2
A	-6	GLU	-	expression tag	UNP A0A095EAP2
A	-5	LEU	-	expression tag	UNP A0A095EAP2
A	-4	ARG	-	expression tag	UNP A0A095EAP2
A	-3	ARG	-	expression tag	UNP A0A095EAP2
A	-2	GLN	-	expression tag	UNP A0A095EAP2
A	-1	ALA	-	expression tag	UNP A0A095EAP2
A	0	SER	-	expression tag	UNP A0A095EAP2
B	-42	MSE	-	initiating methionine	UNP A0A095EAP2
B	-41	GLY	-	expression tag	UNP A0A095EAP2
B	-40	SER	-	expression tag	UNP A0A095EAP2
B	-39	SER	-	expression tag	UNP A0A095EAP2
B	-38	HIS	-	expression tag	UNP A0A095EAP2
B	-37	HIS	-	expression tag	UNP A0A095EAP2
B	-36	HIS	-	expression tag	UNP A0A095EAP2
B	-35	HIS	-	expression tag	UNP A0A095EAP2
B	-34	HIS	-	expression tag	UNP A0A095EAP2
B	-33	HIS	-	expression tag	UNP A0A095EAP2
B	-32	SER	-	expression tag	UNP A0A095EAP2
B	-31	SER	-	expression tag	UNP A0A095EAP2
B	-30	GLY	-	expression tag	UNP A0A095EAP2
B	-29	LEU	-	expression tag	UNP A0A095EAP2
B	-28	VAL	-	expression tag	UNP A0A095EAP2
B	-27	PRO	-	expression tag	UNP A0A095EAP2
B	-26	ARG	-	expression tag	UNP A0A095EAP2
B	-25	GLY	-	expression tag	UNP A0A095EAP2
B	-24	SER	-	expression tag	UNP A0A095EAP2
B	-23	HIS	-	expression tag	UNP A0A095EAP2
B	-22	MSE	-	expression tag	UNP A0A095EAP2
B	-21	ALA	-	expression tag	UNP A0A095EAP2

Continued on next page...

Continued from previous page...

Chain	Residue	Modelled	Actual	Comment	Reference
B	-20	SER	-	expression tag	UNP A0A095EAP2
B	-19	MSE	-	expression tag	UNP A0A095EAP2
B	-18	THR	-	expression tag	UNP A0A095EAP2
B	-17	GLY	-	expression tag	UNP A0A095EAP2
B	-16	GLY	-	expression tag	UNP A0A095EAP2
B	-15	GLN	-	expression tag	UNP A0A095EAP2
B	-14	GLN	-	expression tag	UNP A0A095EAP2
B	-13	MSE	-	expression tag	UNP A0A095EAP2
B	-12	GLY	-	expression tag	UNP A0A095EAP2
B	-11	ARG	-	expression tag	UNP A0A095EAP2
B	-10	GLY	-	expression tag	UNP A0A095EAP2
B	-9	SER	-	expression tag	UNP A0A095EAP2
B	-8	GLU	-	expression tag	UNP A0A095EAP2
B	-7	PHE	-	expression tag	UNP A0A095EAP2
B	-6	GLU	-	expression tag	UNP A0A095EAP2
B	-5	LEU	-	expression tag	UNP A0A095EAP2
B	-4	ARG	-	expression tag	UNP A0A095EAP2
B	-3	ARG	-	expression tag	UNP A0A095EAP2
B	-2	GLN	-	expression tag	UNP A0A095EAP2
B	-1	ALA	-	expression tag	UNP A0A095EAP2
B	0	SER	-	expression tag	UNP A0A095EAP2
C	-42	MSE	-	initiating methionine	UNP A0A095EAP2
C	-41	GLY	-	expression tag	UNP A0A095EAP2
C	-40	SER	-	expression tag	UNP A0A095EAP2
C	-39	SER	-	expression tag	UNP A0A095EAP2
C	-38	HIS	-	expression tag	UNP A0A095EAP2
C	-37	HIS	-	expression tag	UNP A0A095EAP2
C	-36	HIS	-	expression tag	UNP A0A095EAP2
C	-35	HIS	-	expression tag	UNP A0A095EAP2
C	-34	HIS	-	expression tag	UNP A0A095EAP2
C	-33	HIS	-	expression tag	UNP A0A095EAP2
C	-32	SER	-	expression tag	UNP A0A095EAP2
C	-31	SER	-	expression tag	UNP A0A095EAP2
C	-30	GLY	-	expression tag	UNP A0A095EAP2
C	-29	LEU	-	expression tag	UNP A0A095EAP2
C	-28	VAL	-	expression tag	UNP A0A095EAP2
C	-27	PRO	-	expression tag	UNP A0A095EAP2
C	-26	ARG	-	expression tag	UNP A0A095EAP2
C	-25	GLY	-	expression tag	UNP A0A095EAP2
C	-24	SER	-	expression tag	UNP A0A095EAP2
C	-23	HIS	-	expression tag	UNP A0A095EAP2
C	-22	MSE	-	expression tag	UNP A0A095EAP2

Continued on next page...

Continued from previous page...

Chain	Residue	Modelled	Actual	Comment	Reference
C	-21	ALA	-	expression tag	UNP A0A095EAP2
C	-20	SER	-	expression tag	UNP A0A095EAP2
C	-19	MSE	-	expression tag	UNP A0A095EAP2
C	-18	THR	-	expression tag	UNP A0A095EAP2
C	-17	GLY	-	expression tag	UNP A0A095EAP2
C	-16	GLY	-	expression tag	UNP A0A095EAP2
C	-15	GLN	-	expression tag	UNP A0A095EAP2
C	-14	GLN	-	expression tag	UNP A0A095EAP2
C	-13	MSE	-	expression tag	UNP A0A095EAP2
C	-12	GLY	-	expression tag	UNP A0A095EAP2
C	-11	ARG	-	expression tag	UNP A0A095EAP2
C	-10	GLY	-	expression tag	UNP A0A095EAP2
C	-9	SER	-	expression tag	UNP A0A095EAP2
C	-8	GLU	-	expression tag	UNP A0A095EAP2
C	-7	PHE	-	expression tag	UNP A0A095EAP2
C	-6	GLU	-	expression tag	UNP A0A095EAP2
C	-5	LEU	-	expression tag	UNP A0A095EAP2
C	-4	ARG	-	expression tag	UNP A0A095EAP2
C	-3	ARG	-	expression tag	UNP A0A095EAP2
C	-2	GLN	-	expression tag	UNP A0A095EAP2
C	-1	ALA	-	expression tag	UNP A0A095EAP2
C	0	SER	-	expression tag	UNP A0A095EAP2

- Molecule 2 is PLATINUM (II) ION (three-letter code: PT) (formula: Pt) (labeled as "Ligand of Interest" by depositor).

Mol	Chain	Residues	Atoms	ZeroOcc	AltConf
2	A	3	Total Pt 3 3	0	0
2	B	3	Total Pt 3 3	0	0
2	C	3	Total Pt 3 3	0	0



4 Data and refinement statistics

Property	Value	Source
Space group	P 41 21 2	Depositor
Cell constants a, b, c, α , β , γ	74.85Å 74.85Å 191.89Å 90.00° 90.00° 90.00°	Depositor
Resolution (Å)	35.55 – 3.06 35.54 – 3.06	Depositor EDS
% Data completeness (in resolution range)	94.0 (35.55-3.06) 90.6 (35.54-3.06)	Depositor EDS
R_{merge}	0.10	Depositor
R_{sym}	(Not available)	Depositor
$\langle I/\sigma(I) \rangle$ ¹	1.62 (at 3.06Å)	Xtrriage
Refinement program	PHENIX 1.14_3260	Depositor
R, R_{free}	0.243 , 0.297 0.255 , 0.303	Depositor DCC
R_{free} test set	1038 reflections (10.04%)	wwPDB-VP
Wilson B-factor (Å ²)	96.9	Xtrriage
Anisotropy	0.227	Xtrriage
Bulk solvent k_{sol} (e/Å ³), B_{sol} (Å ²)	0.30 , 49.0	EDS
L-test for twinning ²	$\langle L \rangle = 0.42$, $\langle L^2 \rangle = 0.25$	Xtrriage
Estimated twinning fraction	No twinning to report.	Xtrriage
F_o, F_c correlation	0.89	EDS
Total number of atoms	3453	wwPDB-VP
Average B, all atoms (Å ²)	97.0	wwPDB-VP

Xtrriage's analysis on translational NCS is as follows: *The largest off-origin peak in the Patterson function is 5.90% of the height of the origin peak. No significant pseudotranslation is detected.*

¹Intensities estimated from amplitudes.

²Theoretical values of $\langle |L| \rangle$, $\langle L^2 \rangle$ for acentric reflections are 0.5, 0.333 respectively for untwinned datasets, and 0.375, 0.2 for perfectly twinned datasets.

5 Model quality [i](#)

5.1 Standard geometry [i](#)

Bond lengths and bond angles in the following residue types are not validated in this section: PT

The Z score for a bond length (or angle) is the number of standard deviations the observed value is removed from the expected value. A bond length (or angle) with $|Z| > 5$ is considered an outlier worth inspection. RMSZ is the root-mean-square of all Z scores of the bond lengths (or angles).

Mol	Chain	Bond lengths		Bond angles	
		RMSZ	# Z >5	RMSZ	# Z >5
1	A	0.23	0/1163	0.44	0/1565
1	B	0.23	0/1163	0.43	0/1565
1	C	0.23	0/1163	0.43	0/1565
All	All	0.23	0/3489	0.43	0/4695

There are no bond length outliers.

There are no bond angle outliers.

There are no chirality outliers.

There are no planarity outliers.

5.2 Too-close contacts [i](#)

In the following table, the Non-H and H(model) columns list the number of non-hydrogen atoms and hydrogen atoms in the chain respectively. The H(added) column lists the number of hydrogen atoms added and optimized by MolProbity. The Clashes column lists the number of clashes within the asymmetric unit, whereas Symm-Clashes lists symmetry-related clashes.

Mol	Chain	Non-H	H(model)	H(added)	Clashes	Symm-Clashes
1	A	1148	0	1139	11	0
1	B	1148	0	1139	9	0
1	C	1148	0	1139	9	0
2	A	3	0	0	0	0
2	B	3	0	0	0	0
2	C	3	0	0	0	0
All	All	3453	0	3417	29	0

The all-atom clashscore is defined as the number of clashes found per 1000 atoms (including hydrogen atoms). The all-atom clashscore for this structure is 4.

All (29) close contacts within the same asymmetric unit are listed below, sorted by their clash magnitude.

Atom-1	Atom-2	Interatomic distance (Å)	Clash overlap (Å)
1:A:100:ASP:OD1	1:A:103:ARG:NH2	2.30	0.65
1:C:116:ARG:NH2	1:C:164:ASP:O	2.35	0.59
1:B:55:LEU:HD21	1:B:116:ARG:HH11	1.67	0.58
1:A:162:ARG:NH2	1:A:164:ASP:OD2	2.36	0.54
1:C:100:ASP:OD1	1:C:103:ARG:NH2	2.42	0.53
1:B:28:LEU:HD13	1:B:29:GLY:O	2.09	0.52
1:A:100:ASP:O	1:A:104:LEU:HD13	2.09	0.52
1:A:51:LYS:HB2	1:A:139:SER:OG	2.09	0.52
1:C:93:ARG:NH1	1:C:95:ASP:OD1	2.44	0.51
1:C:51:LYS:NZ	1:C:57:ASP:OD2	2.41	0.49
1:A:110:GLN:O	1:A:113:ARG:NH2	2.39	0.49
1:B:93:ARG:NH1	1:B:95:ASP:OD1	2.45	0.49
1:C:53:ASP:N	1:C:53:ASP:OD1	2.46	0.48
1:A:53:ASP:OD1	1:A:53:ASP:N	2.47	0.48
1:B:53:ASP:N	1:B:53:ASP:OD1	2.47	0.47
1:A:35:ARG:HB3	1:A:154:VAL:HG13	1.97	0.46
1:B:114:LEU:HG	1:B:137:ILE:HD11	1.97	0.46
1:A:53:ASP:HB3	1:A:138:MSE:HE2	1.96	0.46
1:A:93:ARG:NH1	1:A:95:ASP:OD1	2.42	0.45
1:C:158:SER:HB2	1:C:170:ASN:ND2	2.33	0.44
1:B:162:ARG:NH2	1:B:164:ASP:OD2	2.43	0.44
1:B:10:ARG:O	1:B:28:LEU:HB2	2.18	0.43
1:B:110:GLN:O	1:B:113:ARG:NH1	2.39	0.43
1:C:35:ARG:HB3	1:C:154:VAL:HG13	2.00	0.43
1:C:114:LEU:HG	1:C:137:ILE:HD11	2.00	0.42
1:A:158:SER:HB2	1:A:170:ASN:ND2	2.34	0.42
1:B:105:PRO:HG2	1:B:108:GLU:HB2	2.01	0.41
1:A:114:LEU:HG	1:A:137:ILE:HD11	2.02	0.40
1:C:55:LEU:HD23	1:C:55:LEU:HA	1.92	0.40

There are no symmetry-related clashes.

5.3 Torsion angles [i](#)

5.3.1 Protein backbone [i](#)

In the following table, the Percentiles column shows the percent Ramachandran outliers of the chain as a percentile score with respect to all X-ray entries followed by that with respect to entries of similar resolution.

The Analysed column shows the number of residues for which the backbone conformation was analysed, and the total number of residues.

Mol	Chain	Analysed	Favoured	Allowed	Outliers	Percentiles	
1	A	134/214 (63%)	130 (97%)	4 (3%)	0	100	100
1	B	134/214 (63%)	130 (97%)	4 (3%)	0	100	100
1	C	134/214 (63%)	131 (98%)	3 (2%)	0	100	100
All	All	402/642 (63%)	391 (97%)	11 (3%)	0	100	100

There are no Ramachandran outliers to report.

5.3.2 Protein sidechains [i](#)

In the following table, the Percentiles column shows the percent sidechain outliers of the chain as a percentile score with respect to all X-ray entries followed by that with respect to entries of similar resolution.

The Analysed column shows the number of residues for which the sidechain conformation was analysed, and the total number of residues.

Mol	Chain	Analysed	Rotameric	Outliers	Percentiles	
1	A	129/187 (69%)	128 (99%)	1 (1%)	81	91
1	B	129/187 (69%)	129 (100%)	0	100	100
1	C	129/187 (69%)	129 (100%)	0	100	100
All	All	387/561 (69%)	386 (100%)	1 (0%)	92	96

All (1) residues with a non-rotameric sidechain are listed below:

Mol	Chain	Res	Type
1	A	23	GLU

Sometimes sidechains can be flipped to improve hydrogen bonding and reduce clashes. There are no such sidechains identified.

5.3.3 RNA [i](#)

There are no RNA molecules in this entry.

5.4 Non-standard residues in protein, DNA, RNA chains [i](#)

There are no non-standard protein/DNA/RNA residues in this entry.

5.5 Carbohydrates [i](#)

There are no monosaccharides in this entry.

5.6 Ligand geometry [i](#)

Of 9 ligands modelled in this entry, 9 are monoatomic - leaving 0 for Mogul analysis.

There are no bond length outliers.

There are no bond angle outliers.

There are no chirality outliers.

There are no torsion outliers.

There are no ring outliers.

No monomer is involved in short contacts.

5.7 Other polymers [i](#)

There are no such residues in this entry.

5.8 Polymer linkage issues [i](#)

There are no chain breaks in this entry.

6 Fit of model and data

6.1 Protein, DNA and RNA chains

In the following table, the column labelled ‘#RSRZ > 2’ contains the number (and percentage) of RSRZ outliers, followed by percent RSRZ outliers for the chain as percentile scores relative to all X-ray entries and entries of similar resolution. The OWAB column contains the minimum, median, 95th percentile and maximum values of the occupancy-weighted average B-factor per residue. The column labelled ‘Q < 0.9’ lists the number of (and percentage) of residues with an average occupancy less than 0.9.

Mol	Chain	Analysed	<RSRZ>	#RSRZ>2	OWAB(Å ²)	Q<0.9
1	A	139/214 (64%)	0.34	8 (5%) 23 9	64, 85, 109, 139	0
1	B	139/214 (64%)	0.58	10 (7%) 15 5	77, 104, 124, 139	0
1	C	139/214 (64%)	0.66	14 (10%) 7 2	75, 99, 119, 131	0
All	All	417/642 (64%)	0.53	32 (7%) 13 4	64, 97, 120, 139	0

All (32) RSRZ outliers are listed below:

Mol	Chain	Res	Type	RSRZ
1	C	132	ALA	7.2
1	B	113	ARG	4.0
1	B	117	SER	4.0
1	C	69	TYR	3.6
1	B	137	ILE	3.5
1	B	12	ASP	3.3
1	B	69	TYR	3.3
1	A	109	GLN	3.1
1	C	91	TYR	3.1
1	B	91	TYR	3.0
1	A	110	GLN	3.0
1	C	107	GLN	3.0
1	B	139	SER	2.8
1	C	133	THR	2.8
1	C	29	GLY	2.7
1	A	71	GLU	2.7
1	C	30	PRO	2.7
1	A	106	GLN	2.6
1	C	134	LEU	2.6
1	C	137	ILE	2.5
1	B	112	TYR	2.5
1	C	159	LEU	2.5
1	C	103	ARG	2.4

Continued on next page...

Continued from previous page...

Mol	Chain	Res	Type	RSRZ
1	C	116	ARG	2.4
1	C	55	LEU	2.3
1	A	69	TYR	2.2
1	A	134	LEU	2.2
1	B	132	ALA	2.2
1	A	112	TYR	2.2
1	C	115	PHE	2.1
1	B	156	LYS	2.1
1	A	117	SER	2.0

6.2 Non-standard residues in protein, DNA, RNA chains [\(i\)](#)

There are no non-standard protein/DNA/RNA residues in this entry.

6.3 Carbohydrates [\(i\)](#)

There are no monosaccharides in this entry.

6.4 Ligands [\(i\)](#)

In the following table, the Atoms column lists the number of modelled atoms in the group and the number defined in the chemical component dictionary. The B-factors column lists the minimum, median, 95th percentile and maximum values of B factors of atoms in the group. The column labelled 'Q< 0.9' lists the number of atoms with occupancy less than 0.9.

Mol	Type	Chain	Res	Atoms	RSCC	RSR	B-factors(Å ²)	Q<0.9
2	PT	B	203	1/1	0.10	0.13	314,314,314,314	0
2	PT	A	203	1/1	0.67	0.13	199,199,199,199	0
2	PT	C	203	1/1	0.69	0.32	233,233,233,233	0
2	PT	B	202	1/1	0.70	0.22	284,284,284,284	0
2	PT	C	202	1/1	0.85	0.22	281,281,281,281	0
2	PT	A	201	1/1	0.97	0.10	270,270,270,270	0
2	PT	B	201	1/1	0.97	0.06	237,237,237,237	0
2	PT	A	202	1/1	0.97	0.20	119,119,119,119	0
2	PT	C	201	1/1	0.98	0.10	194,194,194,194	0

The following is a graphical depiction of the model fit to experimental electron density of all instances of the Ligand of Interest. In addition, ligands with molecular weight > 250 and outliers as shown on the geometry validation Tables will also be included. Each fit is shown from different orientation to approximate a three-dimensional view.

Electron density around PT B 203:

$2mF_o-DF_c$ (at 0.7 rmsd) in gray
 mF_o-DF_c (at 3 rmsd) in purple (negative)
and green (positive)

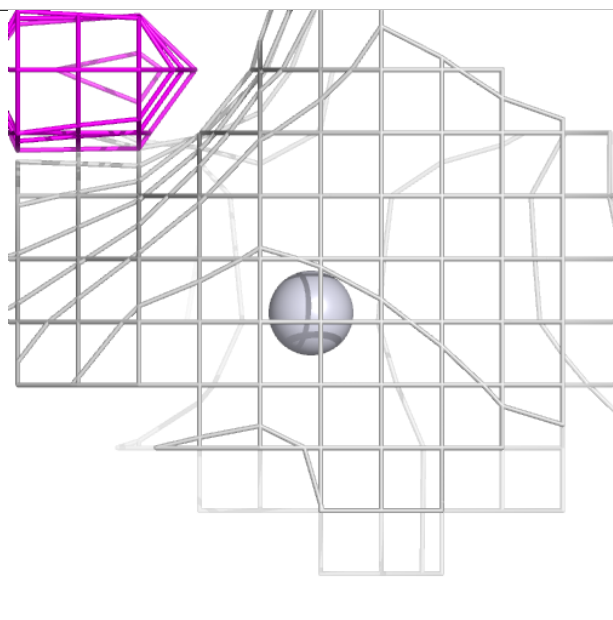
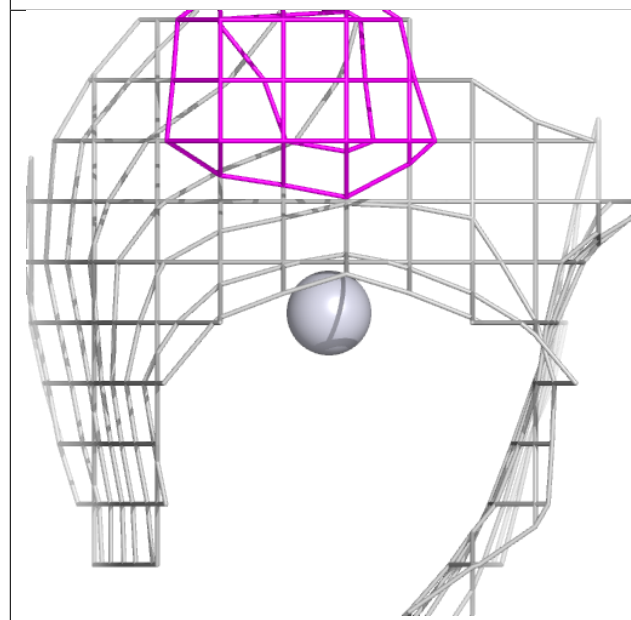
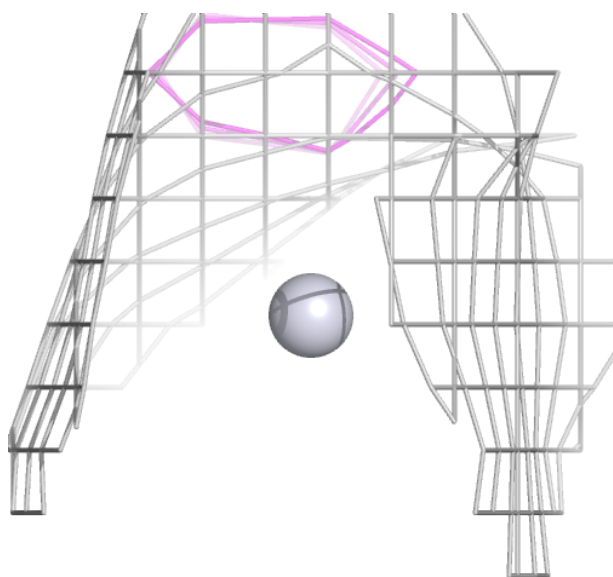

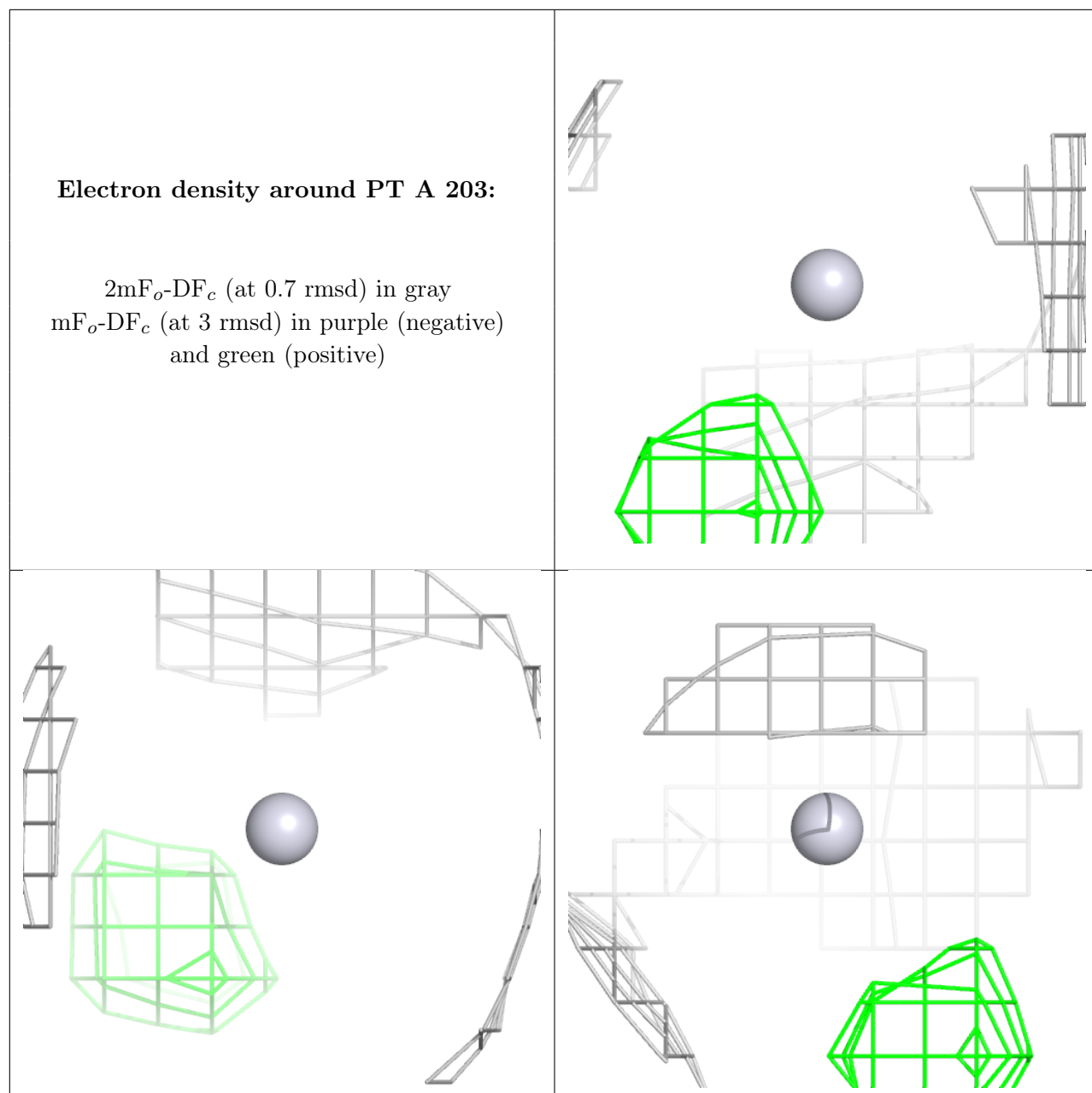

Electron density around PT C 203:

$2mF_o-DF_c$ (at 0.7 rmsd) in gray
 mF_o-DF_c (at 3 rmsd) in purple (negative)
and green (positive)

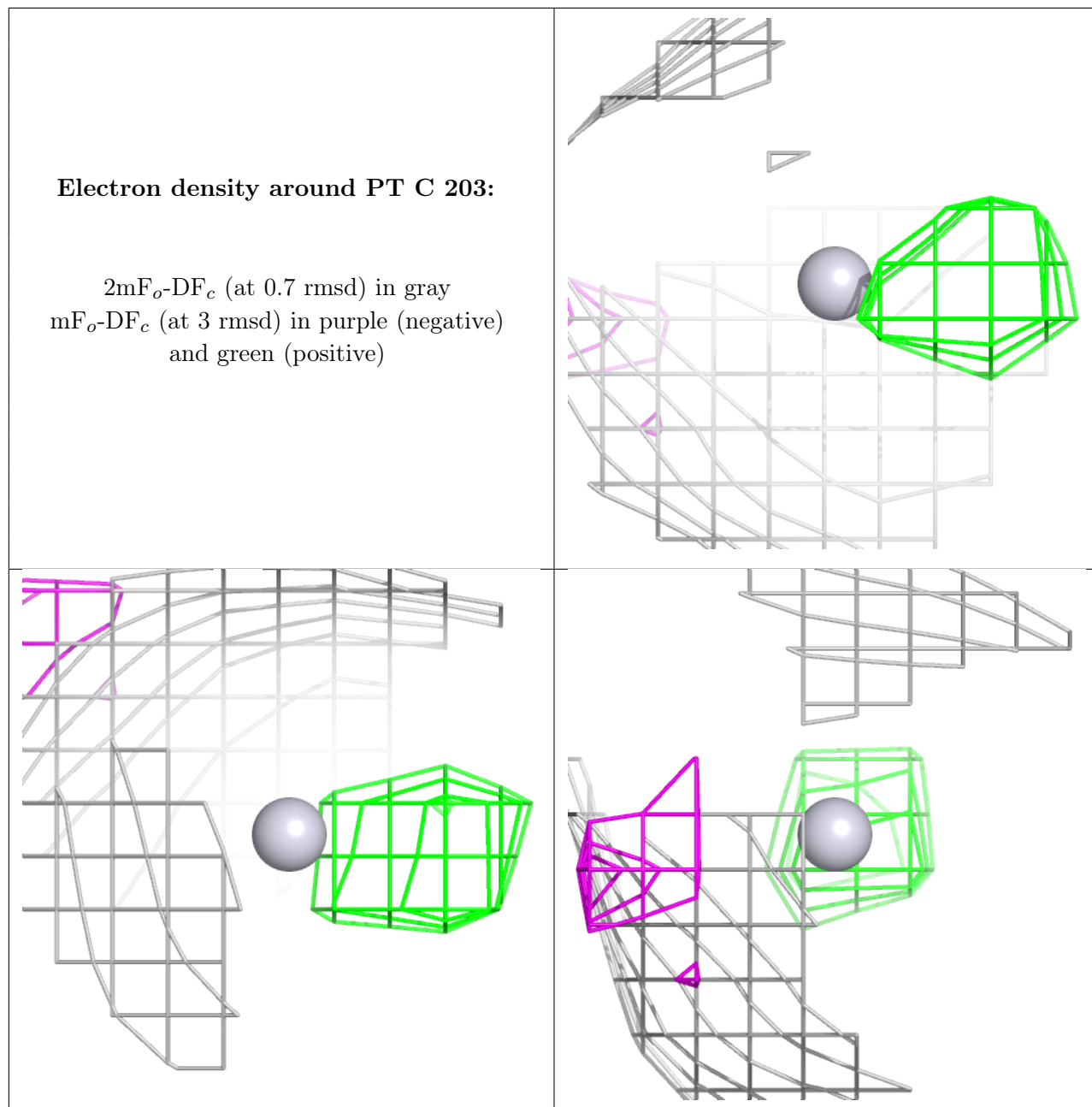

Electron density around PT B 202:

$2mF_o-DF_c$ (at 0.7 rmsd) in gray
 mF_o-DF_c (at 3 rmsd) in purple (negative)
and green (positive)

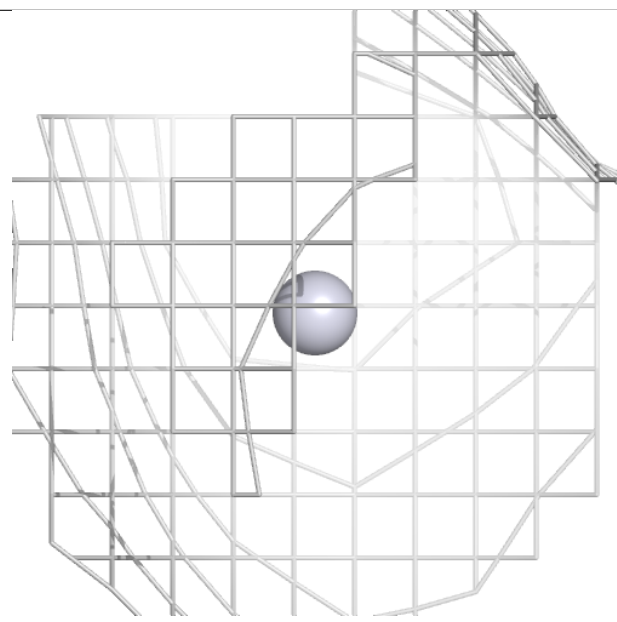
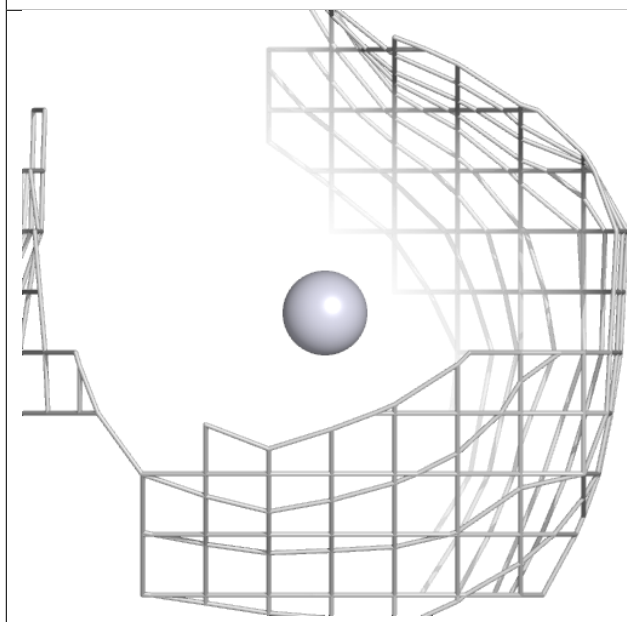
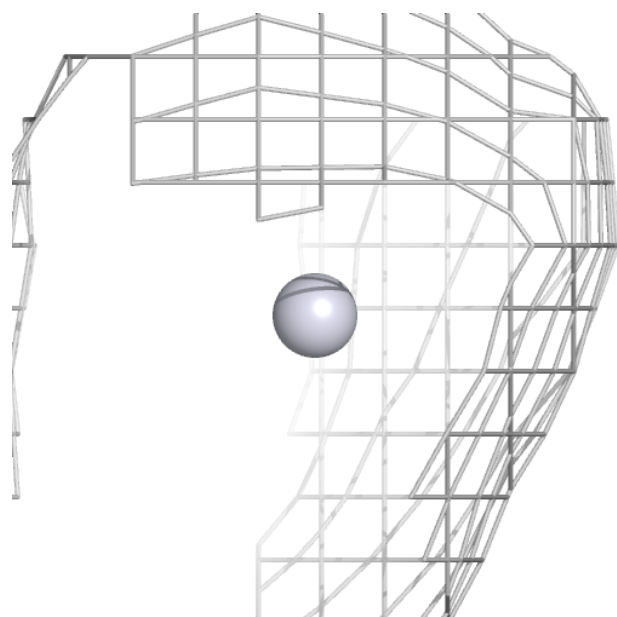

Electron density around PT C 202:

$2mF_o-DF_c$ (at 0.7 rmsd) in gray
 mF_o-DF_c (at 3 rmsd) in purple (negative)
and green (positive)

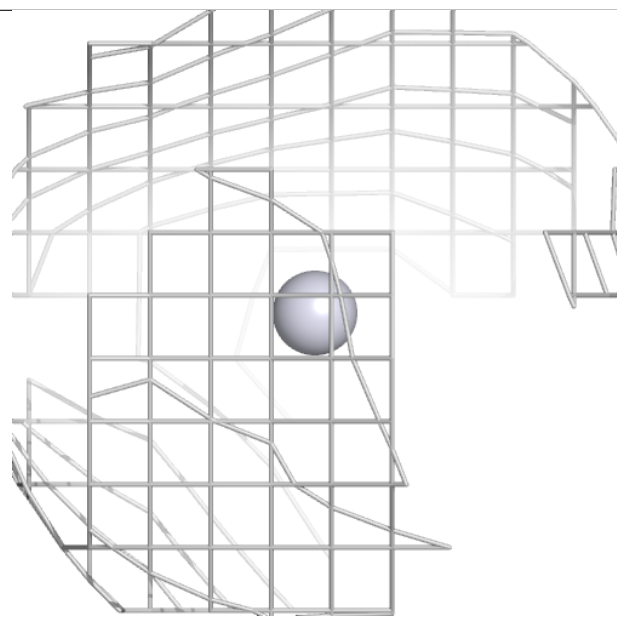
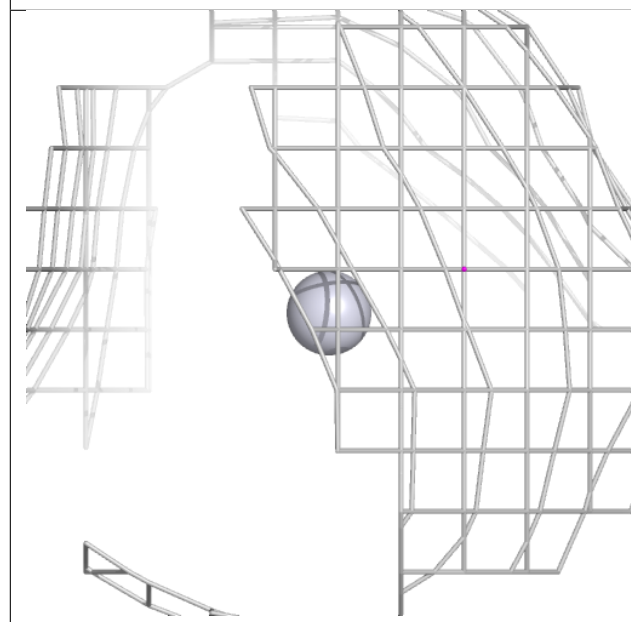
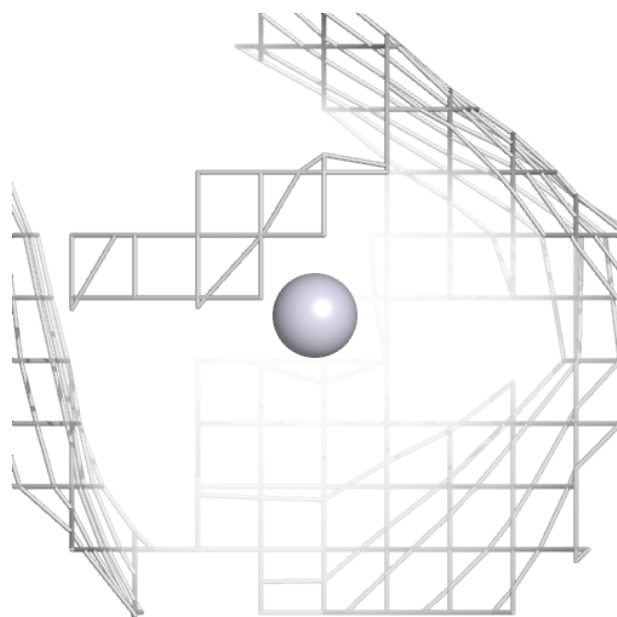

Electron density around PT A 201:

$2mF_o-DF_c$ (at 0.7 rmsd) in gray
 mF_o-DF_c (at 3 rmsd) in purple (negative)
and green (positive)

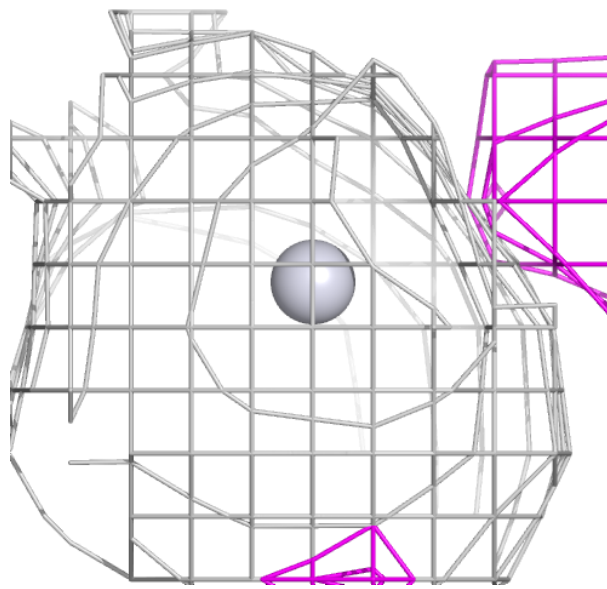
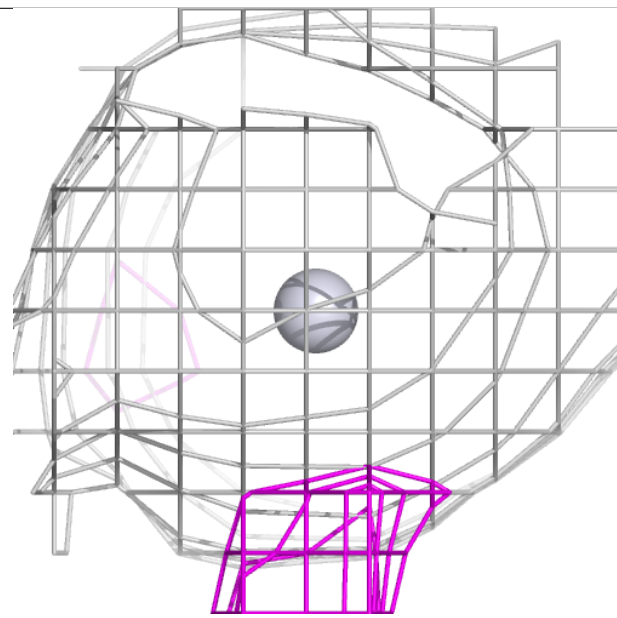
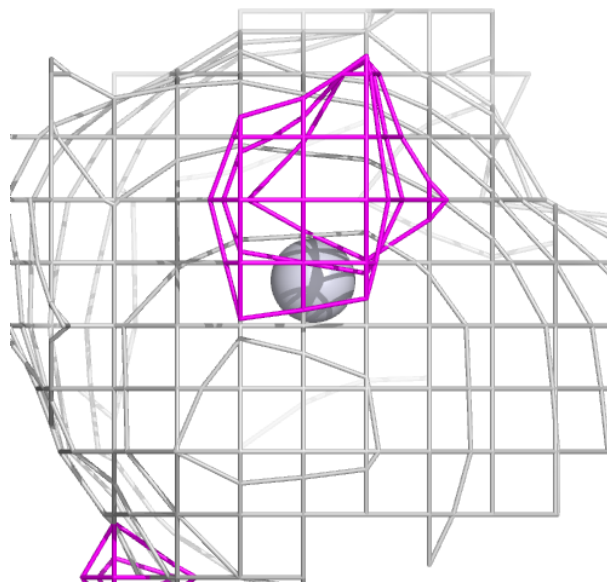

Electron density around PT B 201:

$2mF_o-DF_c$ (at 0.7 rmsd) in gray
 mF_o-DF_c (at 3 rmsd) in purple (negative)
and green (positive)

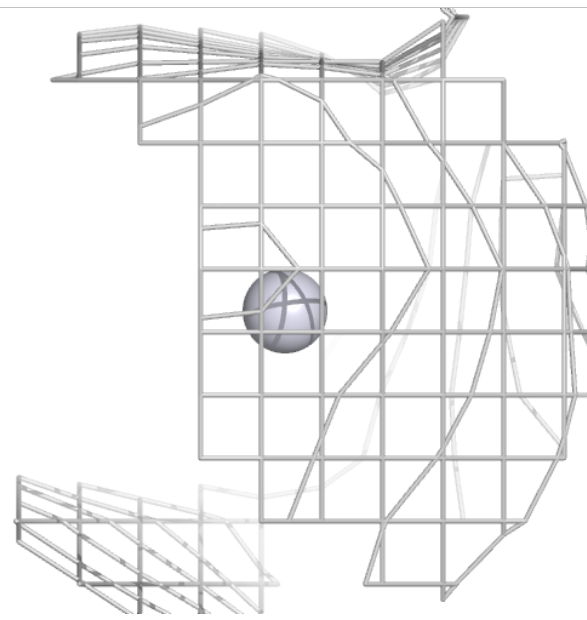
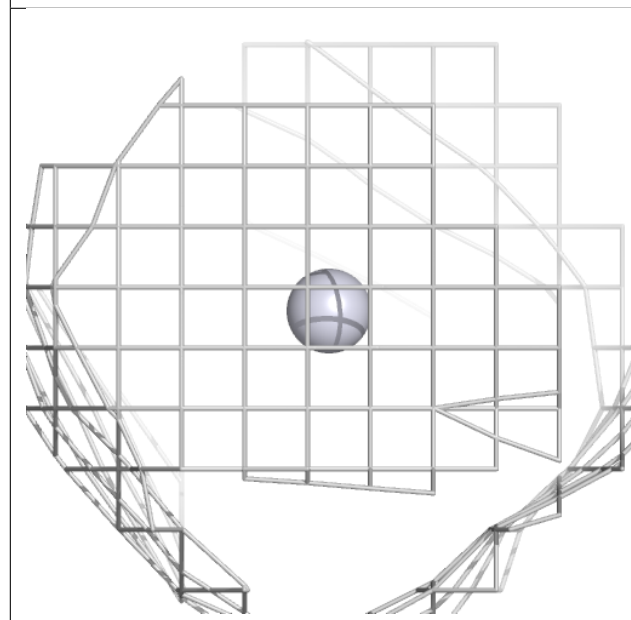
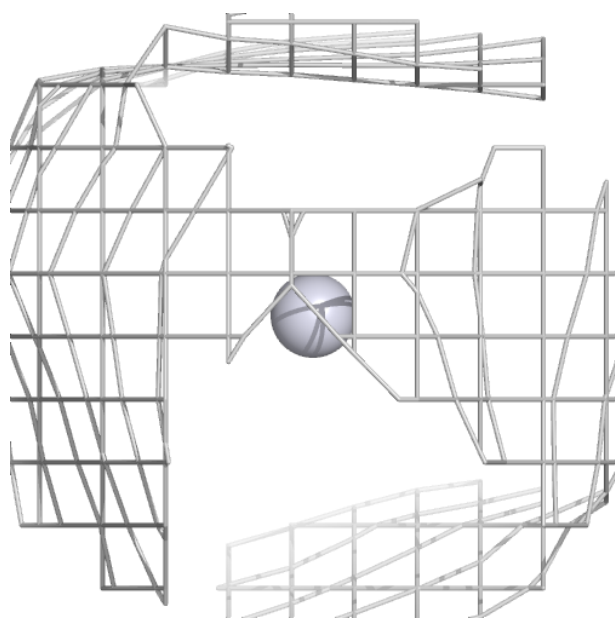

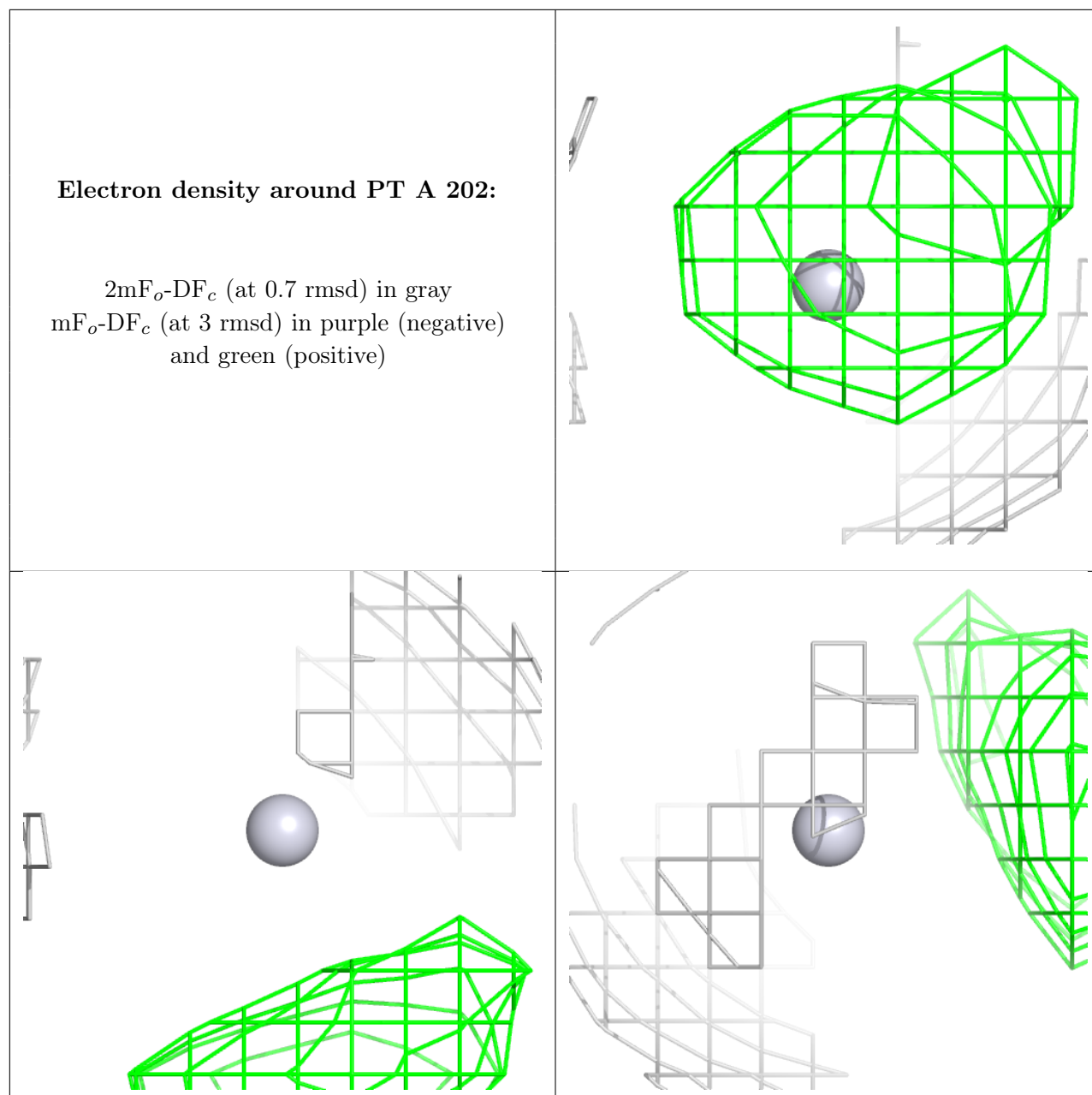

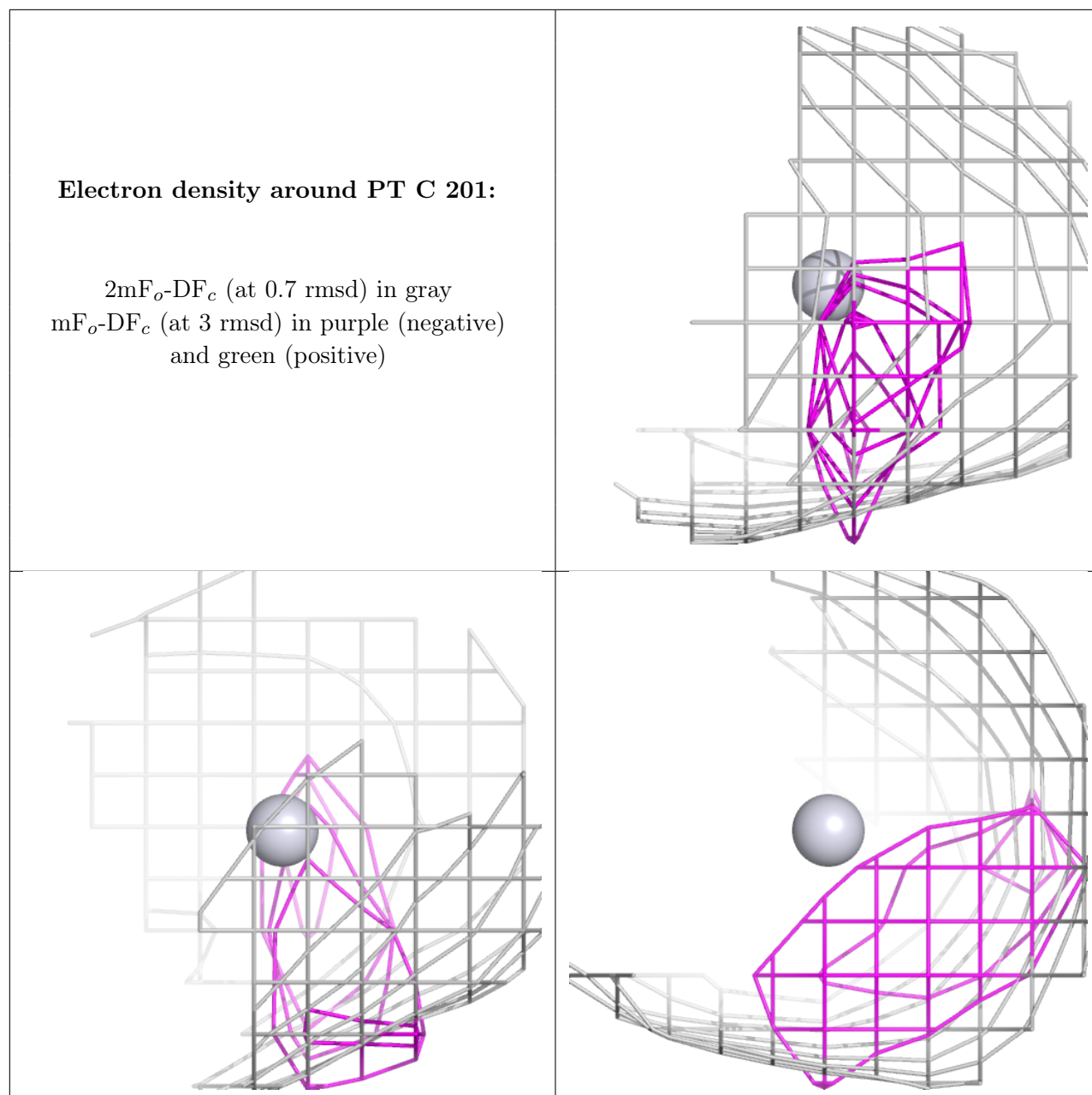

6.5 Other polymers [i](#)

There are no such residues in this entry.