



Full wwPDB EM Validation Report ⓘ

Nov 8, 2022 – 12:58 PM EST

PDB ID : 6MUI
EMDB ID : EMD-9249
Title : CryoEM structure of chimeric Eastern Equine Encephalitis Virus with Fab of
EEEV-42 antibody
Authors : Hasan, S.S.; Sun, C.; Kim, A.S.; Watanabe, Y.; Chen, C.L.; Klose, T.; Buda,
G.; Crispin, M.; Diamond, M.S.; Klimstra, W.B.; Rossmann, M.G.
Deposited on : 2018-10-23
Resolution : 7.70 Å(reported)

This is a Full wwPDB EM Validation Report for a publicly released PDB entry.

We welcome your comments at validation@mail.wwpdb.org

A user guide is available at

<https://www.wwpdb.org/validation/2017/EMValidationReportHelp>

with specific help available everywhere you see the ⓘ symbol.

The types of validation reports are described at

<http://www.wwpdb.org/validation/2017/FAQs#types>.

The following versions of software and data (see [references ⓘ](#)) were used in the production of this report:

EMDB validation analysis : 0.0.1.dev43
MolProbity : 4.02b-467
Percentile statistics : 20191225.v01 (using entries in the PDB archive December 25th 2019)
MapQ : 1.9.9
Ideal geometry (proteins) : Engh & Huber (2001)
Ideal geometry (DNA, RNA) : Parkinson et al. (1996)
Validation Pipeline (wwPDB-VP) : 2.31.2

1 Overall quality at a glance

The following experimental techniques were used to determine the structure:

ELECTRON MICROSCOPY

The reported resolution of this entry is 7.70 Å.

Percentile scores (ranging between 0-100) for global validation metrics of the entry are shown in the following graphic. The table shows the number of entries on which the scores are based.

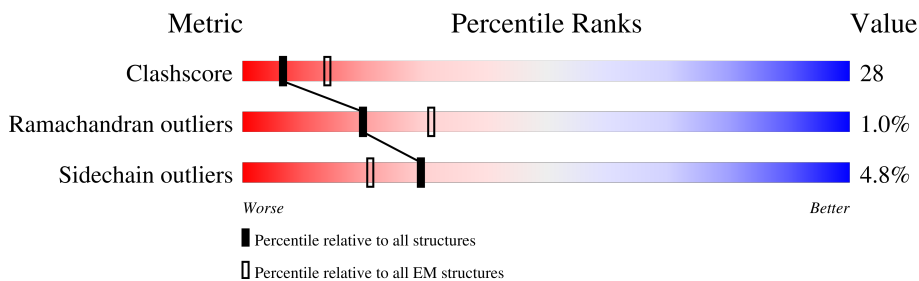

Metric	Whole archive (#Entries)	EM structures (#Entries)
Clashscore	158937	4297
Ramachandran outliers	154571	4023
Sidechain outliers	154315	3826

The table below summarises the geometric issues observed across the polymeric chains and their fit to the map. The red, orange, yellow and green segments of the bar indicate the fraction of residues that contain outliers for ≥ 3 , 2, 1 and 0 types of geometric quality criteria respectively. A grey segment represents the fraction of residues that are not modelled. The numeric value for each fraction is indicated below the corresponding segment, with a dot representing fractions $\leq 5\%$. The upper red bar (where present) indicates the fraction of residues that have poor fit to the EM map (all-atom inclusion $< 40\%$). The numeric value is given above the bar.

Mol	Chain	Length	Quality of chain
1	A	441	 8% 70% 20% • 9%
1	E	441	 12% 71% 19% • 9%
1	I	441	 8% 70% 20% • 9%
1	M	441	 13% 71% 19% • 9%
2	B	477	 54% 14% 32%
2	F	477	 52% 16% 32%
2	J	477	 5% 53% 15% 32%
2	N	477	 8% 52% 16% 32%

Continued on next page...

Continued from previous page...

Mol	Chain	Length	Quality of chain
3	C	218	<p>11% 59% 36% . .</p>
3	G	218	<p>14% 59% 37% . .</p>
3	K	218	<p>17% 59% 36% . .</p>
3	O	218	<p>13% 58% 36% 5% . .</p>
4	D	214	<p>9% 44% 41% 12% . .</p>
4	H	214	<p>8% 40% 45% 13% . .</p>
4	L	214	<p>10% 43% 43% 13% . .</p>
4	P	214	<p>12% 41% 44% 13% . .</p>

2 Entry composition [i](#)

There are 4 unique types of molecules in this entry. The entry contains 35528 atoms, of which 0 are hydrogens and 0 are deuteriums.

In the tables below, the AltConf column contains the number of residues with at least one atom in alternate conformation and the Trace column contains the number of residues modelled with at most 2 atoms.

- Molecule 1 is a protein called E1.

Mol	Chain	Residues	Atoms					AltConf	Trace
			Total	C	N	O	S		
1	A	400	Total 3063	C 1940	N 511	O 592	S 20	0	0
1	E	400	Total 3063	C 1940	N 511	O 592	S 20	0	0
1	I	400	Total 3063	C 1940	N 511	O 592	S 20	0	0
1	M	400	Total 3063	C 1940	N 511	O 592	S 20	0	0

- Molecule 2 is a protein called E2.

Mol	Chain	Residues	Atoms					AltConf	Trace
			Total	C	N	O	S		
2	B	325	Total 2550	C 1601	N 471	O 462	S 16	0	0
2	F	325	Total 2550	C 1601	N 471	O 462	S 16	0	0
2	J	325	Total 2550	C 1601	N 471	O 462	S 16	0	0
2	N	325	Total 2550	C 1601	N 471	O 462	S 16	0	0

- Molecule 3 is a protein called EEEV-42 antibody heavy chain.

Mol	Chain	Residues	Atoms					AltConf	Trace
			Total	C	N	O	S		
3	C	218	Total 1671	C 1066	N 272	O 326	S 7	0	0
3	G	218	Total 1671	C 1066	N 272	O 326	S 7	0	0
3	K	218	Total 1671	C 1066	N 272	O 326	S 7	0	0
3	O	218	Total 1671	C 1066	N 272	O 326	S 7	0	0

- Molecule 4 is a protein called EEEV-42 antibody light chain.

Mol	Chain	Residues	Atoms					AltConf	Trace
			Total	C	N	O	S		
4	D	211	1598	999	270	322	7	0	0
4	H	211	1598	999	270	322	7	0	0
4	L	211	1598	999	270	322	7	0	0
4	P	211	1598	999	270	322	7	0	0

3 Residue-property plots

These plots are drawn for all protein, RNA, DNA and oligosaccharide chains in the entry. The first graphic for a chain summarises the proportions of the various outlier classes displayed in the second graphic. The second graphic shows the sequence view annotated by issues in geometry and atom inclusion in map density. Residues are color-coded according to the number of geometric quality criteria for which they contain at least one outlier: green = 0, yellow = 1, orange = 2 and red = 3 or more. A red diamond above a residue indicates a poor fit to the EM map for this residue (all-atom inclusion < 40%). Stretches of 2 or more consecutive residues without any outlier are shown as a green connector. Residues present in the sample, but not in the model, are shown in grey.

- Molecule 1: E1

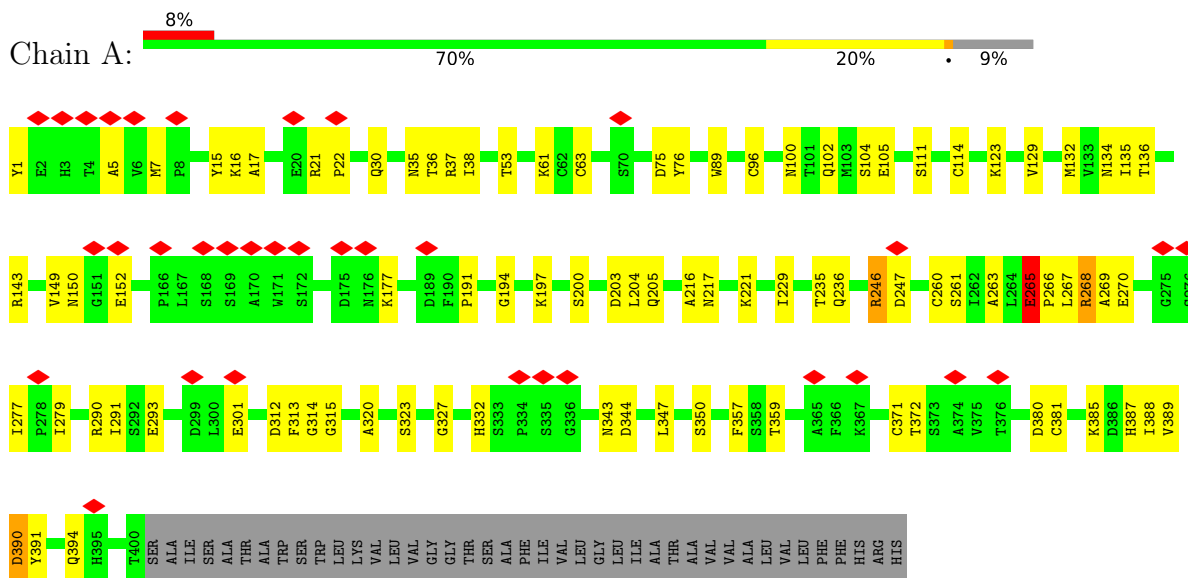

- Molecule 1: E1

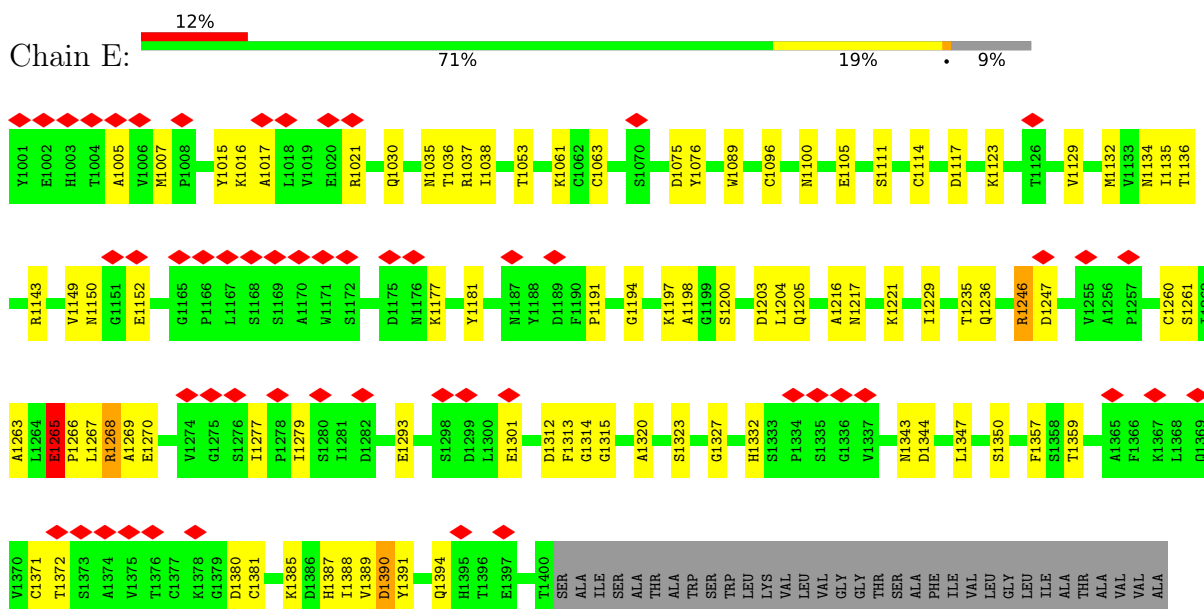

LEU
VAL
LEU
PHE
PHE
HIS
ARG
HIS

• Molecule 1: E1

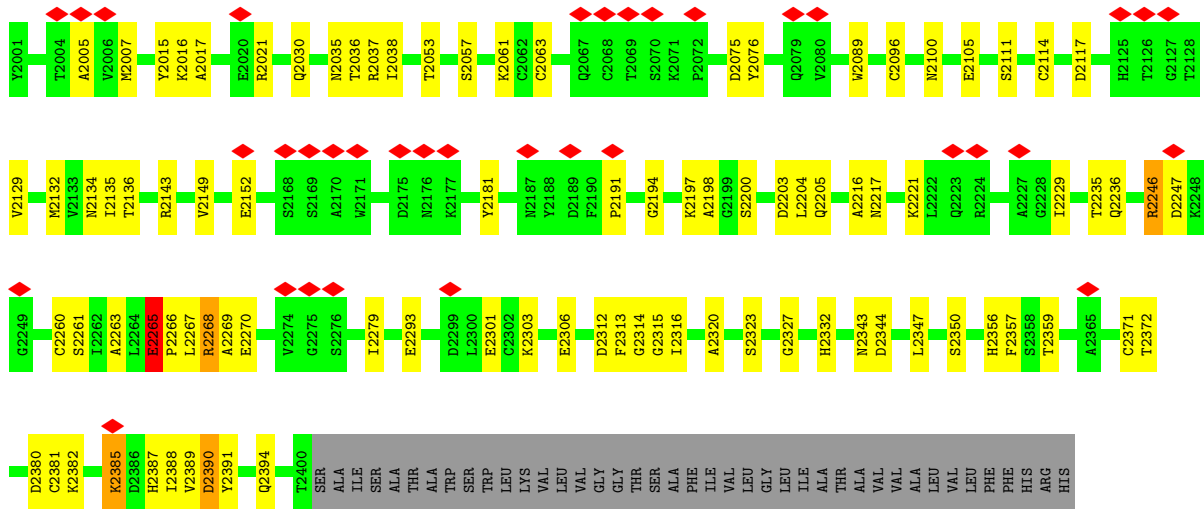

• Molecule 1: E1

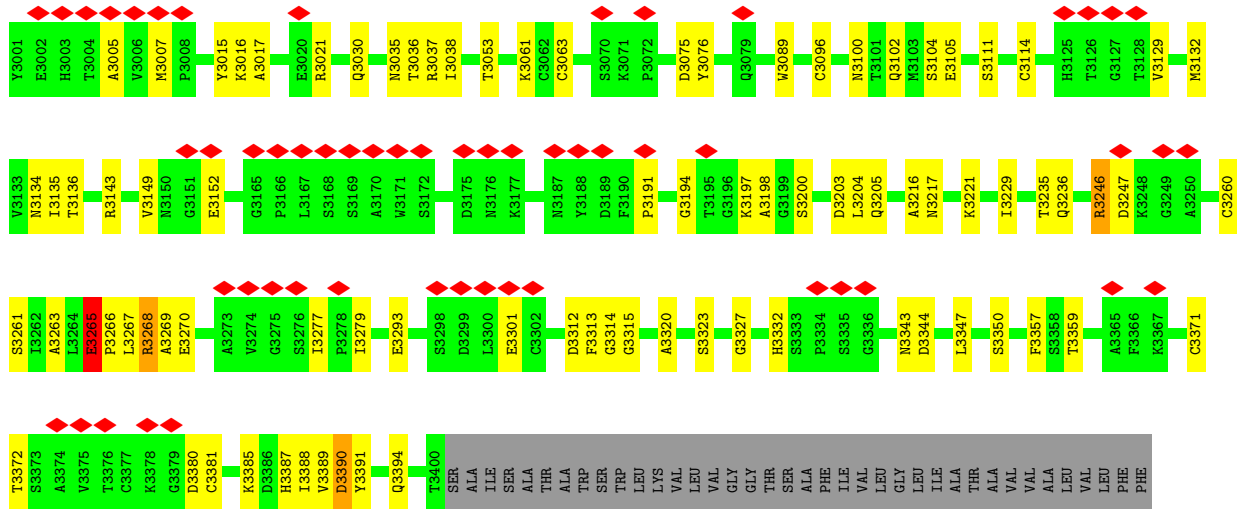
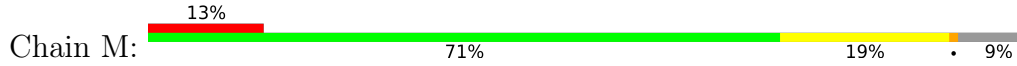

HIS
ARG
HIS

• Molecule 2: E2



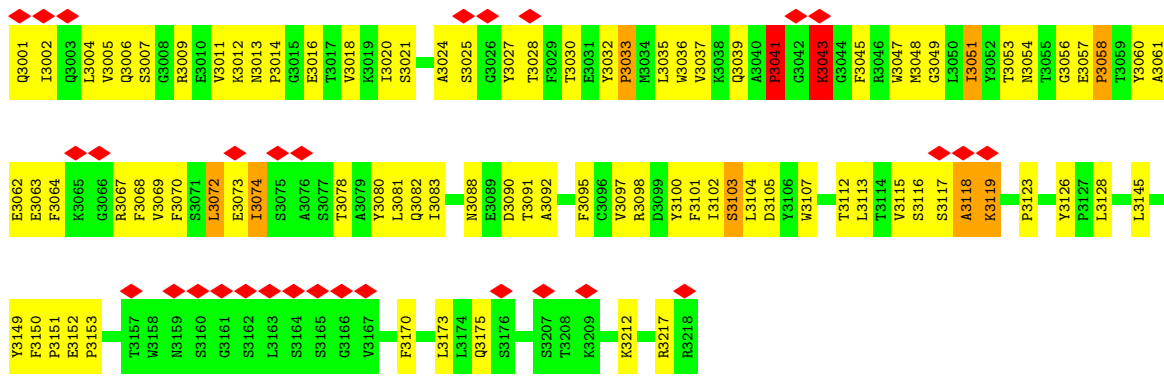

• Molecule 3: EEEV-42 antibody heavy chain

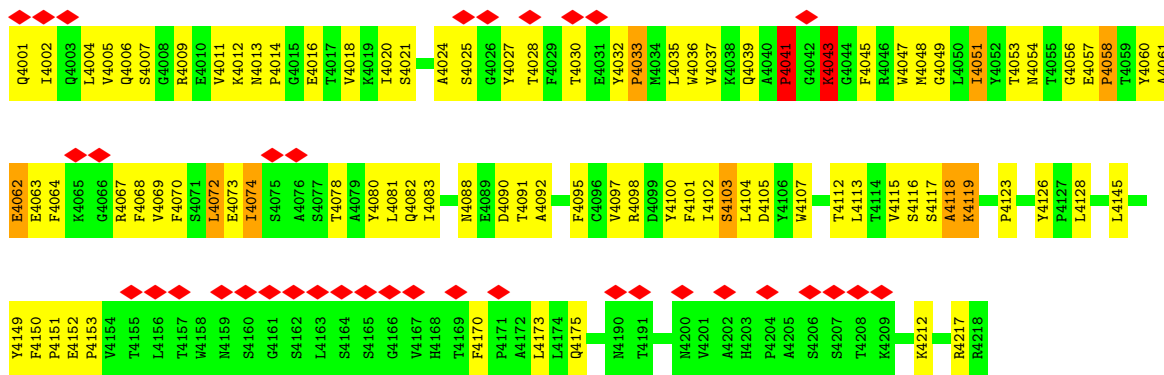

• Molecule 3: EEEV-42 antibody heavy chain

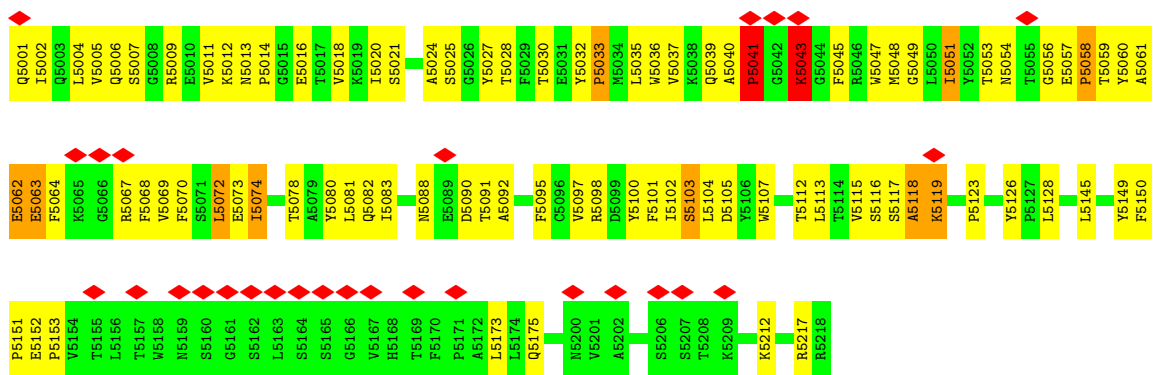

• Molecule 4: EEEV-42 antibody light chain

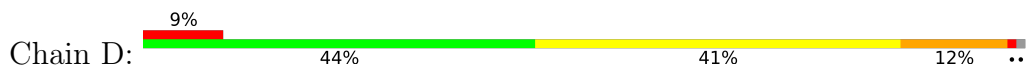

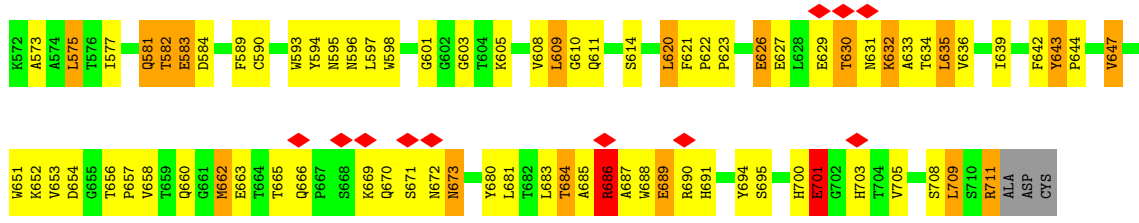

• Molecule 4: EEEV-42 antibody light chain

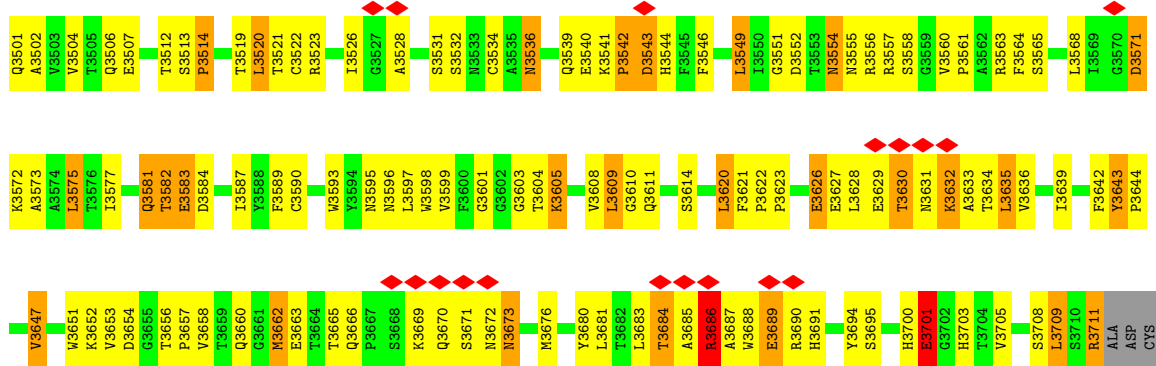

• Molecule 4: EEEV-42 antibody light chain

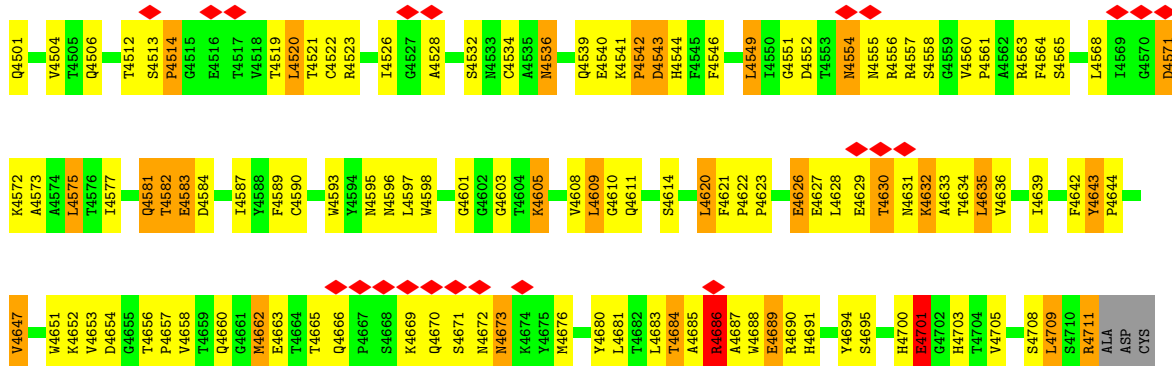

• Molecule 4: EEEV-42 antibody light chain

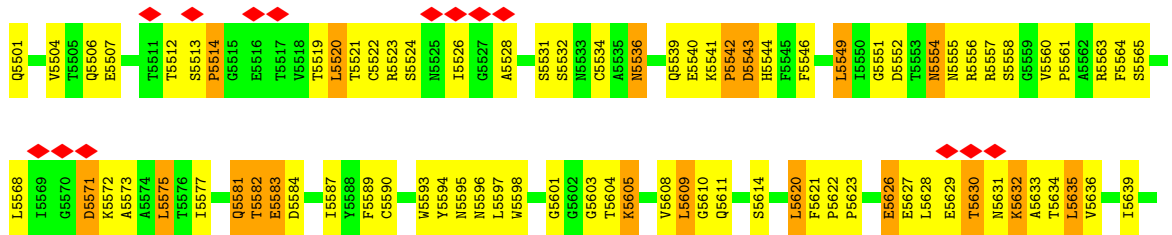

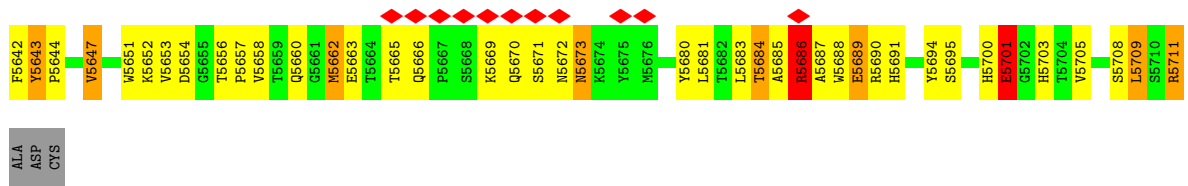

4 Experimental information

Property	Value	Source
EM reconstruction method	SINGLE PARTICLE	Depositor
Imposed symmetry	POINT, Not provided	
Number of particles used	4733	Depositor
Resolution determination method	FSC 0.143 CUT-OFF	Depositor
CTF correction method	PHASE FLIPPING AND AMPLITUDE CORRECTION	Depositor
Microscope	FEI TITAN KRIOS	Depositor
Voltage (kV)	300	Depositor
Electron dose ($e^-/\text{\AA}^2$)	31	Depositor
Minimum defocus (nm)	Not provided	
Maximum defocus (nm)	Not provided	
Magnification	Not provided	
Image detector	GATAN K2 SUMMIT (4k x 4k)	Depositor
Maximum map value	6.244	Depositor
Minimum map value	-6.627	Depositor
Average map value	0.057	Depositor
Map value standard deviation	0.832	Depositor
Recommended contour level	0.7	Depositor
Map size (Å)	907.2, 907.2, 907.2	wwPDB
Map dimensions	560, 560, 560	wwPDB
Map angles (°)	90.0, 90.0, 90.0	wwPDB
Pixel spacing (Å)	1.62, 1.62, 1.62	Depositor

5 Model quality i

5.1 Standard geometry i

The Z score for a bond length (or angle) is the number of standard deviations the observed value is removed from the expected value. A bond length (or angle) with $|Z| > 5$ is considered an outlier worth inspection. RMSZ is the root-mean-square of all Z scores of the bond lengths (or angles).

Mol	Chain	Bond lengths		Bond angles	
		RMSZ	# Z >5	RMSZ	# Z >5
1	A	0.51	0/3147	0.69	1/4294 (0.0%)
1	E	0.51	0/3147	0.69	1/4294 (0.0%)
1	I	0.51	0/3147	0.69	1/4294 (0.0%)
1	M	0.51	0/3147	0.69	1/4294 (0.0%)
2	B	0.50	1/2624 (0.0%)	0.74	2/3571 (0.1%)
2	F	0.50	1/2624 (0.0%)	0.74	2/3571 (0.1%)
2	J	0.50	1/2624 (0.0%)	0.74	3/3571 (0.1%)
2	N	0.50	1/2624 (0.0%)	0.74	3/3571 (0.1%)
3	C	0.73	4/1714 (0.2%)	0.86	3/2340 (0.1%)
3	G	0.73	4/1714 (0.2%)	0.86	3/2340 (0.1%)
3	K	0.73	4/1714 (0.2%)	0.86	3/2340 (0.1%)
3	O	0.73	4/1714 (0.2%)	0.86	3/2340 (0.1%)
4	D	0.91	3/1634 (0.2%)	1.44	12/2232 (0.5%)
4	H	0.91	3/1634 (0.2%)	1.44	12/2232 (0.5%)
4	L	0.91	3/1634 (0.2%)	1.44	12/2232 (0.5%)
4	P	0.91	3/1634 (0.2%)	1.44	12/2232 (0.5%)
All	All	0.64	32/36476 (0.1%)	0.91	74/49748 (0.1%)

Chiral center outliers are detected by calculating the chiral volume of a chiral center and verifying if the center is modelled as a planar moiety or with the opposite hand. A planarity outlier is detected by checking planarity of atoms in a peptide group, atoms in a mainchain group or atoms of a sidechain that are expected to be planar.

Mol	Chain	#Chirality outliers	#Planarity outliers
1	A	0	1
1	E	0	1
1	I	0	1
1	M	0	1
All	All	0	4

All (32) bond length outliers are listed below:

Mol	Chain	Res	Type	Atoms	Z	Observed(Å)	Ideal(Å)
3	C	58	PRO	N-CD	17.41	1.72	1.47
3	G	3058	PRO	N-CD	17.41	1.72	1.47
3	K	4058	PRO	N-CD	17.40	1.72	1.47
3	O	5058	PRO	N-CD	17.38	1.72	1.47
3	O	5041	PRO	N-CD	14.01	1.67	1.47
3	C	41	PRO	N-CD	13.99	1.67	1.47
3	G	3041	PRO	N-CD	13.97	1.67	1.47
3	K	4041	PRO	N-CD	13.95	1.67	1.47
4	P	5514	PRO	N-CD	13.15	1.66	1.47
4	L	4514	PRO	N-CD	13.15	1.66	1.47
4	D	514	PRO	N-CD	13.15	1.66	1.47
4	H	3514	PRO	N-CD	13.12	1.66	1.47
3	C	14	PRO	N-CD	9.46	1.61	1.47
3	G	3014	PRO	N-CD	9.46	1.61	1.47
3	O	5014	PRO	N-CD	9.44	1.61	1.47
3	K	4014	PRO	N-CD	9.41	1.61	1.47
4	H	3542	PRO	N-CD	6.97	1.57	1.47
4	P	5542	PRO	N-CD	6.88	1.57	1.47
4	L	4542	PRO	N-CD	6.86	1.57	1.47
4	D	542	PRO	N-CD	6.85	1.57	1.47
3	G	3033	PRO	N-CD	6.20	1.56	1.47
3	K	4033	PRO	N-CD	6.19	1.56	1.47
3	C	33	PRO	N-CD	6.16	1.56	1.47
3	O	5033	PRO	N-CD	6.10	1.56	1.47
4	H	3544	HIS	CG-CD2	6.08	1.46	1.35
4	L	4544	HIS	CG-CD2	6.06	1.46	1.35
4	P	5544	HIS	CG-CD2	6.06	1.46	1.35
4	D	544	HIS	CG-CD2	6.06	1.46	1.35
2	B	823	TRP	CB-CG	5.25	1.59	1.50
2	F	1823	TRP	CB-CG	5.25	1.59	1.50
2	J	2823	TRP	CB-CG	5.22	1.59	1.50
2	N	3823	TRP	CB-CG	5.21	1.59	1.50

All (74) bond angle outliers are listed below:

Mol	Chain	Res	Type	Atoms	Z	Observed(°)	Ideal(°)
4	D	686	ARG	NE-CZ-NH1	10.11	125.35	120.30
4	L	4686	ARG	NE-CZ-NH1	10.07	125.34	120.30
4	H	3686	ARG	NE-CZ-NH1	10.04	125.32	120.30
4	P	5686	ARG	NE-CZ-NH1	9.96	125.28	120.30
4	H	3635	LEU	CA-CB-CG	9.70	137.61	115.30
4	D	635	LEU	CA-CB-CG	9.70	137.60	115.30
4	P	5635	LEU	CA-CB-CG	9.69	137.60	115.30

Continued on next page...

Continued from previous page...

Mol	Chain	Res	Type	Atoms	Z	Observed(°)	Ideal(°)
4	L	4635	LEU	CA-CB-CG	9.68	137.57	115.30
4	P	5701	GLU	OE1-CD-OE2	-7.61	114.17	123.30
4	D	701	GLU	OE1-CD-OE2	-7.59	114.19	123.30
4	H	3701	GLU	OE1-CD-OE2	-7.59	114.20	123.30
4	L	4701	GLU	OE1-CD-OE2	-7.56	114.22	123.30
4	D	701	GLU	CB-CG-CD	7.40	134.17	114.20
4	H	3701	GLU	CB-CG-CD	7.39	134.15	114.20
4	P	5701	GLU	CB-CG-CD	7.38	134.12	114.20
4	L	4701	GLU	CB-CG-CD	7.37	134.09	114.20
4	D	686	ARG	NE-CZ-NH2	-7.34	116.63	120.30
4	H	3711	ARG	NE-CZ-NH1	7.34	123.97	120.30
4	L	4686	ARG	NE-CZ-NH2	-7.28	116.66	120.30
4	D	711	ARG	NE-CZ-NH1	7.25	123.92	120.30
4	P	5686	ARG	NE-CZ-NH2	-7.25	116.67	120.30
4	L	4711	ARG	NE-CZ-NH1	7.25	123.92	120.30
4	P	5711	ARG	NE-CZ-NH1	7.24	123.92	120.30
4	H	3686	ARG	NE-CZ-NH2	-7.21	116.69	120.30
4	D	690	ARG	NE-CZ-NH1	6.78	123.69	120.30
4	H	3690	ARG	NE-CZ-NH1	6.66	123.63	120.30
4	P	5690	ARG	NE-CZ-NH1	6.63	123.62	120.30
4	L	4690	ARG	NE-CZ-NH1	6.60	123.60	120.30
4	D	701	GLU	N-CA-CB	6.41	122.14	110.60
4	H	3701	GLU	N-CA-CB	6.38	122.09	110.60
4	P	5701	GLU	N-CA-CB	6.38	122.08	110.60
4	L	4701	GLU	N-CA-CB	6.37	122.06	110.60
1	E	1265	GLU	N-CA-C	-6.04	94.68	111.00
1	A	265	GLU	N-CA-C	-6.03	94.72	111.00
1	M	3265	GLU	N-CA-C	-6.02	94.74	111.00
1	I	2265	GLU	N-CA-C	-6.02	94.74	111.00
2	F	1685	TYR	CA-CB-CG	5.74	124.30	113.40
2	B	685	TYR	CA-CB-CG	5.73	124.29	113.40
2	N	3685	TYR	CA-CB-CG	5.73	124.29	113.40
2	J	2685	TYR	CA-CB-CG	5.71	124.26	113.40
3	G	3056	GLY	CA-C-N	5.48	129.25	117.20
3	C	56	GLY	CA-C-N	5.47	129.24	117.20
3	O	5056	GLY	CA-C-N	5.47	129.23	117.20
3	K	4056	GLY	CA-C-N	5.46	129.22	117.20
4	L	4647	VAL	CA-CB-CG1	5.41	119.02	110.90
4	H	3647	VAL	CA-CB-CG1	5.41	119.01	110.90
4	P	5634	THR	CA-CB-CG2	5.39	119.94	112.40
4	D	634	THR	CA-CB-CG2	5.38	119.94	112.40
4	D	614	SER	N-CA-CB	-5.38	102.43	110.50

Continued on next page...

Continued from previous page...

Mol	Chain	Res	Type	Atoms	Z	Observed(°)	Ideal(°)
4	D	647	VAL	CA-CB-CG1	5.38	118.97	110.90
4	H	3634	THR	CA-CB-CG2	5.38	119.93	112.40
4	L	4634	THR	CA-CB-CG2	5.37	119.91	112.40
4	P	5647	VAL	CA-CB-CG1	5.36	118.93	110.90
4	L	4614	SER	N-CA-CB	-5.34	102.49	110.50
4	P	5614	SER	N-CA-CB	-5.34	102.49	110.50
4	H	3614	SER	N-CA-CB	-5.33	102.50	110.50
3	O	5074	ILE	CA-C-N	-5.24	105.68	117.20
3	G	3074	ILE	CA-C-N	-5.21	105.73	117.20
3	K	4074	ILE	CA-C-N	-5.21	105.74	117.20
3	C	74	ILE	CA-C-N	-5.21	105.74	117.20
4	H	3643	TYR	CB-CG-CD2	5.20	124.12	121.00
4	D	643	TYR	CB-CG-CD2	5.19	124.11	121.00
4	L	4643	TYR	CB-CG-CD2	5.15	124.09	121.00
2	J	2542	LEU	CA-CB-CG	5.12	127.08	115.30
2	B	542	LEU	CA-CB-CG	5.12	127.07	115.30
4	P	5643	TYR	CB-CG-CD2	5.11	124.07	121.00
2	N	3542	LEU	CA-CB-CG	5.10	127.03	115.30
2	F	1542	LEU	CA-CB-CG	5.10	127.02	115.30
3	G	3043	LYS	N-CA-C	5.08	124.71	111.00
3	K	4043	LYS	N-CA-C	5.07	124.69	111.00
3	C	43	LYS	N-CA-C	5.07	124.68	111.00
3	O	5043	LYS	N-CA-C	5.07	124.68	111.00
2	J	2823	TRP	CA-CB-CG	5.01	123.23	113.70
2	N	3823	TRP	CA-CB-CG	5.00	123.21	113.70

There are no chirality outliers.

All (4) planarity outliers are listed below:

Mol	Chain	Res	Type	Group
1	A	385	LYS	Peptide
1	E	1385	LYS	Peptide
1	I	2385	LYS	Peptide
1	M	3385	LYS	Peptide

5.2 Too-close contacts [\(i\)](#)

In the following table, the Non-H and H(model) columns list the number of non-hydrogen atoms and hydrogen atoms in the chain respectively. The H(added) column lists the number of hydrogen atoms added and optimized by MolProbity. The Clashes column lists the number of clashes within the asymmetric unit, whereas Symm-Clashes lists symmetry-related clashes.

Mol	Chain	Non-H	H(model)	H(added)	Clashes	Symm-Clashes
1	A	3063	0	2950	84	0
1	E	3063	0	2947	66	0
1	I	3063	0	2945	76	0
1	M	3063	0	2947	56	0
2	B	2550	0	2486	84	0
2	F	2550	0	2492	105	0
2	J	2550	0	2490	89	0
2	N	2550	0	2490	162	0
3	C	1671	0	1641	234	0
3	G	1671	0	1638	215	0
3	K	1671	0	1638	232	0
3	O	1671	0	1637	259	0
4	D	1598	0	1521	203	0
4	H	1598	0	1525	233	0
4	L	1598	0	1523	198	0
4	P	1598	0	1523	252	0
All	All	35528	0	34393	1942	0

The all-atom clashscore is defined as the number of clashes found per 1000 atoms (including hydrogen atoms). The all-atom clashscore for this structure is 28.

All (1942) close contacts within the same asymmetric unit are listed below, sorted by their clash magnitude.

Atom-1	Atom-2	Interatomic distance (Å)	Clash overlap (Å)
3:G:3118:ALA:HB3	3:G:3150:PHE:CE2	1.17	1.67
3:K:4032:TYR:HE1	3:K:4100:TYR:CD1	1.00	1.67
3:O:5118:ALA:HB3	3:O:5150:PHE:CE2	1.17	1.67
3:K:4118:ALA:HB3	3:K:4150:PHE:CE2	1.17	1.65
3:O:5032:TYR:CE1	3:O:5100:TYR:CD1	1.86	1.64
3:C:32:TYR:HE1	3:C:100:TYR:CD1	1.00	1.63
2:N:3543:LYS:HZ1	3:O:5102:ILE:CG1	1.02	1.63
3:O:5032:TYR:HE1	3:O:5100:TYR:CD1	1.00	1.62
3:C:118:ALA:HB3	3:C:150:PHE:CE2	1.17	1.60
3:G:3032:TYR:HE1	3:G:3100:TYR:CD1	1.00	1.60
3:C:32:TYR:CE1	3:C:100:TYR:CD1	1.86	1.60
2:J:2547:VAL:CG2	3:K:4102:ILE:HD11	1.20	1.59
3:G:3032:TYR:CE1	3:G:3100:TYR:CD1	1.86	1.57
3:K:4032:TYR:CE1	3:K:4100:TYR:CD1	1.86	1.57
3:G:3035:LEU:CD1	3:G:3104:LEU:HD21	1.36	1.56
3:C:35:LEU:CD1	3:C:104:LEU:HD21	1.36	1.56
2:N:3543:LYS:CE	3:O:5102:ILE:HD11	1.10	1.55
3:K:4035:LEU:HD13	3:K:4104:LEU:CD2	1.36	1.55

Continued on next page...

Continued from previous page...

Atom-1	Atom-2	Interatomic distance (Å)	Clash overlap (Å)
2:N:3678:SER:HB2	4:P:5597:LEU:CB	1.15	1.55
2:N:3543:LYS:HE2	3:O:5102:ILE:CD1	1.33	1.55
3:C:45:PHE:CZ	4:D:546:PHE:HZ	1.25	1.54
3:K:4035:LEU:CD1	3:K:4104:LEU:HD21	1.36	1.54
3:G:3045:PHE:CZ	4:H:3546:PHE:CZ	1.96	1.54
3:G:3045:PHE:CZ	4:H:3546:PHE:HZ	1.25	1.54
3:K:4045:PHE:CZ	4:L:4546:PHE:HZ	1.25	1.54
3:C:45:PHE:CZ	4:D:546:PHE:CZ	1.96	1.53
3:O:5045:PHE:CZ	4:P:5546:PHE:CZ	1.96	1.52
3:C:35:LEU:HD13	3:C:104:LEU:CD2	1.36	1.52
3:G:3118:ALA:CB	3:G:3150:PHE:CE2	1.92	1.52
3:O:5035:LEU:HD13	3:O:5104:LEU:CD2	1.36	1.51
3:K:4045:PHE:CZ	4:L:4546:PHE:CZ	1.96	1.51
3:K:4118:ALA:CB	3:K:4150:PHE:CE2	1.93	1.50
2:N:3678:SER:CB	4:P:5597:LEU:CB	1.84	1.50
3:G:3035:LEU:HD13	3:G:3104:LEU:CD2	1.36	1.50
3:O:5035:LEU:CD1	3:O:5104:LEU:HD21	1.36	1.50
2:N:3561:LYS:HG3	4:P:5532:SER:CB	1.02	1.49
3:O:5118:ALA:CB	3:O:5150:PHE:CE2	1.92	1.48
3:C:118:ALA:CB	3:C:150:PHE:CE2	1.92	1.47
3:O:5045:PHE:CZ	4:P:5546:PHE:HZ	1.25	1.46
2:F:1679:GLY:H	4:H:3501:GLN:N	1.14	1.43
2:J:2547:VAL:HG21	3:K:4102:ILE:CD1	1.46	1.43
3:C:102:ILE:CB	4:D:552:ASP:HB2	1.49	1.43
2:B:561:LYS:HA	4:D:532:SER:CB	1.45	1.42
3:C:58:PRO:CD	3:C:58:PRO:N	1.72	1.42
3:O:5102:ILE:CB	4:P:5552:ASP:HB2	1.49	1.42
2:J:2563:ILE:HG23	4:L:4532:SER:CB	1.49	1.41
2:N:3543:LYS:NZ	3:O:5102:ILE:CG1	1.76	1.41
2:N:3561:LYS:CG	4:P:5532:SER:HB3	0.92	1.40
2:F:1558:LYS:NZ	4:H:3526:ILE:HG21	1.20	1.40
3:G:3102:ILE:CB	4:H:3552:ASP:HB2	1.49	1.40
2:J:2547:VAL:CG2	3:K:4102:ILE:CD1	1.99	1.40
3:K:4102:ILE:CB	4:L:4552:ASP:HB2	1.49	1.40
2:N:3718:LYS:NZ	4:P:5596:ASN:HB2	1.23	1.40
3:O:5041:PRO:CD	3:O:5041:PRO:N	1.67	1.37
2:N:3561:LYS:HE2	4:P:5532:SER:OG	1.23	1.37
2:N:3718:LYS:CD	3:O:5059:THR:HG21	1.53	1.37
3:K:4078:THR:HG21	3:K:4080:TYR:CZ	1.59	1.37
2:N:3678:SER:CB	4:P:5597:LEU:HB2	1.39	1.37
3:G:3078:THR:HG21	3:G:3080:TYR:CZ	1.59	1.37

Continued on next page...

Continued from previous page...

Atom-1	Atom-2	Interatomic distance (Å)	Clash overlap (Å)
3:C:45:PHE:CE2	4:D:546:PHE:CZ	2.13	1.36
3:C:78:THR:HG21	3:C:80:TYR:CZ	1.59	1.36
3:G:3058:PRO:CD	3:G:3058:PRO:N	1.72	1.36
2:N:3543:LYS:CE	3:O:5102:ILE:CD1	1.90	1.35
3:G:3045:PHE:CE2	4:H:3546:PHE:CZ	2.13	1.35
3:O:5045:PHE:CE2	4:P:5546:PHE:CZ	2.14	1.35
3:O:5078:THR:HG21	3:O:5080:TYR:CZ	1.59	1.35
3:K:4045:PHE:CE2	4:L:4546:PHE:CZ	2.13	1.33
3:K:4032:TYR:OH	3:K:4100:TYR:CZ	1.68	1.33
3:K:4058:PRO:CD	3:K:4058:PRO:N	1.72	1.31
1:A:1:TYR:N	1:I:2385:LYS:CD	1.80	1.31
3:O:5058:PRO:N	3:O:5058:PRO:CD	1.72	1.31
3:G:3002:ILE:CD1	3:G:3098:ARG:NH1	1.95	1.30
3:K:4002:ILE:CD1	3:K:4098:ARG:NH1	1.95	1.30
3:K:4032:TYR:OH	3:K:4100:TYR:CE1	1.84	1.30
3:G:3032:TYR:OH	3:G:3100:TYR:CZ	1.68	1.29
3:O:5002:ILE:CD1	3:O:5098:ARG:NH1	1.95	1.29
3:C:32:TYR:OH	3:C:100:TYR:CE1	1.84	1.29
3:C:32:TYR:OH	3:C:100:TYR:CZ	1.68	1.29
3:G:3032:TYR:OH	3:G:3100:TYR:CE1	1.84	1.29
3:C:2:ILE:CD1	3:C:98:ARG:NH1	1.95	1.28
2:N:3678:SER:HB2	4:P:5597:LEU:CG	1.53	1.27
2:B:545:ASP:CG	3:C:102:ILE:HD13	1.54	1.27
2:B:545:ASP:OD2	3:C:102:ILE:HD13	1.21	1.26
2:J:2563:ILE:CG2	4:L:4532:SER:OG	1.82	1.26
2:N:3543:LYS:NZ	3:O:5102:ILE:CD1	1.95	1.26
3:G:3032:TYR:CE1	3:G:3100:TYR:CG	2.24	1.26
3:O:5032:TYR:OH	3:O:5100:TYR:CZ	1.68	1.25
3:G:3102:ILE:HB	4:H:3552:ASP:CB	1.66	1.25
3:O:5102:ILE:HB	4:P:5552:ASP:CB	1.66	1.25
3:C:102:ILE:HB	4:D:552:ASP:CB	1.66	1.25
3:O:5032:TYR:OH	3:O:5100:TYR:CE1	1.84	1.25
3:G:3045:PHE:HZ	4:H:3546:PHE:CZ	1.43	1.25
3:O:5045:PHE:HZ	4:P:5546:PHE:CZ	1.43	1.25
3:K:4032:TYR:CE1	3:K:4100:TYR:CG	2.24	1.24
2:N:3543:LYS:NZ	3:O:5102:ILE:HG13	1.40	1.24
3:K:4102:ILE:HB	4:L:4552:ASP:CB	1.66	1.23
3:O:5032:TYR:CE1	3:O:5100:TYR:CG	2.24	1.23
3:C:32:TYR:CE1	3:C:100:TYR:CG	2.24	1.23
3:C:217:ARG:NH2	4:D:622:PRO:HD2	1.55	1.22
2:B:545:ASP:OD2	3:C:102:ILE:HA	1.37	1.22

Continued on next page...

Continued from previous page...

Atom-1	Atom-2	Interatomic distance (Å)	Clash overlap (Å)
3:C:21:SER:OG	3:C:80:TYR:CE2	1.92	1.22
3:K:4217:ARG:NH2	4:L:4622:PRO:HD2	1.55	1.22
3:O:5217:ARG:NH2	4:P:5622:PRO:HD2	1.55	1.22
3:G:3021:SER:OG	3:G:3080:TYR:HE2	1.21	1.20
3:G:3217:ARG:NH2	4:H:3622:PRO:HD2	1.55	1.20
2:B:561:LYS:CA	4:D:532:SER:CB	2.20	1.20
3:O:5021:SER:OG	3:O:5080:TYR:HE2	1.21	1.20
3:C:78:THR:CG2	3:C:80:TYR:CZ	2.26	1.19
3:K:4021:SER:OG	3:K:4080:TYR:CE2	1.92	1.19
3:G:3021:SER:OG	3:G:3080:TYR:CE2	1.92	1.19
3:C:21:SER:OG	3:C:80:TYR:HE2	1.21	1.19
2:F:1697:SER:HA	4:H:3501:GLN:NE2	1.57	1.18
3:C:102:ILE:HG22	4:D:534:CYS:HB3	1.25	1.18
3:G:3078:THR:CG2	3:G:3080:TYR:CZ	2.26	1.18
3:K:4021:SER:OG	3:K:4080:TYR:HE2	1.21	1.18
2:N:3678:SER:OG	3:O:5047:TRP:CE3	1.96	1.18
3:K:4078:THR:CG2	3:K:4080:TYR:CZ	2.26	1.18
3:O:5078:THR:CG2	3:O:5080:TYR:CZ	2.26	1.17
4:D:514:PRO:CG	4:D:609:LEU:O	1.93	1.17
2:F:1679:GLY:N	4:H:3501:GLN:N	1.92	1.17
4:H:3514:PRO:CG	4:H:3609:LEU:O	1.93	1.17
2:N:3718:LYS:HD2	3:O:5059:THR:HG21	1.25	1.17
2:J:2563:ILE:HG22	4:L:4532:SER:N	1.59	1.16
4:L:4514:PRO:HG3	4:L:4609:LEU:O	1.45	1.16
3:O:5032:TYR:HE1	3:O:5100:TYR:CG	1.61	1.16
3:K:4102:ILE:HG22	4:L:4534:CYS:HB3	1.25	1.16
4:P:5514:PRO:HG3	4:P:5609:LEU:O	1.45	1.16
4:P:5514:PRO:CG	4:P:5609:LEU:O	1.93	1.15
2:F:1544:THR:HG21	4:H:3534:CYS:SG	1.85	1.15
2:N:3543:LYS:NZ	3:O:5102:ILE:HD11	1.58	1.15
1:A:1:TYR:N	1:I:2385:LYS:HD3	1.44	1.15
1:A:123:LYS:HE2	1:E:1150:ASN:HD22	1.06	1.14
3:G:3102:ILE:HG22	4:H:3534:CYS:HB3	1.25	1.14
4:L:4514:PRO:CG	4:L:4609:LEU:O	1.93	1.14
3:O:5102:ILE:HG22	4:P:5534:CYS:HB3	1.25	1.14
2:N:3718:LYS:NZ	4:P:5596:ASN:CB	2.09	1.14
3:C:32:TYR:HE1	3:C:100:TYR:CG	1.61	1.14
3:G:3032:TYR:HE1	3:G:3100:TYR:CG	1.61	1.14
4:D:514:PRO:HG3	4:D:609:LEU:O	1.45	1.13
3:K:4032:TYR:HE1	3:K:4100:TYR:CG	1.61	1.13
2:B:562:SER:N	4:D:532:SER:HB3	1.62	1.13

Continued on next page...

Continued from previous page...

Atom-1	Atom-2	Interatomic distance (Å)	Clash overlap (Å)
1:A:150:ASN:HD22	1:E:1123:LYS:HE2	1.06	1.13
2:J:2563:ILE:CG2	4:L:4532:SER:CB	2.27	1.13
3:K:4002:ILE:HD11	3:K:4098:ARG:NH1	1.62	1.13
2:N:3718:LYS:HD3	3:O:5059:THR:CG2	1.78	1.12
2:F:1558:LYS:NZ	4:H:3526:ILE:CG2	2.12	1.12
2:B:678:SER:OG	4:D:597:LEU:HD13	1.43	1.12
1:A:1:TYR:H1	1:I:2385:LYS:HD2	1.06	1.11
3:K:4035:LEU:CD2	3:K:4037:VAL:HG23	1.80	1.11
2:J:2560:GLN:OE1	4:L:4595:ASN:HA	1.37	1.11
2:B:561:LYS:HA	4:D:532:SER:HB2	1.24	1.11
2:N:3676:VAL:C	4:P:5501:GLN:HG2	1.68	1.11
3:C:35:LEU:CD2	3:C:37:VAL:HG23	1.80	1.11
3:G:3035:LEU:CD2	3:G:3037:VAL:CG2	2.29	1.11
4:H:3514:PRO:HG3	4:H:3609:LEU:O	1.45	1.11
2:J:2563:ILE:HG23	4:L:4532:SER:OG	0.96	1.11
3:O:5021:SER:OG	3:O:5080:TYR:CE2	1.91	1.11
3:O:5035:LEU:CD2	3:O:5037:VAL:HG23	1.80	1.11
3:O:5035:LEU:CD2	3:O:5037:VAL:CG2	2.29	1.10
2:N:3718:LYS:HZ2	4:P:5596:ASN:CB	1.62	1.10
3:O:5002:ILE:HD11	3:O:5098:ARG:NH1	1.62	1.10
3:C:35:LEU:CD2	3:C:37:VAL:CG2	2.29	1.10
3:C:45:PHE:HZ	4:D:546:PHE:CZ	1.43	1.10
3:K:4035:LEU:CD2	3:K:4037:VAL:CG2	2.29	1.10
2:N:3561:LYS:CE	4:P:5532:SER:OG	2.00	1.10
3:G:3035:LEU:CD2	3:G:3037:VAL:HG23	1.80	1.09
2:N:3678:SER:CB	4:P:5597:LEU:HB3	1.81	1.09
2:B:680:ALA:HA	3:C:62:GLU:OE2	1.52	1.09
2:N:3543:LYS:HZ1	3:O:5102:ILE:CD1	1.59	1.09
3:O:5118:ALA:HB3	3:O:5150:PHE:CZ	1.88	1.09
3:G:3118:ALA:HB3	3:G:3150:PHE:CZ	1.88	1.09
3:K:4002:ILE:HD11	3:K:4098:ARG:HH12	1.12	1.09
2:N:3718:LYS:HD3	3:O:5059:THR:HG21	1.21	1.09
2:J:2680:ALA:HA	3:K:4062:GLU:HG2	1.30	1.08
2:N:3718:LYS:CD	3:O:5059:THR:CG2	2.29	1.08
3:C:2:ILE:HD11	3:C:98:ARG:HH12	1.12	1.08
3:C:118:ALA:HB3	3:C:150:PHE:CZ	1.88	1.08
3:G:3002:ILE:HD11	3:G:3098:ARG:HH12	1.12	1.08
3:G:3002:ILE:HD11	3:G:3098:ARG:NH1	1.62	1.07
2:N:3664:LEU:CD2	4:P:5501:GLN:HG3	1.84	1.07
2:N:3664:LEU:HD22	4:P:5501:GLN:HG3	1.31	1.07
2:N:3678:SER:OG	3:O:5047:TRP:HE3	1.32	1.07

Continued on next page...

Continued from previous page...

Atom-1	Atom-2	Interatomic distance (Å)	Clash overlap (Å)
2:N:3678:SER:HB3	4:P:5597:LEU:HB3	1.37	1.07
3:K:4045:PHE:HZ	4:L:4546:PHE:CZ	1.43	1.07
2:B:561:LYS:HA	4:D:532:SER:OG	1.55	1.06
3:K:4102:ILE:HG21	4:L:4552:ASP:OD1	1.55	1.06
3:K:4118:ALA:HB3	3:K:4150:PHE:CZ	1.88	1.06
2:B:561:LYS:C	4:D:532:SER:HB3	1.75	1.06
3:K:4039:GLN:NE2	3:K:4045:PHE:CE1	2.24	1.05
3:O:5102:ILE:HG13	4:P:5552:ASP:CG	1.76	1.05
2:N:3676:VAL:O	4:P:5501:GLN:N	1.89	1.05
3:O:5002:ILE:HD11	3:O:5098:ARG:HH12	1.12	1.05
3:C:102:ILE:HG21	4:D:552:ASP:OD1	1.55	1.05
3:G:3102:ILE:CB	4:H:3552:ASP:CB	2.30	1.05
3:O:5102:ILE:HG21	4:P:5552:ASP:OD1	1.55	1.05
2:F:1544:THR:CG2	4:H:3534:CYS:SG	2.43	1.05
3:G:3102:ILE:HG21	4:H:3552:ASP:OD1	1.55	1.05
3:K:4102:ILE:HG13	4:L:4552:ASP:CG	1.76	1.05
2:N:3718:LYS:HE3	4:P:5596:ASN:O	1.57	1.05
3:C:45:PHE:CE2	4:D:546:PHE:CE1	2.46	1.04
3:G:3039:GLN:NE2	3:G:3045:PHE:CE1	2.24	1.04
3:O:5039:GLN:NE2	3:O:5045:PHE:CE1	2.24	1.04
3:C:102:ILE:HG13	4:D:552:ASP:CG	1.76	1.04
3:C:39:GLN:NE2	3:C:45:PHE:CE1	2.24	1.04
2:N:3561:LYS:CB	4:P:5532:SER:HB3	1.87	1.04
4:P:5514:PRO:HD3	4:P:5609:LEU:CB	1.87	1.04
1:A:22:PRO:HB3	1:I:2382:LYS:CB	1.88	1.04
4:L:4514:PRO:HD3	4:L:4609:LEU:CB	1.87	1.04
3:G:3102:ILE:HG13	4:H:3552:ASP:CG	1.76	1.03
3:O:5045:PHE:CE2	4:P:5546:PHE:CE1	2.46	1.03
2:B:562:SER:N	4:D:532:SER:CB	2.22	1.03
3:C:2:ILE:HD11	3:C:98:ARG:NH1	1.62	1.03
3:K:4045:PHE:CE2	4:L:4546:PHE:CE1	2.46	1.03
3:C:32:TYR:HH	3:C:100:TYR:CZ	1.03	1.03
3:G:3045:PHE:CE2	4:H:3546:PHE:CE1	2.46	1.03
3:O:5102:ILE:CB	4:P:5552:ASP:CB	2.30	1.03
4:D:514:PRO:HD3	4:D:609:LEU:CB	1.87	1.03
2:F:1697:SER:CA	4:H:3501:GLN:HE22	1.73	1.02
2:N:3560:GLN:H	4:P:5595:ASN:HA	1.22	1.02
2:B:680:ALA:C	3:C:62:GLU:HG2	1.78	1.02
2:F:1558:LYS:HZ3	4:H:3526:ILE:HG21	1.21	1.02
4:H:3514:PRO:HD3	4:H:3609:LEU:CB	1.87	1.02
3:C:45:PHE:CZ	4:D:546:PHE:CE1	2.48	1.01

Continued on next page...

Continued from previous page...

Atom-1	Atom-2	Interatomic distance (Å)	Clash overlap (Å)
3:K:4102:ILE:CB	4:L:4552:ASP:CB	2.30	1.01
3:G:3045:PHE:CZ	4:H:3546:PHE:CE1	2.48	1.01
2:N:3561:LYS:CB	4:P:5532:SER:CB	2.38	1.01
3:K:4045:PHE:CZ	4:L:4546:PHE:CE1	2.48	1.00
3:O:5045:PHE:CZ	4:P:5546:PHE:CE1	2.48	1.00
2:J:2547:VAL:HG22	3:K:4102:ILE:CD1	1.85	1.00
1:A:152:GLU:OE2	1:E:1177:LYS:NZ	1.95	1.00
2:N:3678:SER:HB3	4:P:5597:LEU:CB	1.90	1.00
3:K:4032:TYR:CZ	3:K:4100:TYR:CE1	2.50	1.00
3:K:4217:ARG:HH21	4:L:4622:PRO:HD2	1.18	0.99
2:N:3561:LYS:CG	4:P:5532:SER:CB	1.85	0.99
3:O:5032:TYR:CZ	3:O:5100:TYR:CE1	2.50	0.99
2:N:3718:LYS:HB3	3:O:5059:THR:HG23	1.42	0.99
1:A:150:ASN:ND2	1:E:1123:LYS:HE2	1.77	0.99
3:C:35:LEU:HD21	3:C:37:VAL:HG22	1.43	0.99
3:O:5035:LEU:HD21	3:O:5037:VAL:HG22	1.43	0.98
2:F:1718:LYS:HZ3	4:H:3595:ASN:CB	1.76	0.98
3:G:3032:TYR:CZ	3:G:3100:TYR:CE1	2.50	0.98
1:A:123:LYS:HE2	1:E:1150:ASN:ND2	1.77	0.98
1:A:177:LYS:NZ	1:E:1152:GLU:OE2	1.95	0.98
3:C:32:TYR:CZ	3:C:100:TYR:CE1	2.50	0.98
2:F:1697:SER:HA	4:H:3501:GLN:HE22	1.16	0.98
2:J:2563:ILE:HG22	4:L:4532:SER:H	1.20	0.98
3:K:4035:LEU:HD21	3:K:4037:VAL:HG22	1.43	0.98
3:C:11:VAL:HG11	3:C:151:PRO:CB	1.93	0.98
3:G:3011:VAL:HG11	3:G:3151:PRO:CB	1.93	0.98
3:O:5011:VAL:HG11	3:O:5151:PRO:CB	1.93	0.98
3:C:11:VAL:HG21	3:C:152:GLU:H	1.29	0.97
4:H:3563:ARG:NH2	4:H:3584:ASP:OD1	1.96	0.97
3:K:4011:VAL:HG11	3:K:4151:PRO:CB	1.93	0.97
4:H:3513:SER:OG	4:H:3609:LEU:HD22	1.64	0.97
3:O:5097:VAL:HG11	3:O:5104:LEU:HD23	1.45	0.97
2:B:545:ASP:OD1	3:C:102:ILE:CD1	2.12	0.97
4:D:631:ASN:HA	4:D:685:ALA:HB2	1.47	0.97
3:C:97:VAL:HG11	3:C:104:LEU:HD23	1.45	0.97
3:G:3035:LEU:HD21	3:G:3037:VAL:HG22	1.43	0.97
3:G:3102:ILE:CG2	4:H:3534:CYS:HB3	1.94	0.97
2:B:545:ASP:OD2	3:C:102:ILE:CD1	2.11	0.97
3:K:4011:VAL:HG21	3:K:4152:GLU:H	1.29	0.97
3:C:217:ARG:HH21	4:D:622:PRO:HD2	1.18	0.97
4:D:513:SER:OG	4:D:609:LEU:HD22	1.65	0.97

Continued on next page...

Continued from previous page...

Atom-1	Atom-2	Interatomic distance (Å)	Clash overlap (Å)
4:D:563:ARG:NH2	4:D:584:ASP:OD1	1.96	0.97
4:L:4631:ASN:HA	4:L:4685:ALA:HB2	1.47	0.97
3:O:5102:ILE:CG2	4:P:5534:CYS:HB3	1.94	0.97
4:L:4563:ARG:NH2	4:L:4584:ASP:OD1	1.96	0.97
3:C:32:TYR:HE1	3:C:100:TYR:HD1	1.13	0.96
3:C:32:TYR:CE1	3:C:100:TYR:CE1	2.52	0.96
3:C:102:ILE:CG2	4:D:534:CYS:HB3	1.94	0.96
3:G:3011:VAL:HG21	3:G:3152:GLU:H	1.29	0.96
3:K:4032:TYR:CE1	3:K:4100:TYR:CE1	2.52	0.96
3:O:5011:VAL:HG21	3:O:5152:GLU:H	1.29	0.96
3:G:3032:TYR:CE1	3:G:3100:TYR:CE1	2.52	0.96
3:K:4102:ILE:CG2	4:L:4534:CYS:HB3	1.94	0.96
3:C:35:LEU:HD22	3:C:37:VAL:HG23	1.48	0.96
3:O:5032:TYR:CE1	3:O:5100:TYR:CE1	2.53	0.96
4:P:5563:ARG:NH2	4:P:5584:ASP:OD1	1.96	0.96
3:K:4045:PHE:HE2	4:L:4546:PHE:CZ	1.80	0.95
4:P:5513:SER:OG	4:P:5609:LEU:HD22	1.65	0.95
2:J:2560:GLN:OE1	4:L:4595:ASN:CA	2.13	0.95
3:K:4032:TYR:HE1	3:K:4100:TYR:HD1	1.13	0.95
1:A:22:PRO:HB3	1:I:2382:LYS:HB3	1.46	0.95
3:G:3035:LEU:HD22	3:G:3037:VAL:HG23	1.48	0.95
4:L:4513:SER:OG	4:L:4609:LEU:HD22	1.65	0.95
3:C:102:ILE:CB	4:D:552:ASP:CB	2.30	0.95
3:K:4097:VAL:HG11	3:K:4104:LEU:HD23	1.45	0.95
3:K:4102:ILE:HG23	4:L:4534:CYS:SG	2.07	0.95
3:C:102:ILE:HG23	4:D:534:CYS:SG	2.07	0.94
3:G:3217:ARG:HH21	4:H:3622:PRO:HD2	1.18	0.94
4:H:3631:ASN:HA	4:H:3685:ALA:HB2	1.47	0.94
1:A:1:TYR:H1	1:I:2385:LYS:CD	1.53	0.94
2:F:1558:LYS:HZ1	4:H:3526:ILE:HG21	1.23	0.94
3:G:3097:VAL:HG11	3:G:3104:LEU:HD23	1.45	0.94
2:B:561:LYS:HG3	4:D:532:SER:OG	1.68	0.94
3:K:4035:LEU:HD22	3:K:4037:VAL:HG23	1.48	0.94
4:P:5631:ASN:HA	4:P:5685:ALA:HB2	1.47	0.94
2:B:562:SER:H	4:D:532:SER:CB	1.77	0.93
3:O:5035:LEU:HD22	3:O:5037:VAL:HG23	1.48	0.93
3:K:4097:VAL:CG1	3:K:4104:LEU:HD23	1.98	0.93
3:O:5102:ILE:HG23	4:P:5534:CYS:SG	2.07	0.93
3:G:3102:ILE:HG23	4:H:3534:CYS:SG	2.07	0.93
3:O:5078:THR:HG21	3:O:5080:TYR:OH	1.69	0.93
3:G:3097:VAL:CG1	3:G:3104:LEU:HD23	1.98	0.93

Continued on next page...

Continued from previous page...

Atom-1	Atom-2	Interatomic distance (Å)	Clash overlap (Å)
3:K:4118:ALA:HB1	3:K:4150:PHE:CE2	2.03	0.92
2:B:678:SER:OG	4:D:597:LEU:CD1	2.09	0.92
3:C:97:VAL:CG1	3:C:104:LEU:HD23	1.98	0.92
3:G:3032:TYR:CZ	3:G:3100:TYR:CD1	2.56	0.92
3:G:3118:ALA:HB1	3:G:3150:PHE:CE2	2.02	0.92
2:F:1718:LYS:HZ2	4:H:3596:ASN:ND2	1.67	0.92
3:O:5045:PHE:HE2	4:P:5546:PHE:CZ	1.80	0.92
1:A:1:TYR:H2	1:I:2385:LYS:CD	1.43	0.92
3:O:5032:TYR:CZ	3:O:5100:TYR:CD1	2.56	0.92
3:O:5097:VAL:CG1	3:O:5104:LEU:HD23	1.98	0.92
3:G:3045:PHE:HE2	4:H:3546:PHE:CZ	1.80	0.92
2:N:3543:LYS:HE2	3:O:5102:ILE:HD12	1.50	0.92
3:O:5217:ARG:HH21	4:P:5622:PRO:HD2	1.18	0.92
3:K:4032:TYR:CZ	3:K:4100:TYR:CD1	2.56	0.92
2:N:3718:LYS:HZ1	4:P:5596:ASN:HB2	1.28	0.92
1:A:150:ASN:HD22	1:E:1123:LYS:CE	1.83	0.92
3:C:45:PHE:HE2	4:D:546:PHE:CZ	1.80	0.92
2:F:1718:LYS:NZ	4:H:3595:ASN:HB2	1.85	0.92
3:G:3035:LEU:HD21	3:G:3037:VAL:CG2	1.98	0.91
3:O:5118:ALA:CB	3:O:5150:PHE:CZ	2.51	0.91
3:O:5118:ALA:HB1	3:O:5150:PHE:CE2	2.02	0.91
3:C:32:TYR:CZ	3:C:100:TYR:CD1	2.56	0.91
4:D:694:TYR:HB2	4:D:709:LEU:HD22	1.50	0.91
4:H:3694:TYR:HB2	4:H:3709:LEU:HD22	1.50	0.91
2:B:545:ASP:OD2	3:C:102:ILE:CA	2.18	0.91
3:C:118:ALA:HB1	3:C:150:PHE:CE2	2.03	0.91
3:K:4035:LEU:HD21	3:K:4037:VAL:CG2	1.98	0.90
4:P:5694:TYR:HB2	4:P:5709:LEU:HD22	1.50	0.90
3:G:3032:TYR:HE1	3:G:3100:TYR:HD1	1.13	0.90
3:K:4078:THR:HG21	3:K:4080:TYR:OH	1.69	0.90
4:H:3552:ASP:HB3	4:H:3555:ASN:ND2	1.87	0.90
3:C:78:THR:HG21	3:C:80:TYR:OH	1.69	0.90
3:C:118:ALA:CB	3:C:150:PHE:CZ	2.51	0.90
3:O:5011:VAL:HG11	3:O:5151:PRO:HB3	1.53	0.90
1:A:123:LYS:CE	1:E:1150:ASN:HD22	1.83	0.90
3:G:3078:THR:HG21	3:G:3080:TYR:OH	1.69	0.90
2:J:2558:LYS:HE3	4:L:4501:GLN:CB	2.02	0.90
2:N:3561:LYS:HG3	4:P:5532:SER:CA	2.02	0.90
4:P:5552:ASP:HB3	4:P:5555:ASN:ND2	1.87	0.90
2:B:545:ASP:CG	3:C:102:ILE:CD1	2.40	0.90
2:F:1558:LYS:HZ2	4:H:3526:ILE:HG21	1.26	0.90

Continued on next page...

Continued from previous page...

Atom-1	Atom-2	Interatomic distance (Å)	Clash overlap (Å)
3:K:4011:VAL:HG21	3:K:4152:GLU:N	1.87	0.89
4:L:4694:TYR:HB2	4:L:4709:LEU:HD22	1.50	0.89
3:G:3173:LEU:HD12	4:H:3665:THR:HG22	1.54	0.89
3:K:4011:VAL:HG11	3:K:4151:PRO:HB3	1.53	0.89
3:G:3011:VAL:HG11	3:G:3151:PRO:HB3	1.53	0.89
4:D:552:ASP:HB3	4:D:555:ASN:ND2	1.87	0.89
2:F:1718:LYS:NZ	4:H:3595:ASN:CB	2.32	0.89
4:L:4552:ASP:HB3	4:L:4555:ASN:ND2	1.87	0.89
3:O:5173:LEU:HD12	4:P:5665:THR:HG22	1.54	0.89
3:C:173:LEU:HD12	4:D:665:THR:HG22	1.54	0.89
3:O:5011:VAL:HG21	3:O:5152:GLU:N	1.87	0.89
2:J:2547:VAL:CB	3:K:4102:ILE:HD11	2.03	0.88
2:B:545:ASP:OD1	3:C:102:ILE:HD13	1.68	0.88
3:G:3011:VAL:HG21	3:G:3152:GLU:N	1.87	0.88
3:O:5032:TYR:HE1	3:O:5100:TYR:HD1	1.13	0.88
3:G:3118:ALA:CB	3:G:3150:PHE:CZ	2.51	0.88
4:L:4694:TYR:HB2	4:L:4709:LEU:CD2	2.03	0.88
2:J:2563:ILE:HG23	4:L:4532:SER:HB3	1.55	0.88
3:C:11:VAL:HG21	3:C:152:GLU:N	1.87	0.88
2:J:2558:LYS:HE3	4:L:4501:GLN:HB3	1.54	0.88
3:O:5035:LEU:HD21	3:O:5037:VAL:CG2	1.98	0.88
2:N:3679:GLY:HA2	3:O:5063:GLU:N	1.88	0.87
4:H:3694:TYR:HB2	4:H:3709:LEU:CD2	2.03	0.87
3:C:11:VAL:HG11	3:C:151:PRO:HB3	1.53	0.87
3:K:4011:VAL:CB	3:K:4151:PRO:HB2	2.05	0.87
3:C:35:LEU:HD21	3:C:37:VAL:CG2	1.98	0.87
4:D:694:TYR:HB2	4:D:709:LEU:CD2	2.03	0.87
4:P:5694:TYR:HB2	4:P:5709:LEU:CD2	2.03	0.87
3:G:3011:VAL:CB	3:G:3151:PRO:HB2	2.05	0.87
2:N:3677:PRO:O	4:P:5597:LEU:CD1	2.22	0.87
2:J:2678:SER:N	4:L:4501:GLN:HE21	1.73	0.86
3:C:11:VAL:CB	3:C:151:PRO:HB2	2.05	0.86
3:C:70:PHE:HE1	3:C:81:LEU:HD13	1.40	0.86
3:G:3070:PHE:HE1	3:G:3081:LEU:HD13	1.40	0.86
3:K:4173:LEU:HD12	4:L:4665:THR:HG22	1.54	0.86
3:O:5011:VAL:CB	3:O:5151:PRO:HB2	2.05	0.86
2:N:3677:PRO:O	4:P:5597:LEU:HD11	1.74	0.85
2:N:3678:SER:HB2	4:P:5597:LEU:HB2	0.86	0.85
4:D:513:SER:HA	4:D:609:LEU:HB2	1.59	0.85
3:O:5039:GLN:NE2	3:O:5045:PHE:CZ	2.44	0.85
3:C:39:GLN:NE2	3:C:45:PHE:CZ	2.45	0.85

Continued on next page...

Continued from previous page...

Atom-1	Atom-2	Interatomic distance (Å)	Clash overlap (Å)
3:K:4035:LEU:HD22	3:K:4037:VAL:CG2	2.05	0.85
2:B:561:LYS:C	4:D:532:SER:CB	2.44	0.85
4:H:3513:SER:HA	4:H:3609:LEU:HB2	1.59	0.85
2:N:3678:SER:OG	4:P:5597:LEU:HB2	1.75	0.84
3:K:4118:ALA:CB	3:K:4150:PHE:CZ	2.51	0.84
3:O:5070:PHE:HE1	3:O:5081:LEU:HD13	1.40	0.84
3:G:3035:LEU:HD22	3:G:3037:VAL:CG2	2.05	0.84
3:G:3039:GLN:NE2	3:G:3045:PHE:CZ	2.44	0.84
3:K:4070:PHE:HE1	3:K:4081:LEU:HD13	1.40	0.84
2:N:3676:VAL:CA	4:P:5501:GLN:HG2	1.81	0.84
3:G:3175:GLN:HG3	4:H:3663:GLU:OE2	1.78	0.84
4:D:582:THR:OG1	4:D:610:GLY:HA3	1.78	0.84
3:K:4039:GLN:NE2	3:K:4045:PHE:CZ	2.44	0.84
3:C:35:LEU:HD22	3:C:37:VAL:CG2	2.05	0.84
3:O:5011:VAL:HG11	3:O:5151:PRO:HB2	1.60	0.84
4:H:3554:ASN:C	4:H:3554:ASN:HD22	1.81	0.84
3:O:5175:GLN:HG3	4:P:5663:GLU:OE2	1.78	0.84
3:O:5078:THR:CG2	3:O:5080:TYR:CE1	2.61	0.84
1:A:1:TYR:H2	1:I:2385:LYS:HD3	1.02	0.83
4:L:4653:VAL:HG23	4:L:4658:VAL:HG21	1.60	0.83
3:O:5037:VAL:HG21	3:O:5107:TRP:CH2	2.13	0.83
1:A:291:ILE:HG23	1:I:2316:ILE:HD13	1.58	0.83
2:B:561:LYS:CA	4:D:532:SER:HB2	1.96	0.83
3:C:78:THR:CG2	3:C:80:TYR:CE1	2.61	0.83
3:C:175:GLN:HG3	4:D:663:GLU:OE2	1.78	0.83
4:H:3582:THR:OG1	4:H:3610:GLY:HA3	1.78	0.83
2:J:2563:ILE:CG2	4:L:4532:SER:N	2.42	0.83
2:N:3679:GLY:HA2	3:O:5063:GLU:H	1.43	0.83
4:D:554:ASN:HD22	4:D:554:ASN:C	1.81	0.83
4:D:653:VAL:HG23	4:D:658:VAL:HG21	1.60	0.83
2:N:3679:GLY:CA	3:O:5063:GLU:H	1.92	0.83
3:G:3037:VAL:HG21	3:G:3107:TRP:CH2	2.13	0.83
4:L:4582:THR:OG1	4:L:4610:GLY:HA3	1.78	0.83
4:P:5653:VAL:HG23	4:P:5658:VAL:HG21	1.60	0.83
3:G:3078:THR:CG2	3:G:3080:TYR:CE1	2.61	0.83
3:G:3091:THR:HG22	3:G:3115:VAL:H	1.43	0.83
2:N:3679:GLY:CA	3:O:5063:GLU:N	2.41	0.83
3:K:4037:VAL:HG21	3:K:4107:TRP:CH2	2.13	0.83
3:O:5030:THR:HG23	3:O:5054:ASN:HD22	1.44	0.83
3:C:102:ILE:HG22	3:C:102:ILE:O	1.78	0.82
3:O:5091:THR:HG22	3:O:5115:VAL:H	1.43	0.82

Continued on next page...

Continued from previous page...

Atom-1	Atom-2	Interatomic distance (Å)	Clash overlap (Å)
3:C:37:VAL:HG21	3:C:107:TRP:CH2	2.13	0.82
3:K:4078:THR:CG2	3:K:4080:TYR:CE1	2.61	0.82
4:L:4513:SER:HA	4:L:4609:LEU:HB2	1.59	0.82
3:G:3102:ILE:CG2	4:H:3534:CYS:SG	2.68	0.82
2:N:3561:LYS:CD	4:P:5532:SER:HB3	2.08	0.82
3:C:30:THR:HG23	3:C:54:ASN:HD22	1.44	0.82
3:C:78:THR:HG21	3:C:80:TYR:CE2	2.14	0.82
3:G:3102:ILE:HG13	4:H:3552:ASP:OD2	1.80	0.82
2:N:3561:LYS:CB	4:P:5532:SER:HB2	2.09	0.82
3:C:91:THR:HG22	3:C:115:VAL:H	1.43	0.82
2:N:3718:LYS:CB	3:O:5059:THR:HG23	2.09	0.82
4:P:5554:ASN:C	4:P:5554:ASN:HD22	1.81	0.82
4:H:3653:VAL:HG23	4:H:3658:VAL:HG21	1.60	0.82
3:K:4102:ILE:CG2	4:L:4534:CYS:SG	2.68	0.82
3:O:5078:THR:HG21	3:O:5080:TYR:CE2	2.14	0.82
4:P:5582:THR:OG1	4:P:5610:GLY:HA3	1.78	0.82
3:C:11:VAL:HG11	3:C:151:PRO:HB2	1.60	0.82
3:K:4091:THR:HG22	3:K:4115:VAL:H	1.43	0.82
2:N:3560:GLN:N	4:P:5595:ASN:HA	1.84	0.82
3:O:5102:ILE:HG22	3:O:5102:ILE:O	1.78	0.82
3:G:3011:VAL:HG21	3:G:3151:PRO:HB2	1.62	0.82
3:G:3078:THR:HG21	3:G:3080:TYR:CE2	2.14	0.82
4:L:4554:ASN:HD22	4:L:4554:ASN:C	1.81	0.82
3:O:5102:ILE:HG13	4:P:5552:ASP:OD2	1.80	0.82
3:C:98:ARG:NH2	3:C:105:ASP:OD2	2.13	0.82
3:K:4078:THR:HG21	3:K:4080:TYR:CE2	2.14	0.82
3:K:4098:ARG:NH2	3:K:4105:ASP:OD2	2.13	0.82
3:K:4175:GLN:HG3	4:L:4663:GLU:OE2	1.78	0.81
4:P:5513:SER:HA	4:P:5609:LEU:HB2	1.59	0.81
3:K:4102:ILE:HG13	4:L:4552:ASP:OD2	1.80	0.81
3:O:5102:ILE:CG2	4:P:5534:CYS:SG	2.68	0.81
4:D:683:LEU:HD11	4:D:694:TYR:HE2	1.44	0.81
3:K:4030:THR:HG23	3:K:4054:ASN:HD22	1.44	0.81
3:O:5011:VAL:HG21	3:O:5151:PRO:HB2	1.62	0.81
4:P:5683:LEU:HD11	4:P:5694:TYR:HE2	1.44	0.81
3:G:3098:ARG:NH2	3:G:3105:ASP:OD2	2.13	0.81
4:H:3683:LEU:HD11	4:H:3694:TYR:HE2	1.44	0.81
2:N:3543:LYS:NZ	3:O:5102:ILE:HG12	1.94	0.81
2:N:3718:LYS:HZ1	4:P:5596:ASN:CB	1.86	0.81
3:C:102:ILE:CG2	4:D:534:CYS:SG	2.68	0.81
4:H:3514:PRO:HD3	4:H:3609:LEU:HB2	1.62	0.81

Continued on next page...

Continued from previous page...

Atom-1	Atom-2	Interatomic distance (Å)	Clash overlap (Å)
3:K:4011:VAL:HG21	3:K:4151:PRO:HB2	1.62	0.81
2:N:3543:LYS:HZ1	3:O:5102:ILE:HG13	0.64	0.81
2:N:3543:LYS:HZ3	3:O:5102:ILE:CG1	1.91	0.81
3:O:5035:LEU:HD22	3:O:5037:VAL:CG2	2.05	0.81
4:L:4514:PRO:HD3	4:L:4609:LEU:HB2	1.62	0.81
4:P:5514:PRO:HD3	4:P:5609:LEU:HB2	1.62	0.81
3:C:102:ILE:HG13	4:D:552:ASP:OD2	1.80	0.80
3:G:3030:THR:HG23	3:G:3054:ASN:HD22	1.44	0.80
3:G:3011:VAL:HG11	3:G:3151:PRO:HB2	1.60	0.80
3:G:3102:ILE:HG22	3:G:3102:ILE:O	1.79	0.80
3:O:5102:ILE:CG2	4:P:5552:ASP:HA	2.12	0.80
2:B:716:ASP:OD2	4:D:596:ASN:ND2	2.15	0.80
3:K:4011:VAL:HG11	3:K:4151:PRO:HB2	1.60	0.80
3:K:4102:ILE:HG22	3:K:4102:ILE:O	1.79	0.80
4:L:4683:LEU:HD11	4:L:4694:TYR:HE2	1.44	0.80
3:O:5102:ILE:CG1	4:P:5552:ASP:HB2	2.12	0.80
3:C:11:VAL:HG21	3:C:151:PRO:HB2	1.62	0.80
1:I:2389:VAL:O	2:J:2823:TRP:N	2.13	0.80
3:K:4102:ILE:CG2	4:L:4552:ASP:HA	2.12	0.80
3:C:102:ILE:CG2	4:D:534:CYS:CB	2.60	0.80
3:G:3102:ILE:CG2	4:H:3552:ASP:HA	2.12	0.79
3:O:5102:ILE:CG2	4:P:5534:CYS:CB	2.60	0.79
3:K:4102:ILE:CG2	4:L:4534:CYS:CB	2.60	0.79
3:O:5020:ILE:HD11	3:O:5113:LEU:HD11	1.65	0.79
4:D:514:PRO:HD3	4:D:609:LEU:HB2	1.62	0.79
3:C:102:ILE:HG21	4:D:552:ASP:CG	2.03	0.79
3:G:3102:ILE:HG21	4:H:3552:ASP:CG	2.03	0.79
1:E:1389:VAL:O	2:F:1823:TRP:N	2.13	0.79
3:C:102:ILE:CG2	4:D:552:ASP:HA	2.12	0.79
2:F:1677:PRO:C	4:H:3501:GLN:C	2.41	0.79
3:G:3102:ILE:CG2	4:H:3534:CYS:CB	2.60	0.79
3:G:3102:ILE:CG1	4:H:3552:ASP:HB2	2.12	0.79
2:J:2680:ALA:CA	3:K:4062:GLU:HG2	2.12	0.79
3:C:102:ILE:CG1	4:D:552:ASP:HB2	2.12	0.79
2:J:2563:ILE:CG2	4:L:4532:SER:H	1.92	0.79
3:K:4102:ILE:CG1	4:L:4552:ASP:HB2	2.12	0.79
1:A:389:VAL:O	2:B:823:TRP:N	2.13	0.79
3:K:4020:ILE:HD11	3:K:4113:LEU:HD11	1.65	0.79
1:M:3389:VAL:O	2:N:3823:TRP:N	2.13	0.79
4:H:3542:PRO:O	4:H:3543:ASP:HB2	1.83	0.78
3:C:2:ILE:HD12	3:C:98:ARG:NH1	1.98	0.78

Continued on next page...

Continued from previous page...

Atom-1	Atom-2	Interatomic distance (Å)	Clash overlap (Å)
3:G:3020:ILE:HD11	3:G:3113:LEU:HD11	1.65	0.78
2:J:2676:VAL:HG23	4:L:4501:GLN:NE2	1.97	0.78
4:P:5695:SER:HB2	4:P:5708:SER:OG	1.83	0.78
4:D:695:SER:HB2	4:D:708:SER:OG	1.83	0.78
4:L:4542:PRO:O	4:L:4543:ASP:HB2	1.83	0.78
3:O:5102:ILE:HG21	4:P:5552:ASP:CG	2.03	0.78
2:F:1558:LYS:O	4:H:3595:ASN:ND2	2.15	0.78
3:O:5102:ILE:CG2	4:P:5552:ASP:CB	2.62	0.78
4:P:5542:PRO:O	4:P:5543:ASP:HB2	1.83	0.78
4:D:542:PRO:O	4:D:543:ASP:HB2	1.83	0.78
3:C:20:ILE:HD11	3:C:113:LEU:HD11	1.65	0.78
4:D:520:LEU:N	4:D:520:LEU:HD23	1.99	0.78
2:F:1676:VAL:N	4:H:3501:GLN:OE1	2.06	0.78
3:K:4102:ILE:CG2	4:L:4552:ASP:CB	2.62	0.78
3:K:4102:ILE:HG21	4:L:4552:ASP:CG	2.03	0.78
4:L:4695:SER:HB2	4:L:4708:SER:OG	1.83	0.78
3:G:3048:MET:HG2	3:G:3064:PHE:CZ	2.19	0.78
3:O:5021:SER:OG	3:O:5080:TYR:CD2	2.37	0.78
3:C:102:ILE:CG2	4:D:552:ASP:CB	2.62	0.78
3:K:4021:SER:OG	3:K:4080:TYR:CD2	2.37	0.78
3:O:5098:ARG:NH2	3:O:5105:ASP:OD2	2.13	0.78
3:K:4011:VAL:CG1	3:K:4151:PRO:HB2	2.14	0.78
3:O:5070:PHE:CE1	3:O:5081:LEU:HD13	2.19	0.78
4:H:3695:SER:HB2	4:H:3708:SER:OG	1.83	0.77
3:G:3102:ILE:CG2	4:H:3552:ASP:CB	2.62	0.77
3:C:11:VAL:CG1	3:C:151:PRO:HB2	2.14	0.77
3:K:4048:MET:HG2	3:K:4064:PHE:CZ	2.19	0.77
4:L:4520:LEU:N	4:L:4520:LEU:HD23	1.99	0.77
3:O:5045:PHE:CE1	4:P:5589:PHE:CE2	2.73	0.77
3:C:45:PHE:CE1	4:D:589:PHE:CE2	2.73	0.77
3:G:3045:PHE:CE1	4:H:3589:PHE:CE2	2.73	0.77
2:J:2560:GLN:NE2	4:L:4595:ASN:O	2.18	0.77
3:K:4002:ILE:HD12	3:K:4098:ARG:NH1	1.98	0.77
3:K:4070:PHE:CE1	3:K:4081:LEU:HD13	2.19	0.77
4:L:4685:ALA:O	4:L:4688:TRP:HB3	1.85	0.77
3:C:48:MET:HG2	3:C:64:PHE:CZ	2.19	0.77
3:G:3070:PHE:CE1	3:G:3081:LEU:HD13	2.19	0.77
4:H:3520:LEU:HD23	4:H:3520:LEU:N	1.99	0.77
3:C:70:PHE:CE1	3:C:81:LEU:HD13	2.19	0.77
3:O:5011:VAL:CG1	3:O:5151:PRO:HB2	2.14	0.77
4:P:5520:LEU:N	4:P:5520:LEU:HD23	1.99	0.77

Continued on next page...

Continued from previous page...

Atom-1	Atom-2	Interatomic distance (Å)	Clash overlap (Å)
3:G:3078:THR:HG22	3:G:3080:TYR:CE1	2.20	0.77
3:K:4078:THR:HG22	3:K:4080:TYR:CE1	2.20	0.77
4:L:4514:PRO:HD3	4:L:4609:LEU:CA	2.15	0.77
2:J:2756:PRO:O	2:J:2814:TRP:NE1	2.18	0.77
4:H:3685:ALA:O	4:H:3688:TRP:HB3	1.85	0.76
2:N:3684:TYR:OH	2:N:3701:THR:OG1	2.03	0.76
3:O:5002:ILE:HD12	3:O:5098:ARG:NH1	1.98	0.76
3:C:78:THR:HG22	3:C:80:TYR:CE1	2.20	0.76
3:O:5078:THR:HG22	3:O:5080:TYR:CE1	2.20	0.76
3:O:5048:MET:HG2	3:O:5064:PHE:CZ	2.19	0.76
2:B:692:ARG:O	2:B:711:ARG:NH2	2.19	0.76
2:F:1692:ARG:O	2:F:1711:ARG:NH2	2.19	0.76
3:G:3011:VAL:CG2	3:G:3151:PRO:HB2	2.16	0.76
4:D:514:PRO:CD	4:D:609:LEU:O	2.34	0.76
3:G:3011:VAL:CG1	3:G:3151:PRO:HB2	2.14	0.76
3:K:4045:PHE:CE1	4:L:4589:PHE:CE2	2.73	0.76
3:G:3021:SER:CB	3:G:3080:TYR:CE2	2.69	0.76
3:K:4021:SER:CB	3:K:4080:TYR:CE2	2.69	0.76
3:K:4097:VAL:HG11	3:K:4104:LEU:CD2	2.16	0.76
4:D:685:ALA:O	4:D:688:TRP:HB3	1.85	0.76
4:H:3514:PRO:CD	4:H:3609:LEU:O	2.34	0.76
4:H:3552:ASP:HB3	4:H:3555:ASN:HD22	1.51	0.76
2:J:2595:THR:OG1	2:J:2611:VAL:O	2.04	0.76
4:P:5514:PRO:HD3	4:P:5609:LEU:CA	2.15	0.76
1:A:291:ILE:HG23	1:I:2316:ILE:CD1	2.16	0.76
2:B:718:LYS:HD2	4:D:596:ASN:O	1.84	0.76
3:C:21:SER:CB	3:C:80:TYR:CE2	2.69	0.76
2:B:684:TYR:OH	2:B:701:THR:OG1	2.03	0.76
2:F:1678:SER:OG	4:H:3599:VAL:CG2	2.34	0.76
3:K:4011:VAL:CG2	3:K:4151:PRO:HB2	2.16	0.76
2:B:756:PRO:O	2:B:814:TRP:NE1	2.18	0.76
2:N:3692:ARG:O	2:N:3711:ARG:NH2	2.19	0.76
4:P:5685:ALA:O	4:P:5688:TRP:HB3	1.85	0.76
4:D:514:PRO:HD3	4:D:609:LEU:CA	2.15	0.75
4:H:3514:PRO:HD3	4:H:3609:LEU:CA	2.15	0.75
3:O:5002:ILE:HD13	3:O:5098:ARG:NH1	2.00	0.75
3:K:4002:ILE:HD13	3:K:4098:ARG:NH1	2.00	0.75
2:N:3676:VAL:O	4:P:5501:GLN:HG2	1.86	0.75
2:N:3753:THR:OG1	2:N:3816:ASN:ND2	2.20	0.75
3:O:5097:VAL:HG11	3:O:5104:LEU:CD2	2.16	0.75
2:J:2753:THR:OG1	2:J:2816:ASN:ND2	2.20	0.75

Continued on next page...

Continued from previous page...

Atom-1	Atom-2	Interatomic distance (Å)	Clash overlap (Å)
2:N:3756:PRO:O	2:N:3814:TRP:NE1	2.19	0.75
2:F:1595:THR:OG1	2:F:1611:VAL:O	2.04	0.75
3:O:5011:VAL:CG2	3:O:5151:PRO:HB2	2.16	0.75
4:P:5631:ASN:CA	4:P:5685:ALA:HB2	2.17	0.75
3:O:5102:ILE:HG21	4:P:5552:ASP:HA	1.68	0.75
4:D:631:ASN:CA	4:D:685:ALA:HB2	2.17	0.75
2:F:1756:PRO:O	2:F:1814:TRP:NE1	2.18	0.75
4:L:4552:ASP:HB3	4:L:4555:ASN:HD22	1.51	0.75
3:O:5021:SER:CB	3:O:5080:TYR:CE2	2.69	0.75
3:C:24:ALA:HB1	3:C:27:TYR:CE1	2.22	0.75
4:D:552:ASP:HB3	4:D:555:ASN:HD22	1.51	0.75
2:J:2692:ARG:O	2:J:2711:ARG:NH2	2.19	0.75
4:L:4514:PRO:CD	4:L:4609:LEU:O	2.34	0.75
3:G:3097:VAL:HG11	3:G:3104:LEU:CD2	2.16	0.75
2:N:3595:THR:OG1	2:N:3611:VAL:O	2.04	0.75
4:L:4514:PRO:CD	4:L:4609:LEU:CB	2.65	0.75
2:B:595:THR:OG1	2:B:611:VAL:O	2.04	0.74
3:C:97:VAL:HG11	3:C:104:LEU:CD2	2.16	0.74
2:F:1697:SER:C	4:H:3501:GLN:HE22	1.89	0.74
2:F:1753:THR:OG1	2:F:1816:ASN:ND2	2.20	0.74
3:G:3102:ILE:CG1	4:H:3552:ASP:CG	2.56	0.74
3:K:4102:ILE:HG21	4:L:4552:ASP:HA	1.69	0.74
4:P:5514:PRO:CD	4:P:5609:LEU:O	2.34	0.74
2:B:562:SER:H	4:D:532:SER:HB2	1.52	0.74
3:G:3002:ILE:HD13	3:G:3098:ARG:NH1	2.00	0.74
3:G:3097:VAL:CG2	3:G:3107:TRP:CE3	2.70	0.74
2:J:2547:VAL:CG2	3:K:4102:ILE:HD12	2.15	0.74
3:O:5097:VAL:CG2	3:O:5107:TRP:CE3	2.70	0.74
2:B:753:THR:OG1	2:B:816:ASN:ND2	2.20	0.74
2:N:3543:LYS:CD	3:O:5102:ILE:HD11	2.13	0.74
1:A:30:GLN:OE1	1:A:136:THR:OG1	2.06	0.74
3:C:11:VAL:CG2	3:C:151:PRO:HB2	2.16	0.74
3:C:97:VAL:CG2	3:C:107:TRP:CE3	2.70	0.74
3:C:102:ILE:CG1	4:D:552:ASP:CG	2.56	0.74
1:E:1030:GLN:OE1	1:E:1136:THR:OG1	2.06	0.74
3:G:3002:ILE:HD12	3:G:3098:ARG:NH1	1.98	0.74
4:H:3631:ASN:CA	4:H:3685:ALA:HB2	2.17	0.74
2:N:3678:SER:HB2	4:P:5597:LEU:CD1	2.16	0.74
3:O:5097:VAL:HG21	3:O:5107:TRP:CE3	2.22	0.74
4:H:3514:PRO:CD	4:H:3609:LEU:CB	2.65	0.74
3:C:217:ARG:NH2	4:D:622:PRO:CD	2.45	0.74

Continued on next page...

Continued from previous page...

Atom-1	Atom-2	Interatomic distance (Å)	Clash overlap (Å)
3:K:4024:ALA:HB1	3:K:4027:TYR:CE1	2.22	0.74
1:M:3030:GLN:OE1	1:M:3136:THR:OG1	2.06	0.74
3:O:5024:ALA:HB1	3:O:5027:TYR:CE1	2.22	0.74
3:G:3102:ILE:HB	4:H:3552:ASP:HB2	0.75	0.74
3:G:3217:ARG:NH2	4:H:3622:PRO:CD	2.45	0.73
4:H:3519:THR:C	4:H:3520:LEU:HD23	2.09	0.73
2:J:2562:SER:OG	4:L:4532:SER:O	2.06	0.73
3:K:4097:VAL:CG2	3:K:4107:TRP:CE3	2.70	0.73
3:K:4126:TYR:CE2	4:L:4627:GLU:HG3	2.23	0.73
3:C:102:ILE:HG21	4:D:552:ASP:HA	1.68	0.73
2:F:1684:TYR:OH	2:F:1701:THR:OG1	2.03	0.73
4:L:4631:ASN:CA	4:L:4685:ALA:HB2	2.17	0.73
3:O:5102:ILE:CG1	4:P:5552:ASP:CG	2.56	0.73
3:G:3097:VAL:HG21	3:G:3107:TRP:CE3	2.23	0.73
4:P:5552:ASP:HB3	4:P:5555:ASN:HD22	1.51	0.73
3:C:97:VAL:HG21	3:C:107:TRP:CE3	2.23	0.73
4:D:519:THR:C	4:D:520:LEU:HD23	2.09	0.73
3:K:4097:VAL:HG21	3:K:4107:TRP:CE3	2.23	0.73
3:O:5126:TYR:CE2	4:P:5627:GLU:HG3	2.23	0.73
4:L:4519:THR:C	4:L:4520:LEU:HD23	2.09	0.73
4:P:5519:THR:C	4:P:5520:LEU:HD23	2.09	0.73
3:K:4011:VAL:CG1	3:K:4151:PRO:CB	2.67	0.73
3:C:126:TYR:CE2	4:D:627:GLU:HG3	2.23	0.73
3:G:3024:ALA:HB1	3:G:3027:TYR:CE1	2.22	0.73
3:G:3102:ILE:HG21	4:H:3552:ASP:HA	1.69	0.73
3:G:3126:TYR:CE2	4:H:3627:GLU:HG3	2.23	0.73
1:I:2030:GLN:OE1	1:I:2136:THR:OG1	2.06	0.72
2:B:561:LYS:CG	4:D:532:SER:OG	2.37	0.72
4:D:514:PRO:CD	4:D:609:LEU:CB	2.65	0.72
3:K:4102:ILE:CG1	4:L:4552:ASP:CG	2.56	0.72
3:K:4118:ALA:CB	3:K:4150:PHE:HE2	1.65	0.72
2:N:3543:LYS:HE2	3:O:5102:ILE:HD11	0.73	0.72
2:N:3676:VAL:CA	4:P:5501:GLN:CG	2.58	0.72
4:P:5514:PRO:CD	4:P:5609:LEU:CB	2.65	0.72
2:B:622:ARG:NH2	2:B:815:GLY:O	2.23	0.72
2:F:1622:ARG:NH2	2:F:1815:GLY:O	2.23	0.72
2:N:3622:ARG:NH2	2:N:3815:GLY:O	2.23	0.72
1:A:291:ILE:HG12	1:I:2306:GLU:HB2	1.71	0.72
2:J:2622:ARG:NH2	2:J:2815:GLY:O	2.23	0.72
1:A:22:PRO:CB	1:I:2382:LYS:HB3	2.18	0.72
3:G:3078:THR:HG22	3:G:3080:TYR:CZ	2.25	0.71

Continued on next page...

Continued from previous page...

Atom-1	Atom-2	Interatomic distance (Å)	Clash overlap (Å)
3:C:2:ILE:HD13	3:C:98:ARG:NH1	2.00	0.71
2:F:1783:SER:OG	2:F:1788:ALA:O	2.06	0.71
3:K:4102:ILE:HB	4:L:4552:ASP:HB2	0.75	0.71
3:K:4078:THR:HG22	3:K:4080:TYR:CZ	2.25	0.71
3:O:5078:THR:HG22	3:O:5080:TYR:CZ	2.25	0.71
3:G:3011:VAL:CG1	3:G:3151:PRO:CB	2.67	0.71
1:E:1076:TYR:OH	1:E:1105:GLU:OE1	2.08	0.71
2:J:2684:TYR:OH	2:J:2701:THR:OG1	2.04	0.71
2:N:3718:LYS:HZ2	4:P:5596:ASN:HB2	0.84	0.71
1:A:290:ARG:HH22	1:I:2356:HIS:CE1	2.08	0.71
3:G:3002:ILE:HD12	3:G:3098:ARG:CZ	2.21	0.71
2:N:3664:LEU:CD2	4:P:5501:GLN:CG	2.67	0.71
2:N:3543:LYS:CE	3:O:5102:ILE:HD12	2.12	0.71
2:N:3718:LYS:HD2	3:O:5059:THR:CG2	2.07	0.71
3:C:11:VAL:CG1	3:C:151:PRO:CB	2.67	0.71
3:K:4002:ILE:HD12	3:K:4098:ARG:CZ	2.21	0.71
3:K:4102:ILE:CG2	4:L:4552:ASP:CA	2.69	0.71
3:K:4217:ARG:NH2	4:L:4622:PRO:CD	2.45	0.71
1:M:3076:TYR:OH	1:M:3105:GLU:OE1	2.08	0.71
1:A:76:TYR:OH	1:A:105:GLU:OE1	2.08	0.70
3:O:5102:ILE:CG2	4:P:5552:ASP:CA	2.69	0.70
3:C:102:ILE:CG2	4:D:552:ASP:CA	2.69	0.70
2:B:680:ALA:CA	3:C:62:GLU:HG2	2.19	0.70
4:L:4542:PRO:HB3	4:L:4669:LYS:HD3	1.73	0.70
2:N:3664:LEU:HD22	4:P:5501:GLN:CG	2.17	0.70
3:O:5011:VAL:CG1	3:O:5151:PRO:CB	2.67	0.70
3:O:5030:THR:HG23	3:O:5054:ASN:ND2	2.07	0.70
2:N:3783:SER:OG	2:N:3788:ALA:O	2.06	0.70
3:G:3030:THR:HG23	3:G:3054:ASN:ND2	2.07	0.70
4:D:542:PRO:HB3	4:D:669:LYS:HD3	1.73	0.70
3:G:3002:ILE:CD1	3:G:3098:ARG:CZ	2.70	0.70
3:G:3102:ILE:CG2	4:H:3552:ASP:CA	2.69	0.70
2:N:3716:ASP:OD2	4:P:5596:ASN:CB	2.40	0.70
3:C:2:ILE:HD12	3:C:98:ARG:CZ	2.21	0.70
4:L:4557:ARG:HD2	4:L:4558:SER:O	1.92	0.70
2:F:1718:LYS:HZ1	4:H:3595:ASN:HB2	1.56	0.69
3:G:3060:TYR:OH	3:G:3069:VAL:HA	1.92	0.69
2:N:3718:LYS:HB2	3:O:5059:THR:OG1	1.92	0.69
3:O:5002:ILE:CD1	3:O:5098:ARG:CZ	2.70	0.69
3:C:2:ILE:CD1	3:C:98:ARG:CZ	2.70	0.69
1:A:111:SER:N	1:A:114:CYS:SG	2.66	0.69

Continued on next page...

Continued from previous page...

Atom-1	Atom-2	Interatomic distance (Å)	Clash overlap (Å)
3:C:30:THR:HG23	3:C:54:ASN:ND2	2.07	0.69
1:I:2076:TYR:OH	1:I:2105:GLU:OE1	2.08	0.69
3:K:4030:THR:HG23	3:K:4054:ASN:ND2	2.07	0.69
1:M:3111:SER:N	1:M:3114:CYS:SG	2.66	0.69
4:P:5557:ARG:HD2	4:P:5558:SER:O	1.92	0.69
1:E:1111:SER:N	1:E:1114:CYS:SG	2.65	0.69
1:M:3359:THR:O	1:M:3394:GLN:NE2	2.26	0.69
3:O:5002:ILE:HD12	3:O:5098:ARG:CZ	2.21	0.69
3:O:5039:GLN:CD	3:O:5045:PHE:CZ	2.66	0.69
2:B:552:MET:N	2:B:563:ILE:O	2.26	0.69
3:C:102:ILE:HB	4:D:552:ASP:HB2	0.75	0.69
3:G:3039:GLN:CD	3:G:3045:PHE:CZ	2.66	0.69
3:K:4039:GLN:CD	3:K:4045:PHE:CZ	2.66	0.69
3:K:4060:TYR:OH	3:K:4069:VAL:HA	1.92	0.69
4:P:5542:PRO:HB3	4:P:5669:LYS:HD3	1.74	0.69
4:D:557:ARG:HD2	4:D:558:SER:O	1.92	0.69
4:H:3542:PRO:HB3	4:H:3669:LYS:HD3	1.73	0.69
3:K:4102:ILE:HG21	4:L:4552:ASP:CB	2.23	0.69
4:H:3557:ARG:HD2	4:H:3558:SER:O	1.92	0.68
1:A:359:THR:O	1:A:394:GLN:NE2	2.26	0.68
3:C:60:TYR:OH	3:C:69:VAL:HA	1.92	0.68
3:G:3102:ILE:HG21	4:H:3552:ASP:CB	2.23	0.68
3:K:4002:ILE:CD1	3:K:4098:ARG:CZ	2.70	0.68
2:F:1558:LYS:HZ2	4:H:3526:ILE:CG2	1.91	0.68
3:O:5060:TYR:OH	3:O:5069:VAL:HA	1.92	0.68
2:J:2547:VAL:HG21	3:K:4102:ILE:HD11	0.68	0.68
1:E:1359:THR:O	1:E:1394:GLN:NE2	2.26	0.68
1:I:2391:TYR:OH	2:J:2784:LEU:HD11	1.94	0.68
2:B:560:GLN:HG3	4:D:595:ASN:OD1	1.93	0.68
1:I:2111:SER:N	1:I:2114:CYS:SG	2.66	0.68
2:B:783:SER:OG	2:B:788:ALA:O	2.06	0.68
2:F:1718:LYS:HZ3	4:H:3595:ASN:HB3	1.55	0.68
1:I:2359:THR:O	1:I:2394:GLN:NE2	2.26	0.68
2:N:3552:MET:N	2:N:3563:ILE:O	2.26	0.68
3:O:5217:ARG:NH2	4:P:5622:PRO:CD	2.45	0.68
2:F:1560:GLN:HB2	4:H:3532:SER:HB2	1.76	0.68
2:J:2552:MET:N	2:J:2563:ILE:O	2.26	0.68
2:J:2783:SER:OG	2:J:2788:ALA:O	2.06	0.68
1:A:391:TYR:OH	2:B:784:LEU:HD11	1.94	0.68
3:C:39:GLN:CD	3:C:45:PHE:CZ	2.66	0.68
1:E:1391:TYR:OH	2:F:1784:LEU:HD11	1.94	0.68

Continued on next page...

Continued from previous page...

Atom-1	Atom-2	Interatomic distance (Å)	Clash overlap (Å)
3:C:102:ILE:HG21	4:D:552:ASP:CB	2.23	0.67
4:H:3683:LEU:HD11	4:H:3694:TYR:CE2	2.29	0.67
3:C:128:LEU:HB3	4:D:621:PHE:CD2	2.30	0.67
2:N:3718:LYS:CE	4:P:5596:ASN:O	2.38	0.67
3:O:5102:ILE:HG21	4:P:5552:ASP:CB	2.23	0.67
2:B:561:LYS:CA	4:D:532:SER:HB3	2.06	0.67
4:P:5683:LEU:HD11	4:P:5694:TYR:CE2	2.29	0.67
2:F:1552:MET:N	2:F:1563:ILE:O	2.26	0.67
3:K:4128:LEU:HB3	4:L:4621:PHE:CD2	2.30	0.67
3:O:5102:ILE:HB	4:P:5552:ASP:HB2	0.75	0.67
2:J:2563:ILE:CG2	4:L:4532:SER:HB3	2.12	0.67
3:O:5041:PRO:HD3	3:O:5092:ALA:HA	1.77	0.67
4:H:3672:ASN:O	4:H:3673:ASN:HB2	1.95	0.67
3:K:4041:PRO:HD3	3:K:4092:ALA:HA	1.77	0.67
4:P:5672:ASN:O	4:P:5673:ASN:HB2	1.95	0.67
3:C:41:PRO:HD3	3:C:92:ALA:HA	1.77	0.67
2:F:1678:SER:OG	4:H:3599:VAL:HG23	1.93	0.67
2:F:1678:SER:O	4:H:3597:LEU:CD1	2.42	0.66
1:A:22:PRO:HB3	1:I:2382:LYS:HB2	1.73	0.66
2:J:2547:VAL:CG1	3:K:4102:ILE:HD11	2.25	0.66
1:M:3391:TYR:OH	2:N:3784:LEU:HD11	1.94	0.66
2:F:1697:SER:CA	4:H:3501:GLN:NE2	2.40	0.66
3:G:3128:LEU:HB3	4:H:3621:PHE:CD2	2.30	0.66
2:N:3561:LYS:HA	4:P:5532:SER:HB2	1.77	0.66
3:O:5128:LEU:HB3	4:P:5621:PHE:CD2	2.30	0.66
3:G:3073:GLU:OE1	3:G:3080:TYR:CZ	2.49	0.66
3:O:5073:GLU:OE1	3:O:5080:TYR:CZ	2.49	0.66
3:O:5102:ILE:CG1	4:P:5552:ASP:CB	2.73	0.66
4:D:672:ASN:O	4:D:673:ASN:HB2	1.95	0.66
3:G:3041:PRO:HD3	3:G:3092:ALA:HA	1.77	0.66
2:F:1718:LYS:NZ	4:H:3596:ASN:ND2	2.43	0.66
4:H:3593:TRP:CH2	4:H:3596:ASN:C	2.70	0.66
2:N:3543:LYS:NZ	4:P:5552:ASP:OD2	2.29	0.66
4:D:593:TRP:CH2	4:D:596:ASN:C	2.70	0.65
3:K:4102:ILE:CG1	4:L:4552:ASP:CB	2.73	0.65
4:P:5631:ASN:HA	4:P:5685:ALA:CB	2.25	0.65
3:K:4006:GLN:HE22	3:K:4095:PHE:HA	1.62	0.65
3:C:73:GLU:OE1	3:C:80:TYR:CZ	2.49	0.65
4:L:4593:TRP:CH2	4:L:4596:ASN:C	2.70	0.65
4:L:4672:ASN:O	4:L:4673:ASN:HB2	1.95	0.65
4:P:5593:TRP:CH2	4:P:5596:ASN:C	2.70	0.65

Continued on next page...

Continued from previous page...

Atom-1	Atom-2	Interatomic distance (Å)	Clash overlap (Å)
3:K:4073:GLU:OE1	3:K:4080:TYR:CZ	2.49	0.65
2:B:561:LYS:HA	4:D:532:SER:HG	1.61	0.65
4:L:4610:GLY:O	4:L:4611:GLN:HG3	1.97	0.65
4:D:652:LYS:HG2	4:D:657:PRO:HA	1.79	0.65
4:L:4631:ASN:HA	4:L:4685:ALA:CB	2.25	0.65
2:B:561:LYS:CA	4:D:532:SER:OG	2.34	0.65
4:D:683:LEU:HD11	4:D:694:TYR:CE2	2.29	0.65
3:G:3102:ILE:CG1	4:H:3552:ASP:CB	2.73	0.65
4:H:3610:GLY:O	4:H:3611:GLN:HG3	1.97	0.65
3:G:3006:GLN:HE22	3:G:3095:PHE:HA	1.62	0.64
3:G:3118:ALA:CB	3:G:3150:PHE:HE2	1.65	0.64
4:H:3564:PHE:CE1	4:H:3577:ILE:HG12	2.33	0.64
3:C:6:GLN:HE22	3:C:95:PHE:HA	1.62	0.64
3:C:102:ILE:CG1	4:D:552:ASP:CB	2.73	0.64
4:D:564:PHE:CE1	4:D:577:ILE:HG12	2.33	0.64
3:K:4073:GLU:OE1	3:K:4080:TYR:CE1	2.51	0.64
4:P:5564:PHE:CE1	4:P:5577:ILE:HG12	2.33	0.64
4:P:5610:GLY:O	4:P:5611:GLN:HG3	1.97	0.64
4:D:610:GLY:O	4:D:611:GLN:HG3	1.97	0.64
4:H:3652:LYS:HG2	4:H:3657:PRO:HA	1.79	0.64
2:F:1675:THR:C	4:H:3501:GLN:OE1	2.36	0.64
3:O:5006:GLN:HE22	3:O:5095:PHE:HA	1.62	0.64
4:P:5581:GLN:HB3	4:P:5583:GLU:HG2	1.79	0.64
4:L:4683:LEU:HD11	4:L:4694:TYR:CE2	2.29	0.64
3:O:5073:GLU:OE1	3:O:5080:TYR:CE1	2.51	0.64
4:P:5652:LYS:HG2	4:P:5657:PRO:HA	1.79	0.64
4:D:581:GLN:HB3	4:D:583:GLU:HG2	1.80	0.64
3:G:3073:GLU:OE1	3:G:3080:TYR:CE1	2.51	0.64
2:N:3718:LYS:NZ	4:P:5596:ASN:CA	2.61	0.64
1:A:123:LYS:CE	1:E:1150:ASN:ND2	2.52	0.64
4:D:568:LEU:HD23	4:D:573:ALA:HA	1.80	0.63
2:J:2558:LYS:HE3	4:L:4501:GLN:HB2	1.79	0.63
3:G:3021:SER:OG	3:G:3080:TYR:CD2	2.37	0.63
3:G:3118:ALA:CB	3:G:3150:PHE:CD2	2.77	0.63
4:H:3513:SER:OG	4:H:3609:LEU:CD2	2.44	0.63
4:L:4564:PHE:CE1	4:L:4577:ILE:HG12	2.33	0.63
4:L:4581:GLN:HB3	4:L:4583:GLU:HG2	1.80	0.63
3:O:5030:THR:O	3:O:5030:THR:CG2	2.46	0.63
4:P:5647:VAL:HG12	4:P:5700:HIS:HB2	1.81	0.63
3:C:72:LEU:HD13	3:C:74:ILE:HG13	1.81	0.63
4:D:513:SER:OG	4:D:609:LEU:CD2	2.44	0.63

Continued on next page...

Continued from previous page...

Atom-1	Atom-2	Interatomic distance (Å)	Clash overlap (Å)
4:H:3647:VAL:HG12	4:H:3700:HIS:HB2	1.81	0.63
3:C:73:GLU:OE1	3:C:80:TYR:CE1	2.51	0.63
3:C:118:ALA:CB	3:C:150:PHE:HE2	1.65	0.63
2:F:1676:VAL:CG2	4:H:3501:GLN:N	2.36	0.63
4:H:3581:GLN:HB3	4:H:3583:GLU:HG2	1.80	0.63
4:L:4647:VAL:HG12	4:L:4700:HIS:HB2	1.81	0.63
1:A:150:ASN:ND2	1:E:1123:LYS:CE	2.52	0.63
3:C:30:THR:O	3:C:30:THR:CG2	2.46	0.63
2:N:3558:LYS:HD2	4:P:5596:ASN:HD21	1.62	0.63
2:F:1676:VAL:HG23	4:H:3501:GLN:N	1.56	0.63
2:B:562:SER:N	4:D:532:SER:HB2	2.10	0.63
4:H:3568:LEU:HD23	4:H:3573:ALA:HA	1.80	0.63
1:A:291:ILE:CG2	1:I:2316:ILE:HD13	2.28	0.63
3:K:4030:THR:CG2	3:K:4030:THR:O	2.46	0.63
4:P:5514:PRO:HD3	4:P:5609:LEU:HB3	1.79	0.63
3:G:3072:LEU:HD13	3:G:3074:ILE:HG13	1.81	0.62
3:K:4072:LEU:HD13	3:K:4074:ILE:HG13	1.81	0.62
3:O:5072:LEU:HD13	3:O:5074:ILE:HG13	1.81	0.62
4:D:561:PRO:HG2	4:D:563:ARG:NH1	2.14	0.62
4:H:3514:PRO:HD3	4:H:3609:LEU:O	2.00	0.62
4:L:4568:LEU:HD23	4:L:4573:ALA:HA	1.80	0.62
4:L:4652:LYS:HG2	4:L:4657:PRO:HA	1.79	0.62
2:F:1562:SER:H	4:H:3532:SER:HB3	1.64	0.62
3:G:3030:THR:CG2	3:G:3030:THR:O	2.46	0.62
4:H:3561:PRO:HG2	4:H:3563:ARG:NH1	2.14	0.62
3:K:4035:LEU:HG	3:K:4047:TRP:CD1	2.35	0.62
2:N:3508:ASN:OD1	2:N:3610:THR:OG1	2.11	0.62
4:P:5514:PRO:HD3	4:P:5609:LEU:O	2.00	0.62
4:P:5568:LEU:HD23	4:P:5573:ALA:HA	1.80	0.62
3:C:35:LEU:HG	3:C:47:TRP:CD1	2.34	0.62
2:N:3559:THR:OG1	4:P:5595:ASN:ND2	2.32	0.62
4:D:514:PRO:HD3	4:D:609:LEU:O	2.00	0.62
3:K:4118:ALA:CB	3:K:4150:PHE:CD2	2.77	0.62
1:A:53:THR:OG1	1:A:236:GLN:OE1	2.18	0.62
4:P:5513:SER:OG	4:P:5609:LEU:CD2	2.44	0.62
4:D:647:VAL:HG12	4:D:700:HIS:HB2	1.81	0.61
2:B:505:ASP:O	2:B:726:ARG:NH1	2.32	0.61
3:C:11:VAL:HG23	3:C:152:GLU:O	2.00	0.61
3:G:3011:VAL:HG23	3:G:3152:GLU:O	2.00	0.61
4:L:4561:PRO:HG2	4:L:4563:ARG:NH1	2.14	0.61
2:N:3561:LYS:CA	4:P:5532:SER:HB2	2.31	0.61

Continued on next page...

Continued from previous page...

Atom-1	Atom-2	Interatomic distance (Å)	Clash overlap (Å)
3:O:5011:VAL:HG23	3:O:5152:GLU:O	2.00	0.61
4:P:5514:PRO:CD	4:P:5609:LEU:HB3	2.30	0.61
2:B:559:THR:HG21	4:D:594:TYR:HD1	1.66	0.61
4:P:5561:PRO:HG2	4:P:5563:ARG:NH1	2.14	0.61
4:D:662:MET:HA	4:D:680:TYR:O	2.01	0.61
3:G:3035:LEU:HG	3:G:3047:TRP:CD1	2.35	0.61
2:N:3505:ASP:O	2:N:3726:ARG:NH1	2.32	0.61
2:F:1505:ASP:O	2:F:1726:ARG:NH1	2.32	0.61
3:K:4011:VAL:HG23	3:K:4152:GLU:O	2.00	0.61
1:E:1198:ALA:HB3	2:J:2759:LEU:HD11	1.81	0.61
4:H:3506:GLN:CD	4:H:3590:CYS:SG	2.79	0.61
1:I:2198:ALA:HB3	2:N:3759:LEU:HD11	1.81	0.61
4:L:4506:GLN:CD	4:L:4590:CYS:SG	2.79	0.61
3:O:5035:LEU:HG	3:O:5047:TRP:CD1	2.34	0.61
3:O:5118:ALA:HB1	3:O:5150:PHE:CD2	2.36	0.61
3:K:4009:ARG:HG2	3:K:4112:THR:H	1.65	0.61
2:N:3679:GLY:HA3	3:O:5063:GLU:N	2.13	0.61
4:P:5506:GLN:CD	4:P:5590:CYS:SG	2.79	0.61
4:H:3662:MET:HA	4:H:3680:TYR:O	2.01	0.61
4:L:4514:PRO:HD3	4:L:4609:LEU:O	2.00	0.61
3:O:5097:VAL:HG21	3:O:5107:TRP:CZ3	2.36	0.61
3:G:3102:ILE:HG22	4:H:3534:CYS:CB	2.13	0.61
2:J:2505:ASP:O	2:J:2726:ARG:NH1	2.32	0.61
3:K:4102:ILE:HG21	4:L:4552:ASP:CA	2.31	0.61
4:P:5662:MET:HA	4:P:5680:TYR:O	2.01	0.61
2:F:1558:LYS:HZ1	4:H:3526:ILE:CG2	1.97	0.60
2:F:1581:HIS:NE2	2:F:1583:GLY:O	2.34	0.60
3:C:118:ALA:CB	3:C:150:PHE:CD2	2.77	0.60
1:E:1053:THR:OG1	1:E:1236:GLN:OE1	2.18	0.60
1:I:2053:THR:OG1	1:I:2236:GLN:OE1	2.18	0.60
1:M:3053:THR:OG1	1:M:3236:GLN:OE1	2.18	0.60
3:C:97:VAL:HG21	3:C:107:TRP:CZ3	2.36	0.60
3:K:4097:VAL:HG21	3:K:4107:TRP:CZ3	2.36	0.60
3:K:4145:LEU:HD13	4:L:4680:TYR:HE2	1.67	0.60
3:C:118:ALA:HB1	3:C:150:PHE:CD2	2.36	0.60
2:F:1759:LEU:HD11	1:M:3198:ALA:HB3	1.81	0.60
4:D:506:GLN:CD	4:D:590:CYS:SG	2.79	0.60
4:H:3631:ASN:HA	4:H:3685:ALA:CB	2.25	0.60
4:L:4513:SER:OG	4:L:4609:LEU:CD2	2.44	0.60
3:O:5118:ALA:CB	3:O:5150:PHE:HE2	1.65	0.60
3:O:5145:LEU:HD13	4:P:5680:TYR:HE2	1.67	0.60

Continued on next page...

Continued from previous page...

Atom-1	Atom-2	Interatomic distance (Å)	Clash overlap (Å)
3:C:9:ARG:HG2	3:C:112:THR:H	1.66	0.60
4:L:4662:MET:HA	4:L:4680:TYR:O	2.01	0.60
4:D:514:PRO:CD	4:D:609:LEU:HB3	2.31	0.60
3:G:3102:ILE:HG21	4:H:3552:ASP:CA	2.31	0.60
3:K:4009:ARG:O	3:K:4153:PRO:HD3	2.02	0.60
4:L:4514:PRO:CD	4:L:4609:LEU:HB3	2.30	0.60
4:D:514:PRO:HD3	4:D:609:LEU:HB3	1.79	0.60
3:G:3009:ARG:HG2	3:G:3112:THR:H	1.65	0.60
4:H:3514:PRO:CD	4:H:3609:LEU:HB3	2.31	0.60
4:P:5686:ARG:HG3	4:P:5686:ARG:HH11	1.67	0.60
3:C:9:ARG:O	3:C:153:PRO:HD3	2.02	0.60
3:C:102:ILE:HG21	4:D:552:ASP:CA	2.31	0.60
3:G:3009:ARG:O	3:G:3153:PRO:HD3	2.02	0.60
2:F:1544:THR:HG23	4:H:3534:CYS:SG	2.39	0.59
4:H:3686:ARG:HG3	4:H:3686:ARG:HH11	1.67	0.59
2:J:2581:HIS:NE2	2:J:2583:GLY:O	2.34	0.59
4:L:4528:ALA:HA	4:L:4571:ASP:HB2	1.84	0.59
4:P:5541:LYS:HE2	4:P:5583:GLU:O	2.02	0.59
4:D:631:ASN:HA	4:D:685:ALA:CB	2.25	0.59
3:K:4118:ALA:HB1	3:K:4150:PHE:CD2	2.36	0.59
4:L:4541:LYS:HE2	4:L:4583:GLU:O	2.02	0.59
4:L:4686:ARG:HH11	4:L:4686:ARG:HG3	1.67	0.59
2:N:3559:THR:HG1	4:P:5595:ASN:CG	2.01	0.59
3:O:5009:ARG:HG2	3:O:5112:THR:H	1.65	0.59
2:B:581:HIS:NE2	2:B:583:GLY:O	2.34	0.59
3:C:21:SER:HA	3:C:80:TYR:CD2	2.37	0.59
3:K:4102:ILE:CG2	3:K:4102:ILE:O	2.51	0.59
2:N:3718:LYS:CB	3:O:5059:THR:CG2	2.79	0.59
3:O:5021:SER:HA	3:O:5080:TYR:CD2	2.37	0.59
4:D:528:ALA:HA	4:D:571:ASP:HB2	1.85	0.59
3:G:3102:ILE:CG2	3:G:3102:ILE:O	2.51	0.59
2:B:718:LYS:CD	4:D:596:ASN:O	2.39	0.59
3:C:102:ILE:HG23	4:D:534:CYS:HG	1.67	0.59
3:G:3021:SER:HA	3:G:3080:TYR:CD2	2.37	0.59
2:N:3561:LYS:HB2	4:P:5532:SER:HB2	1.85	0.59
3:O:5009:ARG:O	3:O:5153:PRO:HD3	2.02	0.59
3:C:35:LEU:HD23	3:C:37:VAL:HG23	1.82	0.59
3:K:4118:ALA:HB3	3:K:4150:PHE:HE2	0.78	0.59
4:H:3514:PRO:HD3	4:H:3609:LEU:C	2.23	0.59
4:D:689:GLU:HA	4:D:711:ARG:NH2	2.18	0.59
4:H:3689:GLU:HA	4:H:3711:ARG:NH2	2.18	0.59

Continued on next page...

Continued from previous page...

Atom-1	Atom-2	Interatomic distance (Å)	Clash overlap (Å)
2:N:3581:HIS:NE2	2:N:3583:GLY:O	2.34	0.59
1:A:291:ILE:HG21	1:I:2306:GLU:HB3	1.84	0.58
3:G:3097:VAL:HG21	3:G:3107:TRP:CZ3	2.36	0.58
1:M:3038:ILE:HD12	1:M:3269:ALA:HB3	1.85	0.58
2:N:3556:ASN:O	4:P:5595:ASN:ND2	2.33	0.58
4:D:514:PRO:HD3	4:D:609:LEU:C	2.23	0.58
3:K:4021:SER:HA	3:K:4080:TYR:CD2	2.37	0.58
4:L:4689:GLU:HA	4:L:4711:ARG:NH2	2.18	0.58
2:N:3678:SER:OG	3:O:5047:TRP:CZ3	2.34	0.58
4:D:541:LYS:HE2	4:D:583:GLU:O	2.02	0.58
3:G:3118:ALA:HB1	3:G:3150:PHE:CD2	2.36	0.58
3:O:5002:ILE:CD1	3:O:5098:ARG:HH12	1.83	0.58
1:A:291:ILE:HG12	1:I:2306:GLU:CB	2.32	0.58
3:C:102:ILE:HG22	4:D:534:CYS:CB	2.13	0.58
3:G:3145:LEU:HD13	4:H:3680:TYR:HE2	1.67	0.58
4:L:4514:PRO:HD3	4:L:4609:LEU:HB3	1.79	0.58
4:P:5689:GLU:HA	4:P:5711:ARG:NH2	2.18	0.58
3:C:145:LEU:HD13	4:D:680:TYR:HE2	1.66	0.58
2:F:1569:HIS:N	2:F:1599:GLY:O	2.37	0.58
4:H:3541:LYS:HE2	4:H:3583:GLU:O	2.02	0.58
2:J:2680:ALA:HA	3:K:4062:GLU:CG	2.20	0.58
3:O:5118:ALA:HB3	3:O:5150:PHE:HE2	0.78	0.58
4:P:5528:ALA:HA	4:P:5571:ASP:HB2	1.85	0.58
2:J:2547:VAL:CG1	3:K:4102:ILE:CD1	2.82	0.58
3:C:21:SER:HG	3:C:80:TYR:HE2	0.61	0.58
1:E:1038:ILE:HD12	1:E:1269:ALA:HB3	1.85	0.58
4:H:3514:PRO:CD	4:H:3609:LEU:HB2	2.31	0.58
4:H:3688:TRP:CZ2	4:H:3711:ARG:HG3	2.39	0.58
2:J:2678:SER:N	4:L:4501:GLN:NE2	2.41	0.58
3:O:5102:ILE:HG21	4:P:5552:ASP:CA	2.31	0.58
3:O:5102:ILE:CG2	3:O:5102:ILE:O	2.51	0.58
1:A:38:ILE:HD12	1:A:269:ALA:HB3	1.85	0.58
4:D:686:ARG:HH11	4:D:686:ARG:HG3	1.67	0.58
4:H:3528:ALA:HA	4:H:3571:ASP:HB2	1.85	0.58
2:N:3678:SER:HG	4:P:5597:LEU:HB2	1.68	0.58
1:E:1387:HIS:CD2	2:F:1825:GLN:HE21	2.22	0.58
1:M:3387:HIS:CD2	2:N:3825:GLN:HE21	2.22	0.58
3:G:3145:LEU:CD1	4:H:3680:TYR:HE2	2.17	0.57
3:O:5145:LEU:CD1	4:P:5680:TYR:HE2	2.17	0.57
2:B:569:HIS:N	2:B:599:GLY:O	2.37	0.57
3:K:4145:LEU:CD1	4:L:4680:TYR:HE2	2.18	0.57

Continued on next page...

Continued from previous page...

Atom-1	Atom-2	Interatomic distance (Å)	Clash overlap (Å)
4:L:4631:ASN:C	4:L:4685:ALA:HB2	2.25	0.57
2:N:3561:LYS:CE	4:P:5532:SER:CB	2.80	0.57
4:P:5514:PRO:HD3	4:P:5609:LEU:C	2.23	0.57
3:C:118:ALA:HB3	3:C:150:PHE:HE2	0.78	0.57
4:D:554:ASN:C	4:D:554:ASN:ND2	2.54	0.57
2:N:3675:THR:HG21	4:P:5501:GLN:HA	1.86	0.57
3:O:5061:ALA:HB3	3:O:5064:PHE:HD2	1.70	0.57
3:O:5102:ILE:HG13	4:P:5552:ASP:CB	2.34	0.57
2:N:3675:THR:CG2	4:P:5501:GLN:HA	2.34	0.57
4:D:631:ASN:C	4:D:685:ALA:HB2	2.25	0.57
4:L:4514:PRO:HD3	4:L:4609:LEU:C	2.23	0.57
1:M:3391:TYR:CZ	2:N:3784:LEU:HD11	2.40	0.57
4:P:5611:GLN:HG3	4:P:5611:GLN:O	2.05	0.57
3:C:45:PHE:HE1	4:D:589:PHE:CE2	2.22	0.57
3:K:4102:ILE:HG13	4:L:4552:ASP:CB	2.34	0.57
4:L:4688:TRP:CZ2	4:L:4711:ARG:HG3	2.39	0.57
1:A:391:TYR:CZ	2:B:784:LEU:HD11	2.40	0.57
2:B:680:ALA:HA	3:C:62:GLU:CD	2.24	0.57
3:C:78:THR:HG22	3:C:80:TYR:CZ	2.25	0.57
3:C:117:SER:O	3:C:118:ALA:HB2	2.05	0.57
2:F:1677:PRO:CA	4:H:3501:GLN:C	2.72	0.57
4:H:3611:GLN:HG3	4:H:3611:GLN:O	2.05	0.57
1:I:2391:TYR:CZ	2:J:2784:LEU:HD11	2.39	0.57
2:N:3558:LYS:N	4:P:5595:ASN:ND2	2.48	0.57
3:C:61:ALA:HB3	3:C:64:PHE:HD2	1.70	0.57
4:D:688:TRP:CZ2	4:D:711:ARG:HG3	2.39	0.57
2:F:1577:SER:O	2:F:1589:GLN:N	2.37	0.57
2:J:2560:GLN:CD	4:L:4595:ASN:O	2.43	0.57
3:O:5100:TYR:CE2	3:O:5101:PHE:CZ	2.93	0.57
4:P:5524:SER:OG	4:P:5594:TYR:OH	2.23	0.57
1:A:387:HIS:CD2	2:B:825:GLN:HE21	2.22	0.57
3:C:100:TYR:CE2	3:C:101:PHE:CZ	2.93	0.57
2:F:1718:LYS:HG3	4:H:3595:ASN:O	2.04	0.57
3:K:4030:THR:CG2	3:K:4054:ASN:HD22	2.17	0.57
4:L:4514:PRO:CD	4:L:4609:LEU:HB2	2.31	0.57
2:N:3530:GLY:O	2:N:3590:CYS:N	2.38	0.57
2:N:3577:SER:O	2:N:3589:GLN:N	2.37	0.57
3:O:5040:ALA:C	3:O:5041:PRO:CD	2.63	0.57
1:E:1391:TYR:CZ	2:F:1784:LEU:HD11	2.40	0.56
3:G:3100:TYR:CE2	3:G:3101:PHE:CZ	2.93	0.56
4:L:4557:ARG:HE	4:L:4560:VAL:HG23	1.70	0.56

Continued on next page...

Continued from previous page...

Atom-1	Atom-2	Interatomic distance (Å)	Clash overlap (Å)
3:O:5117:SER:O	3:O:5118:ALA:HB2	2.05	0.56
3:C:102:ILE:CG2	3:C:102:ILE:O	2.51	0.56
3:G:3118:ALA:HB3	3:G:3150:PHE:HE2	0.78	0.56
1:I:2038:ILE:HD12	1:I:2269:ALA:HB3	1.85	0.56
2:N:3561:LYS:HB2	4:P:5532:SER:CB	2.31	0.56
3:C:145:LEU:CD1	4:D:680:TYR:HE2	2.17	0.56
4:D:557:ARG:HE	4:D:560:VAL:HG23	1.70	0.56
4:D:611:GLN:HG3	4:D:611:GLN:O	2.05	0.56
2:F:1530:GLY:O	2:F:1590:CYS:N	2.38	0.56
3:K:4100:TYR:CE2	3:K:4101:PHE:CZ	2.93	0.56
4:P:5688:TRP:CZ2	4:P:5711:ARG:HG3	2.39	0.56
2:N:3675:THR:HG21	4:P:5501:GLN:CA	2.35	0.56
3:O:5126:TYR:CZ	4:P:5627:GLU:HG3	2.41	0.56
4:H:3631:ASN:C	4:H:3685:ALA:HB2	2.25	0.56
3:K:4021:SER:CB	3:K:4080:TYR:HE2	2.13	0.56
4:L:4653:VAL:CG2	4:L:4658:VAL:HG21	2.35	0.56
3:G:3061:ALA:HB3	3:G:3064:PHE:HD2	1.70	0.56
1:I:2057:SER:OG	2:J:2724:SER:O	2.16	0.56
3:O:5030:THR:CG2	3:O:5054:ASN:HD22	2.17	0.56
4:P:5631:ASN:C	4:P:5685:ALA:HB2	2.25	0.56
3:G:3117:SER:O	3:G:3118:ALA:HB2	2.05	0.56
4:H:3514:PRO:HD3	4:H:3609:LEU:HB3	1.79	0.56
2:J:2543:LYS:NZ	4:L:4552:ASP:OD1	2.39	0.56
2:F:1697:SER:HA	4:H:3501:GLN:HE21	1.59	0.56
2:J:2563:ILE:CG2	4:L:4532:SER:CA	2.84	0.56
3:K:4045:PHE:HE1	4:L:4589:PHE:CE2	2.22	0.56
3:K:4126:TYR:CZ	4:L:4627:GLU:HG3	2.41	0.56
3:C:126:TYR:CZ	4:D:627:GLU:HG3	2.41	0.56
2:F:1678:SER:N	4:H:3501:GLN:N	2.53	0.56
4:H:3557:ARG:HE	4:H:3560:VAL:HG23	1.70	0.56
3:K:4117:SER:O	3:K:4118:ALA:HB2	2.05	0.56
3:G:3126:TYR:CZ	4:H:3627:GLU:HG3	2.41	0.56
1:I:2387:HIS:CD2	2:J:2825:GLN:HE21	2.22	0.56
4:L:4611:GLN:HG3	4:L:4611:GLN:O	2.05	0.56
4:P:5557:ARG:HE	4:P:5560:VAL:HG23	1.70	0.56
1:A:194:GLY:N	1:A:205:GLN:OE1	2.39	0.55
1:A:221:LYS:O	1:A:235:THR:OG1	2.19	0.55
2:J:2530:GLY:O	2:J:2590:CYS:N	2.38	0.55
3:K:4045:PHE:CE1	4:L:4589:PHE:CZ	2.94	0.55
2:N:3569:HIS:N	2:N:3599:GLY:O	2.37	0.55
1:A:291:ILE:CG2	1:I:2316:ILE:CD1	2.84	0.55

Continued on next page...

Continued from previous page...

Atom-1	Atom-2	Interatomic distance (Å)	Clash overlap (Å)
4:D:689:GLU:HA	4:D:711:ARG:HE	1.72	0.55
3:K:4061:ALA:HB3	3:K:4064:PHE:HD2	1.70	0.55
4:L:4620:LEU:HD23	4:L:4636:VAL:O	2.06	0.55
4:L:4653:VAL:HG23	4:L:4658:VAL:CG2	2.35	0.55
2:N:3561:LYS:HA	4:P:5532:SER:CB	2.36	0.55
4:H:3554:ASN:C	4:H:3554:ASN:ND2	2.54	0.55
4:L:4620:LEU:HD21	4:L:4651:TRP:HH2	1.72	0.55
1:M:3194:GLY:N	1:M:3205:GLN:OE1	2.39	0.55
3:O:5045:PHE:CE1	4:P:5589:PHE:CZ	2.94	0.55
4:P:5653:VAL:HG23	4:P:5658:VAL:CG2	2.35	0.55
4:D:620:LEU:HD23	4:D:636:VAL:O	2.06	0.55
2:J:2507:PRO:HB3	2:N:3630:GLU:HB2	1.89	0.55
3:K:4102:ILE:CG2	4:L:4552:ASP:CG	2.75	0.55
1:A:371:CYS:O	1:A:372:THR:OG1	2.25	0.55
2:B:680:ALA:CA	3:C:62:GLU:CG	2.85	0.55
3:C:45:PHE:CE1	4:D:589:PHE:CZ	2.94	0.55
3:K:4078:THR:CG2	3:K:4080:TYR:CE2	2.84	0.55
3:O:5073:GLU:CD	3:O:5080:TYR:CE1	2.80	0.55
4:P:5620:LEU:HD23	4:P:5636:VAL:O	2.06	0.55
4:D:653:VAL:HG23	4:D:658:VAL:CG2	2.35	0.55
1:E:1194:GLY:N	1:E:1205:GLN:OE1	2.39	0.55
3:G:3045:PHE:CE1	4:H:3589:PHE:CZ	2.94	0.55
4:H:3689:GLU:HA	4:H:3711:ARG:HE	1.72	0.55
2:J:2569:HIS:N	2:J:2599:GLY:O	2.37	0.55
3:O:5045:PHE:HE1	4:P:5589:PHE:CE2	2.22	0.55
2:B:530:GLY:O	2:B:590:CYS:N	2.38	0.55
2:F:1508:ASN:OD1	2:F:1610:THR:OG1	2.11	0.55
4:H:3620:LEU:HD21	4:H:3651:TRP:HH2	1.72	0.55
2:J:2502:TYR:N	2:J:2537:SER:O	2.40	0.55
2:J:2577:SER:O	2:J:2589:GLN:N	2.37	0.55
4:L:4565:SER:O	4:L:4575:LEU:HD23	2.07	0.55
4:L:4689:GLU:HA	4:L:4711:ARG:HH21	1.72	0.55
3:O:5032:TYR:CE1	3:O:5100:TYR:CB	2.89	0.55
3:O:5035:LEU:HD23	3:O:5037:VAL:HG23	1.82	0.55
4:P:5565:SER:O	4:P:5575:LEU:HD23	2.07	0.55
3:G:3011:VAL:HB	3:G:3151:PRO:HB2	1.87	0.55
4:D:620:LEU:HD21	4:D:651:TRP:HH2	1.72	0.55
4:H:3565:SER:O	4:H:3575:LEU:HD23	2.07	0.55
1:I:2194:GLY:N	1:I:2205:GLN:OE1	2.39	0.55
4:P:5554:ASN:C	4:P:5554:ASN:ND2	2.54	0.55
2:B:502:TYR:N	2:B:537:SER:O	2.40	0.54

Continued on next page...

Continued from previous page...

Atom-1	Atom-2	Interatomic distance (Å)	Clash overlap (Å)
3:C:30:THR:CG2	3:C:54:ASN:HD22	2.17	0.54
3:C:73:GLU:CD	3:C:80:TYR:CE1	2.80	0.54
4:D:565:SER:O	4:D:575:LEU:HD23	2.07	0.54
3:G:3078:THR:CG2	3:G:3080:TYR:CE2	2.84	0.54
3:O:5102:ILE:HG22	4:P:5552:ASP:HA	1.89	0.54
4:D:689:GLU:HA	4:D:711:ARG:HH21	1.72	0.54
4:D:514:PRO:CD	4:D:609:LEU:HB2	2.31	0.54
2:F:1594:ASP:OD2	2:J:2627:HIS:HB2	2.08	0.54
3:G:3073:GLU:CD	3:G:3080:TYR:CE1	2.80	0.54
3:O:5102:ILE:CG2	4:P:5552:ASP:CG	2.75	0.54
3:K:4073:GLU:CD	3:K:4080:TYR:CE1	2.80	0.54
2:N:3561:LYS:CD	4:P:5532:SER:CB	2.76	0.54
2:N:3718:LYS:CD	3:O:5059:THR:HG23	2.33	0.54
2:N:3718:LYS:HD3	3:O:5059:THR:HG23	1.82	0.54
2:B:652:GLU:OE2	2:B:738:LYS:NZ	2.41	0.54
2:F:1677:PRO:HD2	2:F:1680:ALA:HB3	1.90	0.54
3:G:3035:LEU:HD23	3:G:3037:VAL:HG23	1.83	0.54
4:H:3620:LEU:HD23	4:H:3636:VAL:O	2.06	0.54
3:K:4011:VAL:HB	3:K:4151:PRO:HB2	1.87	0.54
2:F:1630:GLU:HB2	2:N:3507:PRO:HB3	1.89	0.54
4:L:4689:GLU:HA	4:L:4711:ARG:HE	1.72	0.54
1:M:3371:CYS:O	1:M:3372:THR:OG1	2.25	0.54
2:N:3502:TYR:N	2:N:3537:SER:O	2.40	0.54
2:N:3652:GLU:OE2	2:N:3738:LYS:NZ	2.41	0.54
2:F:1678:SER:O	4:H:3597:LEU:HD13	2.06	0.54
4:L:4700:HIS:O	4:L:4701:GLU:C	2.46	0.54
4:P:5653:VAL:CG2	4:P:5658:VAL:HG21	2.35	0.54
3:C:32:TYR:CE1	3:C:100:TYR:CB	2.89	0.54
1:E:1061:LYS:NZ	1:E:1063:CYS:O	2.41	0.54
2:F:1502:TYR:N	2:F:1537:SER:O	2.40	0.54
2:J:2652:GLU:OE2	2:J:2738:LYS:NZ	2.41	0.54
3:C:78:THR:CG2	3:C:80:TYR:CE2	2.84	0.54
1:E:1221:LYS:O	1:E:1235:THR:OG1	2.19	0.54
4:H:3689:GLU:HA	4:H:3711:ARG:HH21	1.72	0.54
1:M:3061:LYS:NZ	1:M:3063:CYS:O	2.41	0.54
3:O:5011:VAL:CG2	3:O:5152:GLU:HB2	2.38	0.54
4:P:5689:GLU:HA	4:P:5711:ARG:NE	2.23	0.54
4:P:5689:GLU:HA	4:P:5711:ARG:HH21	1.72	0.54
3:G:3011:VAL:CG2	3:G:3152:GLU:HB2	2.38	0.53
3:G:3102:ILE:HG22	4:H:3552:ASP:HA	1.89	0.53
2:B:690:ASP:OD2	2:B:702:THR:N	2.41	0.53

Continued on next page...

Continued from previous page...

Atom-1	Atom-2	Interatomic distance (Å)	Clash overlap (Å)
2:F:1627:HIS:HB2	2:N:3594:ASP:OD2	2.08	0.53
3:G:3102:ILE:CG2	4:H:3552:ASP:CG	2.75	0.53
4:L:4689:GLU:HA	4:L:4711:ARG:NE	2.23	0.53
4:P:5700:HIS:O	4:P:5701:GLU:C	2.46	0.53
1:A:61:LYS:NZ	1:A:63:CYS:O	2.41	0.53
3:C:11:VAL:HB	3:C:151:PRO:HB2	1.87	0.53
3:G:3032:TYR:CE1	3:G:3100:TYR:CB	2.89	0.53
1:I:2061:LYS:NZ	1:I:2063:CYS:O	2.41	0.53
4:L:4654:ASP:OD2	4:L:4691:HIS:HB3	2.08	0.53
2:N:3563:ILE:HG21	4:P:5531:SER:OG	2.09	0.53
4:P:5514:PRO:CD	4:P:5609:LEU:HB2	2.31	0.53
1:I:2197:LYS:O	1:I:2200:SER:OG	2.18	0.53
2:J:2690:ASP:OD2	2:J:2702:THR:N	2.42	0.53
3:O:5045:PHE:HZ	4:P:5546:PHE:HZ	0.62	0.53
4:P:5689:GLU:HA	4:P:5711:ARG:HE	1.72	0.53
3:C:21:SER:OG	3:C:80:TYR:CD2	2.37	0.53
3:G:3128:LEU:HB3	4:H:3621:PHE:CG	2.44	0.53
2:J:2594:ASP:OD2	2:N:3627:HIS:HB2	2.08	0.53
2:N:3561:LYS:CA	4:P:5532:SER:CB	2.86	0.53
3:C:11:VAL:CG2	3:C:152:GLU:HB2	2.38	0.53
3:C:33:PRO:HA	3:C:53:THR:HG23	1.91	0.53
3:C:128:LEU:HB3	4:D:621:PHE:CG	2.44	0.53
4:L:4683:LEU:HD22	4:L:4687:ALA:HB1	1.91	0.53
3:O:5011:VAL:HB	3:O:5151:PRO:HB2	1.87	0.53
4:P:5654:ASP:OD2	4:P:5691:HIS:HB3	2.08	0.53
4:D:504:VAL:CG1	4:D:522:CYS:SG	2.97	0.53
4:D:700:HIS:O	4:D:701:GLU:C	2.46	0.53
3:G:3045:PHE:HE1	4:H:3589:PHE:CE2	2.22	0.53
4:H:3689:GLU:HA	4:H:3711:ARG:NE	2.23	0.53
3:K:4102:ILE:HG22	4:L:4552:ASP:HA	1.89	0.53
4:P:5620:LEU:HD21	4:P:5651:TRP:HH2	1.72	0.53
1:E:1035:ASN:OD1	1:E:1036:THR:N	2.42	0.53
3:G:3033:PRO:HA	3:G:3053:THR:HG23	1.91	0.53
1:I:2221:LYS:O	1:I:2235:THR:OG1	2.19	0.53
3:O:5128:LEU:HB3	4:P:5621:PHE:CG	2.44	0.53
1:A:343:ASN:OD1	1:A:344:ASP:N	2.42	0.53
3:C:30:THR:O	3:C:30:THR:HG22	2.09	0.53
2:F:1678:SER:O	4:H:3597:LEU:CD2	2.57	0.53
2:F:1690:ASP:OD2	2:F:1702:THR:N	2.41	0.53
3:G:3102:ILE:CB	4:H:3552:ASP:CG	2.78	0.53
4:H:3630:THR:HG22	4:H:3632:LYS:HB2	1.91	0.53

Continued on next page...

Continued from previous page...

Atom-1	Atom-2	Interatomic distance (Å)	Clash overlap (Å)
3:K:4011:VAL:CG2	3:K:4152:GLU:HB2	2.38	0.53
3:O:5033:PRO:HA	3:O:5053:THR:HG23	1.91	0.53
4:P:5514:PRO:HG2	4:P:5609:LEU:O	2.03	0.53
3:O:5030:THR:O	3:O:5030:THR:HG22	2.09	0.53
3:O:5037:VAL:HG21	3:O:5107:TRP:HH2	1.70	0.53
3:O:5118:ALA:CB	3:O:5150:PHE:CD2	2.77	0.53
4:P:5504:VAL:CG1	4:P:5522:CYS:SG	2.97	0.53
1:E:1005:ALA:N	1:E:1279:ILE:O	2.42	0.52
2:F:1652:GLU:OE2	2:F:1738:LYS:NZ	2.41	0.52
4:H:3654:ASP:OD2	4:H:3691:HIS:HB3	2.08	0.52
4:H:3700:HIS:O	4:H:3701:GLU:C	2.46	0.52
2:J:2563:ILE:HG22	4:L:4532:SER:CA	2.38	0.52
3:K:4128:LEU:HB3	4:L:4621:PHE:CG	2.44	0.52
3:O:5102:ILE:CB	4:P:5552:ASP:CG	2.78	0.52
4:D:630:THR:HG22	4:D:632:LYS:HB2	1.91	0.52
2:F:1507:PRO:HB3	2:J:2630:GLU:HB2	1.89	0.52
4:H:3683:LEU:HD22	4:H:3687:ALA:HB1	1.91	0.52
1:I:2035:ASN:OD1	1:I:2036:THR:N	2.42	0.52
1:I:2343:ASN:OD1	1:I:2344:ASP:N	2.42	0.52
4:L:4630:THR:HG22	4:L:4632:LYS:HB2	1.91	0.52
1:M:3035:ASN:OD1	1:M:3036:THR:N	2.42	0.52
1:M:3260:CYS:H	2:N:3782:ARG:HH22	1.58	0.52
1:A:35:ASN:OD1	1:A:36:THR:N	2.42	0.52
3:C:102:ILE:HG22	4:D:552:ASP:HA	1.89	0.52
1:E:1343:ASN:OD1	1:E:1344:ASP:N	2.42	0.52
4:H:3504:VAL:CG1	4:H:3522:CYS:SG	2.97	0.52
3:K:4030:THR:O	3:K:4030:THR:HG22	2.09	0.52
3:K:4032:TYR:CE1	3:K:4100:TYR:CB	2.89	0.52
3:K:4037:VAL:HG21	3:K:4107:TRP:HH2	1.70	0.52
2:N:3677:PRO:HD2	2:N:3680:ALA:HB3	1.90	0.52
3:C:33:PRO:HB2	3:C:51:ILE:O	2.09	0.52
3:G:3033:PRO:HB2	3:G:3051:ILE:O	2.09	0.52
4:H:3653:VAL:HG23	4:H:3658:VAL:CG2	2.35	0.52
3:K:4033:PRO:HA	3:K:4053:THR:HG23	1.91	0.52
3:K:4212:LYS:CE	4:L:4626:GLU:OE1	2.58	0.52
2:N:3690:ASP:OD2	2:N:3702:THR:N	2.42	0.52
2:B:577:SER:O	2:B:589:GLN:N	2.37	0.52
4:D:654:ASP:OD2	4:D:691:HIS:HB3	2.08	0.52
1:I:2005:ALA:N	1:I:2279:ILE:O	2.42	0.52
3:K:4102:ILE:CB	4:L:4552:ASP:CG	2.77	0.52
4:L:4504:VAL:CG1	4:L:4522:CYS:SG	2.97	0.52

Continued on next page...

Continued from previous page...

Atom-1	Atom-2	Interatomic distance (Å)	Clash overlap (Å)
1:M:3315:GLY:O	1:M:3357:PHE:N	2.42	0.52
1:M:3343:ASN:OD1	1:M:3344:ASP:N	2.42	0.52
3:C:212:LYS:CE	4:D:626:GLU:OE1	2.58	0.52
2:J:2677:PRO:HD2	2:J:2680:ALA:HB3	1.90	0.52
3:K:4032:TYR:CE1	3:K:4100:TYR:HD1	1.97	0.52
2:N:3679:GLY:HA3	3:O:5063:GLU:H	1.69	0.52
3:O:5102:ILE:HG22	4:P:5534:CYS:CB	2.13	0.52
3:G:3102:ILE:HG13	4:H:3552:ASP:CB	2.34	0.52
4:H:3520:LEU:N	4:H:3520:LEU:CD2	2.70	0.52
3:O:5212:LYS:CE	4:P:5626:GLU:OE1	2.58	0.52
4:D:653:VAL:CG2	4:D:658:VAL:HG21	2.35	0.52
4:D:689:GLU:HA	4:D:711:ARG:NE	2.23	0.52
3:G:3212:LYS:CE	4:H:3626:GLU:OE1	2.58	0.52
2:J:2543:LYS:HD3	3:K:4102:ILE:HD12	1.91	0.52
2:J:2547:VAL:HG22	3:K:4102:ILE:HD12	1.81	0.52
4:L:4542:PRO:HB2	4:L:4669:LYS:HB2	1.92	0.52
1:M:3005:ALA:N	1:M:3279:ILE:O	2.42	0.52
4:P:5683:LEU:HD22	4:P:5687:ALA:HB1	1.91	0.52
4:P:5684:THR:O	4:P:5685:ALA:C	2.48	0.52
2:B:677:PRO:HD2	2:B:680:ALA:HB3	1.90	0.52
3:C:97:VAL:CG2	3:C:107:TRP:CD2	2.93	0.52
3:C:107:TRP:HB2	4:D:546:PHE:CB	2.40	0.52
3:G:3035:LEU:HD23	3:G:3036:TRP:N	2.25	0.52
3:K:4033:PRO:HB2	3:K:4051:ILE:O	2.09	0.52
3:K:4097:VAL:CG2	3:K:4107:TRP:CD2	2.93	0.52
3:O:5097:VAL:CG2	3:O:5107:TRP:CD2	2.93	0.52
3:G:3097:VAL:CG2	3:G:3107:TRP:CD2	2.93	0.52
3:K:4035:LEU:HD23	3:K:4036:TRP:N	2.25	0.52
3:C:35:LEU:HD23	3:C:36:TRP:N	2.25	0.51
3:G:3030:THR:CG2	3:G:3054:ASN:HD22	2.17	0.51
2:J:2733:ASP:OD1	2:J:2734:THR:N	2.44	0.51
4:L:4684:THR:O	4:L:4685:ALA:C	2.48	0.51
2:N:3543:LYS:HZ3	3:O:5102:ILE:HG12	1.63	0.51
4:P:5542:PRO:HB2	4:P:5669:LYS:HB2	1.92	0.51
3:C:102:ILE:CB	4:D:552:ASP:CG	2.77	0.51
3:G:3107:TRP:HB2	4:H:3546:PHE:CB	2.40	0.51
3:O:5035:LEU:HD23	3:O:5036:TRP:N	2.25	0.51
4:D:683:LEU:HD22	4:D:687:ALA:HB1	1.91	0.51
1:E:1260:CYS:H	2:F:1782:ARG:HH22	1.58	0.51
3:K:4035:LEU:HD23	3:K:4037:VAL:HG23	1.82	0.51
2:N:3557:GLY:C	4:P:5595:ASN:ND2	2.64	0.51

Continued on next page...

Continued from previous page...

Atom-1	Atom-2	Interatomic distance (Å)	Clash overlap (Å)
2:N:3733:ASP:OD1	2:N:3734:THR:N	2.44	0.51
1:A:5:ALA:N	1:A:279:ILE:O	2.42	0.51
1:A:389:VAL:HG12	1:A:390:ASP:H	1.76	0.51
4:D:549:LEU:HD12	4:D:560:VAL:HG21	1.93	0.51
1:E:1315:GLY:O	1:E:1357:PHE:N	2.42	0.51
2:F:1558:LYS:NZ	4:H:3526:ILE:HG13	2.25	0.51
1:I:2260:CYS:H	2:J:2782:ARG:HH22	1.58	0.51
2:J:2569:HIS:O	2:J:2599:GLY:N	2.44	0.51
1:A:315:GLY:O	1:A:357:PHE:N	2.42	0.51
2:J:2508:ASN:OD1	2:J:2610:THR:OG1	2.11	0.51
3:O:5032:TYR:CE1	3:O:5100:TYR:HD1	1.97	0.51
4:P:5520:LEU:N	4:P:5520:LEU:CD2	2.71	0.51
4:P:5630:THR:HG22	4:P:5632:LYS:HB2	1.92	0.51
1:E:1117:ASP:OD1	1:E:1181:TYR:OH	2.20	0.51
2:F:1677:PRO:O	4:H:3501:GLN:C	2.42	0.51
3:O:5033:PRO:HB2	3:O:5051:ILE:O	2.09	0.51
2:F:1569:HIS:O	2:F:1599:GLY:N	2.44	0.51
3:K:4107:TRP:HB2	4:L:4546:PHE:CB	2.40	0.51
4:P:5549:LEU:HD12	4:P:5560:VAL:HG21	1.93	0.51
3:C:102:ILE:CG2	4:D:552:ASP:CG	2.75	0.51
3:G:3030:THR:O	3:G:3030:THR:HG22	2.09	0.51
3:G:3032:TYR:CZ	3:G:3100:TYR:CZ	2.84	0.51
3:G:3032:TYR:CD1	3:G:3100:TYR:HB2	2.46	0.51
4:H:3653:VAL:CG2	4:H:3658:VAL:HG21	2.35	0.51
3:K:4013:ASN:OD1	3:K:4116:SER:O	2.29	0.51
3:O:5078:THR:CG2	3:O:5080:TYR:CE2	2.84	0.51
4:D:684:THR:O	4:D:685:ALA:C	2.48	0.51
1:E:1389:VAL:HG12	1:E:1390:ASP:H	1.76	0.51
2:F:1733:ASP:OD1	2:F:1734:THR:N	2.44	0.51
4:L:4549:LEU:HD12	4:L:4560:VAL:HG21	1.93	0.51
4:P:5589:PHE:CE1	4:P:5603:GLY:HA3	2.46	0.51
2:F:1559:THR:HA	4:H:3595:ASN:HD21	1.76	0.50
4:H:3542:PRO:HB2	4:H:3669:LYS:HB2	1.93	0.50
4:H:3589:PHE:CE1	4:H:3603:GLY:HA3	2.46	0.50
1:A:260:CYS:H	2:B:782:ARG:HH22	1.58	0.50
3:C:13:ASN:OD1	3:C:116:SER:O	2.29	0.50
4:D:589:PHE:CE1	4:D:603:GLY:HA3	2.46	0.50
4:H:3549:LEU:HD12	4:H:3560:VAL:HG21	1.93	0.50
1:I:2203:ASP:OD1	1:I:2204:LEU:N	2.43	0.50
4:L:4589:PHE:CE1	4:L:4603:GLY:HA3	2.46	0.50
1:M:3389:VAL:HG12	1:M:3390:ASP:H	1.76	0.50

Continued on next page...

Continued from previous page...

Atom-1	Atom-2	Interatomic distance (Å)	Clash overlap (Å)
2:N:3569:HIS:O	2:N:3599:GLY:N	2.44	0.50
2:B:508:ASN:OD1	2:B:610:THR:OG1	2.11	0.50
2:B:733:ASP:OD1	2:B:734:THR:N	2.44	0.50
1:E:1203:ASP:OD1	1:E:1204:LEU:N	2.43	0.50
1:I:2389:VAL:HG12	1:I:2390:ASP:H	1.76	0.50
4:L:4554:ASN:C	4:L:4554:ASN:ND2	2.54	0.50
1:M:3203:ASP:OD1	1:M:3204:LEU:N	2.43	0.50
3:O:5013:ASN:OD1	3:O:5116:SER:O	2.29	0.50
3:O:5107:TRP:HB2	4:P:5546:PHE:CB	2.40	0.50
3:C:37:VAL:HG21	3:C:107:TRP:HH2	1.70	0.50
4:D:542:PRO:HB2	4:D:669:LYS:HB2	1.92	0.50
1:I:2315:GLY:O	1:I:2357:PHE:N	2.42	0.50
1:A:15:TYR:O	1:A:17:ALA:N	2.44	0.50
1:A:388:ILE:HD12	1:A:388:ILE:O	2.12	0.50
1:M:3015:TYR:O	1:M:3017:ALA:N	2.44	0.50
2:B:569:HIS:O	2:B:599:GLY:N	2.44	0.50
3:C:102:ILE:HB	4:D:552:ASP:CA	2.40	0.50
4:L:4549:LEU:HD12	4:L:4560:VAL:CG2	2.42	0.50
4:P:5542:PRO:HB3	4:P:5669:LYS:CD	2.42	0.50
1:I:2388:ILE:HD12	1:I:2388:ILE:O	2.12	0.50
3:C:32:TYR:CD1	3:C:100:TYR:HB2	2.46	0.49
4:D:549:LEU:HD12	4:D:560:VAL:CG2	2.42	0.49
1:I:2007:MET:SD	1:I:2279:ILE:HD12	2.52	0.49
3:K:4102:ILE:HB	4:L:4552:ASP:CA	2.40	0.49
3:C:32:TYR:CE1	3:C:100:TYR:HD1	1.97	0.49
1:E:1388:ILE:HD12	1:E:1388:ILE:O	2.12	0.49
3:G:3013:ASN:OD1	3:G:3116:SER:O	2.29	0.49
1:I:2015:TYR:O	1:I:2017:ALA:N	2.44	0.49
3:K:4102:ILE:HG22	4:L:4534:CYS:CB	2.13	0.49
2:N:3716:ASP:OD2	4:P:5596:ASN:HB2	2.11	0.49
1:A:22:PRO:CB	1:I:2382:LYS:CB	2.76	0.49
4:H:3684:THR:O	4:H:3685:ALA:C	2.48	0.49
3:K:4104:LEU:N	4:L:4536:ASN:OD1	2.43	0.49
3:O:5032:TYR:CD1	3:O:5100:TYR:HB2	2.46	0.49
4:D:582:THR:HG1	4:D:610:GLY:HA3	1.76	0.49
4:H:3549:LEU:HD12	4:H:3560:VAL:CG2	2.42	0.49
2:N:3718:LYS:HZ2	4:P:5596:ASN:CA	2.21	0.49
3:C:24:ALA:HB1	3:C:27:TYR:HE1	1.75	0.49
1:M:3301:GLU:O	1:M:3320:ALA:N	2.43	0.49
1:A:203:ASP:OD1	1:A:204:LEU:N	2.43	0.49
3:C:217:ARG:HH21	4:D:622:PRO:CD	2.08	0.49

Continued on next page...

Continued from previous page...

Atom-1	Atom-2	Interatomic distance (Å)	Clash overlap (Å)
4:D:506:GLN:OE1	4:D:601:GLY:HA3	2.13	0.49
2:F:1796:GLU:N	2:F:1796:GLU:OE1	2.45	0.49
1:A:89:TRP:N	2:B:515:ASP:OD2	2.46	0.49
3:G:3002:ILE:HA	3:G:3025:SER:O	2.13	0.49
3:G:3035:LEU:HB3	3:G:3097:VAL:HB	1.95	0.49
4:H:3506:GLN:OE1	4:H:3601:GLY:HA3	2.13	0.49
1:M:3221:LYS:O	1:M:3235:THR:OG1	2.19	0.49
3:O:5002:ILE:HA	3:O:5025:SER:O	2.13	0.49
4:P:5549:LEU:HD12	4:P:5560:VAL:CG2	2.42	0.49
2:B:561:LYS:CB	4:D:532:SER:OG	2.61	0.49
1:M:3388:ILE:HD12	1:M:3388:ILE:O	2.12	0.49
1:A:265:GLU:OE1	1:A:268:ARG:NH2	2.46	0.49
1:A:301:GLU:O	1:A:320:ALA:N	2.43	0.49
1:E:1197:LYS:O	1:E:1200:SER:OG	2.18	0.49
3:G:3045:PHE:HZ	4:H:3546:PHE:HZ	0.62	0.49
4:L:4506:GLN:OE1	4:L:4601:GLY:HA3	2.13	0.49
3:O:5032:TYR:CZ	3:O:5100:TYR:CZ	2.84	0.49
1:E:1015:TYR:O	1:E:1017:ALA:N	2.44	0.48
1:I:2265:GLU:OE1	1:I:2268:ARG:NH2	2.46	0.48
1:I:2371:CYS:O	1:I:2372:THR:OG1	2.25	0.48
2:J:2558:LYS:CE	4:L:4501:GLN:HB2	2.42	0.48
3:K:4032:TYR:CD1	3:K:4100:TYR:HB2	2.46	0.48
3:O:5035:LEU:HB3	3:O:5097:VAL:HB	1.95	0.48
3:O:5217:ARG:HH21	4:P:5622:PRO:CD	2.08	0.48
3:C:2:ILE:HA	3:C:25:SER:O	2.13	0.48
3:C:35:LEU:HB3	3:C:97:VAL:HB	1.95	0.48
3:C:102:ILE:HG13	4:D:552:ASP:CB	2.34	0.48
1:E:1007:MET:SD	1:E:1279:ILE:HD12	2.52	0.48
3:G:3018:VAL:O	3:G:3082:GLN:HA	2.14	0.48
1:I:2117:ASP:OD1	1:I:2181:TYR:OH	2.20	0.48
1:M:3007:MET:SD	1:M:3279:ILE:HD12	2.52	0.48
4:P:5506:GLN:OE1	4:P:5601:GLY:HA3	2.13	0.48
1:A:7:MET:SD	1:A:279:ILE:HD12	2.52	0.48
1:E:1265:GLU:OE1	1:E:1268:ARG:NH2	2.46	0.48
3:G:3102:ILE:HB	4:H:3552:ASP:CA	2.40	0.48
1:I:2301:GLU:OE1	1:I:2303:LYS:NZ	2.40	0.48
1:M:3037:ARG:HH12	1:M:3132:MET:HG3	1.79	0.48
3:C:48:MET:HG2	3:C:64:PHE:CE1	2.48	0.48
3:G:3037:VAL:HG21	3:G:3107:TRP:HH2	1.70	0.48
2:J:2796:GLU:OE1	2:J:2796:GLU:N	2.46	0.48
3:K:4002:ILE:HA	3:K:4025:SER:O	2.13	0.48

Continued on next page...

Continued from previous page...

Atom-1	Atom-2	Interatomic distance (Å)	Clash overlap (Å)
3:K:4035:LEU:HB3	3:K:4097:VAL:HB	1.95	0.48
1:M:3268:ARG:NE	1:M:3270:GLU:OE2	2.47	0.48
1:E:1096:CYS:O	1:E:1100:ASN:ND2	2.46	0.48
1:I:2089:TRP:N	2:J:2515:ASP:OD2	2.46	0.48
3:K:4048:MET:HG2	3:K:4064:PHE:CE1	2.48	0.48
1:M:3265:GLU:OE1	1:M:3268:ARG:NH2	2.46	0.48
3:C:18:VAL:O	3:C:82:GLN:HA	2.14	0.48
2:F:1560:GLN:O	4:H:3532:SER:OG	2.30	0.48
3:G:3024:ALA:HB1	3:G:3027:TYR:HE1	1.75	0.48
4:H:3512:THR:HG22	4:H:3608:VAL:HG22	1.95	0.48
2:N:3716:ASP:OD2	4:P:5596:ASN:CG	2.52	0.48
2:N:3796:GLU:OE1	2:N:3796:GLU:N	2.45	0.48
2:B:796:GLU:OE1	2:B:796:GLU:N	2.46	0.48
1:I:2037:ARG:HH12	1:I:2132:MET:HG3	1.79	0.48
1:I:2268:ARG:NE	1:I:2270:GLU:OE2	2.47	0.48
1:M:3260:CYS:H	2:N:3782:ARG:NH2	2.11	0.48
1:E:1268:ARG:NE	1:E:1270:GLU:OE2	2.47	0.48
3:K:4039:GLN:CD	3:K:4045:PHE:CE1	2.87	0.48
3:K:4045:PHE:HZ	4:L:4546:PHE:HZ	0.62	0.48
1:M:3129:VAL:HG22	1:M:3149:VAL:HG11	1.96	0.48
2:N:3559:THR:HB	4:P:5595:ASN:H	1.18	0.48
3:G:3035:LEU:HG	3:G:3047:TRP:NE1	2.29	0.48
3:K:4035:LEU:HG	3:K:4047:TRP:NE1	2.29	0.48
3:K:4097:VAL:HG22	3:K:4107:TRP:CE3	2.49	0.48
1:A:37:ARG:HH12	1:A:132:MET:HG3	1.79	0.48
1:E:1260:CYS:H	2:F:1782:ARG:NH2	2.11	0.48
3:K:4217:ARG:HH21	4:L:4622:PRO:CD	2.08	0.48
3:O:5018:VAL:O	3:O:5082:GLN:HA	2.14	0.48
3:O:5035:LEU:HG	3:O:5047:TRP:NE1	2.29	0.48
3:O:5048:MET:HG2	3:O:5064:PHE:CE1	2.48	0.48
4:P:5656:THR:HA	4:P:5657:PRO:HD2	1.62	0.48
1:A:268:ARG:NE	1:A:270:GLU:OE2	2.47	0.47
2:B:680:ALA:HA	3:C:62:GLU:CG	2.43	0.47
3:C:97:VAL:HG21	3:C:107:TRP:CD2	2.49	0.47
4:P:5689:GLU:HA	4:P:5711:ARG:CZ	2.44	0.47
1:A:391:TYR:CE2	2:B:784:LEU:HD11	2.49	0.47
3:G:3097:VAL:HG21	3:G:3107:TRP:CD2	2.49	0.47
4:L:4703:HIS:ND1	4:L:4703:HIS:N	2.62	0.47
1:M:3391:TYR:CE2	2:N:3784:LEU:HD11	2.49	0.47
1:E:1089:TRP:N	2:F:1515:ASP:OD2	2.46	0.47
1:I:2312:ASP:OD1	1:I:2313:PHE:N	2.48	0.47

Continued on next page...

Continued from previous page...

Atom-1	Atom-2	Interatomic distance (Å)	Clash overlap (Å)
1:M:3312:ASP:OD1	1:M:3313:PHE:N	2.48	0.47
4:P:5512:THR:HG22	4:P:5608:VAL:HG22	1.95	0.47
1:A:129:VAL:HG22	1:A:149:VAL:HG11	1.96	0.47
1:A:390:ASP:O	2:B:823:TRP:HB3	2.14	0.47
2:B:558:LYS:O	4:D:595:ASN:ND2	2.37	0.47
3:C:45:PHE:HZ	4:D:546:PHE:HZ	0.62	0.47
2:F:1558:LYS:HZ1	4:H:3526:ILE:CB	2.28	0.47
3:G:3021:SER:HG	3:G:3080:TYR:HE2	0.53	0.47
4:H:3689:GLU:HA	4:H:3711:ARG:CZ	2.44	0.47
4:H:3703:HIS:ND1	4:H:3703:HIS:N	2.62	0.47
1:I:2260:CYS:H	2:J:2782:ARG:NH2	2.12	0.47
3:K:4097:VAL:HG21	3:K:4107:TRP:CD2	2.49	0.47
3:G:3048:MET:HG2	3:G:3064:PHE:CE1	2.48	0.47
1:I:2323:SER:N	1:I:2350:SER:OG	2.47	0.47
1:M:3096:CYS:O	1:M:3100:ASN:ND2	2.46	0.47
2:N:3556:ASN:O	2:N:3559:THR:OG1	2.30	0.47
3:O:5097:VAL:HG21	3:O:5107:TRP:CD2	2.49	0.47
1:E:1323:SER:N	1:E:1350:SER:OG	2.47	0.47
3:K:4018:VAL:O	3:K:4082:GLN:HA	2.14	0.47
1:M:3323:SER:N	1:M:3350:SER:OG	2.47	0.47
1:A:260:CYS:H	2:B:782:ARG:NH2	2.11	0.47
1:A:312:ASP:OD1	1:A:313:PHE:N	2.48	0.47
3:C:35:LEU:HG	3:C:47:TRP:NE1	2.29	0.47
3:C:107:TRP:CB	4:D:546:PHE:HB2	2.45	0.47
4:D:514:PRO:HG2	4:D:609:LEU:O	2.03	0.47
4:D:703:HIS:ND1	4:D:703:HIS:N	2.62	0.47
1:E:1229:ILE:HG21	2:F:1513:ARG:HE	1.80	0.47
1:E:1371:CYS:O	1:E:1372:THR:OG1	2.25	0.47
3:G:3011:VAL:CG2	3:G:3152:GLU:N	2.70	0.47
3:G:3103:SER:HA	4:H:3598:TRP:CH2	2.50	0.47
1:I:2391:TYR:CE2	2:J:2784:LEU:HD11	2.49	0.47
3:K:4103:SER:HA	4:L:4598:TRP:CH2	2.50	0.47
4:L:4542:PRO:HB3	4:L:4669:LYS:CD	2.42	0.47
4:L:4689:GLU:HA	4:L:4711:ARG:CZ	2.44	0.47
1:M:3197:LYS:O	1:M:3200:SER:OG	2.18	0.47
2:N:3677:PRO:HB2	4:P:5597:LEU:HD23	1.28	0.47
3:O:5103:SER:HA	4:P:5598:TRP:CH2	2.50	0.47
1:A:246:ARG:NH1	1:A:247:ASP:OD2	2.48	0.47
3:G:3011:VAL:CB	3:G:3151:PRO:CB	2.86	0.47
3:K:4107:TRP:CB	4:L:4546:PHE:HB2	2.45	0.47
3:O:5107:TRP:CB	4:P:5546:PHE:HB2	2.45	0.47

Continued on next page...

Continued from previous page...

Atom-1	Atom-2	Interatomic distance (Å)	Clash overlap (Å)
1:E:1246:ARG:NH1	1:E:1247:ASP:OD2	2.48	0.47
3:K:4030:THR:CG2	3:K:4054:ASN:ND2	2.78	0.47
4:L:4512:THR:HG22	4:L:4608:VAL:HG22	1.95	0.47
1:M:3229:ILE:HG21	2:N:3513:ARG:HE	1.80	0.47
3:O:5024:ALA:HB1	3:O:5027:TYR:HE1	1.75	0.47
1:A:323:SER:N	1:A:350:SER:OG	2.47	0.47
1:E:1037:ARG:HH12	1:E:1132:MET:HG3	1.79	0.47
1:E:1312:ASP:OD1	1:E:1313:PHE:N	2.48	0.47
1:I:2016:LYS:O	1:I:2332:HIS:ND1	2.48	0.47
1:I:2229:ILE:HG21	2:J:2513:ARG:HE	1.80	0.47
1:I:2390:ASP:O	2:J:2823:TRP:HB3	2.14	0.47
1:M:3016:LYS:O	1:M:3332:HIS:ND1	2.48	0.47
2:N:3697:SER:HB2	3:O:5063:GLU:HG2	1.96	0.47
3:O:5011:VAL:CB	3:O:5151:PRO:CB	2.86	0.47
4:P:5703:HIS:N	4:P:5703:HIS:ND1	2.62	0.47
3:C:103:SER:HA	4:D:598:TRP:CH2	2.50	0.46
4:D:689:GLU:HA	4:D:711:ARG:CZ	2.44	0.46
3:G:3039:GLN:CD	3:G:3045:PHE:CE1	2.87	0.46
1:M:3246:ARG:NH1	1:M:3247:ASP:OD2	2.48	0.46
1:M:3390:ASP:O	2:N:3823:TRP:HB3	2.14	0.46
1:A:16:LYS:O	1:A:332:HIS:ND1	2.48	0.46
1:A:229:ILE:HG21	2:B:513:ARG:HE	1.80	0.46
3:C:45:PHE:HE1	4:D:589:PHE:CZ	2.33	0.46
1:E:1391:TYR:CE2	2:F:1784:LEU:HD11	2.49	0.46
2:F:1560:GLN:C	4:H:3532:SER:HG	2.18	0.46
3:G:3107:TRP:CB	4:H:3546:PHE:HB2	2.45	0.46
4:D:512:THR:HG22	4:D:608:VAL:HG22	1.95	0.46
1:I:2129:VAL:HG22	1:I:2149:VAL:HG11	1.96	0.46
3:O:5097:VAL:HG22	3:O:5107:TRP:CD2	2.51	0.46
3:C:78:THR:CG2	3:C:80:TYR:OH	2.48	0.46
1:E:1016:LYS:O	1:E:1332:HIS:ND1	2.48	0.46
1:E:1390:ASP:O	2:F:1823:TRP:HB3	2.14	0.46
3:G:3097:VAL:HG22	3:G:3107:TRP:CD2	2.51	0.46
1:I:2246:ARG:NH1	1:I:2247:ASP:OD2	2.48	0.46
2:J:2547:VAL:HG11	3:K:4102:ILE:CD1	2.45	0.46
2:N:3558:LYS:HD2	4:P:5596:ASN:ND2	2.31	0.46
2:N:3661:ASP:OD1	2:N:3663:SER:OG	2.28	0.46
3:K:4097:VAL:HG22	3:K:4107:TRP:CD2	2.51	0.46
3:O:5047:TRP:NE1	3:O:5049:GLY:O	2.49	0.46
3:C:12:LYS:HD2	3:C:16:GLU:OE1	2.16	0.46
4:D:549:LEU:HA	4:D:560:VAL:HG21	1.97	0.46

Continued on next page...

Continued from previous page...

Atom-1	Atom-2	Interatomic distance (Å)	Clash overlap (Å)
1:E:1129:VAL:HG22	1:E:1149:VAL:HG11	1.96	0.46
3:K:4002:ILE:CD1	3:K:4098:ARG:HH11	2.15	0.46
3:O:5012:LYS:HD2	3:O:5016:GLU:OE1	2.15	0.46
4:P:5507:GLU:O	4:P:5604:THR:OG1	2.27	0.46
4:D:643:TYR:HA	4:D:644:PRO:C	2.36	0.46
3:G:3097:VAL:CG1	3:G:3104:LEU:HB3	2.46	0.46
3:K:4078:THR:CG2	3:K:4080:TYR:OH	2.48	0.46
4:L:4653:VAL:H	4:L:4658:VAL:HG23	1.81	0.46
1:E:1301:GLU:O	1:E:1320:ALA:N	2.43	0.46
3:G:3002:ILE:CD1	3:G:3098:ARG:HH11	2.15	0.46
3:G:3012:LYS:HD2	3:G:3016:GLU:OE1	2.16	0.46
3:K:4012:LYS:HD2	3:K:4016:GLU:OE1	2.15	0.46
3:K:4047:TRP:NE1	3:K:4049:GLY:O	2.49	0.46
4:P:5549:LEU:HA	4:P:5560:VAL:HG21	1.97	0.46
3:C:97:VAL:HG22	3:C:107:TRP:CD2	2.51	0.46
3:G:3078:THR:CG2	3:G:3080:TYR:OH	2.48	0.46
3:K:4045:PHE:HE1	4:L:4589:PHE:CZ	2.33	0.46
1:M:3263:ALA:HB3	1:M:3268:ARG:HE	1.81	0.46
2:N:3679:GLY:O	3:O:5062:GLU:CD	2.42	0.46
3:O:5033:PRO:CB	3:O:5051:ILE:O	2.64	0.46
3:C:33:PRO:CB	3:C:51:ILE:O	2.64	0.45
4:D:653:VAL:H	4:D:658:VAL:HG23	1.81	0.45
3:G:3033:PRO:CB	3:G:3051:ILE:O	2.64	0.45
3:K:4024:ALA:HB1	3:K:4027:TYR:HE1	1.75	0.45
3:K:4097:VAL:CG1	3:K:4104:LEU:HB3	2.46	0.45
4:L:4549:LEU:HA	4:L:4560:VAL:HG21	1.97	0.45
4:L:4643:TYR:HA	4:L:4644:PRO:C	2.36	0.45
2:B:560:GLN:CG	4:D:595:ASN:OD1	2.42	0.45
3:C:32:TYR:CZ	3:C:100:TYR:CZ	2.84	0.45
3:C:97:VAL:CG1	3:C:104:LEU:HB3	2.46	0.45
4:H:3563:ARG:CZ	4:H:3564:PHE:HE2	2.30	0.45
4:H:3653:VAL:H	4:H:3658:VAL:HG23	1.81	0.45
3:K:4011:VAL:CB	3:K:4151:PRO:CB	2.86	0.45
4:L:4513:SER:HG	4:L:4609:LEU:HD22	1.77	0.45
4:L:4563:ARG:CZ	4:L:4564:PHE:HE2	2.30	0.45
4:L:4656:THR:HA	4:L:4657:PRO:HD2	1.62	0.45
1:A:261:SER:O	1:A:270:GLU:N	2.50	0.45
3:C:2:ILE:HD13	3:C:98:ARG:HH11	1.80	0.45
3:C:47:TRP:NE1	3:C:49:GLY:O	2.49	0.45
1:E:1391:TYR:CZ	2:F:1784:LEU:CD1	2.99	0.45
3:G:3021:SER:CB	3:G:3080:TYR:HE2	2.13	0.45

Continued on next page...

Continued from previous page...

Atom-1	Atom-2	Interatomic distance (Å)	Clash overlap (Å)
3:G:3097:VAL:HG22	3:G:3107:TRP:CE3	2.49	0.45
4:H:3557:ARG:CD	4:H:3558:SER:O	2.63	0.45
1:I:2261:SER:O	1:I:2270:GLU:N	2.50	0.45
3:K:4033:PRO:CB	3:K:4051:ILE:O	2.64	0.45
3:O:5097:VAL:HG22	3:O:5107:TRP:CE3	2.49	0.45
2:F:1678:SER:O	4:H:3597:LEU:HD11	2.14	0.45
3:O:5097:VAL:CG1	3:O:5104:LEU:HB3	2.46	0.45
2:B:566:ASP:OD1	2:B:567:ASN:N	2.50	0.45
3:G:3047:TRP:NE1	3:G:3049:GLY:O	2.49	0.45
1:I:2096:CYS:O	1:I:2100:ASN:ND2	2.46	0.45
1:I:2391:TYR:CZ	2:J:2784:LEU:CD1	2.99	0.45
1:M:3261:SER:O	1:M:3270:GLU:N	2.50	0.45
1:M:3391:TYR:CZ	2:N:3784:LEU:CD1	2.99	0.45
4:H:3549:LEU:HA	4:H:3560:VAL:HG21	1.97	0.45
3:O:5021:SER:CB	3:O:5080:TYR:HE2	2.13	0.45
3:O:5045:PHE:HE1	4:P:5589:PHE:CZ	2.33	0.45
3:O:5104:LEU:N	4:P:5536:ASN:OD1	2.43	0.45
3:C:102:ILE:O	4:D:534:CYS:HB3	2.17	0.45
4:D:542:PRO:HB3	4:D:669:LYS:CD	2.42	0.45
3:G:3030:THR:CG2	3:G:3054:ASN:ND2	2.78	0.45
3:G:3045:PHE:HE1	4:H:3589:PHE:CZ	2.33	0.45
3:G:3103:SER:OG	4:H:3551:GLY:HA3	2.17	0.45
3:G:3107:TRP:CB	4:H:3546:PHE:CB	2.95	0.45
1:I:2263:ALA:HB3	1:I:2268:ARG:HE	1.81	0.45
3:O:5103:SER:OG	4:P:5551:GLY:HA3	2.17	0.45
1:A:96:CYS:O	1:A:100:ASN:ND2	2.46	0.45
3:C:47:TRP:CZ2	3:C:49:GLY:HA2	2.52	0.45
1:E:1263:ALA:HB3	1:E:1268:ARG:HE	1.81	0.45
2:F:1566:ASP:OD1	2:F:1567:ASN:N	2.50	0.45
2:F:1678:SER:OG	4:H:3599:VAL:HG22	2.13	0.45
1:I:2301:GLU:O	1:I:2320:ALA:N	2.43	0.45
3:K:4047:TRP:CZ2	3:K:4049:GLY:HA2	2.52	0.45
1:M:3089:TRP:N	2:N:3515:ASP:OD2	2.46	0.45
4:P:5557:ARG:CD	4:P:5558:SER:O	2.63	0.45
1:E:1380:ASP:OD1	1:E:1381:CYS:N	2.50	0.45
3:G:3102:ILE:O	4:H:3534:CYS:HB3	2.17	0.45
1:A:327:GLY:O	1:A:347:LEU:N	2.50	0.45
1:A:391:TYR:CZ	2:B:784:LEU:CD1	2.99	0.45
4:D:523:ARG:NH1	4:D:523:ARG:HG3	2.32	0.45
4:D:557:ARG:HD2	4:D:558:SER:N	2.32	0.45
4:D:557:ARG:CD	4:D:558:SER:O	2.63	0.45

Continued on next page...

Continued from previous page...

Atom-1	Atom-2	Interatomic distance (Å)	Clash overlap (Å)
4:D:563:ARG:CZ	4:D:564:PHE:HE2	2.30	0.45
2:F:1563:ILE:CG2	4:H:3531:SER:OG	2.65	0.45
3:K:4102:ILE:O	4:L:4534:CYS:HB3	2.17	0.45
1:E:1261:SER:O	1:E:1270:GLU:N	2.50	0.44
2:F:1661:ASP:OD1	2:F:1663:SER:OG	2.28	0.44
4:L:4557:ARG:HD2	4:L:4558:SER:N	2.32	0.44
2:N:3559:THR:HG1	4:P:5595:ASN:ND2	2.13	0.44
4:P:5539:GLN:NE2	4:P:5541:LYS:HE3	2.32	0.44
4:P:5643:TYR:HA	4:P:5644:PRO:C	2.36	0.44
4:P:5653:VAL:H	4:P:5658:VAL:HG23	1.81	0.44
4:H:3643:TYR:HA	4:H:3644:PRO:C	2.36	0.44
1:I:2380:ASP:OD1	1:I:2381:CYS:N	2.50	0.44
2:J:2566:ASP:OD1	2:J:2567:ASN:N	2.50	0.44
3:O:5107:TRP:CB	4:P:5546:PHE:CB	2.95	0.44
1:A:197:LYS:O	1:A:200:SER:OG	2.18	0.44
2:B:571:ARG:HG3	2:B:597:THR:OG1	2.18	0.44
3:C:12:LYS:O	3:C:115:VAL:HA	2.17	0.44
3:C:103:SER:OG	4:D:551:GLY:HA3	2.17	0.44
4:D:539:GLN:NE2	4:D:541:LYS:HE3	2.33	0.44
1:E:1327:GLY:O	1:E:1347:LEU:N	2.50	0.44
4:H:3542:PRO:HB3	4:H:3669:LYS:CD	2.42	0.44
3:K:4103:SER:OG	4:L:4551:GLY:HA3	2.17	0.44
3:C:72:LEU:HD13	3:C:74:ILE:CG1	2.46	0.44
4:D:683:LEU:HD22	4:D:687:ALA:CB	2.48	0.44
3:G:3012:LYS:O	3:G:3115:VAL:HA	2.17	0.44
4:H:3556:ARG:HD3	4:H:3560:VAL:HG12	2.00	0.44
3:K:4107:TRP:CB	4:L:4546:PHE:CB	2.95	0.44
4:L:4523:ARG:HG3	4:L:4523:ARG:NH1	2.32	0.44
2:N:3566:ASP:OD1	2:N:3567:ASN:N	2.50	0.44
3:O:5047:TRP:CZ2	3:O:5049:GLY:HA2	2.52	0.44
1:A:263:ALA:HB3	1:A:268:ARG:HE	1.81	0.44
3:C:100:TYR:CD2	3:C:101:PHE:CE2	3.06	0.44
2:F:1677:PRO:C	4:H:3502:ALA:N	2.55	0.44
3:G:3047:TRP:CZ2	3:G:3049:GLY:HA2	2.52	0.44
4:H:3523:ARG:HG3	4:H:3523:ARG:NH1	2.32	0.44
4:L:4557:ARG:CD	4:L:4558:SER:O	2.63	0.44
3:O:5012:LYS:O	3:O:5115:VAL:HA	2.17	0.44
3:C:39:GLN:CD	3:C:45:PHE:CE1	2.87	0.44
3:C:104:LEU:N	4:D:536:ASN:OD1	2.43	0.44
3:C:123:PRO:HB3	3:C:149:TYR:HB3	2.00	0.44
1:E:1312:ASP:O	1:E:1314:GLY:N	2.50	0.44

Continued on next page...

Continued from previous page...

Atom-1	Atom-2	Interatomic distance (Å)	Clash overlap (Å)
4:H:3557:ARG:HD2	4:H:3558:SER:N	2.33	0.44
4:H:3683:LEU:HD22	4:H:3687:ALA:CB	2.48	0.44
3:O:5102:ILE:O	4:P:5534:CYS:HB3	2.17	0.44
4:P:5563:ARG:CZ	4:P:5564:PHE:HE2	2.30	0.44
2:B:543:LYS:HD3	3:C:102:ILE:HD11	2.00	0.44
4:D:556:ARG:HD3	4:D:560:VAL:HG12	2.00	0.44
2:F:1718:LYS:CG	4:H:3595:ASN:O	2.62	0.44
2:F:1780:THR:OG1	2:F:1791:THR:O	2.30	0.44
3:G:3072:LEU:HD13	3:G:3074:ILE:CG1	2.46	0.44
3:G:3100:TYR:CD2	3:G:3101:PHE:CE2	3.06	0.44
4:H:3669:LYS:HE2	4:H:3669:LYS:HB3	1.73	0.44
2:J:2571:ARG:HG3	2:J:2597:THR:OG1	2.17	0.44
4:L:4689:GLU:O	4:L:4689:GLU:HG3	2.18	0.44
4:P:5597:LEU:C	4:P:5597:LEU:HD12	2.38	0.44
2:F:1571:ARG:HG3	2:F:1597:THR:OG1	2.18	0.44
4:L:4597:LEU:C	4:L:4597:LEU:HD12	2.38	0.44
2:N:3675:THR:OG1	4:P:5501:GLN:HA	2.18	0.44
4:P:5689:GLU:O	4:P:5689:GLU:HG3	2.18	0.44
1:A:380:ASP:OD1	1:A:381:CYS:N	2.50	0.44
2:B:680:ALA:O	3:C:62:GLU:HG2	2.13	0.44
3:C:30:THR:CG2	3:C:54:ASN:ND2	2.78	0.44
3:C:107:TRP:CB	4:D:546:PHE:CB	2.95	0.44
1:M:3380:ASP:OD1	1:M:3381:CYS:N	2.50	0.44
3:C:97:VAL:HG22	3:C:107:TRP:CE3	2.49	0.43
4:D:520:LEU:N	4:D:520:LEU:CD2	2.70	0.43
2:F:1678:SER:C	4:H:3501:GLN:N	2.66	0.43
4:H:3514:PRO:HG2	4:H:3609:LEU:O	2.03	0.43
3:K:4072:LEU:HD13	3:K:4074:ILE:CG1	2.46	0.43
3:O:5030:THR:CG2	3:O:5054:ASN:ND2	2.78	0.43
4:H:3539:GLN:NE2	4:H:3541:LYS:HE3	2.32	0.43
1:I:2152:GLU:OE1	1:I:2152:GLU:N	2.52	0.43
4:L:4628:LEU:HD23	4:L:4628:LEU:HA	1.89	0.43
3:O:5072:LEU:HD13	3:O:5074:ILE:CG1	2.46	0.43
3:O:5102:ILE:HB	4:P:5552:ASP:CA	2.40	0.43
4:P:5556:ARG:HD3	4:P:5560:VAL:HG12	2.00	0.43
3:C:11:VAL:CB	3:C:151:PRO:CB	2.86	0.43
4:H:3582:THR:HG1	4:H:3610:GLY:HA3	1.80	0.43
1:I:2312:ASP:O	1:I:2314:GLY:N	2.51	0.43
2:J:2679:GLY:C	3:K:4062:GLU:HB3	2.39	0.43
3:K:4011:VAL:CG2	3:K:4152:GLU:N	2.70	0.43
1:M:3327:GLY:O	1:M:3347:LEU:N	2.50	0.43

Continued on next page...

Continued from previous page...

Atom-1	Atom-2	Interatomic distance (Å)	Clash overlap (Å)
4:P:5683:LEU:HD22	4:P:5687:ALA:CB	2.48	0.43
1:A:312:ASP:O	1:A:314:GLY:N	2.51	0.43
2:B:718:LYS:CG	4:D:596:ASN:HB2	1.89	0.43
3:K:4100:TYR:CD2	3:K:4101:PHE:CE2	3.06	0.43
1:M:3007:MET:O	1:M:3277:ILE:N	2.48	0.43
2:N:3571:ARG:HG3	2:N:3597:THR:OG1	2.18	0.43
2:N:3664:LEU:HD23	4:P:5501:GLN:HB3	2.00	0.43
3:O:5032:TYR:CZ	3:O:5100:TYR:CG	2.96	0.43
3:O:5100:TYR:CD2	3:O:5101:PHE:CE2	3.06	0.43
4:P:5557:ARG:HD2	4:P:5558:SER:N	2.32	0.43
4:D:597:LEU:C	4:D:597:LEU:HD12	2.38	0.43
3:K:4012:LYS:O	3:K:4115:VAL:HA	2.17	0.43
3:K:4078:THR:HB	3:K:4080:TYR:CE1	2.54	0.43
3:K:4123:PRO:HB3	3:K:4149:TYR:HB3	2.00	0.43
1:M:3152:GLU:N	1:M:3152:GLU:OE1	2.52	0.43
3:O:5039:GLN:CD	3:O:5045:PHE:CE1	2.86	0.43
3:O:5040:ALA:CA	3:O:5041:PRO:CD	2.96	0.43
4:L:4539:GLN:NE2	4:L:4541:LYS:HE3	2.32	0.43
4:P:5683:LEU:CD1	4:P:5694:TYR:CE2	3.02	0.43
2:F:1718:LYS:HZ3	4:H:3595:ASN:HB2	1.50	0.43
4:H:3689:GLU:O	4:H:3689:GLU:HG3	2.18	0.43
4:P:5523:ARG:HG3	4:P:5523:ARG:NH1	2.32	0.43
1:A:152:GLU:OE1	1:A:152:GLU:N	2.52	0.43
3:G:3068:PHE:CD1	3:G:3083:ILE:HG12	2.54	0.43
4:H:3623:PRO:CG	4:H:3633:ALA:HB1	2.49	0.43
4:H:3656:THR:HA	4:H:3657:PRO:HD2	1.62	0.43
4:H:3686:ARG:H	4:H:3686:ARG:HG2	1.64	0.43
4:L:4639:ILE:HG22	4:L:4642:PHE:CD2	2.54	0.43
4:L:4683:LEU:HD22	4:L:4687:ALA:CB	2.48	0.43
1:M:3312:ASP:O	1:M:3314:GLY:N	2.51	0.43
2:N:3664:LEU:HD23	4:P:5501:GLN:CB	2.48	0.43
1:A:7:MET:O	1:A:277:ILE:N	2.48	0.43
4:D:623:PRO:CG	4:D:633:ALA:HB1	2.49	0.43
2:F:1678:SER:CA	4:H:3501:GLN:N	2.82	0.43
3:K:4032:TYR:CZ	3:K:4100:TYR:CG	2.96	0.43
4:L:4556:ARG:HD3	4:L:4560:VAL:HG12	2.00	0.43
4:L:4561:PRO:CG	4:L:4563:ARG:NH1	2.82	0.43
3:O:5078:THR:HB	3:O:5080:TYR:CE1	2.54	0.43
4:P:5526:ILE:HG22	4:P:5526:ILE:O	2.19	0.43
4:P:5623:PRO:CG	4:P:5633:ALA:HB1	2.49	0.43
2:B:666:SER:N	2:B:673:LYS:O	2.52	0.43

Continued on next page...

Continued from previous page...

Atom-1	Atom-2	Interatomic distance (Å)	Clash overlap (Å)
3:C:32:TYR:CZ	3:C:100:TYR:CG	2.96	0.43
3:C:37:VAL:HB	3:C:107:TRP:HZ3	1.84	0.43
4:D:561:PRO:CG	4:D:563:ARG:NH1	2.82	0.43
4:H:3639:ILE:HG22	4:H:3642:PHE:CD2	2.54	0.43
1:M:3102:GLN:NE2	1:M:3104:SER:OG	2.47	0.43
3:O:5123:PRO:HB3	3:O:5149:TYR:HB3	2.00	0.43
3:C:4:LEU:HD23	3:C:24:ALA:HA	2.01	0.42
3:C:78:THR:HB	3:C:80:TYR:CE1	2.54	0.42
4:D:656:THR:HA	4:D:657:PRO:HD2	1.62	0.42
4:H:3597:LEU:HD12	4:H:3597:LEU:C	2.38	0.42
4:L:4540:GLU:HB2	4:L:4546:PHE:CE1	2.54	0.42
3:O:5068:PHE:CD1	3:O:5083:ILE:HG12	2.54	0.42
4:D:689:GLU:O	4:D:689:GLU:HG3	2.18	0.42
3:G:3078:THR:HB	3:G:3080:TYR:CE1	2.54	0.42
3:K:4018:VAL:HG11	3:K:4113:LEU:HD13	2.02	0.42
3:O:5018:VAL:HG11	3:O:5113:LEU:HD13	2.02	0.42
3:O:5078:THR:CG2	3:O:5080:TYR:OH	2.48	0.42
4:P:5639:ILE:HG22	4:P:5642:PHE:CD2	2.54	0.42
4:D:526:ILE:O	4:D:526:ILE:HG22	2.19	0.42
2:F:1678:SER:C	4:H:3597:LEU:HD21	2.40	0.42
3:K:4004:LEU:HD23	3:K:4024:ALA:HA	2.02	0.42
4:L:4623:PRO:CG	4:L:4633:ALA:HB1	2.49	0.42
3:O:5037:VAL:HB	3:O:5107:TRP:HZ3	1.84	0.42
3:G:3037:VAL:HB	3:G:3107:TRP:HZ3	1.84	0.42
3:G:3123:PRO:HB3	3:G:3149:TYR:HB3	2.00	0.42
4:H:3540:GLU:HB2	4:H:3546:PHE:CE1	2.54	0.42
3:K:4107:TRP:HB2	4:L:4546:PHE:HB2	2.01	0.42
2:N:3666:SER:N	2:N:3673:LYS:O	2.52	0.42
3:O:5040:ALA:HA	3:O:5041:PRO:CD	2.49	0.42
3:O:5175:GLN:CG	4:P:5663:GLU:OE2	2.60	0.42
3:C:18:VAL:HG11	3:C:113:LEU:HD13	2.02	0.42
3:G:3004:LEU:HD23	3:G:3024:ALA:HA	2.01	0.42
3:K:4068:PHE:CD1	3:K:4083:ILE:HG12	2.54	0.42
2:N:3678:SER:HB2	4:P:5597:LEU:HD13	1.99	0.42
4:P:5540:GLU:HB2	4:P:5546:PHE:CE1	2.54	0.42
3:C:68:PHE:CD1	3:C:83:ILE:HG12	2.54	0.42
3:C:88:ASN:O	3:C:91:THR:HG23	2.19	0.42
4:H:3526:ILE:O	4:H:3526:ILE:HG22	2.19	0.42
3:K:4037:VAL:HB	3:K:4107:TRP:HZ3	1.84	0.42
2:N:3505:ASP:OD2	2:N:3513:ARG:NH2	2.53	0.42
3:C:39:GLN:OE1	3:C:45:PHE:CZ	2.72	0.42

Continued on next page...

Continued from previous page...

Atom-1	Atom-2	Interatomic distance (Å)	Clash overlap (Å)
3:C:67:ARG:NH1	3:C:90:ASP:OD2	2.52	0.42
4:D:540:GLU:HB2	4:D:546:PHE:CE1	2.54	0.42
4:D:639:ILE:HG22	4:D:642:PHE:CD2	2.54	0.42
1:E:1152:GLU:OE1	1:E:1152:GLU:N	2.51	0.42
2:F:1630:GLU:HB2	2:N:3507:PRO:CB	2.49	0.42
2:F:1666:SER:N	2:F:1673:LYS:O	2.52	0.42
3:G:3002:ILE:HD13	3:G:3098:ARG:HH11	1.81	0.42
3:G:3032:TYR:CE1	3:G:3100:TYR:HD1	1.97	0.42
2:J:2558:LYS:CE	4:L:4501:GLN:CB	2.86	0.42
3:K:4088:ASN:O	3:K:4091:THR:HG23	2.19	0.42
3:C:11:VAL:CG2	3:C:152:GLU:O	2.68	0.42
3:C:107:TRP:HB2	4:D:546:PHE:HB2	2.01	0.42
4:D:504:VAL:HG13	4:D:522:CYS:SG	2.60	0.42
3:G:3039:GLN:OE1	3:G:3045:PHE:CZ	2.72	0.42
4:L:4526:ILE:O	4:L:4526:ILE:HG22	2.19	0.42
1:M:3075:ASP:HB2	1:M:3216:ALA:HB3	2.02	0.42
2:N:3676:VAL:C	4:P:5501:GLN:CG	2.62	0.42
3:O:5011:VAL:CG2	3:O:5152:GLU:O	2.68	0.42
3:O:5088:ASN:O	3:O:5091:THR:HG23	2.19	0.42
3:C:11:VAL:CG2	3:C:152:GLU:N	2.70	0.42
2:F:1558:LYS:NZ	4:H:3526:ILE:CB	2.78	0.42
4:H:3583:GLU:HG2	4:H:3583:GLU:H	1.59	0.42
1:I:2075:ASP:HB2	1:I:2216:ALA:HB3	2.02	0.42
2:J:2666:SER:N	2:J:2673:LYS:O	2.52	0.42
3:K:4039:GLN:OE1	3:K:4045:PHE:CZ	2.72	0.42
1:M:3038:ILE:HG23	1:M:3129:VAL:HG12	2.02	0.42
4:P:5542:PRO:CB	4:P:5669:LYS:CD	2.95	0.42
1:A:75:ASP:HB2	1:A:216:ALA:HB3	2.02	0.42
3:G:3032:TYR:CZ	3:G:3100:TYR:CG	2.96	0.42
4:L:4683:LEU:CD1	4:L:4694:TYR:CE2	3.01	0.42
3:C:35:LEU:HD23	3:C:35:LEU:C	2.40	0.41
4:D:593:TRP:CZ3	4:D:597:LEU:CA	3.03	0.41
4:H:3561:PRO:CG	4:H:3563:ARG:NH1	2.82	0.41
3:K:4035:LEU:HD23	3:K:4035:LEU:C	2.40	0.41
3:K:4175:GLN:CG	4:L:4663:GLU:OE2	2.60	0.41
3:O:5011:VAL:CG2	3:O:5152:GLU:N	2.70	0.41
3:O:5107:TRP:CG	4:P:5546:PHE:HB3	2.55	0.41
4:P:5556:ARG:HD3	4:P:5560:VAL:O	2.20	0.41
3:C:21:SER:CB	3:C:80:TYR:HE2	2.13	0.41
3:C:107:TRP:CG	4:D:546:PHE:HB3	2.55	0.41
3:C:175:GLN:CG	4:D:663:GLU:OE2	2.60	0.41

Continued on next page...

Continued from previous page...

Atom-1	Atom-2	Interatomic distance (Å)	Clash overlap (Å)
1:E:1075:ASP:HB2	1:E:1216:ALA:HB3	2.02	0.41
2:F:1507:PRO:CB	2:J:2630:GLU:HB2	2.49	0.41
4:H:3504:VAL:HG13	4:H:3522:CYS:SG	2.60	0.41
3:O:5039:GLN:OE1	3:O:5045:PHE:CZ	2.72	0.41
3:O:5107:TRP:HB2	4:P:5546:PHE:HB2	2.01	0.41
4:P:5593:TRP:CZ3	4:P:5597:LEU:CA	3.03	0.41
4:D:556:ARG:HD3	4:D:560:VAL:O	2.20	0.41
2:F:1505:ASP:OD2	2:F:1513:ARG:NH2	2.53	0.41
3:G:3107:TRP:HB2	4:H:3546:PHE:HB2	2.01	0.41
3:G:3107:TRP:CG	4:H:3546:PHE:HB3	2.55	0.41
1:I:2038:ILE:HG23	1:I:2129:VAL:HG12	2.02	0.41
2:J:2505:ASP:OD2	2:J:2513:ARG:NH2	2.53	0.41
3:K:4107:TRP:CG	4:L:4546:PHE:HB3	2.55	0.41
4:L:4689:GLU:CA	4:L:4711:ARG:HH21	2.33	0.41
2:B:505:ASP:OD2	2:B:513:ARG:NH2	2.53	0.41
1:E:1391:TYR:CE2	2:F:1784:LEU:CD1	3.04	0.41
3:G:3088:ASN:O	3:G:3091:THR:HG23	2.19	0.41
2:J:2637:CYS:SG	2:J:2750:CYS:N	2.93	0.41
4:L:4556:ARG:HD3	4:L:4560:VAL:O	2.20	0.41
1:M:3391:TYR:CE2	2:N:3784:LEU:CD1	3.04	0.41
3:O:5004:LEU:HD23	3:O:5024:ALA:HA	2.01	0.41
3:O:5035:LEU:HD23	3:O:5035:LEU:C	2.40	0.41
3:O:5067:ARG:NH1	3:O:5090:ASP:OD2	2.52	0.41
1:E:1134:ASN:OD1	1:E:1135:ILE:N	2.54	0.41
3:G:3035:LEU:HD23	3:G:3035:LEU:C	2.40	0.41
4:H:3507:GLU:O	4:H:3604:THR:OG1	2.27	0.41
4:H:3521:THR:HG21	4:H:3572:LYS:HE2	2.03	0.41
1:I:2293:GLU:OE1	1:I:2293:GLU:N	2.54	0.41
3:K:4067:ARG:NH1	3:K:4090:ASP:OD2	2.52	0.41
3:K:4119:LYS:O	3:K:4150:PHE:HD2	2.04	0.41
4:P:5549:LEU:HD12	4:P:5549:LEU:HA	1.85	0.41
1:A:134:ASN:OD1	1:A:135:ILE:N	2.54	0.41
3:C:119:LYS:O	3:C:150:PHE:HD2	2.04	0.41
1:E:1007:MET:O	1:E:1277:ILE:N	2.48	0.41
1:E:1293:GLU:OE1	1:E:1293:GLU:N	2.54	0.41
2:F:1637:CYS:SG	2:F:1750:CYS:N	2.93	0.41
4:H:3556:ARG:HD3	4:H:3560:VAL:O	2.20	0.41
4:P:5504:VAL:HG13	4:P:5522:CYS:SG	2.60	0.41
4:P:5628:LEU:HD23	4:P:5628:LEU:HA	1.89	0.41
1:A:293:GLU:N	1:A:293:GLU:OE1	2.54	0.41
1:A:391:TYR:CE2	2:B:784:LEU:CD1	3.04	0.41

Continued on next page...

Continued from previous page...

Atom-1	Atom-2	Interatomic distance (Å)	Clash overlap (Å)
4:D:561:PRO:HG2	4:D:563:ARG:HH12	1.85	0.41
3:G:3104:LEU:N	4:H:3536:ASN:OD1	2.43	0.41
2:J:2676:VAL:CG2	4:L:4501:GLN:NE2	2.78	0.41
4:L:4561:PRO:HG2	4:L:4563:ARG:HH12	1.85	0.41
4:L:4593:TRP:CZ3	4:L:4597:LEU:CA	3.03	0.41
4:P:5521:THR:HG21	4:P:5572:LYS:HE2	2.03	0.41
2:B:675:THR:HG23	4:D:501:GLN:OE1	2.20	0.41
3:C:78:THR:CB	3:C:80:TYR:CE1	3.04	0.41
2:F:1556:ASN:O	2:F:1559:THR:OG1	2.30	0.41
3:G:3011:VAL:CG2	3:G:3152:GLU:O	2.68	0.41
3:G:3067:ARG:HH22	3:G:3090:ASP:CG	2.24	0.41
4:H:3628:LEU:HD23	4:H:3628:LEU:HA	1.89	0.41
3:K:4011:VAL:HB	3:K:4151:PRO:CB	2.51	0.41
4:L:4689:GLU:CA	4:L:4711:ARG:NH2	2.83	0.41
3:O:5100:TYR:HE2	3:O:5101:PHE:CZ	2.38	0.41
4:P:5609:LEU:HD12	4:P:5609:LEU:HA	1.87	0.41
4:P:5689:GLU:CA	4:P:5711:ARG:NH2	2.83	0.41
2:B:502:TYR:HE2	2:B:504:ALA:HB2	1.86	0.41
2:B:559:THR:HG21	4:D:594:TYR:CD1	2.51	0.41
3:G:3018:VAL:HG11	3:G:3113:LEU:HD13	2.02	0.41
3:G:3119:LYS:O	3:G:3150:PHE:HD2	2.04	0.41
4:H:3549:LEU:HD12	4:H:3549:LEU:HA	1.85	0.41
4:H:3689:GLU:CA	4:H:3711:ARG:NH2	2.83	0.41
1:I:2134:ASN:OD1	1:I:2135:ILE:N	2.54	0.41
1:I:2391:TYR:CE2	2:J:2784:LEU:CD1	3.04	0.41
3:K:4011:VAL:CG2	3:K:4152:GLU:O	2.68	0.41
3:K:4067:ARG:NH2	3:K:4090:ASP:OD2	2.52	0.41
4:L:4521:THR:HG21	4:L:4572:LYS:HE2	2.03	0.41
1:M:3134:ASN:OD1	1:M:3135:ILE:N	2.54	0.41
2:N:3502:TYR:HE2	2:N:3504:ALA:HB2	1.86	0.41
1:A:102:GLN:NE2	1:A:104:SER:OG	2.47	0.41
3:C:97:VAL:HG11	3:C:104:LEU:HB3	2.03	0.41
1:E:1265:GLU:O	1:E:1267:LEU:N	2.54	0.41
3:G:3091:THR:O	3:G:3092:ALA:HB2	2.21	0.41
3:G:3175:GLN:CG	4:H:3663:GLU:OE2	2.60	0.41
4:H:3593:TRP:CZ3	4:H:3597:LEU:CA	3.03	0.41
4:H:3689:GLU:OE2	4:H:3711:ARG:NH2	2.54	0.41
3:K:4078:THR:CB	3:K:4080:TYR:CE1	3.04	0.41
4:P:5561:PRO:HG2	4:P:5563:ARG:HH12	1.85	0.41
3:C:67:ARG:HH22	3:C:90:ASP:CG	2.24	0.40
4:D:689:GLU:CA	4:D:711:ARG:NH2	2.83	0.40

Continued on next page...

Continued from previous page...

Atom-1	Atom-2	Interatomic distance (Å)	Clash overlap (Å)
3:G:3032:TYR:CE1	3:G:3100:TYR:HB2	2.56	0.40
3:G:3097:VAL:HG11	3:G:3104:LEU:HB3	2.04	0.40
3:G:3170:PHE:HE1	4:H:3676:MET:HB2	1.87	0.40
2:J:2502:TYR:HE2	2:J:2504:ALA:HB2	1.86	0.40
1:M:3265:GLU:O	1:M:3267:LEU:N	2.54	0.40
2:N:3558:LYS:HG3	4:P:5595:ASN:HB2	2.03	0.40
1:A:38:ILE:HG23	1:A:129:VAL:HG12	2.02	0.40
3:C:32:TYR:CE1	3:C:100:TYR:HB2	2.56	0.40
4:H:3689:GLU:CA	4:H:3711:ARG:HH21	2.33	0.40
3:K:4032:TYR:CE1	3:K:4100:TYR:HB2	2.56	0.40
3:K:4057:GLU:HA	3:K:4058:PRO:CD	2.51	0.40
3:O:5119:LYS:O	3:O:5150:PHE:HD2	2.04	0.40
4:P:5587:ILE:HG12	4:P:5605:LYS:HG3	2.02	0.40
4:D:669:LYS:HB3	4:D:669:LYS:HE2	1.73	0.40
1:E:1038:ILE:HG23	1:E:1129:VAL:HG12	2.02	0.40
4:H:3587:ILE:HG12	4:H:3605:LYS:HG3	2.02	0.40
1:I:2265:GLU:O	1:I:2267:LEU:N	2.54	0.40
3:K:4100:TYR:HE2	3:K:4101:PHE:CZ	2.38	0.40
3:K:4170:PHE:HE1	4:L:4676:MET:HB2	1.87	0.40
1:M:3293:GLU:OE1	1:M:3293:GLU:N	2.54	0.40
3:O:5057:GLU:HA	3:O:5058:PRO:CD	2.51	0.40
4:P:5689:GLU:CA	4:P:5711:ARG:HH21	2.33	0.40
1:A:265:GLU:O	1:A:267:LEU:N	2.54	0.40
3:C:57:GLU:HA	3:C:58:PRO:CD	2.52	0.40
3:G:3057:GLU:HA	3:G:3058:PRO:CD	2.52	0.40
3:K:4175:GLN:NE2	4:L:4663:GLU:HG3	2.37	0.40
3:O:5078:THR:CB	3:O:5080:TYR:CE1	3.04	0.40
3:O:5097:VAL:HG11	3:O:5104:LEU:HB3	2.03	0.40
3:C:35:LEU:HG	3:C:47:TRP:HE1	1.87	0.40
4:D:549:LEU:HD12	4:D:549:LEU:HA	1.85	0.40
4:D:583:GLU:HG2	4:D:583:GLU:H	1.59	0.40
4:D:683:LEU:CD1	4:D:694:TYR:CE2	3.02	0.40
4:D:689:GLU:OE2	4:D:711:ARG:NH2	2.54	0.40
1:I:2327:GLY:O	1:I:2347:LEU:N	2.50	0.40
4:L:4587:ILE:HG12	4:L:4605:LYS:HG3	2.02	0.40
3:O:5048:MET:HE3	3:O:5048:MET:HB3	1.94	0.40
3:O:5048:MET:HE1	3:O:5081:LEU:HD21	2.04	0.40
4:P:5561:PRO:CG	4:P:5563:ARG:NH1	2.82	0.40

There are no symmetry-related clashes.

5.3 Torsion angles [i](#)

5.3.1 Protein backbone [i](#)

In the following table, the Percentiles column shows the percent Ramachandran outliers of the chain as a percentile score with respect to all PDB entries followed by that with respect to all EM entries.

The Analysed column shows the number of residues for which the backbone conformation was analysed, and the total number of residues.

Mol	Chain	Analysed	Favoured	Allowed	Outliers	Percentiles	
1	A	398/441 (90%)	322 (81%)	72 (18%)	4 (1%)	15	55
1	E	398/441 (90%)	322 (81%)	72 (18%)	4 (1%)	15	55
1	I	398/441 (90%)	322 (81%)	72 (18%)	4 (1%)	15	55
1	M	398/441 (90%)	322 (81%)	72 (18%)	4 (1%)	15	55
2	B	323/477 (68%)	258 (80%)	65 (20%)	0	100	100
2	F	323/477 (68%)	259 (80%)	64 (20%)	0	100	100
2	J	323/477 (68%)	259 (80%)	64 (20%)	0	100	100
2	N	323/477 (68%)	259 (80%)	64 (20%)	0	100	100
3	C	216/218 (99%)	196 (91%)	15 (7%)	5 (2%)	6	34
3	G	216/218 (99%)	196 (91%)	15 (7%)	5 (2%)	6	34
3	K	216/218 (99%)	196 (91%)	15 (7%)	5 (2%)	6	34
3	O	216/218 (99%)	196 (91%)	15 (7%)	5 (2%)	6	34
4	D	209/214 (98%)	187 (90%)	20 (10%)	2 (1%)	15	55
4	H	209/214 (98%)	188 (90%)	19 (9%)	2 (1%)	15	55
4	L	209/214 (98%)	187 (90%)	20 (10%)	2 (1%)	15	55
4	P	209/214 (98%)	188 (90%)	19 (9%)	2 (1%)	15	55
All	All	4584/5400 (85%)	3857 (84%)	683 (15%)	44 (1%)	20	55

All (44) Ramachandran outliers are listed below:

Mol	Chain	Res	Type
1	A	390	ASP
3	C	43	LYS
4	D	543	ASP
1	E	1390	ASP
3	G	3043	LYS
4	H	3543	ASP

Continued on next page...

Continued from previous page...

Mol	Chain	Res	Type
1	I	2390	ASP
3	K	4043	LYS
4	L	4543	ASP
1	M	3390	ASP
3	O	5043	LYS
4	P	5543	ASP
3	C	103	SER
3	G	3103	SER
3	K	4103	SER
3	O	5103	SER
3	C	41	PRO
4	D	701	GLU
3	G	3041	PRO
4	H	3701	GLU
3	K	4041	PRO
4	L	4701	GLU
3	O	5041	PRO
4	P	5701	GLU
1	A	265	GLU
1	A	266	PRO
3	C	118	ALA
1	E	1265	GLU
1	E	1266	PRO
3	G	3118	ALA
1	I	2265	GLU
1	I	2266	PRO
3	K	4118	ALA
1	M	3265	GLU
1	M	3266	PRO
3	O	5118	ALA
3	C	119	LYS
3	G	3119	LYS
3	K	4119	LYS
3	O	5119	LYS
1	A	191	PRO
1	E	1191	PRO
1	I	2191	PRO
1	M	3191	PRO

5.3.2 Protein sidechains [i](#)

In the following table, the Percentiles column shows the percent sidechain outliers of the chain as a percentile score with respect to all PDB entries followed by that with respect to all EM entries.

The Analysed column shows the number of residues for which the sidechain conformation was analysed, and the total number of residues.

Mol	Chain	Analysed	Rotameric	Outliers	Percentiles	
1	A	339/370 (92%)	334 (98%)	5 (2%)	65	80
1	E	339/370 (92%)	334 (98%)	5 (2%)	65	80
1	I	339/370 (92%)	334 (98%)	5 (2%)	65	80
1	M	339/370 (92%)	334 (98%)	5 (2%)	65	80
2	B	282/414 (68%)	279 (99%)	3 (1%)	73	84
2	F	282/414 (68%)	279 (99%)	3 (1%)	73	84
2	J	282/414 (68%)	279 (99%)	3 (1%)	73	84
2	N	282/414 (68%)	279 (99%)	3 (1%)	73	84
3	C	188/188 (100%)	178 (95%)	10 (5%)	22	47
3	G	188/188 (100%)	178 (95%)	10 (5%)	22	47
3	K	188/188 (100%)	178 (95%)	10 (5%)	22	47
3	O	188/188 (100%)	178 (95%)	10 (5%)	22	47
4	D	178/183 (97%)	149 (84%)	29 (16%)	2	13
4	H	178/183 (97%)	149 (84%)	29 (16%)	2	13
4	L	178/183 (97%)	149 (84%)	29 (16%)	2	13
4	P	178/183 (97%)	149 (84%)	29 (16%)	2	13
All	All	3948/4620 (86%)	3760 (95%)	188 (5%)	29	51

All (188) residues with a non-rotameric sidechain are listed below:

Mol	Chain	Res	Type
1	A	21	ARG
1	A	143	ARG
1	A	217	ASN
1	A	246	ARG
1	A	268	ARG
2	B	533	ARG
2	B	556	ASN
2	B	618	ARG

Continued on next page...

Continued from previous page...

Mol	Chain	Res	Type
3	C	1	GLN
3	C	5	VAL
3	C	7	SER
3	C	28	THR
3	C	41	PRO
3	C	43	LYS
3	C	51	ILE
3	C	62	GLU
3	C	63	GLU
3	C	72	LEU
4	D	520	LEU
4	D	536	ASN
4	D	549	LEU
4	D	554	ASN
4	D	571	ASP
4	D	575	LEU
4	D	581	GLN
4	D	582	THR
4	D	583	GLU
4	D	605	LYS
4	D	609	LEU
4	D	620	LEU
4	D	626	GLU
4	D	629	GLU
4	D	630	THR
4	D	632	LYS
4	D	635	LEU
4	D	660	GLN
4	D	662	MET
4	D	666	GLN
4	D	670	GLN
4	D	671	SER
4	D	673	ASN
4	D	681	LEU
4	D	684	THR
4	D	686	ARG
4	D	689	GLU
4	D	705	VAL
4	D	709	LEU
1	E	1021	ARG
1	E	1143	ARG
1	E	1217	ASN

Continued on next page...

Continued from previous page...

Mol	Chain	Res	Type
1	E	1246	ARG
1	E	1268	ARG
2	F	1533	ARG
2	F	1556	ASN
2	F	1618	ARG
3	G	3001	GLN
3	G	3005	VAL
3	G	3007	SER
3	G	3028	THR
3	G	3041	PRO
3	G	3043	LYS
3	G	3051	ILE
3	G	3062	GLU
3	G	3063	GLU
3	G	3072	LEU
4	H	3520	LEU
4	H	3536	ASN
4	H	3549	LEU
4	H	3554	ASN
4	H	3571	ASP
4	H	3575	LEU
4	H	3581	GLN
4	H	3582	THR
4	H	3583	GLU
4	H	3605	LYS
4	H	3609	LEU
4	H	3620	LEU
4	H	3626	GLU
4	H	3629	GLU
4	H	3630	THR
4	H	3632	LYS
4	H	3635	LEU
4	H	3660	GLN
4	H	3662	MET
4	H	3666	GLN
4	H	3670	GLN
4	H	3671	SER
4	H	3673	ASN
4	H	3681	LEU
4	H	3684	THR
4	H	3686	ARG
4	H	3689	GLU

Continued on next page...

Continued from previous page...

Mol	Chain	Res	Type
4	H	3705	VAL
4	H	3709	LEU
1	I	2021	ARG
1	I	2143	ARG
1	I	2217	ASN
1	I	2246	ARG
1	I	2268	ARG
2	J	2533	ARG
2	J	2556	ASN
2	J	2618	ARG
3	K	4001	GLN
3	K	4005	VAL
3	K	4007	SER
3	K	4028	THR
3	K	4041	PRO
3	K	4043	LYS
3	K	4051	ILE
3	K	4062	GLU
3	K	4063	GLU
3	K	4072	LEU
4	L	4520	LEU
4	L	4536	ASN
4	L	4549	LEU
4	L	4554	ASN
4	L	4571	ASP
4	L	4575	LEU
4	L	4581	GLN
4	L	4582	THR
4	L	4583	GLU
4	L	4605	LYS
4	L	4609	LEU
4	L	4620	LEU
4	L	4626	GLU
4	L	4629	GLU
4	L	4630	THR
4	L	4632	LYS
4	L	4635	LEU
4	L	4660	GLN
4	L	4662	MET
4	L	4666	GLN
4	L	4670	GLN
4	L	4671	SER

Continued on next page...

Continued from previous page...

Mol	Chain	Res	Type
4	L	4673	ASN
4	L	4681	LEU
4	L	4684	THR
4	L	4686	ARG
4	L	4689	GLU
4	L	4705	VAL
4	L	4709	LEU
1	M	3021	ARG
1	M	3143	ARG
1	M	3217	ASN
1	M	3246	ARG
1	M	3268	ARG
2	N	3533	ARG
2	N	3556	ASN
2	N	3618	ARG
3	O	5001	GLN
3	O	5005	VAL
3	O	5007	SER
3	O	5028	THR
3	O	5041	PRO
3	O	5043	LYS
3	O	5051	ILE
3	O	5062	GLU
3	O	5063	GLU
3	O	5072	LEU
4	P	5520	LEU
4	P	5536	ASN
4	P	5549	LEU
4	P	5554	ASN
4	P	5571	ASP
4	P	5575	LEU
4	P	5581	GLN
4	P	5582	THR
4	P	5583	GLU
4	P	5605	LYS
4	P	5609	LEU
4	P	5620	LEU
4	P	5626	GLU
4	P	5629	GLU
4	P	5630	THR
4	P	5632	LYS
4	P	5635	LEU

Continued on next page...

Continued from previous page...

Mol	Chain	Res	Type
4	P	5660	GLN
4	P	5662	MET
4	P	5666	GLN
4	P	5670	GLN
4	P	5671	SER
4	P	5673	ASN
4	P	5681	LEU
4	P	5684	THR
4	P	5686	ARG
4	P	5689	GLU
4	P	5705	VAL
4	P	5709	LEU

Sometimes sidechains can be flipped to improve hydrogen bonding and reduce clashes. All (63) such sidechains are listed below:

Mol	Chain	Res	Type
1	A	102	GLN
1	A	217	ASN
1	A	387	HIS
2	B	825	GLN
3	C	6	GLN
3	C	39	GLN
3	C	54	ASN
3	C	82	GLN
3	C	84	ASN
3	C	168	HIS
4	D	554	ASN
4	D	555	ASN
4	D	581	GLN
4	D	673	ASN
1	E	1102	GLN
1	E	1217	ASN
1	E	1387	HIS
2	F	1535	GLN
2	F	1816	ASN
2	F	1825	GLN
3	G	3006	GLN
3	G	3039	GLN
3	G	3054	ASN
3	G	3082	GLN
3	G	3084	ASN
3	G	3168	HIS

Continued on next page...

Continued from previous page...

Mol	Chain	Res	Type
4	H	3501	GLN
4	H	3554	ASN
4	H	3555	ASN
4	H	3581	GLN
4	H	3673	ASN
1	I	2102	GLN
1	I	2217	ASN
1	I	2356	HIS
1	I	2387	HIS
2	J	2816	ASN
2	J	2825	GLN
3	K	4006	GLN
3	K	4039	GLN
3	K	4054	ASN
3	K	4082	GLN
3	K	4084	ASN
3	K	4168	HIS
4	L	4554	ASN
4	L	4555	ASN
4	L	4581	GLN
4	L	4596	ASN
4	L	4673	ASN
1	M	3102	GLN
1	M	3217	ASN
1	M	3387	HIS
2	N	3816	ASN
2	N	3825	GLN
3	O	5006	GLN
3	O	5039	GLN
3	O	5054	ASN
3	O	5082	GLN
3	O	5084	ASN
3	O	5168	HIS
4	P	5554	ASN
4	P	5555	ASN
4	P	5581	GLN
4	P	5673	ASN

5.3.3 RNA [i](#)

There are no RNA molecules in this entry.

5.4 Non-standard residues in protein, DNA, RNA chains [i](#)

There are no non-standard protein/DNA/RNA residues in this entry.

5.5 Carbohydrates [i](#)

There are no monosaccharides in this entry.

5.6 Ligand geometry [i](#)

There are no ligands in this entry.

5.7 Other polymers [i](#)

There are no such residues in this entry.

5.8 Polymer linkage issues [i](#)

There are no chain breaks in this entry.

6 Map visualisation [i](#)

This section contains visualisations of the EMDB entry EMD-9249. These allow visual inspection of the internal detail of the map and identification of artifacts.

Images derived from a raw map, generated by summing the deposited half-maps, are presented below the corresponding image components of the primary map to allow further visual inspection and comparison with those of the primary map.

6.1 Orthogonal projections [i](#)

6.1.1 Primary map

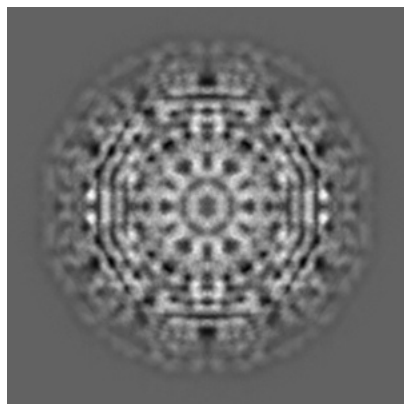

X

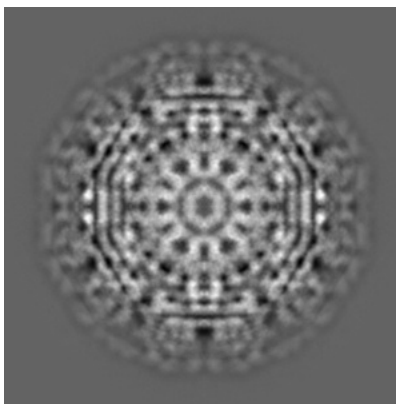

Y

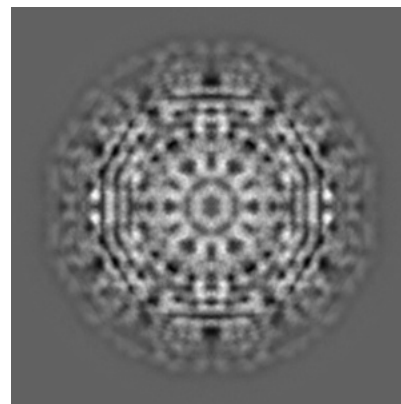

Z

6.1.2 Raw map

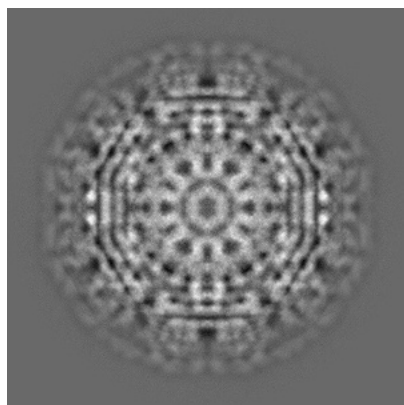

X

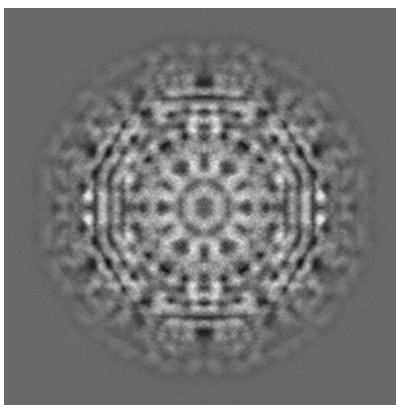

Y

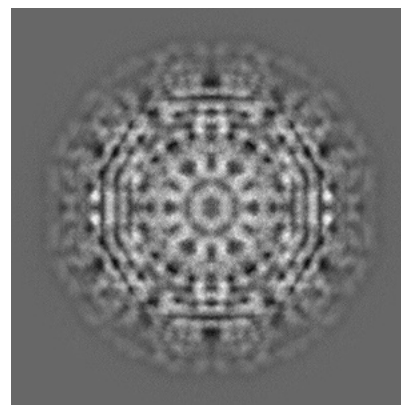

Z

The images above show the map projected in three orthogonal directions.

6.2 Central slices [i](#)

6.2.1 Primary map

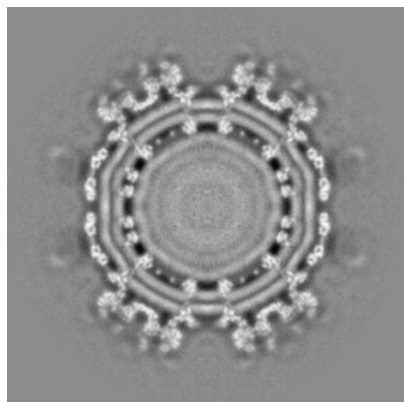

X Index: 280

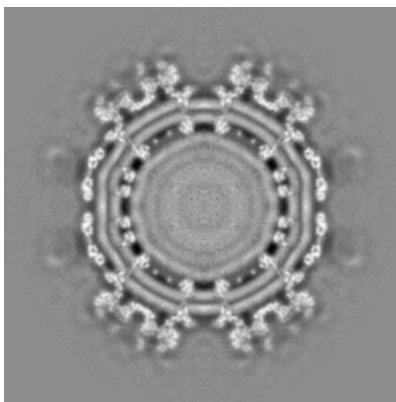

Y Index: 280

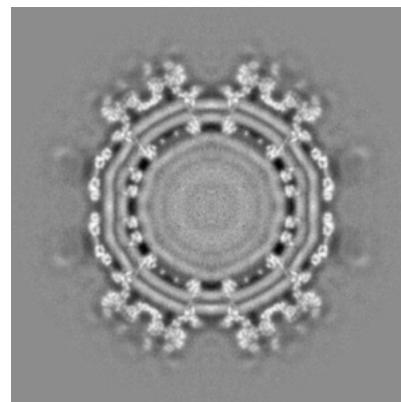

Z Index: 280

6.2.2 Raw map

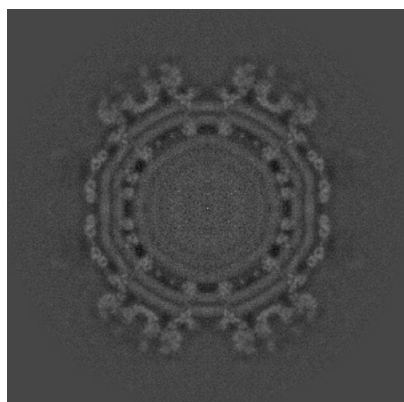

X Index: 280

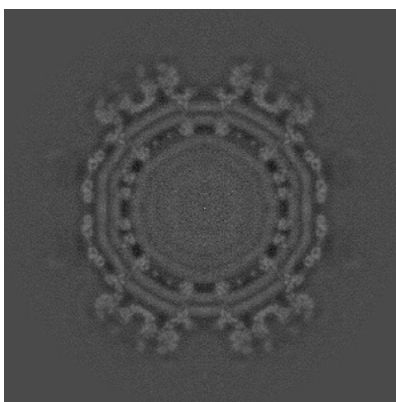

Y Index: 280

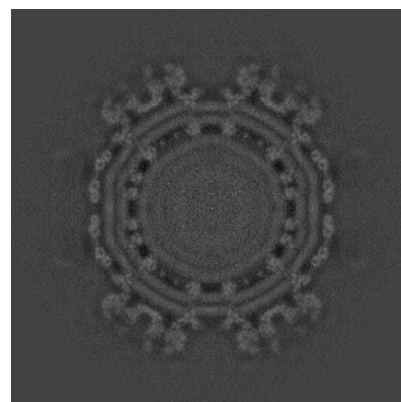

Z Index: 280

The images above show central slices of the map in three orthogonal directions.

6.3 Largest variance slices [i](#)

6.3.1 Primary map

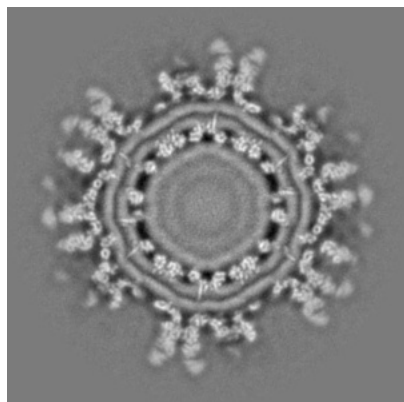

X Index: 227

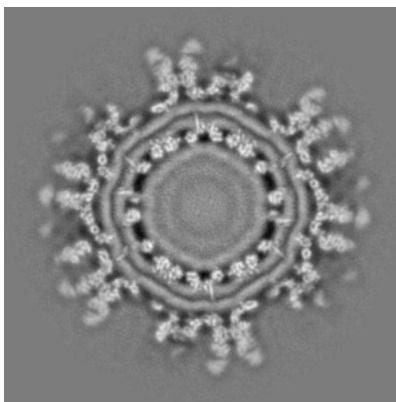

Y Index: 333

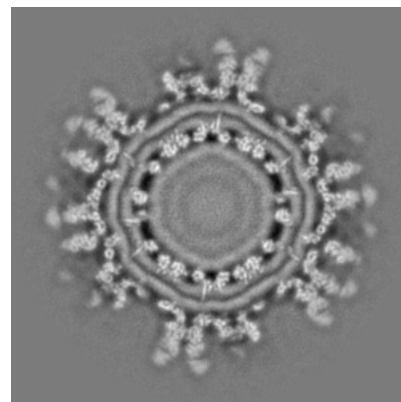

Z Index: 227

6.3.2 Raw map

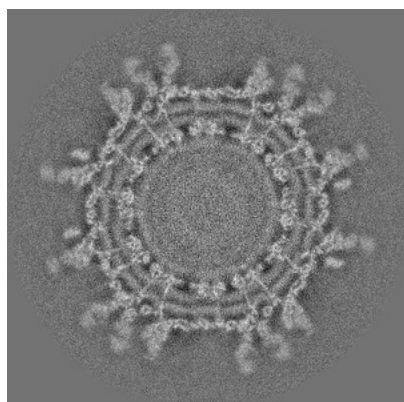

X Index: 297

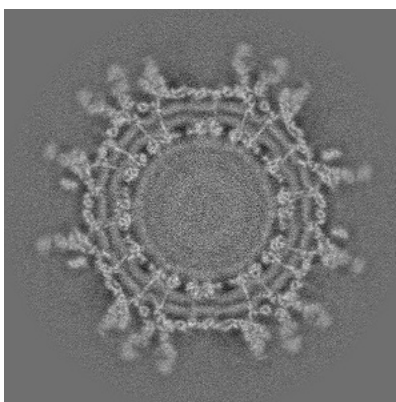

Y Index: 263

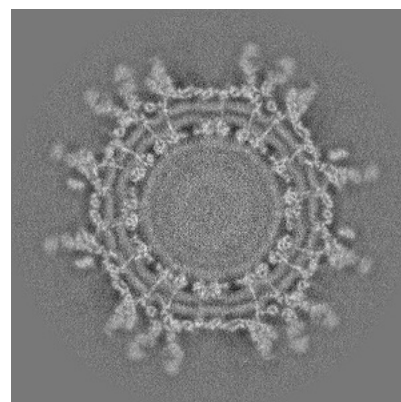

Z Index: 263

The images above show the largest variance slices of the map in three orthogonal directions.

6.4 Orthogonal surface views [i](#)

6.4.1 Primary map

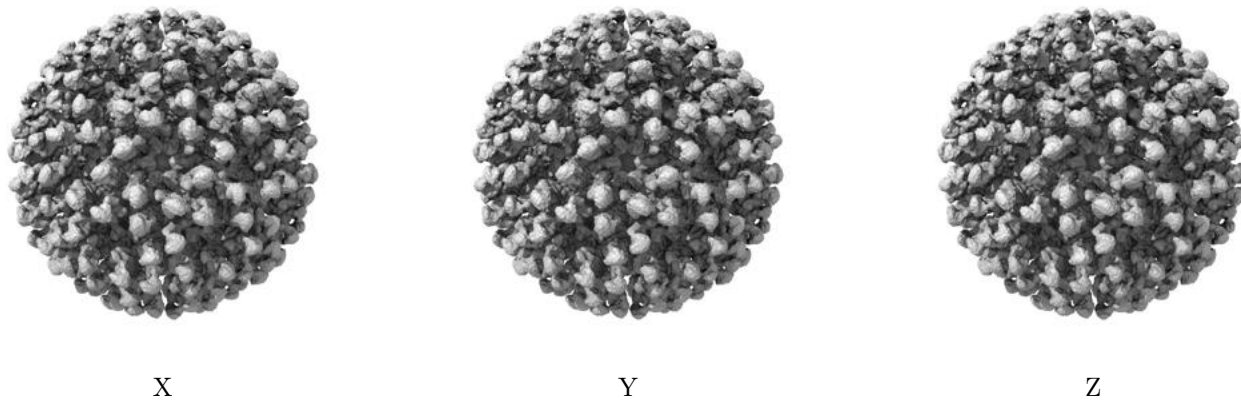

The images above show the 3D surface view of the map at the recommended contour level 0.7. These images, in conjunction with the slice images, may facilitate assessment of whether an appropriate contour level has been provided.

6.4.2 Raw map

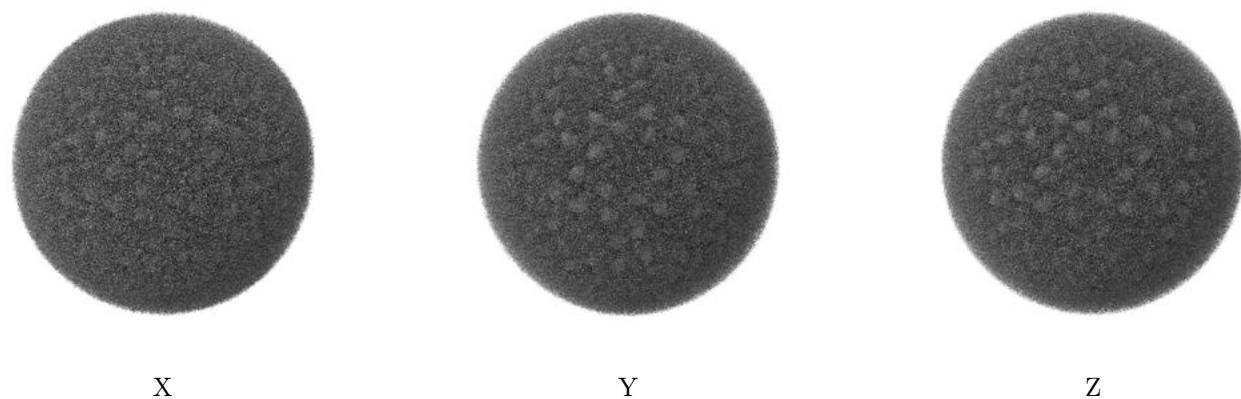

These images show the 3D surface of the raw map. The raw map's contour level was selected so that its surface encloses the same volume as the primary map does at its recommended contour level.

6.5 Mask visualisation [i](#)

This section was not generated. No masks/segmentation were deposited.

7 Map analysis [i](#)

This section contains the results of statistical analysis of the map.

7.1 Map-value distribution [i](#)

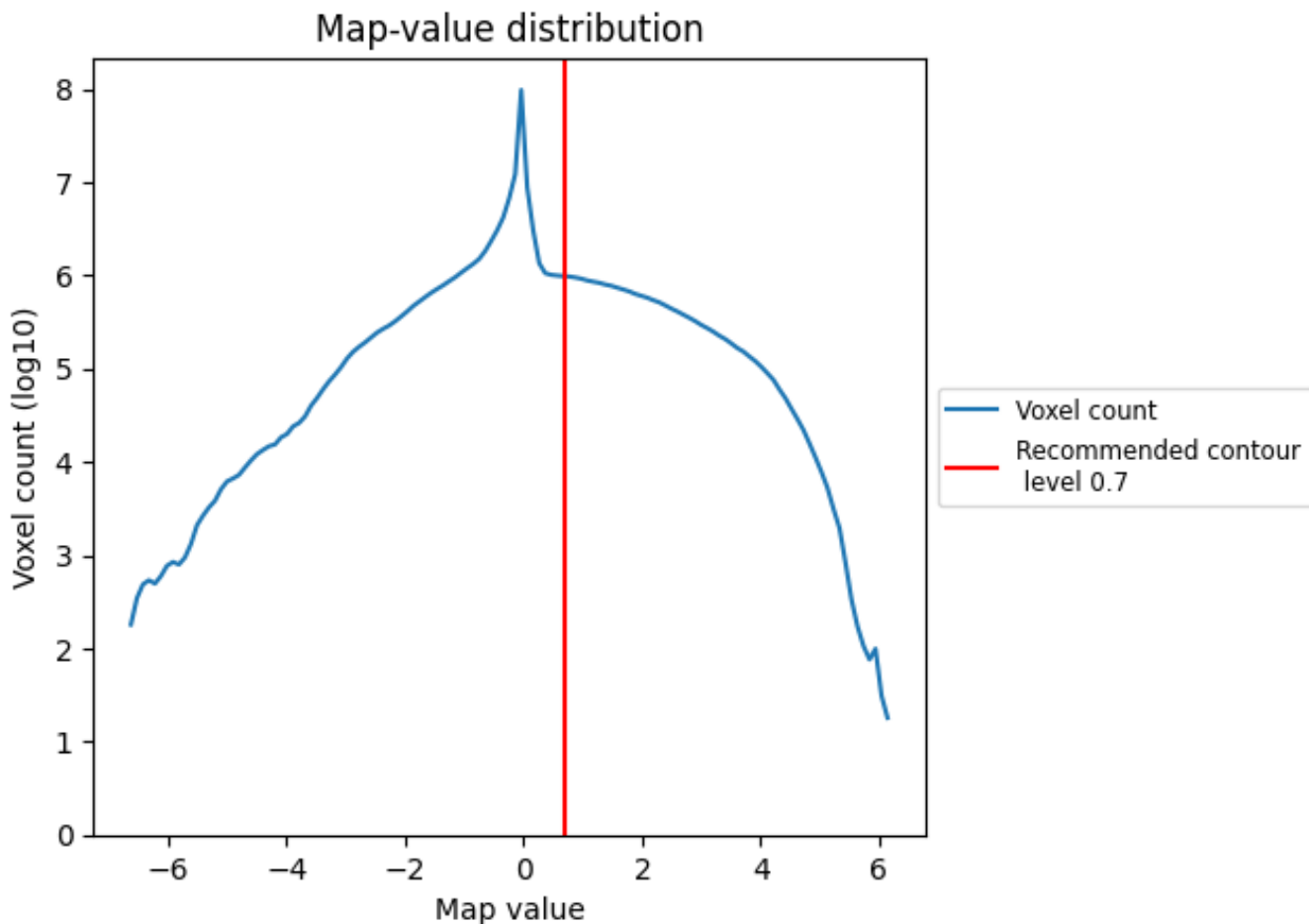

The map-value distribution is plotted in 128 intervals along the x-axis. The y-axis is logarithmic. A spike in this graph at zero usually indicates that the volume has been masked.

7.2 Volume estimate [i](#)

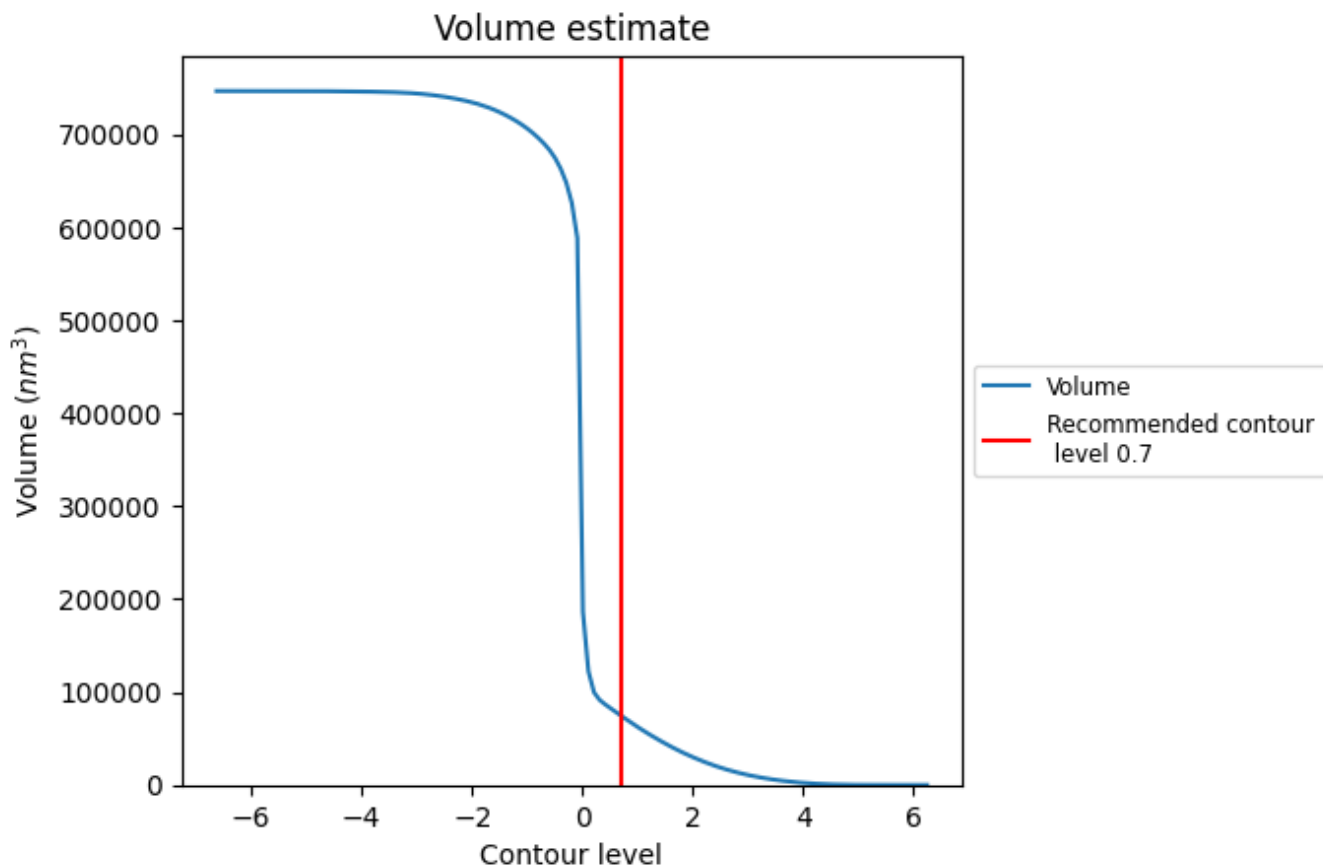

The volume at the recommended contour level is 74514 nm³; this corresponds to an approximate mass of 67311 kDa.

The volume estimate graph shows how the enclosed volume varies with the contour level. The recommended contour level is shown as a vertical line and the intersection between the line and the curve gives the volume of the enclosed surface at the given level.

7.3 Rotationally averaged power spectrum i

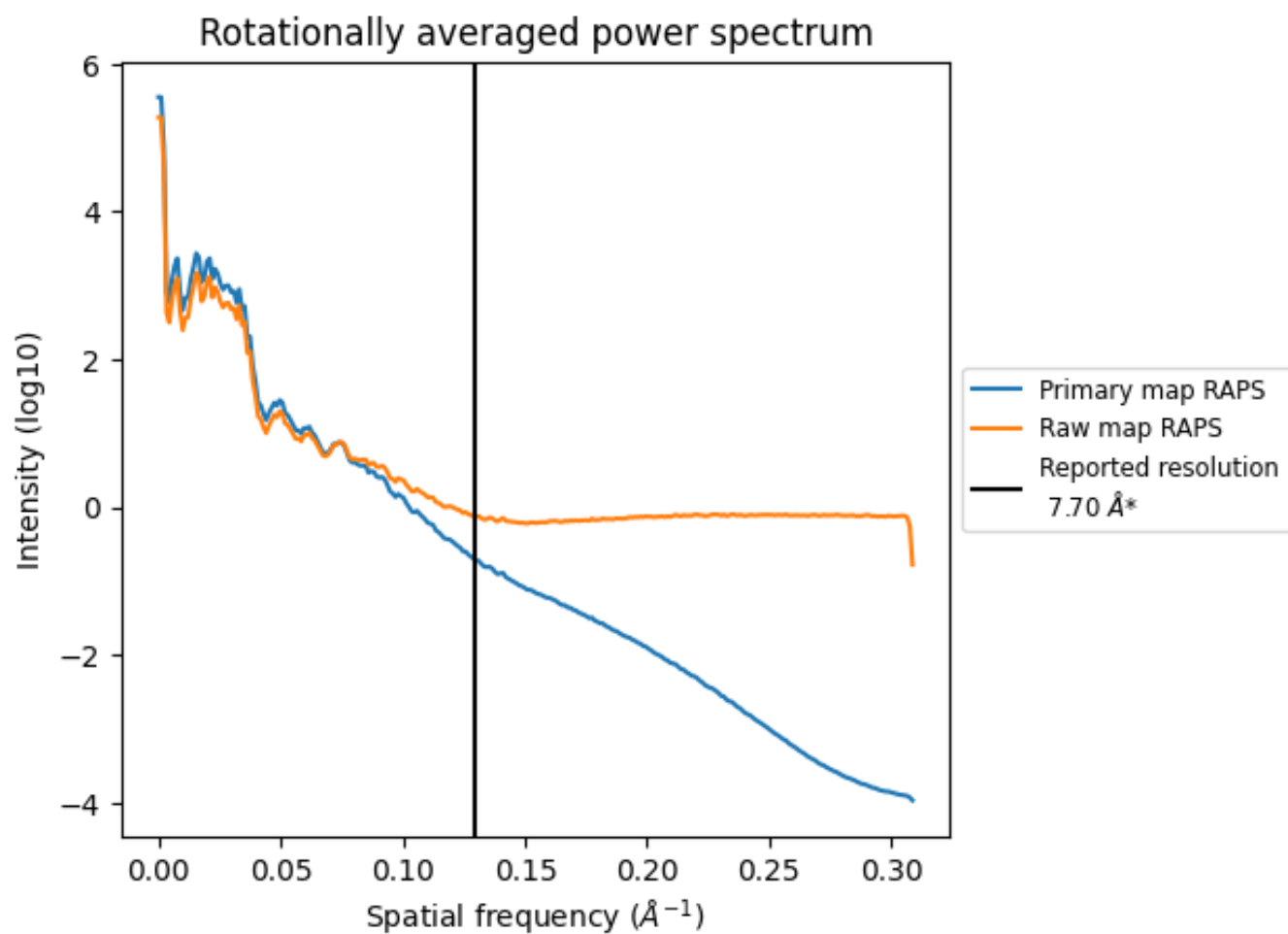

*Reported resolution corresponds to spatial frequency of 0.130 Å⁻¹

8 Fourier-Shell correlation [i](#)

Fourier-Shell Correlation (FSC) is the most commonly used method to estimate the resolution of single-particle and subtomogram-averaged maps. The shape of the curve depends on the imposed symmetry, mask and whether or not the two 3D reconstructions used were processed from a common reference. The reported resolution is shown as a black line. A curve is displayed for the half-bit criterion in addition to lines showing the 0.143 gold standard cut-off and 0.5 cut-off.

8.1 FSC [i](#)

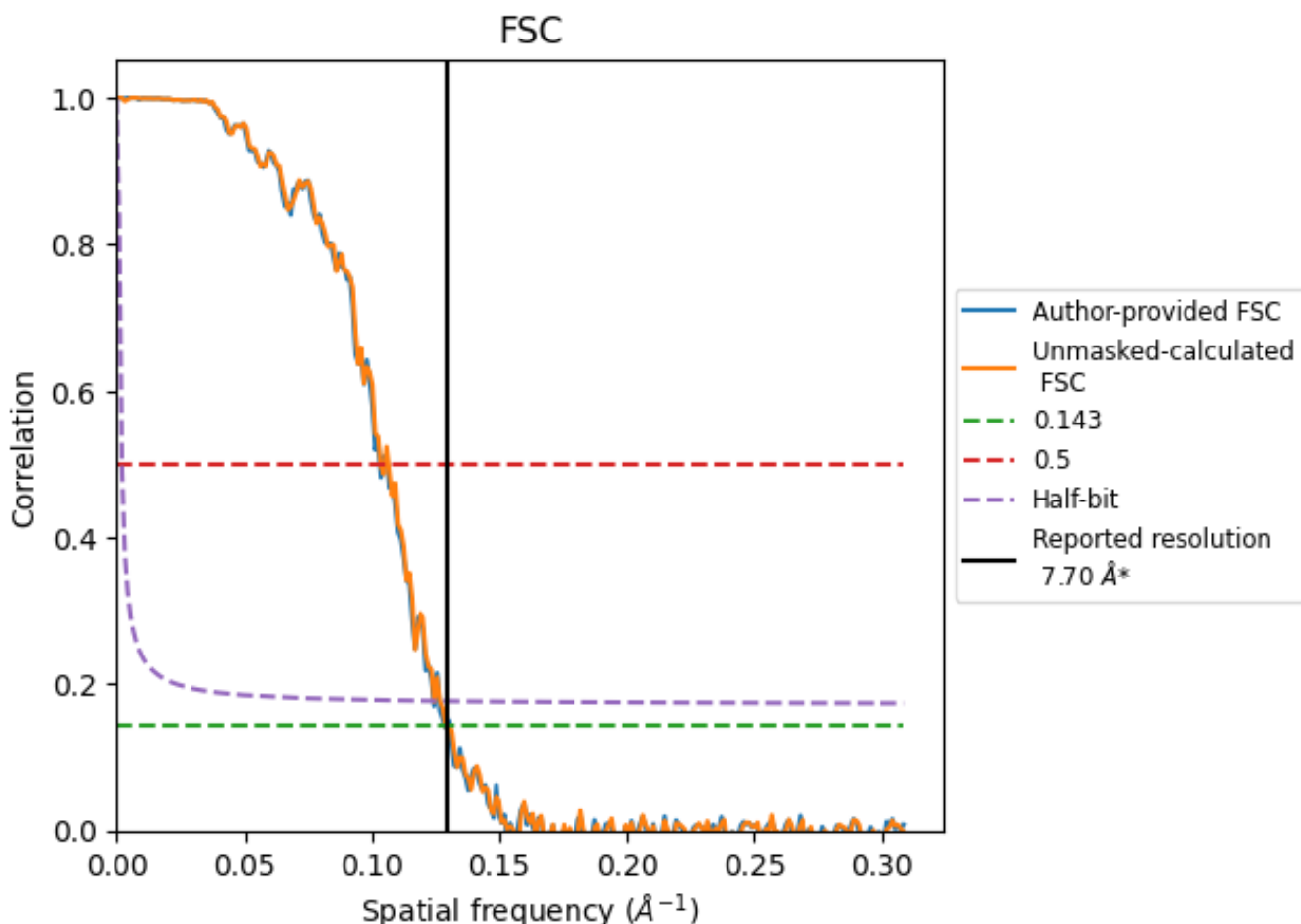

*Reported resolution corresponds to spatial frequency of 0.130 Å⁻¹

8.2 Resolution estimates [i](#)

Resolution estimate (Å)	Estimation criterion (FSC cut-off)		
	0.143	0.5	Half-bit
Reported by author	7.70	-	-
Author-provided FSC curve	7.77	9.69	8.04
Unmasked-calculated*	7.76	9.66	8.03

*Resolution estimate based on FSC curve calculated by comparison of deposited half-maps.

9 Map-model fit [i](#)

This section contains information regarding the fit between EMDB map EMD-9249 and PDB model 6MUI. Per-residue inclusion information can be found in section 3 on page 6.

9.1 Map-model overlays

9.1.1 Map-model overlay [i](#)

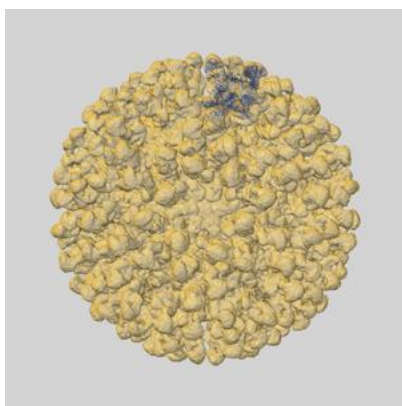

X

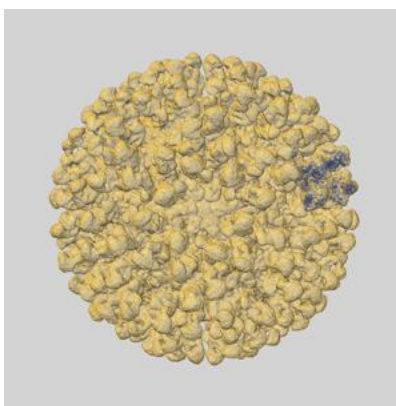

Y

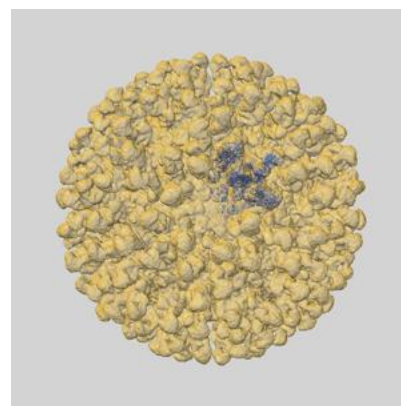

Z

9.1.2 Map-model assembly overlay [i](#)

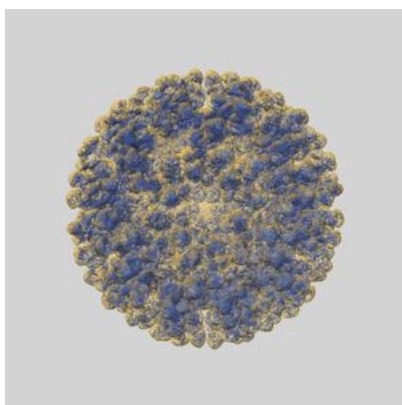

X

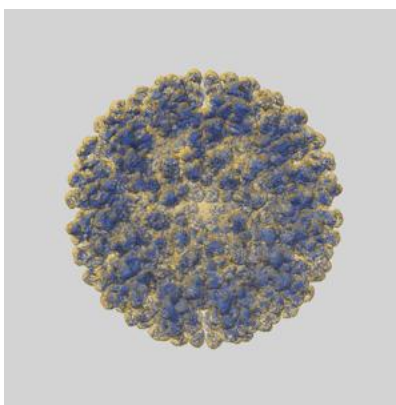

Y

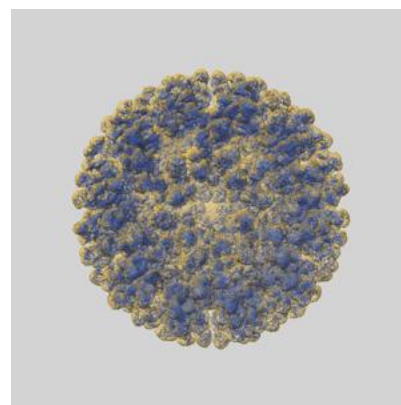

Z

The images above show the 3D surface view of the map at the recommended contour level 0.7 at 50% transparency in yellow overlaid with a ribbon representation of the model coloured in blue. These images allow for the visual assessment of the quality of fit between the atomic model and the map.

9.2 Q-score mapped to coordinate model [i](#)

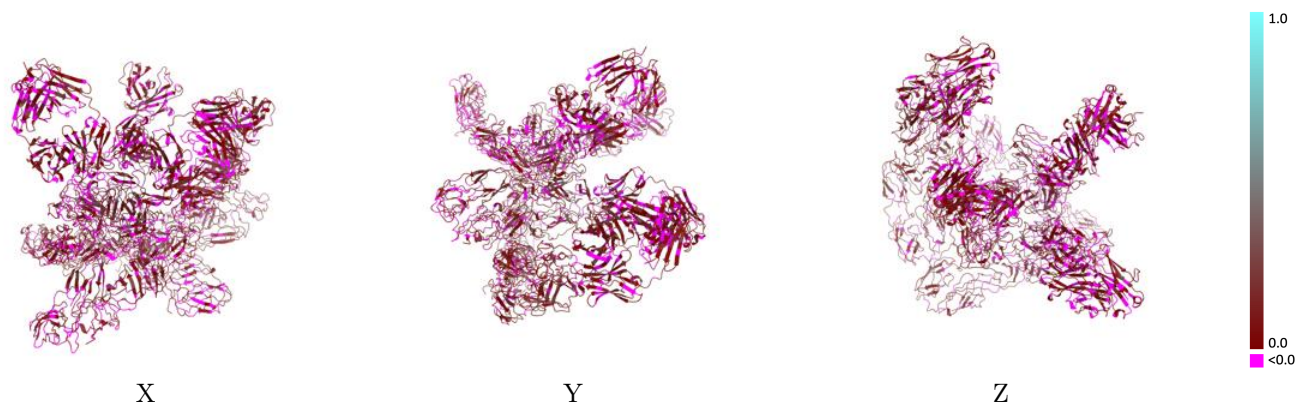

The images above show the model with each residue coloured according to its Q-score. This shows their resolvability in the map with higher Q-score values reflecting better resolvability. Please note: Q-score is calculating the resolvability of atoms, and thus high values are only expected at resolutions at which atoms can be resolved. Low Q-score values may therefore be expected for many entries.

9.3 Atom inclusion mapped to coordinate model [i](#)

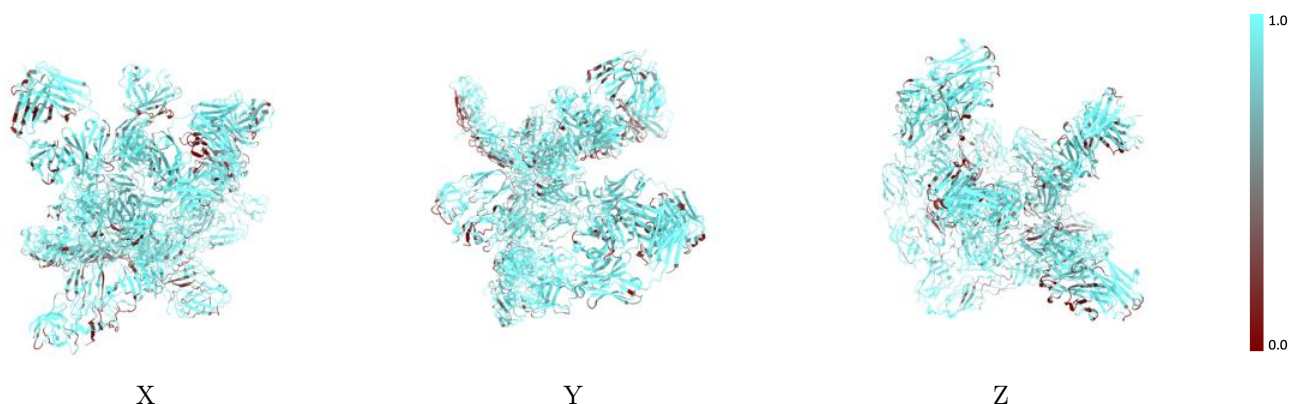

The images above show the model with each residue coloured according to its atom inclusion. This shows to what extent they are inside the map at the recommended contour level (0.7).



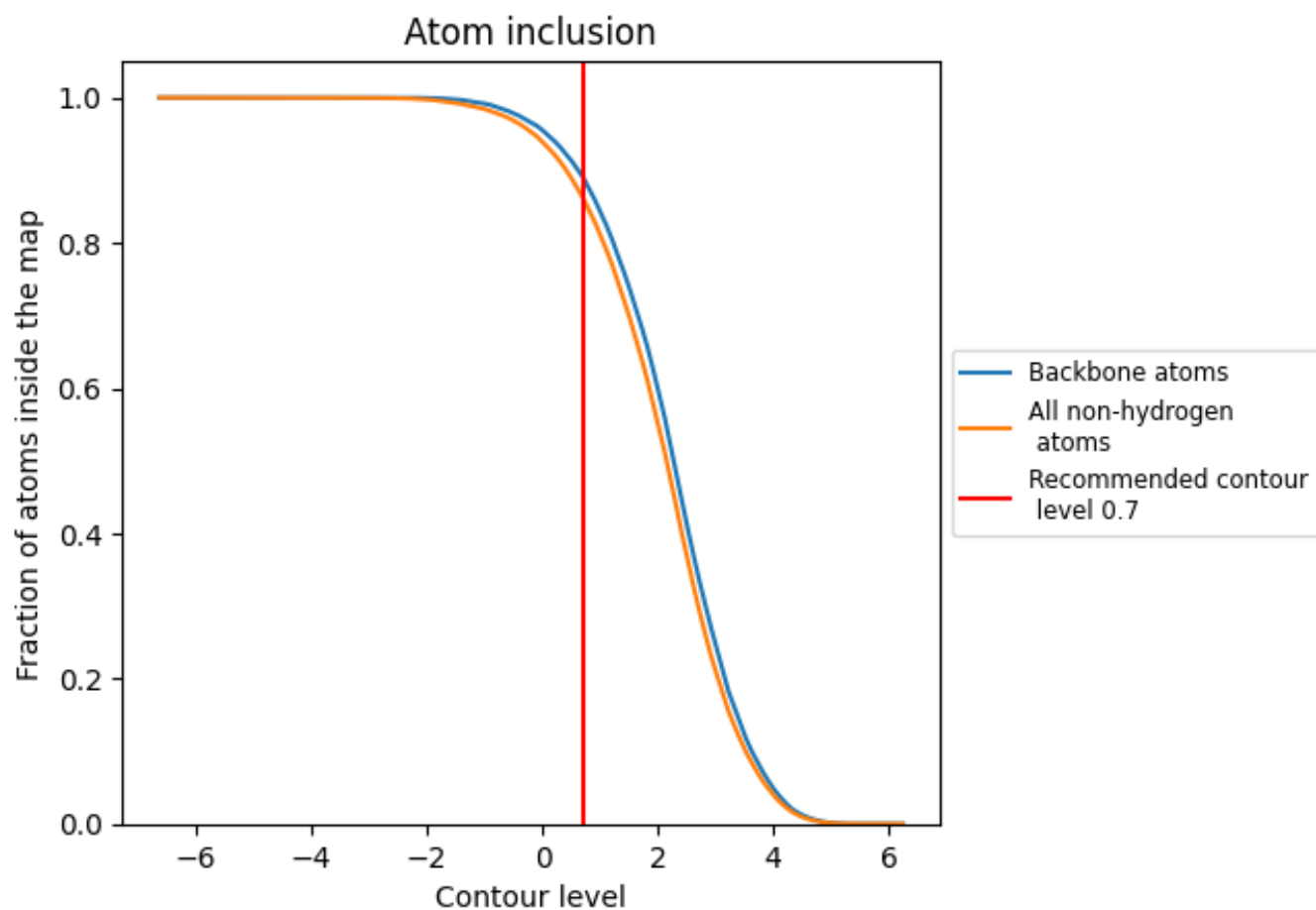































9.4 Atom inclusion [i](#)



At the recommended contour level, 89% of all backbone atoms, 86% of all non-hydrogen atoms, are inside the map.

9.5 Map-model fit summary

The table lists the average atom inclusion at the recommended contour level (0.7) and Q-score for the entire model and for each chain.

Chain	Atom inclusion	Q-score
All	 0.8624	 0.0750
A	 0.8771	 0.1090
B	 0.9203	 0.1220
C	 0.8740	 0.0670
D	 0.8856	 0.0640
E	 0.8304	 0.0840
F	 0.8966	 0.0930
G	 0.8375	 0.0560
H	 0.8983	 0.0520
I	 0.8801	 0.0970
J	 0.8822	 0.0660
K	 0.7809	 0.0480
L	 0.8659	 0.0510
M	 0.8178	 0.0690
N	 0.8417	 0.0560
O	 0.8411	 0.0440
P	 0.8601	 0.0490

