



Full wwPDB EM Validation Report ⓘ

Nov 21, 2022 – 12:51 AM EST

PDB ID : 7MSM
EMDB ID : EMD-23969
Title : Mtb 70SIC in complex with MtbEttA at Trans_R0 state
Authors : Cui, Z.; Zhang, J.
Deposited on : 2021-05-11
Resolution : 2.79 Å(reported)

This is a Full wwPDB EM Validation Report for a publicly released PDB entry.

We welcome your comments at validation@mail.wwpdb.org

A user guide is available at

<https://www.wwpdb.org/validation/2017/EMValidationReportHelp>

with specific help available everywhere you see the ⓘ symbol.

The types of validation reports are described at

<http://www.wwpdb.org/validation/2017/FAQs#types>.

The following versions of software and data (see [references ⓘ](#)) were used in the production of this report:

EMDB validation analysis : 0.0.1.dev43
Mogul : 1.8.5 (274361), CSD as541be (2020)
MolProbity : 4.02b-467
buster-report : 1.1.7 (2018)
Percentile statistics : 20191225.v01 (using entries in the PDB archive December 25th 2019)
MapQ : 1.9.9
Ideal geometry (proteins) : Engh & Huber (2001)
Ideal geometry (DNA, RNA) : Parkinson et al. (1996)
Validation Pipeline (wwPDB-VP) : 2.31.2

1 Overall quality at a glance i

The following experimental techniques were used to determine the structure:

ELECTRON MICROSCOPY

The reported resolution of this entry is 2.79 Å.

Percentile scores (ranging between 0-100) for global validation metrics of the entry are shown in the following graphic. The table shows the number of entries on which the scores are based.

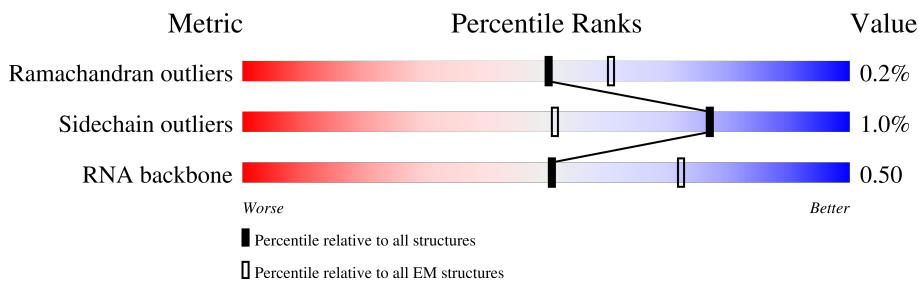











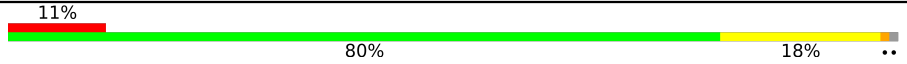

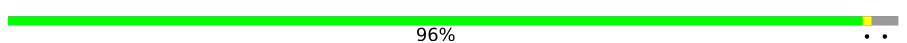
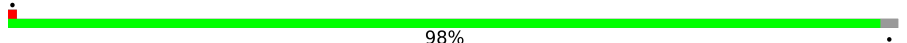

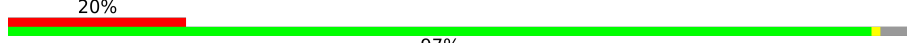

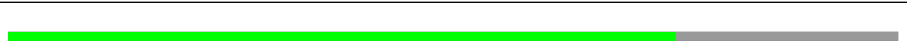
Metric	Whole archive (#Entries)	EM structures (#Entries)
Ramachandran outliers	154571	4023
Sidechain outliers	154315	3826
RNA backbone	4643	859

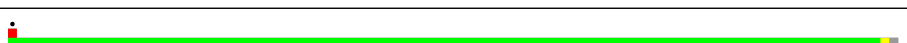
The table below summarises the geometric issues observed across the polymeric chains and their fit to the map. The red, orange, yellow and green segments of the bar indicate the fraction of residues that contain outliers for ≥ 3 , 2, 1 and 0 types of geometric quality criteria respectively. A grey segment represents the fraction of residues that are not modelled. The numeric value for each fraction is indicated below the corresponding segment, with a dot representing fractions $\leq 5\%$. The upper red bar (where present) indicates the fraction of residues that have poor fit to the EM map (all-atom inclusion $< 40\%$). The numeric value is given above the bar.

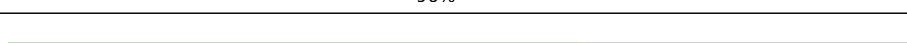
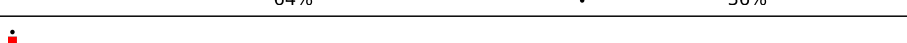
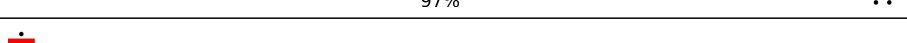
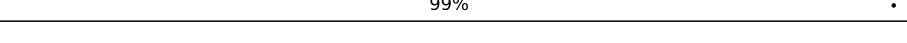
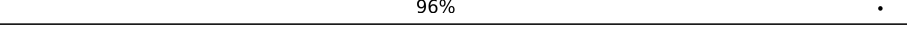
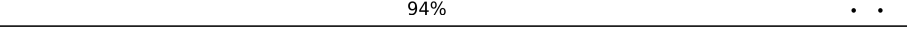
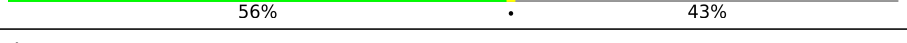
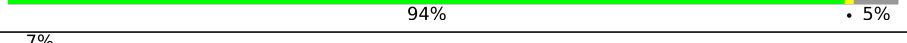
Mol	Chain	Length	Quality of chain
1	0	57	
2	1	55	
3	2	47	
4	3	64	
5	4	37	
6	6	80	
7	7	24	
8	8	235	



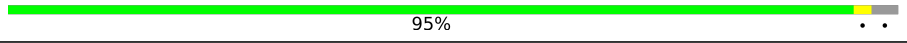







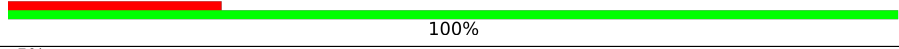

Continued on next page...

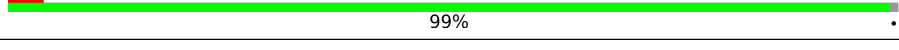
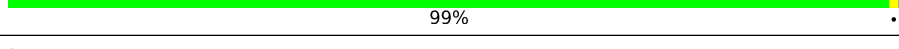
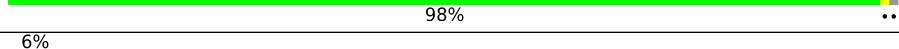
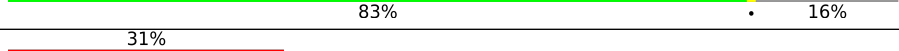
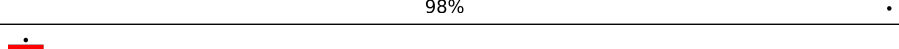
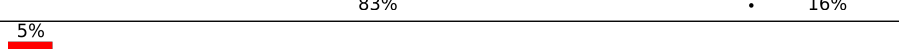
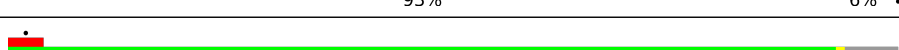
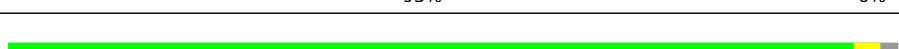
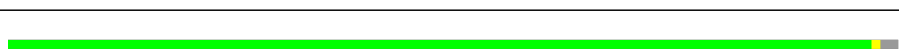
Continued from previous page...

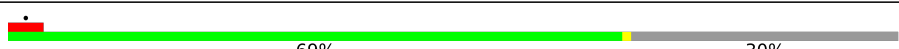
Mol	Chain	Length	Quality of chain
9	A	3138	
10	B	115	
11	C	280	
12	D	217	
13	E	223	
14	F	187	
15	G	179	
16	H	152	
17	J	195	
18	K	122	
19	L	146	
20	M	138	
21	N	180	
22	O	122	
23	P	113	
24	Q	129	
25	R	104	
26	S	197	
27	T	100	
28	U	105	
29	V	215	
30	W	86	
31	X	64	
32	Y	77	
33	Z	65	

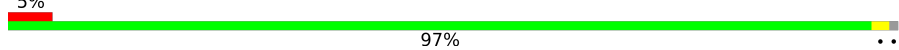
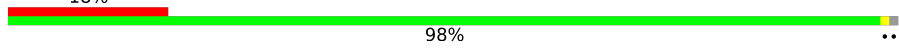
Continued on next page...

Continued from previous page...

Mol	Chain	Length	Quality of chain
34	a	1537	 81% 17%
35	c	274	 10% 75% 24%
36	d	201	 24% 100%
37	e	220	 5% 76% 23%
38	f	96	 99%
39	g	156	 99%
40	h	132	 98%
41	i	151	 6% 83% 16%
42	j	101	 31% 98%
43	k	139	 83% 16%
44	l	124	 5% 93% 6%
45	m	124	 93% 6%
46	n	61	 95%
47	o	89	 97%
48	p	162	 9% 69% 30%
49	q	135	 69% 30%
50	r	84	 5% 73% 24%
51	s	93	 5% 89% 11%
52	t	86	 5% 97%
53	x	558	 18% 98%
54	y	77	 68% 30%
55	z	26	 12% 12% 73%

2 Entry composition

There are 60 unique types of molecules in this entry. The entry contains 152436 atoms, of which 0 are hydrogens and 0 are deuteriums.

In the tables below, the AltConf column contains the number of residues with at least one atom in alternate conformation and the Trace column contains the number of residues modelled with at most 2 atoms.

- Molecule 1 is a protein called 50S ribosomal protein L32.

Mol	Chain	Residues	Atoms				AltConf	Trace
			Total	C	N	O		
1	0	54	429	266	94	69	0	0

- Molecule 2 is a protein called 50S ribosomal protein L33 2.

Mol	Chain	Residues	Atoms					AltConf	Trace
			Total	C	N	O	S		
2	1	48	400	245	84	67	4	0	0

- Molecule 3 is a protein called 50S ribosomal protein L34.

Mol	Chain	Residues	Atoms					AltConf	Trace
			Total	C	N	O	S		
3	2	44	374	222	97	54	1	0	0

- Molecule 4 is a protein called 50S ribosomal protein L35.

Mol	Chain	Residues	Atoms				AltConf	Trace
			Total	C	N	O		
4	3	62	494	298	112	84	0	0

- Molecule 5 is a protein called 50S ribosomal protein L36.

Mol	Chain	Residues	Atoms					AltConf	Trace
			Total	C	N	O	S		
5	4	37	299	182	66	47	4	0	0

There is a discrepancy between the modelled and reference sequences:

Chain	Residue	Modelled	Actual	Comment	Reference
4	1	VAL	MET	conflict	UNP P9WH89

- Molecule 6 is a protein called 50S ribosomal protein L31.

Mol	Chain	Residues	Atoms					AltConf	Trace
6	6	57	Total	C	N	O	S	0	0
			446	277	82	82	5		

- Molecule 7 is a protein called 50S ribosomal protein L37.

Mol	Chain	Residues	Atoms				AltConf	Trace
7	7	22	Total	C	N	O	0	0
			186	111	47	28		

- Molecule 8 is a protein called 50S ribosomal protein L1.

Mol	Chain	Residues	Atoms					AltConf	Trace
8	8	230	Total	C	N	O	S	0	0
			1704	1068	310	323	3		

- Molecule 9 is a RNA chain called 23S rRNA.

Mol	Chain	Residues	Atoms					AltConf	Trace
9	A	3118	Total	C	N	O	P	0	0
			66958	29847	12340	21653	3118		

- Molecule 10 is a RNA chain called 5S rRNA.

Mol	Chain	Residues	Atoms					AltConf	Trace
10	B	115	Total	C	N	O	P	0	0
			2458	1097	456	790	115		

- Molecule 11 is a protein called 50S ribosomal protein L2.

Mol	Chain	Residues	Atoms					AltConf	Trace
11	C	272	Total	C	N	O	S	0	0
			2088	1277	437	369	5		

- Molecule 12 is a protein called 50S ribosomal protein L3.

Mol	Chain	Residues	Atoms					AltConf	Trace
12	D	213	Total	C	N	O	S	0	0
			1590	985	307	292	6		

- Molecule 13 is a protein called 50S ribosomal protein L4.

Mol	Chain	Residues	Atoms					AltConf	Trace
			Total	C	N	O	S		
13	E	207	1552	958	303	289	2	0	0

- Molecule 14 is a protein called 50S ribosomal protein L5.

Mol	Chain	Residues	Atoms					AltConf	Trace
			Total	C	N	O	S		
14	F	178	1408	885	267	251	5	0	0

- Molecule 15 is a protein called 50S ribosomal protein L6.

Mol	Chain	Residues	Atoms					AltConf	Trace
			Total	C	N	O	S		
15	G	174	1330	836	249	244	1	0	0

- Molecule 16 is a protein called 50S ribosomal protein L9.

Mol	Chain	Residues	Atoms					AltConf	Trace
			Total	C	N	O	S		
16	H	47	350	220	64	65	1	0	0

- Molecule 17 is a protein called 50S ribosomal protein L13.

Mol	Chain	Residues	Atoms					AltConf	Trace
			Total	C	N	O	S		
17	J	146	1143	724	217	199	3	0	0

- Molecule 18 is a protein called 50S ribosomal protein L14.

Mol	Chain	Residues	Atoms					AltConf	Trace
			Total	C	N	O	S		
18	K	122	941	590	180	169	2	0	0

There is a discrepancy between the modelled and reference sequences:

Chain	Residue	Modelled	Actual	Comment	Reference
K	1	VAL	MET	conflict	UNP A0A045HTP7

- Molecule 19 is a protein called 50S ribosomal protein L15.

Mol	Chain	Residues	Atoms					AltConf	Trace
19	L	144	Total	C	N	O	S	0	0
			1075	666	217	190	2		

- Molecule 20 is a protein called 50S ribosomal protein L16.

Mol	Chain	Residues	Atoms					AltConf	Trace
20	M	134	Total	C	N	O	S	0	0
			1072	679	215	177	1		

- Molecule 21 is a protein called 50S ribosomal protein L17.

Mol	Chain	Residues	Atoms					AltConf	Trace
21	N	116	Total	C	N	O	S	0	0
			908	574	175	158	1		

- Molecule 22 is a protein called 50S ribosomal protein L18.

Mol	Chain	Residues	Atoms				AltConf	Trace
22	O	119	Total	C	N	O	0	0
			905	552	191	162		

- Molecule 23 is a protein called 50S ribosomal protein L19.

Mol	Chain	Residues	Atoms					AltConf	Trace
23	P	112	Total	C	N	O	S	0	0
			907	573	174	159	1		

- Molecule 24 is a protein called 50S ribosomal protein L20.

Mol	Chain	Residues	Atoms				AltConf	Trace
24	Q	124	Total	C	N	O	0	0
			993	616	207	170		

- Molecule 25 is a protein called 50S ribosomal protein L21.

Mol	Chain	Residues	Atoms				AltConf	Trace
25	R	100	Total	C	N	O	0	0
			757	482	138	137		

There is a discrepancy between the modelled and reference sequences:

Chain	Residue	Modelled	Actual	Comment	Reference
R	1	MET	-	insertion	UNP P9WHC3

- Molecule 26 is a protein called 50S ribosomal protein L22.

Mol	Chain	Residues	Atoms				AltConf	Trace
			Total	C	N	O		
26	S	113	860	533	178	149	0	0

- Molecule 27 is a protein called 50S ribosomal protein L23.

Mol	Chain	Residues	Atoms				AltConf	Trace
			Total	C	N	O		
27	T	95	741	469	138	134	0	0

- Molecule 28 is a protein called 50S ribosomal protein L24.

Mol	Chain	Residues	Atoms					AltConf	Trace
			Total	C	N	O	S		
28	U	90	699	430	138	129	2	0	0

- Molecule 29 is a protein called 50S ribosomal protein L25.

Mol	Chain	Residues	Atoms				AltConf	Trace
			Total	C	N	O		
29	V	177	1319	822	243	254	0	0

- Molecule 30 is a protein called 50S ribosomal protein L27.

Mol	Chain	Residues	Atoms				AltConf	Trace
			Total	C	N	O		
30	W	74	549	337	114	98	0	0

- Molecule 31 is a protein called 50S ribosomal protein L28.

Mol	Chain	Residues	Atoms					AltConf	Trace
			Total	C	N	O	S		
31	X	62	468	284	100	80	4	0	0

- Molecule 32 is a protein called 50S ribosomal protein L29.

Mol	Chain	Residues	Atoms					AltConf	Trace
32	Y	68	Total	C	N	O	S	0	0
			560	343	109	107	1		

- Molecule 33 is a protein called 50S ribosomal protein L30.

Mol	Chain	Residues	Atoms				AltConf	Trace
33	Z	59	Total	C	N	O	0	0
			476	293	101	82		

- Molecule 34 is a RNA chain called 16S rRNA.

Mol	Chain	Residues	Atoms					AltConf	Trace
34	a	1519	Total	C	N	O	P	0	0
			32620	14535	5961	10605	1519		

- Molecule 35 is a protein called 30S ribosomal protein S3.

Mol	Chain	Residues	Atoms					AltConf	Trace
35	c	207	Total	C	N	O	S	0	0
			1654	1030	322	298	4		

- Molecule 36 is a protein called 30S ribosomal protein S4.

Mol	Chain	Residues	Atoms					AltConf	Trace
36	d	200	Total	C	N	O	S	0	0
			1650	1036	316	296	2		

- Molecule 37 is a protein called 30S ribosomal protein S5.

Mol	Chain	Residues	Atoms					AltConf	Trace
37	e	169	Total	C	N	O	S	0	0
			1222	770	231	218	3		

- Molecule 38 is a protein called 30S ribosomal protein S6.

Mol	Chain	Residues	Atoms					AltConf	Trace
38	f	95	Total	C	N	O	S	0	0
			757	480	133	141	3		

- Molecule 39 is a protein called 30S ribosomal protein S7.

Mol	Chain	Residues	Atoms					AltConf	Trace
39	g	155	Total	C	N	O	S	0	0
			1230	768	241	219	2		

- Molecule 40 is a protein called 30S ribosomal protein S8.

Mol	Chain	Residues	Atoms					AltConf	Trace
40	h	131	Total	C	N	O	S	0	0
			1006	631	188	186	1		

- Molecule 41 is a protein called 30S ribosomal protein S9.

Mol	Chain	Residues	Atoms				AltConf	Trace
41	i	127	Total	C	N	O	0	0
			992	628	195	169		

- Molecule 42 is a protein called 30S ribosomal protein S10.

Mol	Chain	Residues	Atoms					AltConf	Trace
42	j	99	Total	C	N	O	S	0	0
			789	496	146	144	3		

- Molecule 43 is a protein called 30S ribosomal protein S11.

Mol	Chain	Residues	Atoms				AltConf	Trace
43	k	117	Total	C	N	O	0	0
			873	540	175	158		

- Molecule 44 is a protein called 30S ribosomal protein S12.

Mol	Chain	Residues	Atoms					AltConf	Trace
44	l	122	Total	C	N	O	S	0	0
			959	594	197	166	2		

- Molecule 45 is a protein called 30S ribosomal protein S13.

Mol	Chain	Residues	Atoms					AltConf	Trace
45	m	116	Total	C	N	O	S	0	0
			945	578	196	168	3		

- Molecule 46 is a protein called 30S ribosomal protein S14 type Z.

Mol	Chain	Residues	Atoms					AltConf	Trace
46	n	60	Total	C	N	O	S	0	0
			468	294	96	73	5		

- Molecule 47 is a protein called 30S ribosomal protein S15.

Mol	Chain	Residues	Atoms				AltConf	Trace
47	o	87	Total	C	N	O	0	0
			718	449	144	125		

- Molecule 48 is a protein called 30S ribosomal protein S16.

Mol	Chain	Residues	Atoms				AltConf	Trace
48	p	113	Total	C	N	O	0	0
			884	564	166	154		

- Molecule 49 is a protein called 30S ribosomal protein S17.

Mol	Chain	Residues	Atoms					AltConf	Trace
49	q	95	Total	C	N	O	S	0	0
			770	482	152	133	3		

- Molecule 50 is a protein called 30S ribosomal protein S18 1.

Mol	Chain	Residues	Atoms					AltConf	Trace
50	r	64	Total	C	N	O	S	0	0
			506	315	98	90	3		

- Molecule 51 is a protein called 30S ribosomal protein S19.

Mol	Chain	Residues	Atoms					AltConf	Trace
51	s	83	Total	C	N	O	S	0	0
			672	432	125	114	1		

- Molecule 52 is a protein called 30S ribosomal protein S20.

Mol	Chain	Residues	Atoms				AltConf	Trace
52	t	85	Total	C	N	O	0	0
			652	394	141	117		

- Molecule 53 is a protein called Energy-dependent translational throttle protein EttA.

Mol	Chain	Residues	Atoms					AltConf	Trace
			Total	C	N	O	S		
53	x	553	4312	2712	754	834	12	0	0

- Molecule 54 is a RNA chain called initiator tRNA (Met).

Mol	Chain	Residues	Atoms					AltConf	Trace
			Total	C	N	O	P		
54	y	77	1644	732	297	538	77	0	0

- Molecule 55 is a RNA chain called mRNA.

Mol	Chain	Residues	Atoms					AltConf	Trace
			Total	C	N	O	P		
55	z	7	149	67	27	48	7	0	0

- Molecule 56 is ZINC ION (three-letter code: ZN) (formula: Zn).

Mol	Chain	Residues	Atoms		AltConf
56	1	1	Total 1	Zn 1	0
56	4	1	Total 1	Zn 1	0
56	6	1	Total 1	Zn 1	0
56	X	1	Total 1	Zn 1	0
56	n	1	Total 1	Zn 1	0
56	r	1	Total 1	Zn 1	0

- Molecule 57 is MAGNESIUM ION (three-letter code: MG) (formula: Mg).

Mol	Chain	Residues	Atoms		AltConf
57	A	302	Total 302	Mg 302	0
57	B	5	Total 5	Mg 5	0
57	C	1	Total 1	Mg 1	0
57	L	1	Total 1	Mg 1	0

Continued on next page...

Continued from previous page...

Mol	Chain	Residues	Atoms		AltConf
57	W	1	Total	Mg	0
			1	1	
57	a	130	Total	Mg	0
			130	130	
57	r	1	Total	Mg	0
			1	1	
57	x	2	Total	Mg	0
			2	2	
57	y	2	Total	Mg	0
			2	2	

- Molecule 58 is ADENOSINE-5'-DIPHOSPHATE (three-letter code: ADP) (formula: $C_{10}H_{15}N_5O_{10}P_2$).

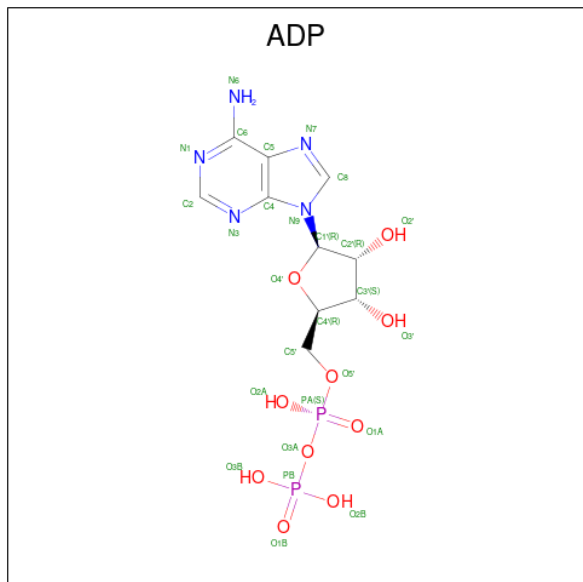

Mol	Chain	Residues	Atoms					AltConf
58	x	1	Total	C	N	O	P	0
			54	20	10	20	4	
58	x	1	Total	C	N	O	P	0
			54	20	10	20	4	

- Molecule 59 is VANADATE ION (three-letter code: VO4) (formula: O_4V).

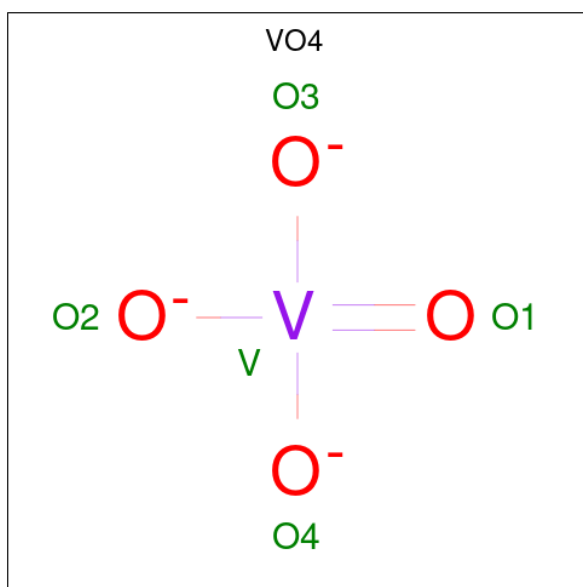

Mol	Chain	Residues	Atoms			AltConf
59	x	1	Total	O	V	0
			10	8	2	
59	x	1	Total	O	V	0
			10	8	2	

- Molecule 60 is N-FORMYLMETHIONINE (three-letter code: FME) (formula: $C_6H_{11}NO_3S$).

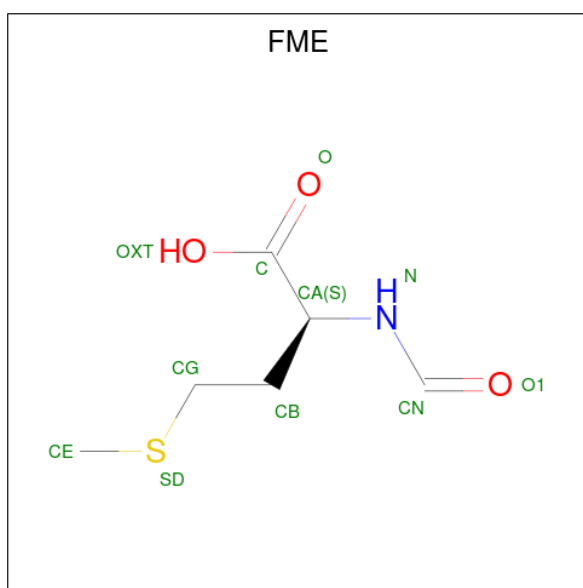

Mol	Chain	Residues	Atoms				AltConf	
60	y	1	Total	C	N	O	S	0
			10	6	1	2	1	

3 Residue-property plots [i](#)

These plots are drawn for all protein, RNA, DNA and oligosaccharide chains in the entry. The first graphic for a chain summarises the proportions of the various outlier classes displayed in the second graphic. The second graphic shows the sequence view annotated by issues in geometry and atom inclusion in map density. Residues are color-coded according to the number of geometric quality criteria for which they contain at least one outlier: green = 0, yellow = 1, orange = 2 and red = 3 or more. A red diamond above a residue indicates a poor fit to the EM map for this residue (all-atom inclusion < 40%). Stretches of 2 or more consecutive residues without any outlier are shown as a green connector. Residues present in the sample, but not in the model, are shown in grey.

- Molecule 1: 50S ribosomal protein L32

Chain 0:  95% 5%

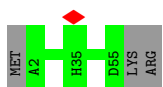

- Molecule 2: 50S ribosomal protein L33 2

Chain 1:  87% 13%



- Molecule 3: 50S ribosomal protein L34

Chain 2:  91% 6%



- Molecule 4: 50S ribosomal protein L35

Chain 3:  97%



- Molecule 5: 50S ribosomal protein L36

Chain 4:  97%



- Molecule 6: 50S ribosomal protein L31

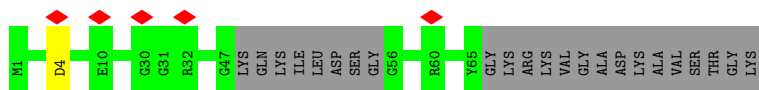

• Molecule 7: 50S ribosomal protein L37

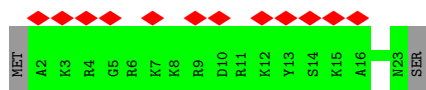
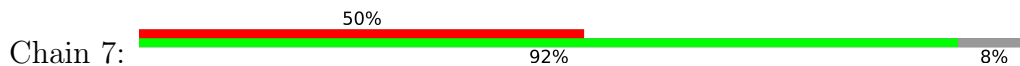

• Molecule 8: 50S ribosomal protein L1

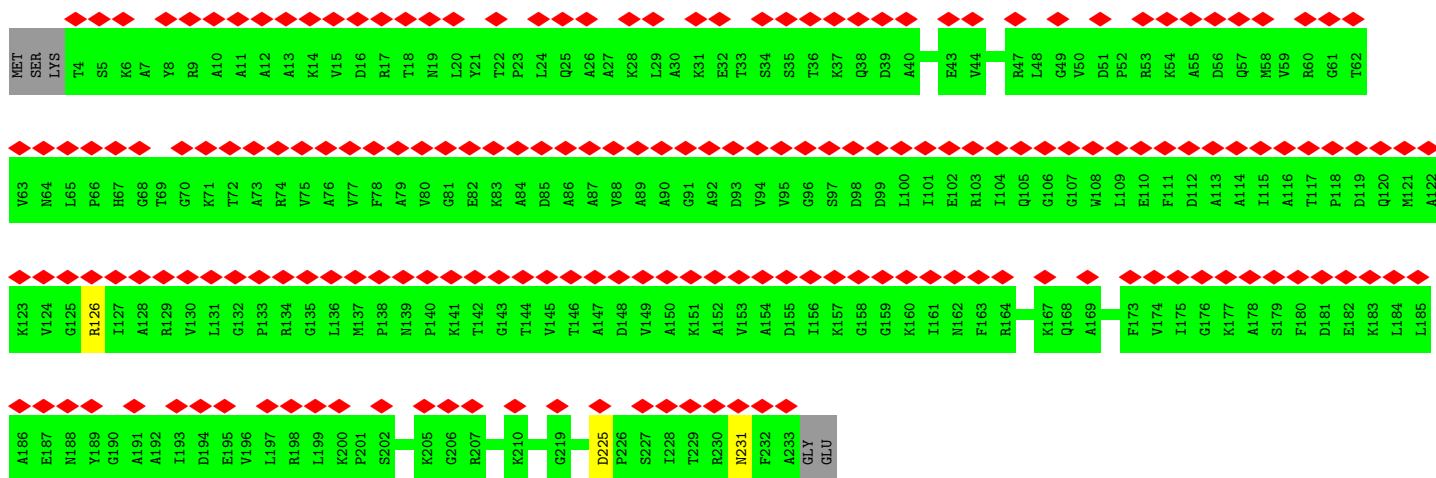
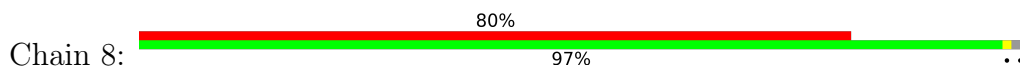

• Molecule 9: 23S rRNA

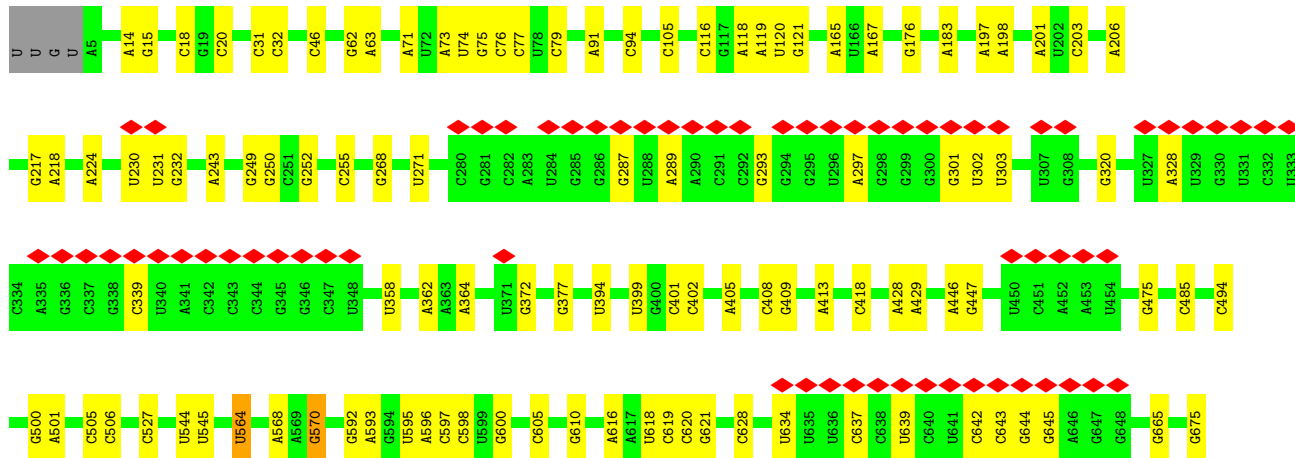
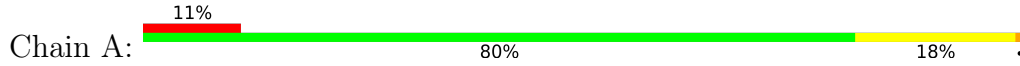

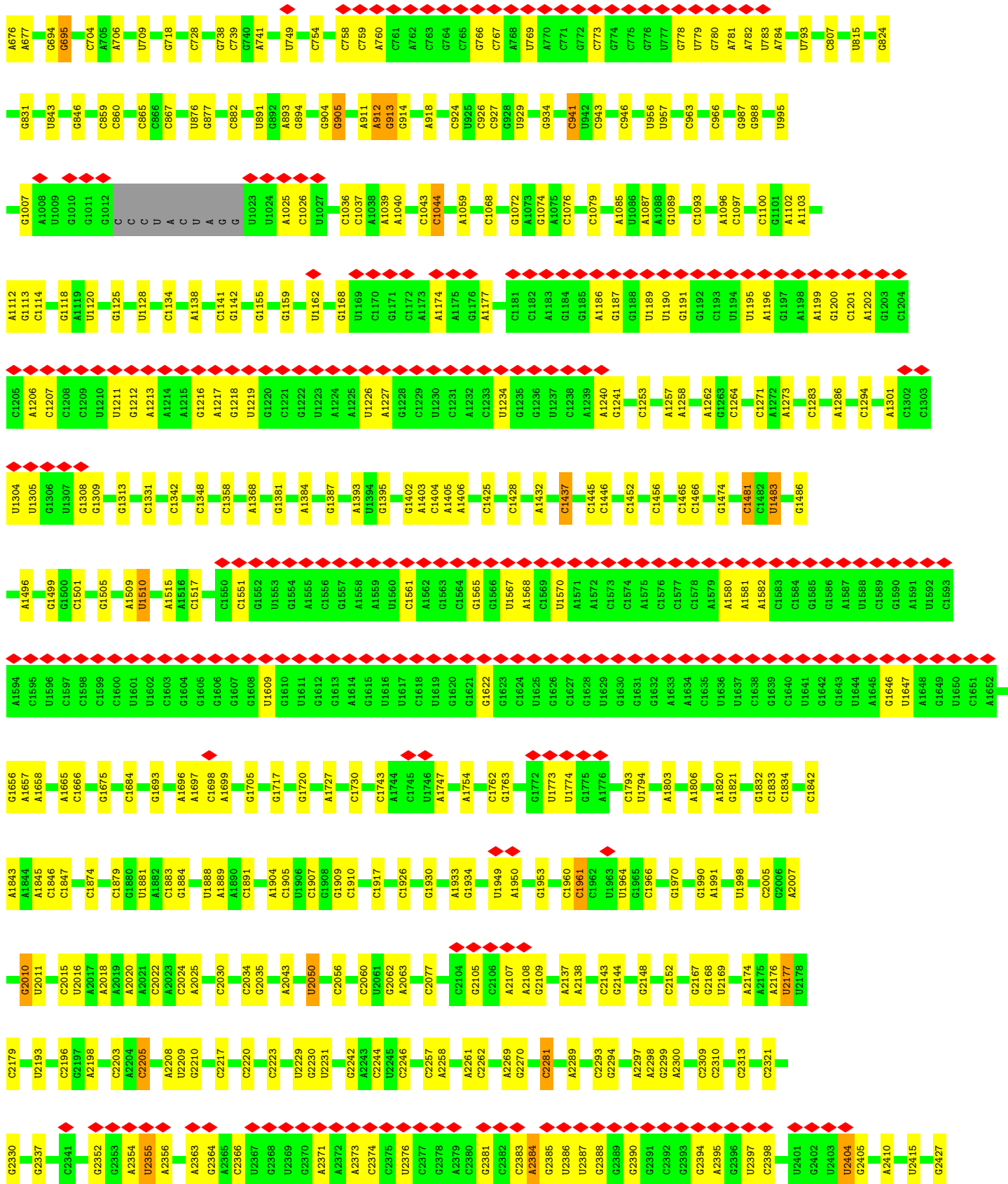

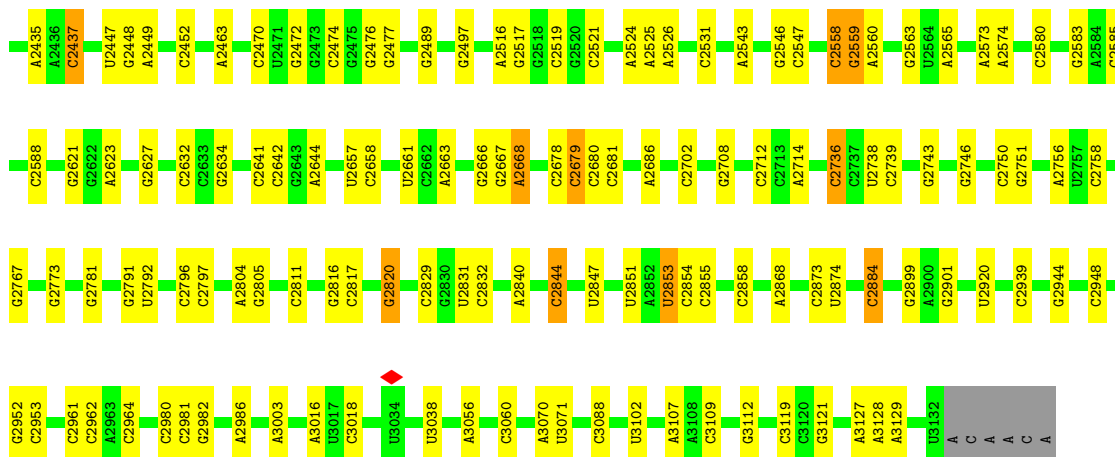

• Molecule 10: 5S rRNA

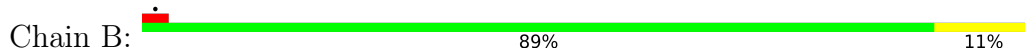

• Molecule 11: 50S ribosomal protein L2

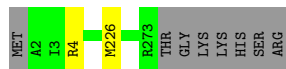

• Molecule 12: 50S ribosomal protein L3

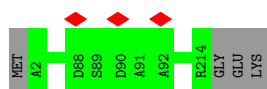

• Molecule 13: 50S ribosomal protein L4

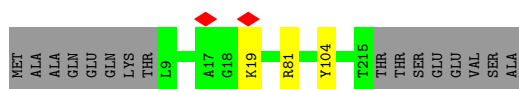

• Molecule 14: 50S ribosomal protein L5

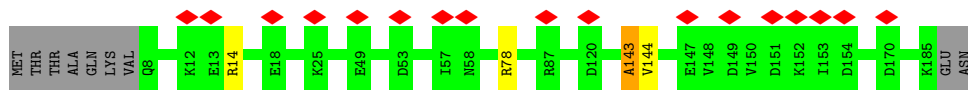

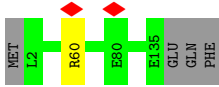

• Molecule 21: 50S ribosomal protein L17

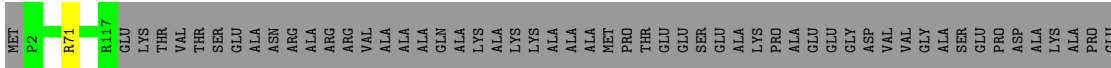

• Molecule 22: 50S ribosomal protein L18

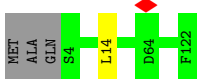

• Molecule 23: 50S ribosomal protein L19

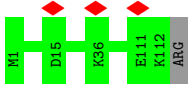

• Molecule 24: 50S ribosomal protein L20

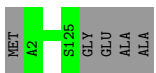

• Molecule 25: 50S ribosomal protein L21

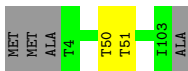

• Molecule 26: 50S ribosomal protein L22

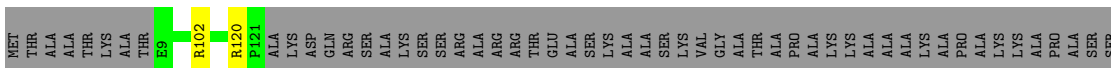

GLY
VAL
LYS
LYS
THR
PRO
PRO
ALA
LYS
LYS
ALA
PRO
PRO
ALA
LYS
LYS
ALA
PRO
PRO
ALA
LYS
LYS
LYS
SER
SER
GLU
THR
THR
SER
SER
ALA
ALA
LYS
LYS
GLY
GLY
SER
ASP

- Molecule 27: 50S ribosomal protein L23



MET
ALA
T9
R70
F96
G97
ALA
PRO
ALA

- Molecule 28: 50S ribosomal protein L24

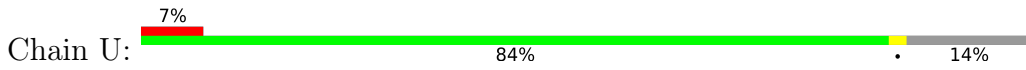

M1
D29
A46
ILE
SER
THR
THR
GLN
ARG
GLY
ALA
ARG
SER
GLY
GLY
ILE
VAL
T61
S76
D88
E89
E90
M101
G102
K103
D104
ILE

- Molecule 29: 50S ribosomal protein L25

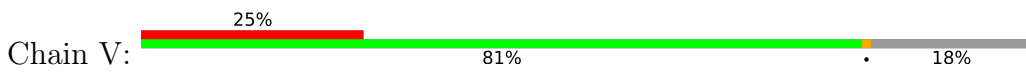

MET
ALA
LYS
SER
ALA
S6
R10
G39
R57
H58
D68
G71
K72
E73
R99
R100
G101
E102
K103
E113
G114
Q115
A116
G117
P118
D119
T120
L121
M127
S128
E132
A133
E134
A135
L136
S137
I138
Q141
L142
T143
V144
S145
I146
E147
G148
A149
E150
P151
G152
T153
G158
Q159
I160
A161
L162
P163
A164
G165
I169
S170
D171
P172
D173
K181
A182
PRO
THR
ALA
GLU
GLU
LEU
GLU
GLY
GLU
VAL
ALA
GLY
ALA
GLU
GLU
ALA
GLU
ALA
ALA
VAL
GLU
GLY
GLU
ALA
ALA
GLU
GLU
SER
GLU

- Molecule 30: 50S ribosomal protein L27

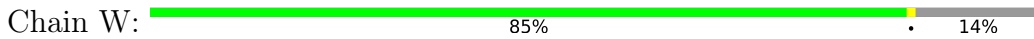

MET
ALA
HIS
LYS
GLY
ALA
SER
S9
R14
G82
SER
THR
ALA

- Molecule 31: 50S ribosomal protein L28



MET
R2
R27
R63
GLY

- Molecule 32: 50S ribosomal protein L29

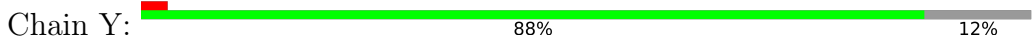

MET
ALA
VAL
GLY
V5
D15
A69
P72
ASP
GLY
LYS
GLU
SER

• Molecule 33: 50S ribosomal protein L30

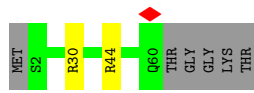
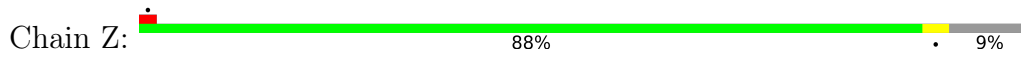

• Molecule 34: 16S rRNA

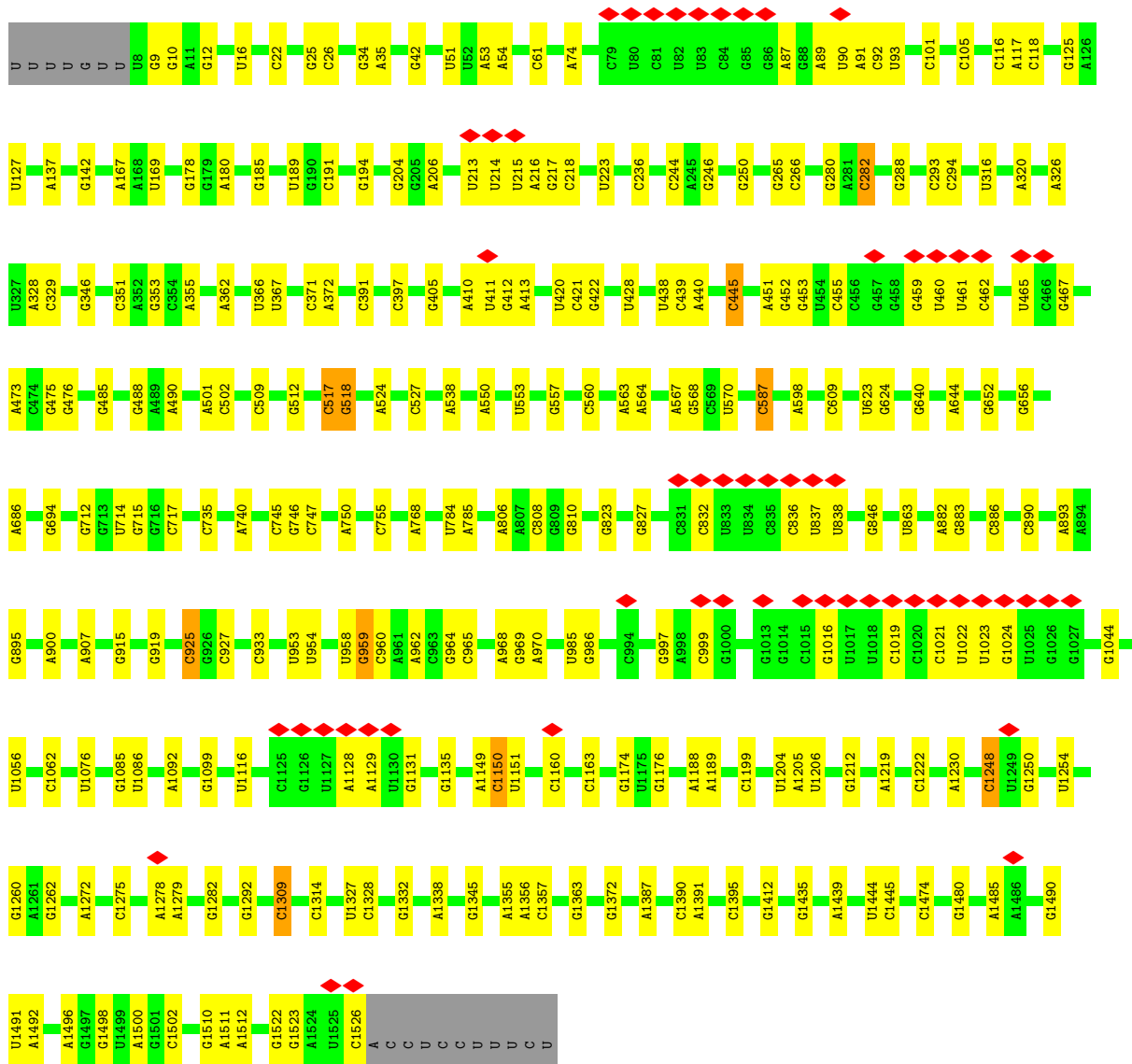
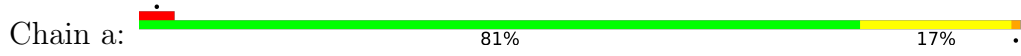

• Molecule 35: 30S ribosomal protein S3

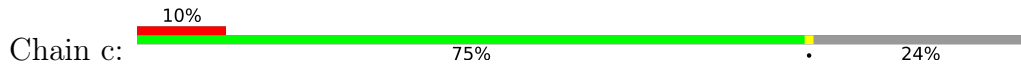

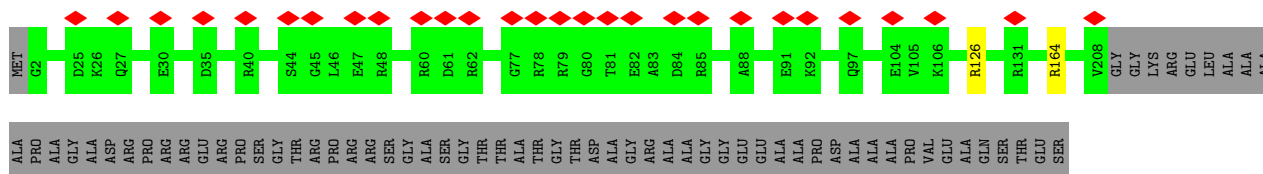

• Molecule 36: 30S ribosomal protein S4

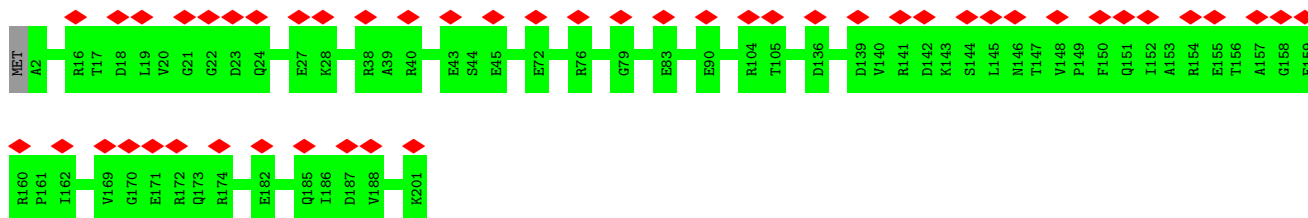

• Molecule 37: 30S ribosomal protein S5

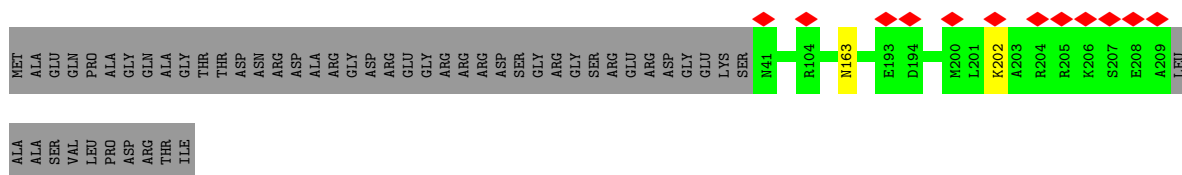
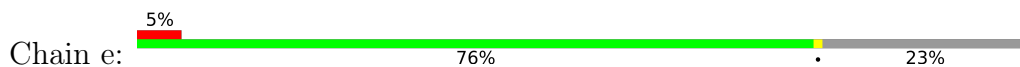

• Molecule 38: 30S ribosomal protein S6

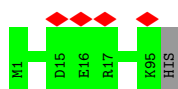

• Molecule 39: 30S ribosomal protein S7

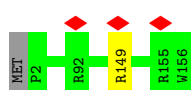

• Molecule 40: 30S ribosomal protein S8

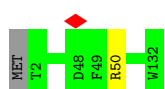

• Molecule 41: 30S ribosomal protein S9

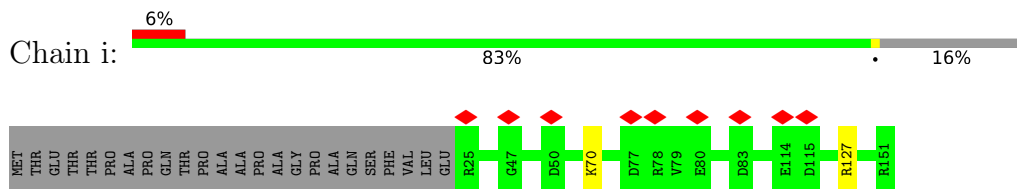

• Molecule 42: 30S ribosomal protein S10

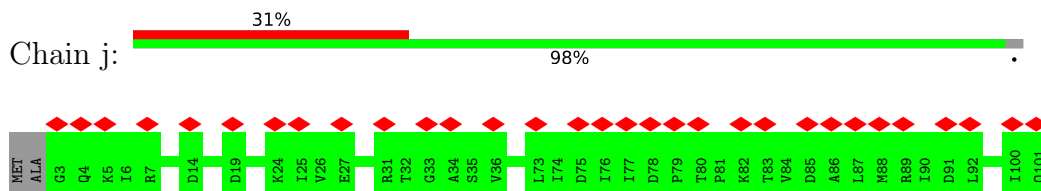

• Molecule 43: 30S ribosomal protein S11

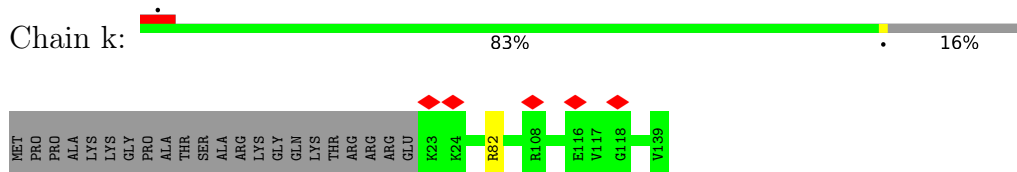

• Molecule 44: 30S ribosomal protein S12

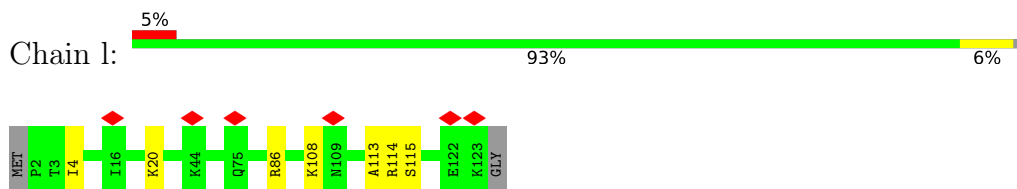

• Molecule 45: 30S ribosomal protein S13

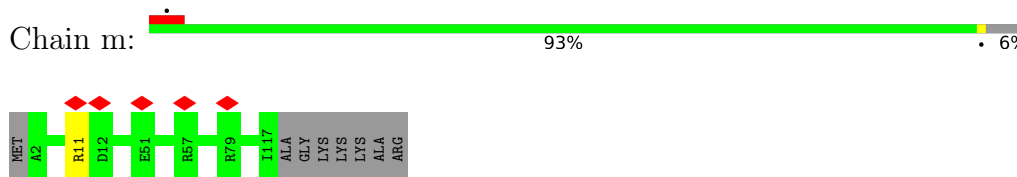

• Molecule 46: 30S ribosomal protein S14 type Z

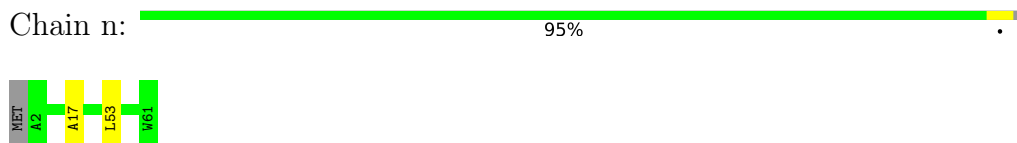

• Molecule 47: 30S ribosomal protein S15





- Molecule 48: 30S ribosomal protein S16

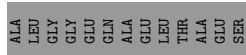
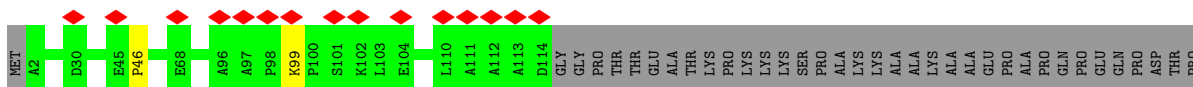

- Molecule 49: 30S ribosomal protein S17

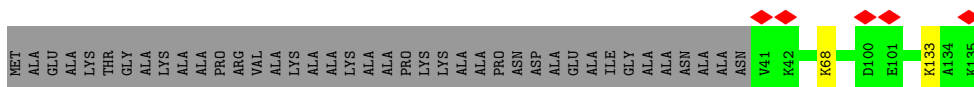

- Molecule 50: 30S ribosomal protein S18 1

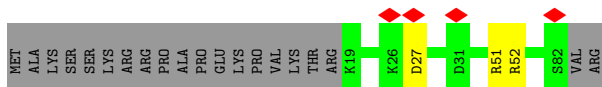

- Molecule 51: 30S ribosomal protein S19

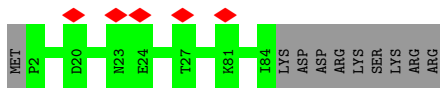
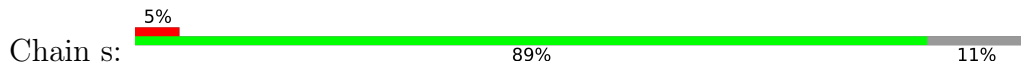

- Molecule 52: 30S ribosomal protein S20

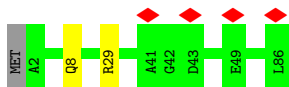

- Molecule 53: Energy-dependent translational throttle protein EttA



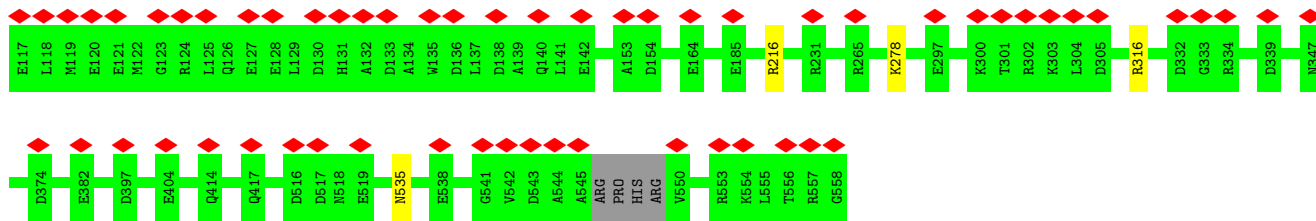

- Molecule 54: initiator tRNA (Met)



- Molecule 55: mRNA



4 Experimental information

Property	Value	Source
EM reconstruction method	SINGLE PARTICLE	Depositor
Imposed symmetry	POINT, Not provided	
Number of particles used	86692	Depositor
Resolution determination method	FSC 0.143 CUT-OFF	Depositor
CTF correction method	NONE	Depositor
Microscope	FEI TITAN KRIOS	Depositor
Voltage (kV)	300	Depositor
Electron dose ($e^-/\text{\AA}^2$)	48	Depositor
Minimum defocus (nm)	Not provided	
Maximum defocus (nm)	Not provided	
Magnification	Not provided	
Image detector	GATAN K2 SUMMIT (4k x 4k)	Depositor
Maximum map value	0.364	Depositor
Minimum map value	-0.005	Depositor
Average map value	0.001	Depositor
Map value standard deviation	0.012	Depositor
Recommended contour level	0.03	Depositor
Map size (\AA)	340.15997, 340.15997, 340.15997	wwPDB
Map dimensions	320, 320, 320	wwPDB
Map angles ($^\circ$)	90.0, 90.0, 90.0	wwPDB
Pixel spacing (\AA)	1.063, 1.063, 1.063	Depositor

5 Model quality i

5.1 Standard geometry i

Bond lengths and bond angles in the following residue types are not validated in this section: ZN, 5MU, FME, 4OC, 5MC, MA6, MG, VO4, UR3, G7M, 2MG, OMG, ADP

The Z score for a bond length (or angle) is the number of standard deviations the observed value is removed from the expected value. A bond length (or angle) with $|Z| > 5$ is considered an outlier worth inspection. RMSZ is the root-mean-square of all Z scores of the bond lengths (or angles).

Mol	Chain	Bond lengths		Bond angles	
		RMSZ	# Z >5	RMSZ	# Z >5
1	0	0.47	0/435	0.58	0/581
2	1	0.49	0/407	0.55	0/543
3	2	0.56	0/377	0.61	0/494
4	3	0.44	0/499	0.57	0/664
5	4	0.44	0/303	0.59	0/402
6	6	0.34	0/455	0.60	1/611 (0.2%)
7	7	0.26	0/188	0.49	0/243
8	8	0.27	0/1728	0.51	0/2339
9	A	1.05	4/74925 (0.0%)	1.08	287/116904 (0.2%)
10	B	0.75	0/2748	0.98	6/4280 (0.1%)
11	C	0.56	1/2129 (0.0%)	0.63	0/2861
12	D	0.51	0/1613	0.61	0/2174
13	E	0.47	0/1575	0.62	0/2129
14	F	0.39	0/1429	0.59	0/1921
15	G	0.31	0/1351	0.58	0/1824
16	H	0.28	0/353	0.61	0/474
17	J	0.52	0/1170	0.60	0/1584
18	K	0.54	0/951	0.64	0/1278
19	L	0.50	0/1088	0.64	0/1453
20	M	0.41	0/1098	0.57	0/1481
21	N	0.50	0/925	0.59	0/1242
22	O	0.42	0/914	0.61	1/1228 (0.1%)
23	P	0.51	0/922	0.60	0/1236
24	Q	0.58	0/1006	0.60	0/1349
25	R	0.53	0/766	0.60	0/1030
26	S	0.51	0/874	0.58	0/1186
27	T	0.46	0/751	0.62	0/1012
28	U	0.41	0/705	0.68	0/941
29	V	0.32	0/1336	0.61	0/1820
30	W	0.51	0/554	0.63	0/737
31	X	0.51	0/476	0.63	0/638
32	Y	0.39	0/564	0.55	0/756

Mol	Chain	Bond lengths		Bond angles	
		RMSZ	# Z >5	RMSZ	# Z >5
33	Z	0.44	0/480	0.59	0/645
34	a	0.88	0/36331	0.99	67/56686 (0.1%)
35	c	0.36	0/1678	0.54	0/2254
36	d	0.32	0/1683	0.53	0/2269
37	e	0.41	0/1238	0.56	0/1673
38	f	0.39	0/767	0.56	0/1036
39	g	0.37	0/1250	0.56	0/1686
40	h	0.44	0/1021	0.59	0/1379
41	i	0.36	0/1010	0.60	0/1356
42	j	0.38	0/803	0.63	0/1086
43	k	0.39	0/891	0.55	0/1204
44	l	0.45	0/970	0.65	0/1295
45	m	0.35	0/953	0.61	0/1274
46	n	0.44	0/477	0.62	1/634 (0.2%)
47	o	0.40	0/727	0.58	0/973
48	p	0.36	0/901	0.62	0/1217
49	q	0.38	0/782	0.64	0/1045
50	r	0.40	0/511	0.64	1/685 (0.1%)
51	s	0.35	0/690	0.54	0/928
52	t	0.31	0/654	0.48	0/867
53	x	0.34	0/4390	0.54	0/5942
54	y	0.78	1/1836 (0.1%)	1.12	16/2859 (0.6%)
55	z	0.93	0/166	1.26	2/256 (0.8%)
All	All	0.86	6/164824 (0.0%)	0.95	382/246664 (0.2%)

Chiral center outliers are detected by calculating the chiral volume of a chiral center and verifying if the center is modelled as a planar moiety or with the opposite hand. A planarity outlier is detected by checking planarity of atoms in a peptide group, atoms in a mainchain group or atoms of a sidechain that are expected to be planar.

Mol	Chain	#Chirality outliers	#Planarity outliers
8	8	0	1
14	F	0	1
25	R	0	1
28	U	0	1
29	V	0	2
44	l	0	2
53	x	0	1
All	All	0	9

All (6) bond length outliers are listed below:

Mol	Chain	Res	Type	Atoms	Z	Observed(Å)	Ideal(Å)
54	y	1	C	OP3-P	-10.61	1.48	1.61
11	C	226	MET	C-N	-7.50	1.16	1.34
9	A	616	A	N9-C4	-7.12	1.33	1.37
9	A	2668	A	N9-C4	-6.71	1.33	1.37
9	A	2025	A	N9-C4	-5.25	1.34	1.37
9	A	2309	C	N3-C4	-5.08	1.30	1.33

All (382) bond angle outliers are listed below:

Mol	Chain	Res	Type	Atoms	Z	Observed(°)	Ideal(°)
54	y	17	C	N1-C2-O2	13.07	126.74	118.90
54	y	17	C	C2-N1-C1'	12.05	132.06	118.80
9	A	3060	C	N3-C2-O2	-10.76	114.37	121.90
9	A	3060	C	N1-C2-O2	10.55	125.23	118.90
9	A	739	C	C2-N1-C1'	10.22	130.04	118.80
9	A	2374	C	N1-C2-O2	9.95	124.87	118.90
54	y	17	C	N3-C2-O2	-9.80	115.04	121.90
9	A	2558	C	N1-C2-O2	9.65	124.69	118.90
9	A	2217	C	C2-N1-C1'	9.50	129.25	118.80
9	A	2374	C	C2-N1-C1'	9.21	128.93	118.80
9	A	946	C	N3-C2-O2	-9.20	115.46	121.90
9	A	882	C	N3-C2-O2	-9.18	115.47	121.90
9	A	2217	C	N1-C2-O2	9.18	124.41	118.90
9	A	2309	C	C2-N1-C1'	9.13	128.84	118.80
9	A	2961	C	C6-N1-C2	-9.07	116.67	120.30
9	A	739	C	N3-C2-O2	-8.98	115.61	121.90
9	A	2217	C	N3-C2-O2	-8.88	115.69	121.90
54	y	17	C	C6-N1-C1'	-8.69	110.38	120.80
9	A	946	C	N1-C2-O2	8.68	124.11	118.90
9	A	3060	C	C2-N1-C1'	8.68	128.35	118.80
9	A	946	C	C2-N1-C1'	8.66	128.33	118.80
9	A	739	C	N1-C2-O2	8.53	124.02	118.90
9	A	1833	C	C6-N1-C2	-8.52	116.89	120.30
9	A	2558	C	N3-C2-O2	-8.37	116.05	121.90
9	A	1833	C	C5-C6-N1	8.28	125.14	121.00
9	A	2844	C	C6-N1-C2	-8.20	117.02	120.30
9	A	1517	C	N1-C2-O2	8.14	123.78	118.90
9	A	2281	C	C6-N1-C2	-8.07	117.07	120.30
9	A	882	C	N1-C2-O2	8.02	123.72	118.90
34	a	223	U	C2-N1-C1'	8.00	127.29	117.70
9	A	2953	C	C6-N1-C2	-7.80	117.18	120.30
9	A	2374	C	N3-C2-O2	-7.75	116.47	121.90
9	A	600	G	O4'-C1'-N9	7.75	114.40	108.20

Continued on next page...

Continued from previous page...

Mol	Chain	Res	Type	Atoms	Z	Observed(°)	Ideal(°)
9	A	2281	C	C5-C6-N1	7.68	124.84	121.00
34	a	1254	U	C2-N1-C1'	7.67	126.90	117.70
9	A	3060	C	C6-N1-C2	-7.61	117.26	120.30
9	A	616	A	C2-N3-C4	-7.59	106.81	110.60
9	A	2558	C	C2-N1-C1'	7.55	127.10	118.80
9	A	739	C	C6-N1-C2	-7.54	117.28	120.30
9	A	882	C	C2-N1-C1'	7.52	127.07	118.80
9	A	1953	G	N3-C2-N2	-7.44	114.69	119.90
9	A	1093	C	C6-N1-C2	-7.43	117.33	120.30
9	A	2309	C	N3-C2-O2	-7.40	116.72	121.90
9	A	1517	C	N3-C2-O2	-7.40	116.72	121.90
34	a	1498	G	C4-N9-C1'	7.38	136.09	126.50
34	a	223	U	N3-C2-O2	-7.36	117.05	122.20
10	B	82	C	C6-N1-C2	-7.33	117.37	120.30
9	A	807	C	C6-N1-C2	-7.27	117.39	120.30
9	A	865	C	C6-N1-C2	-7.25	117.40	120.30
9	A	1120	U	C5-C6-N1	7.22	126.31	122.70
9	A	1684	C	C6-N1-C2	-7.21	117.42	120.30
34	a	223	U	N1-C2-O2	7.20	127.84	122.80
9	A	1072	G	C4-N9-C1'	7.20	135.85	126.50
9	A	1517	C	C2-N1-C1'	7.19	126.71	118.80
34	a	1248	C	N1-C2-O2	7.19	123.21	118.90
9	A	1834	C	C6-N1-C2	-7.05	117.48	120.30
9	A	2217	C	C6-N1-C1'	-7.04	112.35	120.80
34	a	517	C	O4'-C1'-N1	7.01	113.81	108.20
9	A	1905	C	N1-C2-O2	7.00	123.10	118.90
9	A	2953	C	C5-C6-N1	6.97	124.48	121.00
9	A	2398	C	C2-N1-C1'	6.90	126.39	118.80
9	A	1425	C	C6-N1-C2	-6.89	117.54	120.30
9	A	1072	G	C8-N9-C1'	-6.88	118.06	127.00
54	y	17	C	C6-N1-C2	-6.87	117.55	120.30
9	A	704	C	C6-N1-C2	-6.87	117.55	120.30
34	a	560	C	C6-N1-C2	-6.87	117.55	120.30
9	A	429	A	N7-C8-N9	6.82	117.21	113.80
9	A	739	C	C6-N1-C1'	-6.79	112.65	120.80
9	A	2832	C	C6-N1-C2	-6.77	117.59	120.30
9	A	2844	C	C5-C6-N1	6.77	124.39	121.00
9	A	527	C	N1-C2-O2	6.72	122.93	118.90
9	A	2022	C	N1-C2-O2	6.70	122.92	118.90
34	a	527	C	C6-N1-C2	-6.68	117.63	120.30
34	a	1498	G	N3-C4-C5	-6.64	125.28	128.60
9	A	2559	G	C4-N9-C1'	6.62	135.10	126.50

Continued on next page...

Continued from previous page...

Mol	Chain	Res	Type	Atoms	Z	Observed(°)	Ideal(°)
9	A	2831	U	C5-C6-N1	6.57	125.99	122.70
34	a	1254	U	N3-C2-O2	-6.57	117.60	122.20
34	a	965	C	C6-N1-C2	-6.57	117.67	120.30
34	a	933	C	C6-N1-C2	-6.52	117.69	120.30
9	A	2829	C	C6-N1-C2	-6.50	117.70	120.30
9	A	695	G	C4-N9-C1'	6.50	134.95	126.50
34	a	886	C	C6-N1-C2	-6.50	117.70	120.30
9	A	2309	C	C6-N1-C1'	-6.49	113.01	120.80
9	A	2309	C	N1-C2-O2	6.49	122.80	118.90
9	A	2681	C	N1-C2-O2	6.49	122.80	118.90
9	A	2681	C	N3-C2-O2	-6.47	117.37	121.90
34	a	1498	G	N3-C4-N9	6.46	129.88	126.00
9	A	527	C	C6-N1-C2	-6.45	117.72	120.30
9	A	2558	C	C6-N1-C2	-6.44	117.72	120.30
9	A	1128	U	N1-C2-O2	6.44	127.31	122.80
9	A	926	C	C5-C6-N1	6.43	124.22	121.00
54	y	17	C	C5-C6-N1	6.42	124.21	121.00
9	A	2374	C	C6-N1-C1'	-6.42	113.09	120.80
9	A	616	A	N3-C4-N9	-6.41	122.27	127.40
9	A	1833	C	C2-N1-C1'	6.40	125.84	118.80
9	A	2736	C	N1-C2-O2	6.40	122.74	118.90
9	A	2398	C	N1-C2-O2	6.39	122.74	118.90
9	A	2205	C	N3-C2-O2	-6.38	117.43	121.90
9	A	2437	C	C6-N1-C2	-6.36	117.76	120.30
34	a	22	C	C6-N1-C2	-6.36	117.76	120.30
9	A	966	C	C5-C6-N1	6.34	124.17	121.00
34	a	293	C	C5-C6-N1	6.34	124.17	121.00
34	a	1150	C	C2-N1-C1'	6.32	125.75	118.80
9	A	1076	C	C6-N1-C2	-6.32	117.77	120.30
9	A	506	C	C6-N1-C2	-6.29	117.78	120.30
34	a	1254	U	N1-C2-O2	6.29	127.20	122.80
34	a	1248	C	C2-N1-C1'	6.28	125.71	118.80
9	A	1348	C	C6-N1-C2	-6.25	117.80	120.30
9	A	877	G	O4'-C1'-N9	6.25	113.20	108.20
9	A	1093	C	N1-C2-O2	6.25	122.65	118.90
9	A	20	C	C6-N1-C2	-6.24	117.81	120.30
9	A	1428	C	C6-N1-C2	-6.24	117.81	120.30
9	A	1481	C	N1-C2-O2	6.23	122.64	118.90
9	A	1113	G	N3-C4-C5	-6.23	125.49	128.60
9	A	2005	C	C6-N1-C2	-6.22	117.81	120.30
9	A	2980	C	C6-N1-C2	-6.21	117.82	120.30
55	z	3	C	P-O3'-C3'	6.20	127.14	119.70

Continued on next page...

Continued from previous page...

Mol	Chain	Res	Type	Atoms	Z	Observed(°)	Ideal(°)
34	a	925	C	N1-C2-O2	6.20	122.62	118.90
54	y	3	C	N1-C2-O2	6.19	122.61	118.90
9	A	946	C	C6-N1-C1'	-6.19	113.37	120.80
9	A	2948	C	C6-N1-C2	-6.19	117.83	120.30
9	A	2262	C	C6-N1-C2	-6.18	117.83	120.30
9	A	46	C	C6-N1-C2	-6.16	117.83	120.30
54	y	35	C	C2-N1-C1'	6.16	125.57	118.80
34	a	1199	C	N1-C2-O2	6.14	122.58	118.90
9	A	628	C	C6-N1-C2	-6.13	117.85	120.30
9	A	966	C	C6-N1-C2	-6.12	117.85	120.30
9	A	2853	U	N1-C2-O2	6.11	127.07	122.80
9	A	2355	U	P-O3'-C3'	6.10	127.03	119.70
9	A	963	C	C6-N1-C2	-6.10	117.86	120.30
9	A	1437	C	C6-N1-C2	-6.10	117.86	120.30
9	A	1917	C	C6-N1-C2	-6.10	117.86	120.30
9	A	1134	C	C6-N1-C2	-6.09	117.86	120.30
9	A	2750	C	C6-N1-C2	-6.09	117.86	120.30
54	y	35	C	N1-C2-O2	6.08	122.55	118.90
9	A	754	C	C6-N1-C2	-6.06	117.88	120.30
9	A	564	U	C5-C6-N1	6.03	125.72	122.70
34	a	755	C	C6-N1-C2	-6.03	117.89	120.30
9	A	2404	U	C2-N1-C1'	6.03	124.93	117.70
9	A	616	A	C8-N9-C4	-6.00	103.40	105.80
34	a	206	A	N7-C8-N9	5.99	116.79	113.80
9	A	1044	C	N1-C2-O2	5.98	122.49	118.90
9	A	1294	C	C6-N1-C2	-5.98	117.91	120.30
9	A	2559	G	C8-N9-C1'	-5.97	119.24	127.00
9	A	2817	C	C6-N1-C2	-5.97	117.91	120.30
10	B	82	C	C5-C6-N1	5.95	123.97	121.00
34	a	282	C	C6-N1-C2	-5.95	117.92	120.30
34	a	735	C	C6-N1-C2	-5.94	117.92	120.30
34	a	282	C	N1-C2-O2	5.93	122.46	118.90
46	n	53	LEU	CA-CB-CG	5.93	128.94	115.30
34	a	1498	G	C6-C5-N7	-5.92	126.85	130.40
9	A	2702	C	C6-N1-C2	-5.91	117.94	120.30
9	A	860	C	C6-N1-C2	-5.90	117.94	120.30
9	A	1093	C	C5-C6-N1	5.89	123.95	121.00
9	A	2205	C	N1-C2-O2	5.89	122.44	118.90
9	A	2758	C	C6-N1-C2	-5.89	117.94	120.30
9	A	418	C	N1-C2-O2	5.89	122.43	118.90
34	a	745	C	C2-N1-C1'	5.89	125.27	118.80
9	A	2641	C	N1-C2-O2	5.88	122.43	118.90

Continued on next page...

Continued from previous page...

Mol	Chain	Res	Type	Atoms	Z	Observed(°)	Ideal(°)
9	A	1926	C	C6-N1-C2	-5.88	117.95	120.30
9	A	2169	U	C2-N1-C1'	5.87	124.74	117.70
9	A	1128	U	N3-C2-O2	-5.86	118.10	122.20
9	A	2374	C	C6-N1-C2	-5.81	117.98	120.30
9	A	2030	C	C6-N1-C2	-5.81	117.98	120.30
10	B	64	C	N1-C2-O2	5.81	122.39	118.90
34	a	26	C	C6-N1-C2	-5.81	117.98	120.30
9	A	1874	C	N1-C2-O2	5.80	122.38	118.90
9	A	865	C	C5-C6-N1	5.79	123.90	121.00
9	A	2022	C	C6-N1-C2	-5.78	117.99	120.30
9	A	1834	C	C5-C6-N1	5.78	123.89	121.00
9	A	2679	C	N1-C2-O2	5.78	122.37	118.90
9	A	570	G	O4'-C1'-N9	5.78	112.82	108.20
9	A	2179	C	N1-C2-O2	5.77	122.36	118.90
34	a	1150	C	N1-C2-O2	5.77	122.36	118.90
34	a	26	C	C5-C6-N1	5.77	123.88	121.00
9	A	1113	G	C8-N9-C4	-5.76	104.10	106.40
10	B	82	C	C2-N1-C1'	5.76	125.13	118.80
9	A	2681	C	C6-N1-C2	-5.75	118.00	120.30
9	A	1283	C	N1-C2-O2	5.74	122.34	118.90
9	A	1097	C	C6-N1-C2	-5.74	118.00	120.30
34	a	1498	G	C8-N9-C1'	-5.74	119.54	127.00
9	A	2223	C	C6-N1-C2	-5.74	118.00	120.30
34	a	118	C	C6-N1-C2	-5.72	118.01	120.30
9	A	429	A	C8-N9-C4	-5.72	103.51	105.80
9	A	1114	C	N1-C2-O2	5.71	122.33	118.90
9	A	2739	C	C6-N1-C2	-5.70	118.02	120.30
9	A	2384	A	P-O3'-C3'	5.70	126.54	119.70
34	a	1248	C	N3-C2-O2	-5.69	117.92	121.90
9	A	1446	C	C6-N1-C2	-5.68	118.03	120.30
9	A	2854	C	C6-N1-C2	-5.68	118.03	120.30
9	A	912	A	N7-C8-N9	5.67	116.63	113.80
34	a	1498	G	C8-N9-C4	-5.66	104.14	106.40
9	A	2022	C	N3-C2-O2	-5.65	117.94	121.90
9	A	616	A	N3-C4-C5	5.65	130.75	126.80
9	A	2474	C	C6-N1-C2	-5.63	118.05	120.30
9	A	1905	C	N3-C2-O2	-5.63	117.96	121.90
9	A	616	A	C5-N7-C8	-5.62	101.09	103.90
9	A	628	C	C5-C6-N1	5.62	123.81	121.00
9	A	2855	C	N3-C2-O2	-5.62	117.97	121.90
9	A	1093	C	N3-C2-O2	-5.61	117.97	121.90
9	A	1331	C	C6-N1-C2	-5.61	118.06	120.30

Continued on next page...

Continued from previous page...

Mol	Chain	Res	Type	Atoms	Z	Observed(°)	Ideal(°)
9	A	2437	C	C5-C6-N1	5.61	123.81	121.00
9	A	1425	C	C5-C6-N1	5.61	123.80	121.00
34	a	223	U	C6-N1-C1'	-5.61	113.35	121.20
9	A	2011	U	N1-C2-O2	5.60	126.72	122.80
9	A	2220	C	C6-N1-C2	-5.59	118.06	120.30
9	A	867	C	C6-N1-C2	-5.59	118.06	120.30
9	A	1904	A	C4-N9-C1'	5.58	136.35	126.30
9	A	116	C	N3-C2-O2	-5.58	118.00	121.90
54	y	35	C	C6-N1-C2	-5.58	118.07	120.30
9	A	564	U	C2-N1-C1'	5.57	124.39	117.70
9	A	2873	C	C6-N1-C2	-5.57	118.07	120.30
9	A	418	C	C6-N1-C2	-5.56	118.08	120.30
34	a	439	C	N1-C2-O2	5.55	122.23	118.90
34	a	717	C	C6-N1-C2	-5.55	118.08	120.30
9	A	2452	C	C6-N1-C2	-5.54	118.08	120.30
9	A	77	C	C6-N1-C2	-5.53	118.09	120.30
34	a	925	C	C2-N1-C1'	5.53	124.89	118.80
9	A	913	G	P-O3'-C3'	5.52	126.33	119.70
34	a	925	C	C6-N1-C2	-5.52	118.09	120.30
50	r	27	ASP	CB-CG-OD1	5.52	123.27	118.30
9	A	2010	G	C4-N9-C1'	5.52	133.67	126.50
34	a	890	C	C6-N1-C2	-5.51	118.09	120.30
9	A	2641	C	C6-N1-C2	-5.50	118.10	120.30
9	A	2257	C	N1-C2-O2	5.50	122.20	118.90
9	A	31	C	C6-N1-C2	-5.50	118.10	120.30
9	A	2855	C	N1-C2-O2	5.50	122.20	118.90
9	A	1953	G	N3-C4-N9	-5.50	122.70	126.00
9	A	527	C	N3-C2-O2	-5.49	118.05	121.90
9	A	605	C	C6-N1-C2	-5.49	118.10	120.30
9	A	485	C	C6-N1-C2	-5.49	118.10	120.30
9	A	867	C	N1-C2-O2	5.49	122.19	118.90
9	A	2448	G	C4-N9-C1'	5.49	133.63	126.50
9	A	598	C	C6-N1-C2	-5.48	118.11	120.30
9	A	1793	C	N1-C2-O2	5.47	122.18	118.90
34	a	294	C	C6-N1-C2	-5.47	118.11	120.30
34	a	1502	C	C6-N1-C2	-5.47	118.11	120.30
9	A	2309	C	C6-N1-C2	-5.47	118.11	120.30
34	a	587	C	C6-N1-C2	-5.46	118.12	120.30
9	A	912	A	C4-N9-C1'	5.46	136.12	126.30
9	A	2196	C	C6-N1-C2	-5.45	118.12	120.30
9	A	429	A	C5-N7-C8	-5.45	101.17	103.90
9	A	1358	C	C6-N1-C2	-5.45	118.12	120.30

Continued on next page...

Continued from previous page...

Mol	Chain	Res	Type	Atoms	Z	Observed(°)	Ideal(°)
9	A	1846	C	C6-N1-C2	-5.45	118.12	120.30
54	y	41	C	C6-N1-C2	-5.43	118.13	120.30
9	A	1891	C	C6-N1-C2	-5.43	118.13	120.30
9	A	2981	C	C6-N1-C2	-5.42	118.13	120.30
9	A	271	U	N1-C2-O2	5.41	126.58	122.80
34	a	1309	C	N1-C2-O2	5.40	122.14	118.90
9	A	255	C	C6-N1-C2	-5.39	118.14	120.30
9	A	2244	C	C5-C6-N1	5.39	123.70	121.00
9	A	1134	C	C5-C6-N1	5.39	123.70	121.00
9	A	1847	C	C6-N1-C2	-5.39	118.14	120.30
34	a	958	U	N3-C2-O2	-5.39	118.43	122.20
22	O	14	LEU	CA-CB-CG	5.39	127.69	115.30
9	A	1960	C	N1-C2-O2	5.38	122.13	118.90
9	A	1466	C	C6-N1-C2	-5.38	118.15	120.30
9	A	1100	C	N1-C2-O2	5.38	122.13	118.90
9	A	1068	C	C5-C6-N1	5.38	123.69	121.00
9	A	105	C	C5-C6-N1	5.37	123.69	121.00
9	A	418	C	N3-C2-O2	-5.37	118.14	121.90
9	A	1961	C	N1-C2-O2	5.37	122.12	118.90
34	a	282	C	C5-C6-N1	5.37	123.68	121.00
9	A	3060	C	C6-N1-C1'	-5.36	114.36	120.80
54	y	4	G	O4'-C1'-N9	5.36	112.49	108.20
9	A	2205	C	C6-N1-C2	-5.36	118.16	120.30
9	A	527	C	C5-C6-N1	5.36	123.68	121.00
9	A	1481	C	N3-C2-O2	-5.36	118.15	121.90
9	A	408	C	C6-N1-C2	-5.34	118.16	120.30
9	A	1474	G	C4-N9-C1'	5.34	133.44	126.50
9	A	32	C	C6-N1-C2	-5.34	118.17	120.30
9	A	2398	C	N3-C2-O2	-5.33	118.17	121.90
9	A	2820	G	N3-C4-N9	5.33	129.20	126.00
10	B	81	C	C6-N1-C2	-5.33	118.17	120.30
9	A	1874	C	N3-C2-O2	-5.33	118.17	121.90
9	A	2632	C	C6-N1-C2	-5.32	118.17	120.30
54	y	35	C	N3-C2-O2	-5.32	118.17	121.90
9	A	616	A	C5-C6-N1	-5.32	115.04	117.70
9	A	2077	C	C6-N1-C2	-5.31	118.17	120.30
9	A	2470	C	C6-N1-C2	-5.31	118.17	120.30
34	a	105	C	C6-N1-C2	-5.31	118.18	120.30
9	A	1079	C	C6-N1-C2	-5.31	118.18	120.30
9	A	1874	C	C6-N1-C2	-5.31	118.18	120.30
9	A	2796	C	C6-N1-C2	-5.30	118.18	120.30
9	A	1072	G	N3-C4-N9	5.30	129.18	126.00

Continued on next page...

Continued from previous page...

Mol	Chain	Res	Type	Atoms	Z	Observed(°)	Ideal(°)
9	A	2580	C	C6-N1-C2	-5.30	118.18	120.30
9	A	402	C	C6-N1-C2	-5.29	118.18	120.30
9	A	1428	C	C5-C6-N1	5.29	123.64	121.00
34	a	735	C	C5-C6-N1	5.29	123.64	121.00
9	A	2310	C	C6-N1-C2	-5.28	118.19	120.30
9	A	2011	U	N3-C2-O2	-5.28	118.50	122.20
34	a	206	A	C8-N9-C4	-5.28	103.69	105.80
54	y	42	C	C6-N1-C2	-5.27	118.19	120.30
9	A	1425	C	N1-C2-O2	5.26	122.05	118.90
9	A	506	C	C5-C6-N1	5.25	123.63	121.00
6	6	4	ASP	CB-CG-OD1	5.25	123.03	118.30
34	a	101	C	C6-N1-C2	-5.25	118.20	120.30
9	A	739	C	O4'-C1'-N1	5.25	112.40	108.20
9	A	941	C	C6-N1-C2	-5.24	118.20	120.30
9	A	2321	C	C6-N1-C2	-5.24	118.20	120.30
34	a	218	C	C6-N1-C2	-5.24	118.21	120.30
10	B	82	C	N1-C2-O2	5.23	122.04	118.90
34	a	1062	C	N1-C2-O2	5.23	122.04	118.90
9	A	2884	C	C6-N1-C2	-5.22	118.21	120.30
9	A	2056	C	C6-N1-C2	-5.22	118.21	120.30
9	A	2519	C	C6-N1-C2	-5.21	118.22	120.30
9	A	1445	C	C6-N1-C2	-5.21	118.22	120.30
34	a	445	C	C6-N1-C2	-5.20	118.22	120.30
9	A	1037	C	N3-C2-O2	-5.20	118.26	121.90
9	A	927	C	C6-N1-C2	-5.20	118.22	120.30
9	A	2797	C	C6-N1-C2	-5.20	118.22	120.30
9	A	1068	C	C6-N1-C2	-5.19	118.22	120.30
9	A	271	U	N3-C2-O2	-5.19	118.57	122.20
9	A	1960	C	N3-C2-O2	-5.19	118.27	121.90
9	A	2739	C	C5-C6-N1	5.19	123.59	121.00
9	A	695	G	C8-N9-C1'	-5.18	120.26	127.00
9	A	2143	C	N1-C2-O2	5.18	122.01	118.90
9	A	1037	C	N1-C2-O2	5.18	122.01	118.90
9	A	568	A	OP1-P-O3'	5.18	116.59	105.20
9	A	1917	C	C5-C6-N1	5.17	123.59	121.00
9	A	2642	C	C6-N1-C2	-5.17	118.23	120.30
9	A	1113	G	C4-N9-C1'	5.17	133.22	126.50
34	a	1222	C	C6-N1-C2	-5.17	118.23	120.30
34	a	1275	C	C6-N1-C2	-5.17	118.23	120.30
34	a	1498	G	N7-C8-N9	5.17	115.69	113.10
9	A	2246	C	C6-N1-C2	-5.17	118.23	120.30
9	A	2024	C	C6-N1-C2	-5.16	118.24	120.30

Continued on next page...

Continued from previous page...

Mol	Chain	Res	Type	Atoms	Z	Observed(°)	Ideal(°)
9	A	3088	C	C6-N1-C2	-5.16	118.24	120.30
9	A	1793	C	N3-C2-O2	-5.16	118.29	121.90
9	A	2939	C	C6-N1-C2	-5.16	118.24	120.30
54	y	76	C	C6-N1-C2	-5.15	118.24	120.30
9	A	2374	C	C5-C6-N1	5.15	123.58	121.00
9	A	924	C	C6-N1-C2	-5.14	118.24	120.30
9	A	3109	C	C6-N1-C2	-5.14	118.24	120.30
9	A	46	C	C5-C6-N1	5.13	123.57	121.00
9	A	882	C	C6-N1-C1'	-5.13	114.64	120.80
34	a	747	C	C6-N1-C2	-5.13	118.25	120.30
9	A	2658	C	C6-N1-C2	-5.12	118.25	120.30
9	A	1043	C	C6-N1-C2	-5.12	118.25	120.30
9	A	2050	U	N1-C2-O2	5.12	126.38	122.80
9	A	1847	C	C5-C6-N1	5.11	123.56	121.00
9	A	769	U	C2-N1-C1'	5.11	123.83	117.70
9	A	1483	U	N3-C2-O2	-5.10	118.63	122.20
34	a	236	C	C6-N1-C2	-5.10	118.26	120.30
9	A	79	C	C6-N1-C2	-5.09	118.26	120.30
34	a	22	C	C5-C6-N1	5.09	123.55	121.00
9	A	1465	C	C6-N1-C2	-5.09	118.27	120.30
34	a	1150	C	N3-C2-O2	-5.08	118.34	121.90
9	A	18	C	C6-N1-C2	-5.08	118.27	120.30
9	A	1114	C	C6-N1-C2	-5.08	118.27	120.30
9	A	2397	U	C2-N1-C1'	5.08	123.80	117.70
54	y	29	C	C6-N1-C2	-5.08	118.27	120.30
9	A	2874	U	C2-N1-C1'	5.08	123.79	117.70
9	A	2858	C	C6-N1-C2	-5.08	118.27	120.30
9	A	963	C	C5-C6-N1	5.07	123.53	121.00
9	A	1907	C	C2-N1-C1'	5.07	124.38	118.80
9	A	1879	C	C6-N1-C2	-5.06	118.28	120.30
9	A	1481	C	C6-N1-C2	-5.06	118.28	120.30
9	A	105	C	C6-N1-C2	-5.06	118.28	120.30
9	A	3109	C	N1-C2-O2	5.06	121.94	118.90
34	a	61	C	C6-N1-C2	-5.06	118.28	120.30
34	a	886	C	C5-C6-N1	5.06	123.53	121.00
9	A	728	C	C6-N1-C2	-5.05	118.28	120.30
9	A	1510	U	C2-N1-C1'	5.05	123.76	117.70
34	a	1474	C	C6-N1-C2	-5.05	118.28	120.30
34	a	1254	U	O4'-C1'-N1	5.05	112.24	108.20
9	A	882	C	C6-N1-C2	-5.04	118.28	120.30
9	A	1044	C	C6-N1-C2	-5.04	118.28	120.30
9	A	2404	U	N1-C2-O2	5.04	126.33	122.80

Continued on next page...

Continued from previous page...

Mol	Chain	Res	Type	Atoms	Z	Observed(°)	Ideal(°)
9	A	2680	C	C6-N1-C2	-5.04	118.28	120.30
9	A	905	G	C8-N9-C1'	-5.04	120.45	127.00
9	A	1474	G	C8-N9-C1'	-5.04	120.45	127.00
9	A	2010	G	N3-C4-N9	5.04	129.02	126.00
9	A	76	C	C6-N1-C2	-5.03	118.29	120.30
34	a	1199	C	C5-C6-N1	5.03	123.52	121.00
9	A	943	C	C5-C6-N1	5.03	123.51	121.00
9	A	271	U	C2-N1-C1'	5.02	123.72	117.70
9	A	2060	C	C6-N1-C2	-5.02	118.29	120.30
9	A	598	C	C5-C6-N1	5.02	123.51	121.00
55	z	3	C	O4'-C1'-N1	5.02	112.22	108.20
9	A	867	C	C2-N1-C1'	5.01	124.31	118.80
9	A	1253	C	C6-N1-C2	-5.00	118.30	120.30

There are no chirality outliers.

All (9) planarity outliers are listed below:

Mol	Chain	Res	Type	Group
8	8	225	ASP	Mainchain
14	F	143	ALA	Peptide
25	R	50	THR	Peptide
28	U	101	ASN	Peptide
29	V	135	ALA	Peptide
29	V	136	LEU	Peptide
44	l	113	ALA	Peptide
44	l	115	SER	Peptide
53	x	278	LYS	Peptide

5.2 Too-close contacts [i](#)

Due to software issues we are unable to calculate clashes - this section is therefore empty.

5.3 Torsion angles [i](#)

5.3.1 Protein backbone [i](#)

In the following table, the Percentiles column shows the percent Ramachandran outliers of the chain as a percentile score with respect to all PDB entries followed by that with respect to all EM entries.

The Analysed column shows the number of residues for which the backbone conformation was analysed, and the total number of residues.

Mol	Chain	Analysed	Favoured	Allowed	Outliers	Percentiles	
1	0	52/57 (91%)	52 (100%)	0	0	100	100
2	1	46/55 (84%)	45 (98%)	1 (2%)	0	100	100
3	2	42/47 (89%)	41 (98%)	1 (2%)	0	100	100
4	3	60/64 (94%)	57 (95%)	3 (5%)	0	100	100
5	4	35/37 (95%)	33 (94%)	2 (6%)	0	100	100
6	6	53/80 (66%)	48 (91%)	5 (9%)	0	100	100
7	7	20/24 (83%)	19 (95%)	1 (5%)	0	100	100
8	8	228/235 (97%)	206 (90%)	22 (10%)	0	100	100
11	C	270/280 (96%)	257 (95%)	13 (5%)	0	100	100
12	D	211/217 (97%)	201 (95%)	10 (5%)	0	100	100
13	E	205/223 (92%)	199 (97%)	6 (3%)	0	100	100
14	F	176/187 (94%)	157 (89%)	17 (10%)	2 (1%)	14	41
15	G	172/179 (96%)	161 (94%)	11 (6%)	0	100	100
16	H	45/152 (30%)	40 (89%)	5 (11%)	0	100	100
17	J	144/195 (74%)	141 (98%)	3 (2%)	0	100	100
18	K	120/122 (98%)	116 (97%)	4 (3%)	0	100	100
19	L	142/146 (97%)	133 (94%)	9 (6%)	0	100	100
20	M	132/138 (96%)	124 (94%)	8 (6%)	0	100	100
21	N	114/180 (63%)	113 (99%)	1 (1%)	0	100	100
22	O	117/122 (96%)	112 (96%)	5 (4%)	0	100	100
23	P	110/113 (97%)	99 (90%)	11 (10%)	0	100	100
24	Q	122/129 (95%)	121 (99%)	1 (1%)	0	100	100
25	R	98/104 (94%)	91 (93%)	6 (6%)	1 (1%)	15	44
26	S	111/197 (56%)	108 (97%)	3 (3%)	0	100	100
27	T	93/100 (93%)	89 (96%)	4 (4%)	0	100	100
28	U	86/105 (82%)	75 (87%)	11 (13%)	0	100	100
29	V	175/215 (81%)	154 (88%)	19 (11%)	2 (1%)	14	41
30	W	72/86 (84%)	63 (88%)	9 (12%)	0	100	100
31	X	60/64 (94%)	58 (97%)	2 (3%)	0	100	100
32	Y	66/77 (86%)	63 (96%)	3 (4%)	0	100	100

Continued on next page...

Continued from previous page...

Mol	Chain	Analysed	Favoured	Allowed	Outliers	Percentiles	
33	Z	57/65 (88%)	55 (96%)	2 (4%)	0	100	100
35	c	205/274 (75%)	189 (92%)	16 (8%)	0	100	100
36	d	198/201 (98%)	177 (89%)	21 (11%)	0	100	100
37	e	167/220 (76%)	153 (92%)	14 (8%)	0	100	100
38	f	93/96 (97%)	90 (97%)	3 (3%)	0	100	100
39	g	153/156 (98%)	150 (98%)	3 (2%)	0	100	100
40	h	129/132 (98%)	121 (94%)	8 (6%)	0	100	100
41	i	125/151 (83%)	110 (88%)	15 (12%)	0	100	100
42	j	97/101 (96%)	88 (91%)	9 (9%)	0	100	100
43	k	115/139 (83%)	107 (93%)	8 (7%)	0	100	100
44	l	120/124 (97%)	95 (79%)	23 (19%)	2 (2%)	9	29
45	m	114/124 (92%)	104 (91%)	10 (9%)	0	100	100
46	n	58/61 (95%)	55 (95%)	2 (3%)	1 (2%)	9	29
47	o	85/89 (96%)	80 (94%)	4 (5%)	1 (1%)	13	39
48	p	111/162 (68%)	99 (89%)	11 (10%)	1 (1%)	17	46
49	q	93/135 (69%)	78 (84%)	15 (16%)	0	100	100
50	r	62/84 (74%)	58 (94%)	4 (6%)	0	100	100
51	s	81/93 (87%)	73 (90%)	8 (10%)	0	100	100
52	t	83/86 (96%)	82 (99%)	1 (1%)	0	100	100
53	x	549/558 (98%)	511 (93%)	38 (7%)	0	100	100
All	All	6072/6981 (87%)	5651 (93%)	411 (7%)	10 (0%)	50	78

All (10) Ramachandran outliers are listed below:

Mol	Chain	Res	Type
14	F	143	ALA
14	F	144	VAL
25	R	51	THR
44	l	114	ARG
46	n	17	ALA
48	p	46	PRO
47	o	19	GLU
29	V	135	ALA
29	V	136	LEU
44	l	4	ILE

5.3.2 Protein sidechains [i](#)

In the following table, the Percentiles column shows the percent sidechain outliers of the chain as a percentile score with respect to all PDB entries followed by that with respect to all EM entries.

The Analysed column shows the number of residues for which the sidechain conformation was analysed, and the total number of residues.

Mol	Chain	Analysed	Rotameric	Outliers	Percentiles	
1	0	44/47 (94%)	44 (100%)	0	100	100
2	1	45/51 (88%)	45 (100%)	0	100	100
3	2	38/40 (95%)	37 (97%)	1 (3%)	46	79
4	3	53/54 (98%)	53 (100%)	0	100	100
5	4	35/35 (100%)	34 (97%)	1 (3%)	42	76
6	6	49/66 (74%)	49 (100%)	0	100	100
7	7	18/20 (90%)	18 (100%)	0	100	100
8	8	175/179 (98%)	173 (99%)	2 (1%)	73	92
11	C	212/219 (97%)	211 (100%)	1 (0%)	88	96
12	D	163/166 (98%)	163 (100%)	0	100	100
13	E	159/172 (92%)	156 (98%)	3 (2%)	57	85
14	F	147/155 (95%)	145 (99%)	2 (1%)	67	90
15	G	143/147 (97%)	142 (99%)	1 (1%)	84	95
16	H	36/121 (30%)	35 (97%)	1 (3%)	43	77
17	J	120/161 (74%)	120 (100%)	0	100	100
18	K	101/101 (100%)	99 (98%)	2 (2%)	55	84
19	L	108/110 (98%)	107 (99%)	1 (1%)	78	94
20	M	110/114 (96%)	109 (99%)	1 (1%)	78	94
21	N	94/139 (68%)	93 (99%)	1 (1%)	73	92
22	O	91/93 (98%)	91 (100%)	0	100	100
23	P	98/99 (99%)	98 (100%)	0	100	100
24	Q	97/99 (98%)	97 (100%)	0	100	100
25	R	81/83 (98%)	81 (100%)	0	100	100
26	S	87/140 (62%)	85 (98%)	2 (2%)	50	82
27	T	81/83 (98%)	80 (99%)	1 (1%)	71	92
28	U	77/88 (88%)	76 (99%)	1 (1%)	69	91

Continued on next page...

Continued from previous page...

Mol	Chain	Analysed	Rotameric	Outliers	Percentiles	
29	V	142/164 (87%)	141 (99%)	1 (1%)	84	95
30	W	54/62 (87%)	53 (98%)	1 (2%)	57	85
31	X	51/52 (98%)	50 (98%)	1 (2%)	55	84
32	Y	60/66 (91%)	60 (100%)	0	100	100
33	Z	51/55 (93%)	49 (96%)	2 (4%)	32	66
35	c	170/210 (81%)	168 (99%)	2 (1%)	71	92
36	d	176/177 (99%)	176 (100%)	0	100	100
37	e	121/159 (76%)	119 (98%)	2 (2%)	60	87
38	f	84/85 (99%)	84 (100%)	0	100	100
39	g	130/131 (99%)	129 (99%)	1 (1%)	81	94
40	h	107/108 (99%)	106 (99%)	1 (1%)	78	94
41	i	102/120 (85%)	100 (98%)	2 (2%)	55	84
42	j	89/90 (99%)	89 (100%)	0	100	100
43	k	90/107 (84%)	89 (99%)	1 (1%)	73	92
44	l	104/105 (99%)	101 (97%)	3 (3%)	42	76
45	m	99/104 (95%)	98 (99%)	1 (1%)	76	93
46	n	46/47 (98%)	46 (100%)	0	100	100
47	o	77/79 (98%)	77 (100%)	0	100	100
48	p	90/125 (72%)	89 (99%)	1 (1%)	73	92
49	q	85/105 (81%)	83 (98%)	2 (2%)	49	81
50	r	54/72 (75%)	52 (96%)	2 (4%)	34	68
51	s	75/85 (88%)	75 (100%)	0	100	100
52	t	64/65 (98%)	62 (97%)	2 (3%)	40	74
53	x	455/460 (99%)	452 (99%)	3 (1%)	84	95
All	All	5038/5615 (90%)	4989 (99%)	49 (1%)	77	93

All (49) residues with a non-rotameric sidechain are listed below:

Mol	Chain	Res	Type
3	2	31	ARG
5	4	8	LYS
8	8	126	ARG
8	8	231	ASN
11	C	4	ARG

Continued on next page...

Continued from previous page...

Mol	Chain	Res	Type
13	E	19	LYS
13	E	81	ARG
13	E	104	TYR
14	F	14	ARG
14	F	78	ARG
15	G	96	ARG
16	H	41	ARG
18	K	97	ARG
18	K	110	ARG
19	L	21	VAL
20	M	60	ARG
21	N	71	ARG
26	S	102	ARG
26	S	120	ARG
27	T	70	ARG
28	U	103	LYS
29	V	10	ARG
30	W	14	ARG
31	X	27	ARG
33	Z	30	ARG
33	Z	44	ARG
35	c	126	ARG
35	c	164	ARG
37	e	163	ASN
37	e	202	LYS
39	g	149	ARG
40	h	50	ARG
41	i	70	LYS
41	i	127	ARG
43	k	82	ARG
44	l	20	LYS
44	l	86	ARG
44	l	108	LYS
45	m	11	ARG
48	p	99	LYS
49	q	68	LYS
49	q	133	LYS
50	r	51	ARG
50	r	52	ARG
52	t	8	GLN
52	t	29	ARG
53	x	216	ARG

Continued on next page...

Continued from previous page...

Mol	Chain	Res	Type
53	x	316	ARG
53	x	535	ASN

Sometimes sidechains can be flipped to improve hydrogen bonding and reduce clashes. All (27) such sidechains are listed below:

Mol	Chain	Res	Type
7	7	17	ASN
8	8	105	GLN
8	8	172	HIS
8	8	231	ASN
13	E	127	ASN
14	F	146	HIS
14	F	162	ASN
15	G	22	GLN
17	J	147	GLN
20	M	57	HIS
22	O	36	HIS
23	P	2	ASN
24	Q	11	HIS
24	Q	44	ASN
24	Q	122	ASN
27	T	58	ASN
29	V	44	HIS
29	V	124	GLN
36	d	115	HIS
36	d	121	ASN
37	e	163	ASN
40	h	42	ASN
41	i	65	HIS
47	o	51	HIS
53	x	40	ASN
53	x	140	GLN
53	x	518	ASN

5.3.3 RNA [i](#)

Mol	Chain	Analysed	Backbone Outliers	Pucker Outliers
10	B	113/115 (98%)	10 (8%)	0
34	a	1515/1537 (98%)	231 (15%)	0
54	y	76/77 (98%)	18 (23%)	0

Continued on next page...

Continued from previous page...

Mol	Chain	Analysed	Backbone Outliers	Pucker Outliers
55	z	6/26 (23%)	4 (66%)	0
9	A	3116/3138 (99%)	460 (14%)	5 (0%)
All	All	4826/4893 (98%)	723 (14%)	5 (0%)

All (723) RNA backbone outliers are listed below:

Mol	Chain	Res	Type
9	A	14	A
9	A	15	G
9	A	62	G
9	A	63	A
9	A	71	A
9	A	73	A
9	A	74	U
9	A	75	G
9	A	91	A
9	A	94	C
9	A	118	A
9	A	119	A
9	A	120	U
9	A	121	G
9	A	165	A
9	A	167	A
9	A	176	G
9	A	183	A
9	A	197	A
9	A	198	A
9	A	201	A
9	A	203	C
9	A	206	A
9	A	217	G
9	A	218	A
9	A	224	A
9	A	230	U
9	A	231	U
9	A	232	G
9	A	243	A
9	A	249	G
9	A	250	G
9	A	252	G
9	A	268	G
9	A	287	G

Continued on next page...

Continued from previous page...

Mol	Chain	Res	Type
9	A	289	A
9	A	293	G
9	A	297	A
9	A	301	G
9	A	302	U
9	A	303	U
9	A	320	G
9	A	328	A
9	A	339	C
9	A	358	U
9	A	362	A
9	A	364	A
9	A	372	G
9	A	377	G
9	A	394	U
9	A	399	U
9	A	401	C
9	A	405	A
9	A	409	G
9	A	413	A
9	A	428	A
9	A	446	A
9	A	447	G
9	A	475	G
9	A	494	C
9	A	500	G
9	A	501	A
9	A	505	C
9	A	544	U
9	A	545	U
9	A	564	U
9	A	570	G
9	A	592	G
9	A	593	A
9	A	595	U
9	A	596	A
9	A	597	C
9	A	610	G
9	A	618	U
9	A	619	C
9	A	620	C
9	A	621	G

Continued on next page...

Continued from previous page...

Mol	Chain	Res	Type
9	A	634	U
9	A	637	C
9	A	639	U
9	A	642	C
9	A	643	C
9	A	644	G
9	A	645	G
9	A	665	G
9	A	675	G
9	A	676	A
9	A	677	A
9	A	694	G
9	A	695	G
9	A	706	A
9	A	709	U
9	A	718	G
9	A	738	G
9	A	741	A
9	A	749	U
9	A	758	C
9	A	759	C
9	A	760	A
9	A	766	G
9	A	767	C
9	A	773	C
9	A	778	G
9	A	779	U
9	A	780	G
9	A	781	A
9	A	782	A
9	A	783	U
9	A	784	A
9	A	793	U
9	A	815	U
9	A	824	G
9	A	831	G
9	A	843	U
9	A	846	G
9	A	859	C
9	A	876	U
9	A	891	U
9	A	893	A

Continued on next page...

Continued from previous page...

Mol	Chain	Res	Type
9	A	894	G
9	A	904	G
9	A	905	G
9	A	911	A
9	A	912	A
9	A	913	G
9	A	914	G
9	A	918	A
9	A	929	U
9	A	934	G
9	A	941	C
9	A	956	U
9	A	957	U
9	A	987	G
9	A	988	G
9	A	995	U
9	A	1007	G
9	A	1025	A
9	A	1026	C
9	A	1036	C
9	A	1039	A
9	A	1040	A
9	A	1044	C
9	A	1059	A
9	A	1074	G
9	A	1085	A
9	A	1087	A
9	A	1089	G
9	A	1096	A
9	A	1102	A
9	A	1103	A
9	A	1112	A
9	A	1118	G
9	A	1125	G
9	A	1138	A
9	A	1141	C
9	A	1142	G
9	A	1155	G
9	A	1159	G
9	A	1162	U
9	A	1168	G
9	A	1174	A

Continued on next page...

Continued from previous page...

Mol	Chain	Res	Type
9	A	1177	A
9	A	1186	A
9	A	1187	G
9	A	1189	U
9	A	1190	U
9	A	1191	G
9	A	1195	U
9	A	1196	A
9	A	1199	A
9	A	1200	G
9	A	1201	C
9	A	1202	A
9	A	1206	A
9	A	1207	C
9	A	1211	U
9	A	1212	G
9	A	1213	A
9	A	1216	G
9	A	1217	A
9	A	1218	G
9	A	1219	U
9	A	1226	U
9	A	1227	A
9	A	1234	U
9	A	1240	A
9	A	1241	G
9	A	1257	A
9	A	1258	A
9	A	1262	A
9	A	1264	C
9	A	1271	C
9	A	1273	A
9	A	1286	A
9	A	1301	A
9	A	1304	U
9	A	1305	U
9	A	1308	G
9	A	1309	G
9	A	1313	G
9	A	1342	C
9	A	1368	A
9	A	1381	G

Continued on next page...

Continued from previous page...

Mol	Chain	Res	Type
9	A	1384	A
9	A	1387	G
9	A	1393	A
9	A	1395	G
9	A	1402	G
9	A	1403	A
9	A	1404	C
9	A	1405	A
9	A	1406	A
9	A	1432	A
9	A	1437	C
9	A	1452	C
9	A	1456	C
9	A	1481	C
9	A	1483	U
9	A	1486	G
9	A	1496	A
9	A	1499	G
9	A	1501	C
9	A	1505	G
9	A	1509	A
9	A	1510	U
9	A	1515	A
9	A	1551	C
9	A	1561	C
9	A	1565	G
9	A	1567	U
9	A	1568	A
9	A	1570	U
9	A	1580	A
9	A	1581	A
9	A	1582	A
9	A	1609	U
9	A	1622	G
9	A	1646	G
9	A	1647	U
9	A	1656	G
9	A	1657	A
9	A	1658	A
9	A	1665	A
9	A	1666	C
9	A	1675	G

Continued on next page...

Continued from previous page...

Mol	Chain	Res	Type
9	A	1693	G
9	A	1696	A
9	A	1697	A
9	A	1698	C
9	A	1699	A
9	A	1705	G
9	A	1717	G
9	A	1720	G
9	A	1727	A
9	A	1730	C
9	A	1743	C
9	A	1747	A
9	A	1754	A
9	A	1762	C
9	A	1763	G
9	A	1773	U
9	A	1774	U
9	A	1794	U
9	A	1803	A
9	A	1806	A
9	A	1820	A
9	A	1821	G
9	A	1832	G
9	A	1842	C
9	A	1843	A
9	A	1845	A
9	A	1881	U
9	A	1883	C
9	A	1884	G
9	A	1888	U
9	A	1889	A
9	A	1909	G
9	A	1910	C
9	A	1930	G
9	A	1933	A
9	A	1934	G
9	A	1949	U
9	A	1950	A
9	A	1961	C
9	A	1964	U
9	A	1966	C
9	A	1970	G

Continued on next page...

Continued from previous page...

Mol	Chain	Res	Type
9	A	1990	G
9	A	1991	A
9	A	1998	U
9	A	2007	A
9	A	2010	G
9	A	2015	C
9	A	2016	U
9	A	2018	A
9	A	2020	A
9	A	2034	C
9	A	2035	G
9	A	2043	A
9	A	2050	U
9	A	2062	G
9	A	2063	A
9	A	2105	G
9	A	2107	A
9	A	2108	A
9	A	2109	G
9	A	2137	A
9	A	2138	A
9	A	2144	G
9	A	2148	G
9	A	2152	C
9	A	2167	G
9	A	2168	G
9	A	2174	A
9	A	2176	A
9	A	2177	5MU
9	A	2193	U
9	A	2198	A
9	A	2203	C
9	A	2205	C
9	A	2208	A
9	A	2209	U
9	A	2210	G
9	A	2229	U
9	A	2230	G
9	A	2231	U
9	A	2242	G
9	A	2258	A
9	A	2261	A

Continued on next page...

Continued from previous page...

Mol	Chain	Res	Type
9	A	2269	A
9	A	2270	G
9	A	2281	C
9	A	2289	A
9	A	2293	C
9	A	2294	G
9	A	2297	A
9	A	2298	A
9	A	2299	G
9	A	2300	A
9	A	2313	C
9	A	2330	G
9	A	2337	G
9	A	2352	G
9	A	2354	A
9	A	2355	U
9	A	2356	A
9	A	2363	A
9	A	2364	G
9	A	2366	C
9	A	2371	A
9	A	2373	A
9	A	2376	U
9	A	2381	G
9	A	2383	C
9	A	2384	A
9	A	2385	G
9	A	2386	U
9	A	2387	U
9	A	2388	G
9	A	2390	G
9	A	2394	G
9	A	2395	A
9	A	2404	U
9	A	2405	G
9	A	2410	A
9	A	2415	U
9	A	2427	G
9	A	2435	A
9	A	2437	C
9	A	2447	U
9	A	2449	A

Continued on next page...

Continued from previous page...

Mol	Chain	Res	Type
9	A	2463	A
9	A	2472	G
9	A	2476	G
9	A	2477	G
9	A	2489	G
9	A	2497	G
9	A	2516	A
9	A	2517	G
9	A	2521	C
9	A	2524	A
9	A	2525	A
9	A	2526	A
9	A	2531	C
9	A	2543	A
9	A	2546	G
9	A	2547	C
9	A	2558	C
9	A	2559	G
9	A	2560	A
9	A	2563	G
9	A	2565	A
9	A	2573	A
9	A	2574	A
9	A	2583	G
9	A	2585	C
9	A	2588	C
9	A	2621	G
9	A	2623	A
9	A	2627	G
9	A	2634	G
9	A	2644	A
9	A	2657	U
9	A	2661	U
9	A	2663	A
9	A	2666	G
9	A	2667	G
9	A	2668	A
9	A	2678	C
9	A	2679	C
9	A	2686	A
9	A	2708	G
9	A	2712	C

Continued on next page...

Continued from previous page...

Mol	Chain	Res	Type
9	A	2714	A
9	A	2736	C
9	A	2738	U
9	A	2743	G
9	A	2746	G
9	A	2751	G
9	A	2756	A
9	A	2767	G
9	A	2773	G
9	A	2781	G
9	A	2792	U
9	A	2804	A
9	A	2805	G
9	A	2811	C
9	A	2816	G
9	A	2820	G
9	A	2840	A
9	A	2844	C
9	A	2847	U
9	A	2851	U
9	A	2853	U
9	A	2868	A
9	A	2884	C
9	A	2899	G
9	A	2901	G
9	A	2920	U
9	A	2944	G
9	A	2952	G
9	A	2962	C
9	A	2964	C
9	A	2982	G
9	A	2986	A
9	A	3003	A
9	A	3016	A
9	A	3018	C
9	A	3038	U
9	A	3056	A
9	A	3070	A
9	A	3071	U
9	A	3102	U
9	A	3107	A
9	A	3112	G

Continued on next page...

Continued from previous page...

Mol	Chain	Res	Type
9	A	3119	C
9	A	3121	G
9	A	3127	A
9	A	3128	A
9	A	3129	A
10	B	3	A
10	B	6	G
10	B	8	G
10	B	41	C
10	B	55	U
10	B	56	A
10	B	85	U
10	B	101	G
10	B	105	A
10	B	115	A
34	a	9	G
34	a	10	G
34	a	12	G
34	a	16	U
34	a	25	G
34	a	34	G
34	a	35	A
34	a	42	G
34	a	51	U
34	a	53	A
34	a	54	A
34	a	74	A
34	a	87	A
34	a	89	A
34	a	90	U
34	a	91	A
34	a	92	C
34	a	93	U
34	a	116	C
34	a	117	A
34	a	125	G
34	a	127	U
34	a	137	A
34	a	142	G
34	a	167	A
34	a	169	U
34	a	178	G

Continued on next page...

Continued from previous page...

Mol	Chain	Res	Type
34	a	180	A
34	a	185	G
34	a	189	U
34	a	191	C
34	a	194	G
34	a	204	G
34	a	213	U
34	a	214	U
34	a	215	U
34	a	216	A
34	a	217	G
34	a	244	C
34	a	246	G
34	a	250	G
34	a	265	G
34	a	266	C
34	a	280	G
34	a	282	C
34	a	288	G
34	a	316	U
34	a	320	A
34	a	326	A
34	a	328	A
34	a	329	C
34	a	346	G
34	a	351	C
34	a	353	G
34	a	355	A
34	a	362	A
34	a	366	U
34	a	367	U
34	a	371	C
34	a	372	A
34	a	391	C
34	a	397	C
34	a	405	G
34	a	410	A
34	a	411	U
34	a	412	G
34	a	413	A
34	a	420	U
34	a	421	C

Continued on next page...

Continued from previous page...

Mol	Chain	Res	Type
34	a	422	G
34	a	428	U
34	a	438	U
34	a	440	A
34	a	445	C
34	a	451	A
34	a	452	G
34	a	453	G
34	a	455	C
34	a	459	G
34	a	460	U
34	a	461	U
34	a	462	C
34	a	465	U
34	a	467	G
34	a	473	A
34	a	475	G
34	a	476	G
34	a	485	G
34	a	488	G
34	a	490	A
34	a	501	A
34	a	502	C
34	a	509	C
34	a	512	G
34	a	517	C
34	a	518	G7M
34	a	524	A
34	a	538	A
34	a	550	A
34	a	553	U
34	a	557	G
34	a	563	A
34	a	564	A
34	a	567	A
34	a	568	G
34	a	570	U
34	a	587	C
34	a	598	A
34	a	609	C
34	a	623	U
34	a	624	G

Continued on next page...

Continued from previous page...

Mol	Chain	Res	Type
34	a	640	G
34	a	644	A
34	a	652	G
34	a	656	G
34	a	686	A
34	a	694	G
34	a	712	G
34	a	714	U
34	a	715	G
34	a	740	A
34	a	746	G
34	a	750	A
34	a	768	A
34	a	784	U
34	a	785	A
34	a	806	A
34	a	808	C
34	a	810	G
34	a	823	G
34	a	827	G
34	a	832	C
34	a	836	C
34	a	837	U
34	a	838	U
34	a	846	G
34	a	863	U
34	a	882	A
34	a	883	G
34	a	893	A
34	a	895	G
34	a	900	A
34	a	907	A
34	a	915	G
34	a	919	G
34	a	925	C
34	a	927	C
34	a	953	U
34	a	954	U
34	a	959	2MG
34	a	962	A
34	a	964	G
34	a	968	A

Continued on next page...

Continued from previous page...

Mol	Chain	Res	Type
34	a	969	G
34	a	970	A
34	a	985	U
34	a	986	G
34	a	997	G
34	a	999	C
34	a	1016	G
34	a	1019	C
34	a	1021	C
34	a	1022	U
34	a	1023	U
34	a	1024	G
34	a	1044	G
34	a	1056	U
34	a	1076	U
34	a	1085	G
34	a	1086	U
34	a	1092	A
34	a	1099	G
34	a	1116	U
34	a	1128	A
34	a	1129	A
34	a	1131	G
34	a	1135	G
34	a	1149	A
34	a	1150	C
34	a	1151	U
34	a	1160	C
34	a	1163	C
34	a	1174	G
34	a	1176	G
34	a	1188	A
34	a	1189	A
34	a	1204	U
34	a	1205	A
34	a	1206	U
34	a	1212	G
34	a	1219	A
34	a	1230	A
34	a	1248	C
34	a	1250	G
34	a	1260	G

Continued on next page...

Continued from previous page...

Mol	Chain	Res	Type
34	a	1262	G
34	a	1272	A
34	a	1278	A
34	a	1279	A
34	a	1282	G
34	a	1292	G
34	a	1309	C
34	a	1314	C
34	a	1327	U
34	a	1328	C
34	a	1332	G
34	a	1338	A
34	a	1345	G
34	a	1355	A
34	a	1356	A
34	a	1357	C
34	a	1363	G
34	a	1372	G
34	a	1387	A
34	a	1390	C
34	a	1391	A
34	a	1412	G
34	a	1435	G
34	a	1439	A
34	a	1444	U
34	a	1445	C
34	a	1480	G
34	a	1485	A
34	a	1490	G
34	a	1492	A
34	a	1496	A
34	a	1500	A
34	a	1510	G
34	a	1522	G
34	a	1523	G
34	a	1526	C
54	y	4	G
54	y	5	G
54	y	9	G
54	y	13	C
54	y	14	A
54	y	17	C

Continued on next page...

Continued from previous page...

Mol	Chain	Res	Type
54	y	18	U
54	y	19	G
54	y	20	G
54	y	22	A
54	y	26	C
54	y	44	A
54	y	49	C
54	y	51	U
54	y	53	G
54	y	64	G
54	y	74	A
54	y	77	A
55	z	2	A
55	z	3	C
55	z	4	A
55	z	7	U

All (5) RNA pucker outliers are listed below:

Mol	Chain	Res	Type
9	A	913	G
9	A	2177	5MU
9	A	2355	U
9	A	2384	A
9	A	3127	A

5.4 Non-standard residues in protein, DNA, RNA chains [i](#)

9 non-standard protein/DNA/RNA residues are modelled in this entry.

In the following table, the Counts columns list the number of bonds (or angles) for which Mogul statistics could be retrieved, the number of bonds (or angles) that are observed in the model and the number of bonds (or angles) that are defined in the Chemical Component Dictionary. The Link column lists molecule types, if any, to which the group is linked. The Z score for a bond length (or angle) is the number of standard deviations the observed value is removed from the expected value. A bond length (or angle) with $|Z| > 2$ is considered an outlier worth inspection. RMSZ is the root-mean-square of all Z scores of the bond lengths (or angles).

Mol	Type	Chain	Res	Link	Bond lengths			Bond angles		
					Counts	RMSZ	# Z > 2	Counts	RMSZ	# Z > 2
9	5MU	A	2177	9	19,22,23	4.55	7 (36%)	28,32,35	3.75	9 (32%)
34	MA6	a	1511	34	19,26,27	1.05	2 (10%)	18,38,41	3.38	2 (11%)

Mol	Type	Chain	Res	Link	Bond lengths			Bond angles		
					Counts	RMSZ	# Z > 2	Counts	RMSZ	# Z > 2
34	G7M	a	518	34	20,26,27	3.88	10 (50%)	17,39,42	1.12	1 (5%)
34	4OC	a	1395	34	20,23,24	2.80	8 (40%)	26,32,35	0.97	3 (11%)
34	MA6	a	1512	34	19,26,27	1.12	1 (5%)	18,38,41	3.48	2 (11%)
34	UR3	a	1491	34	19,22,23	2.56	7 (36%)	26,32,35	1.19	3 (11%)
34	5MC	a	960	34	18,22,23	3.38	7 (38%)	26,32,35	1.20	2 (7%)
34	2MG	a	959	34	18,26,27	2.37	7 (38%)	16,38,41	1.40	4 (25%)
9	OMG	A	2791	9	18,26,27	2.37	8 (44%)	19,38,41	1.52	4 (21%)

In the following table, the Chirals column lists the number of chiral outliers, the number of chiral centers analysed, the number of these observed in the model and the number defined in the Chemical Component Dictionary. Similar counts are reported in the Torsion and Rings columns. '-' means no outliers of that kind were identified.

Mol	Type	Chain	Res	Link	Chirals	Torsions	Rings
9	5MU	A	2177	9	-	1/7/25/26	0/2/2/2
34	MA6	a	1511	34	-	1/7/29/30	0/3/3/3
34	G7M	a	518	34	-	1/3/25/26	0/3/3/3
34	4OC	a	1395	34	-	2/9/29/30	0/2/2/2
34	MA6	a	1512	34	-	2/7/29/30	0/3/3/3
34	UR3	a	1491	34	-	2/7/25/26	0/2/2/2
34	5MC	a	960	34	-	1/7/25/26	0/2/2/2
34	2MG	a	959	34	-	0/5/27/28	0/3/3/3
9	OMG	A	2791	9	-	2/5/27/28	0/3/3/3

All (57) bond length outliers are listed below:

Mol	Chain	Res	Type	Atoms	Z	Observed(Å)	Ideal(Å)
9	A	2177	5MU	C6-N1	10.06	1.55	1.38
34	a	518	G7M	C8-N7	9.69	1.50	1.33
9	A	2177	5MU	C2-N1	9.51	1.53	1.38
34	a	518	G7M	C8-N9	9.43	1.50	1.33
9	A	2177	5MU	C4-C5	8.87	1.59	1.44
34	a	960	5MC	C6-C5	8.43	1.48	1.34
9	A	2177	5MU	C4-N3	-8.03	1.23	1.38
34	a	1491	UR3	C6-C5	6.36	1.49	1.35
34	a	960	5MC	C4-N3	6.24	1.44	1.34
9	A	2177	5MU	C6-C5	5.93	1.44	1.34
34	a	1395	4OC	C6-C5	5.90	1.48	1.35
34	a	960	5MC	C2-N3	5.73	1.48	1.36
34	a	1395	4OC	C4-N3	5.65	1.42	1.32

Continued on next page...

Continued from previous page...

Mol	Chain	Res	Type	Atoms	Z	Observed(Å)	Ideal(Å)
34	a	1491	UR3	C2-N1	5.52	1.46	1.38
34	a	518	G7M	C2-N3	5.41	1.46	1.33
34	a	1395	4OC	C2-N3	5.35	1.47	1.36
9	A	2791	OMG	C2-N3	5.33	1.46	1.33
34	a	959	2MG	C2-N2	5.21	1.45	1.33
34	a	518	G7M	C2-N2	4.80	1.45	1.34
34	a	1491	UR3	C2-N3	4.76	1.48	1.39
34	a	959	2MG	C4-N3	4.73	1.48	1.37
34	a	518	G7M	C6-N1	4.43	1.44	1.37
9	A	2791	OMG	C4-N3	4.42	1.48	1.37
34	a	959	2MG	C2-N1	4.36	1.43	1.36
34	a	1395	4OC	C4-N4	4.26	1.44	1.35
34	a	960	5MC	C4-N4	4.26	1.45	1.34
34	a	960	5MC	C2-N1	4.09	1.48	1.40
34	a	960	5MC	C6-N1	4.03	1.44	1.38
9	A	2791	OMG	C2-N2	3.86	1.43	1.34
34	a	518	G7M	C4-N3	3.76	1.46	1.37
34	a	1395	4OC	C2-N1	3.61	1.47	1.40
34	a	518	G7M	C2-N1	3.49	1.46	1.37
9	A	2177	5MU	O4-C4	-3.36	1.17	1.23
9	A	2791	OMG	C6-N1	3.17	1.42	1.37
34	a	1395	4OC	C5-C4	3.15	1.47	1.40
34	a	959	2MG	C6-N1	3.09	1.42	1.37
34	a	960	5MC	O2-C2	-3.05	1.18	1.23
9	A	2177	5MU	O2-C2	-3.02	1.17	1.23
9	A	2791	OMG	C5-C4	-3.00	1.35	1.43
34	a	1395	4OC	O2-C2	-2.94	1.18	1.23
34	a	1395	4OC	C6-N1	2.90	1.45	1.38
34	a	959	2MG	C5-C4	-2.87	1.35	1.43
34	a	1491	UR3	C6-N1	2.87	1.44	1.38
34	a	1512	MA6	C5-C4	-2.84	1.33	1.40
9	A	2791	OMG	O6-C6	-2.75	1.17	1.23
34	a	1511	MA6	C5-C4	-2.68	1.33	1.40
34	a	959	2MG	O6-C6	-2.57	1.18	1.23
34	a	518	G7M	O6-C6	-2.55	1.18	1.23
34	a	1491	UR3	O2-C2	-2.51	1.17	1.22
34	a	518	G7M	C5-C6	2.50	1.51	1.45
34	a	959	2MG	C5-C6	2.34	1.52	1.47
9	A	2791	OMG	C5-C6	2.26	1.52	1.47
34	a	1491	UR3	C3U-N3	-2.21	1.43	1.47
9	A	2791	OMG	C2-N1	2.12	1.42	1.37
34	a	1491	UR3	O4-C4	-2.04	1.19	1.23

Continued on next page...

Continued from previous page...

Mol	Chain	Res	Type	Atoms	Z	Observed(Å)	Ideal(Å)
34	a	1511	MA6	C2-N3	2.03	1.35	1.32
34	a	518	G7M	C5-C4	2.01	1.43	1.39

All (30) bond angle outliers are listed below:

Mol	Chain	Res	Type	Atoms	Z	Observed(°)	Ideal(°)
34	a	1512	MA6	N1-C6-N6	-13.36	103.00	117.06
34	a	1511	MA6	N1-C6-N6	-12.89	103.49	117.06
9	A	2177	5MU	C5-C4-N3	12.42	125.91	115.31
9	A	2177	5MU	C5-C6-N1	-10.16	112.88	123.34
34	a	1512	MA6	N3-C2-N1	-5.82	119.58	128.68
34	a	1511	MA6	N3-C2-N1	-5.63	119.88	128.68
9	A	2177	5MU	C4-N3-C2	-5.28	120.51	127.35
9	A	2177	5MU	O4-C4-C5	-5.21	118.86	124.90
9	A	2177	5MU	N3-C2-N1	4.88	121.36	114.89
34	a	960	5MC	C5-C6-N1	-3.94	119.28	123.34
9	A	2177	5MU	O2-C2-N1	-3.88	117.63	122.79
34	a	1491	UR3	C4-N3-C2	-3.85	120.94	124.56
9	A	2177	5MU	C5M-C5-C6	-3.65	117.98	122.85
9	A	2791	OMG	C5-C6-N1	3.56	120.24	113.95
9	A	2177	5MU	C5M-C5-C4	3.53	122.66	118.77
34	a	959	2MG	C5-C6-N1	3.50	120.13	113.95
9	A	2791	OMG	C2-N1-C6	-3.22	119.17	125.10
34	a	518	G7M	C2-N1-C6	-2.72	120.09	125.10
9	A	2791	OMG	C8-N7-C5	2.67	108.07	102.99
34	a	959	2MG	C8-N7-C5	2.57	107.89	102.99
9	A	2177	5MU	O4-C4-N3	-2.55	115.22	120.12
9	A	2791	OMG	O6-C6-C5	-2.43	119.62	124.37
34	a	959	2MG	O6-C6-C5	-2.43	119.63	124.37
34	a	1491	UR3	C6-N1-C2	-2.26	119.77	121.79
34	a	960	5MC	CM5-C5-C6	-2.24	119.85	122.85
34	a	1491	UR3	C1'-N1-C2	2.16	120.63	116.99
34	a	1395	4OC	CM4-N4-C4	-2.15	118.25	122.45
34	a	1395	4OC	O2-C2-N3	-2.09	118.93	122.33
34	a	1395	4OC	C6-C5-C4	2.07	119.49	116.96
34	a	959	2MG	CM2-N2-C2	-2.00	119.44	123.86

There are no chirality outliers.

All (12) torsion outliers are listed below:

Mol	Chain	Res	Type	Atoms
34	a	1512	MA6	O4'-C4'-C5'-O5'

Continued on next page...

Continued from previous page...

Mol	Chain	Res	Type	Atoms
34	a	1512	MA6	C3'-C4'-C5'-O5'
34	a	1395	4OC	O4'-C4'-C5'-O5'
9	A	2791	OMG	O4'-C4'-C5'-O5'
9	A	2791	OMG	C3'-C4'-C5'-O5'
34	a	1395	4OC	C3'-C4'-C5'-O5'
34	a	518	G7M	C3'-C4'-C5'-O5'
34	a	1491	UR3	O4'-C4'-C5'-O5'
34	a	960	5MC	O4'-C4'-C5'-O5'
9	A	2177	5MU	O4'-C4'-C5'-O5'
34	a	1491	UR3	C3'-C4'-C5'-O5'
34	a	1511	MA6	C3'-C4'-C5'-O5'

There are no ring outliers.

No monomer is involved in short contacts.

5.5 Carbohydrates [i](#)

There are no monosaccharides in this entry.

5.6 Ligand geometry [i](#)

Of 456 ligands modelled in this entry, 451 are monoatomic - leaving 5 for Mogul analysis.

In the following table, the Counts columns list the number of bonds (or angles) for which Mogul statistics could be retrieved, the number of bonds (or angles) that are observed in the model and the number of bonds (or angles) that are defined in the Chemical Component Dictionary. The Link column lists molecule types, if any, to which the group is linked. The Z score for a bond length (or angle) is the number of standard deviations the observed value is removed from the expected value. A bond length (or angle) with $|Z| > 2$ is considered an outlier worth inspection. RMSZ is the root-mean-square of all Z scores of the bond lengths (or angles).

Mol	Type	Chain	Res	Link	Bond lengths			Bond angles		
					Counts	RMSZ	$\# Z > 2$	Counts	RMSZ	$\# Z > 2$
58	ADP	x	603	57	24,29,29	0.92	1 (4%)	29,45,45	1.58	4 (13%)
59	VO4	x	604	53,57	1,4,4	4.73	1 (100%)	-		
58	ADP	x	601	57	24,29,29	0.95	1 (4%)	29,45,45	1.66	5 (17%)
60	FME	y	101	54	8,9,10	1.00	0	7,9,11	1.23	1 (14%)
59	VO4	x	602	57	1,4,4	4.77	1 (100%)	-		

In the following table, the Chirals column lists the number of chiral outliers, the number of chiral

centers analysed, the number of these observed in the model and the number defined in the Chemical Component Dictionary. Similar counts are reported in the Torsion and Rings columns. '-' means no outliers of that kind were identified.

Mol	Type	Chain	Res	Link	Chirals	Torsions	Rings
58	ADP	x	601	57	-	2/12/32/32	0/3/3/3
60	FME	y	101	54	-	1/7/9/11	-
58	ADP	x	603	57	-	2/12/32/32	0/3/3/3

All (4) bond length outliers are listed below:

Mol	Chain	Res	Type	Atoms	Z	Observed(Å)	Ideal(Å)
59	x	602	VO4	O1-V	4.77	1.90	1.63
59	x	604	VO4	O1-V	4.73	1.90	1.63
58	x	603	ADP	C5-C4	2.31	1.47	1.40
58	x	601	ADP	C5-C4	2.28	1.47	1.40

All (10) bond angle outliers are listed below:

Mol	Chain	Res	Type	Atoms	Z	Observed(°)	Ideal(°)
58	x	601	ADP	PA-O3A-PB	-4.77	116.47	132.83
58	x	603	ADP	PA-O3A-PB	-4.74	116.55	132.83
58	x	601	ADP	C3'-C2'-C1'	3.55	106.33	100.98
58	x	603	ADP	N3-C2-N1	-3.17	123.73	128.68
58	x	601	ADP	N3-C2-N1	-2.99	124.00	128.68
58	x	603	ADP	C3'-C2'-C1'	2.82	105.22	100.98
58	x	603	ADP	C4-C5-N7	-2.69	106.60	109.40
60	y	101	FME	C-CA-N	2.36	113.99	109.73
58	x	601	ADP	O3B-PB-O2B	2.14	115.82	107.64
58	x	601	ADP	C4-C5-N7	-2.07	107.24	109.40

There are no chirality outliers.

All (5) torsion outliers are listed below:

Mol	Chain	Res	Type	Atoms
58	x	601	ADP	O4'-C4'-C5'-O5'
58	x	603	ADP	C5'-O5'-PA-O3A
58	x	601	ADP	C3'-C4'-C5'-O5'
60	y	101	FME	CB-CG-SD-CE
58	x	603	ADP	C5'-O5'-PA-O2A

There are no ring outliers.

No monomer is involved in short contacts.

The following is a two-dimensional graphical depiction of Mogul quality analysis of bond lengths, bond angles, torsion angles, and ring geometry for all instances of the Ligand of Interest. In addition, ligands with molecular weight > 250 and outliers as shown on the validation Tables will also be included. For torsion angles, if less than 5% of the Mogul distribution of torsion angles is within 10 degrees of the torsion angle in question, then that torsion angle is considered an outlier. Any bond that is central to one or more torsion angles identified as an outlier by Mogul will be highlighted in the graph. For rings, the root-mean-square deviation (RMSD) between the ring in question and similar rings identified by Mogul is calculated over all ring torsion angles. If the average RMSD is greater than 60 degrees and the minimal RMSD between the ring in question and any Mogul-identified rings is also greater than 60 degrees, then that ring is considered an outlier. The outliers are highlighted in purple. The color gray indicates Mogul did not find sufficient equivalents in the CSD to analyse the geometry.

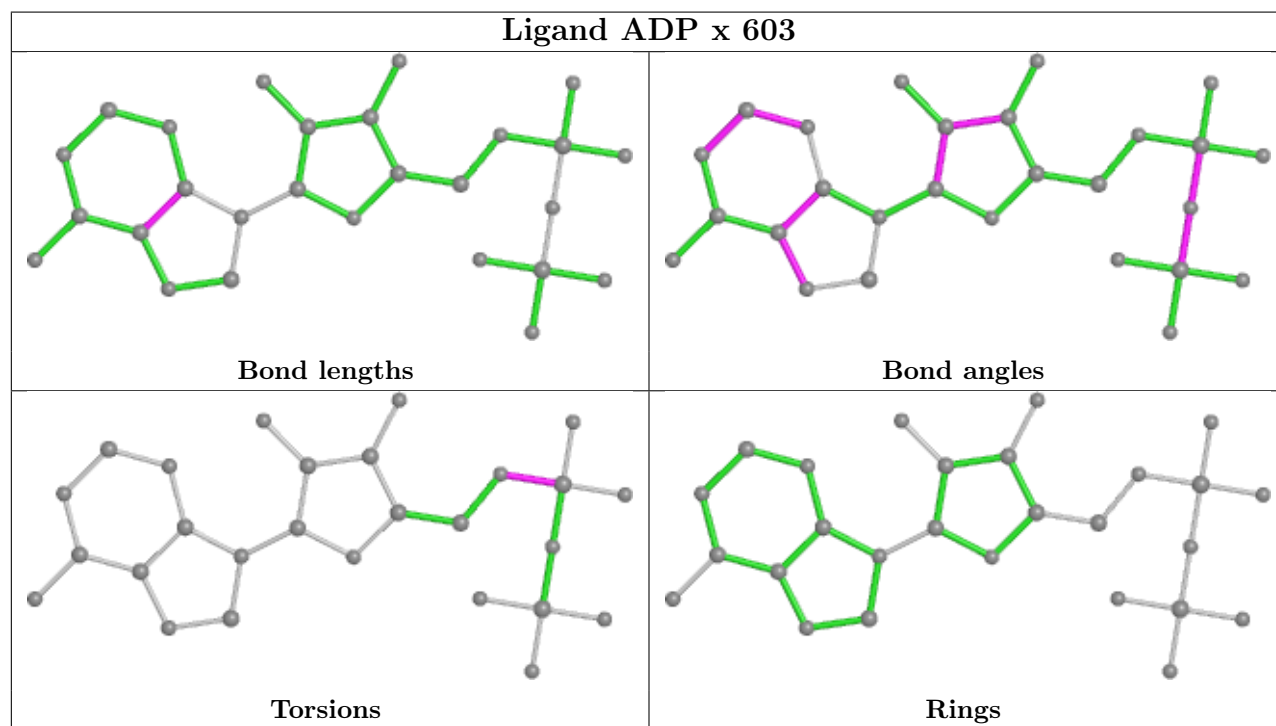

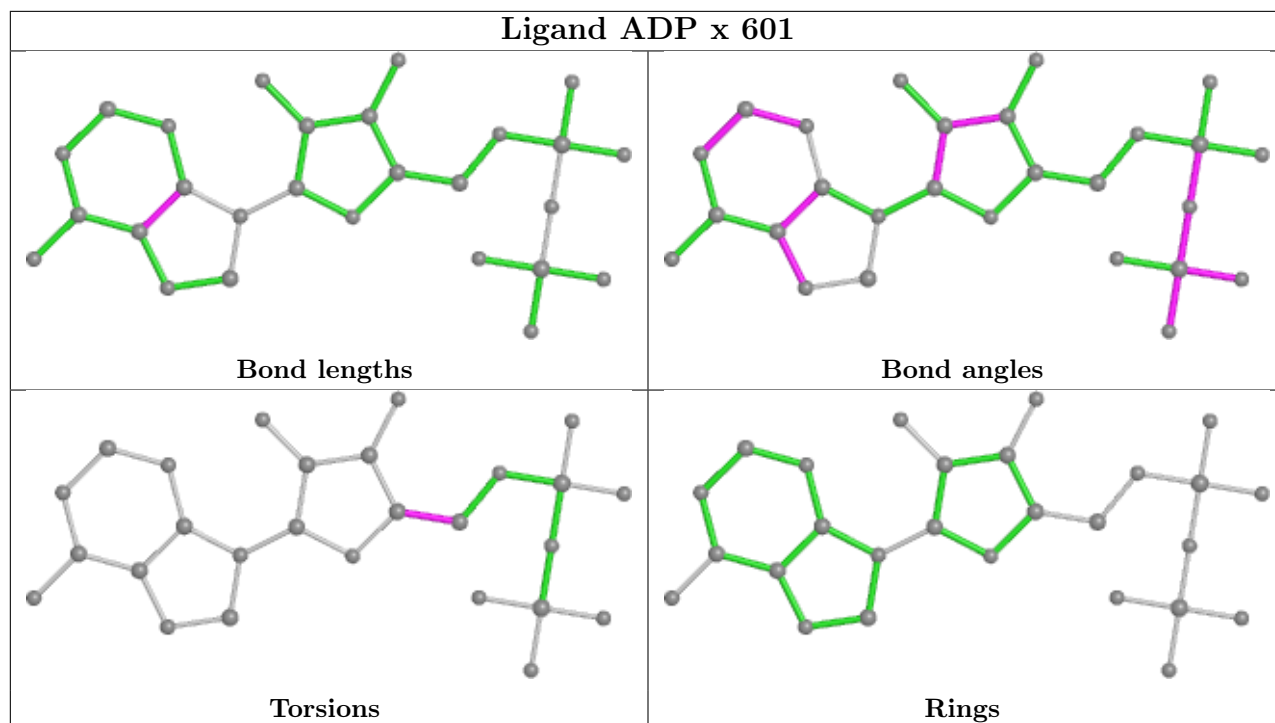

5.7 Other polymers [i](#)

There are no such residues in this entry.

5.8 Polymer linkage issues [i](#)

The following chains have linkage breaks:

Mol	Chain	Number of breaks
10	B	1
11	C	1

All chain breaks are listed below:

Model	Chain	Residue-1	Atom-1	Residue-2	Atom-2	Distance (Å)
1	B	76:U	O3'	77:A	P	3.18
1	C	226:MET	C	227:ASN	N	1.16

6 Map visualisation [i](#)

This section contains visualisations of the EMDB entry EMD-23969. These allow visual inspection of the internal detail of the map and identification of artifacts.

No raw map or half-maps were deposited for this entry and therefore no images, graphs, etc. pertaining to the raw map can be shown.

6.1 Orthogonal projections [i](#)

6.1.1 Primary map

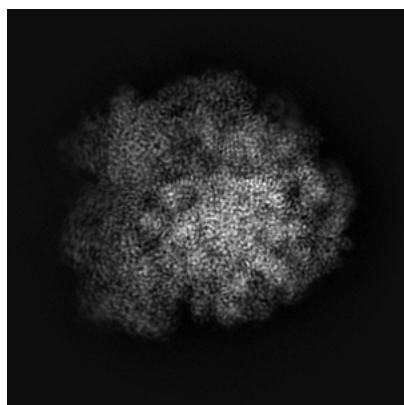

X

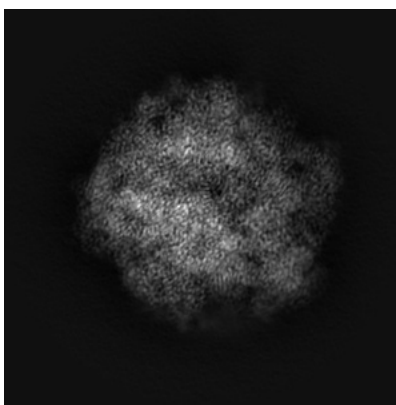

Y

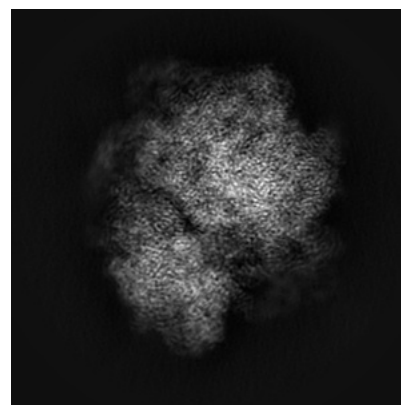

Z

The images above show the map projected in three orthogonal directions.

6.2 Central slices [i](#)

6.2.1 Primary map

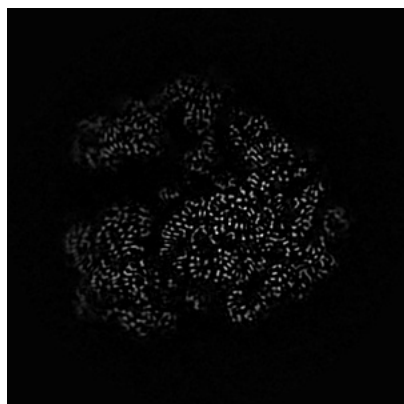

X Index: 160

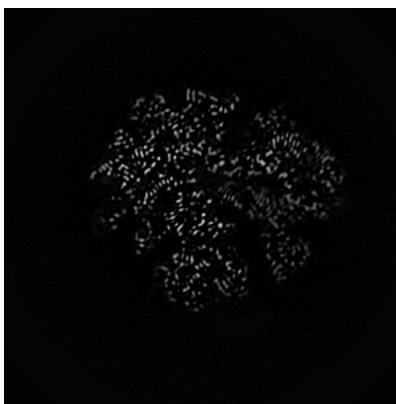

Y Index: 160

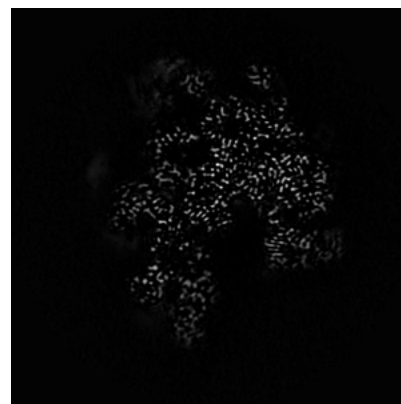

Z Index: 160

The images above show central slices of the map in three orthogonal directions.

6.3 Largest variance slices [i](#)

6.3.1 Primary map

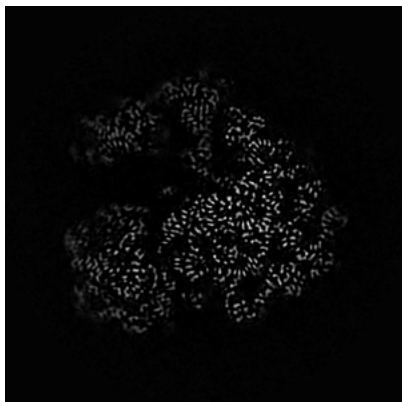

X Index: 162

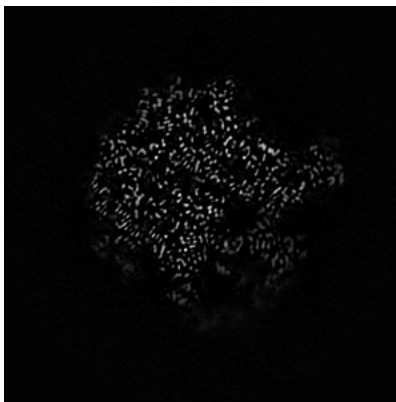

Y Index: 183

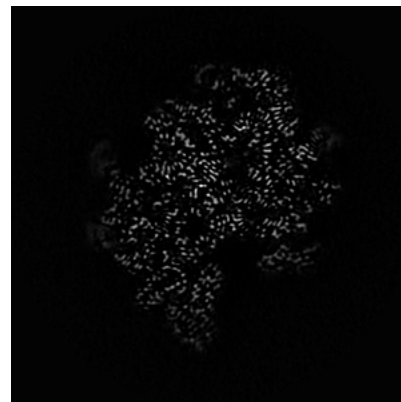

Z Index: 145

The images above show the largest variance slices of the map in three orthogonal directions.

6.4 Orthogonal surface views [i](#)

6.4.1 Primary map

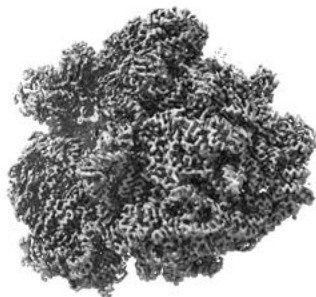

X

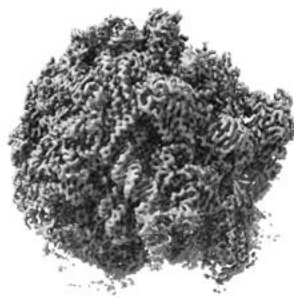

Y



Z

The images above show the 3D surface view of the map at the recommended contour level 0.03. These images, in conjunction with the slice images, may facilitate assessment of whether an appropriate contour level has been provided.

6.5 Mask visualisation

This section was not generated. No masks/segmentation were deposited.

7 Map analysis [i](#)

This section contains the results of statistical analysis of the map.

7.1 Map-value distribution [i](#)

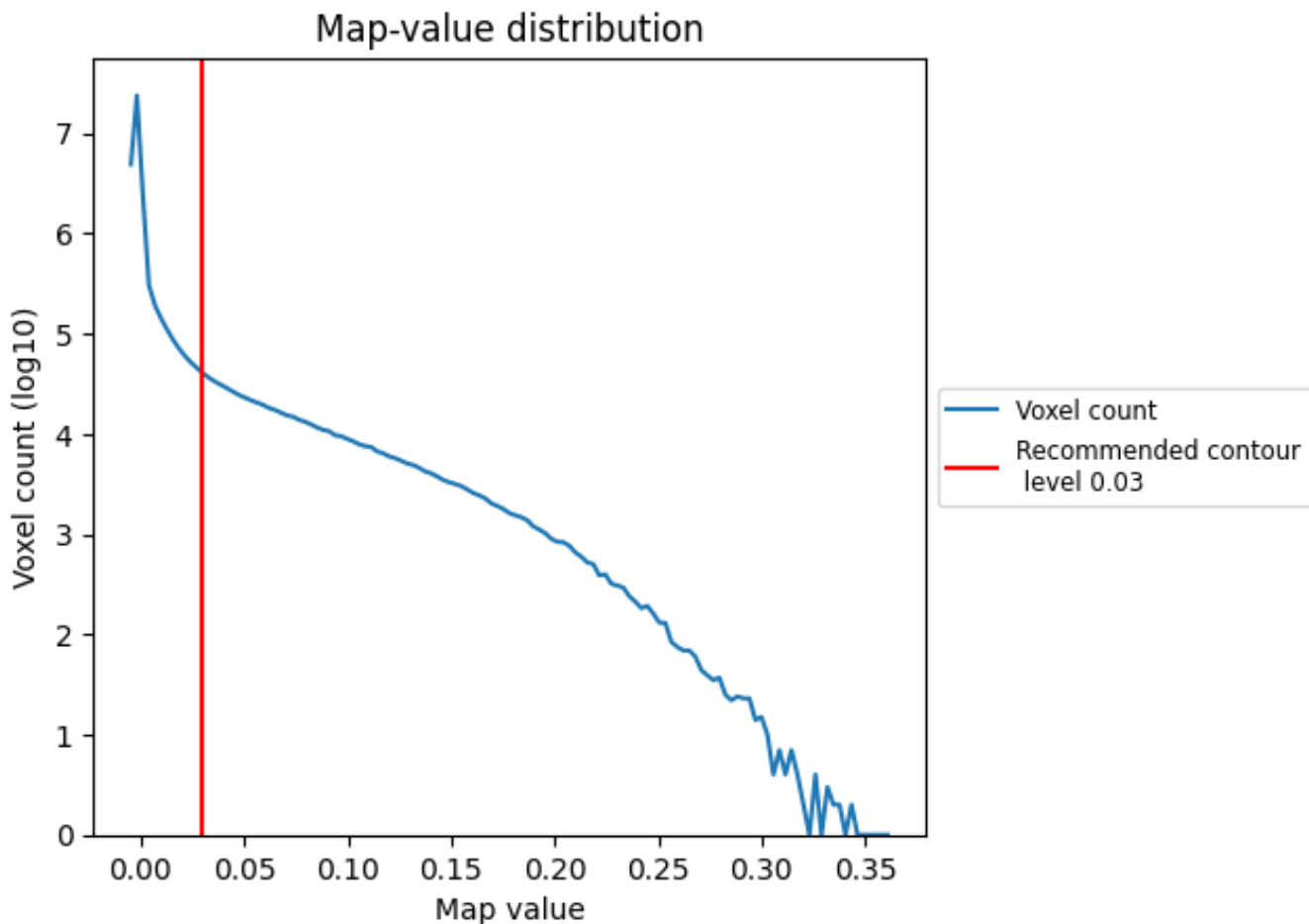

The map-value distribution is plotted in 128 intervals along the x-axis. The y-axis is logarithmic. A spike in this graph at zero usually indicates that the volume has been masked.

7.2 Volume estimate [i](#)

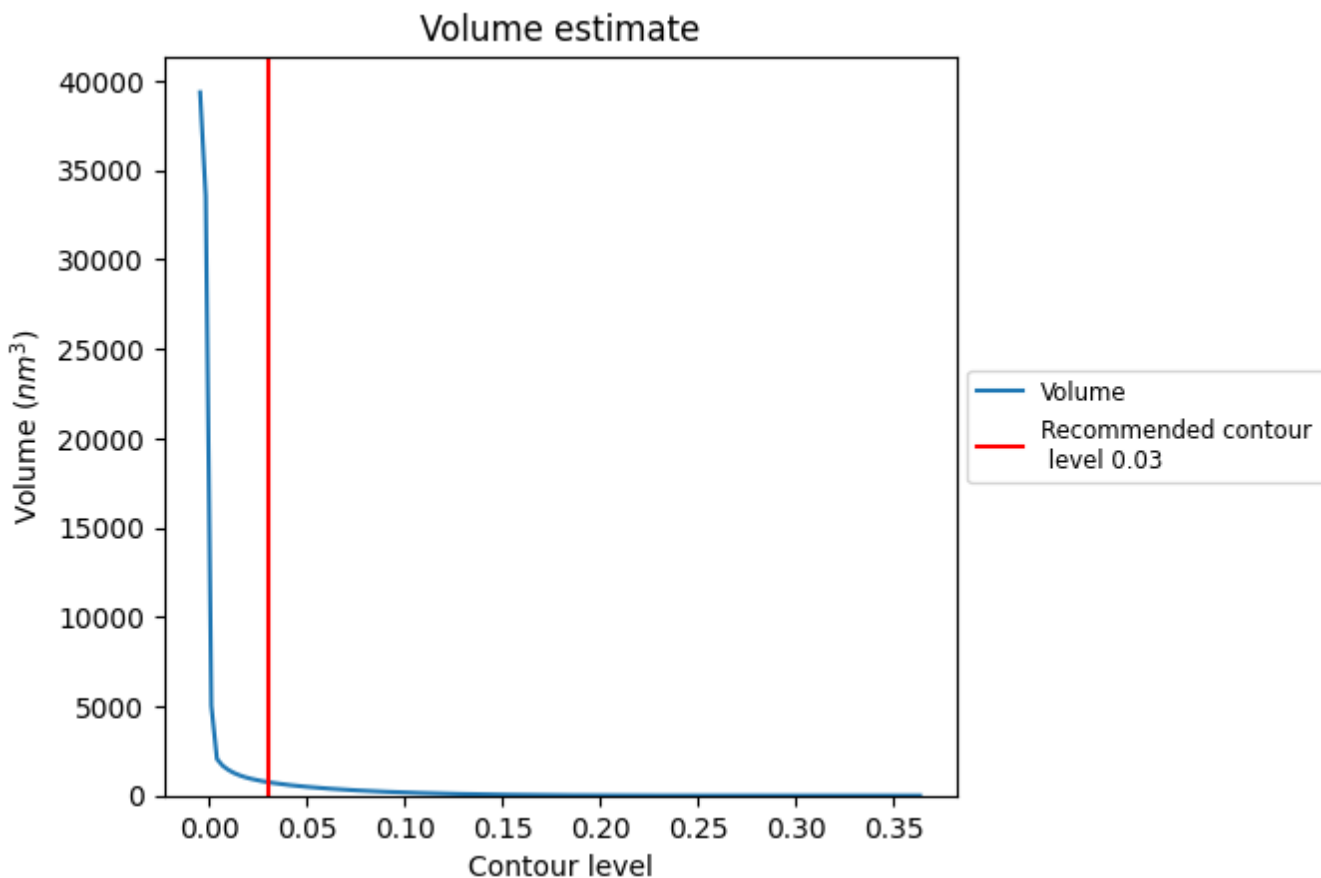

The volume at the recommended contour level is 751 nm^3 ; this corresponds to an approximate mass of 678 kDa.

The volume estimate graph shows how the enclosed volume varies with the contour level. The recommended contour level is shown as a vertical line and the intersection between the line and the curve gives the volume of the enclosed surface at the given level.

7.3 Rotationally averaged power spectrum [i](#)

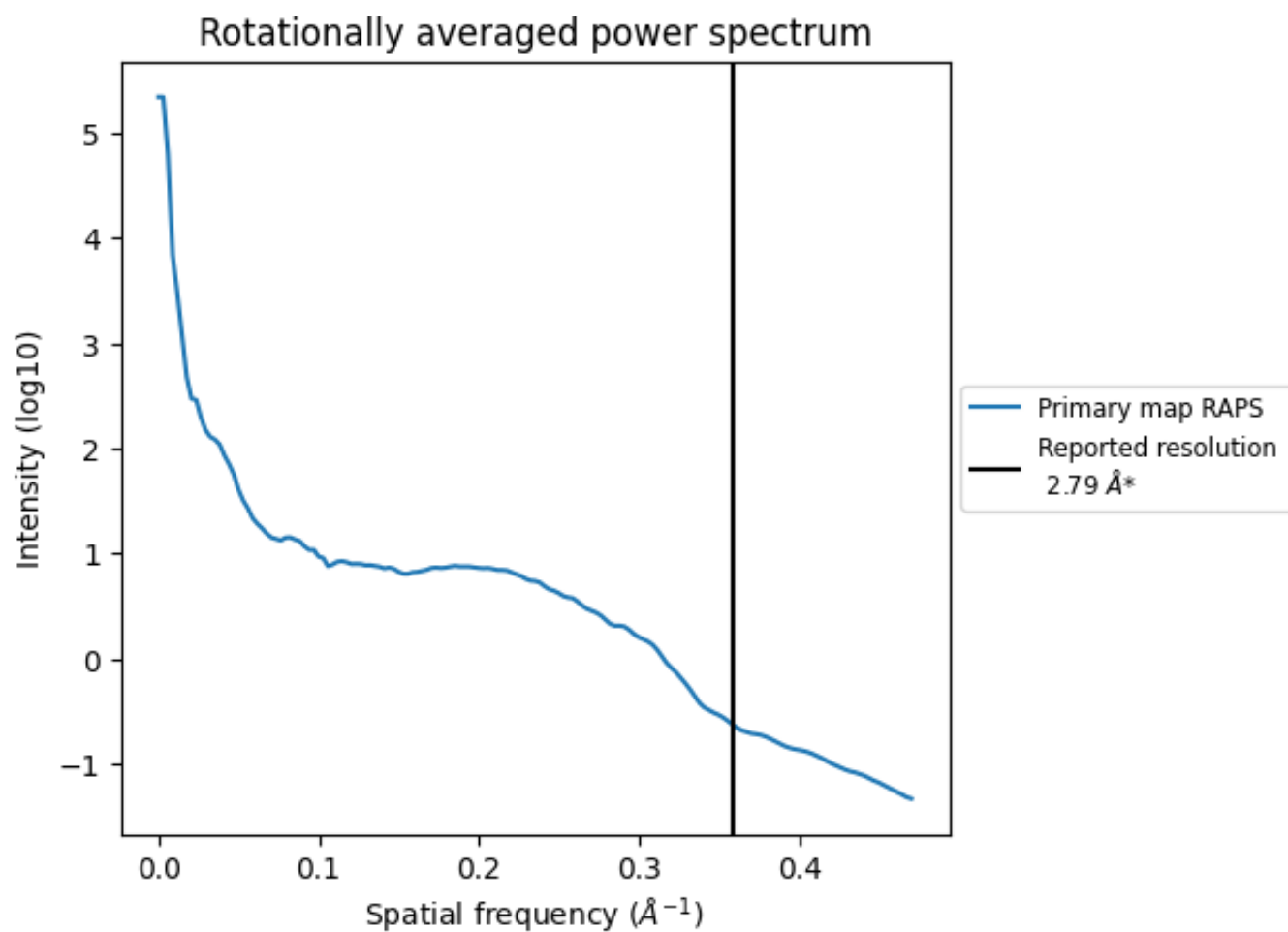

*Reported resolution corresponds to spatial frequency of 0.358 Å⁻¹

8 Fourier-Shell correlation [\(i\)](#)

Fourier-Shell Correlation (FSC) is the most commonly used method to estimate the resolution of single-particle and subtomogram-averaged maps. The shape of the curve depends on the imposed symmetry, mask and whether or not the two 3D reconstructions used were processed from a common reference. The reported resolution is shown as a black line. A curve is displayed for the half-bit criterion in addition to lines showing the 0.143 gold standard cut-off and 0.5 cut-off.

8.1 FSC [\(i\)](#)

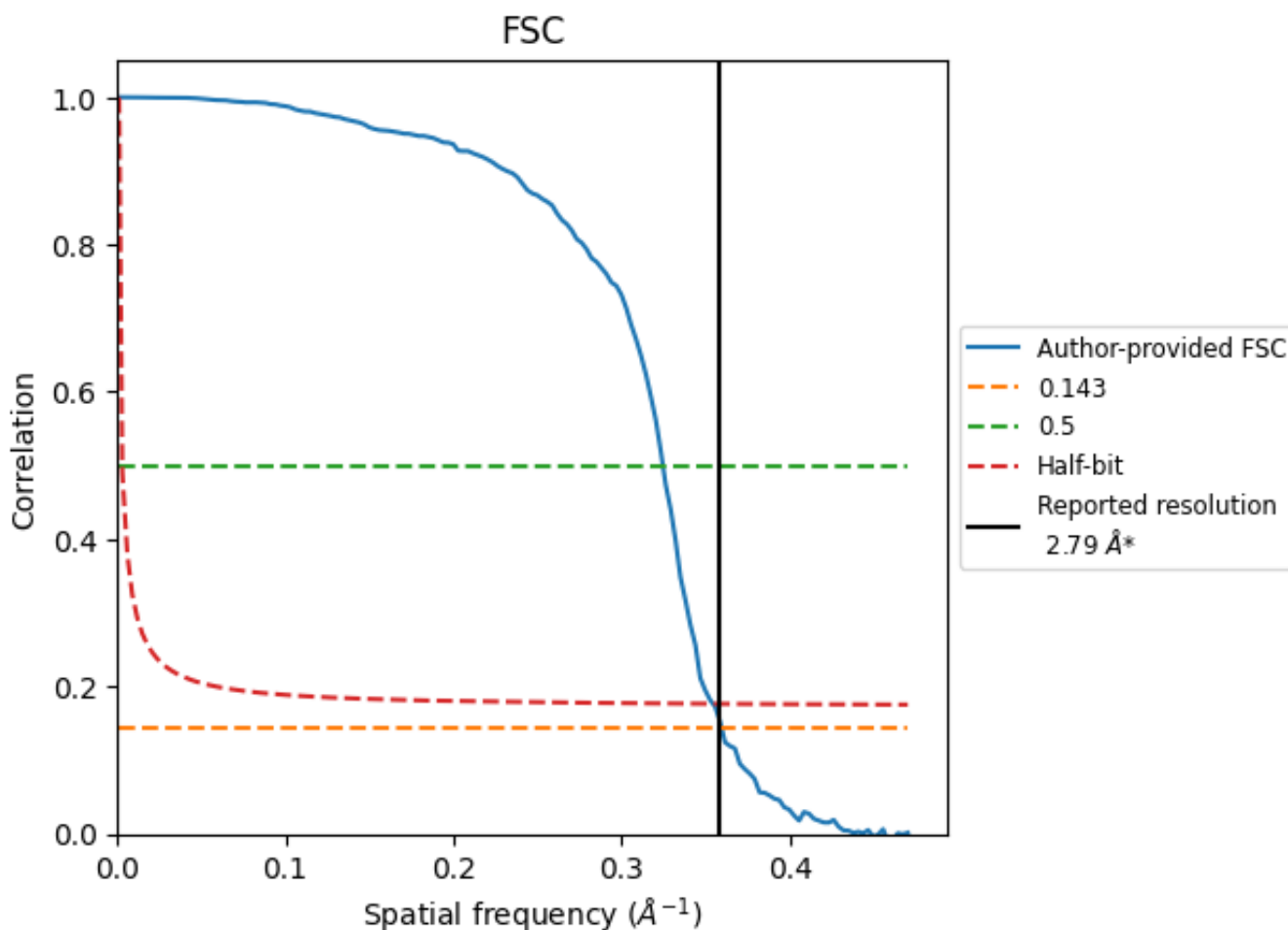

*Reported resolution corresponds to spatial frequency of 0.358 Å⁻¹

8.2 Resolution estimates [i](#)

Resolution estimate (Å)	Estimation criterion (FSC cut-off)		
	0.143	0.5	Half-bit
Reported by author	2.79	-	-
Author-provided FSC curve	2.78	3.08	2.82
Unmasked-calculated*	-	-	-

*Resolution estimate based on FSC curve calculated by comparison of deposited half-maps.

9 Map-model fit [i](#)

This section contains information regarding the fit between EMDB map EMD-23969 and PDB model 7MSM. Per-residue inclusion information can be found in section [3](#) on page [16](#).

9.1 Map-model overlay [i](#)

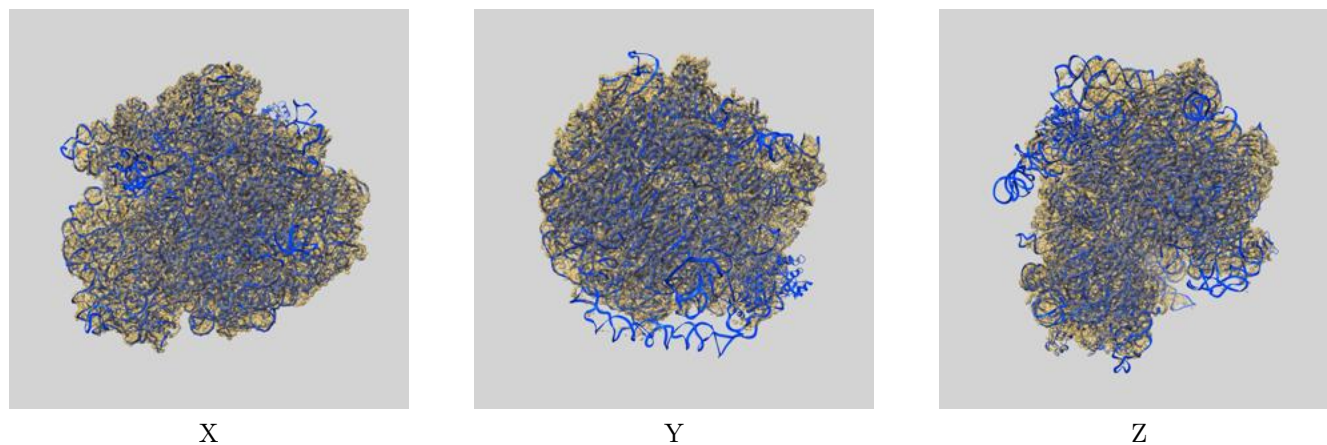

The images above show the 3D surface view of the map at the recommended contour level 0.03 at 50% transparency in yellow overlaid with a ribbon representation of the model coloured in blue. These images allow for the visual assessment of the quality of fit between the atomic model and the map.

9.2 Q-score mapped to coordinate model [i](#)

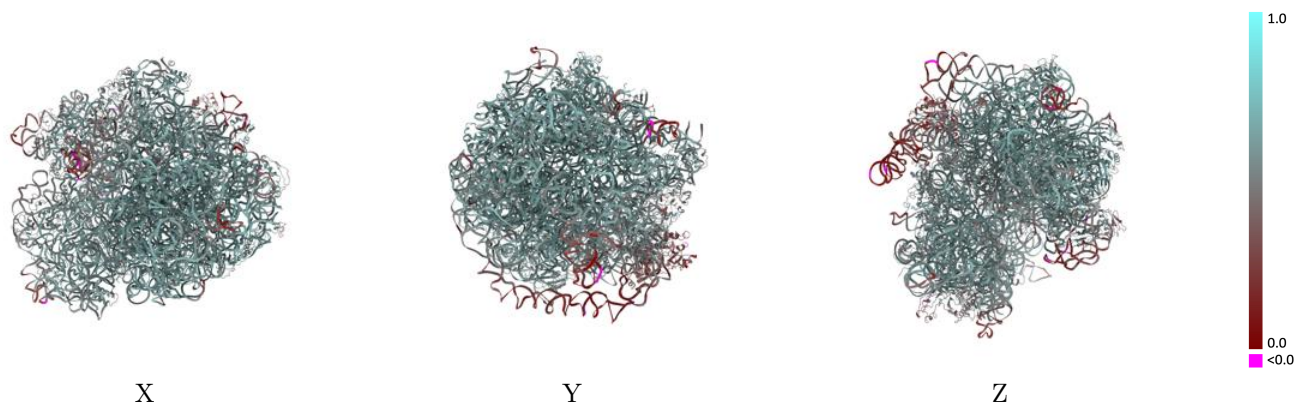

The images above show the model with each residue coloured according to its Q-score. This shows their resolvability in the map with higher Q-score values reflecting better resolvability. Please note: Q-score is calculating the resolvability of atoms, and thus high values are only expected at resolutions at which atoms can be resolved. Low Q-score values may therefore be expected for many entries.

9.3 Atom inclusion mapped to coordinate model [i](#)

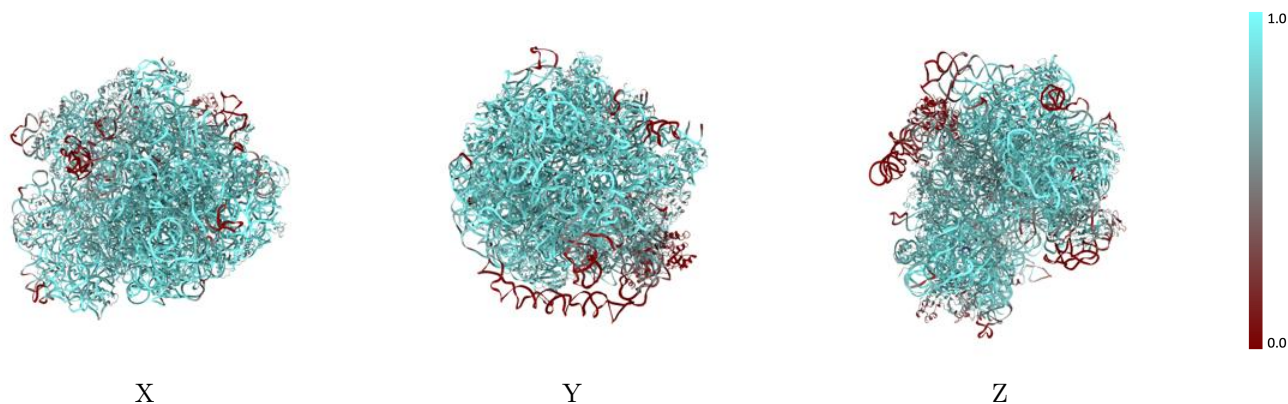

The images above show the model with each residue coloured according to its atom inclusion. This shows to what extent they are inside the map at the recommended contour level (0.03).



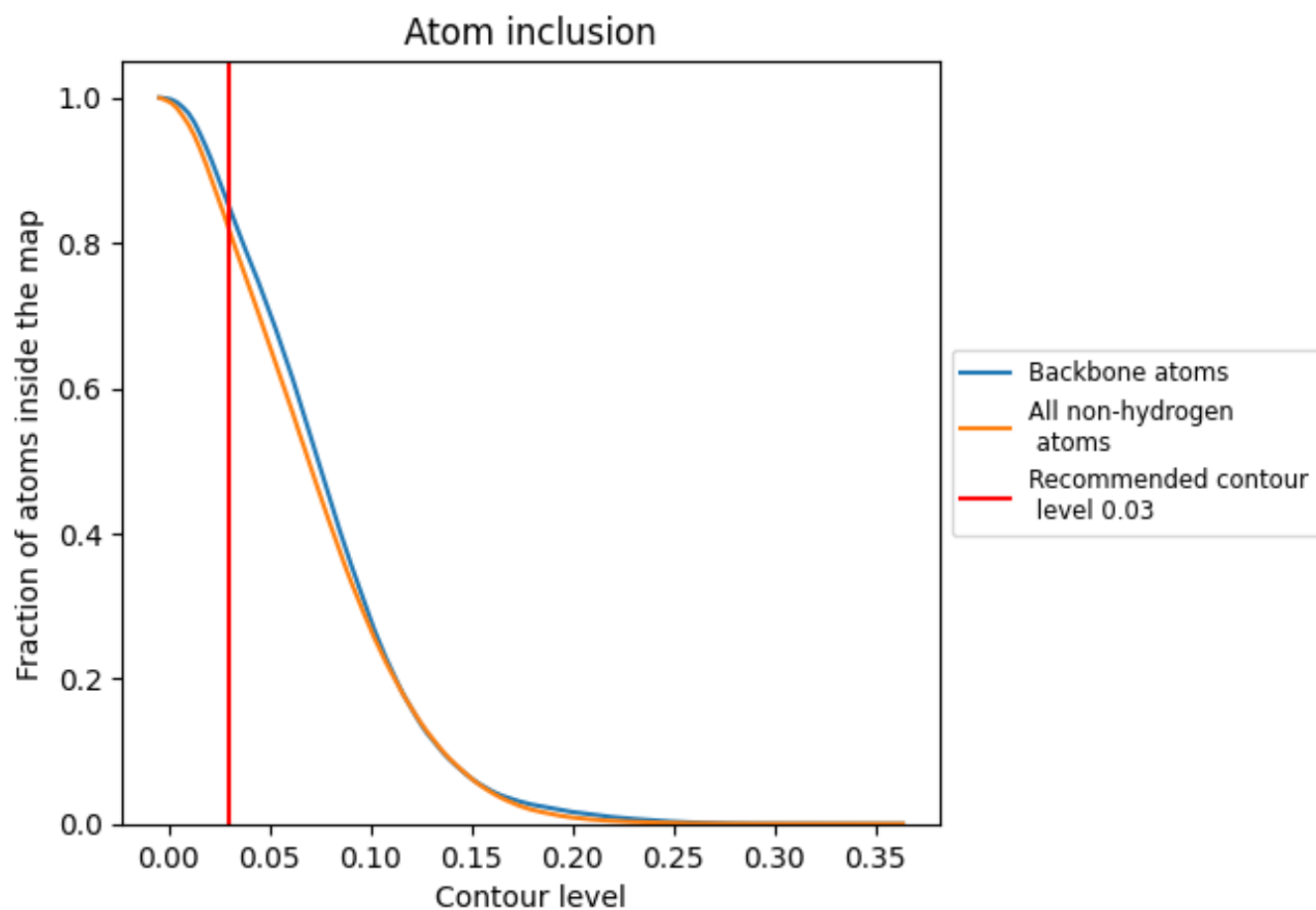



































































9.4 Atom inclusion [i](#)



At the recommended contour level, 85% of all backbone atoms, 82% of all non-hydrogen atoms, are inside the map.

9.5 Map-model fit summary











































The table lists the average atom inclusion at the recommended contour level (0.03) and Q-score for the entire model and for each chain.

Chain	Atom inclusion	Q-score
All	 0.8163	 0.5610
0	 0.8268	 0.5960
1	 0.8376	 0.5820
2	 0.9128	 0.6210
3	 0.8919	 0.6260
4	 0.8194	 0.5980
6	 0.6912	 0.4870
7	 0.3600	 0.5600
8	 0.1837	 0.3420
A	 0.8433	 0.5690
B	 0.8786	 0.5690
C	 0.8751	 0.6140
D	 0.8497	 0.5880
E	 0.8556	 0.5890
F	 0.6909	 0.5120
G	 0.5869	 0.4840
H	 0.3469	 0.4670
J	 0.8519	 0.5950
K	 0.8573	 0.5920
L	 0.8373	 0.5900
M	 0.7992	 0.5810
N	 0.8710	 0.6020
O	 0.8005	 0.5690
P	 0.8292	 0.5800
Q	 0.8841	 0.6090
R	 0.8409	 0.5900
S	 0.8773	 0.5970
T	 0.8069	 0.5640
U	 0.7871	 0.5450
V	 0.5297	 0.4760
W	 0.8682	 0.5790
X	 0.8877	 0.6000
Y	 0.7579	 0.5390
Z	 0.8484	 0.5850
a	 0.8837	 0.5740



Continued on next page...

Continued from previous page...

Chain	Atom inclusion	Q-score
c	 0.6646	 0.5010
d	 0.6001	 0.4660
e	 0.7580	 0.5530
f	 0.7218	 0.5430
g	 0.7435	 0.5440
h	 0.8023	 0.5630
i	 0.7101	 0.5190
j	 0.5547	 0.4460
k	 0.7564	 0.5450
l	 0.7459	 0.5210
m	 0.7056	 0.5240
n	 0.8289	 0.5700
o	 0.7815	 0.5540
p	 0.6787	 0.5100
q	 0.7349	 0.5190
r	 0.7642	 0.5470
s	 0.7110	 0.5310
t	 0.7319	 0.5400
x	 0.6017	 0.4980
y	 0.8442	 0.5730
z	 0.7517	 0.5010