



## Full wwPDB EM Validation Report ⓘ

Nov 19, 2022 – 12:08 pm GMT

PDB ID : 5LZT  
EMDB ID : EMD-4131  
Title : Structure of the mammalian ribosomal termination complex with eRF1 and eRF3.  
Authors : Shao, S.; Murray, J.; Brown, A.; Taunton, J.; Ramakrishnan, V.; Hegde, R.S.  
Deposited on : 2016-10-02  
Resolution : 3.65 Å(reported)

This is a Full wwPDB EM Validation Report for a publicly released PDB entry.

We welcome your comments at [validation@mail.wwpdb.org](mailto:validation@mail.wwpdb.org)

A user guide is available at

<https://www.wwpdb.org/validation/2017/EMValidationReportHelp>

with specific help available everywhere you see the ⓘ symbol.

The types of validation reports are described at

<http://www.wwpdb.org/validation/2017/FAQs#types>.

---

The following versions of software and data (see [references ⓘ](#)) were used in the production of this report:

EMDB validation analysis : 0.0.1.dev43  
Mogul : 1.8.4, CSD as541be (2020)  
MolProbity : 4.02b-467  
buster-report : 1.1.7 (2018)  
Percentile statistics : 20191225.v01 (using entries in the PDB archive December 25th 2019)  
MapQ : 1.9.9  
Ideal geometry (proteins) : Engh & Huber (2001)  
Ideal geometry (DNA, RNA) : Parkinson et al. (1996)  
Validation Pipeline (wwPDB-VP) : 2.31.2

# 1 Overall quality at a glance i

The following experimental techniques were used to determine the structure:  
*ELECTRON MICROSCOPY*

The reported resolution of this entry is 3.65 Å.

Percentile scores (ranging between 0-100) for global validation metrics of the entry are shown in the following graphic. The table shows the number of entries on which the scores are based.

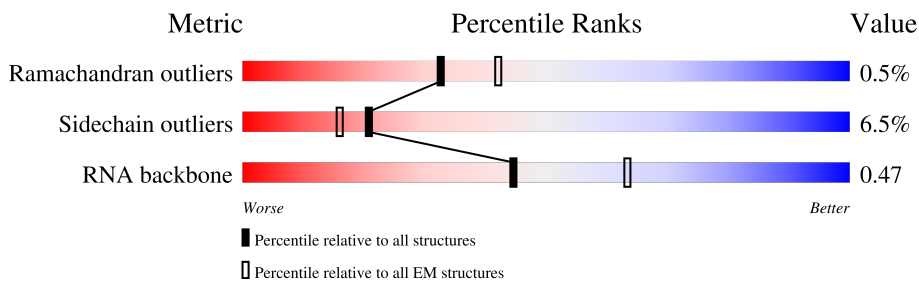











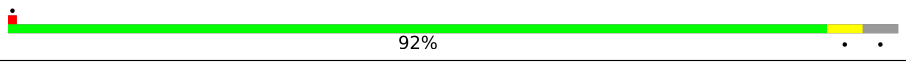
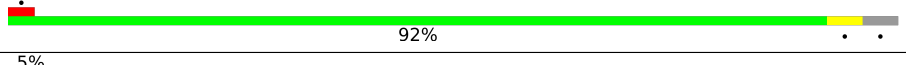
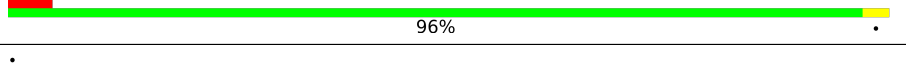

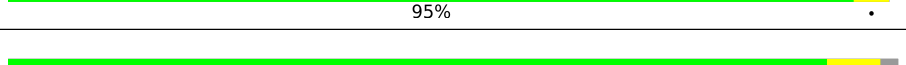
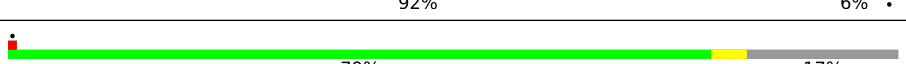
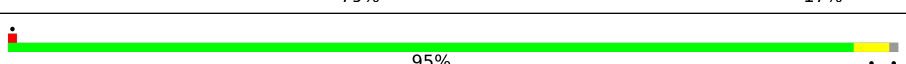
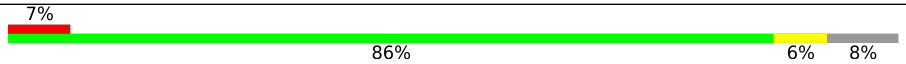
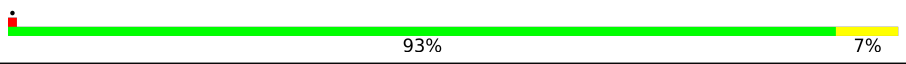
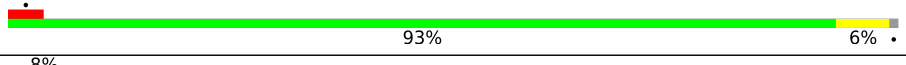
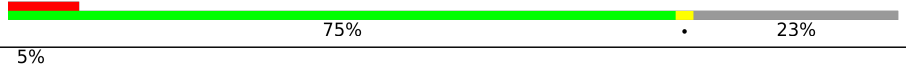
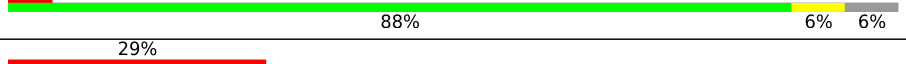
Metric	Whole archive (#Entries)	EM structures (#Entries)
Ramachandran outliers	154571	4023
Sidechain outliers	154315	3826
RNA backbone	4643	859

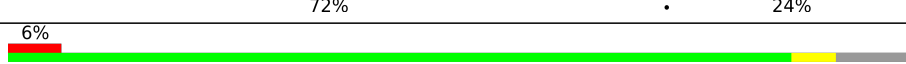
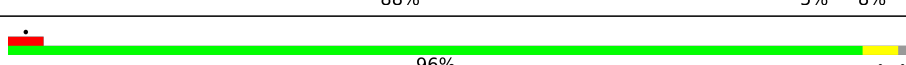
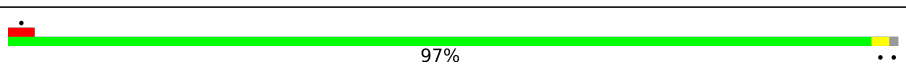
The table below summarises the geometric issues observed across the polymeric chains and their fit to the map. The red, orange, yellow and green segments of the bar indicate the fraction of residues that contain outliers for  $\geq 3$ , 2, 1 and 0 types of geometric quality criteria respectively. A grey segment represents the fraction of residues that are not modelled. The numeric value for each fraction is indicated below the corresponding segment, with a dot representing fractions  $\leq 5\%$ . The upper red bar (where present) indicates the fraction of residues that have poor fit to the EM map (all-atom inclusion  $< 40\%$ ). The numeric value is given above the bar.

Mol	Chain	Length	Quality of chain
1	A	257	
2	B	403	
3	C	425	
4	D	297	
5	E	291	
6	F	247	
7	G	319	
8	H	192	

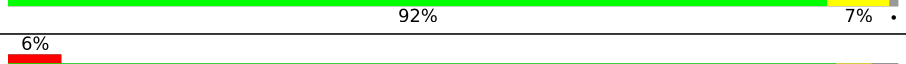

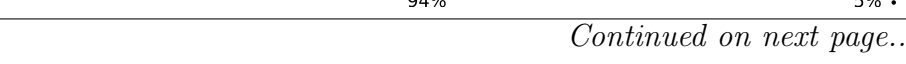







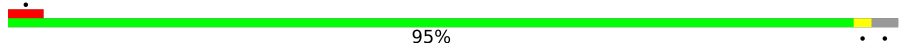

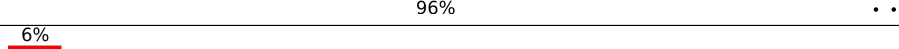

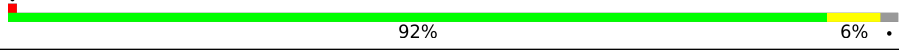
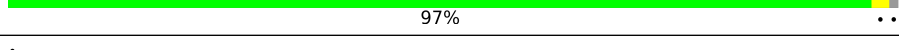

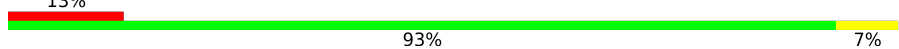

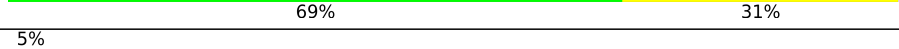

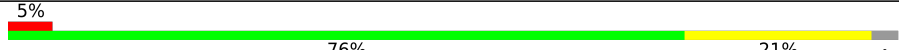
Continued on next page...

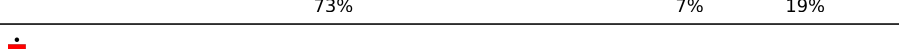
Continued from previous page...

Mol	Chain	Length	Quality of chain
9	I	214	 92%
10	J	178	 92%
11	L	211	 5% 96%
12	M	218	 5% 59% 5% 37%
13	N	204	 95%
14	O	203	 92% 6%
15	P	184	 79% 17%
16	Q	188	 95%
17	R	196	 7% 86% 6% 8%
18	S	176	 93% 7%
19	T	160	 8% 93% 6%
20	U	128	 8% 75% 23%
21	V	140	 5% 88% 6% 6%
22	W	157	 29% 66% 32%
23	X	156	 72% 24%
24	Y	145	 6% 88% 5% 8%
25	Z	136	 96%
26	a	148	 97%
27	b	245	 7% 41% 58%
28	c	115	 7% 83% 15%
29	d	125	 5% 79% 6% 14%
30	e	135	 88% 7% 5%
31	f	110	 92% 7%
32	g	117	 6% 93%
33	h	123	 94% 5%

Continued on next page...

Continued from previous page...

Mol	Chain	Length	Quality of chain
34	i	105	 95%
35	j	97	 84% 5% 11%
36	k	70	 6% 96%
37	l	51	 6% 96%
38	m	102	 48% 49%
39	n	25	 8% 92% 8%
40	o	106	 92% 6%
41	p	92	 97%
42	r	137	 85% 5% 9%
43	s	318	 49% 59% 38%
44	t	165	 82% 88% 7%
45	1	15	 13% 93% 7%
46	2	76	 83% 17%
47	3	75	 51% 69% 31%
48	5	3543	 5% 74% 26%
49	7	120	 87% 13%
50	8	156	 5% 76% 21%
51	9	1869	 6% 67% 23% 9%
52	AA	295	 6% 69% 26%
53	BB	264	 73% 7% 19%
54	CC	293	 71% 25%
55	DD	243	 9% 87% 7% 6%
56	EE	263	 5% 91% 8%
57	FF	204	 83% 8% 9%
58	GG	249	21% 89% 6% 5%



Continued on next page...

Continued from previous page...

Mol	Chain	Length	Quality of chain
59	HH	194	
60	II	208	
61	JJ	194	
62	KK	165	
63	LL	158	
64	MM	132	
65	NN	151	
66	OO	168	
67	PP	145	
68	QQ	146	
69	RR	135	
70	SS	152	
71	TT	145	
72	UU	119	
73	VV	83	
74	WW	130	
75	XX	143	
76	YY	130	
77	ZZ	125	
78	aa	115	
79	bb	84	
80	cc	69	
81	dd	56	
82	ee	133	
83	ff	156	

Continued on next page...

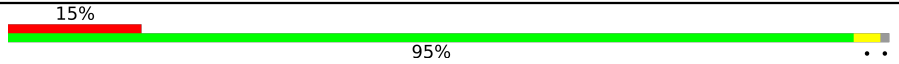
*Continued from previous page...*

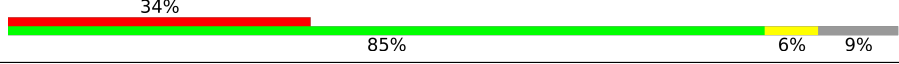
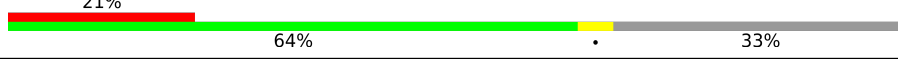
Mol	Chain	Length	Quality of chain
84	gg	317	
85	hh	15	
86	ii	459	
87	jj	637	

## 2 Entry composition [i](#)

There are 90 unique types of molecules in this entry. The entry contains 222683 atoms, of which 0 are hydrogens and 0 are deuteriums.

In the tables below, the AltConf column contains the number of residues with at least one atom in alternate conformation and the Trace column contains the number of residues modelled with at most 2 atoms.

- Molecule 1 is a protein called uL2.

Mol	Chain	Residues	Atoms					AltConf	Trace
			Total	C	N	O	S		
1	A	248	Total	C	N	O	S	0	0
			1898	1189	389	314	6		

- Molecule 2 is a protein called uL3.

Mol	Chain	Residues	Atoms					AltConf	Trace
			Total	C	N	O	S		
2	B	394	Total	C	N	O	S	0	0
			3172	2020	597	542	13		

There is a discrepancy between the modelled and reference sequences:

Chain	Residue	Modelled	Actual	Comment	Reference
B	1	MET	GLN	initiating methionine	UNP G1TL06

- Molecule 3 is a protein called uL4.

Mol	Chain	Residues	Atoms					AltConf	Trace
			Total	C	N	O	S		
3	C	362	Total	C	N	O	S	0	0
			2883	1812	577	480	14		

- Molecule 4 is a protein called uL18.

Mol	Chain	Residues	Atoms					AltConf	Trace
			Total	C	N	O	S		
4	D	293	Total	C	N	O	S	0	0
			2391	1512	438	427	14		

There is a discrepancy between the modelled and reference sequences:

Chain	Residue	Modelled	Actual	Comment	Reference
D	1	MET	LYS	initiating methionine	UNP G1SYJ6

- Molecule 5 is a protein called eL6.

Mol	Chain	Residues	Atoms					AltConf	Trace
			Total	C	N	O	S		
5	E	216	1729	1115	329	282	3	0	0

- Molecule 6 is a protein called uL30.

Mol	Chain	Residues	Atoms					AltConf	Trace
			Total	C	N	O	S		
6	F	225	1875	1205	358	303	9	0	0

There are 4 discrepancies between the modelled and reference sequences:

Chain	Residue	Modelled	Actual	Comment	Reference
F	61	ARG	GLY	conflict	UNP G1TUB1
F	93	ARG	GLY	conflict	UNP G1TUB1
F	131	MET	VAL	conflict	UNP G1TUB1
F	153	ILE	VAL	conflict	UNP G1TUB1

- Molecule 7 is a protein called eL8.

Mol	Chain	Residues	Atoms					AltConf	Trace
			Total	C	N	O	S		
7	G	233	1879	1199	361	315	4	0	0

There is a discrepancy between the modelled and reference sequences:

Chain	Residue	Modelled	Actual	Comment	Reference
G	244	GLY	CYS	conflict	UNP G1STW0

- Molecule 8 is a protein called uL6.

Mol	Chain	Residues	Atoms					AltConf	Trace
			Total	C	N	O	S		
8	H	190	1516	954	284	272	6	0	0

- Molecule 9 is a protein called uL16.

Mol	Chain	Residues	Atoms					AltConf	Trace
			Total	C	N	O	S		
9	I	205	1664	1056	321	274	13	0	0

- Molecule 10 is a protein called uL5.



Mol	Chain	Residues	Atoms					AltConf	Trace
10	J	170	Total	C	N	O	S	0	0
			1362	861	254	241	6		

- Molecule 11 is a protein called eL13.

Mol	Chain	Residues	Atoms					AltConf	Trace
11	L	210	Total	C	N	O	S	0	0
			1702	1065	354	279	4		

- Molecule 12 is a protein called eL14.

Mol	Chain	Residues	Atoms					AltConf	Trace
12	M	138	Total	C	N	O	S	0	0
			1137	727	221	182	7		

- Molecule 13 is a protein called eL15.

Mol	Chain	Residues	Atoms					AltConf	Trace
13	N	203	Total	C	N	O	S	0	0
			1701	1072	359	266	4		

- Molecule 14 is a protein called uL13.

Mol	Chain	Residues	Atoms					AltConf	Trace
14	O	199	Total	C	N	O	S	0	0
			1630	1051	319	255	5		

- Molecule 15 is a protein called uL22.

Mol	Chain	Residues	Atoms					AltConf	Trace
15	P	153	Total	C	N	O	S	0	0
			1242	777	241	215	9		

- Molecule 16 is a protein called eL18.

Mol	Chain	Residues	Atoms					AltConf	Trace
16	Q	187	Total	C	N	O	S	0	0
			1515	946	315	250	4		

- Molecule 17 is a protein called eL19.

Mol	Chain	Residues	Atoms					AltConf	Trace
17	R	180	Total	C	N	O	S	0	0
			1508	933	328	238	9		

- Molecule 18 is a protein called eL20.

Mol	Chain	Residues	Atoms					AltConf	Trace
18	S	176	Total	C	N	O	S	0	0
			1462	930	285	236	11		

- Molecule 19 is a protein called eL21.

Mol	Chain	Residues	Atoms					AltConf	Trace
19	T	159	Total	C	N	O	S	0	0
			1298	823	252	217	6		

- Molecule 20 is a protein called eL22.

Mol	Chain	Residues	Atoms					AltConf	Trace
20	U	99	Total	C	N	O	S	0	0
			809	519	141	147	2		

- Molecule 21 is a protein called uL14.

Mol	Chain	Residues	Atoms					AltConf	Trace
21	V	131	Total	C	N	O	S	0	0
			979	618	184	172	5		

- Molecule 22 is a protein called eL24.

Mol	Chain	Residues	Atoms					AltConf	Trace
22	W	106	Total	C	N	O	S	0	0
			860	538	174	144	4		

- Molecule 23 is a protein called uL23.

Mol	Chain	Residues	Atoms					AltConf	Trace
23	X	118	Total	C	N	O	S	0	0
			967	618	181	167	1		

- Molecule 24 is a protein called uL24.

Mol	Chain	Residues	Atoms					AltConf	Trace
			Total	C	N	O	S		
24	Y	134	1115	700	226	186	3	0	0

- Molecule 25 is a protein called eL27.

Mol	Chain	Residues	Atoms					AltConf	Trace
			Total	C	N	O	S		
25	Z	135	1107	714	208	182	3	0	0

- Molecule 26 is a protein called uL15.

Mol	Chain	Residues	Atoms					AltConf	Trace
			Total	C	N	O	S		
26	a	147	1162	734	239	185	4	0	0

There is a discrepancy between the modelled and reference sequences:

Chain	Residue	Modelled	Actual	Comment	Reference
a	1	MET	GLN	conflict	UNP G1SNY0

- Molecule 27 is a protein called eL29.

Mol	Chain	Residues	Atoms					AltConf	Trace
			Total	C	N	O	S		
27	b	104	848	527	189	129	3	0	0

- Molecule 28 is a protein called eL30.

Mol	Chain	Residues	Atoms					AltConf	Trace
			Total	C	N	O	S		
28	c	98	761	481	134	140	6	0	0

- Molecule 29 is a protein called eL31.

Mol	Chain	Residues	Atoms					AltConf	Trace
			Total	C	N	O	S		
29	d	107	888	560	171	155	2	0	0

- Molecule 30 is a protein called eL32.

Mol	Chain	Residues	Atoms					AltConf	Trace
			Total	C	N	O	S		
30	e	128	1053	667	216	165	5	0	0

- Molecule 31 is a protein called eL33.

Mol	Chain	Residues	Atoms					AltConf	Trace
			Total	C	N	O	S		
31	f	109	876	555	174	143	4	0	0

- Molecule 32 is a protein called eL34.

Mol	Chain	Residues	Atoms					AltConf	Trace
			Total	C	N	O	S		
32	g	114	906	566	187	147	6	0	0

There is a discrepancy between the modelled and reference sequences:

Chain	Residue	Modelled	Actual	Comment	Reference
g	117	LYS	-	insertion	UNP G1U945

- Molecule 33 is a protein called uL29.

Mol	Chain	Residues	Atoms					AltConf	Trace
			Total	C	N	O	S		
33	h	122	1013	640	204	168	1	0	0

- Molecule 34 is a protein called eL36.

Mol	Chain	Residues	Atoms					AltConf	Trace
			Total	C	N	O	S		
34	i	102	830	520	176	129	5	0	0

- Molecule 35 is a protein called eL37.

Mol	Chain	Residues	Atoms					AltConf	Trace
			Total	C	N	O	S		
35	j	86	705	434	155	111	5	0	0

- Molecule 36 is a protein called eL38.

Mol	Chain	Residues	Atoms					AltConf	Trace
36	k	69	Total	C	N	O	S	0	0
			569	366	103	99	1		

- Molecule 37 is a protein called eL39.

Mol	Chain	Residues	Atoms					AltConf	Trace
37	l	50	Total	C	N	O	S	0	0
			447	286	96	64	1		

- Molecule 38 is a protein called eL40.

Mol	Chain	Residues	Atoms					AltConf	Trace
38	m	52	Total	C	N	O	S	0	0
			429	266	90	67	6		

- Molecule 39 is a protein called eL41.

Mol	Chain	Residues	Atoms					AltConf	Trace
39	n	25	Total	C	N	O	S	0	0
			239	145	64	27	3		

- Molecule 40 is a protein called eL42.

Mol	Chain	Residues	Atoms					AltConf	Trace
40	o	104	Total	C	N	O	S	0	0
			851	533	174	138	6		

- Molecule 41 is a protein called eL43.

Mol	Chain	Residues	Atoms					AltConf	Trace
41	p	91	Total	C	N	O	S	0	0
			708	445	136	120	7		

- Molecule 42 is a protein called eL28.

Mol	Chain	Residues	Atoms					AltConf	Trace
42	r	124	Total	C	N	O	S	0	0
			994	616	205	167	6		

- Molecule 43 is a protein called uL10.

Mol	Chain	Residues	Atoms					AltConf	Trace
43	s	196	Total	C	N	O	S	0	0
			1507	959	263	276	9		

- Molecule 44 is a protein called uL11.

Mol	Chain	Residues	Atoms					AltConf	Trace
44	t	153	Total	C	N	O	S	0	0
			1160	722	218	217	3		

- Molecule 45 is a protein called Nascent chain.

Mol	Chain	Residues	Atoms					AltConf	Trace
45	1	15	Total	C	N	O	S	0	0
			125	82	20	22	1		

- Molecule 46 is a RNA chain called P-site tRNA.

Mol	Chain	Residues	Atoms					AltConf	Trace
46	2	76	Total	C	N	O	P	0	0
			1616	723	291	527	75		

- Molecule 47 is a RNA chain called E-site tRNA.

Mol	Chain	Residues	Atoms					AltConf	Trace
47	3	75	Total	C	N	O	P	0	0
			1593	712	281	526	74		

- Molecule 48 is a RNA chain called 28S ribosomal RNA.

Mol	Chain	Residues	Atoms					AltConf	Trace
48	5	3543	Total	C	N	O	P	0	0
			75972	33833	13910	24686	3543		

- Molecule 49 is a RNA chain called 5S ribosomal RNA.

Mol	Chain	Residues	Atoms					AltConf	Trace
49	7	120	Total	C	N	O	P	0	0
			2558	1141	456	842	119		

- Molecule 50 is a RNA chain called 5.8S ribosomal RNA.

Mol	Chain	Residues	Atoms					AltConf	Trace
50	8	151	Total	C	N	O	P	0	0
			3208	1432	564	1062	150		

- Molecule 51 is a RNA chain called 18S ribosomal RNA.

Mol	Chain	Residues	Atoms					AltConf	Trace
51	9	1698	Total	C	N	O	P	0	0
			36249	16180	6508	11864	1697		

- Molecule 52 is a protein called uS2.

Mol	Chain	Residues	Atoms					AltConf	Trace
52	AA	217	Total	C	N	O	S	0	0
			1710	1086	300	316	8		

- Molecule 53 is a protein called eS1.

Mol	Chain	Residues	Atoms					AltConf	Trace
53	BB	213	Total	C	N	O	S	0	0
			1729	1098	309	308	14		

- Molecule 54 is a protein called uS5.

Mol	Chain	Residues	Atoms					AltConf	Trace
54	CC	221	Total	C	N	O	S	0	0
			1716	1111	295	301	9		

- Molecule 55 is a protein called uS3.

Mol	Chain	Residues	Atoms					AltConf	Trace
55	DD	228	Total	C	N	O	S	0	0
			1768	1126	318	316	8		

- Molecule 56 is a protein called eS4.

Mol	Chain	Residues	Atoms					AltConf	Trace
56	EE	262	Total	C	N	O	S	0	0
			2076	1324	386	358	8		

- Molecule 57 is a protein called uS7.

Mol	Chain	Residues	Atoms					AltConf	Trace
57	FF	185	Total	C	N	O	S	0	0
			1471	921	277	266	7		

- Molecule 58 is a protein called eS6.

Mol	Chain	Residues	Atoms					AltConf	Trace
58	GG	237	Total	C	N	O	S	0	0
			1923	1200	387	329	7		

- Molecule 59 is a protein called eS7.

Mol	Chain	Residues	Atoms					AltConf	Trace
59	HH	185	Total	C	N	O	S	0	0
			1488	952	271	264	1		

- Molecule 60 is a protein called eS8.

Mol	Chain	Residues	Atoms					AltConf	Trace
60	II	206	Total	C	N	O	S	0	0
			1686	1058	332	291	5		

There is a discrepancy between the modelled and reference sequences:

Chain	Residue	Modelled	Actual	Comment	Reference
II	47	ARG	GLY	conflict	UNP G1TJW1

- Molecule 61 is a protein called uS4.

Mol	Chain	Residues	Atoms					AltConf	Trace
61	JJ	185	Total	C	N	O	S	0	0
			1525	969	306	248	2		

- Molecule 62 is a protein called eS10.

Mol	Chain	Residues	Atoms					AltConf	Trace
62	KK	96	Total	C	N	O	S	0	0
			810	530	143	131	6		

- Molecule 63 is a protein called uS17.



Mol	Chain	Residues	Atoms					AltConf	Trace
			Total	C	N	O	S		
63	LL	143	1175	749	222	198	6	0	0

- Molecule 64 is a protein called eS12.

Mol	Chain	Residues	Atoms					AltConf	Trace
			Total	C	N	O	S		
64	MM	117	908	570	161	169	8	0	0

- Molecule 65 is a protein called uS15.

Mol	Chain	Residues	Atoms					AltConf	Trace
			Total	C	N	O	S		
65	NN	149	1202	770	228	203	1	0	0

- Molecule 66 is a protein called uS11.

Mol	Chain	Residues	Atoms					AltConf	Trace
			Total	C	N	O	S		
66	OO	136	1016	621	199	190	6	0	0

- Molecule 67 is a protein called uS19.

Mol	Chain	Residues	Atoms					AltConf	Trace
			Total	C	N	O	S		
67	PP	120	997	635	187	168	7	0	0

- Molecule 68 is a protein called uS9.

Mol	Chain	Residues	Atoms					AltConf	Trace
			Total	C	N	O	S		
68	QQ	142	1128	717	213	195	3	0	0

- Molecule 69 is a protein called eS17.

Mol	Chain	Residues	Atoms					AltConf	Trace
			Total	C	N	O	S		
69	RR	132	1068	670	199	195	4	0	0

- Molecule 70 is a protein called uS13.

Mol	Chain	Residues	Atoms					AltConf	Trace
70	SS	144	Total	C	N	O	S	0	0
			1190	746	241	202	1		

- Molecule 71 is a protein called eS19.

Mol	Chain	Residues	Atoms					AltConf	Trace
71	TT	141	Total	C	N	O	S	0	0
			1097	688	211	195	3		

There is a discrepancy between the modelled and reference sequences:

Chain	Residue	Modelled	Actual	Comment	Reference
TT	119	GLY	TRP	conflict	UNP G1TN62

- Molecule 72 is a protein called uS10.

Mol	Chain	Residues	Atoms					AltConf	Trace
72	UU	100	Total	C	N	O	S	0	0
			795	498	152	141	4		

- Molecule 73 is a protein called eS21.

Mol	Chain	Residues	Atoms					AltConf	Trace
73	VV	83	Total	C	N	O	S	0	0
			636	393	117	121	5		

- Molecule 74 is a protein called uS8.

Mol	Chain	Residues	Atoms					AltConf	Trace
74	WW	129	Total	C	N	O	S	0	0
			1034	659	193	176	6		

- Molecule 75 is a protein called uS12.

Mol	Chain	Residues	Atoms					AltConf	Trace
75	XX	141	Total	C	N	O	S	0	0
			1098	693	219	183	3		

- Molecule 76 is a protein called eS24.

Mol	Chain	Residues	Atoms					AltConf	Trace
76	YY	124	Total	C	N	O	S	0	0
			1011	640	198	168	5		

- Molecule 77 is a protein called eS25.

Mol	Chain	Residues	Atoms					AltConf	Trace
77	ZZ	75	Total	C	N	O	S	0	0
			598	382	111	104	1		

- Molecule 78 is a protein called eS26.

Mol	Chain	Residues	Atoms					AltConf	Trace
78	aa	101	Total	C	N	O	S	0	0
			814	507	170	132	5		

- Molecule 79 is a protein called eS27.

Mol	Chain	Residues	Atoms					AltConf	Trace
79	bb	83	Total	C	N	O	S	0	0
			651	408	121	115	7		

- Molecule 80 is a protein called eS28.

Mol	Chain	Residues	Atoms					AltConf	Trace
80	cc	62	Total	C	N	O	S	0	0
			488	297	97	92	2		

- Molecule 81 is a protein called uS14.

Mol	Chain	Residues	Atoms					AltConf	Trace
81	dd	55	Total	C	N	O	S	0	0
			459	286	94	74	5		

- Molecule 82 is a protein called eS30.

Mol	Chain	Residues	Atoms					AltConf	Trace
82	ee	55	Total	C	N	O	S	0	0
			443	274	97	71	1		

- Molecule 83 is a protein called eS31.

Mol	Chain	Residues	Atoms					AltConf	Trace
			Total	C	N	O	S		
83	ff	68	555	351	103	94	7	0	0

- Molecule 84 is a protein called RACK1.

Mol	Chain	Residues	Atoms					AltConf	Trace
			Total	C	N	O	S		
84	gg	313	2436	1535	424	465	12	0	0

- Molecule 85 is a RNA chain called mRNA (UGA stop codon).

Mol	Chain	Residues	Atoms					AltConf	Trace
			Total	C	N	O	P		
85	hh	15	317	142	54	106	15	0	0

- Molecule 86 is a protein called eRF1.

Mol	Chain	Residues	Atoms					AltConf	Trace
			Total	C	N	O	S		
86	ii	419	3307	2104	562	629	12	0	0

There are 22 discrepancies between the modelled and reference sequences:

Chain	Residue	Modelled	Actual	Comment	Reference
ii	-21	MET	-	initiating methionine	UNP P62495
ii	-20	ARG	-	expression tag	UNP P62495
ii	-19	GLY	-	expression tag	UNP P62495
ii	-18	SER	-	expression tag	UNP P62495
ii	-17	HIS	-	expression tag	UNP P62495
ii	-16	HIS	-	expression tag	UNP P62495
ii	-15	HIS	-	expression tag	UNP P62495
ii	-14	HIS	-	expression tag	UNP P62495
ii	-13	HIS	-	expression tag	UNP P62495
ii	-12	HIS	-	expression tag	UNP P62495
ii	-11	GLY	-	expression tag	UNP P62495
ii	-10	MET	-	expression tag	UNP P62495
ii	-9	ALA	-	expression tag	UNP P62495
ii	-8	SER	-	expression tag	UNP P62495
ii	-7	GLU	-	expression tag	UNP P62495
ii	-6	ASN	-	expression tag	UNP P62495
ii	-5	LEU	-	expression tag	UNP P62495
ii	-4	TYR	-	expression tag	UNP P62495
ii	-3	PHE	-	expression tag	UNP P62495

*Continued on next page...*

*Continued from previous page...*

Chain	Residue	Modelled	Actual	Comment	Reference
ii	-2	GLN	-	expression tag	UNP P62495
ii	-1	GLY	-	expression tag	UNP P62495
ii	0	SER	-	expression tag	UNP P62495

- Molecule 87 is a protein called eRF3a.

Mol	Chain	Residues	Atoms					AltConf	Trace
			Total	C	N	O	S		
87	jj	428	3368	2144	580	623	21	0	0

There is a discrepancy between the modelled and reference sequences:

Chain	Residue	Modelled	Actual	Comment	Reference
jj	100	ALA	VAL	conflict	UNP P15170

- Molecule 88 is MAGNESIUM ION (three-letter code: MG) (formula: Mg).

Mol	Chain	Residues	Atoms		AltConf
88	A	1	Total 1	Mg 1	0
88	B	1	Total 1	Mg 1	0
88	I	1	Total 1	Mg 1	0
88	P	3	Total 3	Mg 3	0
88	Q	1	Total 1	Mg 1	0
88	V	1	Total 1	Mg 1	0
88	a	1	Total 1	Mg 1	0
88	g	1	Total 1	Mg 1	0
88	j	1	Total 1	Mg 1	0
88	5	185	Total 185	Mg 185	0
88	7	5	Total 5	Mg 5	0
88	8	8	Total 8	Mg 8	0

*Continued on next page...*

*Continued from previous page...*

Mol	Chain	Residues	Atoms		AltConf
88	9	71	Total 71	Mg 71	0
88	hh	1	Total 1	Mg 1	0
88	jj	1	Total 1	Mg 1	0

- Molecule 89 is ZINC ION (three-letter code: ZN) (formula: Zn).

Mol	Chain	Residues	Atoms		AltConf
89	g	1	Total 1	Zn 1	0
89	j	1	Total 1	Zn 1	0
89	m	1	Total 1	Zn 1	0
89	o	1	Total 1	Zn 1	0
89	p	1	Total 1	Zn 1	0
89	aa	1	Total 1	Zn 1	0
89	dd	1	Total 1	Zn 1	0
89	ff	1	Total 1	Zn 1	0

- Molecule 90 is PHOSPHOMETHYLPHOSPHONIC ACID GUANYLATE ESTER (three-letter code: GCP) (formula: C<sub>11</sub>H<sub>18</sub>N<sub>5</sub>O<sub>13</sub>P<sub>3</sub>).

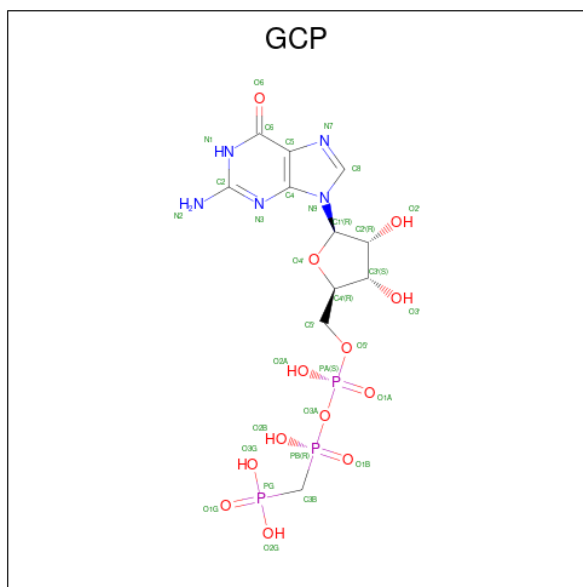

Mol	Chain	Residues	Atoms					AltConf
			Total	C	N	O	P	
90	jj	1	32	11	5	13	3	0

### 3 Residue-property plots [i](#)

These plots are drawn for all protein, RNA, DNA and oligosaccharide chains in the entry. The first graphic for a chain summarises the proportions of the various outlier classes displayed in the second graphic. The second graphic shows the sequence view annotated by issues in geometry and atom inclusion in map density. Residues are color-coded according to the number of geometric quality criteria for which they contain at least one outlier: green = 0, yellow = 1, orange = 2 and red = 3 or more. A red diamond above a residue indicates a poor fit to the EM map for this residue (all-atom inclusion < 40%). Stretches of 2 or more consecutive residues without any outlier are shown as a green connector. Residues present in the sample, but not in the model, are shown in grey.

- Molecule 1: uL2

Chain A:  91% 5%

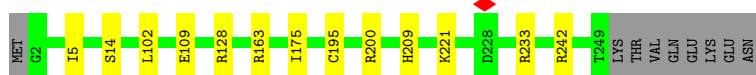

- Molecule 2: uL3

Chain B:  93% 5%



- Molecule 3: uL4

Chain C:  81% 15%

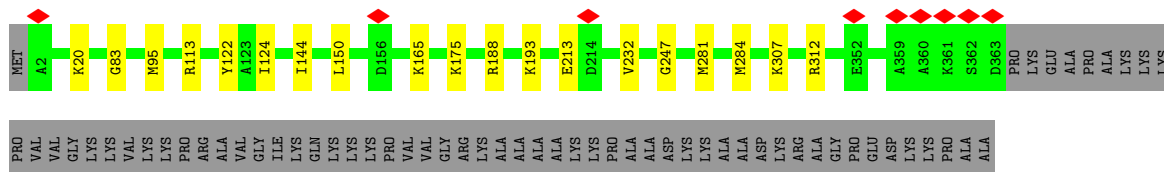

- Molecule 4: uL18

Chain D:  94%



- Molecule 5: eL6

Chain E:  70% 26%



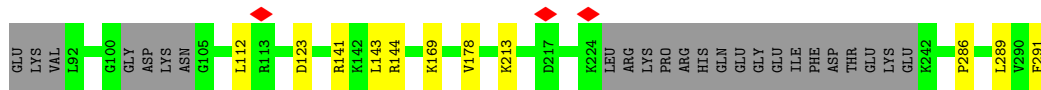
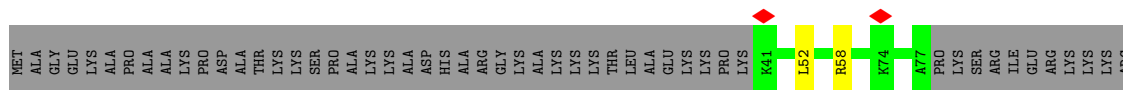

• Molecule 6: uL30

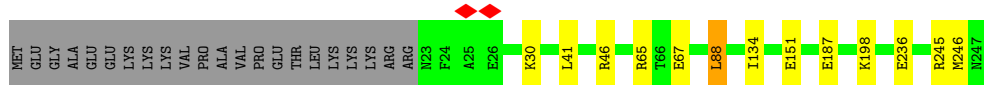
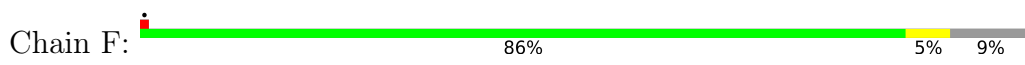

• Molecule 7: eL8

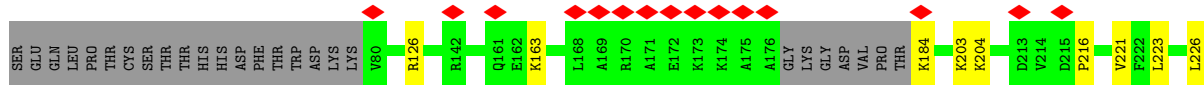
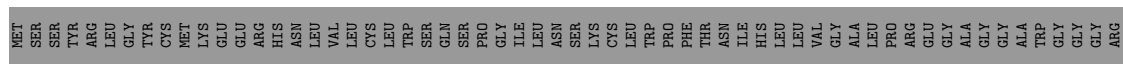

• Molecule 8: uL6

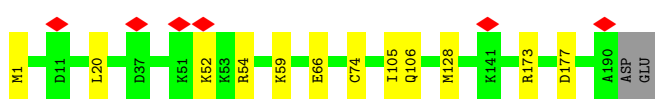
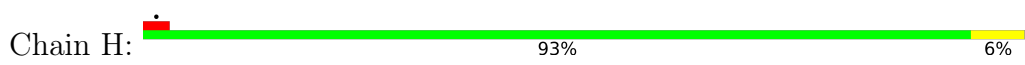

• Molecule 9: uL16

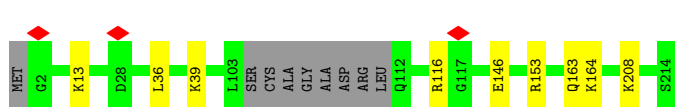
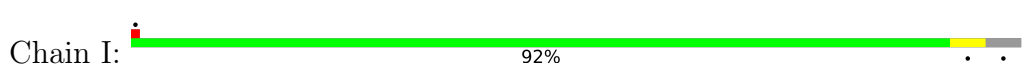

• Molecule 10: uL5

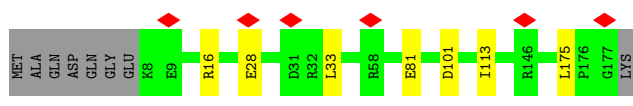
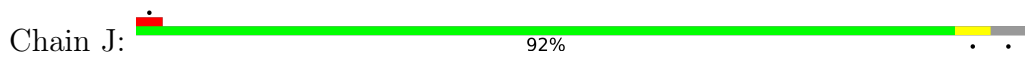

• Molecule 11: eL13

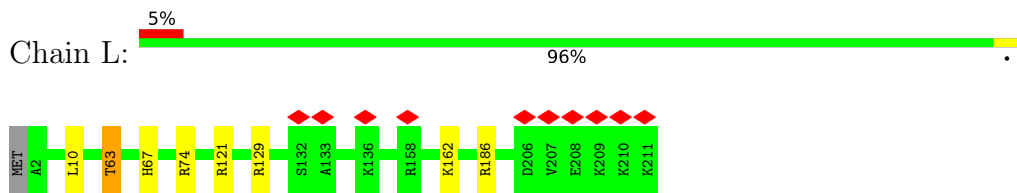

• Molecule 12: eL14

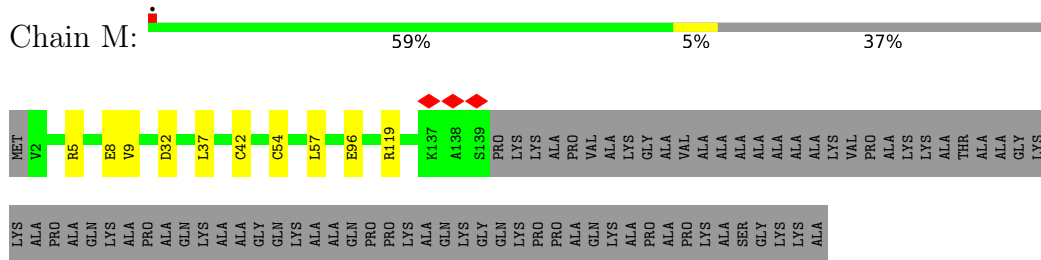

• Molecule 13: eL15

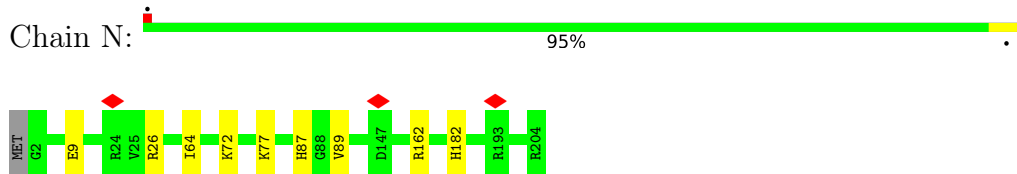

• Molecule 14: uL13

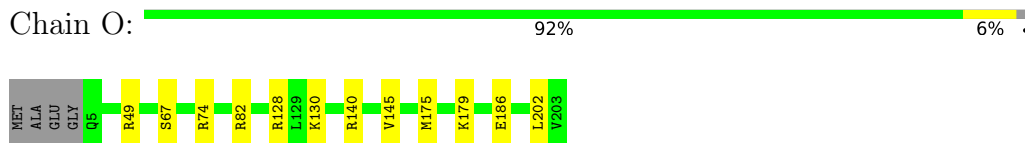

• Molecule 15: uL22

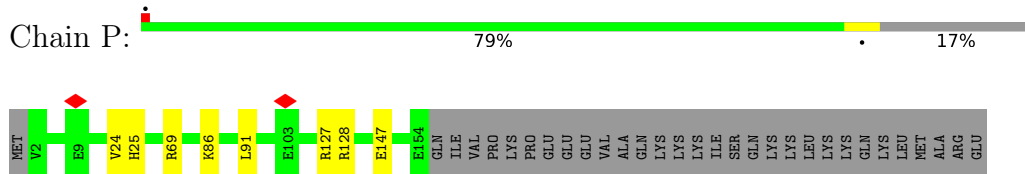

• Molecule 16: eL18

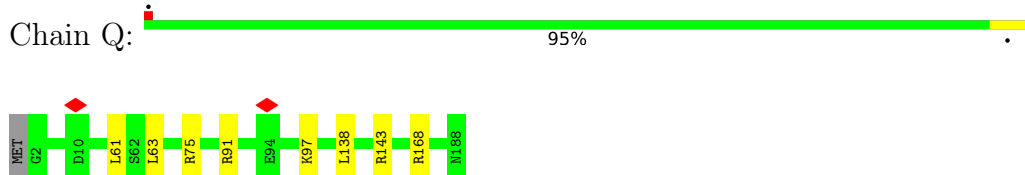

• Molecule 17: eL19

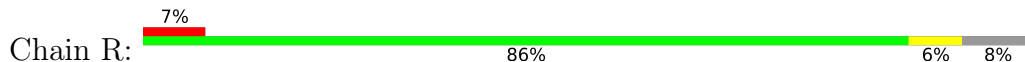

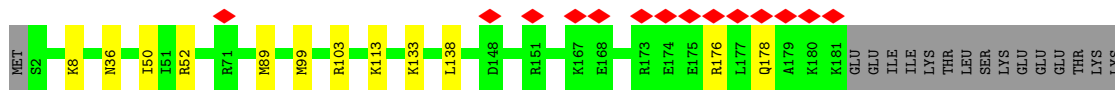

• Molecule 18: eL20

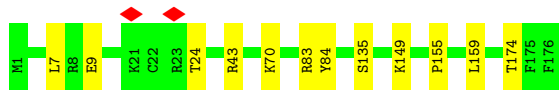
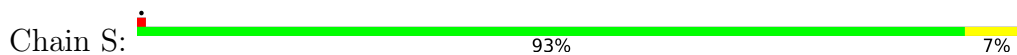

• Molecule 19: eL21

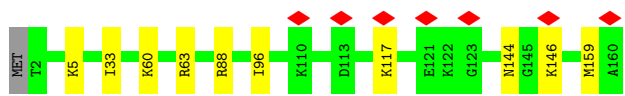

• Molecule 20: eL22

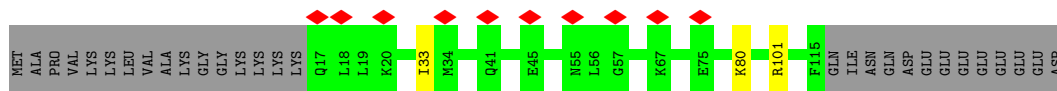
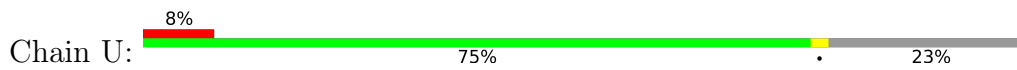

• Molecule 21: uL14

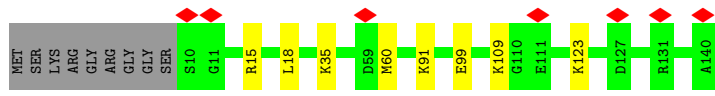
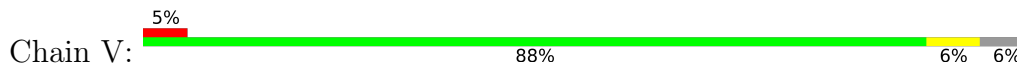

• Molecule 22: eL24

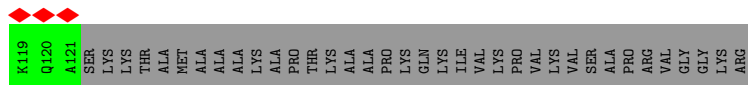
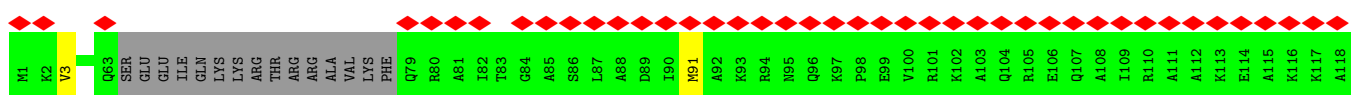

• Molecule 23: uL23

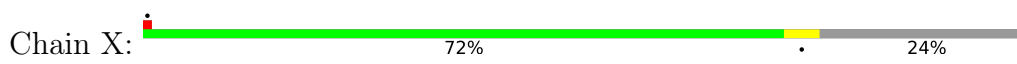





• Molecule 30: eL32

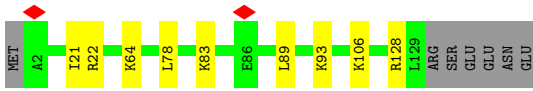
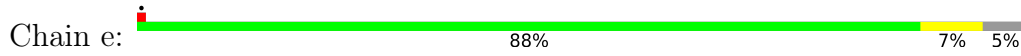

• Molecule 31: eL33

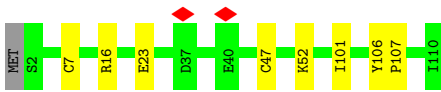
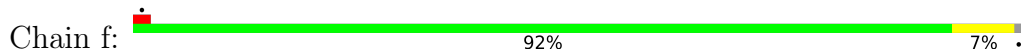

• Molecule 32: eL34

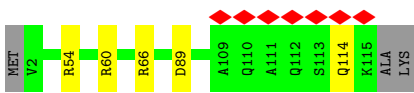
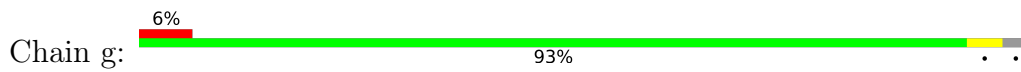

• Molecule 33: uL29



• Molecule 34: eL36

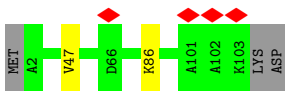

• Molecule 35: eL37

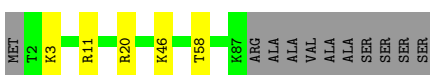
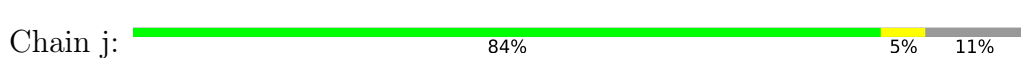

• Molecule 36: eL38

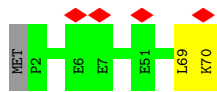

• Molecule 37: eL39

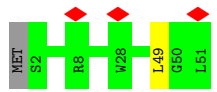

• Molecule 38: eL40

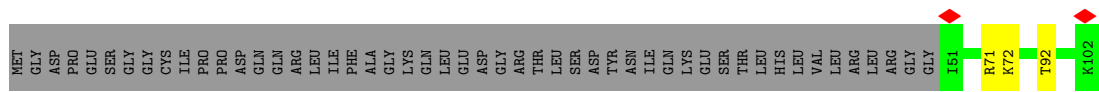

• Molecule 39: eL41

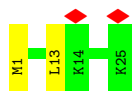
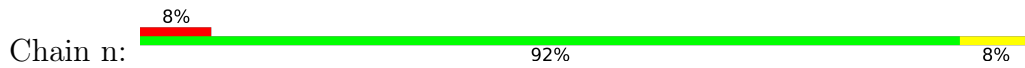

• Molecule 40: eL42

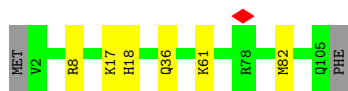
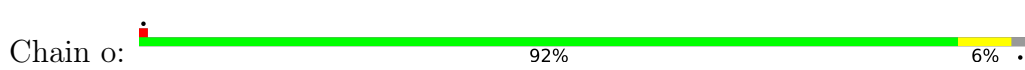

• Molecule 41: eL43

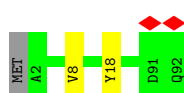

• Molecule 42: eL28

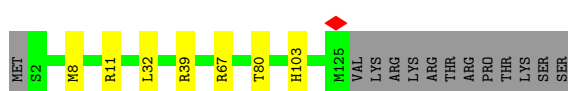
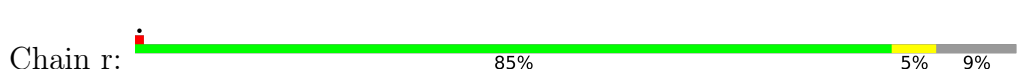





• Molecule 47: E-site tRNA

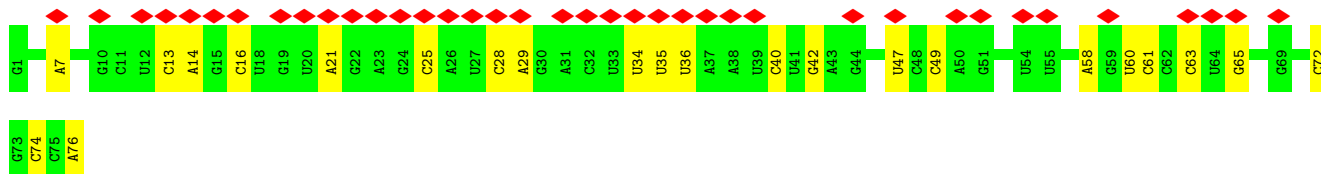

• Molecule 48: 28S ribosomal RNA

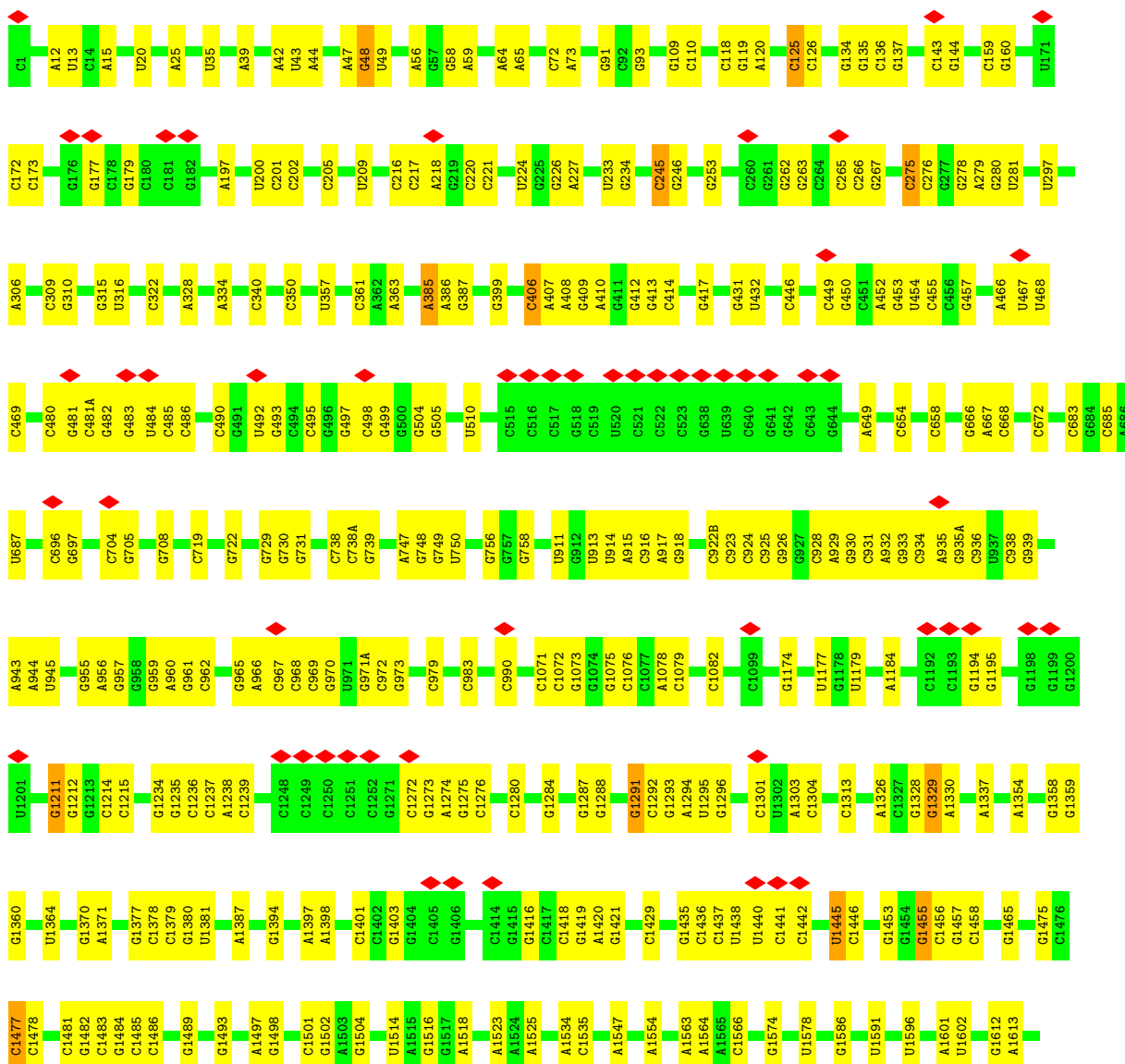



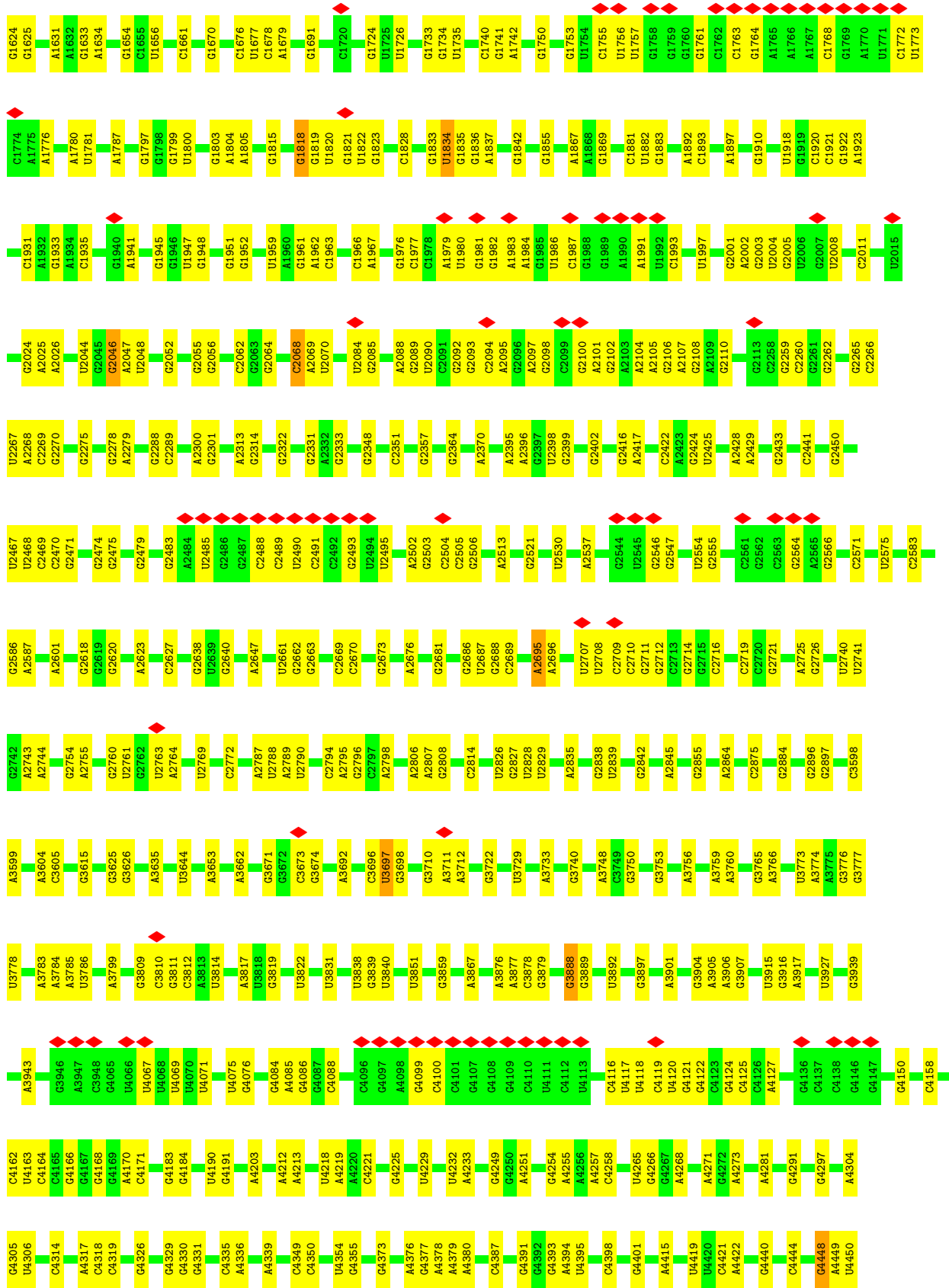

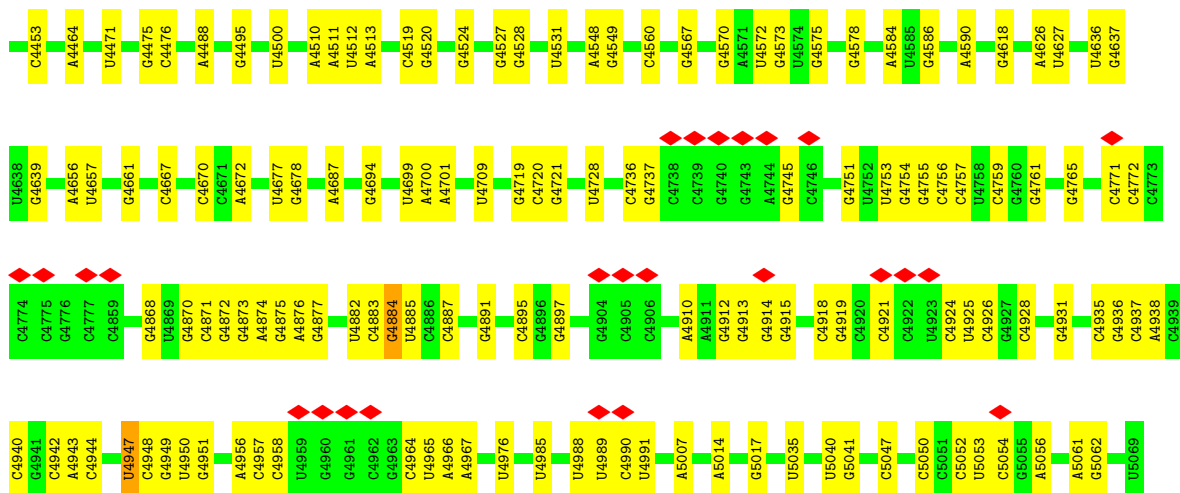

• Molecule 49: 5S ribosomal RNA

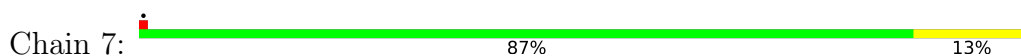

• Molecule 50: 5.8S ribosomal RNA

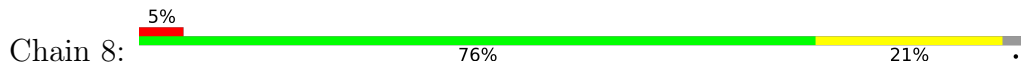

• Molecule 51: 18S ribosomal RNA

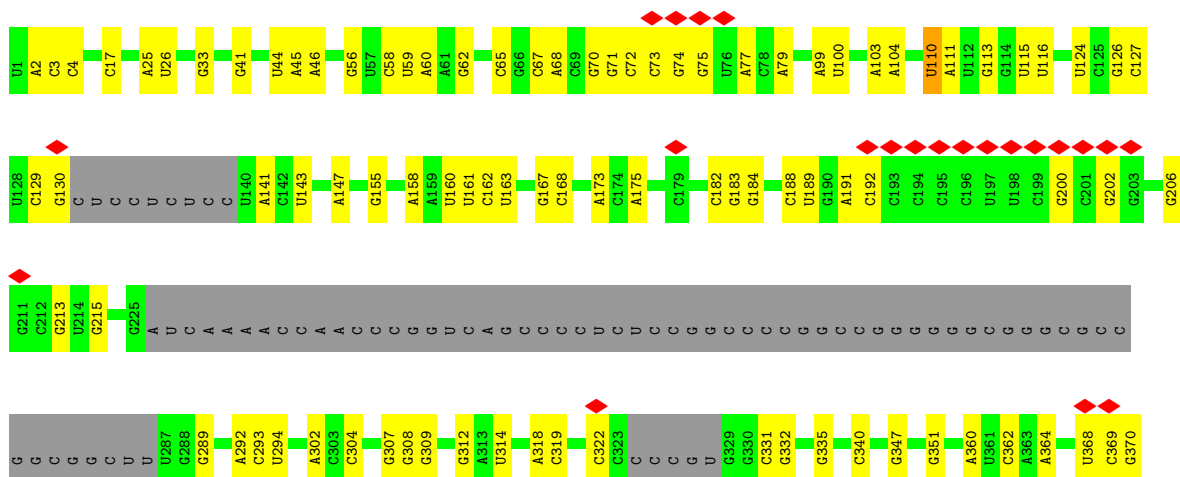

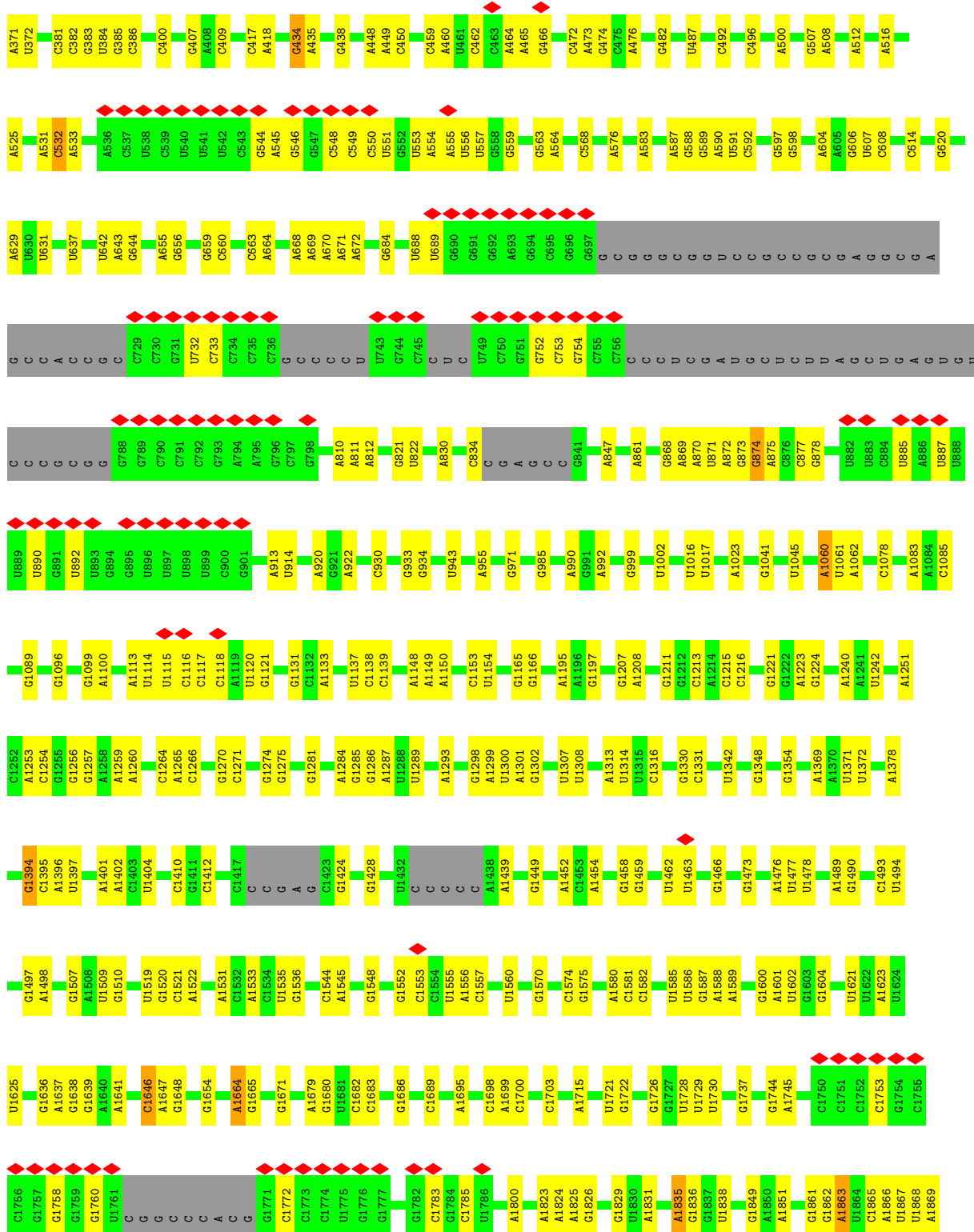

• Molecule 52: uS2

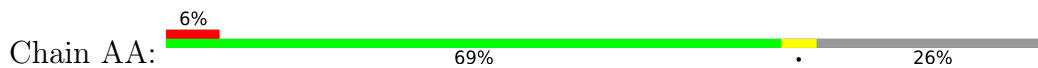





• Molecule 57: uS7

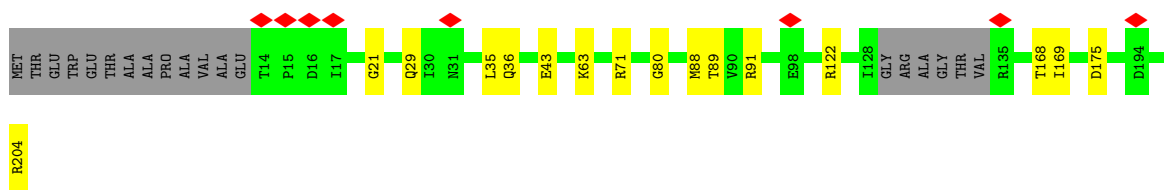
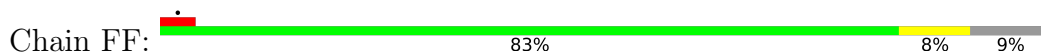

• Molecule 58: eS6

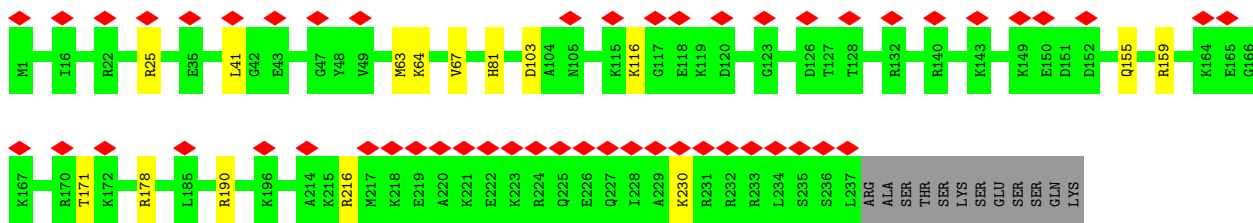
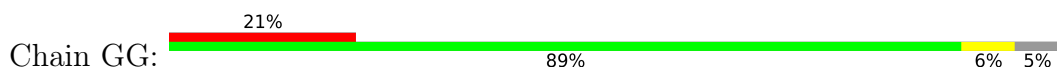

• Molecule 59: eS7

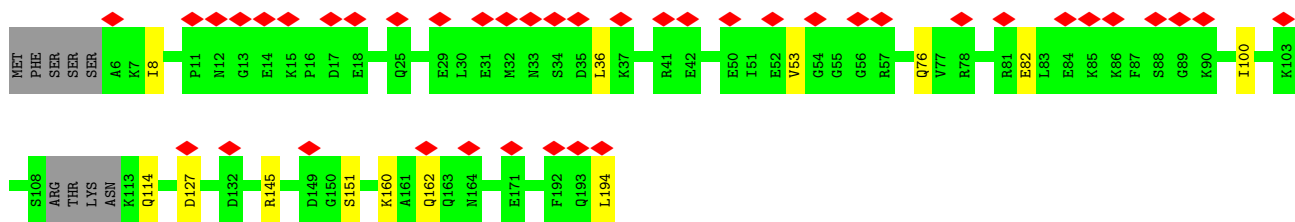
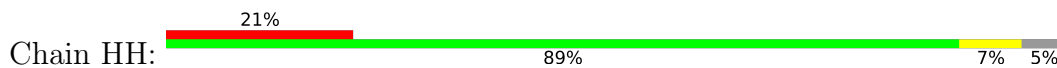

• Molecule 60: eS8

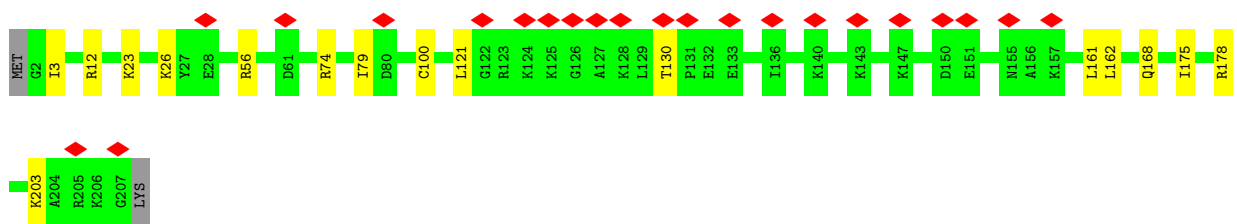
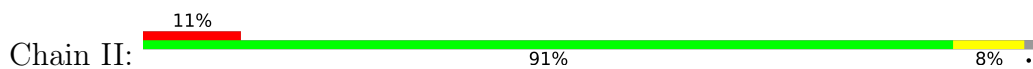

• Molecule 61: uS4

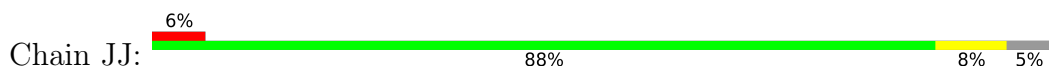

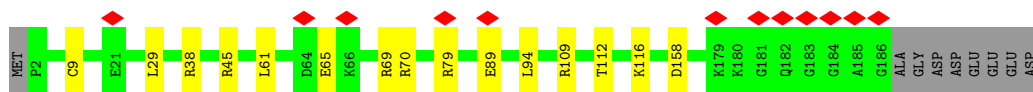

• Molecule 62: eS10

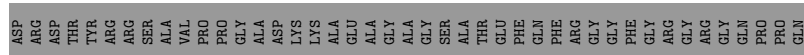
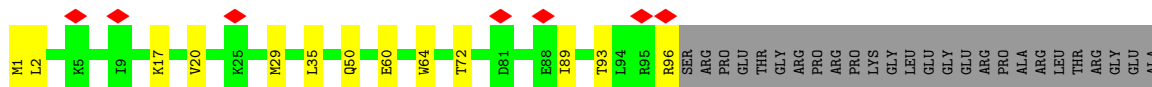

• Molecule 63: uS17

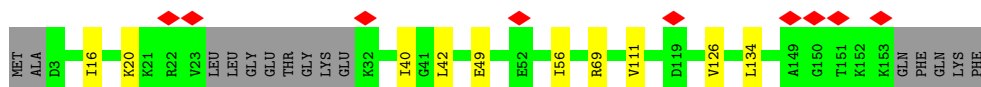
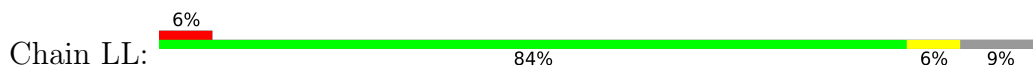

• Molecule 64: eS12

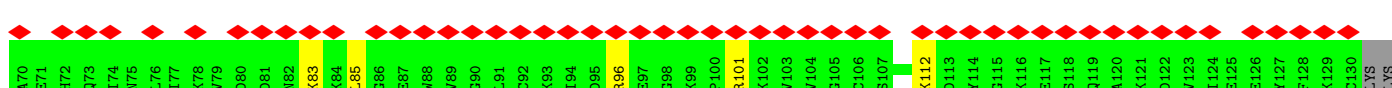
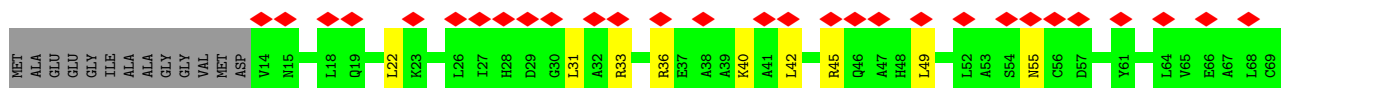

• Molecule 65: uS15



• Molecule 66: uS11

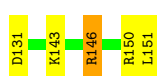

• Molecule 67: uS19

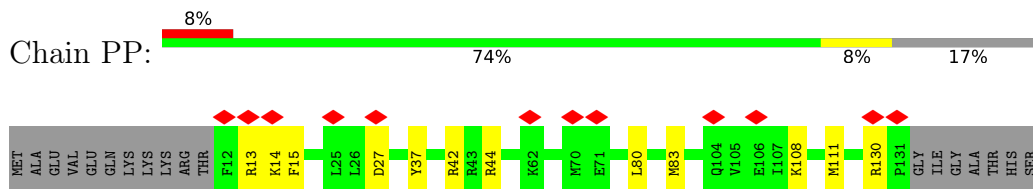

• Molecule 68: uS9

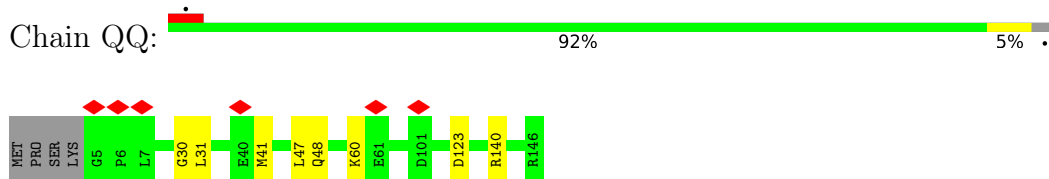

• Molecule 69: eS17

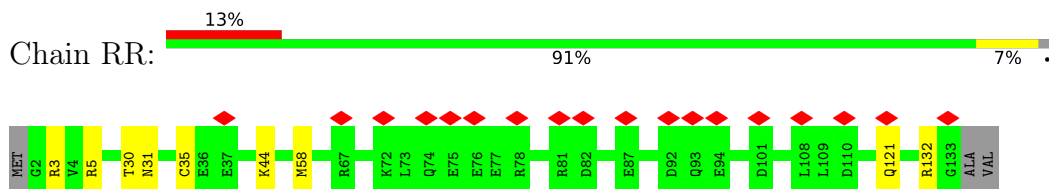

• Molecule 70: uS13

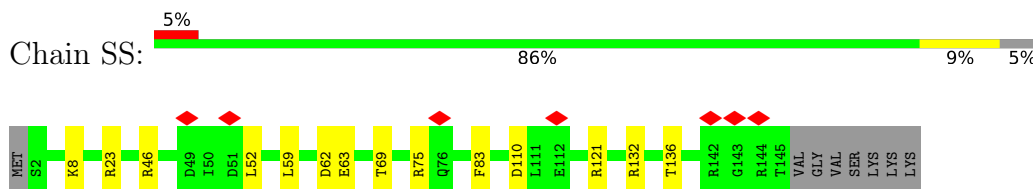

• Molecule 71: eS19

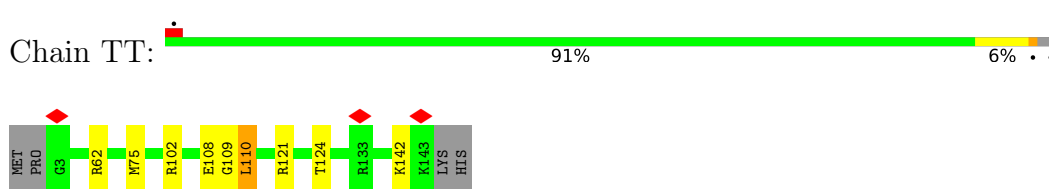

• Molecule 72: uS10

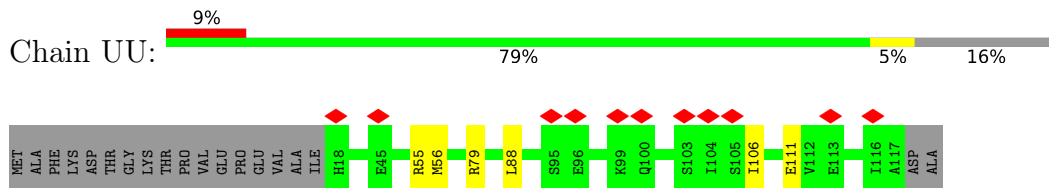

• Molecule 73: eS21





• Molecule 74: uS8



• Molecule 75: uS12



• Molecule 76: eS24

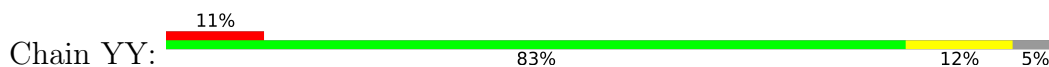

• Molecule 77: eS25

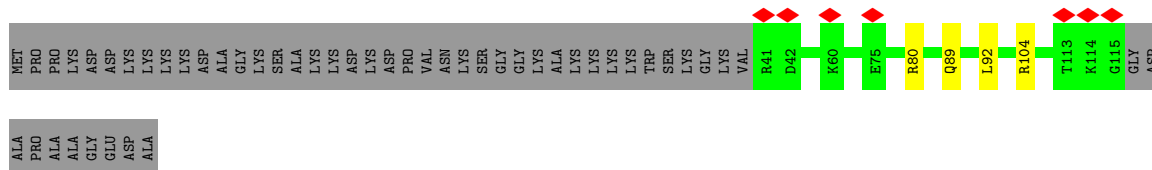

• Molecule 78: eS26

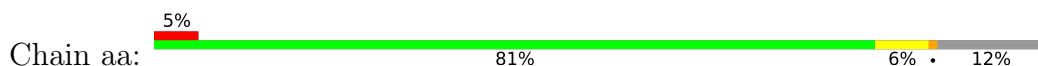

• Molecule 79: eS27

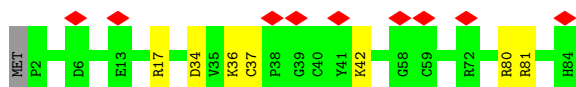
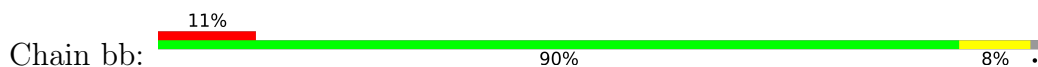







• Molecule 86: eRF1

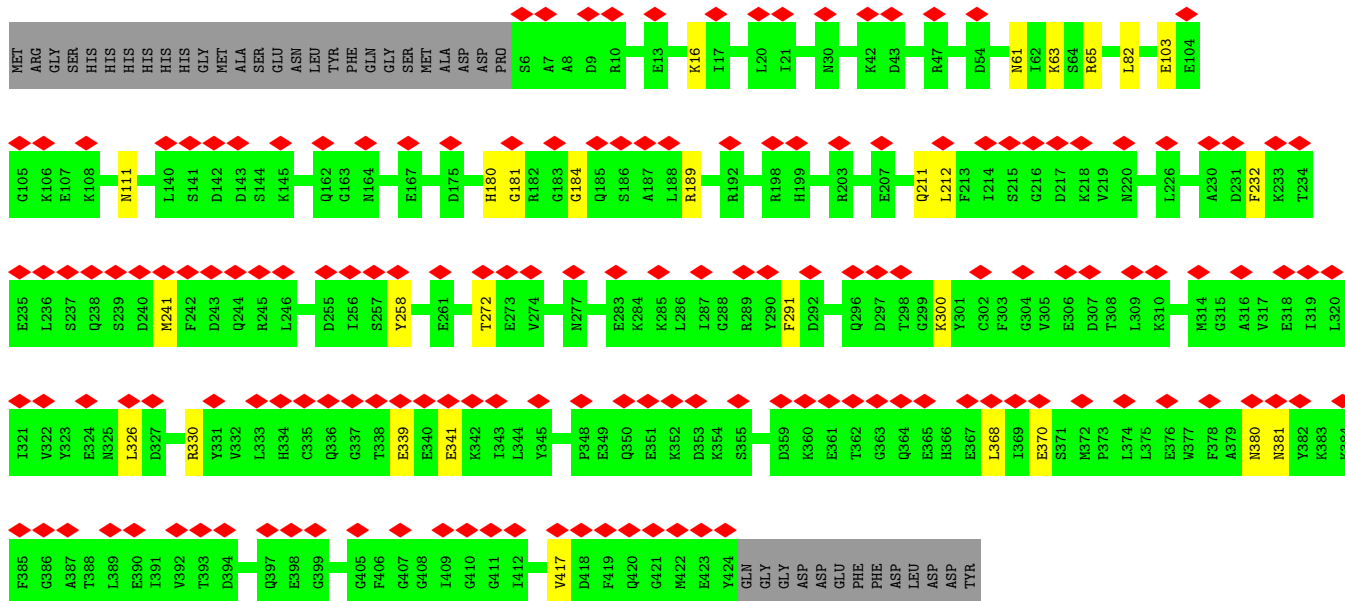
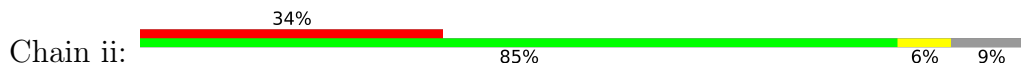

• Molecule 87: eRF3a

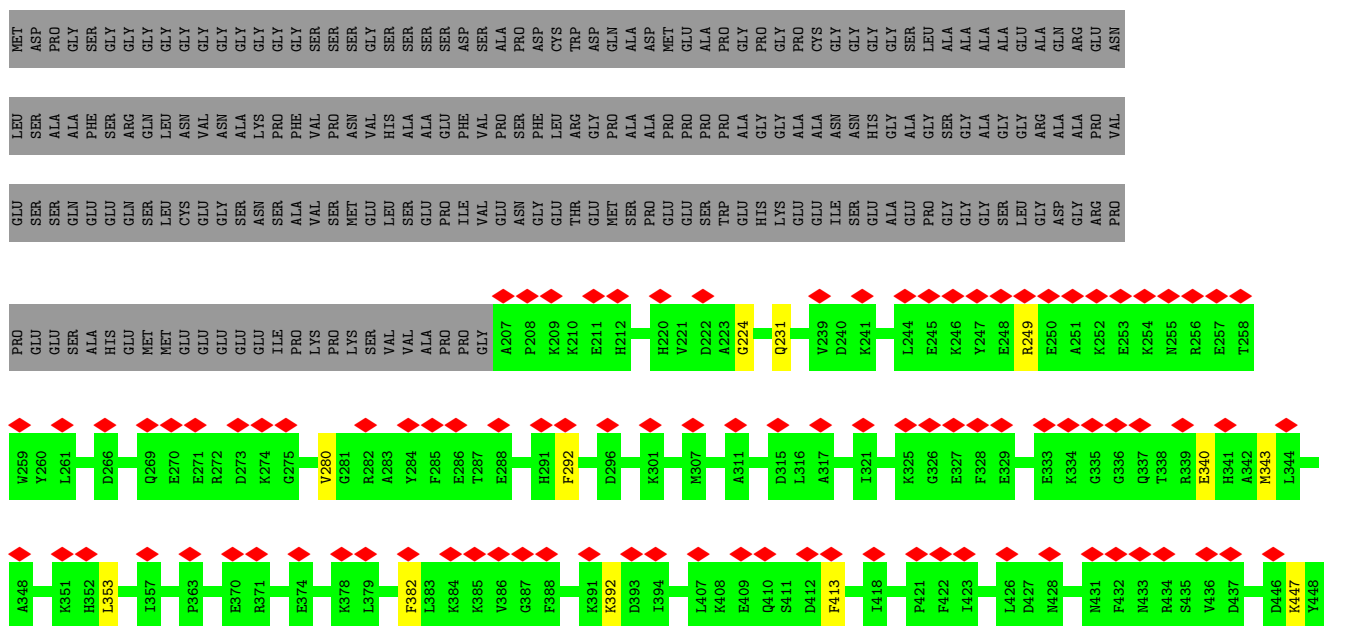

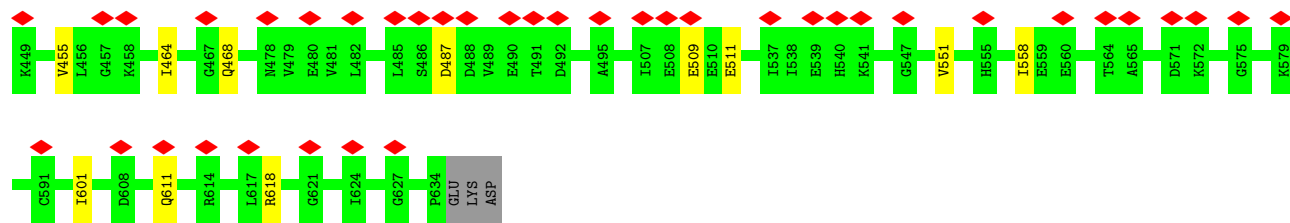

## 4 Experimental information

Property	Value	Source
EM reconstruction method	SINGLE PARTICLE	Depositor
Imposed symmetry	POINT, C1	Depositor
Number of particles used	61752	Depositor
Resolution determination method	FSC 0.143 CUT-OFF	Depositor
CTF correction method	PHASE FLIPPING AND AMPLITUDE CORRECTION	Depositor
Microscope	FEI TITAN KRIOS	Depositor
Voltage (kV)	300	Depositor
Electron dose ( $e^-/\text{\AA}^2$ )	30	Depositor
Minimum defocus (nm)	Not provided	
Maximum defocus (nm)	Not provided	
Magnification	104478	Depositor
Image detector	FEI FALCON II (4k x 4k)	Depositor
Maximum map value	0.800	Depositor
Minimum map value	-0.493	Depositor
Average map value	0.001	Depositor
Map value standard deviation	0.023	Depositor
Recommended contour level	0.1	Depositor
Map size (Å)	562.8, 562.8, 562.8	wwPDB
Map dimensions	420, 420, 420	wwPDB
Map angles (°)	90.0, 90.0, 90.0	wwPDB
Pixel spacing (Å)	1.3399999, 1.3399999, 1.3399999	Depositor

## 5 Model quality

### 5.1 Standard geometry

Bond lengths and bond angles in the following residue types are not validated in this section: ZN, GCP, MG

The Z score for a bond length (or angle) is the number of standard deviations the observed value is removed from the expected value. A bond length (or angle) with  $|Z| > 5$  is considered an outlier worth inspection. RMSZ is the root-mean-square of all Z scores of the bond lengths (or angles).

Mol	Chain	Bond lengths		Bond angles	
		RMSZ	# $ Z  > 5$	RMSZ	# $ Z  > 5$
1	A	0.34	0/1936	0.69	0/2596
2	B	0.33	0/3240	0.64	0/4339
3	C	0.33	0/2937	0.66	0/3946
4	D	0.34	0/2437	0.61	3/3264 (0.1%)
5	E	0.33	0/1762	0.63	0/2362
6	F	0.36	0/1911	0.66	1/2549 (0.0%)
7	G	0.33	0/1910	0.62	0/2569
8	H	0.31	0/1535	0.60	0/2063
9	I	0.33	0/1702	0.60	0/2272
10	J	0.33	0/1385	0.61	0/1852
11	L	0.34	0/1733	0.67	0/2316
12	M	0.35	0/1158	0.65	0/1547
13	N	0.35	0/1746	0.67	0/2338
14	O	0.34	0/1662	0.66	0/2222
15	P	0.36	0/1268	0.64	0/1700
16	Q	0.35	0/1539	0.72	0/2054
17	R	0.34	0/1524	0.67	0/2013
18	S	0.37	0/1501	0.68	0/2012
19	T	0.33	0/1326	0.60	0/1770
20	U	0.35	0/823	0.55	0/1104
21	V	0.34	0/993	0.62	0/1332
22	W	0.34	0/873	0.56	0/1158
23	X	0.33	0/984	0.60	0/1323
24	Y	0.33	0/1132	0.62	0/1504
25	Z	0.34	0/1130	0.61	0/1507
26	a	0.32	0/1191	0.61	0/1590
27	b	0.34	0/861	0.58	0/1138
28	c	0.32	0/771	0.54	0/1034
29	d	0.34	0/903	0.66	0/1216
30	e	0.34	0/1071	0.66	0/1429
31	f	0.36	0/895	0.69	0/1198
32	g	0.33	0/916	0.67	0/1220

Mol	Chain	Bond lengths		Bond angles	
		RMSZ	# Z  >5	RMSZ	# Z  >5
33	h	0.32	0/1021	0.61	0/1348
34	i	0.34	0/841	0.60	0/1112
35	j	0.36	0/720	0.72	0/952
36	k	0.32	0/575	0.55	0/761
37	l	0.35	0/459	0.63	0/608
38	m	0.34	0/435	0.61	0/575
39	n	0.34	0/240	0.67	0/305
40	o	0.34	0/864	0.61	0/1140
41	p	0.32	0/718	0.62	0/953
42	r	0.35	0/1010	0.69	0/1354
43	s	0.36	0/1530	0.50	0/2064
44	t	0.36	0/1174	0.52	0/1582
45	1	0.41	0/129	0.61	0/173
46	2	0.22	0/1805	0.67	0/2809
47	3	0.21	0/1777	0.66	0/2763
48	5	0.27	0/84973	0.68	22/132508 (0.0%)
49	7	0.26	0/2858	0.67	0/4455
50	8	0.28	0/3581	0.67	0/5577
51	9	0.25	0/40524	0.69	10/63134 (0.0%)
52	AA	0.33	0/1747	0.60	0/2374
53	BB	0.33	0/1756	0.63	0/2350
54	CC	0.34	0/1753	0.62	0/2369
55	DD	0.35	0/1796	0.61	0/2417
56	EE	0.34	0/2118	0.64	0/2849
57	FF	0.33	0/1492	0.61	0/2005
58	GG	0.35	0/1946	0.67	0/2590
59	HH	0.35	0/1510	0.59	0/2022
60	II	0.34	0/1715	0.63	0/2287
61	JJ	0.33	0/1550	0.68	0/2069
62	KK	0.34	0/834	0.59	0/1125
63	LL	0.35	0/1195	0.66	0/1597
64	MM	0.36	0/918	0.61	0/1233
65	NN	0.33	0/1226	0.62	0/1649
66	OO	0.34	0/1029	0.78	1/1380 (0.1%)
67	PP	0.34	0/1017	0.64	0/1358
68	QQ	0.32	0/1146	0.61	0/1534
69	RR	0.33	0/1082	0.60	0/1452
70	SS	0.34	0/1208	0.68	0/1618
71	TT	0.36	0/1115	0.63	1/1493 (0.1%)
72	UU	0.34	0/805	0.65	0/1081
73	VV	0.36	0/643	0.67	0/860
74	WW	0.34	0/1051	0.69	0/1406
75	XX	0.32	0/1116	0.64	0/1490

Mol	Chain	Bond lengths		Bond angles	
		RMSZ	# Z  >5	RMSZ	# Z  >5
76	YY	0.35	0/1028	0.61	0/1366
77	ZZ	0.33	0/604	0.59	0/810
78	aa	0.35	0/828	0.74	0/1109
79	bb	0.33	0/665	0.59	0/891
80	cc	0.33	0/490	0.65	0/656
81	dd	0.37	0/470	0.62	0/623
82	ee	0.35	0/447	0.70	0/587
83	ff	0.36	0/567	0.56	0/753
84	gg	0.32	0/2493	0.55	0/3394
85	hh	0.31	0/353	0.77	0/547
86	ii	0.35	0/3361	0.54	0/4519
87	jj	0.35	0/3435	0.55	0/4633
All	All	0.30	0/238498	0.66	38/349206 (0.0%)

Chiral center outliers are detected by calculating the chiral volume of a chiral center and verifying if the center is modelled as a planar moiety or with the opposite hand. A planarity outlier is detected by checking planarity of atoms in a peptide group, atoms in a mainchain group or atoms of a sidechain that are expected to be planar.

Mol	Chain	#Chirality outliers	#Planarity outliers
2	B	0	1
74	WW	0	1
75	XX	0	1
All	All	0	3

There are no bond length outliers.

All (38) bond angle outliers are listed below:

Mol	Chain	Res	Type	Atoms	Z	Observed(°)	Ideal(°)
51	9	1835	A	C2'-C3'-O3'	8.60	128.43	109.50
4	D	22	ARG	NE-CZ-NH1	8.45	124.52	120.30
51	9	1394	G	C2'-C3'-O3'	7.70	126.44	109.50
48	5	406	C	C2'-C3'-O3'	7.30	125.56	109.50
48	5	1477	C	C2'-C3'-O3'	6.95	124.81	113.70
48	5	3888	G	C2'-C3'-O3'	6.93	124.79	113.70
48	5	1211	G	C2'-C3'-O3'	6.79	124.57	113.70
48	5	275	C	C2'-C3'-O3'	6.74	124.49	113.70
66	OO	146	ARG	NE-CZ-NH1	6.70	123.65	120.30
51	9	1646	C	C2'-C3'-O3'	6.28	123.75	113.70
48	5	3697	U	C2'-C3'-O3'	6.24	123.67	113.70
48	5	1818	G	C2'-C3'-O3'	6.11	123.47	113.70
48	5	2046	G	C2'-C3'-O3'	6.08	123.43	113.70

*Continued on next page...*

Continued from previous page...

Mol	Chain	Res	Type	Atoms	Z	Observed(°)	Ideal(°)
48	5	2695	A	C2'-C3'-O3'	6.02	123.34	113.70
48	5	1834	U	C2'-C3'-O3'	6.00	123.29	113.70
48	5	1455	G	C2'-C3'-O3'	5.97	123.26	113.70
51	9	874	G	C2'-C3'-O3'	5.97	123.26	113.70
51	9	434	G	C2'-C3'-O3'	5.91	123.16	113.70
48	5	1291	G	C2'-C3'-O3'	5.77	122.93	113.70
48	5	4947	U	C2'-C3'-O3'	5.65	122.75	113.70
48	5	245	C	C2'-C3'-O3'	5.62	122.69	113.70
48	5	1329	G	C2'-C3'-O3'	5.57	122.60	113.70
51	9	110	U	C2'-C3'-O3'	5.56	122.59	113.70
6	F	88	LEU	CA-CB-CG	5.53	128.02	115.30
48	5	48	G	C2'-C3'-O3'	5.53	122.54	113.70
48	5	2068	C	C4'-C3'-O3'	5.50	124.01	113.00
48	5	4448	G	C4'-C3'-O3'	5.48	123.97	113.00
4	D	22	ARG	CG-CD-NE	5.44	123.22	111.80
48	5	385	A	C4'-C3'-O3'	5.34	123.68	113.00
51	9	1863	A	N9-C1'-C2'	5.23	120.81	114.00
51	9	532	C	C2'-C3'-O3'	5.21	122.04	113.70
48	5	125	C	C2'-C3'-O3'	5.18	122.00	113.70
48	5	1445	U	C2'-C3'-O3'	5.18	121.99	113.70
71	TT	110	LEU	CA-CB-CG	5.13	127.10	115.30
48	5	4884	G	C2'-C3'-O3'	5.09	121.84	113.70
51	9	1060	A	N9-C1'-C2'	5.08	120.61	114.00
4	D	22	ARG	NE-CZ-NH2	-5.02	117.79	120.30
51	9	1664	A	C4'-C3'-O3'	5.00	123.01	113.00

There are no chirality outliers.

All (3) planarity outliers are listed below:

Mol	Chain	Res	Type	Group
2	B	16	PHE	Peptide
74	WW	27	ILE	Peptide
75	XX	61	GLN	Peptide

## 5.2 Too-close contacts [i](#)

Due to software issues we are unable to calculate clashes - this section is therefore empty.



## 5.3 Torsion angles

### 5.3.1 Protein backbone

In the following table, the Percentiles column shows the percent Ramachandran outliers of the chain as a percentile score with respect to all PDB entries followed by that with respect to all EM entries.

The Analysed column shows the number of residues for which the backbone conformation was analysed, and the total number of residues.

Mol	Chain	Analysed	Favoured	Allowed	Outliers	Percentiles	
1	A	246/257 (96%)	218 (89%)	26 (11%)	2 (1%)	19	56
2	B	392/403 (97%)	360 (92%)	29 (7%)	3 (1%)	19	56
3	C	360/425 (85%)	337 (94%)	21 (6%)	2 (1%)	25	62
4	D	291/297 (98%)	275 (94%)	15 (5%)	1 (0%)	41	74
5	E	208/291 (72%)	191 (92%)	17 (8%)	0	100	100
6	F	223/247 (90%)	212 (95%)	10 (4%)	1 (0%)	34	69
7	G	229/319 (72%)	216 (94%)	11 (5%)	2 (1%)	17	54
8	H	188/192 (98%)	178 (95%)	10 (5%)	0	100	100
9	I	201/214 (94%)	185 (92%)	16 (8%)	0	100	100
10	J	168/178 (94%)	161 (96%)	7 (4%)	0	100	100
11	L	208/211 (99%)	196 (94%)	11 (5%)	1 (0%)	29	66
12	M	136/218 (62%)	123 (90%)	12 (9%)	1 (1%)	22	59
13	N	201/204 (98%)	187 (93%)	13 (6%)	1 (0%)	29	66
14	O	197/203 (97%)	188 (95%)	8 (4%)	1 (0%)	29	66
15	P	151/184 (82%)	142 (94%)	9 (6%)	0	100	100
16	Q	185/188 (98%)	173 (94%)	12 (6%)	0	100	100
17	R	178/196 (91%)	173 (97%)	5 (3%)	0	100	100
18	S	174/176 (99%)	159 (91%)	14 (8%)	1 (1%)	25	62
19	T	157/160 (98%)	147 (94%)	10 (6%)	0	100	100
20	U	97/128 (76%)	87 (90%)	10 (10%)	0	100	100
21	V	129/140 (92%)	120 (93%)	9 (7%)	0	100	100
22	W	102/157 (65%)	97 (95%)	4 (4%)	1 (1%)	15	52
23	X	116/156 (74%)	107 (92%)	9 (8%)	0	100	100
24	Y	132/145 (91%)	122 (92%)	10 (8%)	0	100	100
25	Z	133/136 (98%)	126 (95%)	5 (4%)	2 (2%)	10	44

Continued on next page...

Continued from previous page...

Mol	Chain	Analysed	Favoured	Allowed	Outliers	Percentiles	
26	a	145/148 (98%)	131 (90%)	14 (10%)	0	100	100
27	b	100/245 (41%)	94 (94%)	5 (5%)	1 (1%)	15	52
28	c	96/115 (84%)	93 (97%)	3 (3%)	0	100	100
29	d	105/125 (84%)	89 (85%)	15 (14%)	1 (1%)	15	52
30	e	126/135 (93%)	120 (95%)	6 (5%)	0	100	100
31	f	107/110 (97%)	97 (91%)	8 (8%)	2 (2%)	8	40
32	g	112/117 (96%)	105 (94%)	7 (6%)	0	100	100
33	h	120/123 (98%)	118 (98%)	2 (2%)	0	100	100
34	i	100/105 (95%)	94 (94%)	5 (5%)	1 (1%)	15	52
35	j	84/97 (87%)	78 (93%)	6 (7%)	0	100	100
36	k	67/70 (96%)	65 (97%)	2 (3%)	0	100	100
37	l	48/51 (94%)	44 (92%)	4 (8%)	0	100	100
38	m	50/102 (49%)	47 (94%)	3 (6%)	0	100	100
39	n	23/25 (92%)	23 (100%)	0	0	100	100
40	o	102/106 (96%)	98 (96%)	4 (4%)	0	100	100
41	p	89/92 (97%)	83 (93%)	5 (6%)	1 (1%)	14	51
42	r	122/137 (89%)	112 (92%)	9 (7%)	1 (1%)	19	56
43	s	194/318 (61%)	176 (91%)	16 (8%)	2 (1%)	15	52
44	t	151/165 (92%)	135 (89%)	14 (9%)	2 (1%)	12	47
45	l	13/15 (87%)	10 (77%)	2 (15%)	1 (8%)	1	12
52	AA	215/295 (73%)	203 (94%)	11 (5%)	1 (0%)	29	66
53	BB	211/264 (80%)	198 (94%)	12 (6%)	1 (0%)	29	66
54	CC	219/293 (75%)	206 (94%)	13 (6%)	0	100	100
55	DD	226/243 (93%)	213 (94%)	12 (5%)	1 (0%)	34	69
56	EE	260/263 (99%)	246 (95%)	14 (5%)	0	100	100
57	FF	181/204 (89%)	170 (94%)	9 (5%)	2 (1%)	14	51
58	GG	235/249 (94%)	224 (95%)	11 (5%)	0	100	100
59	HH	181/194 (93%)	171 (94%)	10 (6%)	0	100	100
60	II	204/208 (98%)	192 (94%)	11 (5%)	1 (0%)	29	66
61	JJ	183/194 (94%)	177 (97%)	6 (3%)	0	100	100
62	KK	94/165 (57%)	89 (95%)	4 (4%)	1 (1%)	14	51

Continued on next page...

Continued from previous page...

Mol	Chain	Analysed	Favoured	Allowed	Outliers	Percentiles	
63	LL	139/158 (88%)	130 (94%)	9 (6%)	0	100	100
64	MM	115/132 (87%)	103 (90%)	12 (10%)	0	100	100
65	NN	147/151 (97%)	142 (97%)	4 (3%)	1 (1%)	22	59
66	OO	134/168 (80%)	123 (92%)	9 (7%)	2 (2%)	10	44
67	PP	118/145 (81%)	105 (89%)	12 (10%)	1 (1%)	19	56
68	QQ	140/146 (96%)	132 (94%)	7 (5%)	1 (1%)	22	59
69	RR	130/135 (96%)	120 (92%)	10 (8%)	0	100	100
70	SS	142/152 (93%)	135 (95%)	7 (5%)	0	100	100
71	TT	139/145 (96%)	130 (94%)	8 (6%)	1 (1%)	22	59
72	UU	98/119 (82%)	91 (93%)	7 (7%)	0	100	100
73	VV	81/83 (98%)	79 (98%)	2 (2%)	0	100	100
74	WW	127/130 (98%)	120 (94%)	5 (4%)	2 (2%)	9	43
75	XX	139/143 (97%)	128 (92%)	8 (6%)	3 (2%)	6	37
76	YY	122/130 (94%)	115 (94%)	7 (6%)	0	100	100
77	ZZ	73/125 (58%)	70 (96%)	3 (4%)	0	100	100
78	aa	99/115 (86%)	93 (94%)	4 (4%)	2 (2%)	7	39
79	bb	81/84 (96%)	75 (93%)	6 (7%)	0	100	100
80	cc	60/69 (87%)	58 (97%)	2 (3%)	0	100	100
81	dd	53/56 (95%)	48 (91%)	5 (9%)	0	100	100
82	ee	53/133 (40%)	51 (96%)	2 (4%)	0	100	100
83	ff	66/156 (42%)	59 (89%)	7 (11%)	0	100	100
84	gg	311/317 (98%)	285 (92%)	24 (8%)	2 (1%)	25	62
86	ii	417/459 (91%)	387 (93%)	24 (6%)	6 (1%)	11	45
87	jj	426/637 (67%)	371 (87%)	50 (12%)	5 (1%)	13	49
All	All	12375/14486 (85%)	11531 (93%)	780 (6%)	64 (0%)	32	66

All (64) Ramachandran outliers are listed below:

Mol	Chain	Res	Type
75	XX	62	PRO
86	ii	258	TYR
86	ii	272	THR
87	jj	224	GLY
87	jj	280	VAL

Continued on next page...

*Continued from previous page...*

<b>Mol</b>	<b>Chain</b>	<b>Res</b>	<b>Type</b>
13	N	89	VAL
42	r	11	ARG
43	s	142	GLY
65	NN	108	ASP
66	OO	20	GLN
66	OO	30	VAL
67	PP	80	LEU
68	QQ	30	GLY
75	XX	61	GLN
75	XX	86	PRO
86	ii	181	GLY
1	A	14	SER
6	F	236	GLU
11	L	63	THR
18	S	155	PRO
25	Z	90	PRO
25	Z	91	LEU
27	b	102	PRO
31	f	107	PRO
44	t	125	LEU
55	DD	93	THR
60	II	3	ILE
62	KK	64	TRP
74	WW	56	HIS
86	ii	370	GLU
2	B	17	LEU
2	B	376	HIS
41	p	18	TYR
44	t	54	LYS
78	aa	15	ARG
86	ii	326	LEU
3	C	83	GLY
14	O	186	GLU
29	d	58	GLY
31	f	106	TYR
45	l	64	PRO
52	AA	159	ILE
57	FF	21	GLY
57	FF	80	GLY
74	WW	29	PRO
78	aa	47	ALA
86	ii	184	GLY

*Continued on next page...*

*Continued from previous page...*

Mol	Chain	Res	Type
87	jj	487	ASP
1	A	195	CYS
7	G	221	VAL
43	s	25	PRO
84	gg	224	GLY
87	jj	464	ILE
87	jj	558	ILE
7	G	216	PRO
22	W	3	VAL
53	BB	93	GLY
2	B	254	ILE
3	C	247	GLY
4	D	125	VAL
12	M	9	VAL
34	i	47	VAL
71	TT	109	GLY
84	gg	13	GLY

### 5.3.2 Protein sidechains [i](#)

In the following table, the Percentiles column shows the percent sidechain outliers of the chain as a percentile score with respect to all PDB entries followed by that with respect to all EM entries.

The Analysed column shows the number of residues for which the sidechain conformation was analysed, and the total number of residues.

Mol	Chain	Analysed	Rotameric	Outliers	Percentiles	
1	A	190/199 (96%)	179 (94%)	11 (6%)	20	52
2	B	342/348 (98%)	325 (95%)	17 (5%)	24	55
3	C	302/347 (87%)	285 (94%)	17 (6%)	21	53
4	D	247/250 (99%)	235 (95%)	12 (5%)	25	56
5	E	190/251 (76%)	177 (93%)	13 (7%)	16	47
6	F	196/215 (91%)	184 (94%)	12 (6%)	18	50
7	G	200/272 (74%)	189 (94%)	11 (6%)	21	53
8	H	169/171 (99%)	157 (93%)	12 (7%)	14	45
9	I	175/181 (97%)	166 (95%)	9 (5%)	24	55
10	J	143/149 (96%)	136 (95%)	7 (5%)	25	56
11	L	175/176 (99%)	167 (95%)	8 (5%)	27	57

*Continued on next page...*

*Continued from previous page...*

Mol	Chain	Analysed	Rotameric	Outliers	Percentiles	
12	M	117/161 (73%)	108 (92%)	9 (8%)	13	43
13	N	171/172 (99%)	163 (95%)	8 (5%)	26	56
14	O	171/173 (99%)	160 (94%)	11 (6%)	17	49
15	P	134/163 (82%)	126 (94%)	8 (6%)	19	51
16	Q	164/165 (99%)	156 (95%)	8 (5%)	25	56
17	R	159/175 (91%)	147 (92%)	12 (8%)	13	44
18	S	157/157 (100%)	146 (93%)	11 (7%)	15	46
19	T	139/140 (99%)	129 (93%)	10 (7%)	14	45
20	U	89/114 (78%)	86 (97%)	3 (3%)	37	63
21	V	101/107 (94%)	93 (92%)	8 (8%)	12	42
22	W	86/126 (68%)	85 (99%)	1 (1%)	71	84
23	X	106/134 (79%)	100 (94%)	6 (6%)	20	52
24	Y	124/135 (92%)	117 (94%)	7 (6%)	21	53
25	Z	117/118 (99%)	114 (97%)	3 (3%)	46	68
26	a	119/120 (99%)	116 (98%)	3 (2%)	47	69
27	b	84/184 (46%)	81 (96%)	3 (4%)	35	62
28	c	84/98 (86%)	81 (96%)	3 (4%)	35	62
29	d	98/110 (89%)	91 (93%)	7 (7%)	14	45
30	e	114/121 (94%)	105 (92%)	9 (8%)	12	42
31	f	88/89 (99%)	82 (93%)	6 (7%)	16	47
32	g	98/100 (98%)	93 (95%)	5 (5%)	24	55
33	h	109/110 (99%)	103 (94%)	6 (6%)	21	53
34	i	86/89 (97%)	85 (99%)	1 (1%)	71	84
35	j	73/80 (91%)	68 (93%)	5 (7%)	16	47
36	k	64/65 (98%)	62 (97%)	2 (3%)	40	65
37	l	47/48 (98%)	46 (98%)	1 (2%)	53	73
38	m	48/90 (53%)	45 (94%)	3 (6%)	18	49
39	n	24/24 (100%)	22 (92%)	2 (8%)	11	40
40	o	92/94 (98%)	86 (94%)	6 (6%)	17	48
41	p	74/75 (99%)	73 (99%)	1 (1%)	67	82
42	r	108/121 (89%)	102 (94%)	6 (6%)	21	53

*Continued on next page...*

*Continued from previous page...*

Mol	Chain	Analysed	Rotameric	Outliers	Percentiles	
43	s	164/258 (64%)	158 (96%)	6 (4%)	34	61
44	t	126/137 (92%)	121 (96%)	5 (4%)	31	60
45	1	13/13 (100%)	13 (100%)	0	100	100
52	AA	180/245 (74%)	168 (93%)	12 (7%)	16	48
53	BB	194/231 (84%)	176 (91%)	18 (9%)	9	36
54	CC	187/225 (83%)	175 (94%)	12 (6%)	17	49
55	DD	190/202 (94%)	174 (92%)	16 (8%)	11	40
56	EE	224/225 (100%)	202 (90%)	22 (10%)	8	33
57	FF	158/170 (93%)	144 (91%)	14 (9%)	9	38
58	GG	207/218 (95%)	192 (93%)	15 (7%)	14	45
59	HH	165/174 (95%)	152 (92%)	13 (8%)	12	42
60	II	178/180 (99%)	163 (92%)	15 (8%)	11	40
61	JJ	161/168 (96%)	146 (91%)	15 (9%)	9	36
62	KK	87/136 (64%)	75 (86%)	12 (14%)	3	20
63	LL	130/142 (92%)	120 (92%)	10 (8%)	13	43
64	MM	99/108 (92%)	85 (86%)	14 (14%)	3	19
65	NN	130/131 (99%)	118 (91%)	12 (9%)	9	36
66	OO	106/130 (82%)	91 (86%)	15 (14%)	3	19
67	PP	109/130 (84%)	98 (90%)	11 (10%)	7	31
68	QQ	117/121 (97%)	110 (94%)	7 (6%)	19	51
69	RR	119/121 (98%)	110 (92%)	9 (8%)	13	43
70	SS	125/132 (95%)	111 (89%)	14 (11%)	6	28
71	TT	111/115 (96%)	103 (93%)	8 (7%)	14	45
72	UU	92/107 (86%)	86 (94%)	6 (6%)	17	48
73	VV	67/67 (100%)	63 (94%)	4 (6%)	19	51
74	WW	112/113 (99%)	103 (92%)	9 (8%)	12	42
75	XX	113/115 (98%)	107 (95%)	6 (5%)	22	54
76	YY	107/112 (96%)	91 (85%)	16 (15%)	3	17
77	ZZ	66/103 (64%)	62 (94%)	4 (6%)	18	50
78	aa	88/98 (90%)	81 (92%)	7 (8%)	12	42
79	bb	75/76 (99%)	68 (91%)	7 (9%)	9	36

*Continued on next page...*

*Continued from previous page...*

Mol	Chain	Analysed	Rotameric	Outliers	Percentiles	
80	cc	55/62 (89%)	50 (91%)	5 (9%)	9	37
81	dd	48/49 (98%)	47 (98%)	1 (2%)	53	73
82	ee	46/106 (43%)	42 (91%)	4 (9%)	10	39
83	ff	61/140 (44%)	56 (92%)	5 (8%)	11	41
84	gg	272/275 (99%)	263 (97%)	9 (3%)	38	64
86	ii	361/394 (92%)	339 (94%)	22 (6%)	18	50
87	jj	372/520 (72%)	354 (95%)	18 (5%)	25	56
All	All	10789/12266 (88%)	10088 (94%)	701 (6%)	21	48

All (701) residues with a non-rotameric sidechain are listed below:

Mol	Chain	Res	Type
1	A	5	ILE
1	A	102	LEU
1	A	109	GLU
1	A	128	ARG
1	A	163	ARG
1	A	175	ILE
1	A	200	ARG
1	A	209	HIS
1	A	221	LYS
1	A	233	ARG
1	A	242	ARG
2	B	10	ARG
2	B	17	LEU
2	B	53	MET
2	B	62	ARG
2	B	66	LYS
2	B	97	ARG
2	B	135	LYS
2	B	248	LEU
2	B	261	ARG
2	B	262	VAL
2	B	279	GLU
2	B	294	LYS
2	B	309	LEU
2	B	314	ILE
2	B	333	LEU
2	B	356	LYS
2	B	383	GLU

*Continued on next page...*



*Continued from previous page...*

<b>Mol</b>	<b>Chain</b>	<b>Res</b>	<b>Type</b>
3	C	20	LYS
3	C	95	MET
3	C	113	ARG
3	C	122	TYR
3	C	124	ILE
3	C	144	ILE
3	C	150	LEU
3	C	165	LYS
3	C	175	LYS
3	C	188	ARG
3	C	193	LYS
3	C	213	GLU
3	C	232	VAL
3	C	281	MET
3	C	284	MET
3	C	307	LYS
3	C	312	ARG
4	D	22	ARG
4	D	33	ARG
4	D	37	VAL
4	D	50	ARG
4	D	56	THR
4	D	89	LYS
4	D	104	LEU
4	D	124	GLU
4	D	225	GLN
4	D	234	ASP
4	D	264	LYS
4	D	268	ARG
5	E	52	LEU
5	E	58	ARG
5	E	112	LEU
5	E	123	ASP
5	E	141	ARG
5	E	143	LEU
5	E	144	ARG
5	E	169	LYS
5	E	178	VAL
5	E	213	LYS
5	E	286	PRO
5	E	289	LEU
5	E	291	PHE

*Continued on next page...*

*Continued from previous page...*

<b>Mol</b>	<b>Chain</b>	<b>Res</b>	<b>Type</b>
6	F	30	LYS
6	F	41	LEU
6	F	46	ARG
6	F	65	ARG
6	F	67	GLU
6	F	88	LEU
6	F	134	ILE
6	F	151	GLU
6	F	187	GLU
6	F	198	LYS
6	F	245	ARG
6	F	246	MET
7	G	126	ARG
7	G	163	LYS
7	G	184	LYS
7	G	203	LYS
7	G	204	LYS
7	G	223	LEU
7	G	226	LEU
7	G	230	MET
7	G	242	ARG
7	G	273	GLU
7	G	293	ASN
8	H	1	MET
8	H	20	LEU
8	H	52	LYS
8	H	54	ARG
8	H	59	LYS
8	H	66	GLU
8	H	74	CYS
8	H	105	ILE
8	H	106	GLN
8	H	128	MET
8	H	173	ARG
8	H	177	ASP
9	I	13	LYS
9	I	36	LEU
9	I	39	LYS
9	I	116	ARG
9	I	146	GLU
9	I	153	ARG
9	I	163	GLN

*Continued on next page...*

*Continued from previous page...*

<b>Mol</b>	<b>Chain</b>	<b>Res</b>	<b>Type</b>
9	I	164	LYS
9	I	208	LYS
10	J	16	ARG
10	J	28	GLU
10	J	33	LEU
10	J	81	GLU
10	J	101	ASP
10	J	113	ILE
10	J	175	LEU
11	L	10	LEU
11	L	63	THR
11	L	67	HIS
11	L	74	ARG
11	L	121	ARG
11	L	129	ARG
11	L	162	LYS
11	L	186	ARG
12	M	5	ARG
12	M	8	GLU
12	M	32	ASP
12	M	37	LEU
12	M	42	CYS
12	M	54	CYS
12	M	57	LEU
12	M	96	GLU
12	M	119	ARG
13	N	9	GLU
13	N	26	ARG
13	N	64	ILE
13	N	72	LYS
13	N	77	LYS
13	N	87	HIS
13	N	162	ARG
13	N	182	HIS
14	O	49	ARG
14	O	67	SER
14	O	74	ARG
14	O	82	ARG
14	O	128	ARG
14	O	130	LYS
14	O	140	ARG
14	O	145	VAL

*Continued on next page...*

*Continued from previous page...*

<b>Mol</b>	<b>Chain</b>	<b>Res</b>	<b>Type</b>
14	O	175	MET
14	O	179	LYS
14	O	202	LEU
15	P	24	VAL
15	P	25	HIS
15	P	69	ARG
15	P	86	LYS
15	P	91	LEU
15	P	127	ARG
15	P	128	ARG
15	P	147	GLU
16	Q	61	LEU
16	Q	63	LEU
16	Q	75	ARG
16	Q	91	ARG
16	Q	97	LYS
16	Q	138	LEU
16	Q	143	ARG
16	Q	168	ARG
17	R	8	LYS
17	R	36	ASN
17	R	50	ILE
17	R	52	ARG
17	R	89	MET
17	R	99	MET
17	R	103	ARG
17	R	113	LYS
17	R	133	LYS
17	R	138	LEU
17	R	176	ARG
17	R	178	GLN
18	S	7	LEU
18	S	9	GLU
18	S	24	THR
18	S	43	ARG
18	S	70	LYS
18	S	83	ARG
18	S	84	TYR
18	S	135	SER
18	S	149	LYS
18	S	159	LEU
18	S	174	THR

*Continued on next page...*

*Continued from previous page...*

<b>Mol</b>	<b>Chain</b>	<b>Res</b>	<b>Type</b>
19	T	5	LYS
19	T	33	ILE
19	T	60	LYS
19	T	63	ARG
19	T	88	ARG
19	T	96	ILE
19	T	117	LYS
19	T	144	ASN
19	T	146	LYS
19	T	159	MET
20	U	33	ILE
20	U	80	LYS
20	U	101	ARG
21	V	15	ARG
21	V	18	LEU
21	V	35	LYS
21	V	60	MET
21	V	91	LYS
21	V	99	GLU
21	V	109	LYS
21	V	123	LYS
22	W	91	MET
23	X	39	LYS
23	X	41	ARG
23	X	53	ARG
23	X	63	LYS
23	X	91	GLU
23	X	148	ASP
24	Y	2	LYS
24	Y	8	THR
24	Y	50	ARG
24	Y	52	ASP
24	Y	72	GLN
24	Y	74	TYR
24	Y	112	ASP
25	Z	33	THR
25	Z	42	LEU
25	Z	112	ARG
26	a	4	ARG
26	a	122	VAL
26	a	132	ARG
27	b	22	LYS

*Continued on next page...*

*Continued from previous page...*

<b>Mol</b>	<b>Chain</b>	<b>Res</b>	<b>Type</b>
27	b	40	LEU
27	b	101	HIS
28	c	37	MET
28	c	65	MET
28	c	78	ASN
29	d	23	ARG
29	d	31	LYS
29	d	44	ARG
29	d	48	GLU
29	d	78	ARG
29	d	85	ARG
29	d	98	SER
30	e	21	ILE
30	e	22	ARG
30	e	64	LYS
30	e	78	LEU
30	e	83	LYS
30	e	89	LEU
30	e	93	LYS
30	e	106	LYS
30	e	128	ARG
31	f	7	CYS
31	f	16	ARG
31	f	23	GLU
31	f	47	CYS
31	f	52	LYS
31	f	101	ILE
32	g	54	ARG
32	g	60	ARG
32	g	66	ARG
32	g	89	ASP
32	g	114	GLN
33	h	15	GLU
33	h	28	LEU
33	h	67	GLU
33	h	77	LYS
33	h	82	ASP
33	h	89	ARG
34	i	86	LYS
35	j	3	LYS
35	j	11	ARG
35	j	20	ARG

*Continued on next page...*

*Continued from previous page...*

<b>Mol</b>	<b>Chain</b>	<b>Res</b>	<b>Type</b>
35	j	46	LYS
35	j	58	THR
36	k	69	LEU
36	k	70	LYS
37	l	49	LEU
38	m	71	ARG
38	m	72	LYS
38	m	92	THR
39	n	1	MET
39	n	13	LEU
40	o	8	ARG
40	o	17	LYS
40	o	18	HIS
40	o	36	GLN
40	o	61	LYS
40	o	82	MET
41	p	8	VAL
42	r	8	MET
42	r	32	LEU
42	r	39	ARG
42	r	67	ARG
42	r	80	THR
42	r	103	HIS
43	s	38	LYS
43	s	95	LEU
43	s	105	ASN
43	s	146	LYS
43	s	187	LEU
43	s	191	GLN
44	t	37	LEU
44	t	98	ILE
44	t	133	LEU
44	t	137	GLN
44	t	144	ASP
52	AA	5	LEU
52	AA	12	GLU
52	AA	25	LEU
52	AA	56	GLU
52	AA	58	LEU
52	AA	59	LEU
52	AA	60	LEU
52	AA	111	GLN

*Continued on next page...*

*Continued from previous page...*

<b>Mol</b>	<b>Chain</b>	<b>Res</b>	<b>Type</b>
52	AA	122	LEU
52	AA	132	GLN
52	AA	136	GLU
52	AA	178	LEU
53	BB	38	MET
53	BB	42	ARG
53	BB	71	LEU
53	BB	74	LEU
53	BB	82	ARG
53	BB	92	GLN
53	BB	105	LEU
53	BB	125	VAL
53	BB	126	ASP
53	BB	157	GLN
53	BB	172	MET
53	BB	175	GLU
53	BB	181	LEU
53	BB	202	GLN
53	BB	207	LEU
53	BB	209	ASP
53	BB	213	ARG
53	BB	225	LEU
54	CC	72	ASP
54	CC	78	LEU
54	CC	114	LYS
54	CC	117	ARG
54	CC	121	ARG
54	CC	137	VAL
54	CC	167	ARG
54	CC	227	ARG
54	CC	235	ASN
54	CC	236	PHE
54	CC	252	THR
54	CC	254	ASP
55	DD	22	ASN
55	DD	28	GLU
55	DD	31	GLU
55	DD	35	SER
55	DD	45	ARG
55	DD	65	ARG
55	DD	76	ARG
55	DD	106	ARG

*Continued on next page...*



*Continued from previous page...*

<b>Mol</b>	<b>Chain</b>	<b>Res</b>	<b>Type</b>
55	DD	120	TYR
55	DD	127	MET
55	DD	142	LEU
55	DD	156	LEU
55	DD	160	SER
55	DD	198	ILE
55	DD	215	ASP
55	DD	218	LEU
56	EE	6	LYS
56	EE	17	HIS
56	EE	30	ARG
56	EE	42	LEU
56	EE	49	ARG
56	EE	51	ARG
56	EE	65	CYS
56	EE	66	MET
56	EE	67	GLN
56	EE	77	ARG
56	EE	88	ASP
56	EE	145	ARG
56	EE	159	THR
56	EE	162	ILE
56	EE	177	THR
56	EE	200	ARG
56	EE	205	PHE
56	EE	222	LEU
56	EE	232	ASN
56	EE	238	LEU
56	EE	240	ARG
56	EE	246	LEU
57	FF	29	GLN
57	FF	35	LEU
57	FF	36	GLN
57	FF	43	GLU
57	FF	63	LYS
57	FF	71	ARG
57	FF	88	MET
57	FF	89	THR
57	FF	91	ARG
57	FF	122	ARG
57	FF	168	THR
57	FF	169	ILE

*Continued on next page...*

*Continued from previous page...*

<b>Mol</b>	<b>Chain</b>	<b>Res</b>	<b>Type</b>
57	FF	175	ASP
57	FF	204	ARG
58	GG	25	ARG
58	GG	41	LEU
58	GG	63	MET
58	GG	64	LYS
58	GG	67	VAL
58	GG	81	HIS
58	GG	103	ASP
58	GG	116	LYS
58	GG	155	GLN
58	GG	159	ARG
58	GG	171	THR
58	GG	178	ARG
58	GG	190	ARG
58	GG	216	ARG
58	GG	230	LYS
59	HH	8	ILE
59	HH	36	LEU
59	HH	53	VAL
59	HH	76	GLN
59	HH	82	GLU
59	HH	100	ILE
59	HH	114	GLN
59	HH	127	ASP
59	HH	145	ARG
59	HH	151	SER
59	HH	160	LYS
59	HH	162	GLN
59	HH	194	LEU
60	II	12	ARG
60	II	23	LYS
60	II	26	LYS
60	II	56	ARG
60	II	74	ARG
60	II	79	ILE
60	II	100	CYS
60	II	121	LEU
60	II	130	THR
60	II	161	LEU
60	II	162	LEU
60	II	168	GLN

*Continued on next page...*

*Continued from previous page...*

<b>Mol</b>	<b>Chain</b>	<b>Res</b>	<b>Type</b>
60	II	175	ILE
60	II	178	ARG
60	II	203	LYS
61	JJ	9	CYS
61	JJ	29	LEU
61	JJ	38	ARG
61	JJ	45	ARG
61	JJ	61	LEU
61	JJ	65	GLU
61	JJ	69	ARG
61	JJ	70	ARG
61	JJ	79	ARG
61	JJ	89	GLU
61	JJ	94	LEU
61	JJ	109	ARG
61	JJ	112	THR
61	JJ	116	LYS
61	JJ	158	ASP
62	KK	1	MET
62	KK	2	LEU
62	KK	17	LYS
62	KK	20	VAL
62	KK	29	MET
62	KK	35	LEU
62	KK	50	GLN
62	KK	60	GLU
62	KK	72	THR
62	KK	89	ILE
62	KK	93	THR
62	KK	96	ARG
63	LL	16	ILE
63	LL	20	LYS
63	LL	40	ILE
63	LL	42	LEU
63	LL	49	GLU
63	LL	56	ILE
63	LL	69	ARG
63	LL	111	VAL
63	LL	126	VAL
63	LL	134	LEU
64	MM	22	LEU
64	MM	31	LEU

*Continued on next page...*

*Continued from previous page...*

<b>Mol</b>	<b>Chain</b>	<b>Res</b>	<b>Type</b>
64	MM	33	ARG
64	MM	36	ARG
64	MM	40	LYS
64	MM	42	LEU
64	MM	45	ARG
64	MM	49	LEU
64	MM	55	ASN
64	MM	83	LYS
64	MM	85	LEU
64	MM	96	ARG
64	MM	101	ARG
64	MM	112	LYS
65	NN	3	ARG
65	NN	20	ARG
65	NN	27	LYS
65	NN	46	THR
65	NN	55	ARG
65	NN	60	VAL
65	NN	75	LEU
65	NN	78	LYS
65	NN	84	LEU
65	NN	107	LYS
65	NN	132	LYS
65	NN	134	VAL
66	OO	25	GLU
66	OO	34	PHE
66	OO	38	ASN
66	OO	50	LYS
66	OO	51	GLU
66	OO	56	VAL
66	OO	76	LEU
66	OO	85	CYS
66	OO	119	LEU
66	OO	128	ARG
66	OO	131	ASP
66	OO	143	LYS
66	OO	146	ARG
66	OO	150	ARG
66	OO	151	LEU
67	PP	13	ARG
67	PP	14	LYS
67	PP	15	PHE

*Continued on next page...*

*Continued from previous page...*

<b>Mol</b>	<b>Chain</b>	<b>Res</b>	<b>Type</b>
67	PP	27	ASP
67	PP	37	TYR
67	PP	42	ARG
67	PP	44	ARG
67	PP	83	MET
67	PP	108	LYS
67	PP	111	MET
67	PP	130	ARG
68	QQ	31	LEU
68	QQ	41	MET
68	QQ	47	LEU
68	QQ	48	GLN
68	QQ	60	LYS
68	QQ	123	ASP
68	QQ	140	ARG
69	RR	3	ARG
69	RR	5	ARG
69	RR	30	THR
69	RR	31	ASN
69	RR	35	CYS
69	RR	44	LYS
69	RR	58	MET
69	RR	121	GLN
69	RR	132	ARG
70	SS	8	LYS
70	SS	23	ARG
70	SS	46	ARG
70	SS	52	LEU
70	SS	59	LEU
70	SS	62	ASP
70	SS	63	GLU
70	SS	69	THR
70	SS	75	ARG
70	SS	83	PHE
70	SS	110	ASP
70	SS	121	ARG
70	SS	132	ARG
70	SS	136	THR
71	TT	62	ARG
71	TT	75	MET
71	TT	102	ARG
71	TT	108	GLU

*Continued on next page...*

*Continued from previous page...*

<b>Mol</b>	<b>Chain</b>	<b>Res</b>	<b>Type</b>
71	TT	110	LEU
71	TT	121	ARG
71	TT	124	THR
71	TT	142	LYS
72	UU	55	ARG
72	UU	56	MET
72	UU	79	ARG
72	UU	88	LEU
72	UU	106	ILE
72	UU	111	GLU
73	VV	12	TYR
73	VV	32	ILE
73	VV	66	ASP
73	VV	68	SER
74	WW	12	LYS
74	WW	23	ARG
74	WW	28	ARG
74	WW	36	ARG
74	WW	51	GLU
74	WW	92	ASN
74	WW	103	VAL
74	WW	104	LEU
74	WW	117	ARG
75	XX	29	LYS
75	XX	67	ARG
75	XX	82	THR
75	XX	105	PHE
75	XX	115	ILE
75	XX	129	SER
76	YY	16	ARG
76	YY	17	LEU
76	YY	20	ARG
76	YY	32	LYS
76	YY	38	THR
76	YY	40	ILE
76	YY	47	MET
76	YY	50	THR
76	YY	61	ARG
76	YY	74	MET
76	YY	79	LEU
76	YY	88	LYS
76	YY	93	ARG

*Continued on next page...*

*Continued from previous page...*

<b>Mol</b>	<b>Chain</b>	<b>Res</b>	<b>Type</b>
76	YY	100	LYS
76	YY	101	LYS
76	YY	115	LYS
77	ZZ	80	ARG
77	ZZ	89	GLN
77	ZZ	92	LEU
77	ZZ	104	ARG
78	aa	15	ARG
78	aa	21	ILE
78	aa	34	LYS
78	aa	41	ILE
78	aa	44	ILE
78	aa	55	GLU
78	aa	100	ARG
79	bb	17	ARG
79	bb	34	ASP
79	bb	36	LYS
79	bb	37	CYS
79	bb	42	LYS
79	bb	80	ARG
79	bb	81	ARG
80	cc	27	CYS
80	cc	28	THR
80	cc	31	ARG
80	cc	40	ARG
80	cc	44	ARG
81	dd	20	SER
82	ee	97	LYS
82	ee	99	LYS
82	ee	107	ARG
82	ee	113	ARG
83	ff	83	LYS
83	ff	94	LYS
83	ff	99	LYS
83	ff	138	ARG
83	ff	140	TYR
84	gg	17	TRP
84	gg	20	GLN
84	gg	38	LYS
84	gg	79	LEU
84	gg	119	GLN
84	gg	198	VAL

*Continued on next page...*

*Continued from previous page...*

<b>Mol</b>	<b>Chain</b>	<b>Res</b>	<b>Type</b>
84	gg	207	CYS
84	gg	289	LEU
84	gg	306	LEU
86	ii	16	LYS
86	ii	61	ASN
86	ii	63	LYS
86	ii	65	ARG
86	ii	82	LEU
86	ii	103	GLU
86	ii	111	ASN
86	ii	180	HIS
86	ii	189	ARG
86	ii	211	GLN
86	ii	212	LEU
86	ii	232	PHE
86	ii	241	MET
86	ii	291	PHE
86	ii	300	LYS
86	ii	330	ARG
86	ii	339	GLU
86	ii	341	GLU
86	ii	368	LEU
86	ii	380	ASN
86	ii	381	ASN
86	ii	417	VAL
87	jj	231	GLN
87	jj	249	ARG
87	jj	292	PHE
87	jj	340	GLU
87	jj	343	MET
87	jj	353	LEU
87	jj	382	PHE
87	jj	392	LYS
87	jj	413	PHE
87	jj	447	LYS
87	jj	455	VAL
87	jj	468	GLN
87	jj	509	GLU
87	jj	511	GLU
87	jj	551	VAL
87	jj	601	ILE
87	jj	611	GLN

*Continued on next page...*



*Continued from previous page...*

Mol	Chain	Res	Type
87	jj	618	ARG

Sometimes sidechains can be flipped to improve hydrogen bonding and reduce clashes. All (38) such sidechains are listed below:

Mol	Chain	Res	Type
4	D	191	ASN
7	G	135	GLN
8	H	78	GLN
12	M	20	HIS
12	M	48	GLN
13	N	32	GLN
15	P	137	ASN
24	Y	14	ASN
24	Y	56	GLN
28	c	78	ASN
29	d	30	HIS
32	g	14	ASN
42	r	70	GLN
42	r	103	HIS
43	s	34	ASN
53	BB	158	HIS
54	CC	113	GLN
54	CC	235	ASN
56	EE	36	HIS
56	EE	142	HIS
56	EE	260	GLN
57	FF	118	ASN
58	GG	13	GLN
59	HH	114	GLN
59	HH	162	GLN
61	JJ	154	GLN
68	QQ	142	GLN
79	bb	49	HIS
80	cc	26	GLN
86	ii	67	ASN
86	ii	170	HIS
86	ii	380	ASN
87	jj	214	ASN
87	jj	313	GLN
87	jj	428	ASN
87	jj	499	ASN
87	jj	523	ASN

*Continued on next page...*

*Continued from previous page...*

Mol	Chain	Res	Type
87	jj	555	HIS

### 5.3.3 RNA [i](#)

Mol	Chain	Analysed	Backbone Outliers	Pucker Outliers
46	2	74/76 (97%)	13 (17%)	0
47	3	72/75 (96%)	22 (30%)	2 (2%)
48	5	3514/3543 (99%)	876 (24%)	169 (4%)
49	7	119/120 (99%)	14 (11%)	2 (1%)
50	8	149/156 (95%)	32 (21%)	6 (4%)
51	9	1679/1869 (89%)	422 (25%)	71 (4%)
85	hh	14/15 (93%)	8 (57%)	0
All	All	5621/5854 (96%)	1387 (24%)	250 (4%)

All (1387) RNA backbone outliers are listed below:

Mol	Chain	Res	Type
46	2	9	A
46	2	13	U
46	2	16	C
46	2	19	G
46	2	20	U
46	2	21	A
46	2	46	G
46	2	47	U
46	2	49	C
46	2	58	A
46	2	64	G
46	2	72	C
46	2	75	C
47	3	7	A
47	3	13	C
47	3	14	A
47	3	16	C
47	3	21	A
47	3	25	C
47	3	28	C
47	3	29	A
47	3	34	U
47	3	35	U
47	3	36	U

*Continued on next page...*

*Continued from previous page...*

<b>Mol</b>	<b>Chain</b>	<b>Res</b>	<b>Type</b>
47	3	40	C
47	3	42	G
47	3	47	U
47	3	49	C
47	3	58	A
47	3	60	U
47	3	61	C
47	3	63	C
47	3	65	G
47	3	72	C
47	3	76	A
48	5	12	A
48	5	13	U
48	5	15	A
48	5	25	A
48	5	35	U
48	5	39	A
48	5	42	A
48	5	43	U
48	5	44	A
48	5	48	G
48	5	49	U
48	5	56	A
48	5	58	G
48	5	59	A
48	5	64	A
48	5	65	A
48	5	72	C
48	5	73	A
48	5	91	G
48	5	93	G
48	5	109	G
48	5	110	C
48	5	118	C
48	5	119	G
48	5	120	A
48	5	126	C
48	5	134	G
48	5	135	G
48	5	136	C
48	5	137	G
48	5	143	C

*Continued on next page...*

*Continued from previous page...*

<b>Mol</b>	<b>Chain</b>	<b>Res</b>	<b>Type</b>
48	5	144	G
48	5	159	C
48	5	160	G
48	5	172	C
48	5	173	C
48	5	177	G
48	5	179	G
48	5	197	A
48	5	200	U
48	5	201	C
48	5	202	C
48	5	205	C
48	5	209	U
48	5	216	C
48	5	217	C
48	5	218	A
48	5	220	C
48	5	221	C
48	5	224	U
48	5	226	G
48	5	227	A
48	5	233	U
48	5	234	G
48	5	245	C
48	5	246	G
48	5	253	G
48	5	262	G
48	5	263	G
48	5	266	C
48	5	267	G
48	5	276	C
48	5	279	A
48	5	280	G
48	5	281	U
48	5	297	U
48	5	306	A
48	5	309	C
48	5	310	G
48	5	315	G
48	5	316	U
48	5	322	C
48	5	328	A

*Continued on next page...*

*Continued from previous page...*

<b>Mol</b>	<b>Chain</b>	<b>Res</b>	<b>Type</b>
48	5	334	A
48	5	340	C
48	5	350	C
48	5	357	U
48	5	361	C
48	5	363	A
48	5	386	A
48	5	387	G
48	5	399	G
48	5	406	C
48	5	407	A
48	5	408	A
48	5	409	G
48	5	410	A
48	5	412	G
48	5	413	G
48	5	414	C
48	5	431	G
48	5	432	U
48	5	446	C
48	5	449	C
48	5	450	G
48	5	452	A
48	5	453	G
48	5	454	U
48	5	455	C
48	5	457	G
48	5	466	A
48	5	467	U
48	5	468	U
48	5	469	C
48	5	481	G
48	5	481(A)	C
48	5	482	G
48	5	483	G
48	5	484	U
48	5	485	C
48	5	486	C
48	5	490	C
48	5	492	U
48	5	493	G
48	5	495	C

*Continued on next page...*

*Continued from previous page...*

<b>Mol</b>	<b>Chain</b>	<b>Res</b>	<b>Type</b>
48	5	497	G
48	5	498	C
48	5	499	G
48	5	505	G
48	5	510	U
48	5	649	A
48	5	654	C
48	5	658	C
48	5	666	G
48	5	667	A
48	5	668	C
48	5	672	C
48	5	683	C
48	5	685	C
48	5	687	U
48	5	696	C
48	5	697	G
48	5	704	C
48	5	705	G
48	5	708	G
48	5	719	C
48	5	722	G
48	5	729	G
48	5	730	G
48	5	731	G
48	5	738	C
48	5	738(A)	C
48	5	739	G
48	5	747	A
48	5	748	G
48	5	749	G
48	5	750	U
48	5	756	G
48	5	758	G
48	5	911	U
48	5	913	U
48	5	914	U
48	5	915	A
48	5	916	C
48	5	917	A
48	5	918	G
48	5	923	C

*Continued on next page...*

*Continued from previous page...*

<b>Mol</b>	<b>Chain</b>	<b>Res</b>	<b>Type</b>
48	5	924	C
48	5	925	C
48	5	926	G
48	5	928	C
48	5	929	A
48	5	931	C
48	5	932	A
48	5	933	G
48	5	934	C
48	5	935	A
48	5	935(A)	G
48	5	936	C
48	5	938	C
48	5	939	G
48	5	943	A
48	5	944	A
48	5	945	U
48	5	955	G
48	5	956	A
48	5	957	G
48	5	959	G
48	5	960	A
48	5	961	G
48	5	962	C
48	5	965	G
48	5	966	A
48	5	967	C
48	5	968	C
48	5	969	C
48	5	970	G
48	5	972	C
48	5	973	G
48	5	979	C
48	5	983	C
48	5	990	C
48	5	1072	C
48	5	1073	G
48	5	1075	G
48	5	1076	C
48	5	1078	A
48	5	1079	C
48	5	1082	C

*Continued on next page...*

*Continued from previous page...*

<b>Mol</b>	<b>Chain</b>	<b>Res</b>	<b>Type</b>
48	5	1174	G
48	5	1177	U
48	5	1179	U
48	5	1184	A
48	5	1194	G
48	5	1195	G
48	5	1211	G
48	5	1212	G
48	5	1214	C
48	5	1215	C
48	5	1234	G
48	5	1235	G
48	5	1236	C
48	5	1237	C
48	5	1238	A
48	5	1239	C
48	5	1272	C
48	5	1273	G
48	5	1274	A
48	5	1275	G
48	5	1276	C
48	5	1280	C
48	5	1284	G
48	5	1287	G
48	5	1288	G
48	5	1291	G
48	5	1292	C
48	5	1293	G
48	5	1295	U
48	5	1296	G
48	5	1301	C
48	5	1303	A
48	5	1304	C
48	5	1313	C
48	5	1326	A
48	5	1328	G
48	5	1330	A
48	5	1337	A
48	5	1354	A
48	5	1359	G
48	5	1360	G
48	5	1364	U

*Continued on next page...*



*Continued from previous page...*

<b>Mol</b>	<b>Chain</b>	<b>Res</b>	<b>Type</b>
48	5	1370	G
48	5	1371	A
48	5	1377	G
48	5	1378	C
48	5	1379	C
48	5	1380	G
48	5	1381	U
48	5	1387	A
48	5	1394	G
48	5	1397	A
48	5	1398	A
48	5	1401	C
48	5	1403	G
48	5	1416	G
48	5	1418	C
48	5	1419	G
48	5	1420	A
48	5	1421	G
48	5	1429	C
48	5	1435	G
48	5	1436	C
48	5	1437	C
48	5	1438	U
48	5	1441	C
48	5	1442	C
48	5	1445	U
48	5	1446	C
48	5	1453	G
48	5	1455	G
48	5	1456	C
48	5	1457	G
48	5	1458	C
48	5	1465	G
48	5	1475	G
48	5	1477	C
48	5	1478	C
48	5	1482	G
48	5	1483	C
48	5	1484	G
48	5	1486	C
48	5	1489	G
48	5	1493	G

*Continued on next page...*

*Continued from previous page...*

<b>Mol</b>	<b>Chain</b>	<b>Res</b>	<b>Type</b>
48	5	1497	A
48	5	1498	G
48	5	1501	C
48	5	1502	G
48	5	1504	G
48	5	1514	U
48	5	1516	G
48	5	1518	A
48	5	1523	A
48	5	1525	A
48	5	1534	A
48	5	1535	C
48	5	1547	A
48	5	1554	A
48	5	1563	A
48	5	1564	A
48	5	1566	C
48	5	1574	G
48	5	1578	U
48	5	1586	G
48	5	1591	U
48	5	1596	U
48	5	1601	A
48	5	1602	U
48	5	1612	G
48	5	1613	A
48	5	1624	G
48	5	1625	G
48	5	1631	A
48	5	1633	G
48	5	1634	A
48	5	1654	G
48	5	1656	U
48	5	1661	C
48	5	1670	G
48	5	1676	C
48	5	1677	U
48	5	1679	A
48	5	1691	G
48	5	1724	G
48	5	1726	U
48	5	1734	G

*Continued on next page...*

*Continued from previous page...*

<b>Mol</b>	<b>Chain</b>	<b>Res</b>	<b>Type</b>
48	5	1735	U
48	5	1740	C
48	5	1741	G
48	5	1742	A
48	5	1750	G
48	5	1753	G
48	5	1755	C
48	5	1756	U
48	5	1757	U
48	5	1761	G
48	5	1763	C
48	5	1764	G
48	5	1768	C
48	5	1772	C
48	5	1773	U
48	5	1776	A
48	5	1780	A
48	5	1781	U
48	5	1787	A
48	5	1797	G
48	5	1799	G
48	5	1800	U
48	5	1803	G
48	5	1804	A
48	5	1805	A
48	5	1819	G
48	5	1820	U
48	5	1821	G
48	5	1822	U
48	5	1823	G
48	5	1828	C
48	5	1833	G
48	5	1834	U
48	5	1835	G
48	5	1836	G
48	5	1837	A
48	5	1842	G
48	5	1855	G
48	5	1867	A
48	5	1869	G
48	5	1882	U
48	5	1883	G

*Continued on next page...*

*Continued from previous page...*

<b>Mol</b>	<b>Chain</b>	<b>Res</b>	<b>Type</b>
48	5	1893	C
48	5	1897	A
48	5	1910	G
48	5	1918	U
48	5	1920	C
48	5	1921	C
48	5	1922	G
48	5	1923	A
48	5	1931	C
48	5	1933	G
48	5	1941	A
48	5	1945	G
48	5	1948	G
48	5	1951	G
48	5	1952	G
48	5	1959	U
48	5	1961	G
48	5	1962	A
48	5	1963	C
48	5	1966	C
48	5	1967	A
48	5	1976	G
48	5	1977	C
48	5	1979	A
48	5	1980	U
48	5	1981	G
48	5	1982	G
48	5	1983	A
48	5	1984	A
48	5	1986	U
48	5	1987	C
48	5	1991	A
48	5	1993	C
48	5	1997	U
48	5	2001	G
48	5	2002	A
48	5	2003	G
48	5	2004	U
48	5	2005	G
48	5	2008	U
48	5	2011	C
48	5	2024	G

*Continued on next page...*

*Continued from previous page...*

<b>Mol</b>	<b>Chain</b>	<b>Res</b>	<b>Type</b>
48	5	2025	A
48	5	2026	A
48	5	2044	U
48	5	2046	G
48	5	2047	A
48	5	2048	U
48	5	2052	G
48	5	2055	G
48	5	2056	G
48	5	2062	C
48	5	2064	G
48	5	2069	A
48	5	2070	U
48	5	2084	U
48	5	2085	G
48	5	2089	G
48	5	2090	U
48	5	2092	G
48	5	2093	G
48	5	2094	C
48	5	2095	A
48	5	2097	A
48	5	2098	G
48	5	2100	G
48	5	2101	A
48	5	2102	G
48	5	2104	A
48	5	2105	A
48	5	2106	G
48	5	2107	A
48	5	2108	G
48	5	2110	G
48	5	2259	G
48	5	2260	C
48	5	2262	G
48	5	2266	C
48	5	2267	U
48	5	2268	A
48	5	2269	C
48	5	2270	G
48	5	2275	G
48	5	2278	G

*Continued on next page...*

*Continued from previous page...*

<b>Mol</b>	<b>Chain</b>	<b>Res</b>	<b>Type</b>
48	5	2279	A
48	5	2288	G
48	5	2289	C
48	5	2300	A
48	5	2301	G
48	5	2313	A
48	5	2314	G
48	5	2322	G
48	5	2331	G
48	5	2333	G
48	5	2348	G
48	5	2351	C
48	5	2357	G
48	5	2364	G
48	5	2370	A
48	5	2395	A
48	5	2396	A
48	5	2399	G
48	5	2402	G
48	5	2416	G
48	5	2417	A
48	5	2422	C
48	5	2424	G
48	5	2425	U
48	5	2428	A
48	5	2429	A
48	5	2433	G
48	5	2441	C
48	5	2450	G
48	5	2469	C
48	5	2470	C
48	5	2471	G
48	5	2475	G
48	5	2479	G
48	5	2483	G
48	5	2485	U
48	5	2488	C
48	5	2489	C
48	5	2490	U
48	5	2491	C
48	5	2493	G
48	5	2495	U

*Continued on next page...*

*Continued from previous page...*

<b>Mol</b>	<b>Chain</b>	<b>Res</b>	<b>Type</b>
48	5	2503	G
48	5	2504	C
48	5	2505	C
48	5	2506	G
48	5	2513	A
48	5	2521	G
48	5	2530	U
48	5	2537	A
48	5	2546	G
48	5	2547	G
48	5	2554	U
48	5	2555	G
48	5	2564	G
48	5	2566	G
48	5	2571	C
48	5	2575	U
48	5	2583	C
48	5	2586	G
48	5	2587	A
48	5	2601	A
48	5	2618	G
48	5	2620	G
48	5	2623	A
48	5	2627	C
48	5	2638	G
48	5	2640	G
48	5	2647	A
48	5	2661	U
48	5	2662	G
48	5	2663	G
48	5	2669	C
48	5	2670	C
48	5	2673	G
48	5	2676	A
48	5	2681	G
48	5	2686	G
48	5	2687	U
48	5	2688	G
48	5	2689	C
48	5	2695	A
48	5	2696	A
48	5	2707	U

*Continued on next page...*

*Continued from previous page...*

<b>Mol</b>	<b>Chain</b>	<b>Res</b>	<b>Type</b>
48	5	2708	U
48	5	2709	C
48	5	2710	C
48	5	2711	G
48	5	2712	G
48	5	2714	G
48	5	2716	C
48	5	2719	C
48	5	2721	G
48	5	2725	A
48	5	2726	G
48	5	2740	U
48	5	2743	A
48	5	2744	A
48	5	2754	G
48	5	2755	A
48	5	2760	G
48	5	2761	U
48	5	2763	U
48	5	2764	A
48	5	2769	U
48	5	2772	C
48	5	2787	A
48	5	2788	U
48	5	2789	A
48	5	2790	U
48	5	2794	C
48	5	2795	A
48	5	2796	G
48	5	2798	A
48	5	2806	A
48	5	2807	A
48	5	2808	G
48	5	2814	C
48	5	2826	U
48	5	2827	G
48	5	2828	U
48	5	2829	U
48	5	2835	A
48	5	2838	G
48	5	2839	U
48	5	2842	G

*Continued on next page...*



*Continued from previous page...*

<b>Mol</b>	<b>Chain</b>	<b>Res</b>	<b>Type</b>
48	5	2845	A
48	5	2855	G
48	5	2864	A
48	5	2875	C
48	5	2884	G
48	5	2896	G
48	5	2897	G
48	5	3598	C
48	5	3599	A
48	5	3604	A
48	5	3605	C
48	5	3615	G
48	5	3625	G
48	5	3626	G
48	5	3635	A
48	5	3644	U
48	5	3653	A
48	5	3662	A
48	5	3671	G
48	5	3673	C
48	5	3674	G
48	5	3692	A
48	5	3696	C
48	5	3698	G
48	5	3711	A
48	5	3712	A
48	5	3722	G
48	5	3729	U
48	5	3733	A
48	5	3740	G
48	5	3748	A
48	5	3750	G
48	5	3753	G
48	5	3756	A
48	5	3759	A
48	5	3760	A
48	5	3765	G
48	5	3766	A
48	5	3773	U
48	5	3774	A
48	5	3776	G
48	5	3777	G

*Continued on next page...*

*Continued from previous page...*

<b>Mol</b>	<b>Chain</b>	<b>Res</b>	<b>Type</b>
48	5	3778	U
48	5	3783	A
48	5	3784	A
48	5	3785	A
48	5	3786	U
48	5	3799	A
48	5	3810	C
48	5	3811	G
48	5	3812	C
48	5	3814	U
48	5	3817	A
48	5	3819	G
48	5	3822	U
48	5	3831	U
48	5	3838	U
48	5	3839	G
48	5	3840	U
48	5	3851	U
48	5	3859	G
48	5	3867	A
48	5	3876	A
48	5	3877	A
48	5	3878	C
48	5	3879	G
48	5	3889	G
48	5	3892	U
48	5	3897	G
48	5	3901	A
48	5	3905	A
48	5	3906	A
48	5	3907	G
48	5	3915	U
48	5	3916	G
48	5	3917	A
48	5	3927	U
48	5	3939	G
48	5	3943	A
48	5	4067	U
48	5	4069	U
48	5	4071	U
48	5	4076	G
48	5	4084	G

*Continued on next page...*

*Continued from previous page...*

<b>Mol</b>	<b>Chain</b>	<b>Res</b>	<b>Type</b>
48	5	4085	A
48	5	4086	G
48	5	4088	C
48	5	4099	G
48	5	4100	C
48	5	4116	C
48	5	4117	U
48	5	4118	U
48	5	4119	C
48	5	4120	U
48	5	4121	G
48	5	4122	G
48	5	4125	C
48	5	4127	A
48	5	4150	G
48	5	4158	C
48	5	4162	C
48	5	4163	U
48	5	4164	C
48	5	4166	G
48	5	4168	G
48	5	4171	C
48	5	4183	G
48	5	4184	G
48	5	4190	U
48	5	4191	G
48	5	4203	A
48	5	4212	A
48	5	4213	A
48	5	4218	U
48	5	4219	A
48	5	4225	G
48	5	4229	U
48	5	4232	U
48	5	4233	A
48	5	4249	G
48	5	4251	A
48	5	4255	A
48	5	4257	A
48	5	4258	C
48	5	4265	U
48	5	4268	A

*Continued on next page...*

*Continued from previous page...*

<b>Mol</b>	<b>Chain</b>	<b>Res</b>	<b>Type</b>
48	5	4271	A
48	5	4273	A
48	5	4281	A
48	5	4291	G
48	5	4297	G
48	5	4304	A
48	5	4305	G
48	5	4306	U
48	5	4314	C
48	5	4317	A
48	5	4318	C
48	5	4319	C
48	5	4326	G
48	5	4329	G
48	5	4330	G
48	5	4335	C
48	5	4336	A
48	5	4339	A
48	5	4349	C
48	5	4350	C
48	5	4354	U
48	5	4355	G
48	5	4373	G
48	5	4376	A
48	5	4377	G
48	5	4378	A
48	5	4379	A
48	5	4380	A
48	5	4387	C
48	5	4391	G
48	5	4393	G
48	5	4394	A
48	5	4395	U
48	5	4398	C
48	5	4401	G
48	5	4415	A
48	5	4419	U
48	5	4421	C
48	5	4422	A
48	5	4440	G
48	5	4444	C
48	5	4448	G

*Continued on next page...*

*Continued from previous page...*

<b>Mol</b>	<b>Chain</b>	<b>Res</b>	<b>Type</b>
48	5	4449	A
48	5	4450	U
48	5	4453	C
48	5	4464	A
48	5	4471	U
48	5	4475	G
48	5	4476	C
48	5	4488	A
48	5	4495	G
48	5	4500	U
48	5	4510	A
48	5	4511	A
48	5	4512	U
48	5	4513	A
48	5	4519	C
48	5	4520	G
48	5	4524	G
48	5	4528	G
48	5	4531	U
48	5	4548	A
48	5	4549	G
48	5	4560	C
48	5	4567	G
48	5	4570	G
48	5	4573	G
48	5	4575	G
48	5	4578	G
48	5	4584	A
48	5	4586	G
48	5	4590	A
48	5	4618	G
48	5	4627	U
48	5	4636	U
48	5	4637	G
48	5	4639	G
48	5	4656	A
48	5	4657	U
48	5	4661	G
48	5	4667	C
48	5	4670	C
48	5	4672	A
48	5	4677	U

*Continued on next page...*

*Continued from previous page...*

<b>Mol</b>	<b>Chain</b>	<b>Res</b>	<b>Type</b>
48	5	4678	G
48	5	4687	A
48	5	4694	G
48	5	4700	A
48	5	4701	A
48	5	4709	U
48	5	4719	G
48	5	4720	C
48	5	4721	G
48	5	4728	U
48	5	4736	C
48	5	4737	G
48	5	4745	G
48	5	4751	G
48	5	4754	G
48	5	4755	G
48	5	4756	C
48	5	4757	C
48	5	4759	C
48	5	4761	G
48	5	4765	G
48	5	4771	C
48	5	4772	C
48	5	4868	G
48	5	4870	G
48	5	4871	C
48	5	4872	G
48	5	4873	G
48	5	4874	A
48	5	4875	G
48	5	4876	A
48	5	4877	G
48	5	4882	U
48	5	4883	C
48	5	4885	U
48	5	4887	C
48	5	4891	G
48	5	4895	C
48	5	4897	G
48	5	4910	A
48	5	4912	G
48	5	4913	G

*Continued on next page...*

*Continued from previous page...*

<b>Mol</b>	<b>Chain</b>	<b>Res</b>	<b>Type</b>
48	5	4914	G
48	5	4915	G
48	5	4918	C
48	5	4919	G
48	5	4921	C
48	5	4924	C
48	5	4925	U
48	5	4926	C
48	5	4928	C
48	5	4931	G
48	5	4935	C
48	5	4937	C
48	5	4938	A
48	5	4940	C
48	5	4943	A
48	5	4944	C
48	5	4948	C
48	5	4949	G
48	5	4950	U
48	5	4951	G
48	5	4956	A
48	5	4957	C
48	5	4958	C
48	5	4964	C
48	5	4965	U
48	5	4966	A
48	5	4967	A
48	5	4976	U
48	5	4985	U
48	5	4988	U
48	5	4989	U
48	5	4990	C
48	5	4991	U
48	5	5007	A
48	5	5014	A
48	5	5017	G
48	5	5035	U
48	5	5040	U
48	5	5041	G
48	5	5047	C
48	5	5050	C
48	5	5052	C

*Continued on next page...*

*Continued from previous page...*

<b>Mol</b>	<b>Chain</b>	<b>Res</b>	<b>Type</b>
48	5	5053	U
48	5	5054	C
48	5	5056	A
48	5	5061	A
48	5	5062	G
49	7	7	G
49	7	11	A
49	7	22	A
49	7	33	U
49	7	42	A
49	7	53	U
49	7	54	A
49	7	64	G
49	7	97	G
49	7	100	A
49	7	106	G
49	7	110	G
49	7	117	G
49	7	120	U
50	8	2	G
50	8	3	A
50	8	32	C
50	8	34	U
50	8	35	C
50	8	49	G
50	8	59	A
50	8	62	A
50	8	63	U
50	8	75	G
50	8	79	G
50	8	86	U
50	8	87	G
50	8	94	G
50	8	95	A
50	8	103	A
50	8	104	A
50	8	105	C
50	8	107	C
50	8	109	C
50	8	110	U
50	8	111	U
50	8	112	G

*Continued on next page...*



*Continued from previous page...*

<b>Mol</b>	<b>Chain</b>	<b>Res</b>	<b>Type</b>
50	8	114	G
50	8	121	G
50	8	123	U
50	8	124	U
50	8	125	C
50	8	126	C
50	8	127	U
50	8	137	A
50	8	143	G
51	9	2	A
51	9	3	C
51	9	4	C
51	9	17	C
51	9	25	A
51	9	26	U
51	9	33	G
51	9	41	G
51	9	44	U
51	9	45	A
51	9	46	A
51	9	56	G
51	9	58	C
51	9	59	U
51	9	60	A
51	9	62	G
51	9	65	C
51	9	67	C
51	9	68	A
51	9	70	G
51	9	71	G
51	9	73	C
51	9	74	G
51	9	75	G
51	9	77	A
51	9	79	A
51	9	99	A
51	9	100	U
51	9	103	A
51	9	104	A
51	9	110	U
51	9	111	A
51	9	113	G

*Continued on next page...*

*Continued from previous page...*

<b>Mol</b>	<b>Chain</b>	<b>Res</b>	<b>Type</b>
51	9	115	U
51	9	116	U
51	9	124	U
51	9	126	G
51	9	127	C
51	9	129	C
51	9	130	G
51	9	141	A
51	9	143	U
51	9	147	A
51	9	155	G
51	9	158	A
51	9	161	U
51	9	162	C
51	9	163	U
51	9	167	G
51	9	168	C
51	9	173	A
51	9	175	A
51	9	182	C
51	9	183	G
51	9	184	G
51	9	188	C
51	9	189	U
51	9	191	A
51	9	192	C
51	9	200	G
51	9	202	G
51	9	206	G
51	9	213	G
51	9	215	G
51	9	289	G
51	9	292	A
51	9	293	C
51	9	294	U
51	9	302	A
51	9	304	C
51	9	307	G
51	9	308	G
51	9	309	G
51	9	312	G
51	9	314	U

*Continued on next page...*

*Continued from previous page...*

<b>Mol</b>	<b>Chain</b>	<b>Res</b>	<b>Type</b>
51	9	318	A
51	9	319	C
51	9	322	C
51	9	331	C
51	9	332	G
51	9	335	G
51	9	340	C
51	9	347	G
51	9	351	G
51	9	360	A
51	9	362	C
51	9	364	A
51	9	368	U
51	9	370	G
51	9	371	A
51	9	372	U
51	9	381	C
51	9	382	C
51	9	383	G
51	9	384	U
51	9	385	G
51	9	386	C
51	9	400	C
51	9	407	G
51	9	409	C
51	9	417	C
51	9	418	A
51	9	435	A
51	9	438	G
51	9	448	A
51	9	449	A
51	9	450	C
51	9	459	C
51	9	460	A
51	9	462	C
51	9	464	A
51	9	465	A
51	9	466	G
51	9	472	C
51	9	473	A
51	9	474	G
51	9	476	A

*Continued on next page...*

*Continued from previous page...*

<b>Mol</b>	<b>Chain</b>	<b>Res</b>	<b>Type</b>
51	9	482	G
51	9	487	U
51	9	492	C
51	9	496	C
51	9	507	G
51	9	508	A
51	9	512	A
51	9	516	A
51	9	525	A
51	9	531	A
51	9	532	C
51	9	533	A
51	9	544	G
51	9	545	A
51	9	546	G
51	9	548	C
51	9	549	C
51	9	550	C
51	9	551	U
51	9	554	A
51	9	555	A
51	9	556	U
51	9	557	U
51	9	559	G
51	9	563	G
51	9	564	A
51	9	568	C
51	9	576	A
51	9	583	A
51	9	587	A
51	9	588	G
51	9	589	G
51	9	590	A
51	9	591	U
51	9	592	C
51	9	597	G
51	9	598	G
51	9	604	A
51	9	606	G
51	9	607	U
51	9	608	C
51	9	614	C

*Continued on next page...*

*Continued from previous page...*

<b>Mol</b>	<b>Chain</b>	<b>Res</b>	<b>Type</b>
51	9	620	G
51	9	629	A
51	9	631	U
51	9	637	U
51	9	643	A
51	9	644	G
51	9	655	A
51	9	659	G
51	9	660	C
51	9	663	C
51	9	664	A
51	9	668	A
51	9	669	A
51	9	670	A
51	9	671	A
51	9	672	A
51	9	684	G
51	9	688	U
51	9	689	U
51	9	732	U
51	9	733	C
51	9	752	G
51	9	753	C
51	9	754	G
51	9	810	A
51	9	811	A
51	9	812	A
51	9	821	G
51	9	822	U
51	9	830	A
51	9	834	C
51	9	847	A
51	9	861	A
51	9	868	G
51	9	869	A
51	9	870	A
51	9	871	U
51	9	872	A
51	9	873	G
51	9	874	G
51	9	875	A
51	9	877	C

*Continued on next page...*

*Continued from previous page...*

<b>Mol</b>	<b>Chain</b>	<b>Res</b>	<b>Type</b>
51	9	878	G
51	9	885	U
51	9	887	U
51	9	890	U
51	9	892	U
51	9	913	A
51	9	914	U
51	9	920	A
51	9	922	A
51	9	930	C
51	9	933	G
51	9	934	G
51	9	943	U
51	9	955	A
51	9	971	G
51	9	985	G
51	9	990	A
51	9	992	A
51	9	999	G
51	9	1002	U
51	9	1017	U
51	9	1023	A
51	9	1041	G
51	9	1045	U
51	9	1060	A
51	9	1061	U
51	9	1062	A
51	9	1078	C
51	9	1083	A
51	9	1085	C
51	9	1089	G
51	9	1096	G
51	9	1099	G
51	9	1100	A
51	9	1113	A
51	9	1114	U
51	9	1115	U
51	9	1116	C
51	9	1117	C
51	9	1118	C
51	9	1121	G
51	9	1131	G

*Continued on next page...*

*Continued from previous page...*

<b>Mol</b>	<b>Chain</b>	<b>Res</b>	<b>Type</b>
51	9	1133	A
51	9	1138	C
51	9	1139	C
51	9	1148	A
51	9	1149	A
51	9	1150	A
51	9	1153	C
51	9	1154	U
51	9	1165	G
51	9	1166	G
51	9	1195	A
51	9	1197	G
51	9	1207	G
51	9	1208	A
51	9	1211	G
51	9	1213	C
51	9	1215	C
51	9	1216	C
51	9	1221	G
51	9	1223	A
51	9	1224	G
51	9	1240	A
51	9	1242	U
51	9	1251	A
51	9	1253	A
51	9	1254	C
51	9	1256	G
51	9	1257	G
51	9	1259	A
51	9	1260	A
51	9	1265	A
51	9	1266	C
51	9	1270	G
51	9	1271	C
51	9	1274	G
51	9	1275	G
51	9	1281	G
51	9	1284	A
51	9	1285	G
51	9	1286	G
51	9	1287	A
51	9	1289	U

*Continued on next page...*

*Continued from previous page...*

<b>Mol</b>	<b>Chain</b>	<b>Res</b>	<b>Type</b>
51	9	1293	A
51	9	1298	G
51	9	1299	A
51	9	1300	U
51	9	1301	A
51	9	1302	G
51	9	1307	U
51	9	1308	U
51	9	1313	A
51	9	1314	U
51	9	1316	C
51	9	1330	G
51	9	1331	C
51	9	1342	U
51	9	1348	G
51	9	1354	G
51	9	1369	A
51	9	1371	U
51	9	1372	U
51	9	1378	A
51	9	1395	C
51	9	1396	A
51	9	1397	U
51	9	1401	A
51	9	1402	A
51	9	1404	U
51	9	1410	C
51	9	1412	C
51	9	1424	G
51	9	1428	G
51	9	1439	A
51	9	1449	G
51	9	1452	A
51	9	1454	A
51	9	1458	G
51	9	1459	G
51	9	1462	U
51	9	1463	U
51	9	1466	G
51	9	1473	G
51	9	1476	A
51	9	1477	U

*Continued on next page...*



*Continued from previous page...*

<b>Mol</b>	<b>Chain</b>	<b>Res</b>	<b>Type</b>
51	9	1478	U
51	9	1490	G
51	9	1494	U
51	9	1497	G
51	9	1498	A
51	9	1507	G
51	9	1509	U
51	9	1510	G
51	9	1519	U
51	9	1521	C
51	9	1522	A
51	9	1531	A
51	9	1533	A
51	9	1536	G
51	9	1544	C
51	9	1545	A
51	9	1548	G
51	9	1552	G
51	9	1553	C
51	9	1555	U
51	9	1556	A
51	9	1557	C
51	9	1560	U
51	9	1570	G
51	9	1574	C
51	9	1575	G
51	9	1580	A
51	9	1581	C
51	9	1582	C
51	9	1585	U
51	9	1586	U
51	9	1587	G
51	9	1588	A
51	9	1589	A
51	9	1600	G
51	9	1601	A
51	9	1602	U
51	9	1604	G
51	9	1621	U
51	9	1623	A
51	9	1625	U
51	9	1637	A

*Continued on next page...*

*Continued from previous page...*

<b>Mol</b>	<b>Chain</b>	<b>Res</b>	<b>Type</b>
51	9	1638	G
51	9	1639	G
51	9	1641	A
51	9	1647	A
51	9	1648	G
51	9	1654	G
51	9	1664	A
51	9	1665	G
51	9	1671	G
51	9	1680	G
51	9	1682	C
51	9	1683	C
51	9	1686	G
51	9	1689	C
51	9	1695	A
51	9	1698	C
51	9	1699	A
51	9	1700	C
51	9	1703	C
51	9	1715	A
51	9	1721	U
51	9	1722	G
51	9	1726	G
51	9	1728	U
51	9	1729	U
51	9	1730	U
51	9	1737	G
51	9	1745	A
51	9	1753	C
51	9	1758	G
51	9	1760	G
51	9	1772	C
51	9	1783	C
51	9	1785	C
51	9	1800	A
51	9	1823	A
51	9	1825	A
51	9	1826	G
51	9	1829	G
51	9	1831	A
51	9	1835	A
51	9	1836	G

*Continued on next page...*

*Continued from previous page...*

<b>Mol</b>	<b>Chain</b>	<b>Res</b>	<b>Type</b>
51	9	1838	U
51	9	1849	G
51	9	1851	A
51	9	1861	G
51	9	1862	G
51	9	1863	A
51	9	1865	C
51	9	1866	A
51	9	1867	U
51	9	1868	U
51	9	1869	A
85	hh	42	C
85	hh	43	A
85	hh	45	A
85	hh	46	G
85	hh	49	U
85	hh	52	G
85	hh	54	U
85	hh	55	C

All (250) RNA pucker outliers are listed below:

<b>Mol</b>	<b>Chain</b>	<b>Res</b>	<b>Type</b>
47	3	7	A
47	3	74	C
48	5	12	A
48	5	20	U
48	5	47	A
48	5	48	G
48	5	64	A
48	5	125	C
48	5	134	G
48	5	143	C
48	5	159	C
48	5	217	C
48	5	226	G
48	5	234	G
48	5	245	C
48	5	265	C
48	5	275	C
48	5	278	G
48	5	385	A

*Continued on next page...*

*Continued from previous page...*

<b>Mol</b>	<b>Chain</b>	<b>Res</b>	<b>Type</b>
48	5	387	G
48	5	406	C
48	5	408	A
48	5	409	G
48	5	417	G
48	5	449	C
48	5	480	C
48	5	481(A)	C
48	5	482	G
48	5	484	U
48	5	485	C
48	5	492	U
48	5	497	G
48	5	498	C
48	5	504	G
48	5	696	C
48	5	729	G
48	5	738(A)	C
48	5	747	A
48	5	748	G
48	5	915	A
48	5	916	C
48	5	922(B)	C
48	5	930	G
48	5	935(A)	G
48	5	936	C
48	5	955	G
48	5	956	A
48	5	959	G
48	5	965	G
48	5	966	A
48	5	969	C
48	5	971(A)	G
48	5	1071	C
48	5	1072	C
48	5	1211	G
48	5	1214	C
48	5	1236	C
48	5	1238	A
48	5	1287	G
48	5	1291	G
48	5	1294	A

*Continued on next page...*

*Continued from previous page...*

<b>Mol</b>	<b>Chain</b>	<b>Res</b>	<b>Type</b>
48	5	1295	U
48	5	1329	G
48	5	1358	G
48	5	1359	G
48	5	1370	G
48	5	1378	C
48	5	1380	G
48	5	1420	A
48	5	1440	U
48	5	1445	U
48	5	1455	G
48	5	1477	C
48	5	1481	C
48	5	1484	G
48	5	1485	C
48	5	1497	A
48	5	1563	A
48	5	1633	G
48	5	1678	C
48	5	1733	G
48	5	1734	G
48	5	1740	C
48	5	1804	A
48	5	1815	G
48	5	1818	G
48	5	1833	G
48	5	1834	U
48	5	1835	G
48	5	1836	G
48	5	1881	C
48	5	1892	A
48	5	1921	C
48	5	1935	C
48	5	1947	U
48	5	1979	A
48	5	1983	A
48	5	1986	U
48	5	2001	G
48	5	2003	G
48	5	2046	G
48	5	2068	C
48	5	2088	A

*Continued on next page...*

*Continued from previous page...*

<b>Mol</b>	<b>Chain</b>	<b>Res</b>	<b>Type</b>
48	5	2089	G
48	5	2100	G
48	5	2265	G
48	5	2266	C
48	5	2278	G
48	5	2313	A
48	5	2398	U
48	5	2428	A
48	5	2467	U
48	5	2468	U
48	5	2474	G
48	5	2475	G
48	5	2490	U
48	5	2502	A
48	5	2546	G
48	5	2587	A
48	5	2661	U
48	5	2695	A
48	5	2741	U
48	5	2754	G
48	5	2794	C
48	5	2806	A
48	5	3625	G
48	5	3673	C
48	5	3697	U
48	5	3710	G
48	5	3809	G
48	5	3876	A
48	5	3888	G
48	5	3904	G
48	5	4075	U
48	5	4076	G
48	5	4084	G
48	5	4116	C
48	5	4119	C
48	5	4121	G
48	5	4124	G
48	5	4162	C
48	5	4170	A
48	5	4221	C
48	5	4232	U
48	5	4254	G

*Continued on next page...*

*Continued from previous page...*

<b>Mol</b>	<b>Chain</b>	<b>Res</b>	<b>Type</b>
48	5	4257	A
48	5	4266	G
48	5	4331	G
48	5	4378	A
48	5	4379	A
48	5	4395	U
48	5	4448	G
48	5	4449	A
48	5	4510	A
48	5	4527	G
48	5	4572	U
48	5	4626	A
48	5	4699	U
48	5	4719	G
48	5	4753	U
48	5	4871	C
48	5	4872	G
48	5	4876	A
48	5	4884	G
48	5	4925	U
48	5	4936	G
48	5	4942	C
48	5	4947	U
48	5	4949	G
48	5	4965	U
48	5	4966	A
49	7	10	C
49	7	109	U
50	8	2	G
50	8	51	U
50	8	86	U
50	8	94	G
50	8	110	U
50	8	124	U
51	9	2	A
51	9	3	C
51	9	72	C
51	9	110	U
51	9	126	G
51	9	127	C
51	9	160	U
51	9	182	C

*Continued on next page...*

*Continued from previous page...*

<b>Mol</b>	<b>Chain</b>	<b>Res</b>	<b>Type</b>
51	9	293	C
51	9	308	G
51	9	369	C
51	9	370	G
51	9	434	G
51	9	448	A
51	9	465	A
51	9	473	A
51	9	487	U
51	9	500	A
51	9	532	C
51	9	550	C
51	9	553	U
51	9	555	A
51	9	563	G
51	9	591	U
51	9	606	G
51	9	620	G
51	9	642	U
51	9	656	G
51	9	670	A
51	9	688	U
51	9	752	G
51	9	821	G
51	9	869	A
51	9	870	A
51	9	872	A
51	9	874	G
51	9	1016	U
51	9	1114	U
51	9	1115	U
51	9	1120	U
51	9	1137	U
51	9	1165	G
51	9	1215	C
51	9	1253	A
51	9	1264	C
51	9	1284	A
51	9	1286	G
51	9	1313	A
51	9	1330	G
51	9	1394	G

*Continued on next page...*



*Continued from previous page...*

Mol	Chain	Res	Type
51	9	1395	C
51	9	1396	A
51	9	1476	A
51	9	1489	A
51	9	1493	C
51	9	1519	U
51	9	1520	G
51	9	1535	U
51	9	1585	U
51	9	1636	G
51	9	1637	A
51	9	1646	C
51	9	1664	A
51	9	1679	A
51	9	1721	U
51	9	1744	G
51	9	1824	A
51	9	1826	G
51	9	1835	A
51	9	1867	U
51	9	1868	U

#### 5.4 Non-standard residues in protein, DNA, RNA chains [i](#)

There are no non-standard protein/DNA/RNA residues in this entry.

#### 5.5 Carbohydrates [i](#)

There are no monosaccharides in this entry.

#### 5.6 Ligand geometry [i](#)

Of 291 ligands modelled in this entry, 290 are monoatomic - leaving 1 for Mogul analysis.

In the following table, the Counts columns list the number of bonds (or angles) for which Mogul statistics could be retrieved, the number of bonds (or angles) that are observed in the model and the number of bonds (or angles) that are defined in the Chemical Component Dictionary. The Link column lists molecule types, if any, to which the group is linked. The Z score for a bond length (or angle) is the number of standard deviations the observed value is removed from the expected value. A bond length (or angle) with  $|Z| > 2$  is considered an outlier worth inspection. RMSZ is the root-mean-square of all Z scores of the bond lengths (or angles).

Mol	Type	Chain	Res	Link	Bond lengths			Bond angles		
					Counts	RMSZ	# Z  > 2	Counts	RMSZ	# Z  > 2
90	GCP	jj	700	88	27,34,34	1.85	7 (25%)	34,54,54	1.96	8 (23%)

In the following table, the Chirals column lists the number of chiral outliers, the number of chiral centers analysed, the number of these observed in the model and the number defined in the Chemical Component Dictionary. Similar counts are reported in the Torsion and Rings columns. '-' means no outliers of that kind were identified.

Mol	Type	Chain	Res	Link	Chirals	Torsions	Rings
90	GCP	jj	700	88	-	6/15/38/38	0/3/3/3

All (7) bond length outliers are listed below:

Mol	Chain	Res	Type	Atoms	Z	Observed(Å)	Ideal(Å)
90	jj	700	GCP	PG-O1G	5.39	1.61	1.50
90	jj	700	GCP	C5-C6	4.50	1.49	1.41
90	jj	700	GCP	PG-O2G	2.91	1.61	1.54
90	jj	700	GCP	PG-O3G	-2.87	1.48	1.54
90	jj	700	GCP	C5-C4	2.49	1.47	1.40
90	jj	700	GCP	PB-O3A	2.19	1.60	1.58
90	jj	700	GCP	PB-O2B	2.03	1.61	1.56

All (8) bond angle outliers are listed below:

Mol	Chain	Res	Type	Atoms	Z	Observed(°)	Ideal(°)
90	jj	700	GCP	C2-N3-C4	5.22	121.32	115.36
90	jj	700	GCP	C4-C5-C6	-4.43	116.56	120.80
90	jj	700	GCP	PB-O3A-PA	-3.80	120.51	132.56
90	jj	700	GCP	C2-N1-C6	3.77	121.92	115.93
90	jj	700	GCP	N3-C2-N1	-3.57	122.47	127.22
90	jj	700	GCP	C5-C6-N1	-3.32	118.89	123.43
90	jj	700	GCP	C4-C5-N7	-2.61	106.68	109.40
90	jj	700	GCP	C3'-C2'-C1'	2.53	104.79	100.98

There are no chirality outliers.

All (6) torsion outliers are listed below:

Mol	Chain	Res	Type	Atoms
90	jj	700	GCP	PG-C3B-PB-O1B
90	jj	700	GCP	PG-C3B-PB-O2B
90	jj	700	GCP	PG-C3B-PB-O3A
90	jj	700	GCP	C5'-O5'-PA-O3A

*Continued on next page...*

Continued from previous page...

Mol	Chain	Res	Type	Atoms
90	jj	700	GCP	C5'-O5'-PA-O1A
90	jj	700	GCP	O4'-C4'-C5'-O5'

There are no ring outliers.

No monomer is involved in short contacts.

The following is a two-dimensional graphical depiction of Mogul quality analysis of bond lengths, bond angles, torsion angles, and ring geometry for all instances of the Ligand of Interest. In addition, ligands with molecular weight > 250 and outliers as shown on the validation Tables will also be included. For torsion angles, if less than 5% of the Mogul distribution of torsion angles is within 10 degrees of the torsion angle in question, then that torsion angle is considered an outlier. Any bond that is central to one or more torsion angles identified as an outlier by Mogul will be highlighted in the graph. For rings, the root-mean-square deviation (RMSD) between the ring in question and similar rings identified by Mogul is calculated over all ring torsion angles. If the average RMSD is greater than 60 degrees and the minimal RMSD between the ring in question and any Mogul-identified rings is also greater than 60 degrees, then that ring is considered an outlier. The outliers are highlighted in purple. The color gray indicates Mogul did not find sufficient equivalents in the CSD to analyse the geometry.

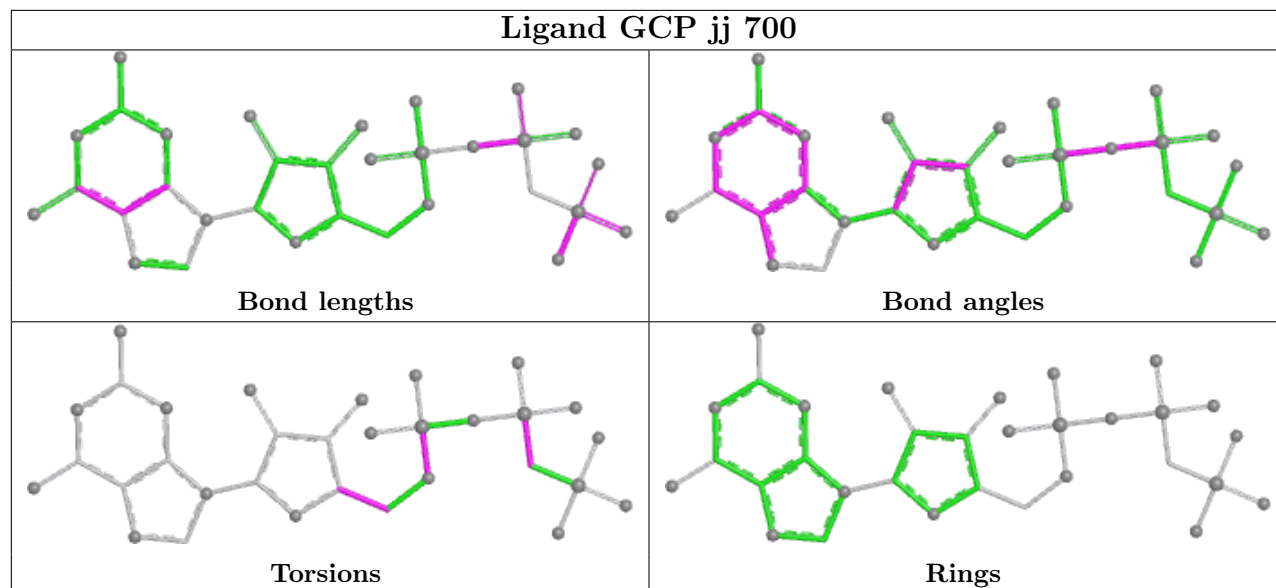

## 5.7 Other polymers [\(i\)](#)

There are no such residues in this entry.

## 5.8 Polymer linkage issues [\(i\)](#)

The following chains have linkage breaks:

Mol	Chain	Number of breaks
48	5	30
51	9	7
47	3	2
46	2	1

All chain breaks are listed below:

Model	Chain	Residue-1	Atom-1	Residue-2	Atom-2	Distance (Å)
1	5	2113:G	O3'	2258:C	P	41.06
1	5	1252:C	O3'	1271:G	P	35.64
1	5	1219:G	O3'	1233:G	P	22.79
1	5	3948:C	O3'	4065:G	P	19.75
1	5	1406(C):G	O3'	1411:C	P	18.65
1	5	990:C	O3'	1064:G	P	18.31
1	5	523:C	O3'	638:G	P	18.02
1	5	4138:C	O3'	4146:G	P	18.00
1	5	4101:C	O3'	4107:G	P	17.52
1	5	4777:C	O3'	4859:C	P	16.78
1	5	760:G	O3'	904:C	P	15.07
1	5	1696:C	O3'	1720:C	P	14.63
1	5	5022:U	O3'	5028:G	P	14.63
1	5	182:G	O3'	189:G	P	14.05
1	5	1364:U	O3'	1368:A	P	13.97
1	5	2901:G	O3'	3597:G	P	13.29
1	5	512:U	O3'	515:C	P	9.99
1	5	4729:A	O3'	4735:G	P	9.79
1	5	1180:C	O3'	1183:C	P	9.09
1	5	500:G	O3'	504:G	P	6.73
1	5	1100:U	O3'	1168:G	P	5.98
1	3	19:G	O3'	20:U	P	5.77
1	5	1239:C	O3'	1244:G	P	5.36
1	9	322:C	O3'	323:C	P	5.19
1	5	4740:G	O3'	4743:G	P	4.87
1	3	16:C	O3'	18:U	P	4.79
1	2	16:C	O3'	18:G	P	4.35
1	9	309:G	O3'	310:C	P	4.34
1	9	798:G	O3'	799:U	P	4.27
1	9	304:C	O3'	305:U	P	4.18
1	5	170:C	O3'	171:U	P	3.77
1	9	902:G	O3'	903:A	P	3.43
1	5	1438:U	O3'	1440:U	P	3.34
1	9	903:A	O3'	904:A	P	3.33
1	5	4899:G	O3'	4902:C	P	3.32
1	9	1295:A	O3'	1296:U	P	3.24

*Continued on next page...*

*Continued from previous page...*

Model	Chain	Residue-1	Atom-1	Residue-2	Atom-2	Distance (Å)
1	5	5020:G	O3'	5021:C	P	3.16
1	5	267:G	O3'	268:G	P	3.15
1	5	751:G	O3'	752:G	P	3.15
1	5	2031:C	O3'	2032:U	P	2.55

## 6 Map visualisation [i](#)

This section contains visualisations of the EMDB entry EMD-4131. These allow visual inspection of the internal detail of the map and identification of artifacts.

Images derived from a raw map, generated by summing the deposited half-maps, are presented below the corresponding image components of the primary map to allow further visual inspection and comparison with those of the primary map.

### 6.1 Orthogonal projections [i](#)

#### 6.1.1 Primary map

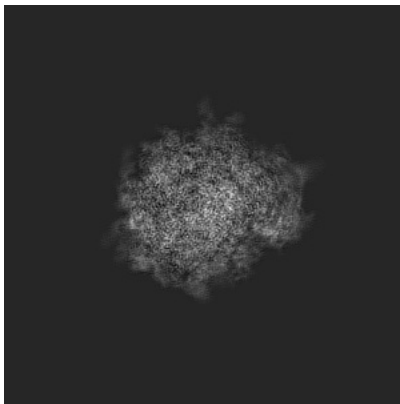

X

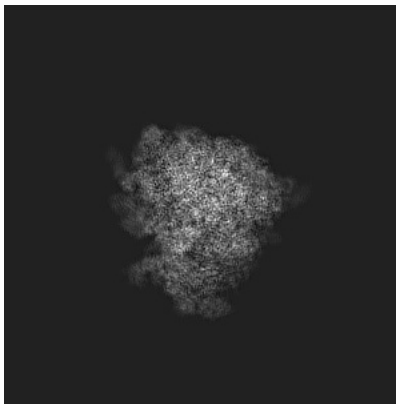

Y

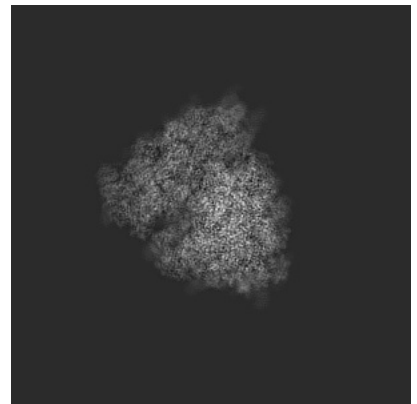

Z

#### 6.1.2 Raw map

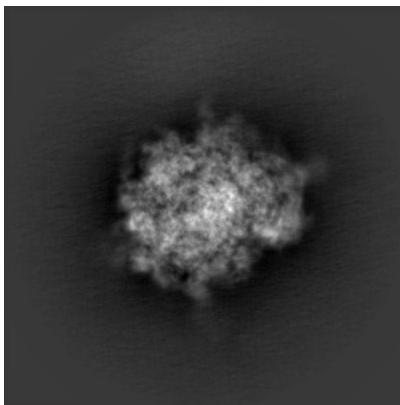

X

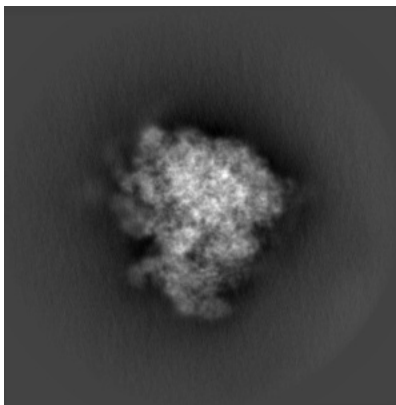

Y

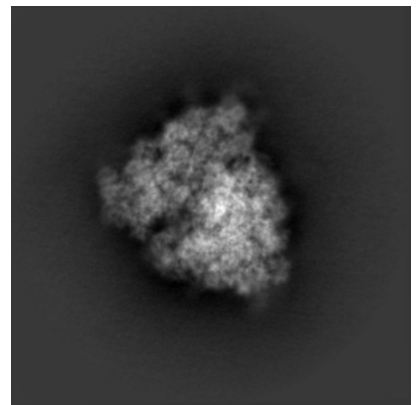

Z

The images above show the map projected in three orthogonal directions.

## 6.2 Central slices [i](#)

### 6.2.1 Primary map

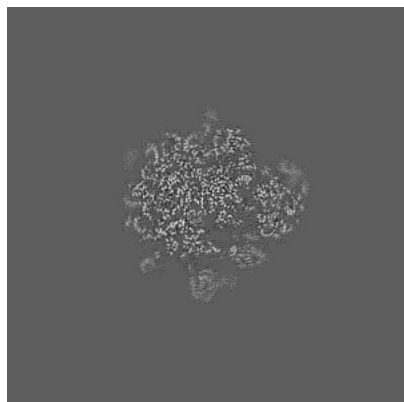

X Index: 210

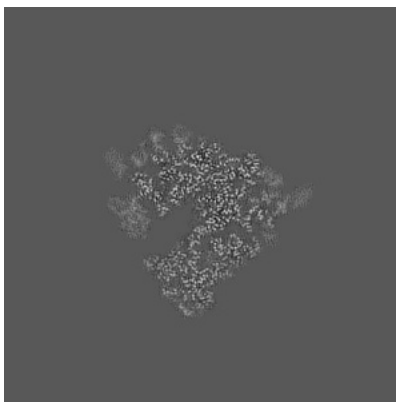

Y Index: 210

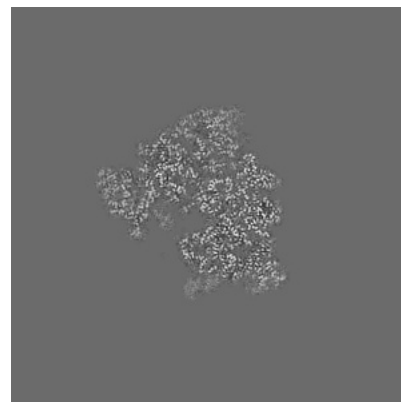

Z Index: 210

### 6.2.2 Raw map

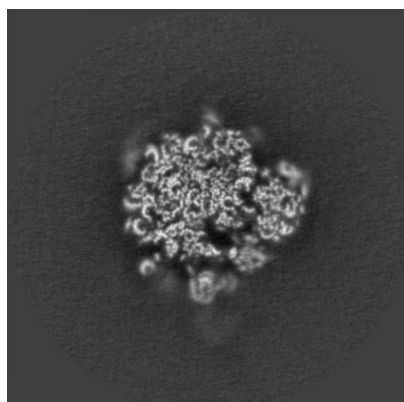

X Index: 210

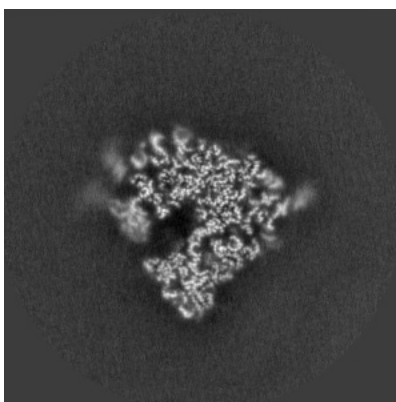

Y Index: 210

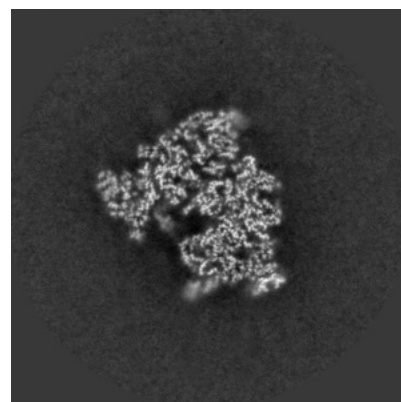

Z Index: 210

The images above show central slices of the map in three orthogonal directions.

## 6.3 Largest variance slices [i](#)

### 6.3.1 Primary map

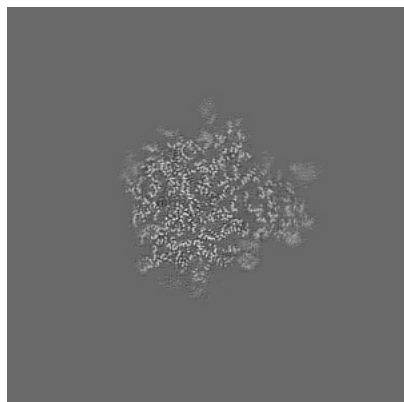

X Index: 222

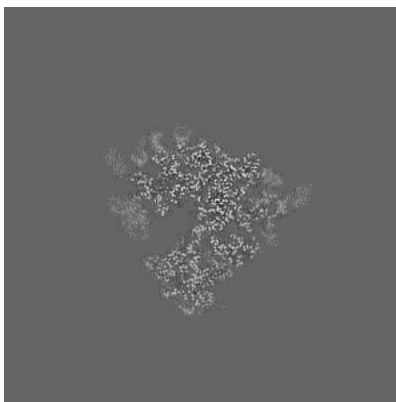

Y Index: 211

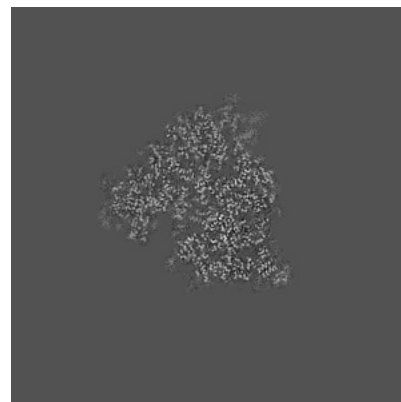

Z Index: 202

### 6.3.2 Raw map

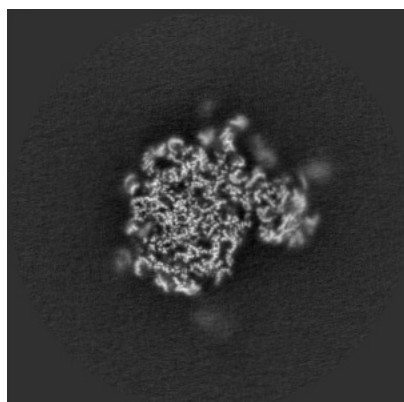

X Index: 233

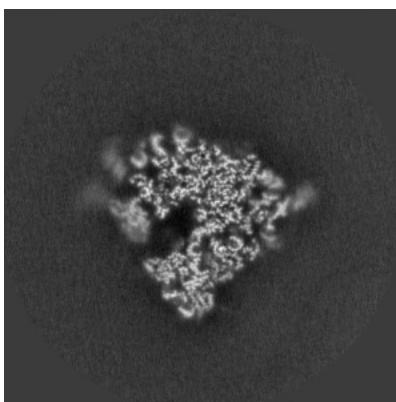

Y Index: 211

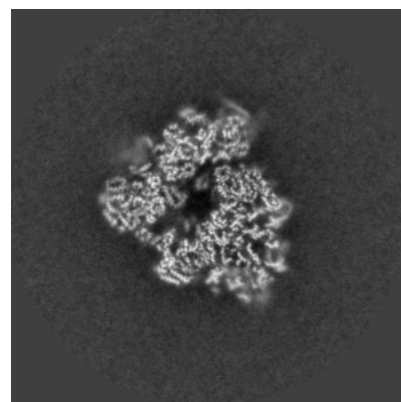

Z Index: 186

The images above show the largest variance slices of the map in three orthogonal directions.



## 6.4 Orthogonal surface views [i](#)

### 6.4.1 Primary map

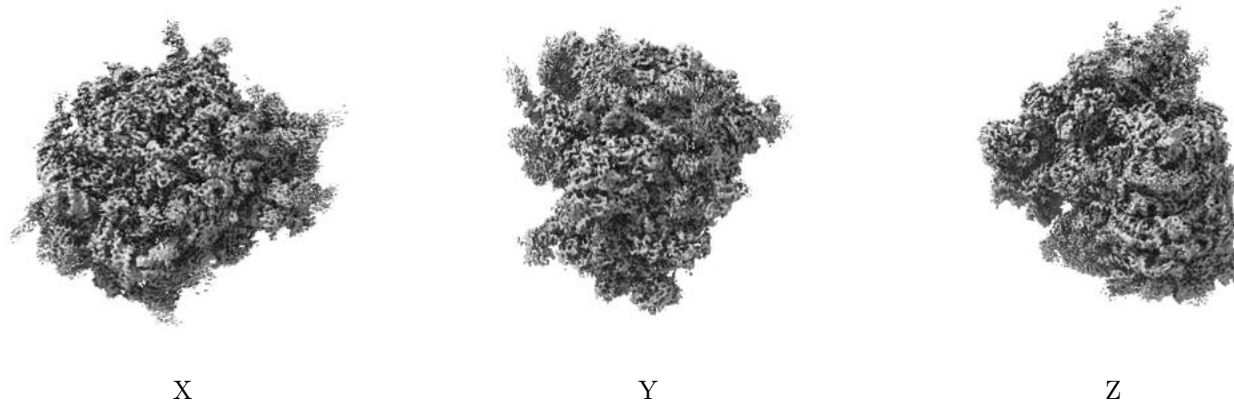

The images above show the 3D surface view of the map at the recommended contour level 0.1. These images, in conjunction with the slice images, may facilitate assessment of whether an appropriate contour level has been provided.

### 6.4.2 Raw map



These images show the 3D surface of the raw map. The raw map's contour level was selected so that its surface encloses the same volume as the primary map does at its recommended contour level.

## 6.5 Mask visualisation [i](#)

This section was not generated. No masks/segmentation were deposited.

## 7 Map analysis [i](#)

This section contains the results of statistical analysis of the map.

### 7.1 Map-value distribution [i](#)

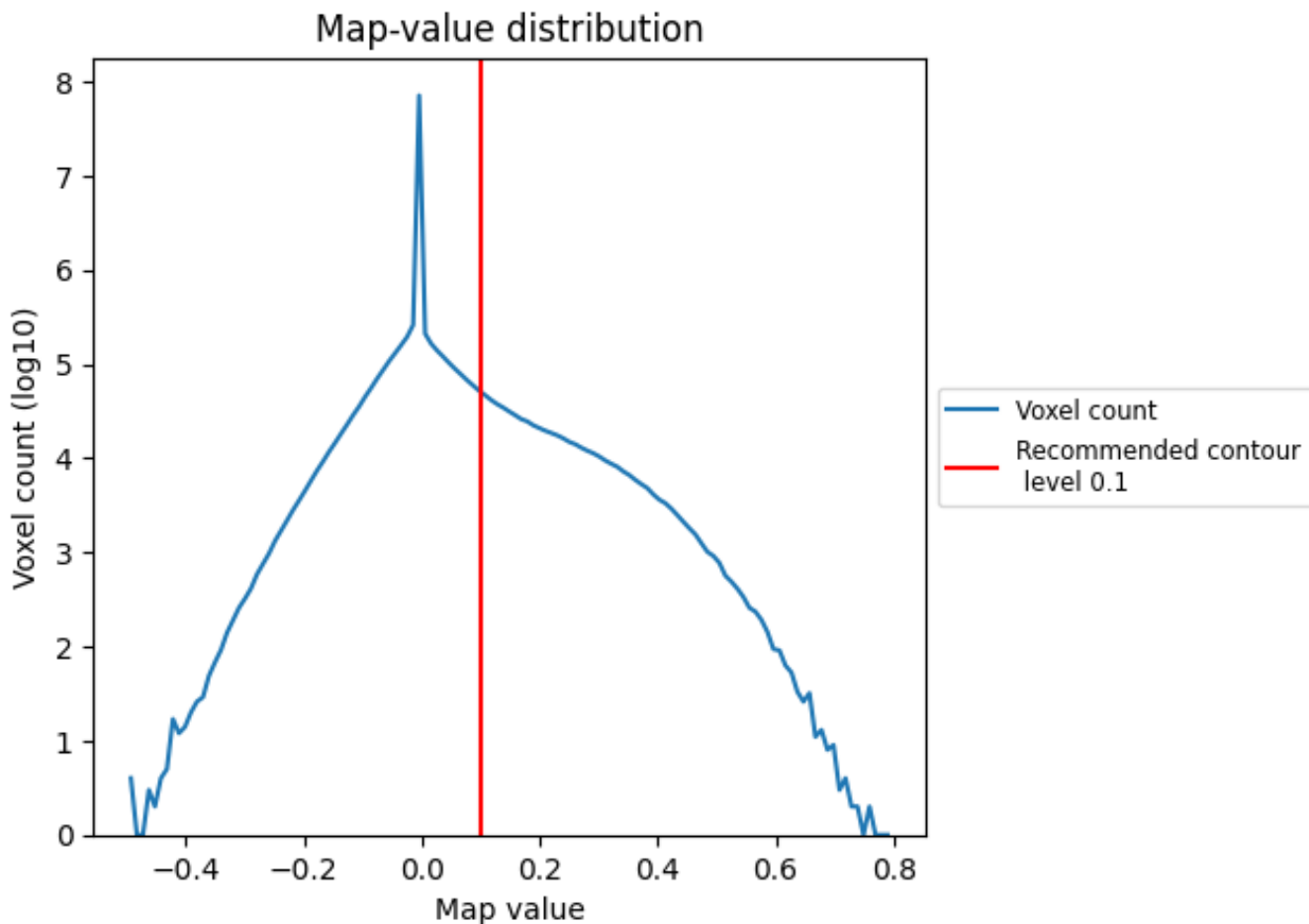

The map-value distribution is plotted in 128 intervals along the x-axis. The y-axis is logarithmic. A spike in this graph at zero usually indicates that the volume has been masked.

## 7.2 Volume estimate [\(i\)](#)

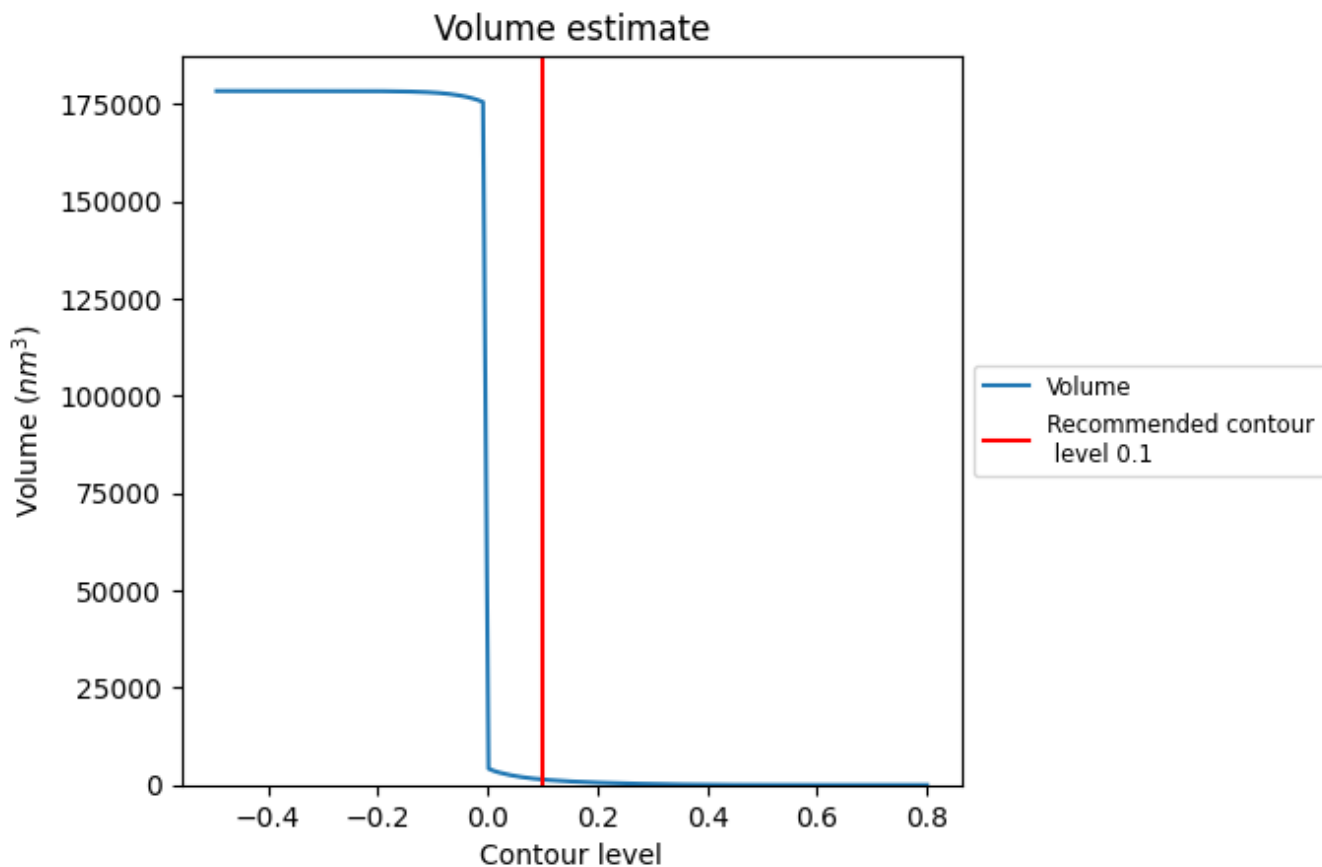

The volume at the recommended contour level is 1409  $\text{nm}^3$ ; this corresponds to an approximate mass of 1273 kDa.

The volume estimate graph shows how the enclosed volume varies with the contour level. The recommended contour level is shown as a vertical line and the intersection between the line and the curve gives the volume of the enclosed surface at the given level.

### 7.3 Rotationally averaged power spectrum i

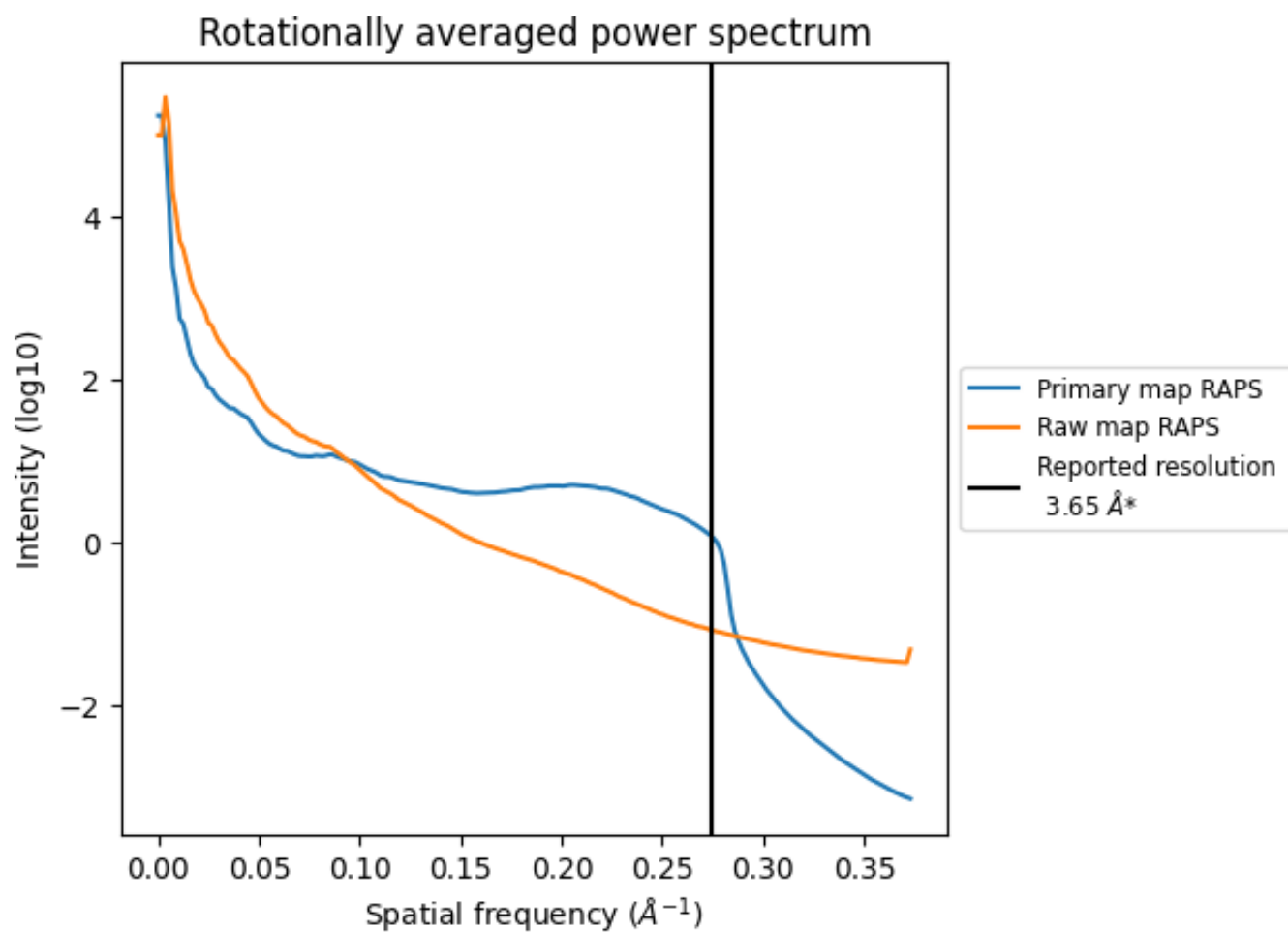

\*Reported resolution corresponds to spatial frequency of 0.274 Å<sup>-1</sup>

## 8 Fourier-Shell correlation [i](#)

Fourier-Shell Correlation (FSC) is the most commonly used method to estimate the resolution of single-particle and subtomogram-averaged maps. The shape of the curve depends on the imposed symmetry, mask and whether or not the two 3D reconstructions used were processed from a common reference. The reported resolution is shown as a black line. A curve is displayed for the half-bit criterion in addition to lines showing the 0.143 gold standard cut-off and 0.5 cut-off.

### 8.1 FSC [i](#)

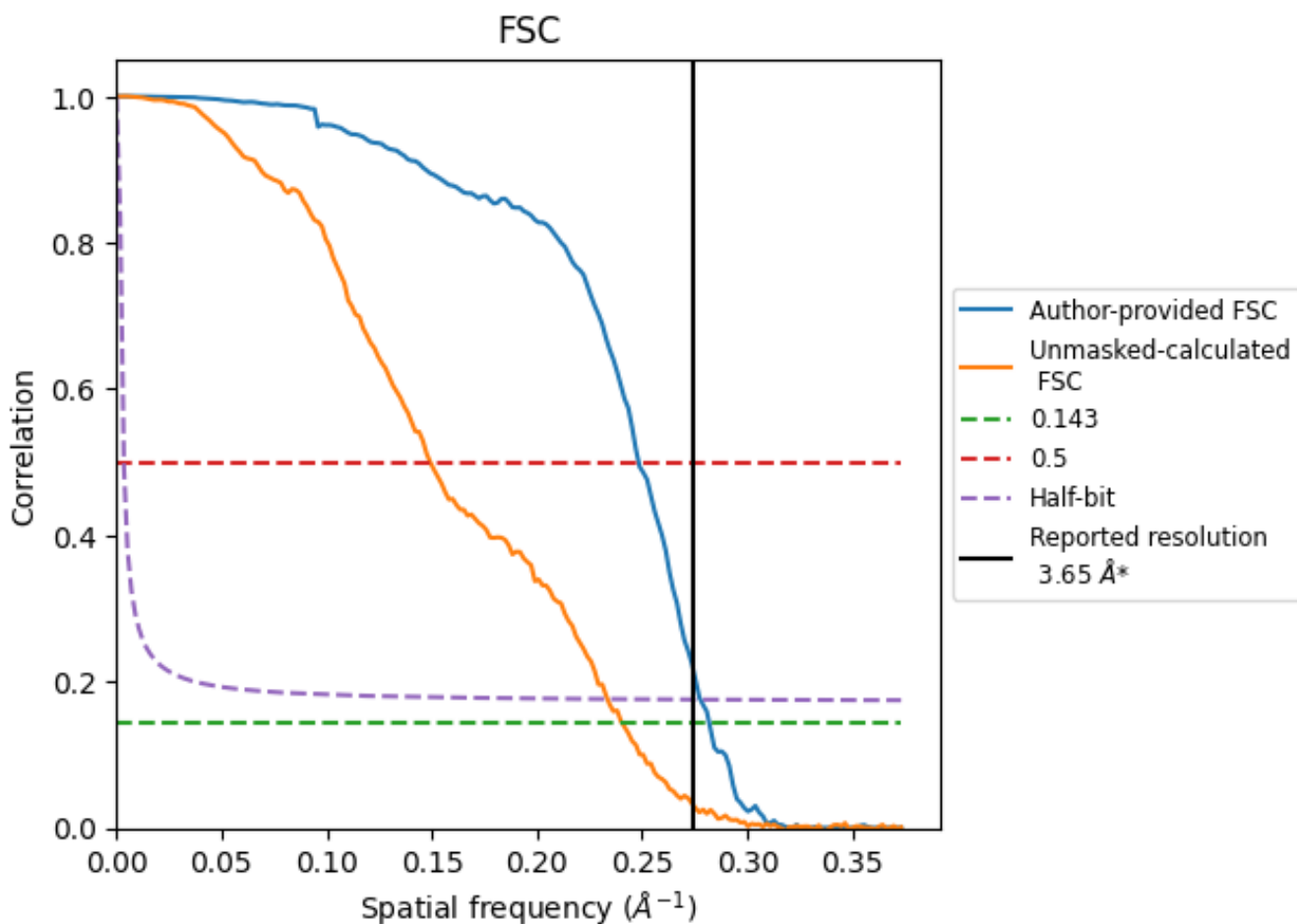

\*Reported resolution corresponds to spatial frequency of 0.274 Å<sup>-1</sup>

## 8.2 Resolution estimates [i](#)

Resolution estimate (Å)	Estimation criterion (FSC cut-off)		
	0.143	0.5	Half-bit
Reported by author	3.65	-	-
Author-provided FSC curve	3.55	4.03	3.60
Unmasked-calculated*	4.16	6.71	4.28

\*Resolution estimate based on FSC curve calculated by comparison of deposited half-maps. The value from deposited half-maps intersecting FSC 0.143 CUT-OFF 4.16 differs from the reported value 3.65 by more than 10 %

## 9 Map-model fit [i](#)

This section contains information regarding the fit between EMDB map EMD-4131 and PDB model 5LZT. Per-residue inclusion information can be found in section 3 on page 24.

### 9.1 Map-model overlay [i](#)

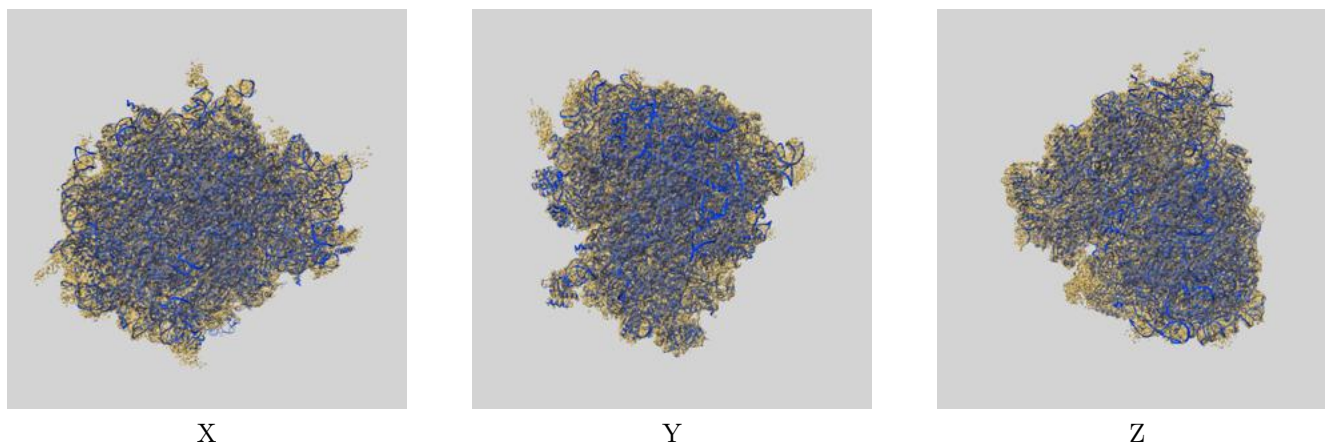

The images above show the 3D surface view of the map at the recommended contour level 0.1 at 50% transparency in yellow overlaid with a ribbon representation of the model coloured in blue. These images allow for the visual assessment of the quality of fit between the atomic model and the map.

## 9.2 Q-score mapped to coordinate model [i](#)

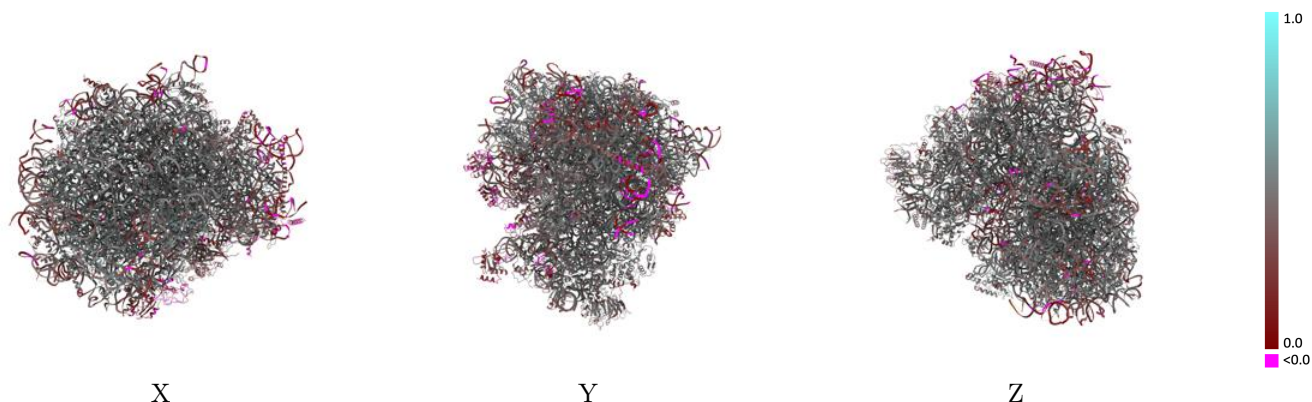

The images above show the model with each residue coloured according to its Q-score. This shows their resolvability in the map with higher Q-score values reflecting better resolvability. Please note: Q-score is calculating the resolvability of atoms, and thus high values are only expected at resolutions at which atoms can be resolved. Low Q-score values may therefore be expected for many entries.

## 9.3 Atom inclusion mapped to coordinate model [i](#)

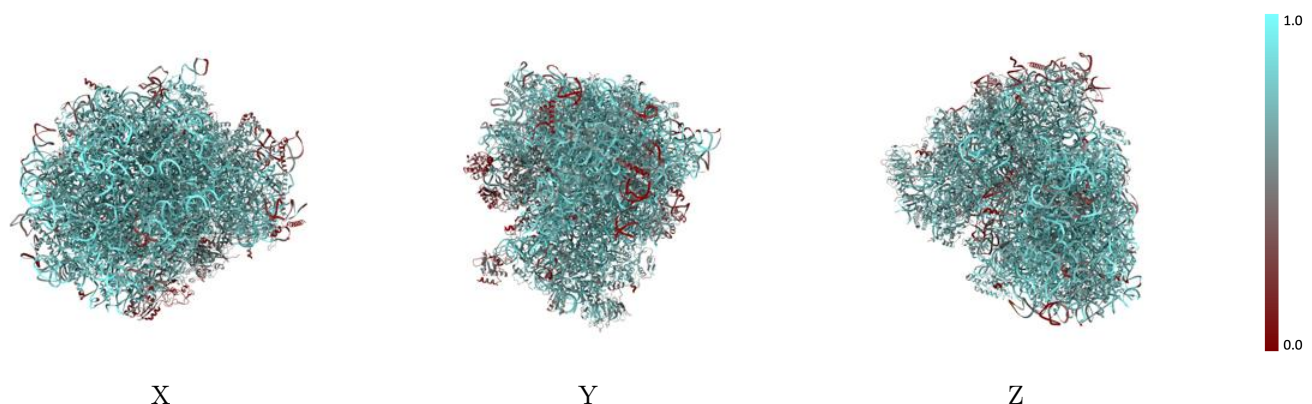

The images above show the model with each residue coloured according to its atom inclusion. This shows to what extent they are inside the map at the recommended contour level (0.1).





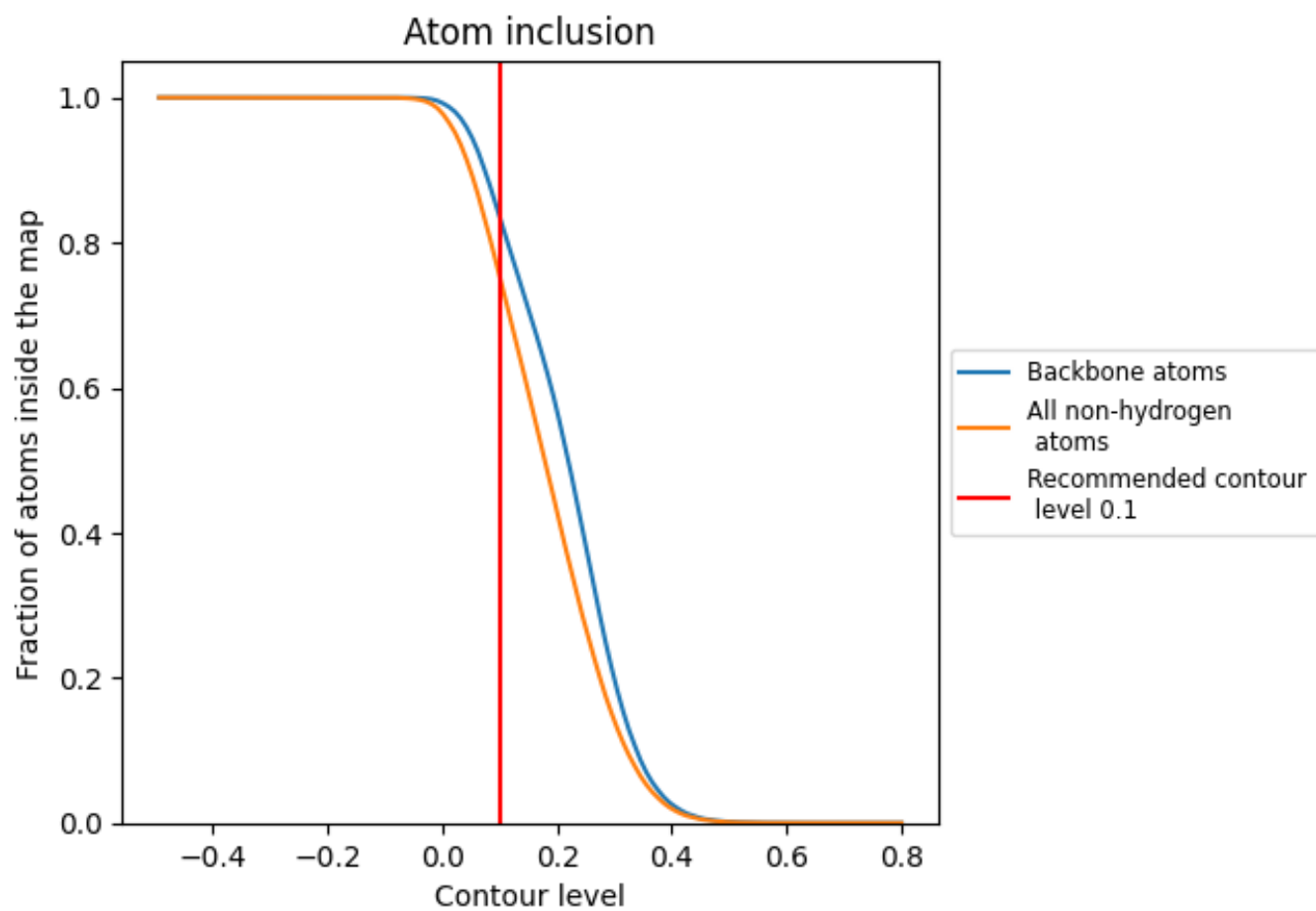



































































## 9.4 Atom inclusion [i](#)



At the recommended contour level, 84% of all backbone atoms, 75% of all non-hydrogen atoms, are inside the map.

## 9.5 Map-model fit summary





















































































The table lists the average atom inclusion at the recommended contour level (0.1) and Q-score for the entire model and for each chain.

Chain	Atom inclusion	Q-score
All	 0.7535	 0.4340
1	 0.5868	 0.4450
2	 0.8007	 0.4240
3	 0.3867	 0.2490
5	 0.8254	 0.4360
7	 0.8970	 0.4710
8	 0.8439	 0.4440
9	 0.8024	 0.4180
A	 0.7745	 0.5010
AA	 0.6794	 0.4470
B	 0.7743	 0.4950
BB	 0.6939	 0.4600
C	 0.7683	 0.4960
CC	 0.7049	 0.4700
D	 0.7589	 0.4590
DD	 0.6267	 0.4280
E	 0.7784	 0.4740
EE	 0.7002	 0.4420
F	 0.7800	 0.4950
FF	 0.6899	 0.4530
G	 0.6597	 0.4150
GG	 0.5671	 0.3460
H	 0.7341	 0.4830
HH	 0.5441	 0.3770
I	 0.7350	 0.4830
II	 0.6718	 0.4350
J	 0.7207	 0.4550
JJ	 0.7222	 0.4450
KK	 0.6899	 0.4260
L	 0.7307	 0.4700
LL	 0.7132	 0.4710
M	 0.7753	 0.4910
MM	 0.2953	 0.1990
N	 0.7895	 0.5040
NN	 0.7084	 0.4680

























*Continued on next page...*

*Continued from previous page...*

Chain	Atom inclusion	Q-score
O	 0.7685	 0.4900
OO	 0.7264	 0.4750
P	 0.7891	 0.5070
PP	 0.6528	 0.4130
Q	 0.7553	 0.4990
QQ	 0.7161	 0.4610
R	 0.7044	 0.4490
RR	 0.6166	 0.4240
S	 0.7997	 0.5060
SS	 0.7118	 0.4390
T	 0.7411	 0.4810
TT	 0.7170	 0.4410
U	 0.6713	 0.4040
UU	 0.6266	 0.4200
V	 0.7255	 0.4940
VV	 0.7106	 0.4640
W	 0.4898	 0.3390
WW	 0.7277	 0.4950
X	 0.7181	 0.4680
XX	 0.7106	 0.4900
Y	 0.7430	 0.4720
YY	 0.6442	 0.4110
Z	 0.7614	 0.4560
ZZ	 0.6552	 0.4160
a	 0.7874	 0.4970
aa	 0.7238	 0.4650
b	 0.6466	 0.4110
bb	 0.6588	 0.4280
c	 0.7137	 0.4630
cc	 0.6319	 0.4530
d	 0.7363	 0.4790
dd	 0.7376	 0.4740
e	 0.7640	 0.4960
ee	 0.6385	 0.4120
f	 0.8040	 0.5170
ff	 0.3604	 0.2610
g	 0.7061	 0.4670
gg	 0.6077	 0.3930
h	 0.7171	 0.4600
hh	 0.7138	 0.3910
i	 0.7123	 0.4560
ii	 0.4616	 0.3240

*Continued on next page...*

*Continued from previous page...*

Chain	Atom inclusion	Q-score
j	 0.7878	 0.4990
jj	 0.5024	 0.3280
k	 0.6661	 0.4320
l	 0.7260	 0.4840
m	 0.7620	 0.4750
n	 0.6651	 0.4660
o	 0.7409	 0.4870
p	 0.7504	 0.4860
r	 0.8119	 0.5060
s	 0.2034	 0.1760
t	 0.1485	 0.1400