



# wwPDB X-ray Structure Validation Summary Report ⓘ

Sep 12, 2023 – 04:00 AM EDT

PDB ID : 4LUS  
Title : alanine racemase [Clostridium difficile 630]  
Authors : Asojo, O.A.  
Deposited on : 2013-07-25  
Resolution : 2.10 Å(reported)

This is a wwPDB X-ray Structure Validation Summary Report for a publicly released PDB entry.

We welcome your comments at [validation@mail.wwpdb.org](mailto:validation@mail.wwpdb.org)

A user guide is available at

<https://www.wwpdb.org/validation/2017/XrayValidationReportHelp>

with specific help available everywhere you see the ⓘ symbol.

The types of validation reports are described at

<http://www.wwpdb.org/validation/2017/FAQs#types>.

---

The following versions of software and data (see [references ⓘ](#)) were used in the production of this report:

MolProbity : 4.02b-467  
Mogul : 1.8.5 (274361), CSD as541be (2020)  
Xtriage (Phenix) : 1.13  
EDS : 2.35.1  
buster-report : 1.1.7 (2018)  
Percentile statistics : 20191225.v01 (using entries in the PDB archive December 25th 2019)  
Refmac : 5.8.0158  
CCP4 : 7.0.044 (Gargrove)  
Ideal geometry (proteins) : Engh & Huber (2001)  
Ideal geometry (DNA, RNA) : Parkinson et al. (1996)  
Validation Pipeline (wwPDB-VP) : 2.35.1

# 1 Overall quality at a glance

The following experimental techniques were used to determine the structure:

*X-RAY DIFFRACTION*

The reported resolution of this entry is 2.10 Å.

Percentile scores (ranging between 0-100) for global validation metrics of the entry are shown in the following graphic. The table shows the number of entries on which the scores are based.

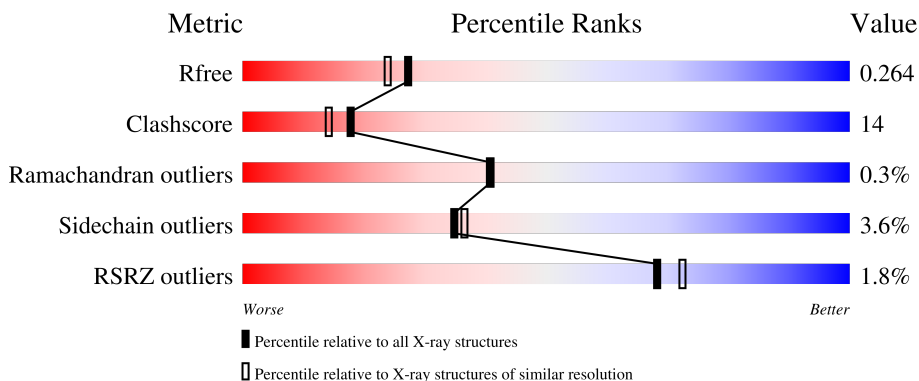

Metric	Whole archive (#Entries)	Similar resolution (#Entries, resolution range(Å))
$R_{free}$	130704	5197 (2.10-2.10)
Clashscore	141614	5710 (2.10-2.10)
Ramachandran outliers	138981	5647 (2.10-2.10)
Sidechain outliers	138945	5648 (2.10-2.10)
RSRZ outliers	127900	5083 (2.10-2.10)

The table below summarises the geometric issues observed across the polymeric chains and their fit to the electron density. The red, orange, yellow and green segments of the lower bar indicate the fraction of residues that contain outliers for  $\geq 3$ , 2, 1 and 0 types of geometric quality criteria respectively. A grey segment represents the fraction of residues that are not modelled. The numeric value for each fraction is indicated below the corresponding segment, with a dot representing fractions  $\leq 5\%$ . The upper red bar (where present) indicates the fraction of residues that have poor fit to the electron density. The numeric value is given above the bar.

Mol	Chain	Length	Quality of chain
1	A	385	 76% 16% • 6%
1	C	385	 66% 28% • •
1	D	385	 73% 24% • •
2	B	385	 73% 22% • •

The following table lists non-polymeric compounds, carbohydrate monomers and non-standard

residues in protein, DNA, RNA chains that are outliers for geometric or electron-density-fit criteria:

Mol	Type	Chain	Res	Chirality	Geometry	Clashes	Electron density
3	GOL	A	401	-	-	X	-

## 2 Entry composition [i](#)

There are 5 unique types of molecules in this entry. The entry contains 12484 atoms, of which 0 are hydrogens and 0 are deuteriums.

In the tables below, the ZeroOcc column contains the number of atoms modelled with zero occupancy, the AltConf column contains the number of residues with at least one atom in alternate conformation and the Trace column contains the number of residues modelled with at most 2 atoms.

- Molecule 1 is a protein called Alanine racemase.

Mol	Chain	Residues	Atoms						ZeroOcc	AltConf	Trace
			Total	C	N	O	P	S			
1	A	362	Total 2880	C 1828	N 481	O 554	P 1	S 16	0	0	0
1	C	382	Total 3029	C 1923	N 504	O 585	P 1	S 16	0	0	0
1	D	380	Total 3013	C 1912	N 501	O 583	P 1	S 16	0	0	0

- Molecule 2 is a protein called Alanine racemase.

Mol	Chain	Residues	Atoms						ZeroOcc	AltConf	Trace
			Total	C	N	O	P	S			
2	B	374	Total 2972	C 1888	N 493	O 575	P 1	S 15	0	1	0

- Molecule 3 is GLYCEROL (three-letter code: GOL) (formula:  $C_3H_8O_3$ ).

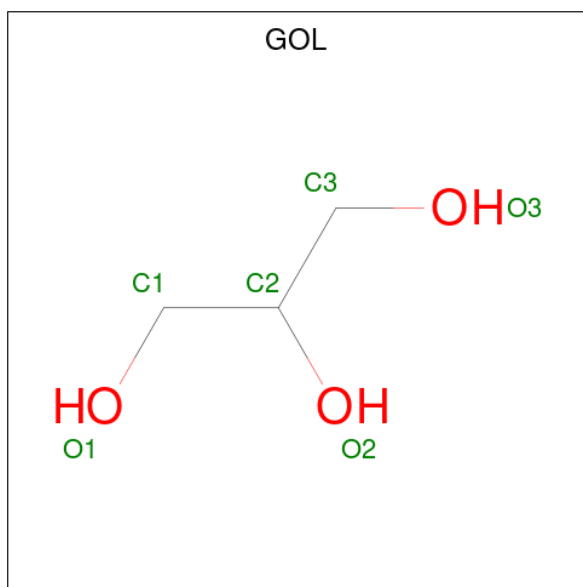

Mol	Chain	Residues	Atoms			ZeroOcc	AltConf
3	A	1	Total	C	O	0	0
			6	3	3		

- Molecule 4 is 3,3',3''-phosphanetriyltripropanoic acid (three-letter code: TCE) (formula:  $C_9H_{15}O_6P$ ).

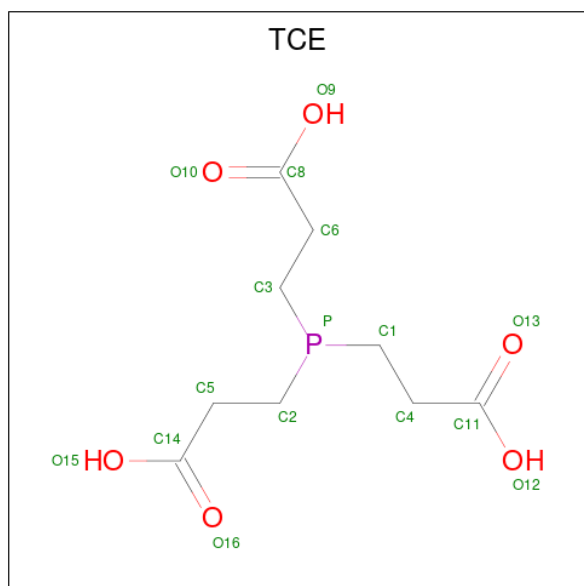

Mol	Chain	Residues	Atoms				ZeroOcc	AltConf
4	B	1	Total	C	O	P	0	0
			16	9	6	1		

- Molecule 5 is water.

Mol	Chain	Residues	Atoms		ZeroOcc	AltConf
5	A	186	Total	O	0	0
			186	186		
5	B	150	Total	O	0	0
			150	150		
5	C	125	Total	O	0	0
			125	125		
5	D	107	Total	O	0	0
			107	107		

### 3 Residue-property plots [i](#)

These plots are drawn for all protein, RNA, DNA and oligosaccharide chains in the entry. The first graphic for a chain summarises the proportions of the various outlier classes displayed in the second graphic. The second graphic shows the sequence view annotated by issues in geometry and electron density. Residues are color-coded according to the number of geometric quality criteria for which they contain at least one outlier: green = 0, yellow = 1, orange = 2 and red = 3 or more. A red dot above a residue indicates a poor fit to the electron density ( $RSRZ > 2$ ). Stretches of 2 or more consecutive residues without any outlier are shown as a green connector. Residues present in the sample, but not in the model, are shown in grey.

- Molecule 1: Alanine racemase

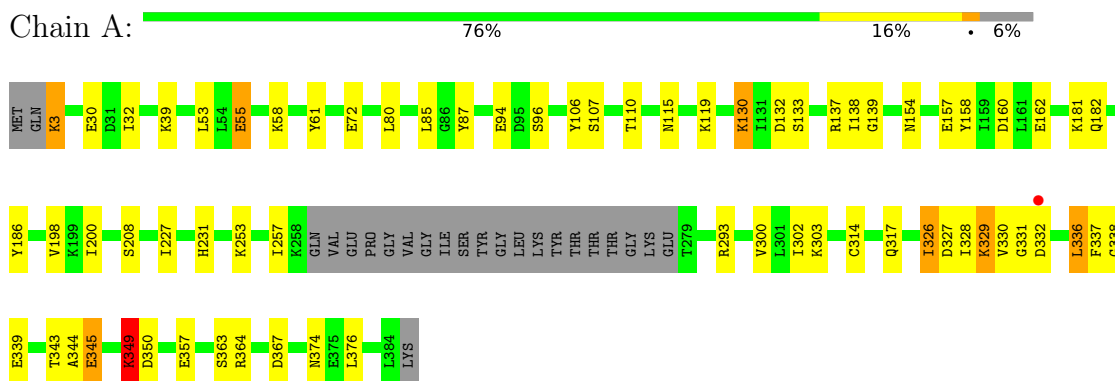

- Molecule 1: Alanine racemase

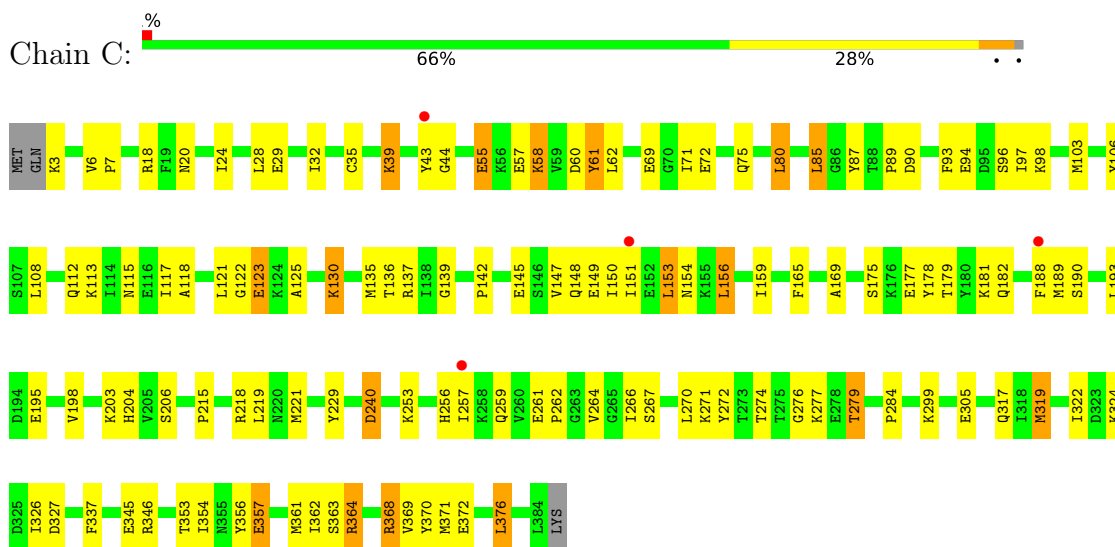

- Molecule 1: Alanine racemase

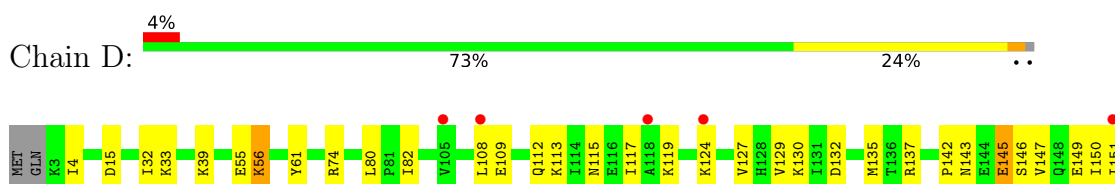

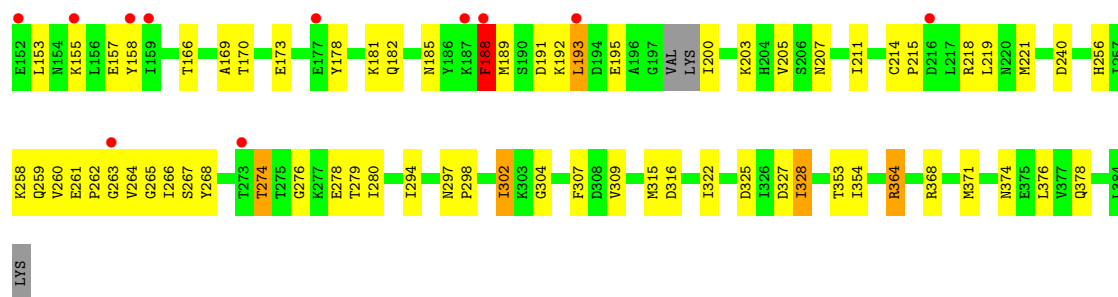

- Molecule 2: Alanine racemase

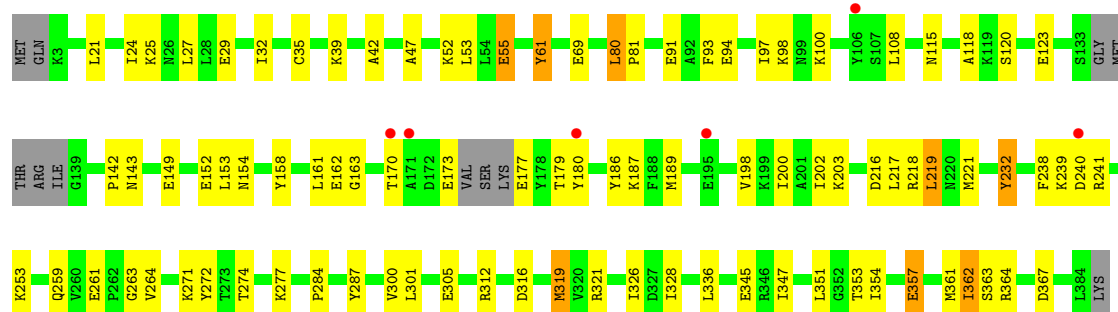
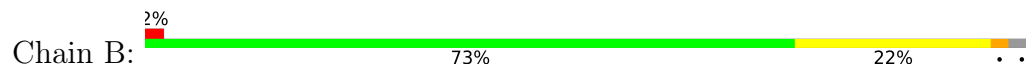

## 4 Data and refinement statistics

Property	Value	Source
Space group	P 1 21 1	Depositor
Cell constants a, b, c, $\alpha$ , $\beta$ , $\gamma$	85.15Å 93.30Å 107.09Å 90.00° 91.00° 90.00°	Depositor
Resolution (Å)	54.54 – 2.10 54.54 – 2.10	Depositor EDS
% Data completeness (in resolution range)	95.1 (54.54-2.10) 95.1 (54.54-2.10)	Depositor EDS
$R_{merge}$	0.06	Depositor
$R_{sym}$	(Not available)	Depositor
$\langle I/\sigma(I) \rangle$ <sup>1</sup>	12.41 (at 2.10Å)	Xtrriage
Refinement program	REFMAC 5.7.0032	Depositor
R, $R_{free}$	0.202 , 0.266 0.215 , 0.264	Depositor DCC
$R_{free}$ test set	4555 reflections (4.90%)	wwPDB-VP
Wilson B-factor (Å <sup>2</sup> )	34.9	Xtrriage
Anisotropy	0.018	Xtrriage
Bulk solvent $k_{sol}$ (e/Å <sup>3</sup> ), $B_{sol}$ (Å <sup>2</sup> )	0.33 , 48.1	EDS
L-test for twinning <sup>2</sup>	$\langle  L  \rangle = 0.51$ , $\langle L^2 \rangle = 0.35$	Xtrriage
Estimated twinning fraction	0.013 for h,-k,-l	Xtrriage
$F_o, F_c$ correlation	0.94	EDS
Total number of atoms	12484	wwPDB-VP
Average B, all atoms (Å <sup>2</sup> )	39.0	wwPDB-VP

Xtrriage's analysis on translational NCS is as follows: *The largest off-origin peak in the Patterson function is 3.67% of the height of the origin peak. No significant pseudotranslation is detected.*

<sup>1</sup>Intensities estimated from amplitudes.

<sup>2</sup>Theoretical values of  $\langle |L| \rangle$ ,  $\langle L^2 \rangle$  for acentric reflections are 0.5, 0.333 respectively for untwinned datasets, and 0.375, 0.2 for perfectly twinned datasets.



## 5 Model quality [i](#)

### 5.1 Standard geometry [i](#)

Bond lengths and bond angles in the following residue types are not validated in this section: KCX, TCE, GOL, LLP

The Z score for a bond length (or angle) is the number of standard deviations the observed value is removed from the expected value. A bond length (or angle) with  $|Z| > 5$  is considered an outlier worth inspection. RMSZ is the root-mean-square of all Z scores of the bond lengths (or angles).

Mol	Chain	Bond lengths		Bond angles	
		RMSZ	# Z  >5	RMSZ	# Z  >5
1	A	1.63	14/2881 (0.5%)	0.99	10/3883 (0.3%)
1	C	1.45	8/3034 (0.3%)	0.96	10/4092 (0.2%)
1	D	1.38	0/3017	0.94	3/4068 (0.1%)
2	B	1.51	14/2988 (0.5%)	0.93	6/4029 (0.1%)
All	All	1.49	36/11920 (0.3%)	0.96	29/16072 (0.2%)

Chiral center outliers are detected by calculating the chiral volume of a chiral center and verifying if the center is modelled as a planar moiety or with the opposite hand. A planarity outlier is detected by checking planarity of atoms in a peptide group, atoms in a mainchain group or atoms of a sidechain that are expected to be planar.

Mol	Chain	#Chirality outliers	#Planarity outliers
1	A	0	2
2	B	0	2
All	All	0	4

The worst 5 of 36 bond length outliers are listed below:

Mol	Chain	Res	Type	Atoms	Z	Observed(Å)	Ideal(Å)
1	A	345	GLU	CD-OE2	-7.20	1.17	1.25
2	B	363[A]	SER	CB-OG	-7.09	1.33	1.42
2	B	363[B]	SER	CB-OG	-7.09	1.33	1.42
2	B	162	GLU	CD-OE1	-6.63	1.18	1.25
1	A	363	SER	CB-OG	-6.40	1.33	1.42

The worst 5 of 29 bond angle outliers are listed below:

Mol	Chain	Res	Type	Atoms	Z	Observed(°)	Ideal(°)
1	A	3	LYS	O-C-N	-10.13	106.49	122.70
1	A	364	ARG	NE-CZ-NH2	-9.62	115.49	120.30

*Continued on next page...*

Continued from previous page...

Mol	Chain	Res	Type	Atoms	Z	Observed(°)	Ideal(°)
1	A	160	ASP	CB-CG-OD1	8.33	125.80	118.30
2	B	364	ARG	NE-CZ-NH2	-7.05	116.77	120.30
1	A	364	ARG	NE-CZ-NH1	7.04	123.82	120.30

There are no chirality outliers.

All (4) planarity outliers are listed below:

Mol	Chain	Res	Type	Group
1	A	3	LYS	Peptide,Mainchain
2	B	218	ARG	Mainchain
2	B	362	ILE	Peptide

## 5.2 Too-close contacts [i](#)

In the following table, the Non-H and H(model) columns list the number of non-hydrogen atoms and hydrogen atoms in the chain respectively. The H(added) column lists the number of hydrogen atoms added and optimized by MolProbity. The Clashes column lists the number of clashes within the asymmetric unit, whereas Symm-Clashes lists symmetry-related clashes.

Mol	Chain	Non-H	H(model)	H(added)	Clashes	Symm-Clashes
1	A	2880	0	2925	53	0
1	C	3029	0	3075	118	0
1	D	3013	0	3052	97	0
2	B	2972	0	3010	75	0
3	A	6	0	8	17	0
4	B	16	0	12	6	0
5	A	186	0	0	5	0
5	B	150	0	0	2	0
5	C	125	0	0	6	0
5	D	107	0	0	4	0
All	All	12484	0	12082	326	0

The all-atom clashscore is defined as the number of clashes found per 1000 atoms (including hydrogen atoms). The all-atom clashscore for this structure is 14.

The worst 5 of 326 close contacts within the same asymmetric unit are listed below, sorted by their clash magnitude.

Atom-1	Atom-2	Interatomic distance (Å)	Clash overlap (Å)
1:D:259:GLN:OE1	1:D:279:THR:HG22	1.49	1.12

Continued on next page...

Continued from previous page...

Atom-1	Atom-2	Interatomic distance (Å)	Clash overlap (Å)
2:B:264:VAL:H	2:B:274:THR:HG22	1.01	1.12
2:B:264:VAL:H	2:B:274:THR:CG2	1.61	1.11
2:B:100:LYS:HB3	4:B:401:TCE:H2	1.38	1.05
1:C:43:TYR:HE1	1:D:315:MET:HE3	1.21	1.03

There are no symmetry-related clashes.

## 5.3 Torsion angles [i](#)

### 5.3.1 Protein backbone [i](#)

In the following table, the Percentiles column shows the percent Ramachandran outliers of the chain as a percentile score with respect to all X-ray entries followed by that with respect to entries of similar resolution.

The Analysed column shows the number of residues for which the backbone conformation was analysed, and the total number of residues.

Mol	Chain	Analysed	Favoured	Allowed	Outliers	Percentiles	
1	A	356/385 (92%)	346 (97%)	9 (2%)	1 (0%)	41	41
1	C	378/385 (98%)	365 (97%)	11 (3%)	2 (0%)	29	26
1	D	374/385 (97%)	365 (98%)	9 (2%)	0	100	100
2	B	368/385 (96%)	360 (98%)	6 (2%)	2 (0%)	29	26
All	All	1476/1540 (96%)	1436 (97%)	35 (2%)	5 (0%)	41	41

All (5) Ramachandran outliers are listed below:

Mol	Chain	Res	Type
2	B	219	LEU
1	C	267	SER
1	C	58	LYS
2	B	200	ILE
1	A	200	ILE

### 5.3.2 Protein sidechains [i](#)

In the following table, the Percentiles column shows the percent sidechain outliers of the chain as a percentile score with respect to all X-ray entries followed by that with respect to entries of similar resolution.

The Analysed column shows the number of residues for which the sidechain conformation was analysed, and the total number of residues.

Mol	Chain	Analysed	Rotameric	Outliers	Percentiles	
1	A	313/332 (94%)	306 (98%)	7 (2%)	52	57
1	C	329/332 (99%)	315 (96%)	14 (4%)	29	29
1	D	327/332 (98%)	311 (95%)	16 (5%)	25	23
2	B	324/333 (97%)	315 (97%)	9 (3%)	43	47
All	All	1293/1329 (97%)	1247 (96%)	46 (4%)	35	36

5 of 46 residues with a non-rotameric sidechain are listed below:

Mol	Chain	Res	Type
1	C	319	MET
1	D	188	PHE
1	C	368	ARG
1	D	127	VAL
1	D	240	ASP

Sometimes sidechains can be flipped to improve hydrogen bonding and reduce clashes. 5 of 13 such sidechains are listed below:

Mol	Chain	Res	Type
1	C	182	GLN
1	C	317	GLN
1	D	374	ASN
1	D	148	GLN
1	D	256	HIS

### 5.3.3 RNA [i](#)

There are no RNA molecules in this entry.

## 5.4 Non-standard residues in protein, DNA, RNA chains [i](#)

7 non-standard protein/DNA/RNA residues are modelled in this entry.

In the following table, the Counts columns list the number of bonds (or angles) for which Mogul statistics could be retrieved, the number of bonds (or angles) that are observed in the model and the number of bonds (or angles) that are defined in the Chemical Component Dictionary. The Link column lists molecule types, if any, to which the group is linked. The Z score for a bond length (or angle) is the number of standard deviations the observed value is removed from the

expected value. A bond length (or angle) with  $|Z| > 2$  is considered an outlier worth inspection. RMSZ is the root-mean-square of all Z scores of the bond lengths (or angles).

Mol	Type	Chain	Res	Link	Bond lengths			Bond angles		
					Counts	RMSZ	# Z  > 2	Counts	RMSZ	# Z  > 2
1	KCX	D	130	1	9,11,12	1.31	1 (11%)	5,12,14	2.37	2 (40%)
1	LLP	A	39	1	23,24,25	2.65	9 (39%)	25,32,34	1.49	6 (24%)
1	LLP	D	39	1	23,24,25	2.19	9 (39%)	25,32,34	2.13	10 (40%)
1	KCX	C	130	1	9,11,12	1.30	1 (11%)	5,12,14	0.91	0
2	LLP	B	39	2	23,24,25	2.51	11 (47%)	25,32,34	1.49	4 (16%)
1	KCX	A	130	1	9,11,12	2.02	4 (44%)	5,12,14	1.79	1 (20%)
1	LLP	C	39	1	23,24,25	2.28	8 (34%)	25,32,34	1.91	8 (32%)

In the following table, the Chirals column lists the number of chiral outliers, the number of chiral centers analysed, the number of these observed in the model and the number defined in the Chemical Component Dictionary. Similar counts are reported in the Torsion and Rings columns. '-' means no outliers of that kind were identified.

Mol	Type	Chain	Res	Link	Chirals	Torsions	Rings
1	KCX	D	130	1	-	2/9/10/12	-
1	LLP	A	39	1	-	5/16/17/19	0/1/1/1
1	LLP	D	39	1	-	3/16/17/19	0/1/1/1
1	KCX	C	130	1	-	3/9/10/12	-
2	LLP	B	39	2	-	3/16/17/19	0/1/1/1
1	KCX	A	130	1	-	4/9/10/12	-
1	LLP	C	39	1	-	6/16/17/19	0/1/1/1

The worst 5 of 43 bond length outliers are listed below:

Mol	Chain	Res	Type	Atoms	Z	Observed(Å)	Ideal(Å)
1	A	39	LLP	C3-C2	6.28	1.47	1.40
1	D	39	LLP	C4'-NZ	5.40	1.45	1.27
1	A	39	LLP	C4'-NZ	5.36	1.45	1.27
2	B	39	LLP	C3-C2	5.25	1.46	1.40
1	C	39	LLP	C4'-NZ	4.79	1.43	1.27

The worst 5 of 31 bond angle outliers are listed below:

Mol	Chain	Res	Type	Atoms	Z	Observed(°)	Ideal(°)
1	D	39	LLP	C4-C4'-NZ	-5.17	100.59	124.31
1	C	39	LLP	CD-CE-NZ	4.39	121.68	110.93

*Continued on next page...*

Continued from previous page...

Mol	Chain	Res	Type	Atoms	Z	Observed(°)	Ideal(°)
1	D	130	KCX	CE-NZ-CX	3.96	128.25	121.89
1	C	39	LLP	C4-C4'-NZ	-3.92	106.30	124.31
1	A	130	KCX	OQ1-CX-NZ	3.65	130.61	124.96

There are no chirality outliers.

5 of 26 torsion outliers are listed below:

Mol	Chain	Res	Type	Atoms
1	A	39	LLP	C4-C4'-NZ-CE
1	A	130	KCX	N-CA-CB-CG
1	A	130	KCX	C-CA-CB-CG
2	B	39	LLP	C4-C4'-NZ-CE
1	C	39	LLP	C4-C4'-NZ-CE

There are no ring outliers.

3 monomers are involved in 4 short contacts:

Mol	Chain	Res	Type	Clashes	Symm-Clashes
1	C	130	KCX	1	0
1	A	130	KCX	2	0
1	C	39	LLP	1	0

## 5.5 Carbohydrates [i](#)

There are no monosaccharides in this entry.

## 5.6 Ligand geometry [i](#)

2 ligands are modelled in this entry.

In the following table, the Counts columns list the number of bonds (or angles) for which Mogul statistics could be retrieved, the number of bonds (or angles) that are observed in the model and the number of bonds (or angles) that are defined in the Chemical Component Dictionary. The Link column lists molecule types, if any, to which the group is linked. The Z score for a bond length (or angle) is the number of standard deviations the observed value is removed from the expected value. A bond length (or angle) with  $|Z| > 2$  is considered an outlier worth inspection. RMSZ is the root-mean-square of all Z scores of the bond lengths (or angles).

Mol	Type	Chain	Res	Link	Bond lengths			Bond angles		
					Counts	RMSZ	# Z  > 2	Counts	RMSZ	# Z  > 2
4	TCE	B	401	-	12,15,15	1.23	0	12,18,18	3.15	3 (25%)

Mol	Type	Chain	Res	Link	Bond lengths			Bond angles		
					Counts	RMSZ	# Z  > 2	Counts	RMSZ	# Z  > 2
3	GOL	A	401	-	5,5,5	1.16	0	5,5,5	2.07	2 (40%)

In the following table, the Chirals column lists the number of chiral outliers, the number of chiral centers analysed, the number of these observed in the model and the number defined in the Chemical Component Dictionary. Similar counts are reported in the Torsion and Rings columns. '-' means no outliers of that kind were identified.

Mol	Type	Chain	Res	Link	Chirals	Torsions	Rings
4	TCE	B	401	-	-	12/15/15/15	-
3	GOL	A	401	-	-	3/4/4/4	-

There are no bond length outliers.

All (5) bond angle outliers are listed below:

Mol	Chain	Res	Type	Atoms	Z	Observed(°)	Ideal(°)
4	B	401	TCE	C1-P-C3	5.99	120.03	100.95
4	B	401	TCE	C1-P-C2	5.98	120.00	100.95
4	B	401	TCE	C3-P-C2	5.97	119.97	100.95
3	A	401	GOL	O1-C1-C2	3.24	125.75	110.20
3	A	401	GOL	O3-C3-C2	2.50	122.17	110.20

There are no chirality outliers.

5 of 15 torsion outliers are listed below:

Mol	Chain	Res	Type	Atoms
3	A	401	GOL	O1-C1-C2-C3
4	B	401	TCE	P-C2-C5-C14
4	B	401	TCE	C5-C2-P-C3
4	B	401	TCE	C5-C2-P-C1
4	B	401	TCE	C6-C3-P-C2

There are no ring outliers.

2 monomers are involved in 23 short contacts:

Mol	Chain	Res	Type	Clashes	Symm-Clashes
4	B	401	TCE	6	0
3	A	401	GOL	17	0

The following is a two-dimensional graphical depiction of Mogul quality analysis of bond lengths, bond angles, torsion angles, and ring geometry for all instances of the Ligand of Interest. In

addition, ligands with molecular weight > 250 and outliers as shown on the validation Tables will also be included. For torsion angles, if less than 5% of the Mogul distribution of torsion angles is within 10 degrees of the torsion angle in question, then that torsion angle is considered an outlier. Any bond that is central to one or more torsion angles identified as an outlier by Mogul will be highlighted in the graph. For rings, the root-mean-square deviation (RMSD) between the ring in question and similar rings identified by Mogul is calculated over all ring torsion angles. If the average RMSD is greater than 60 degrees and the minimal RMSD between the ring in question and any Mogul-identified rings is also greater than 60 degrees, then that ring is considered an outlier. The outliers are highlighted in purple. The color gray indicates Mogul did not find sufficient equivalents in the CSD to analyse the geometry.

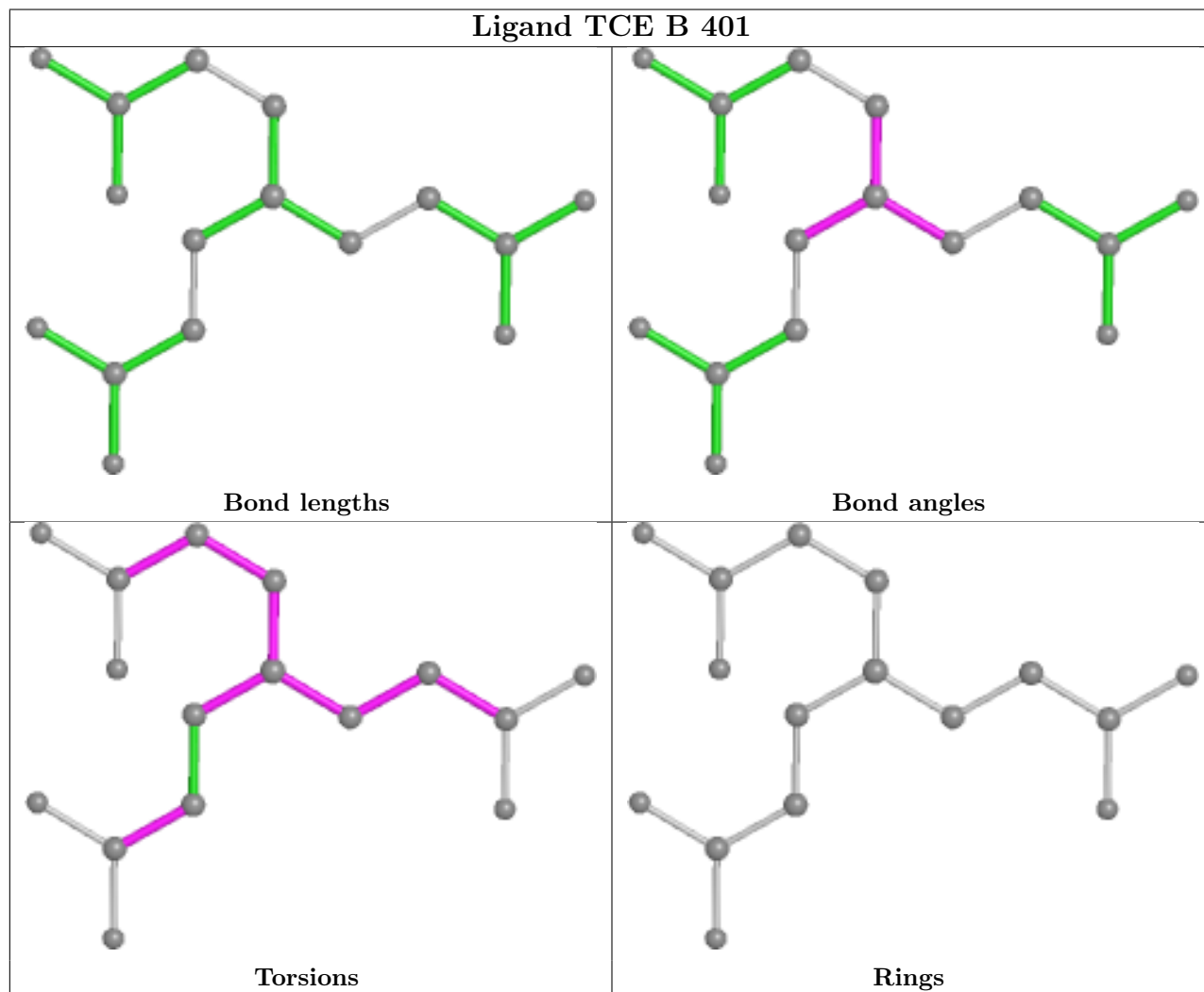

## 5.7 Other polymers [i](#)

There are no such residues in this entry.



## 5.8 Polymer linkage issues

There are no chain breaks in this entry.

## 6 Fit of model and data [i](#)

### 6.1 Protein, DNA and RNA chains [i](#)

In the following table, the column labelled ‘#RSRZ > 2’ contains the number (and percentage) of RSRZ outliers, followed by percent RSRZ outliers for the chain as percentile scores relative to all X-ray entries and entries of similar resolution. The OWAB column contains the minimum, median, 95<sup>th</sup> percentile and maximum values of the occupancy-weighted average B-factor per residue. The column labelled ‘Q < 0.9’ lists the number of (and percentage) of residues with an average occupancy less than 0.9.

Mol	Chain	Analysed	<RSRZ>	#RSRZ>2	OWAB(Å <sup>2</sup> )	Q<0.9
1	A	360/385 (93%)	-0.24	1 (0%) 94 94	16, 28, 49, 73	0
1	C	380/385 (98%)	-0.04	4 (1%) 80 84	23, 42, 63, 85	0
1	D	378/385 (98%)	0.05	16 (4%) 36 42	21, 43, 72, 92	0
2	B	373/385 (96%)	-0.16	6 (1%) 72 75	19, 35, 63, 81	0
All	All	1491/1540 (96%)	-0.09	27 (1%) 68 72	16, 37, 65, 92	0

The worst 5 of 27 RSRZ outliers are listed below:

Mol	Chain	Res	Type	RSRZ
1	A	332	ASP	4.6
1	D	273	THR	4.4
1	D	193	LEU	4.0
1	D	188	PHE	3.6
1	D	216	ASP	3.1

### 6.2 Non-standard residues in protein, DNA, RNA chains [i](#)

In the following table, the Atoms column lists the number of modelled atoms in the group and the number defined in the chemical component dictionary. The B-factors column lists the minimum, median, 95<sup>th</sup> percentile and maximum values of B factors of atoms in the group. The column labelled ‘Q < 0.9’ lists the number of atoms with occupancy less than 0.9.

Mol	Type	Chain	Res	Atoms	RSCC	RSR	B-factors(Å <sup>2</sup> )	Q<0.9
1	KCX	C	130	12/13	0.89	0.13	40,45,50,56	0
1	KCX	D	130	12/13	0.91	0.14	36,45,56,61	0
2	LLP	B	39	24/25	0.95	0.10	16,28,32,34	0
1	LLP	C	39	24/25	0.95	0.12	28,33,42,47	0
1	LLP	D	39	24/25	0.96	0.10	25,34,42,43	0
1	KCX	A	130	12/13	0.96	0.11	20,29,37,37	0
1	LLP	A	39	24/25	0.97	0.12	15,23,29,36	0

### 6.3 Carbohydrates [i](#)

There are no monosaccharides in this entry.

### 6.4 Ligands [i](#)

In the following table, the Atoms column lists the number of modelled atoms in the group and the number defined in the chemical component dictionary. The B-factors column lists the minimum, median, 95<sup>th</sup> percentile and maximum values of B factors of atoms in the group. The column labelled 'Q< 0.9' lists the number of atoms with occupancy less than 0.9.

Mol	Type	Chain	Res	Atoms	RSCC	RSR	B-factors(Å <sup>2</sup> )	Q<0.9
4	TCE	B	401	16/16	0.76	0.17	40,48,58,59	0
3	GOL	A	401	6/6	0.93	0.22	21,29,39,54	0

The following is a graphical depiction of the model fit to experimental electron density of all instances of the Ligand of Interest. In addition, ligands with molecular weight > 250 and outliers as shown on the geometry validation Tables will also be included. Each fit is shown from different orientation to approximate a three-dimensional view.

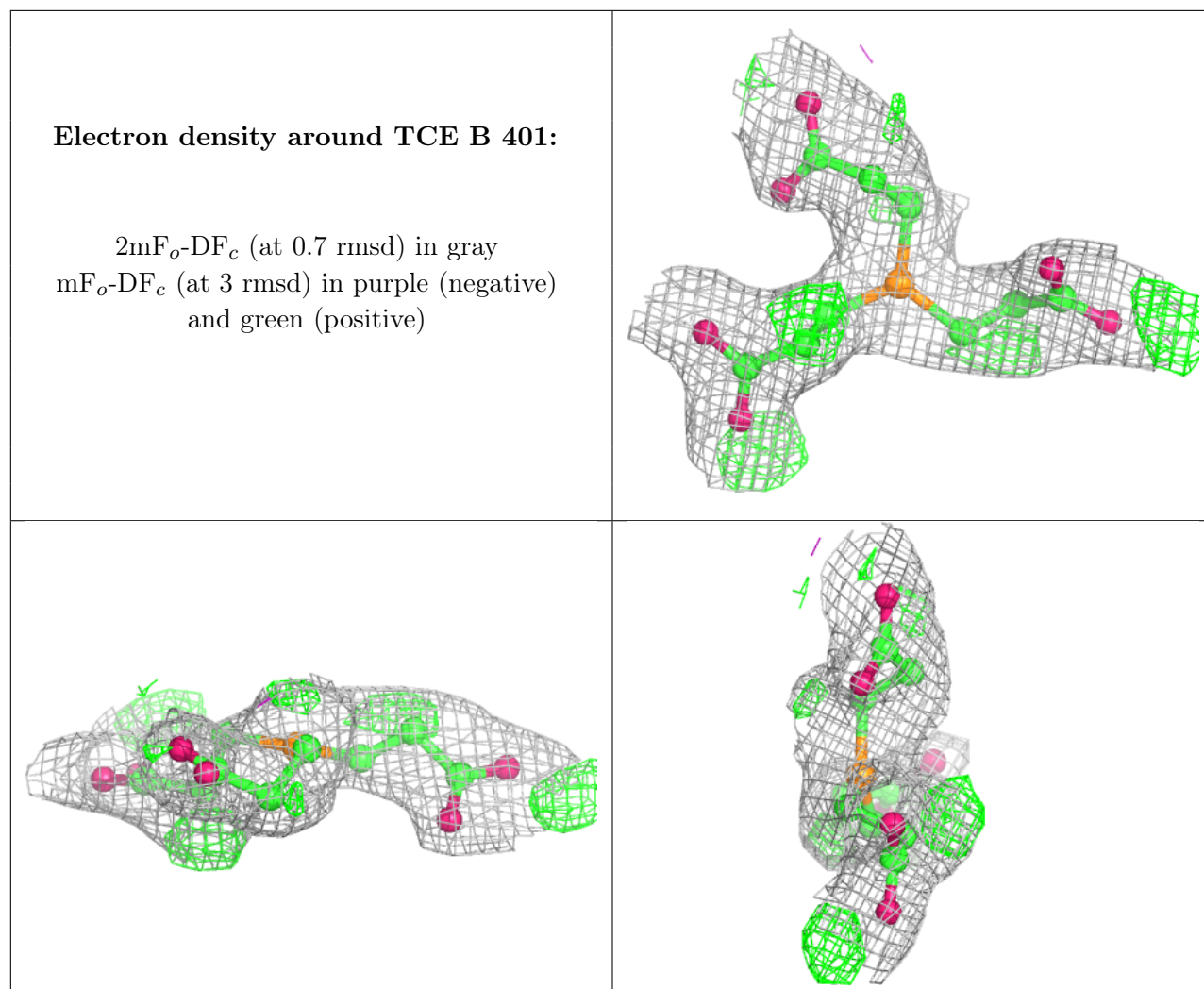

## 6.5 Other polymers [\(i\)](#)

There are no such residues in this entry.