



wwPDB X-ray Structure Validation Summary Report ⓘ

Nov 16, 2023 – 04:36 AM JST

PDB ID : 6KNZ
Title : Crystal structure of T2R-TTL-KXO1 complex
Authors : Chen, Q.; Yu, Y.
Deposited on : 2019-08-07
Resolution : 2.48 Å(reported)

This is a wwPDB X-ray Structure Validation Summary Report for a publicly released PDB entry.

We welcome your comments at validation@mail.wwpdb.org

A user guide is available at

<https://www.wwpdb.org/validation/2017/XrayValidationReportHelp>

with specific help available everywhere you see the ⓘ symbol.

The types of validation reports are described at

<https://www.wwpdb.org/validation/2017/FAQs#types>.

The following versions of software and data (see [references ⓘ](#)) were used in the production of this report:

MolProbity : 4.02b-467
Mogul : 1.8.5 (274361), CSD as541be (2020)
Xtriage (Phenix) : 1.13
EDS : 2.36
buster-report : 1.1.7 (2018)
Percentile statistics : 20191225.v01 (using entries in the PDB archive December 25th 2019)
Refmac : 5.8.0158
CCP4 : 7.0.044 (Gargrove)
Ideal geometry (proteins) : Engh & Huber (2001)
Ideal geometry (DNA, RNA) : Parkinson et al. (1996)
Validation Pipeline (wwPDB-VP) : 2.36

1 Overall quality at a glance

The following experimental techniques were used to determine the structure:

X-RAY DIFFRACTION

The reported resolution of this entry is 2.48 Å.

Percentile scores (ranging between 0-100) for global validation metrics of the entry are shown in the following graphic. The table shows the number of entries on which the scores are based.

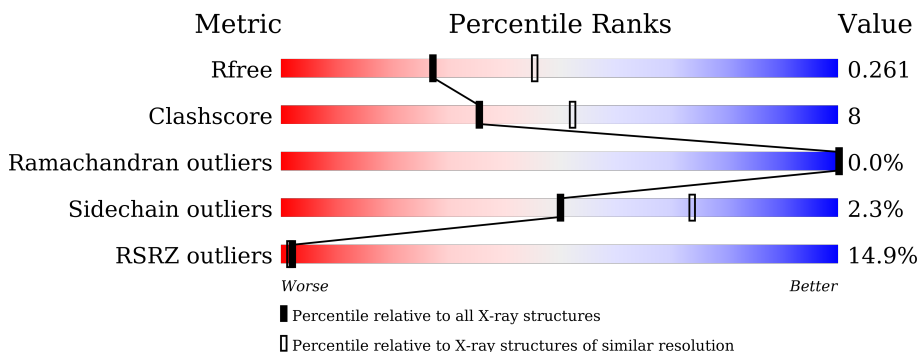

Metric	Whole archive (#Entries)	Similar resolution (#Entries, resolution range(Å))
R_{free}	130704	5857 (2.50-2.46)
Clashscore	141614	6594 (2.50-2.46)
Ramachandran outliers	138981	6469 (2.50-2.46)
Sidechain outliers	138945	6471 (2.50-2.46)
RSRZ outliers	127900	5738 (2.50-2.46)

The table below summarises the geometric issues observed across the polymeric chains and their fit to the electron density. The red, orange, yellow and green segments of the lower bar indicate the fraction of residues that contain outliers for ≥ 3 , 2, 1 and 0 types of geometric quality criteria respectively. A grey segment represents the fraction of residues that are not modelled. The numeric value for each fraction is indicated below the corresponding segment, with a dot representing fractions $\leq 5\%$. The upper red bar (where present) indicates the fraction of residues that have poor fit to the electron density. The numeric value is given above the bar.

Mol	Chain	Length	Quality of chain
1	A	450	 8% (poor fit), 82% (0-1 outliers), 14% (2-3 outliers), 2% (not modelled)
1	C	450	 5% (poor fit), 86% (0-1 outliers), 12% (2-3 outliers), 1% (not modelled)
2	B	445	 10% (poor fit), 78% (0-1 outliers), 16% (2-3 outliers), 6% (not modelled)
2	D	445	 21% (poor fit), 76% (0-1 outliers), 20% (2-3 outliers), 3% (not modelled)
3	E	143	 18% (poor fit), 73% (0-1 outliers), 13% (2-3 outliers), 14% (not modelled)
4	F	384	 26% (poor fit), 68% (0-1 outliers), 20% (2-3 outliers), 9% (not modelled)

The following table lists non-polymeric compounds, carbohydrate monomers and non-standard residues in protein, DNA, RNA chains that are outliers for geometric or electron-density-fit criteria:

Mol	Type	Chain	Res	Chirality	Geometry	Clashes	Electron density
7	CA	D	502	-	-	-	X
9	MES	B	507	-	-	X	-

2 Entry composition i

There are 12 unique types of molecules in this entry. The entry contains 35097 atoms, of which 17128 are hydrogens and 0 are deuteriums.

In the tables below, the ZeroOcc column contains the number of atoms modelled with zero occupancy, the AltConf column contains the number of residues with at least one atom in alternate conformation and the Trace column contains the number of residues modelled with at most 2 atoms.

- Molecule 1 is a protein called Tubulin alpha-1B chain.

Mol	Chain	Residues	Atoms					ZeroOcc	AltConf	Trace	
			Total	C	H	N	O				S
1	A	438	6779	2176	3339	584	656	24	0	3	0
1	C	440	6825	2195	3362	586	659	23	0	6	0

- Molecule 2 is a protein called Tubulin beta-2B chain.

Mol	Chain	Residues	Atoms					ZeroOcc	AltConf	Trace	
			Total	C	H	N	O				S
2	B	425	6592	2111	3233	574	647	27	0	3	0
2	D	425	6543	2095	3205	569	648	26	0	1	0

- Molecule 3 is a protein called Stathmin-4.

Mol	Chain	Residues	Atoms					ZeroOcc	AltConf	Trace	
			Total	C	H	N	O				S
3	E	123	2080	638	1044	188	205	5	0	3	0

There are 2 discrepancies between the modelled and reference sequences:

Chain	Residue	Modelled	Actual	Comment	Reference
E	3	MET	-	expression tag	UNP P63043
E	4	ALA	-	expression tag	UNP P63043

- Molecule 4 is a protein called Tubulin tyrosine ligase.

Mol	Chain	Residues	Atoms					ZeroOcc	AltConf	Trace	
			Total	C	H	N	O				S
4	F	349	5665	1830	2808	489	523	15	0	1	0

There are 6 discrepancies between the modelled and reference sequences:

Chain	Residue	Modelled	Actual	Comment	Reference
F	379	HIS	-	expression tag	UNP E1BQ43
F	380	HIS	-	expression tag	UNP E1BQ43
F	381	HIS	-	expression tag	UNP E1BQ43
F	382	HIS	-	expression tag	UNP E1BQ43
F	383	HIS	-	expression tag	UNP E1BQ43
F	384	HIS	-	expression tag	UNP E1BQ43

- Molecule 5 is GUANOSINE-5'-TRIPHOSPHATE (three-letter code: GTP) (formula: $C_{10}H_{16}N_5O_{14}P_3$).

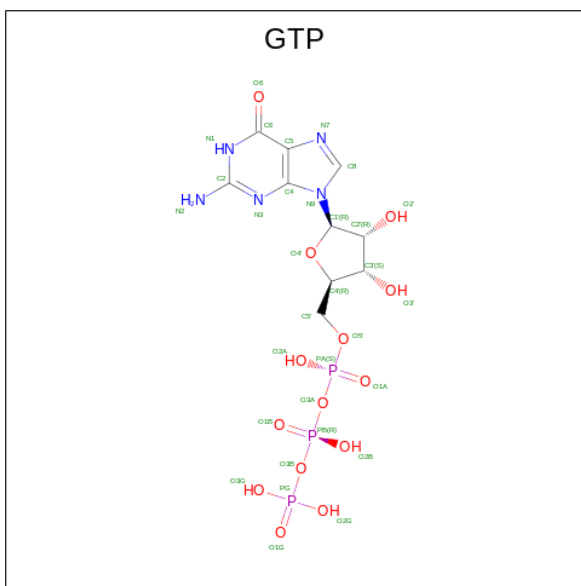

Mol	Chain	Residues	Atoms					ZeroOcc	AltConf	
			Total	C	H	N	O			P
5	A	1	Total	C	H	N	O	P	0	0
			42	10	10	5	14	3		
5	C	1	Total	C	H	N	O	P	0	0
			42	10	10	5	14	3		
5	D	1	Total	C	H	N	O	P	0	0
			42	10	10	5	14	3		

- Molecule 6 is MAGNESIUM ION (three-letter code: MG) (formula: Mg).

Mol	Chain	Residues	Atoms		ZeroOcc	AltConf
6	A	1	Total	Mg	0	0
			1	1		
6	B	1	Total	Mg	0	0
			1	1		
6	C	1	Total	Mg	0	0
			1	1		

Continued on next page...

Continued from previous page...

Mol	Chain	Residues	Atoms	ZeroOcc	AltConf
6	D	1	Total Mg 1 1	0	0
6	F	1	Total Mg 1 1	0	0

- Molecule 7 is CALCIUM ION (three-letter code: CA) (formula: Ca).

Mol	Chain	Residues	Atoms	ZeroOcc	AltConf
7	A	1	Total Ca 1 1	0	0
7	B	2	Total Ca 2 2	0	0
7	C	1	Total Ca 1 1	0	0
7	D	1	Total Ca 1 1	0	0
7	E	1	Total Ca 1 1	0	0

- Molecule 8 is GUANOSINE-5'-DIPHOSPHATE (three-letter code: GDP) (formula: C₁₀H₁₅N₅O₁₁P₂).

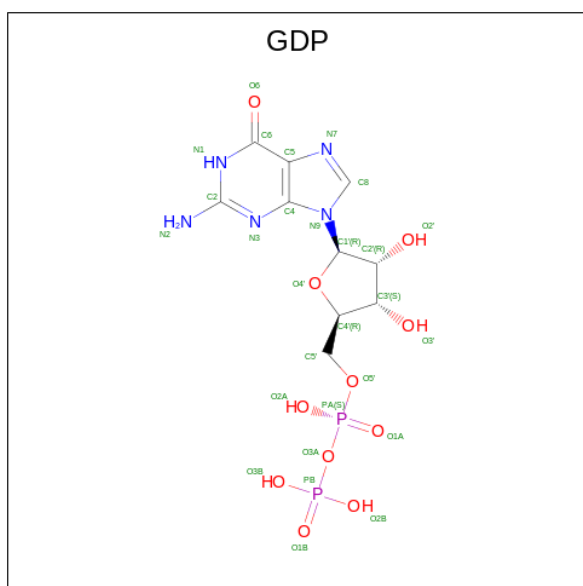

Mol	Chain	Residues	Atoms	ZeroOcc	AltConf
8	B	1	Total C H N O P 38 10 10 5 11 2	0	0

- Molecule 9 is 2-(N-MORPHOLINO)-ETHANESULFONIC ACID (three-letter code: MES) (formula: C₆H₁₃NO₄S).

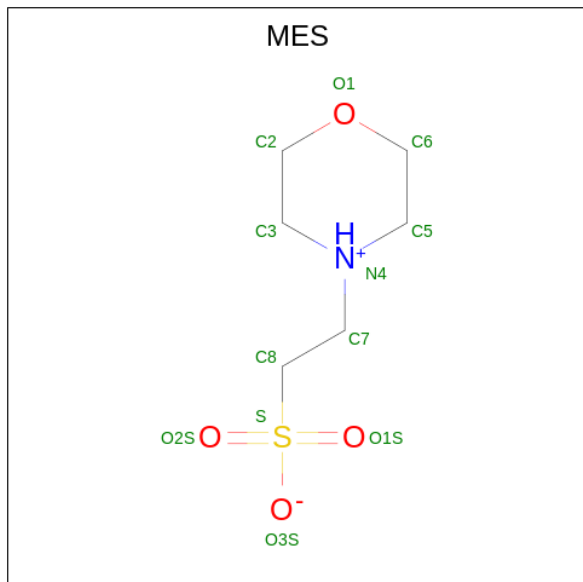

Mol	Chain	Residues	Atoms					ZeroOcc	AltConf		
			Total	C	H	N	O			S	
9	B	1	Total	24	6	12	1	4	1	0	0
9	B	1	Total	25	6	13	1	4	1	0	0

- Molecule 10 is 2-[5-[4-(2-morpholin-4-ylethoxy)phenyl]pyridin-2-yl]-{N}-(phenylmethyl)ethanamide (three-letter code: DN0) (formula: C₂₆H₂₉N₃O₃) (labeled as "Ligand of Interest" by depositor).

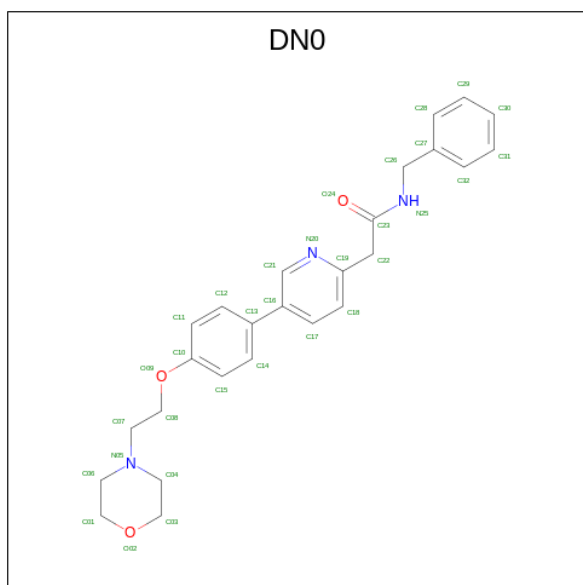

Mol	Chain	Residues	Atoms					ZeroOcc	AltConf
10	B	1	Total	C	H	N	O	0	0
			61	26	29	3	3		
10	D	1	Total	C	H	N	O	0	0
			61	26	29	3	3		

- Molecule 11 is PHOSPHOMETHYLPHOSPHONIC ACID ADENYLATE ESTER (three-letter code: ACP) (formula: C₁₁H₁₈N₅O₁₂P₃).

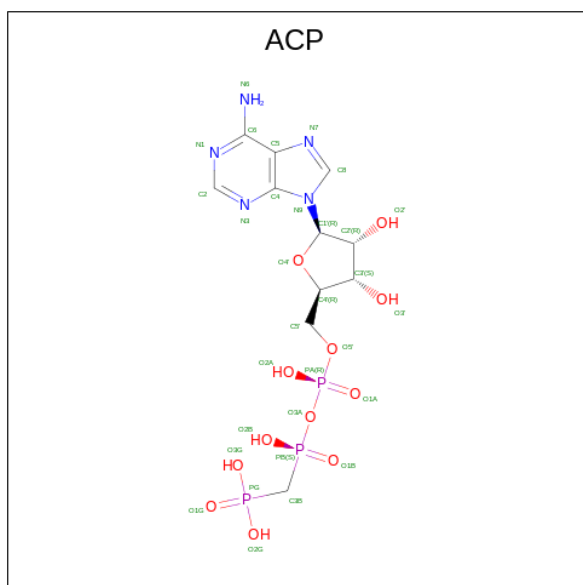

Mol	Chain	Residues	Atoms						ZeroOcc	AltConf
11	F	1	Total	C	H	N	O	P	0	0
			45	11	14	5	12	3		

- Molecule 12 is water.

Mol	Chain	Residues	Atoms		ZeroOcc	AltConf
12	A	54	Total	O	0	0
			54	54		
12	B	44	Total	O	0	0
			44	44		
12	C	96	Total	O	0	0
			96	96		
12	D	11	Total	O	0	0
			11	11		
12	E	3	Total	O	0	0
			3	3		
12	F	14	Total	O	0	0
			14	14		

3 Residue-property plots [i](#)

These plots are drawn for all protein, RNA, DNA and oligosaccharide chains in the entry. The first graphic for a chain summarises the proportions of the various outlier classes displayed in the second graphic. The second graphic shows the sequence view annotated by issues in geometry and electron density. Residues are color-coded according to the number of geometric quality criteria for which they contain at least one outlier: green = 0, yellow = 1, orange = 2 and red = 3 or more. A red dot above a residue indicates a poor fit to the electron density ($RSRZ > 2$). Stretches of 2 or more consecutive residues without any outlier are shown as a green connector. Residues present in the sample, but not in the model, are shown in grey.

- Molecule 1: Tubulin alpha-1B chain

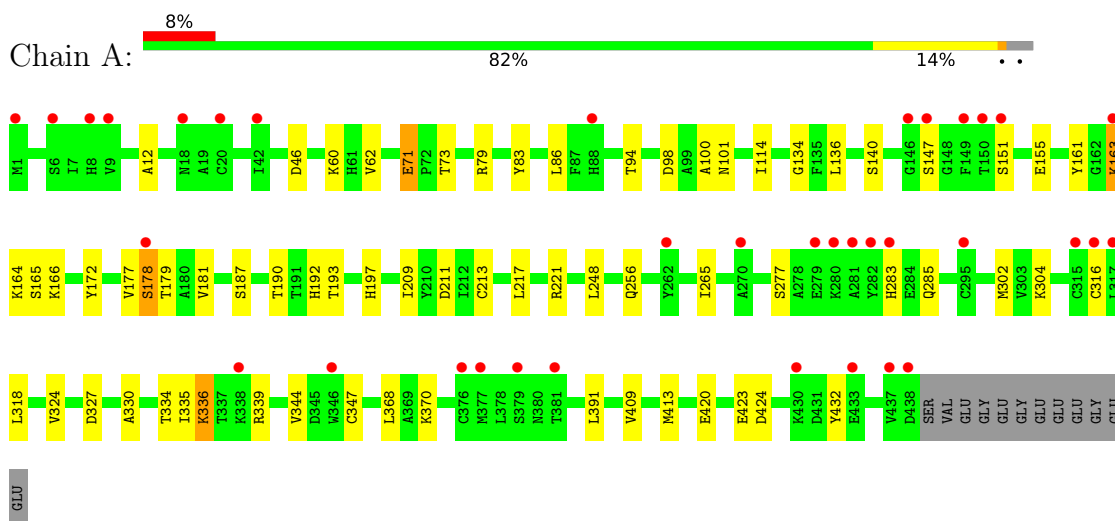

- Molecule 1: Tubulin alpha-1B chain

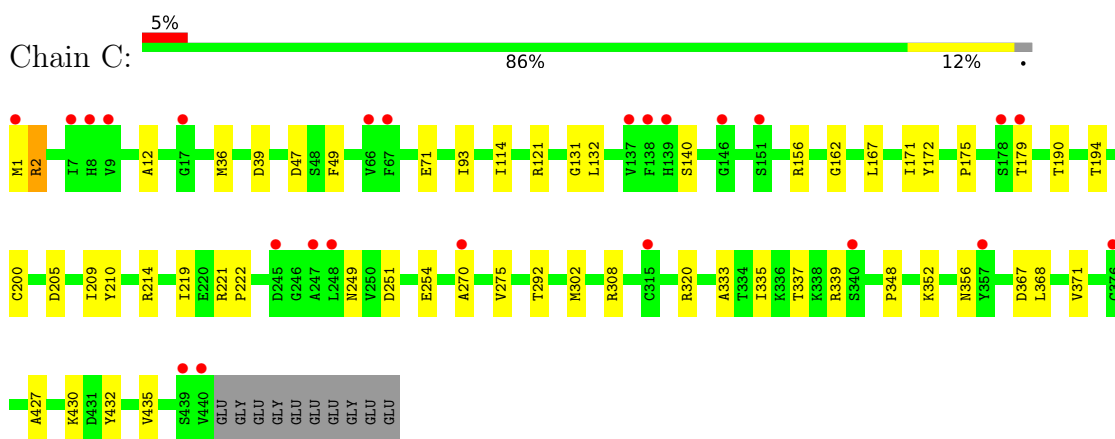

- Molecule 2: Tubulin beta-2B chain

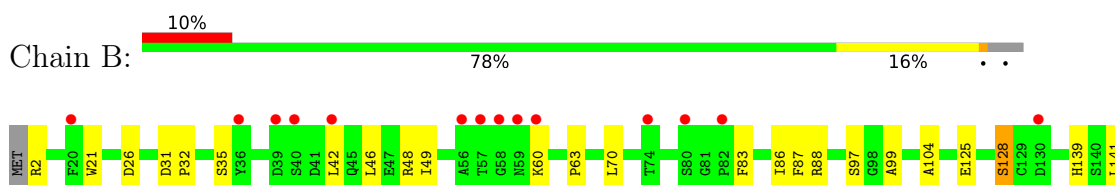

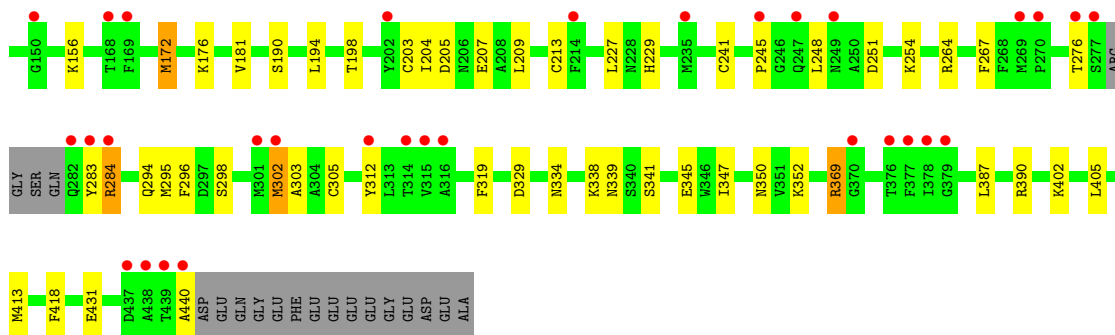

• Molecule 2: Tubulin beta-2B chain

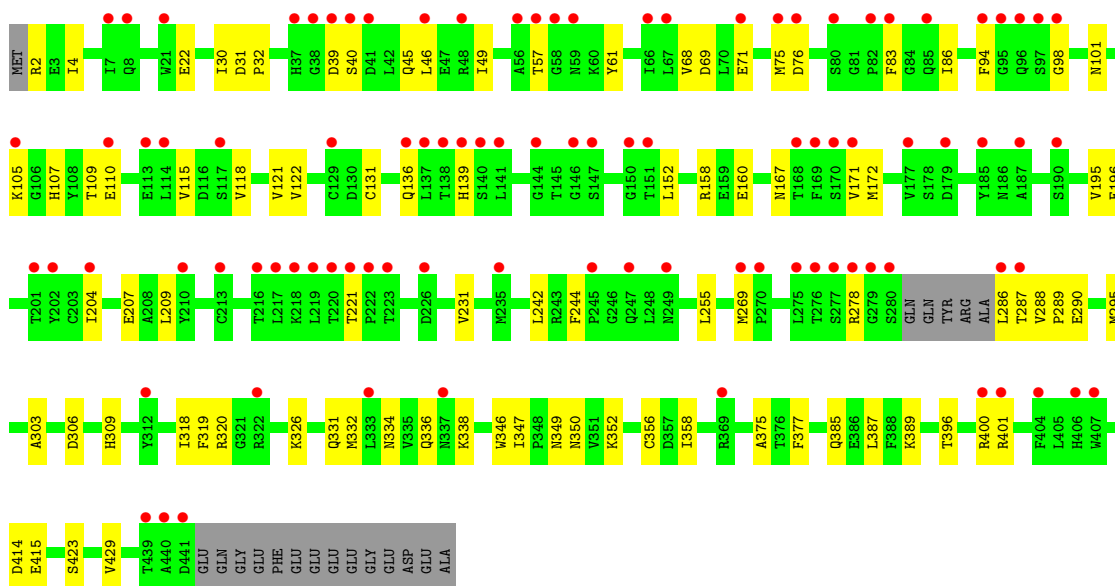
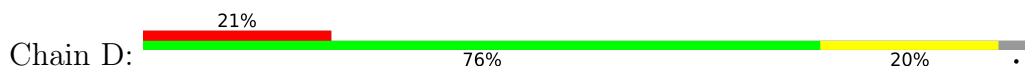

• Molecule 3: Stathmin-4

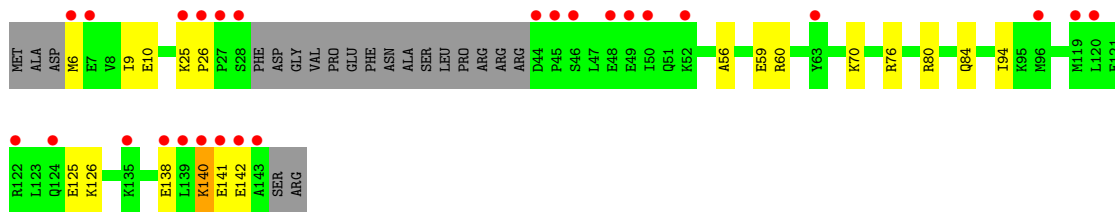
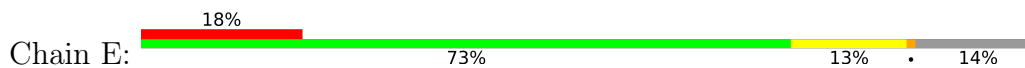

• Molecule 4: Tubulin tyrosine ligase

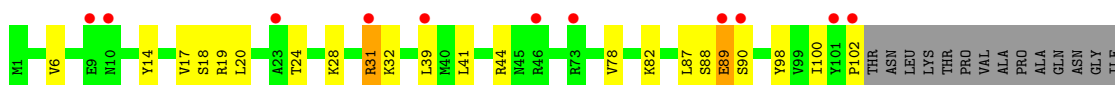

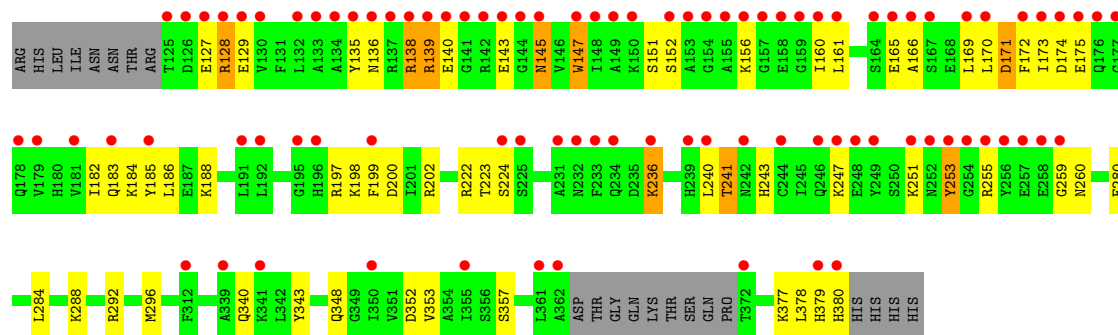

4 Data and refinement statistics

Property	Value	Source
Space group	P 21 21 21	Depositor
Cell constants a, b, c, α , β , γ	104.93Å 157.06Å 182.21Å 90.00° 90.00° 90.00°	Depositor
Resolution (Å)	26.23 – 2.48 26.23 – 2.47	Depositor EDS
% Data completeness (in resolution range)	98.7 (26.23-2.48) 98.8 (26.23-2.47)	Depositor EDS
R_{merge}	(Not available)	Depositor
R_{sym}	(Not available)	Depositor
$\langle I/\sigma(I) \rangle$ ¹	1.60 (at 2.47Å)	Xtrriage
Refinement program	PHENIX 1.15.2_3472	Depositor
R, R_{free}	0.220 , 0.261 0.220 , 0.261	Depositor DCC
R_{free} test set	1364 reflections (1.28%)	wwPDB-VP
Wilson B-factor (Å ²)	52.7	Xtrriage
Anisotropy	0.223	Xtrriage
Bulk solvent k_{sol} (e/Å ³), B_{sol} (Å ²)	0.39 , 51.3	EDS
L-test for twinning ²	$\langle L \rangle = 0.50$, $\langle L^2 \rangle = 0.33$	Xtrriage
Estimated twinning fraction	No twinning to report.	Xtrriage
F_o, F_c correlation	0.94	EDS
Total number of atoms	35097	wwPDB-VP
Average B, all atoms (Å ²)	73.0	wwPDB-VP

Xtrriage's analysis on translational NCS is as follows: *The largest off-origin peak in the Patterson function is 2.62% of the height of the origin peak. No significant pseudotranslation is detected.*

¹Intensities estimated from amplitudes.

²Theoretical values of $\langle |L| \rangle$, $\langle L^2 \rangle$ for acentric reflections are 0.5, 0.333 respectively for untwinned datasets, and 0.375, 0.2 for perfectly twinned datasets.

5 Model quality [i](#)

5.1 Standard geometry [i](#)

Bond lengths and bond angles in the following residue types are not validated in this section: CA, DN0, ACP, MG, GTP, MES, GDP

The Z score for a bond length (or angle) is the number of standard deviations the observed value is removed from the expected value. A bond length (or angle) with $|Z| > 5$ is considered an outlier worth inspection. RMSZ is the root-mean-square of all Z scores of the bond lengths (or angles).

Mol	Chain	Bond lengths		Bond angles	
		RMSZ	# Z >5	RMSZ	# Z >5
1	A	0.29	0/3521	0.47	0/4780
1	C	0.30	1/3560 (0.0%)	0.47	0/4835
2	B	0.34	2/3442 (0.1%)	0.53	2/4662 (0.0%)
2	D	0.46	4/3414 (0.1%)	0.56	2/4624 (0.0%)
3	E	0.31	0/1048	0.40	0/1391
4	F	0.58	10/2922 (0.3%)	0.62	3/3946 (0.1%)
All	All	0.40	17/17907 (0.1%)	0.52	7/24238 (0.0%)

Chiral center outliers are detected by calculating the chiral volume of a chiral center and verifying if the center is modelled as a planar moiety or with the opposite hand. A planarity outlier is detected by checking planarity of atoms in a peptide group, atoms in a mainchain group or atoms of a sidechain that are expected to be planar.

Mol	Chain	#Chirality outliers	#Planarity outliers
2	D	0	1
4	F	0	1
All	All	0	2

The worst 5 of 17 bond length outliers are listed below:

Mol	Chain	Res	Type	Atoms	Z	Observed(Å)	Ideal(Å)
2	D	160	GLU	CD-OE1	15.11	1.42	1.25
2	D	160	GLU	CD-OE2	10.23	1.36	1.25
4	F	147	TRP	CG-CD1	9.48	1.50	1.36
4	F	138	ARG	CB-CG	7.89	1.73	1.52
4	F	147	TRP	CD1-NE1	-7.15	1.25	1.38

The worst 5 of 7 bond angle outliers are listed below:

Mol	Chain	Res	Type	Atoms	Z	Observed(°)	Ideal(°)
2	B	284	ARG	NE-CZ-NH1	-12.82	113.89	120.30
4	F	138	ARG	CD-NE-CZ	10.69	138.56	123.60
2	B	284	ARG	CG-CD-NE	-9.68	91.47	111.80
2	D	160	GLU	OE1-CD-OE2	9.39	134.56	123.30
2	D	76	ASP	CB-CG-OD1	7.93	125.43	118.30

There are no chirality outliers.

All (2) planarity outliers are listed below:

Mol	Chain	Res	Type	Group
2	D	57	THR	Peptide
4	F	241	THR	Peptide

5.2 Too-close contacts [i](#)

In the following table, the Non-H and H(model) columns list the number of non-hydrogen atoms and hydrogen atoms in the chain respectively. The H(added) column lists the number of hydrogen atoms added and optimized by MolProbity. The Clashes column lists the number of clashes within the asymmetric unit, whereas Symm-Clashes lists symmetry-related clashes.

Mol	Chain	Non-H	H(model)	H(added)	Clashes	Symm-Clashes
1	A	3440	3339	3350	49	0
1	C	3463	3362	3387	38	0
2	B	3359	3233	3244	55	0
2	D	3338	3205	3215	57	0
3	E	1036	1044	1047	10	0
4	F	2857	2808	2824	81	0
5	A	32	10	12	1	0
5	C	32	10	12	0	0
5	D	32	10	12	0	0
6	A	1	0	0	0	0
6	B	1	0	0	0	0
6	C	1	0	0	0	0
6	D	1	0	0	0	0
6	F	1	0	0	0	0
7	A	1	0	0	0	0
7	B	2	0	0	0	0
7	C	1	0	0	0	0
7	D	1	0	0	0	0
7	E	1	0	0	0	0
8	B	28	10	12	2	0
9	B	24	25	24	6	0

Continued on next page...

Continued from previous page...

Mol	Chain	Non-H	H(model)	H(added)	Clashes	Symm-Clashes
10	B	32	29	0	1	0
10	D	32	29	0	3	0
11	F	31	14	13	3	0
12	A	54	0	0	3	0
12	B	44	0	0	9	0
12	C	96	0	0	7	0
12	D	11	0	0	2	0
12	E	3	0	0	0	0
12	F	14	0	0	0	0
All	All	17969	17128	17152	283	0

The all-atom clashscore is defined as the number of clashes found per 1000 atoms (including hydrogen atoms). The all-atom clashscore for this structure is 8.

The worst 5 of 283 close contacts within the same asymmetric unit are listed below, sorted by their clash magnitude.

Atom-1	Atom-2	Interatomic distance (Å)	Clash overlap (Å)
2:B:312:TYR:OH	12:B:601:HOH:O	1.85	0.93
4:F:135:TYR:CE2	4:F:145:ASN:OD1	2.25	0.89
4:F:135:TYR:HD2	4:F:147:TRP:HE1	1.23	0.82
2:B:294:GLN:NE2	12:B:602:HOH:O	2.12	0.81
2:D:331:GLN:OE1	12:D:601:HOH:O	2.03	0.77

There are no symmetry-related clashes.

5.3 Torsion angles [\(i\)](#)

5.3.1 Protein backbone [\(i\)](#)

In the following table, the Percentiles column shows the percent Ramachandran outliers of the chain as a percentile score with respect to all X-ray entries followed by that with respect to entries of similar resolution.

The Analysed column shows the number of residues for which the backbone conformation was analysed, and the total number of residues.

Mol	Chain	Analysed	Favoured	Allowed	Outliers	Percentiles
1	A	439/450 (98%)	428 (98%)	11 (2%)	0	100 100
1	C	444/450 (99%)	436 (98%)	8 (2%)	0	100 100

Continued on next page...

Continued from previous page...

Mol	Chain	Analysed	Favoured	Allowed	Outliers	Percentiles	
2	B	424/445 (95%)	413 (97%)	11 (3%)	0	100	100
2	D	422/445 (95%)	414 (98%)	8 (2%)	0	100	100
3	E	122/143 (85%)	121 (99%)	1 (1%)	0	100	100
4	F	344/384 (90%)	329 (96%)	14 (4%)	1 (0%)	41	59
All	All	2195/2317 (95%)	2141 (98%)	53 (2%)	1 (0%)	100	100

All (1) Ramachandran outliers are listed below:

Mol	Chain	Res	Type
4	F	89	GLU

5.3.2 Protein sidechains [i](#)

In the following table, the Percentiles column shows the percent sidechain outliers of the chain as a percentile score with respect to all X-ray entries followed by that with respect to entries of similar resolution.

The Analysed column shows the number of residues for which the sidechain conformation was analysed, and the total number of residues.

Mol	Chain	Analysed	Rotameric	Outliers	Percentiles	
1	A	372/378 (98%)	365 (98%)	7 (2%)	57	78
1	C	377/378 (100%)	372 (99%)	5 (1%)	69	86
2	B	370/383 (97%)	361 (98%)	9 (2%)	49	72
2	D	368/383 (96%)	361 (98%)	7 (2%)	57	78
3	E	113/127 (89%)	109 (96%)	4 (4%)	36	59
4	F	312/342 (91%)	301 (96%)	11 (4%)	36	59
All	All	1912/1991 (96%)	1869 (98%)	43 (2%)	50	75

5 of 43 residues with a non-rotameric sidechain are listed below:

Mol	Chain	Res	Type
3	E	6	MET
4	F	139	ARG
3	E	125	GLU
4	F	18	SER
4	F	183	GLN

Sometimes sidechains can be flipped to improve hydrogen bonding and reduce clashes. 5 of 9 such sidechains are listed below:

Mol	Chain	Res	Type
4	F	260	ASN
4	F	379	HIS
2	B	37	HIS
2	B	91	ASN
4	F	145	ASN

5.3.3 RNA [i](#)

There are no RNA molecules in this entry.

5.4 Non-standard residues in protein, DNA, RNA chains [i](#)

There are no non-standard protein/DNA/RNA residues in this entry.

5.5 Carbohydrates [i](#)

There are no monosaccharides in this entry.

5.6 Ligand geometry [i](#)

Of 20 ligands modelled in this entry, 11 are monoatomic - leaving 9 for Mogul analysis.

In the following table, the Counts columns list the number of bonds (or angles) for which Mogul statistics could be retrieved, the number of bonds (or angles) that are observed in the model and the number of bonds (or angles) that are defined in the Chemical Component Dictionary. The Link column lists molecule types, if any, to which the group is linked. The Z score for a bond length (or angle) is the number of standard deviations the observed value is removed from the expected value. A bond length (or angle) with $|Z| > 2$ is considered an outlier worth inspection. RMSZ is the root-mean-square of all Z scores of the bond lengths (or angles).

Mol	Type	Chain	Res	Link	Bond lengths			Bond angles		
					Counts	RMSZ	$\# Z > 2$	Counts	RMSZ	$\# Z > 2$
5	GTP	D	503	6	26,34,34	1.15	3 (11%)	32,54,54	1.58	9 (28%)
11	ACP	F	402	6	27,33,33	4.92	11 (40%)	32,52,52	2.31	13 (40%)
10	DN0	D	504	-	35,35,35	2.57	10 (28%)	44,45,45	1.86	12 (27%)
8	GDP	B	501	6	24,30,30	1.19	2 (8%)	30,47,47	1.36	5 (16%)
5	GTP	A	501	6	26,34,34	1.18	3 (11%)	32,54,54	1.52	6 (18%)
5	GTP	C	501	6	26,34,34	1.16	3 (11%)	32,54,54	1.55	7 (21%)

Mol	Type	Chain	Res	Link	Bond lengths			Bond angles		
					Counts	RMSZ	# Z > 2	Counts	RMSZ	# Z > 2
10	DN0	B	506	-	35,35,35	2.55	9 (25%)	44,45,45	2.02	12 (27%)
9	MES	B	503	-	12,12,12	2.12	1 (8%)	14,16,16	2.00	4 (28%)
9	MES	B	507	-	12,12,12	2.27	1 (8%)	14,16,16	2.66	6 (42%)

In the following table, the Chirals column lists the number of chiral outliers, the number of chiral centers analysed, the number of these observed in the model and the number defined in the Chemical Component Dictionary. Similar counts are reported in the Torsion and Rings columns. '-' means no outliers of that kind were identified.

Mol	Type	Chain	Res	Link	Chirals	Torsions	Rings
5	GTP	D	503	6	-	3/18/38/38	0/3/3/3
11	ACP	F	402	6	-	10/15/38/38	0/3/3/3
10	DN0	D	504	-	-	7/19/27/27	0/4/4/4
8	GDP	B	501	6	-	3/12/32/32	0/3/3/3
5	GTP	A	501	6	-	5/18/38/38	0/3/3/3
5	GTP	C	501	6	-	8/18/38/38	0/3/3/3
10	DN0	B	506	-	-	5/19/27/27	0/4/4/4
9	MES	B	503	-	-	5/6/14/14	0/1/1/1
9	MES	B	507	-	-	3/6/14/14	0/1/1/1

The worst 5 of 43 bond length outliers are listed below:

Mol	Chain	Res	Type	Atoms	Z	Observed(Å)	Ideal(Å)
11	F	402	ACP	PB-O3A	21.67	1.82	1.58
10	B	506	DN0	C22-C19	8.99	1.60	1.51
11	F	402	ACP	PA-O5'	8.54	1.93	1.59
10	D	504	DN0	C22-C19	8.25	1.59	1.51
9	B	507	MES	C8-S	-7.55	1.66	1.77

The worst 5 of 74 bond angle outliers are listed below:

Mol	Chain	Res	Type	Atoms	Z	Observed(°)	Ideal(°)
10	B	506	DN0	C22-C23-N25	7.03	125.69	116.19
9	B	507	MES	C6-C5-N4	-6.34	100.50	110.10
11	F	402	ACP	O4'-C1'-C2'	5.57	115.06	106.93
10	D	504	DN0	C22-C23-N25	5.56	123.70	116.19
9	B	503	MES	C5-N4-C3	5.16	120.43	108.83

There are no chirality outliers.

5 of 49 torsion outliers are listed below:

Mol	Chain	Res	Type	Atoms
5	A	501	GTP	PB-O3B-PG-O2G
5	A	501	GTP	C5'-O5'-PA-O1A
5	A	501	GTP	C5'-O5'-PA-O2A
5	C	501	GTP	C5'-O5'-PA-O1A
5	C	501	GTP	C5'-O5'-PA-O2A

There are no ring outliers.

6 monomers are involved in 16 short contacts:

Mol	Chain	Res	Type	Clashes	Symm-Clashes
11	F	402	ACP	3	0
10	D	504	DN0	3	0
8	B	501	GDP	2	0
5	A	501	GTP	1	0
10	B	506	DN0	1	0
9	B	507	MES	6	0

The following is a two-dimensional graphical depiction of Mogul quality analysis of bond lengths, bond angles, torsion angles, and ring geometry for all instances of the Ligand of Interest. In addition, ligands with molecular weight > 250 and outliers as shown on the validation Tables will also be included. For torsion angles, if less than 5% of the Mogul distribution of torsion angles is within 10 degrees of the torsion angle in question, then that torsion angle is considered an outlier. Any bond that is central to one or more torsion angles identified as an outlier by Mogul will be highlighted in the graph. For rings, the root-mean-square deviation (RMSD) between the ring in question and similar rings identified by Mogul is calculated over all ring torsion angles. If the average RMSD is greater than 60 degrees and the minimal RMSD between the ring in question and any Mogul-identified rings is also greater than 60 degrees, then that ring is considered an outlier. The outliers are highlighted in purple. The color gray indicates Mogul did not find sufficient equivalents in the CSD to analyse the geometry.

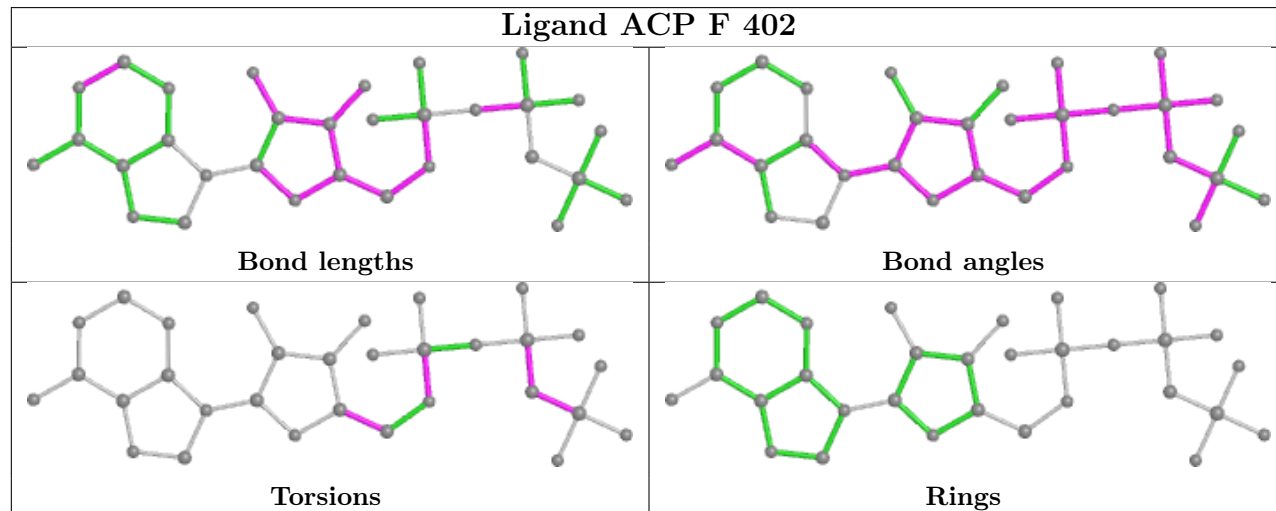
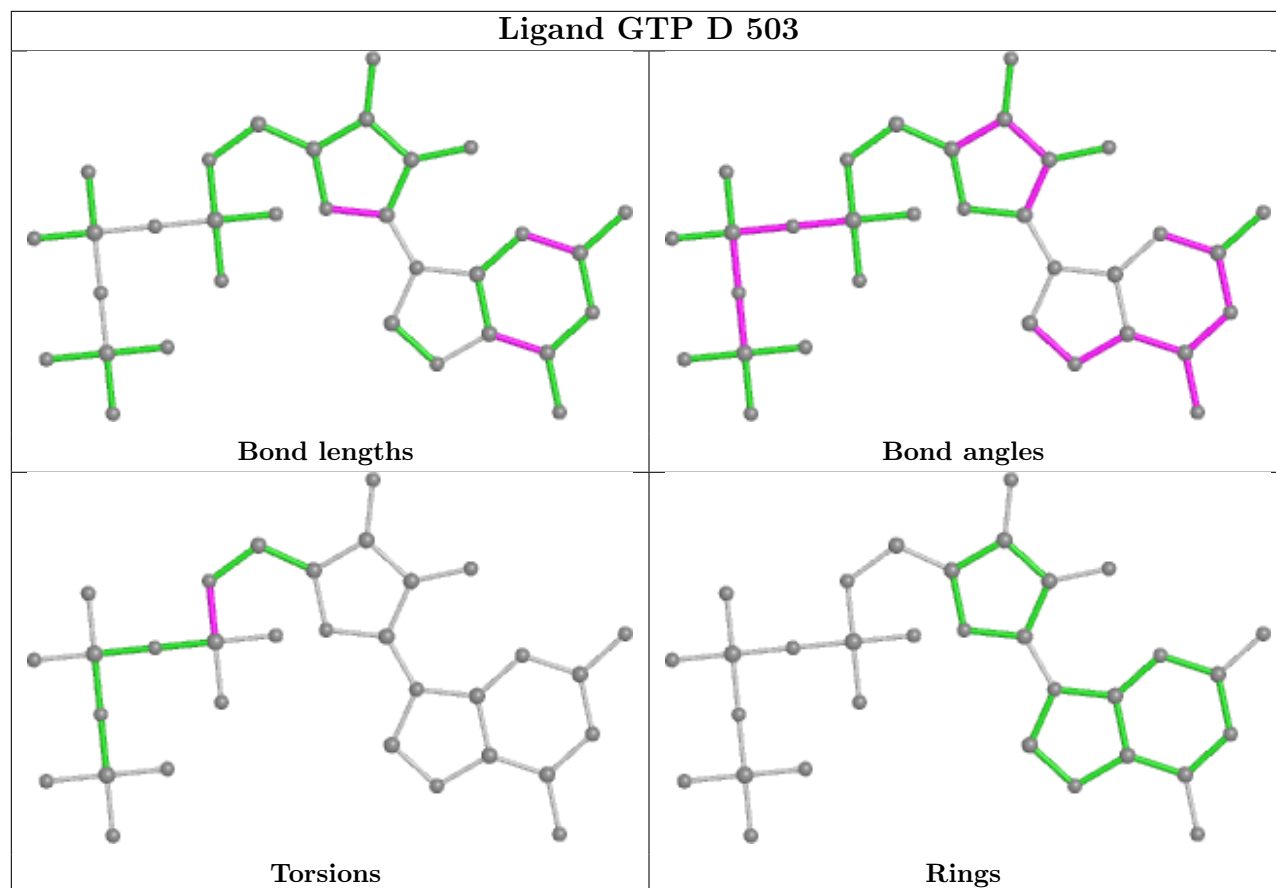

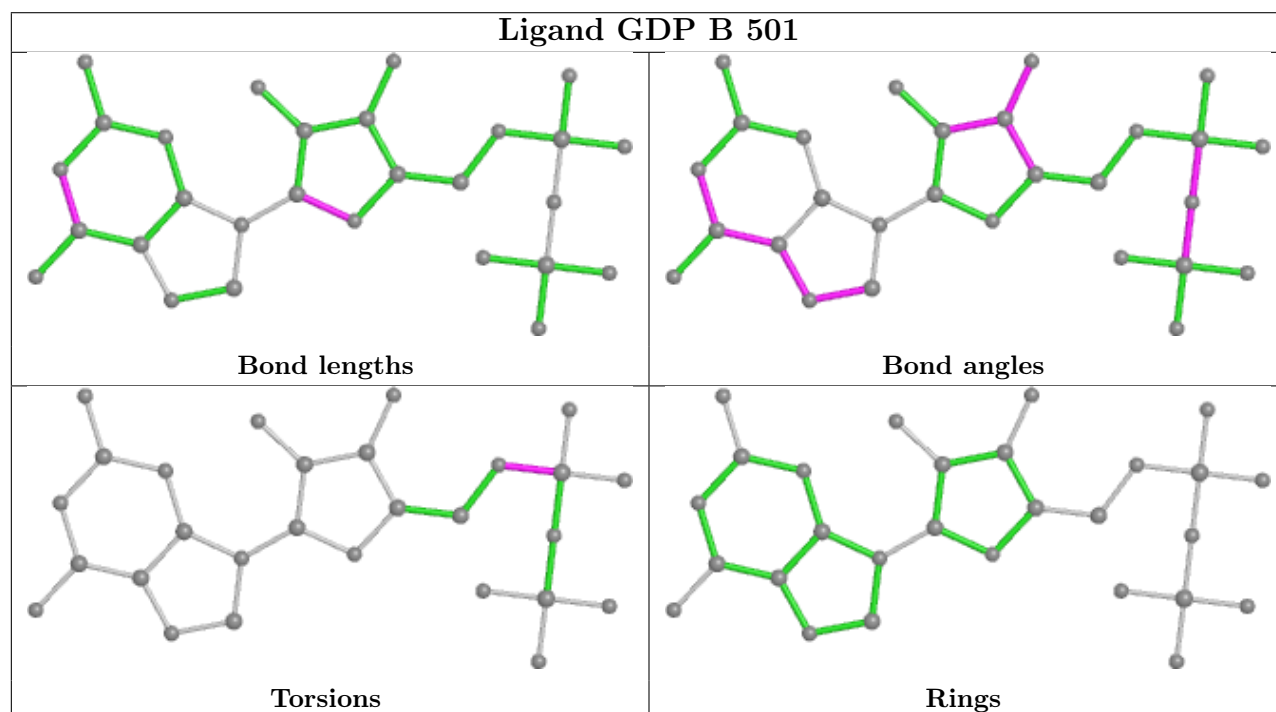
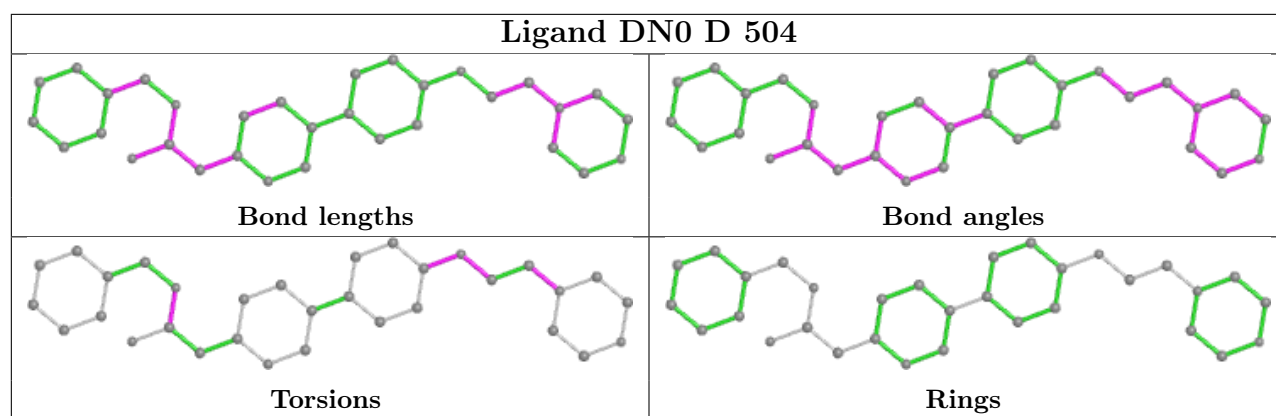

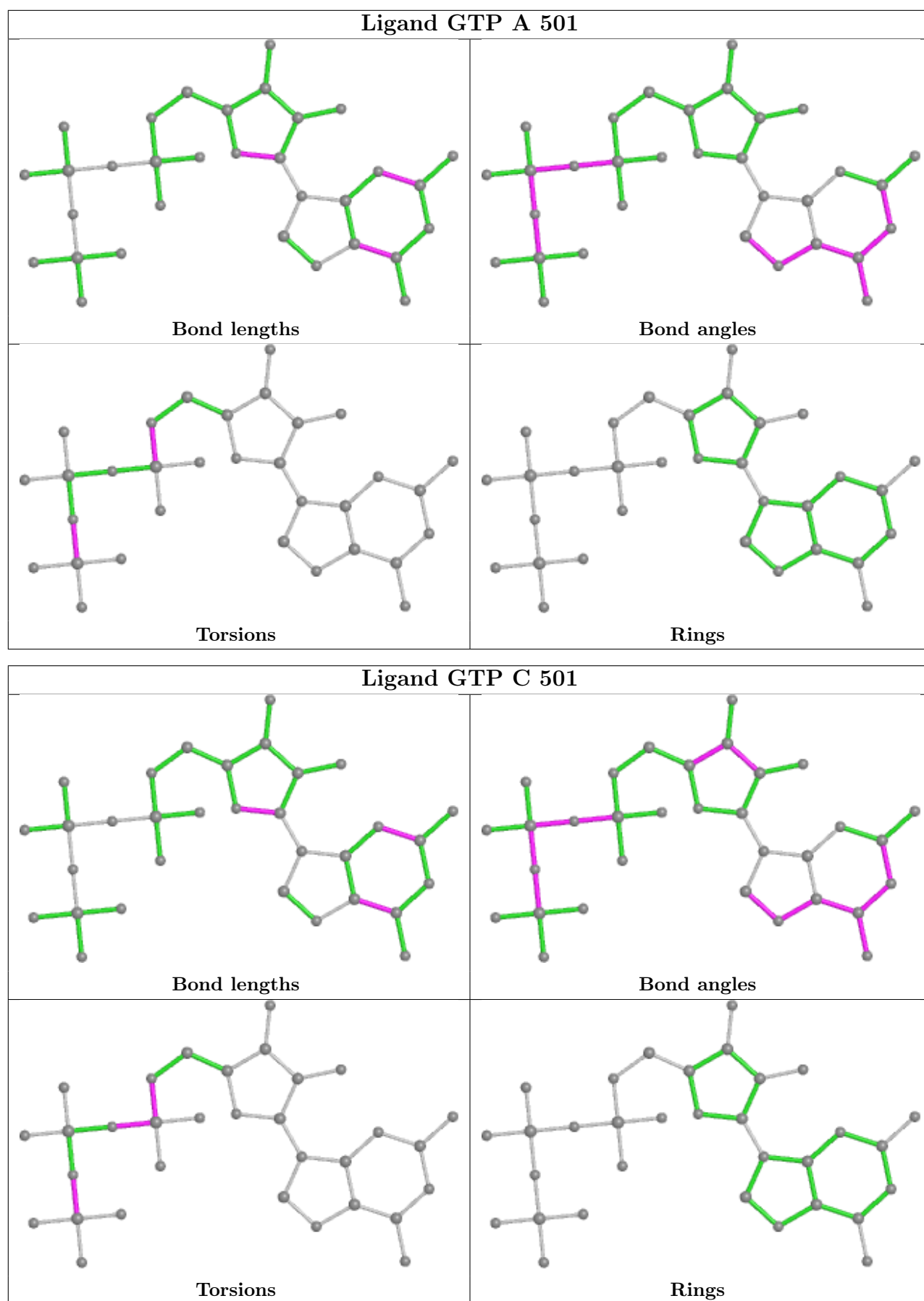

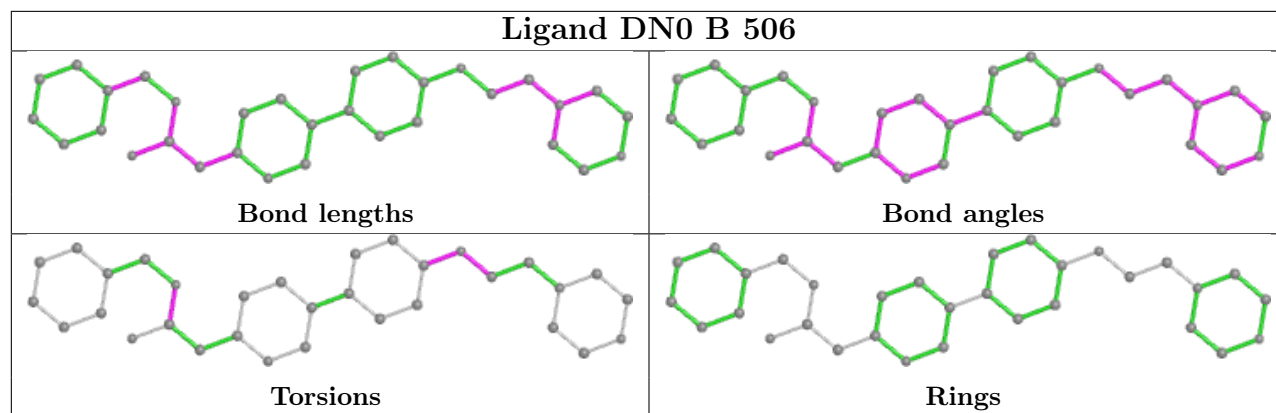

5.7 Other polymers [i](#)

There are no such residues in this entry.

5.8 Polymer linkage issues [i](#)

There are no chain breaks in this entry.

6 Fit of model and data [i](#)

6.1 Protein, DNA and RNA chains [i](#)

In the following table, the column labelled ‘#RSRZ > 2’ contains the number (and percentage) of RSRZ outliers, followed by percent RSRZ outliers for the chain as percentile scores relative to all X-ray entries and entries of similar resolution. The OWAB column contains the minimum, median, 95th percentile and maximum values of the occupancy-weighted average B-factor per residue. The column labelled ‘Q < 0.9’ lists the number of (and percentage) of residues with an average occupancy less than 0.9.

Mol	Chain	Analysed	<RSRZ>	#RSRZ>2	OWAB(Å ²)	Q<0.9
1	A	438/450 (97%)	0.49	36 (8%) 11 11	36, 59, 83, 120	0
1	C	440/450 (97%)	0.25	24 (5%) 25 26	33, 49, 69, 80	0
2	B	425/445 (95%)	0.66	45 (10%) 6 5	34, 59, 88, 112	0
2	D	425/445 (95%)	1.07	95 (22%) 0 0	45, 77, 96, 104	0
3	E	123/143 (86%)	1.21	26 (21%) 1 0	45, 72, 96, 111	0
4	F	349/384 (90%)	1.39	101 (28%) 0 0	47, 82, 133, 205	0
All	All	2200/2317 (94%)	0.77	327 (14%) 2 1	33, 64, 108, 205	0

The worst 5 of 327 RSRZ outliers are listed below:

Mol	Chain	Res	Type	RSRZ
4	F	157	GLY	9.6
1	A	281	ALA	8.1
4	F	253	TYR	7.5
4	F	155	ALA	6.9
4	F	177	GLY	6.8

6.2 Non-standard residues in protein, DNA, RNA chains [i](#)

There are no non-standard protein/DNA/RNA residues in this entry.

6.3 Carbohydrates [i](#)

There are no monosaccharides in this entry.

6.4 Ligands

In the following table, the Atoms column lists the number of modelled atoms in the group and the number defined in the chemical component dictionary. The B-factors column lists the minimum, median, 95th percentile and maximum values of B factors of atoms in the group. The column labelled 'Q<0.9' lists the number of atoms with occupancy less than 0.9.

Mol	Type	Chain	Res	Atoms	RSCC	RSR	B-factors(Å ²)	Q<0.9
7	CA	D	502	1/1	0.65	0.53	100,100,100,100	0
7	CA	E	201	1/1	0.66	0.16	83,83,83,83	0
7	CA	B	505	1/1	0.71	0.08	93,93,93,93	0
11	ACP	F	402	31/31	0.77	0.28	99,114,133,139	0
10	DN0	D	504	32/32	0.81	0.28	61,74,89,92	0
10	DN0	B	506	32/32	0.81	0.24	50,65,90,108	0
7	CA	B	504	1/1	0.83	0.10	101,101,101,101	0
6	MG	F	401	1/1	0.89	0.14	98,98,98,98	0
9	MES	B	503	12/12	0.92	0.17	50,62,76,79	0
5	GTP	D	503	32/32	0.92	0.18	67,76,89,94	0
9	MES	B	507	12/12	0.93	0.28	72,85,94,98	0
6	MG	B	502	1/1	0.94	0.08	39,39,39,39	0
6	MG	D	501	1/1	0.94	0.11	74,74,74,74	0
8	GDP	B	501	28/28	0.95	0.19	39,47,67,77	0
6	MG	C	502	1/1	0.95	0.08	42,42,42,42	0
5	GTP	C	501	32/32	0.97	0.17	30,43,55,57	0
7	CA	A	503	1/1	0.97	0.03	72,72,72,72	0
5	GTP	A	501	32/32	0.97	0.16	28,49,60,66	0
6	MG	A	502	1/1	0.97	0.10	40,40,40,40	0
7	CA	C	503	1/1	0.98	0.08	65,65,65,65	0

The following is a graphical depiction of the model fit to experimental electron density of all instances of the Ligand of Interest. In addition, ligands with molecular weight > 250 and outliers as shown on the geometry validation Tables will also be included. Each fit is shown from different orientation to approximate a three-dimensional view.

Electron density around ACP F 402:

$2mF_o-DF_c$ (at 0.7 rmsd) in gray
 mF_o-DF_c (at 3 rmsd) in purple (negative)
and green (positive)

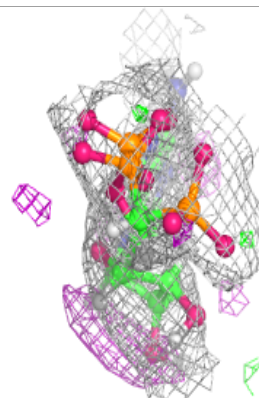
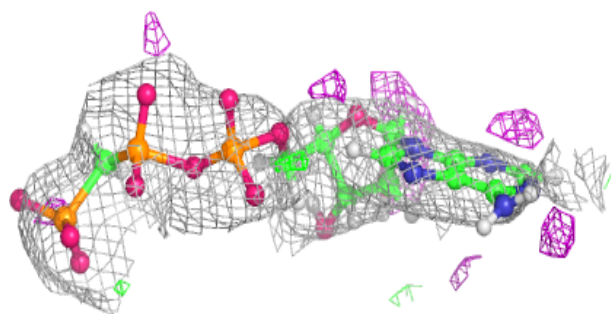
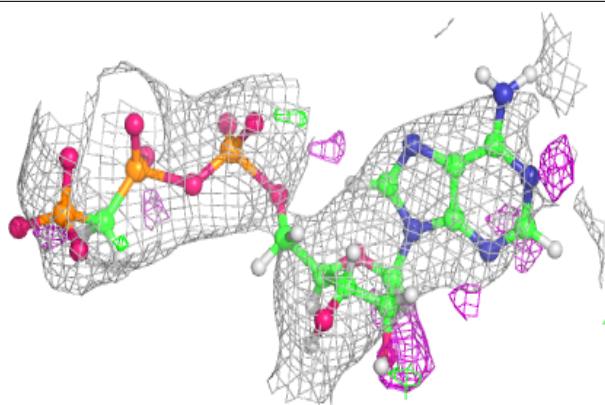
**Electron density around DN0 D 504:**

$2mF_o-DF_c$ (at 0.7 rmsd) in gray
 mF_o-DF_c (at 3 rmsd) in purple (negative)
and green (positive)

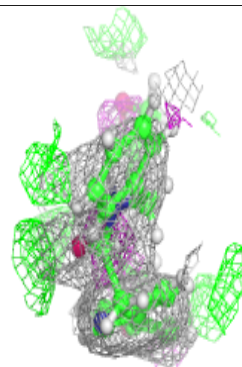
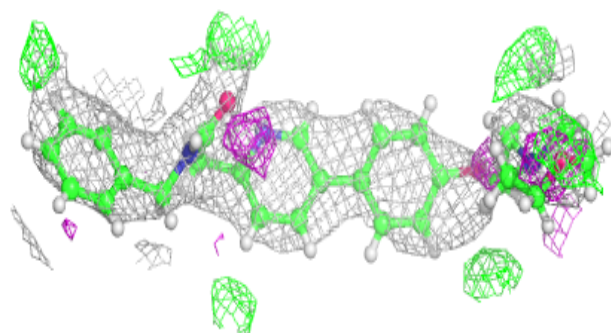
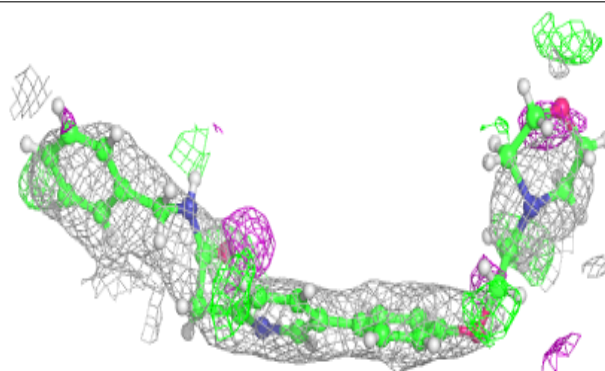

Electron density around DN0 B 506:

$2mF_o-DF_c$ (at 0.7 rmsd) in gray
 mF_o-DF_c (at 3 rmsd) in purple (negative)
and green (positive)

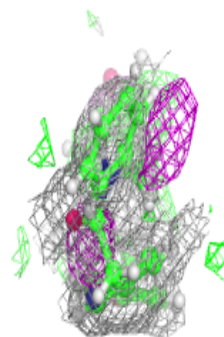
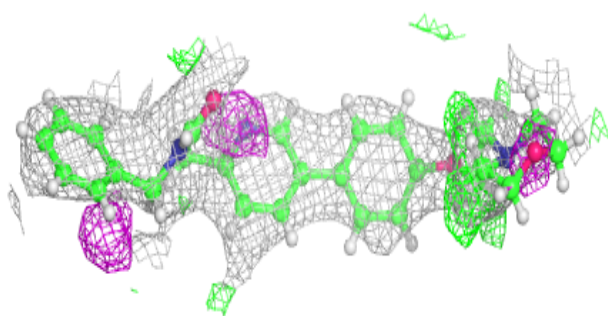
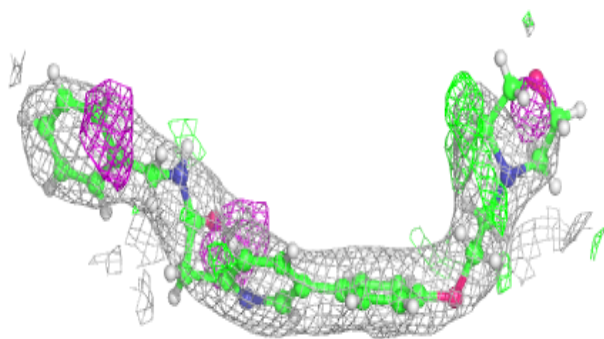
**Electron density around GTP D 503:**

$2mF_o-DF_c$ (at 0.7 rmsd) in gray
 mF_o-DF_c (at 3 rmsd) in purple (negative)
and green (positive)

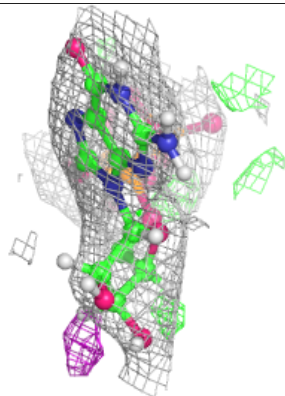
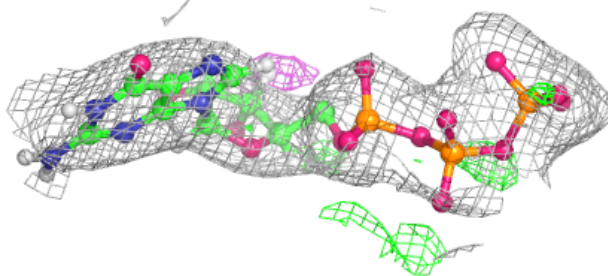
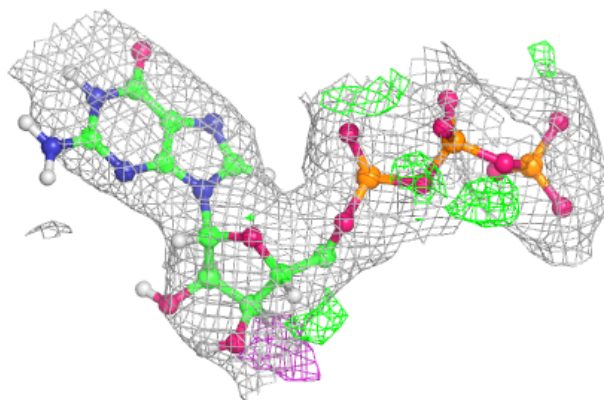

Electron density around GDP B 501:

$2mF_o-DF_c$ (at 0.7 rmsd) in gray
 mF_o-DF_c (at 3 rmsd) in purple (negative)
and green (positive)

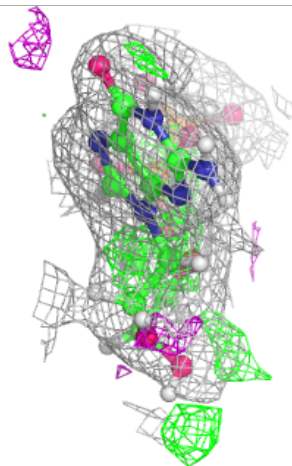
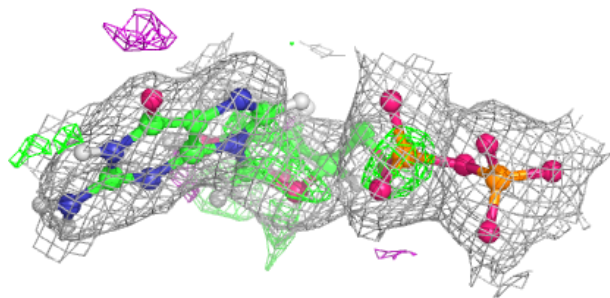
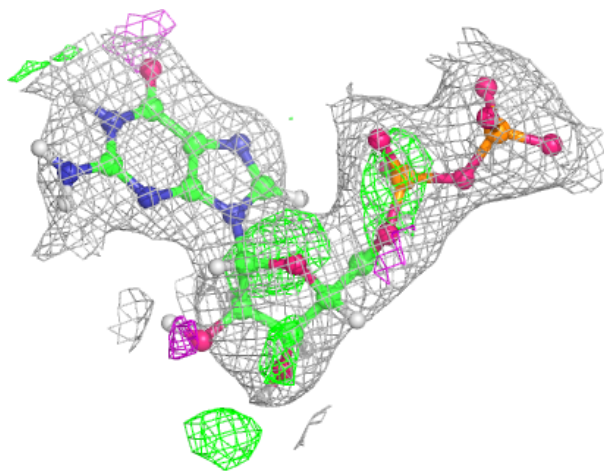

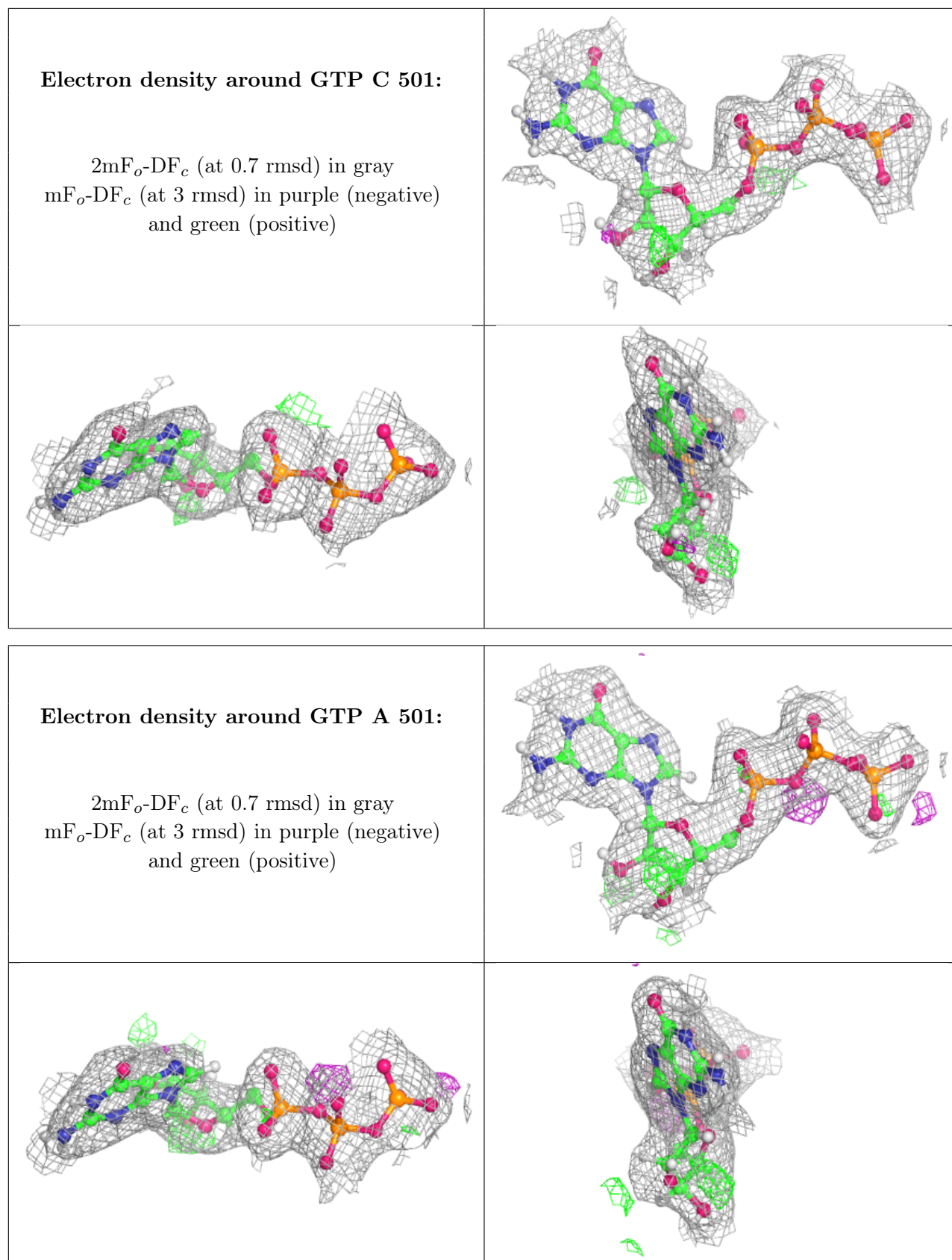

6.5 Other polymers [i](#)

There are no such residues in this entry.