



wwPDB X-ray Structure Validation Summary Report ⓘ

Nov 16, 2023 – 01:33 AM JST

PDB ID : 6KDE
Title : Crystal structure of the alpha beta heterodimer of human IDH3 in complex with Ca(2+)
Authors : Sun, P.; Ding, J.
Deposited on : 2019-07-02
Resolution : 3.00 Å(reported)

This is a wwPDB X-ray Structure Validation Summary Report for a publicly released PDB entry.

We welcome your comments at validation@mail.wwpdb.org

A user guide is available at

<https://www.wwpdb.org/validation/2017/XrayValidationReportHelp>

with specific help available everywhere you see the ⓘ symbol.

The types of validation reports are described at

<http://www.wwpdb.org/validation/2017/FAQs#types>.

The following versions of software and data (see [references ⓘ](#)) were used in the production of this report:

MolProbity : 4.02b-467
Xtrriage (Phenix) : 1.13
EDS : 2.36
buster-report : 1.1.7 (2018)
Percentile statistics : 20191225.v01 (using entries in the PDB archive December 25th 2019)
Refmac : 5.8.0158
CCP4 : 7.0.044 (Gargrove)
Ideal geometry (proteins) : Engh & Huber (2001)
Ideal geometry (DNA, RNA) : Parkinson et al. (1996)
Validation Pipeline (wwPDB-VP) : 2.36

1 Overall quality at a glance

The following experimental techniques were used to determine the structure:

X-RAY DIFFRACTION

The reported resolution of this entry is 3.00 Å.

Percentile scores (ranging between 0-100) for global validation metrics of the entry are shown in the following graphic. The table shows the number of entries on which the scores are based.

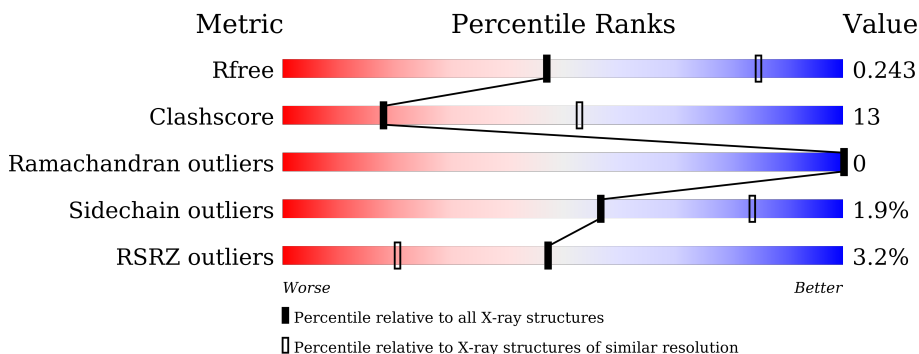

Metric	Whole archive (#Entries)	Similar resolution (#Entries, resolution range(Å))
R_{free}	130704	2092 (3.00-3.00)
Clashscore	141614	2416 (3.00-3.00)
Ramachandran outliers	138981	2333 (3.00-3.00)
Sidechain outliers	138945	2336 (3.00-3.00)
RSRZ outliers	127900	1990 (3.00-3.00)

The table below summarises the geometric issues observed across the polymeric chains and their fit to the electron density. The red, orange, yellow and green segments of the lower bar indicate the fraction of residues that contain outliers for ≥ 3 , 2, 1 and 0 types of geometric quality criteria respectively. A grey segment represents the fraction of residues that are not modelled. The numeric value for each fraction is indicated below the corresponding segment, with a dot representing fractions $\leq 5\%$. The upper red bar (where present) indicates the fraction of residues that have poor fit to the electron density. The numeric value is given above the bar.

Mol	Chain	Length	Quality of chain
1	A	341	 4% 70% 28% ..
1	C	341	 5% 66% 32% ..
2	B	356	 2% 64% 24% 11%
2	D	356	 2% 64% 24% • 11%

2 Entry composition

There are 3 unique types of molecules in this entry. The entry contains 9632 atoms, of which 0 are hydrogens and 0 are deuteriums.

In the tables below, the ZeroOcc column contains the number of atoms modelled with zero occupancy, the AltConf column contains the number of residues with at least one atom in alternate conformation and the Trace column contains the number of residues modelled with at most 2 atoms.

- Molecule 1 is a protein called Isocitrate dehydrogenase [NAD] subunit alpha, mitochondrial.

Mol	Chain	Residues	Atoms					ZeroOcc	AltConf	Trace
			Total	C	N	O	S			
1	A	336	Total	C	N	O	S	0	0	0
			2468	1549	421	476	22			
1	C	336	Total	C	N	O	S	0	0	0
			2475	1552	421	480	22			

There are 4 discrepancies between the modelled and reference sequences:

Chain	Residue	Modelled	Actual	Comment	Reference
A	-1	GLY	-	expression tag	UNP P50213
A	0	SER	-	expression tag	UNP P50213
C	-1	GLY	-	expression tag	UNP P50213
C	0	SER	-	expression tag	UNP P50213

- Molecule 2 is a protein called Isocitrate dehydrogenase [NAD] subunit beta, mitochondrial.

Mol	Chain	Residues	Atoms					ZeroOcc	AltConf	Trace
			Total	C	N	O	S			
2	B	316	Total	C	N	O	S	0	0	0
			2339	1480	405	435	19			
2	D	316	Total	C	N	O	S	0	0	0
			2348	1484	404	441	19			

There are 32 discrepancies between the modelled and reference sequences:

Chain	Residue	Modelled	Actual	Comment	Reference
B	341	GLU	-	expression tag	UNP O43837
B	342	ILE	-	expression tag	UNP O43837
B	343	CYS	-	expression tag	UNP O43837
B	344	ARG	-	expression tag	UNP O43837
B	345	ARG	-	expression tag	UNP O43837
B	346	VAL	-	expression tag	UNP O43837
B	347	LYS	-	expression tag	UNP O43837
B	348	ASP	-	expression tag	UNP O43837

Continued on next page...

Continued from previous page...

Chain	Residue	Modelled	Actual	Comment	Reference
B	349	LEU	-	expression tag	UNP O43837
B	350	ASP	-	expression tag	UNP O43837
B	351	GLU	-	expression tag	UNP O43837
B	352	ASN	-	expression tag	UNP O43837
B	353	LEU	-	expression tag	UNP O43837
B	354	TYR	-	expression tag	UNP O43837
B	355	PHE	-	expression tag	UNP O43837
B	356	GLN	-	expression tag	UNP O43837
D	341	GLU	-	expression tag	UNP O43837
D	342	ILE	-	expression tag	UNP O43837
D	343	CYS	-	expression tag	UNP O43837
D	344	ARG	-	expression tag	UNP O43837
D	345	ARG	-	expression tag	UNP O43837
D	346	VAL	-	expression tag	UNP O43837
D	347	LYS	-	expression tag	UNP O43837
D	348	ASP	-	expression tag	UNP O43837
D	349	LEU	-	expression tag	UNP O43837
D	350	ASP	-	expression tag	UNP O43837
D	351	GLU	-	expression tag	UNP O43837
D	352	ASN	-	expression tag	UNP O43837
D	353	LEU	-	expression tag	UNP O43837
D	354	TYR	-	expression tag	UNP O43837
D	355	PHE	-	expression tag	UNP O43837
D	356	GLN	-	expression tag	UNP O43837

- Molecule 3 is CALCIUM ION (three-letter code: CA) (formula: Ca) (labeled as "Ligand of Interest" by depositor).

Mol	Chain	Residues	Atoms	ZeroOcc	AltConf
3	A	1	Total Ca 1 1	0	0
3	C	1	Total Ca 1 1	0	0

3 Residue-property plots i

These plots are drawn for all protein, RNA, DNA and oligosaccharide chains in the entry. The first graphic for a chain summarises the proportions of the various outlier classes displayed in the second graphic. The second graphic shows the sequence view annotated by issues in geometry and electron density. Residues are color-coded according to the number of geometric quality criteria for which they contain at least one outlier: green = 0, yellow = 1, orange = 2 and red = 3 or more. A red dot above a residue indicates a poor fit to the electron density ($RSRZ > 2$). Stretches of 2 or more consecutive residues without any outlier are shown as a green connector. Residues present in the sample, but not in the model, are shown in grey.

- Molecule 1: Isocitrate dehydrogenase [NAD] subunit alpha, mitochondrial

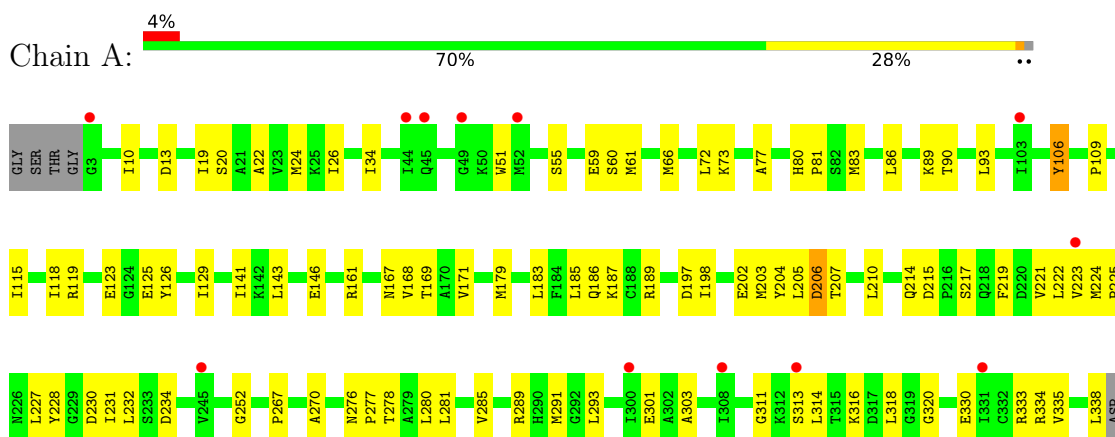

- Molecule 1: Isocitrate dehydrogenase [NAD] subunit alpha, mitochondrial



- Molecule 2: Isocitrate dehydrogenase [NAD] subunit beta, mitochondrial

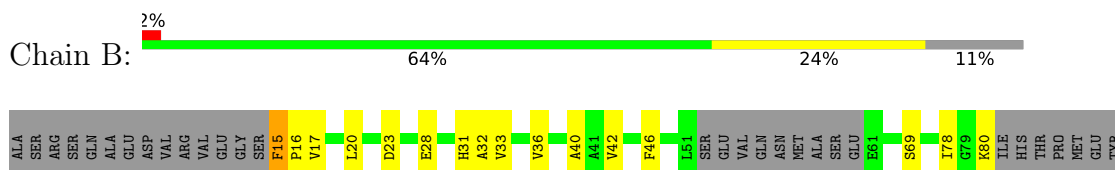

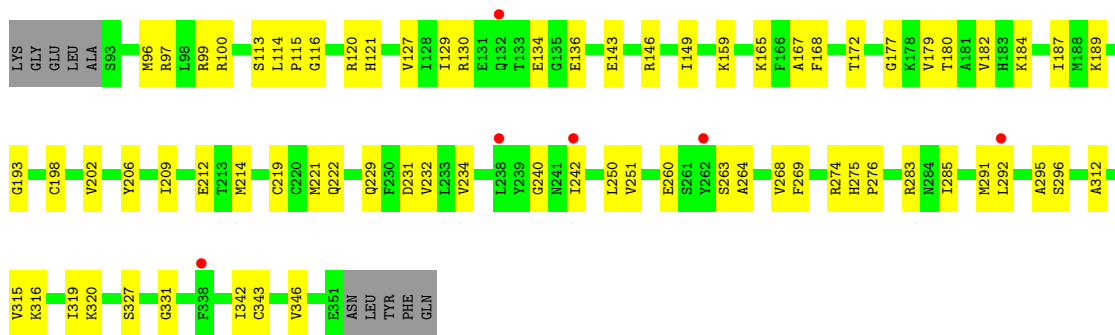

• Molecule 2: Isocitrate dehydrogenase [NAD] subunit beta, mitochondrial

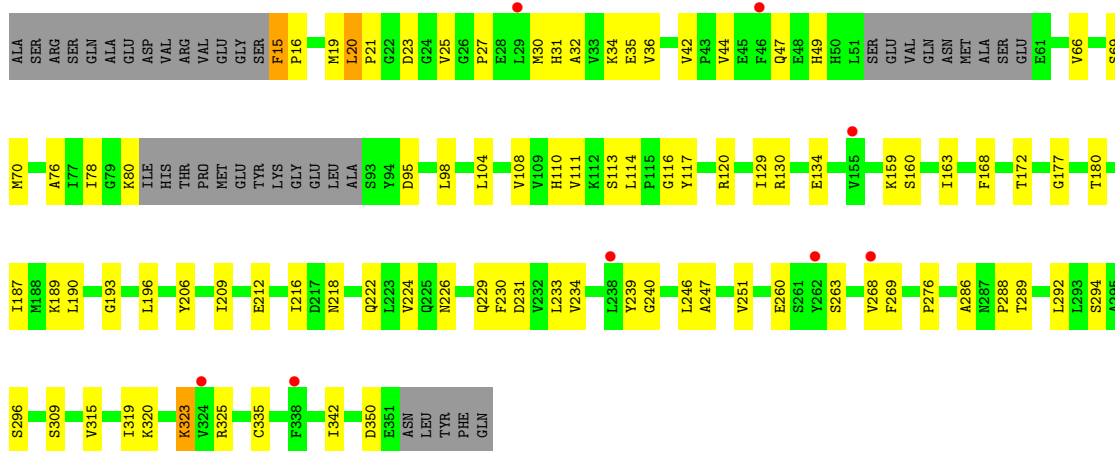

4 Data and refinement statistics

Property	Value	Source
Space group	I 4	Depositor
Cell constants a, b, c, α , β , γ	166.20Å 166.20Å 128.13Å 90.00° 90.00° 90.00°	Depositor
Resolution (Å)	41.37 – 3.00 43.37 – 3.00	Depositor EDS
% Data completeness (in resolution range)	99.3 (41.37-3.00) 99.3 (43.37-3.00)	Depositor EDS
R_{merge}	0.06	Depositor
R_{sym}	(Not available)	Depositor
$\langle I/\sigma(I) \rangle$ ¹	2.05 (at 3.01Å)	Xtrriage
Refinement program	PHENIX 1.14_3260	Depositor
R, R_{free}	0.194 , 0.243 0.194 , 0.243	Depositor DCC
R_{free} test set	1708 reflections (4.92%)	wwPDB-VP
Wilson B-factor (Å ²)	77.8	Xtrriage
Anisotropy	0.256	Xtrriage
Bulk solvent k_{sol} (e/Å ³), B_{sol} (Å ²)	0.32 , 40.5	EDS
L-test for twinning ²	$\langle L \rangle = 0.50$, $\langle L^2 \rangle = 0.33$	Xtrriage
Estimated twinning fraction	0.470 for -k,-h,-l	Xtrriage
F_o, F_c correlation	0.94	EDS
Total number of atoms	9632	wwPDB-VP
Average B, all atoms (Å ²)	75.0	wwPDB-VP

Xtrriage's analysis on translational NCS is as follows: *The largest off-origin peak in the Patterson function is 8.62% of the height of the origin peak. No significant pseudotranslation is detected.*

¹Intensities estimated from amplitudes.

²Theoretical values of $\langle |L| \rangle$, $\langle L^2 \rangle$ for acentric reflections are 0.5, 0.333 respectively for untwinned datasets, and 0.375, 0.2 for perfectly twinned datasets.

5 Model quality [i](#)

5.1 Standard geometry [i](#)

Bond lengths and bond angles in the following residue types are not validated in this section:
CA

The Z score for a bond length (or angle) is the number of standard deviations the observed value is removed from the expected value. A bond length (or angle) with $|Z| > 5$ is considered an outlier worth inspection. RMSZ is the root-mean-square of all Z scores of the bond lengths (or angles).

Mol	Chain	Bond lengths		Bond angles	
		RMSZ	# Z >5	RMSZ	# Z >5
1	A	0.49	0/2510	0.62	0/3411
1	C	0.47	0/2517	0.63	0/3420
2	B	0.44	0/2380	0.61	0/3227
2	D	0.47	1/2388 (0.0%)	0.63	0/3236
All	All	0.47	1/9795 (0.0%)	0.62	0/13294

All (1) bond length outliers are listed below:

Mol	Chain	Res	Type	Atoms	Z	Observed(Å)	Ideal(Å)
2	D	323	LYS	CE-NZ	-5.50	1.35	1.49

There are no bond angle outliers.

There are no chirality outliers.

There are no planarity outliers.

5.2 Too-close contacts [i](#)

In the following table, the Non-H and H(model) columns list the number of non-hydrogen atoms and hydrogen atoms in the chain respectively. The H(added) column lists the number of hydrogen atoms added and optimized by MolProbity. The Clashes column lists the number of clashes within the asymmetric unit, whereas Symm-Clashes lists symmetry-related clashes.

Mol	Chain	Non-H	H(model)	H(added)	Clashes	Symm-Clashes
1	A	2468	0	2394	68	1
1	C	2475	0	2399	81	1
2	B	2339	0	2240	63	0
2	D	2348	0	2258	66	1
3	A	1	0	0	0	0
3	C	1	0	0	0	0

Continued on next page...

Continued from previous page...

Mol	Chain	Non-H	H(model)	H(added)	Clashes	Symm-Clashes
All	All	9632	0	9291	255	2

The all-atom clashscore is defined as the number of clashes found per 1000 atoms (including hydrogen atoms). The all-atom clashscore for this structure is 13.

The worst 5 of 255 close contacts within the same asymmetric unit are listed below, sorted by their clash magnitude.

Atom-1	Atom-2	Interatomic distance (Å)	Clash overlap (Å)
2:D:20:LEU:CD2	2:D:78:ILE:HG22	1.78	1.12
2:D:20:LEU:HD21	2:D:78:ILE:HG22	1.21	1.11
2:D:20:LEU:HD21	2:D:78:ILE:CG2	1.86	1.05
1:C:276:ASN:HD22	1:C:318:LEU:HD13	1.27	0.99
1:A:146:GLU:HG3	1:A:187:LYS:HE3	1.45	0.98

All (2) symmetry-related close contacts are listed below. The label for Atom-2 includes the symmetry operator and encoded unit-cell translations to be applied.

Atom-1	Atom-2	Interatomic distance (Å)	Clash overlap (Å)
1:A:161:ARG:NH1	1:C:158:GLU:OE1[2_655]	2.15	0.05
2:D:323:LYS:NZ	2:D:350:ASP:OD1[4_655]	2.16	0.04

5.3 Torsion angles [i](#)

5.3.1 Protein backbone [i](#)

In the following table, the Percentiles column shows the percent Ramachandran outliers of the chain as a percentile score with respect to all X-ray entries followed by that with respect to entries of similar resolution.

The Analysed column shows the number of residues for which the backbone conformation was analysed, and the total number of residues.

Mol	Chain	Analysed	Favoured	Allowed	Outliers	Percentiles	
1	A	334/341 (98%)	315 (94%)	19 (6%)	0	100	100
1	C	334/341 (98%)	316 (95%)	18 (5%)	0	100	100
2	B	310/356 (87%)	286 (92%)	24 (8%)	0	100	100
2	D	310/356 (87%)	280 (90%)	30 (10%)	0	100	100
All	All	1288/1394 (92%)	1197 (93%)	91 (7%)	0	100	100

There are no Ramachandran outliers to report.

5.3.2 Protein sidechains [i](#)

In the following table, the Percentiles column shows the percent sidechain outliers of the chain as a percentile score with respect to all X-ray entries followed by that with respect to entries of similar resolution.

The Analysed column shows the number of residues for which the sidechain conformation was analysed, and the total number of residues.

Mol	Chain	Analysed	Rotameric	Outliers	Percentiles	
1	A	256/278 (92%)	252 (98%)	4 (2%)	62	86
1	C	258/278 (93%)	254 (98%)	4 (2%)	62	86
2	B	235/300 (78%)	231 (98%)	4 (2%)	60	85
2	D	239/300 (80%)	232 (97%)	7 (3%)	42	76
All	All	988/1156 (86%)	969 (98%)	19 (2%)	57	84

5 of 19 residues with a non-rotameric sidechain are listed below:

Mol	Chain	Res	Type
2	D	117	TYR
2	D	296	SER
2	D	309	SER
2	D	294	SER
1	C	40	ASN

Sometimes sidechains can be flipped to improve hydrogen bonding and reduce clashes. All (5) such sidechains are listed below:

Mol	Chain	Res	Type
2	B	107	ASN
2	B	229	GLN
2	D	31	HIS
2	D	222	GLN
2	D	225	GLN

5.3.3 RNA [i](#)

There are no RNA molecules in this entry.

5.4 Non-standard residues in protein, DNA, RNA chains [i](#)

There are no non-standard protein/DNA/RNA residues in this entry.

5.5 Carbohydrates [i](#)

There are no monosaccharides in this entry.

5.6 Ligand geometry [i](#)

Of 2 ligands modelled in this entry, 2 are monoatomic - leaving 0 for Mogul analysis.

There are no bond length outliers.

There are no bond angle outliers.

There are no chirality outliers.

There are no torsion outliers.

There are no ring outliers.

No monomer is involved in short contacts.

5.7 Other polymers [i](#)

There are no such residues in this entry.

5.8 Polymer linkage issues [i](#)

There are no chain breaks in this entry.

6 Fit of model and data [i](#)

6.1 Protein, DNA and RNA chains [i](#)

In the following table, the column labelled ‘#RSRZ > 2’ contains the number (and percentage) of RSRZ outliers, followed by percent RSRZ outliers for the chain as percentile scores relative to all X-ray entries and entries of similar resolution. The OWAB column contains the minimum, median, 95th percentile and maximum values of the occupancy-weighted average B-factor per residue. The column labelled ‘Q < 0.9’ lists the number of (and percentage) of residues with an average occupancy less than 0.9.

Mol	Chain	Analysed	<RSRZ>	#RSRZ>2	OWAB(Å ²)	Q<0.9
1	A	336/341 (98%)	0.29	12 (3%) 42 17	49, 70, 101, 133	0
1	C	336/341 (98%)	0.31	16 (4%) 30 11	48, 70, 103, 121	0
2	B	316/356 (88%)	0.20	6 (1%) 66 37	49, 74, 110, 124	0
2	D	316/356 (88%)	0.22	8 (2%) 57 29	54, 75, 109, 129	0
All	All	1304/1394 (93%)	0.25	42 (3%) 47 20	48, 72, 106, 133	0

The worst 5 of 42 RSRZ outliers are listed below:

Mol	Chain	Res	Type	RSRZ
1	C	44	ILE	4.3
1	A	308	ILE	3.6
1	A	331	ILE	3.6
1	A	300	ILE	3.5
2	B	262	TYR	3.5

6.2 Non-standard residues in protein, DNA, RNA chains [i](#)

There are no non-standard protein/DNA/RNA residues in this entry.

6.3 Carbohydrates [i](#)

There are no monosaccharides in this entry.

6.4 Ligands [i](#)

In the following table, the Atoms column lists the number of modelled atoms in the group and the number defined in the chemical component dictionary. The B-factors column lists the minimum, median, 95th percentile and maximum values of B factors of atoms in the group. The column labelled ‘Q < 0.9’ lists the number of atoms with occupancy less than 0.9.

Mol	Type	Chain	Res	Atoms	RSCC	RSR	B-factors(\AA^2)	Q<0.9
3	CA	C	401	1/1	0.84	0.30	71,71,71,71	0
3	CA	A	401	1/1	0.90	0.29	68,68,68,68	0

The following is a graphical depiction of the model fit to experimental electron density of all instances of the Ligand of Interest. In addition, ligands with molecular weight > 250 and outliers as shown on the geometry validation Tables will also be included. Each fit is shown from different orientation to approximate a three-dimensional view.

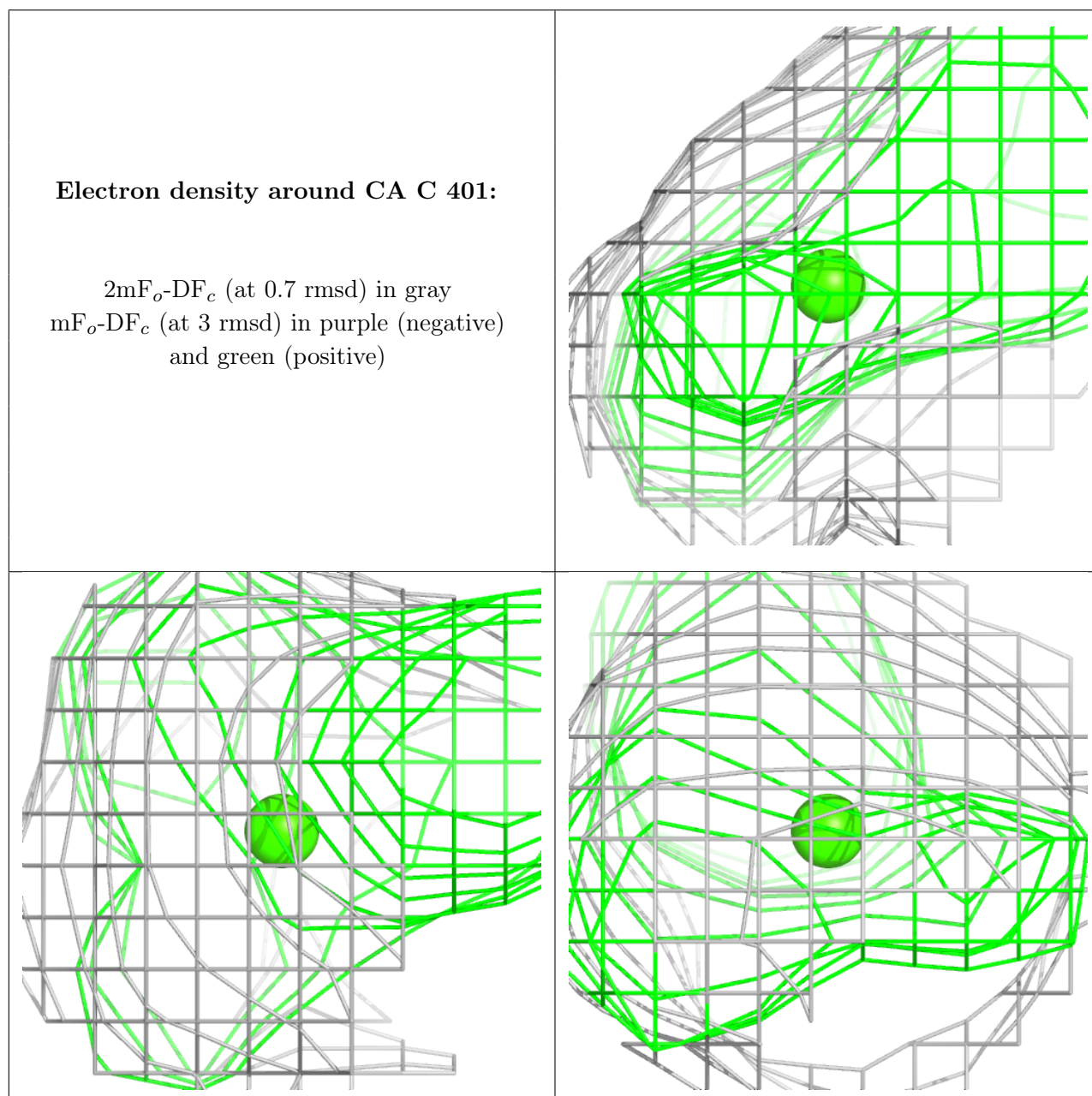

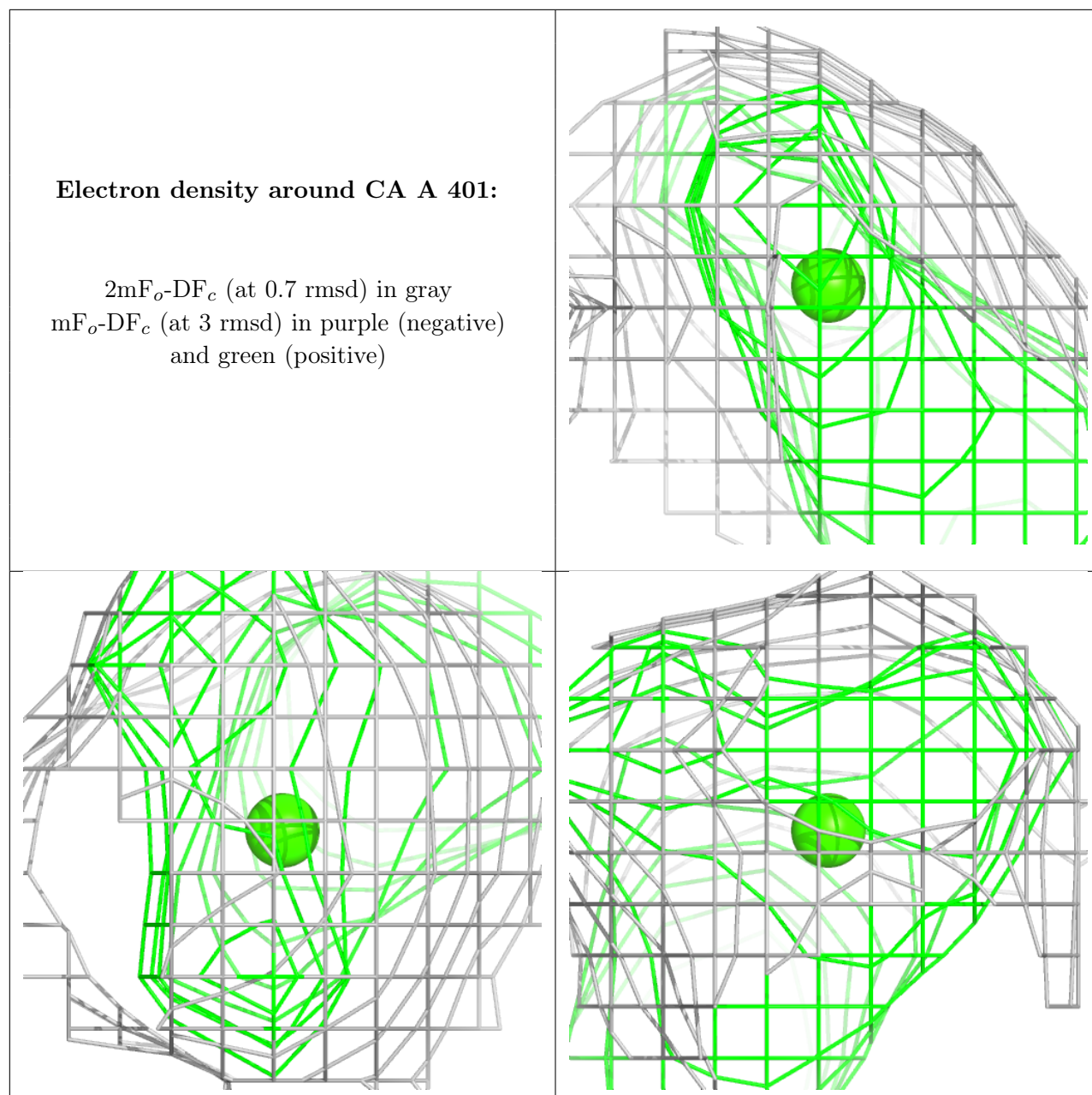

6.5 Other polymers [i](#)

There are no such residues in this entry.