



wwPDB X-ray Structure Validation Summary Report

Mar 12, 2024 – 02:28 PM JST

PDB ID : 8IR8
Title : XFEL structure of cyanobacterial photosystem II following one flash (1F) with a 1-microsecond delay
Authors : Li, H.; Suga, M.; Shen, J.R.
Deposited on : 2023-03-17
Resolution : 2.25 Å(reported)

This is a wwPDB X-ray Structure Validation Summary Report for a publicly released PDB entry.

We welcome your comments at validation@mail.wwpdb.org

A user guide is available at

<https://www.wwpdb.org/validation/2017/XrayValidationReportHelp>

with specific help available everywhere you see the  symbol.

The types of validation reports are described at

<http://www.wwpdb.org/validation/2017/FAQs#types>.

The following versions of software and data (see [references](#) ) were used in the production of this report:

MolProbity : 4.02b-467
Mogul : 1.8.5 (274361), CSD as541be (2020)
Xtriage (Phenix) : 1.13
EDS : 2.36
buster-report : 1.1.7 (2018)
Percentile statistics : 20191225.v01 (using entries in the PDB archive December 25th 2019)
Refmac : 5.8.0158
CCP4 : 7.0.044 (Gargrove)
Ideal geometry (proteins) : Engh & Huber (2001)
Ideal geometry (DNA, RNA) : Parkinson et al. (1996)
Validation Pipeline (wwPDB-VP) : 2.36

1 Overall quality at a glance

The following experimental techniques were used to determine the structure:

X-RAY DIFFRACTION

The reported resolution of this entry is 2.25 Å.

Percentile scores (ranging between 0-100) for global validation metrics of the entry are shown in the following graphic. The table shows the number of entries on which the scores are based.

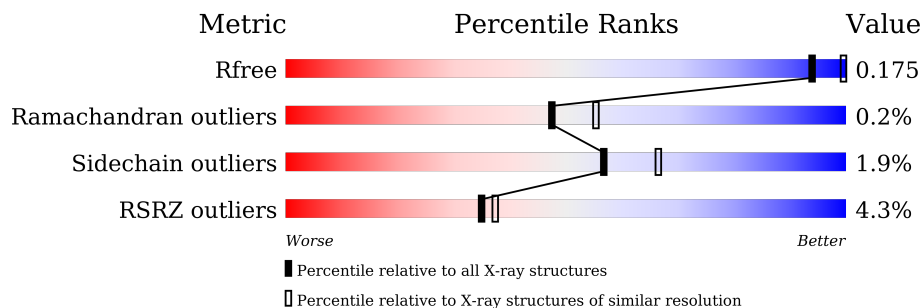

Metric	Whole archive (#Entries)	Similar resolution (#Entries, resolution range(Å))
R_{free}	130704	1377 (2.26-2.26)
Ramachandran outliers	138981	1449 (2.26-2.26)
Sidechain outliers	138945	1450 (2.26-2.26)
RSRZ outliers	127900	1356 (2.26-2.26)

The table below summarises the geometric issues observed across the polymeric chains and their fit to the electron density. The red, orange, yellow and green segments of the lower bar indicate the fraction of residues that contain outliers for ≥ 3 , 2, 1 and 0 types of geometric quality criteria respectively. A grey segment represents the fraction of residues that are not modelled. The numeric value for each fraction is indicated below the corresponding segment, with a dot representing fractions $\leq 5\%$. The upper red bar (where present) indicates the fraction of residues that have poor fit to the electron density. The numeric value is given above the bar.

Mol	Chain	Length	Quality of chain
1	A	344	 97%
1	a	344	 97%
2	B	505	 99%
2	b	505	 98%
3	C	455	 98%
3	c	455	 99%
4	D	342	 99%

Continued on next page...

Continued from previous page...

Mol	Chain	Length	Quality of chain
4	d	342	99%
5	E	84	93%
5	e	84	93% 6%
6	F	44	77% 23%
6	f	44	70% 30%
7	H	65	95%
7	h	65	94% 5%
8	I	38	92% 8%
8	i	38	95% 5%
9	J	39	95%
9	j	39	97%
10	K	37	89% 11%
10	k	37	89% 11%
11	L	37	97%
11	l	37	97%
12	M	36	86% 6% 8%
12	m	36	89% 6% 6%
13	O	244	97%
13	o	244	97%
14	T	32	88% 6% 6%
14	t	32	91% 6%
15	U	104	90% 8%
15	u	104	92% 7%
16	V	137	99%
16	v	137	96%

Continued on next page...

Continued from previous page...

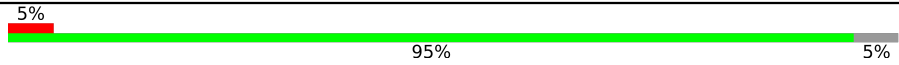
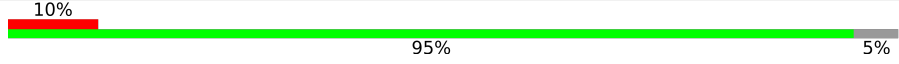
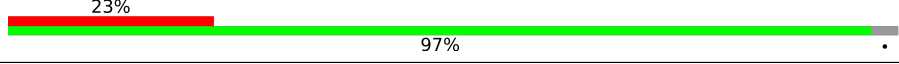
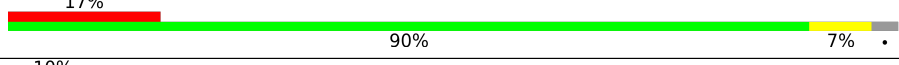
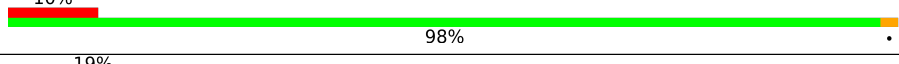
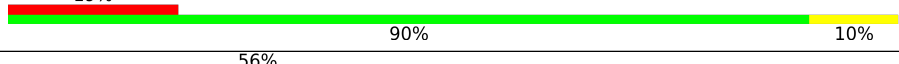
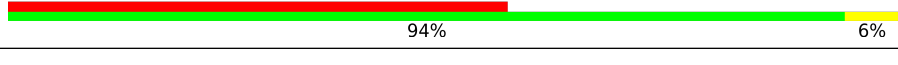
Mol	Chain	Length	Quality of chain
17	X	40	
17	x	40	
18	Y	30	
18	y	30	
19	Z	62	
19	z	62	
20	R	34	

The following table lists non-polymeric compounds, carbohydrate monomers and non-standard residues in protein, DNA, RNA chains that are outliers for geometric or electron-density-fit criteria:

Mol	Type	Chain	Res	Chirality	Geometry	Clashes	Electron density
23	CLA	A	404[A]	X	-	-	-
23	CLA	A	404[B]	X	-	-	-
23	CLA	A	405[B]	X	-	-	-
23	CLA	A	408	X	-	-	-
23	CLA	B	601	X	-	-	-
23	CLA	B	602	X	-	-	-
23	CLA	B	603	X	-	-	-
23	CLA	B	604	X	-	-	-
23	CLA	B	605	X	-	-	-
23	CLA	B	606	X	-	-	-
23	CLA	B	607	X	-	-	-
23	CLA	B	609	X	-	-	-
23	CLA	B	610	X	-	-	-
23	CLA	B	611	X	-	-	-
23	CLA	B	612	X	-	-	-
23	CLA	B	613	X	-	-	-
23	CLA	B	614	X	-	-	-
23	CLA	B	615	X	-	-	-
23	CLA	B	616	X	-	-	-
23	CLA	C	502	X	-	-	-
23	CLA	C	505	X	-	-	-
23	CLA	C	506	X	-	-	-
23	CLA	C	507	X	-	-	-
23	CLA	C	508	X	-	-	-
23	CLA	C	509	X	-	-	-

Continued on next page...

Continued from previous page...

Mol	Type	Chain	Res	Chirality	Geometry	Clashes	Electron density
23	CLA	C	510	X	-	-	-
23	CLA	C	511	X	-	-	-
23	CLA	C	512	X	-	-	-
23	CLA	C	513	X	-	-	-
23	CLA	C	514	X	-	-	-
23	CLA	D	402[A]	X	-	-	-
23	CLA	D	402[B]	X	-	-	-
23	CLA	D	403	X	-	-	-
23	CLA	a	404[A]	X	-	-	-
23	CLA	a	404[B]	X	-	-	-
23	CLA	a	407	X	-	-	-
23	CLA	b	601	X	-	-	-
23	CLA	b	602	X	-	-	-
23	CLA	b	603	X	-	-	-
23	CLA	b	604	X	-	-	-
23	CLA	b	605	X	-	-	-
23	CLA	b	606	X	-	-	-
23	CLA	b	607	X	-	-	-
23	CLA	b	609	X	-	-	-
23	CLA	b	610	X	-	-	-
23	CLA	b	611	X	-	-	-
23	CLA	b	612	X	-	-	-
23	CLA	b	613	X	-	-	-
23	CLA	b	614	X	-	-	-
23	CLA	b	615	X	-	-	-
23	CLA	b	616	X	-	-	-
23	CLA	c	503	X	-	-	-
23	CLA	c	504	X	-	-	-
23	CLA	c	505	X	-	-	-
23	CLA	c	506	X	-	-	-
23	CLA	c	507	X	-	-	-
23	CLA	c	508	X	-	-	-
23	CLA	c	509	X	-	-	-
23	CLA	c	510	X	-	-	-
23	CLA	c	511	X	-	-	-
23	CLA	c	512	X	-	-	-
23	CLA	c	513	X	-	-	-
23	CLA	c	514	X	-	-	-
23	CLA	c	515	X	-	-	-
23	CLA	d	402[A]	X	-	-	-
23	CLA	d	402[B]	X	-	-	-
23	CLA	d	403[A]	X	-	-	-

Continued on next page...

Continued from previous page...

Mol	Type	Chain	Res	Chirality	Geometry	Clashes	Electron density
23	CLA	d	403[B]	X	-	-	-
23	CLA	d	404	X	-	-	-
27	GOL	a	415	-	-	-	X
30	UNL	c	526[A]	-	-	-	X
30	UNL	c	526[B]	-	-	-	X
31	LMT	F	101	-	-	-	X
31	LMT	c	502	-	-	-	X
31	LMT	e	101	-	-	-	X
34	HTG	b	623	-	-	-	X

2 Entry composition [i](#)

There are 41 unique types of molecules in this entry. The entry contains 62674 atoms, of which 0 are hydrogens and 0 are deuteriums.

In the tables below, the ZeroOcc column contains the number of atoms modelled with zero occupancy, the AltConf column contains the number of residues with at least one atom in alternate conformation and the Trace column contains the number of residues modelled with at most 2 atoms.

- Molecule 1 is a protein called Photosystem II protein D1.

Mol	Chain	Residues	Atoms					ZeroOcc	AltConf	Trace
			Total	C	N	O	S			
1	A	334	4338	2836	717	760	25	0	222	0
1	a	334	4318	2821	715	757	25	0	220	0

There are 2 discrepancies between the modelled and reference sequences:

Chain	Residue	Modelled	Actual	Comment	Reference
A	279	PRO	ARG	conflict	UNP P51765
a	279	PRO	ARG	conflict	UNP P51765

- Molecule 2 is a protein called Photosystem II CP47 reaction center protein.

Mol	Chain	Residues	Atoms					ZeroOcc	AltConf	Trace
			Total	C	N	O	S			
2	B	504	4166	2735	694	724	13	0	22	0
2	b	504	4134	2718	687	716	13	0	19	0

- Molecule 3 is a protein called Photosystem II CP43 reaction center protein.

Mol	Chain	Residues	Atoms					ZeroOcc	AltConf	Trace
			Total	C	N	O	S			
3	C	451	4272	2796	715	743	18	0	99	0
3	c	455	4316	2827	720	751	18	0	101	0

There are 8 discrepancies between the modelled and reference sequences:

Chain	Residue	Modelled	Actual	Comment	Reference
C	19	ASN	-	expression tag	UNP D0VWR7
C	20	SER	-	expression tag	UNP D0VWR7

Continued on next page...

Continued from previous page...

Chain	Residue	Modelled	Actual	Comment	Reference
C	21	ILE	-	expression tag	UNP D0VWR7
C	22	PHE	-	expression tag	UNP D0VWR7
c	19	ASN	-	expression tag	UNP D0VWR7
c	20	SER	-	expression tag	UNP D0VWR7
c	21	ILE	-	expression tag	UNP D0VWR7
c	22	PHE	-	expression tag	UNP D0VWR7

- Molecule 4 is a protein called Photosystem II D2 protein.

Mol	Chain	Residues	Atoms					ZeroOcc	AltConf	Trace
4	D	342	Total	C	N	O	S	0	115	0
			3625	2390	597	623	15			
4	d	341	Total	C	N	O	S	0	119	0
			3658	2412	605	626	15			

- Molecule 5 is a protein called Cytochrome b559 subunit alpha.

Mol	Chain	Residues	Atoms				ZeroOcc	AltConf	Trace
5	E	81	Total	C	N	O	0	0	0
			662	432	107	123			
5	e	79	Total	C	N	O	0	2	0
			670	439	110	121			

- Molecule 6 is a protein called Cytochrome b559 subunit beta.

Mol	Chain	Residues	Atoms					ZeroOcc	AltConf	Trace
6	F	34	Total	C	N	O	S	0	0	0
			275	187	45	42	1			
6	f	31	Total	C	N	O	S	0	1	0
			261	179	43	38	1			

- Molecule 7 is a protein called Photosystem II reaction center protein H.

Mol	Chain	Residues	Atoms					ZeroOcc	AltConf	Trace
7	H	64	Total	C	N	O	S	0	0	0
			506	339	81	84	2			
7	h	64	Total	C	N	O	S	0	1	0
			517	345	85	85	2			

- Molecule 8 is a protein called Photosystem II reaction center protein I.

Mol	Chain	Residues	Atoms					ZeroOcc	AltConf	Trace
8	I	38	Total	C	N	O	S	0	0	0
			314	211	48	54	1			
8	i	38	Total	C	N	O	S	0	0	0
			314	211	48	54	1			

- Molecule 9 is a protein called Photosystem II reaction center protein J.

Mol	Chain	Residues	Atoms					ZeroOcc	AltConf	Trace
9	J	38	Total	C	N	O	S	0	0	0
			272	182	42	47	1			
9	j	39	Total	C	N	O	S	0	0	0
			277	185	43	48	1			

- Molecule 10 is a protein called Photosystem II reaction center protein K.

Mol	Chain	Residues	Atoms				ZeroOcc	AltConf	Trace
10	K	37	Total	C	N	O	0	0	0
			293	204	43	46			
10	k	37	Total	C	N	O	0	0	0
			293	204	43	46			

There are 4 discrepancies between the modelled and reference sequences:

Chain	Residue	Modelled	Actual	Comment	Reference
K	33	LEU	PHE	conflict	UNP P19054
K	39	TRP	VAL	conflict	UNP P19054
k	33	LEU	PHE	conflict	UNP P19054
k	39	TRP	VAL	conflict	UNP P19054

- Molecule 11 is a protein called Photosystem II reaction center protein L.

Mol	Chain	Residues	Atoms				ZeroOcc	AltConf	Trace
11	L	36	Total	C	N	O	0	2	0
			311	207	49	55			
11	l	36	Total	C	N	O	0	2	0
			311	207	49	55			

- Molecule 12 is a protein called Photosystem II reaction center protein M.

Mol	Chain	Residues	Atoms					ZeroOcc	AltConf	Trace
12	M	33	Total	C	N	O	S	0	1	0
			268	179	39	49	1			

Continued on next page...

Continued from previous page...

Mol	Chain	Residues	Atoms					ZeroOcc	AltConf	Trace
12	m	34	Total	C	N	O	S	0	2	0
			286	190	43	52	1			

There are 2 discrepancies between the modelled and reference sequences:

Chain	Residue	Modelled	Actual	Comment	Reference
M	8	LEU	PHE	conflict	UNP P12312
m	8	LEU	PHE	conflict	UNP P12312

- Molecule 13 is a protein called Photosystem II manganese-stabilizing polypeptide.

Mol	Chain	Residues	Atoms					ZeroOcc	AltConf	Trace
13	O	243	Total	C	N	O	S	0	10	0
			1958	1221	335	398	4			
13	o	243	Total	C	N	O	S	0	8	0
			1933	1207	330	392	4			

- Molecule 14 is a protein called Photosystem II reaction center protein T.

Mol	Chain	Residues	Atoms					ZeroOcc	AltConf	Trace
14	T	30	Total	C	N	O	S	0	6	0
			311	213	48	48	2			
14	t	30	Total	C	N	O	S	0	5	0
			302	208	47	45	2			

- Molecule 15 is a protein called Photosystem II 12 kDa extrinsic protein.

Mol	Chain	Residues	Atoms				ZeroOcc	AltConf	Trace
15	U	96	Total	C	N	O	0	4	0
			800	508	133	159			
15	u	97	Total	C	N	O	0	5	0
			815	519	135	161			

- Molecule 16 is a protein called Cytochrome c-550.

Mol	Chain	Residues	Atoms					ZeroOcc	AltConf	Trace
16	V	137	Total	C	N	O	S	0	6	0
			1120	711	185	220	4			
16	v	137	Total	C	N	O	S	0	6	0
			1117	712	185	216	4			

- Molecule 17 is a protein called Photosystem II reaction center protein X.

Mol	Chain	Residues	Atoms				ZeroOcc	AltConf	Trace
17	X	38	Total	C	N	O	0	1	0
			289	194	46	49			
17	x	38	Total	C	N	O	0	0	0
			281	188	45	48			

- Molecule 18 is a protein called Photosystem II reaction center protein Ycf12.

Mol	Chain	Residues	Atoms					ZeroOcc	AltConf	Trace
18	Y	29	Total	C	N	O	S	0	0	0
			215	142	37	33	3			
18	y	29	Total	C	N	O	S	0	0	0
			215	142	37	33	3			

- Molecule 19 is a protein called Photosystem II reaction center protein Z.

Mol	Chain	Residues	Atoms					ZeroOcc	AltConf	Trace
19	Z	62	Total	C	N	O	S	0	0	0
			479	328	72	77	2			
19	z	62	Total	C	N	O	S	0	0	0
			479	328	72	77	2			

- Molecule 20 is a protein called Photosystem II protein Y.

Mol	Chain	Residues	Atoms				ZeroOcc	AltConf	Trace
20	R	34	Total	C	N	O	0	0	0
			273	186	47	40			

- Molecule 21 is FE (II) ION (three-letter code: FE2) (formula: Fe) (labeled as "Ligand of Interest" by depositor).

Mol	Chain	Residues	Atoms		ZeroOcc	AltConf
21	A	1	Total	Fe	0	1
			2	2		
21	a	1	Total	Fe	0	1
			2	2		

- Molecule 22 is CHLORIDE ION (three-letter code: CL) (formula: Cl) (labeled as "Ligand of Interest" by depositor).

Mol	Chain	Residues	Atoms		ZeroOcc	AltConf
22	A	2	Total	Cl	0	2
			4	4		

Continued on next page...

Continued from previous page...

Mol	Chain	Residues	Atoms	ZeroOcc	AltConf
22	a	2	Total Cl 4 4	0	2

- Molecule 23 is CHLOROPHYLL A (three-letter code: CLA) (formula: $C_{55}H_{72}MgN_4O_5$) (labeled as "Ligand of Interest" by depositor).

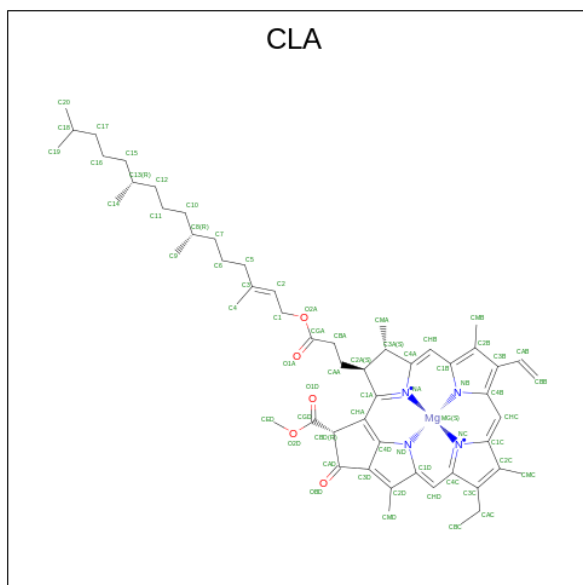

Mol	Chain	Residues	Atoms					ZeroOcc	AltConf
			Total	C	Mg	N	O		
23	A	1	Total	C	Mg	N	O	0	1
			130	110	2	8	10		
23	A	1	Total	C	Mg	N	O	0	1
			130	110	2	8	10		
23	A	1	Total	C	Mg	N	O	0	1
			130	110	2	8	10		
23	A	1	Total	C	Mg	N	O	0	0
			65	55	1	4	5		
23	B	1	Total	C	Mg	N	O	0	0
			65	55	1	4	5		
23	B	1	Total	C	Mg	N	O	0	0
			65	55	1	4	5		
23	B	1	Total	C	Mg	N	O	0	0
			65	55	1	4	5		
23	B	1	Total	C	Mg	N	O	0	0
			65	55	1	4	5		
23	B	1	Total	C	Mg	N	O	0	0
			65	55	1	4	5		
23	B	1	Total	C	Mg	N	O	0	0
			65	55	1	4	5		

Continued on next page...

Continued from previous page...

Mol	Chain	Residues	Atoms					ZeroOcc	AltConf
23	B	1	Total	C	Mg	N	O	0	0
			65	55	1	4	5		
23	B	1	Total	C	Mg	N	O	0	0
			65	55	1	4	5		
23	B	1	Total	C	Mg	N	O	0	0
			65	55	1	4	5		
23	B	1	Total	C	Mg	N	O	0	0
			65	55	1	4	5		
23	B	1	Total	C	Mg	N	O	0	0
			65	55	1	4	5		
23	B	1	Total	C	Mg	N	O	0	0
			65	55	1	4	5		
23	B	1	Total	C	Mg	N	O	0	0
			65	55	1	4	5		
23	B	1	Total	C	Mg	N	O	0	0
			65	55	1	4	5		
23	C	1	Total	C	Mg	N	O	0	0
			65	55	1	4	5		
23	C	1	Total	C	Mg	N	O	0	0
			65	55	1	4	5		
23	C	1	Total	C	Mg	N	O	0	0
			65	55	1	4	5		
23	C	1	Total	C	Mg	N	O	0	0
			65	55	1	4	5		
23	C	1	Total	C	Mg	N	O	0	0
			65	55	1	4	5		
23	C	1	Total	C	Mg	N	O	0	0
			65	55	1	4	5		
23	C	1	Total	C	Mg	N	O	0	0
			65	55	1	4	5		
23	C	1	Total	C	Mg	N	O	0	0
			65	55	1	4	5		
23	C	1	Total	C	Mg	N	O	0	0
			65	55	1	4	5		

Continued on next page...

Continued from previous page...

Mol	Chain	Residues	Atoms					ZeroOcc	AltConf
23	C	1	Total	C	Mg	N	O	0	0
			65	55	1	4	5		
23	C	1	Total	C	Mg	N	O	0	0
			65	55	1	4	5		
23	D	1	Total	C	Mg	N	O	0	1
			130	110	2	8	10		
23	D	1	Total	C	Mg	N	O	0	0
			65	55	1	4	5		
23	a	1	Total	C	Mg	N	O	0	1
			130	110	2	8	10		
23	a	1	Total	C	Mg	N	O	0	1
			130	110	2	8	10		
23	a	1	Total	C	Mg	N	O	0	0
			65	55	1	4	5		
23	b	1	Total	C	Mg	N	O	0	0
			65	55	1	4	5		
23	b	1	Total	C	Mg	N	O	0	0
			65	55	1	4	5		
23	b	1	Total	C	Mg	N	O	0	0
			65	55	1	4	5		
23	b	1	Total	C	Mg	N	O	0	0
			65	55	1	4	5		
23	b	1	Total	C	Mg	N	O	0	0
			65	55	1	4	5		
23	b	1	Total	C	Mg	N	O	0	0
			65	55	1	4	5		
23	b	1	Total	C	Mg	N	O	0	0
			65	55	1	4	5		
23	b	1	Total	C	Mg	N	O	0	0
			65	55	1	4	5		
23	b	1	Total	C	Mg	N	O	0	0
			65	55	1	4	5		
23	b	1	Total	C	Mg	N	O	0	0
			65	55	1	4	5		
23	b	1	Total	C	Mg	N	O	0	0
			65	55	1	4	5		
23	b	1	Total	C	Mg	N	O	0	0
			65	55	1	4	5		

Continued on next page...

Continued from previous page...

Mol	Chain	Residues	Atoms					ZeroOcc	AltConf
23	b	1	Total	C	Mg	N	O	0	0
			65	55	1	4	5		
23	b	1	Total	C	Mg	N	O	0	0
			65	55	1	4	5		
23	c	1	Total	C	Mg	N	O	0	0
			65	55	1	4	5		
23	c	1	Total	C	Mg	N	O	0	0
			65	55	1	4	5		
23	c	1	Total	C	Mg	N	O	0	0
			65	55	1	4	5		
23	c	1	Total	C	Mg	N	O	0	0
			65	55	1	4	5		
23	c	1	Total	C	Mg	N	O	0	0
			65	55	1	4	5		
23	c	1	Total	C	Mg	N	O	0	0
			65	55	1	4	5		
23	c	1	Total	C	Mg	N	O	0	0
			65	55	1	4	5		
23	c	1	Total	C	Mg	N	O	0	0
			65	55	1	4	5		
23	c	1	Total	C	Mg	N	O	0	0
			65	55	1	4	5		
23	c	1	Total	C	Mg	N	O	0	0
			65	55	1	4	5		
23	d	1	Total	C	Mg	N	O	0	1
			130	110	2	8	10		
23	d	1	Total	C	Mg	N	O	0	1
			130	110	2	8	10		
23	d	1	Total	C	Mg	N	O	0	0
			65	55	1	4	5		

- Molecule 24 is PHEOPHYTIN A (three-letter code: PHO) (formula: C₅₅H₇₄N₄O₅).

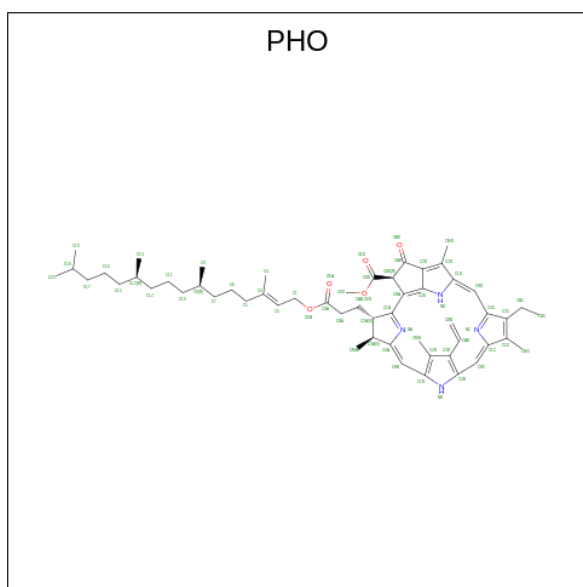

Mol	Chain	Residues	Atoms				ZeroOcc	AltConf
			Total	C	N	O		
24	A	1	Total	C	N	O	0	1
			128	110	8	10		
24	A	1	Total	C	N	O	0	1
			128	110	8	10		
24	a	1	Total	C	N	O	0	1
			128	110	8	10		
24	a	1	Total	C	N	O	0	1
			128	110	8	10		

- Molecule 25 is BETA-CAROTENE (three-letter code: BCR) (formula: $C_{40}H_{56}$).

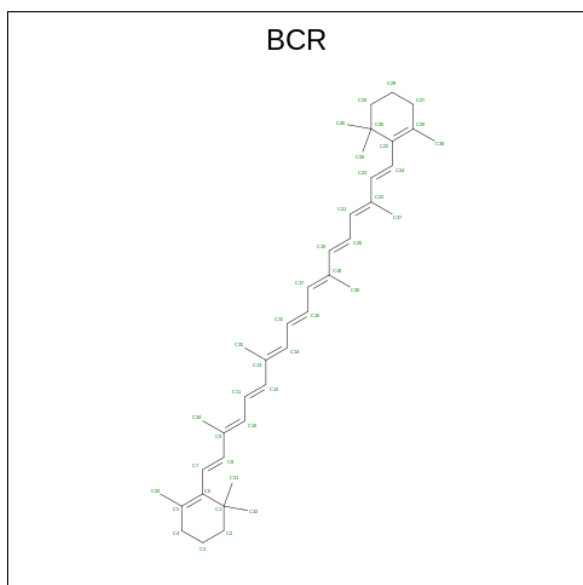

Mol	Chain	Residues	Atoms	ZeroOcc	AltConf
25	A	1	Total C 40 40	0	0
25	B	1	Total C 40 40	0	0
25	B	1	Total C 40 40	0	0
25	B	1	Total C 40 40	0	0
25	C	1	Total C 40 40	0	0
25	C	1	Total C 40 40	0	0
25	D	1	Total C 40 40	0	0
25	K	1	Total C 40 40	0	0
25	T	1	Total C 40 40	0	0
25	X	1	Total C 40 40	0	0
25	Y	1	Total C 40 40	0	0
25	a	1	Total C 40 40	0	0
25	b	1	Total C 40 40	0	0
25	b	1	Total C 40 40	0	0
25	b	1	Total C 40 40	0	0
25	c	1	Total C 40 40	0	0
25	c	1	Total C 40 40	0	0
25	d	1	Total C 40 40	0	0
25	h	1	Total C 40 40	0	0
25	k	1	Total C 40 40	0	0
25	t	1	Total C 40 40	0	0
25	y	1	Total C 40 40	0	0

- Molecule 26 is 1,2-DI-O-ACYL-3-O-[6-DEOXY-6-SULFO-ALPHA-D-GLUCOPYRANOSYL]-SN-GLYCEROL (three-letter code: SQD) (formula: $C_{41}H_{78}O_{12}S$).

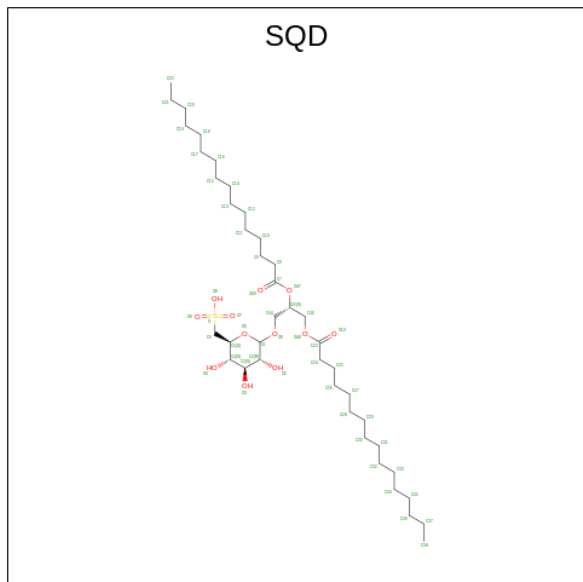

Mol	Chain	Residues	Atoms				ZeroOcc	AltConf
			Total	C	O	S		
26	A	1	Total 108	C 82	O 24	S 2	0	1
26	A	1	Total 54	C 41	O 12	S 1	0	0
26	B	1	Total 54	C 41	O 12	S 1	0	0
26	F	1	Total 43	C 30	O 12	S 1	0	0
26	a	1	Total 108	C 82	O 24	S 2	0	1
26	a	1	Total 54	C 41	O 12	S 1	0	0
26	b	1	Total 54	C 41	O 12	S 1	0	0
26	f	1	Total 43	C 30	O 12	S 1	0	0

- Molecule 27 is GLYCEROL (three-letter code: GOL) (formula: $C_3H_8O_3$).

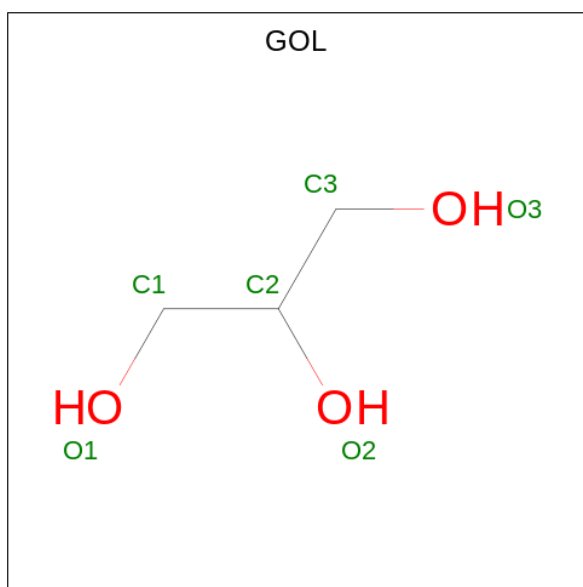

Mol	Chain	Residues	Atoms	ZeroOcc	AltConf
27	A	1	Total C O 6 3 3	0	0
27	A	1	Total C O 6 3 3	0	0
27	B	1	Total C O 6 3 3	0	0
27	B	1	Total C O 6 3 3	0	0
27	B	1	Total C O 6 3 3	0	0
27	C	1	Total C O 12 6 6	0	1
27	D	1	Total C O 6 3 3	0	0
27	O	1	Total C O 6 3 3	0	0
27	O	1	Total C O 6 3 3	0	0
27	V	1	Total C O 12 6 6	0	1
27	a	1	Total C O 6 3 3	0	0
27	a	1	Total C O 6 3 3	0	0
27	b	1	Total C O 6 3 3	0	0
27	b	1	Total C O 6 3 3	0	0

Continued on next page...

Continued from previous page...

Mol	Chain	Residues	Atoms			ZeroOcc	AltConf
27	c	1	Total	C	O	0	1
			12	6	6		
27	c	1	Total	C	O	0	0
			6	3	3		
27	d	1	Total	C	O	0	0
			6	3	3		
27	l	1	Total	C	O	0	1
			12	6	6		
27	o	1	Total	C	O	0	0
			6	3	3		
27	o	1	Total	C	O	0	0
			6	3	3		
27	v	1	Total	C	O	0	1
			12	6	6		

- Molecule 28 is CA-MN4-O5 CLUSTER (three-letter code: OEX) (formula: CaMn_4O_5) (labeled as "Ligand of Interest" by depositor).

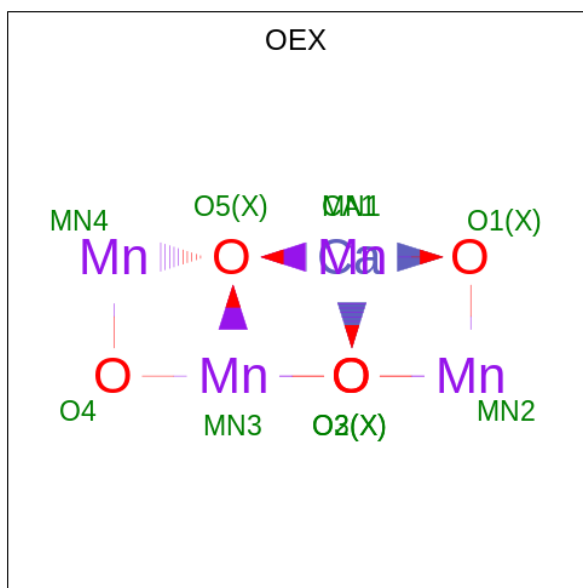

Mol	Chain	Residues	Atoms				ZeroOcc	AltConf
28	A	1	Total	Ca	Mn	O	0	1
			20	2	8	10		
28	a	1	Total	Ca	Mn	O	0	1
			20	2	8	10		

- Molecule 29 is 2,3-DIMETHYL-5-(3,7,11,15,19,23,27,31,35-NONAMETHYL-2,6,10,14,18,22,26,30,34-HEXATRIACONTANONAENYL-2,5-CYCLOHEXADIENE-1,4-DIONE-2,3-DIMETHYL-5-SOLANESYL-1,4-BENZOQUINONE (three-letter code: PL9) (formula:

C₅₃H₈₀O₂) (labeled as "Ligand of Interest" by depositor).

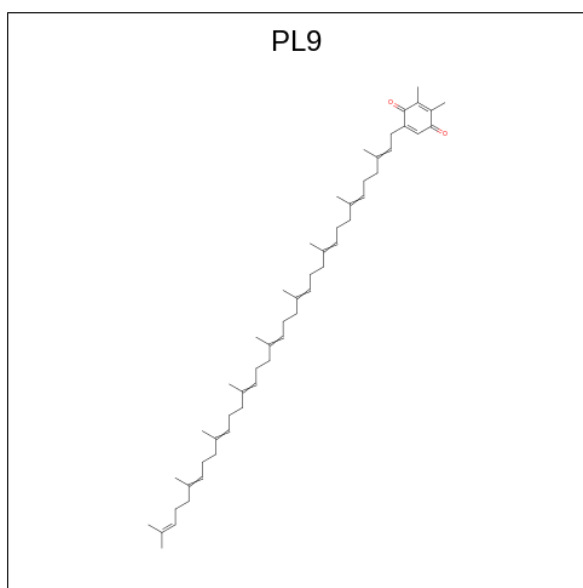

Mol	Chain	Residues	Atoms			ZeroOcc	AltConf
29	A	1	Total	C	O	0	1
			110	106	4		
29	D	1	Total	C	O	0	1
			110	106	4		
29	a	1	Total	C	O	0	1
			110	106	4		
29	d	1	Total	C	O	0	1
			110	106	4		

- Molecule 30 is UNKNOWN LIGAND (three-letter code: UNL) (formula:).

Mol	Chain	Residues	Atoms			ZeroOcc	AltConf
30	A	1	Total	C	O	0	0
			28	23	5		
30	B	1	Total	C	O	0	0
			33	28	5		
30	D	2	Total	C	O	0	0
			57	51	6		
30	I	1	Total	C	O	0	0
			40	35	5		
30	J	1	Total	C		0	0
			10	10			
30	K	1	Total	C	O	0	1
			68	58	10		
30	M	1	Total	C		0	0
			10	10			

Continued on next page...

Continued from previous page...

Mol	Chain	Residues	Atoms			ZeroOcc	AltConf
30	X	1	Total	C	O	0	0
			18	16	2		
30	a	1	Total	C	O	0	0
			30	25	5		
30	b	1	Total	C	O	0	0
			33	28	5		
30	c	1	Total	C	O	0	1
			64	54	10		
30	d	2	Total	C	O	0	0
			53	47	6		
30	i	1	Total	C	O	0	0
			40	35	5		
30	j	1	Total	C		0	0
			10	10			
30	m	1	Total	C		0	0
			10	10			
30	x	1	Total	C	O	0	0
			18	16	2		

- Molecule 31 is DODECYL-BETA-D-MALTOSE (three-letter code: LMT) (formula: $C_{24}H_{46}O_{11}$).

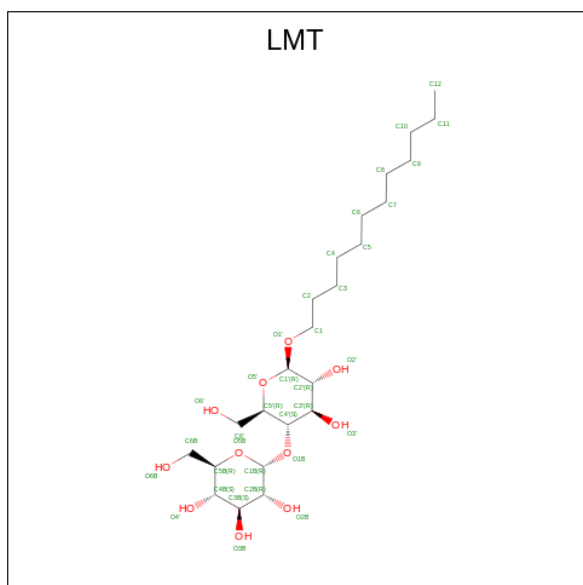

Mol	Chain	Residues	Atoms			ZeroOcc	AltConf
31	A	1	Total	C	O	0	0
			35	24	11		
31	A	1	Total	C	O	0	0
			35	24	11		

Continued on next page...

Continued from previous page...

Mol	Chain	Residues	Atoms			ZeroOcc	AltConf
31	B	1	Total	C	O	0	0
			35	24	11		
31	B	1	Total	C	O	0	0
			35	24	11		
31	B	1	Total	C	O	0	0
			25	19	6		
31	F	1	Total	C	O	0	0
			35	24	11		
31	M	1	Total	C	O	0	0
			35	24	11		
31	M	1	Total	C	O	0	0
			35	24	11		
31	b	1	Total	C	O	0	0
			25	19	6		
31	b	1	Total	C	O	0	0
			25	19	6		
31	c	1	Total	C	O	0	0
			35	24	11		
31	e	1	Total	C	O	0	0
			35	24	11		
31	m	1	Total	C	O	0	0
			35	24	11		
31	t	1	Total	C	O	0	0
			26	19	7		

- Molecule 32 is 1,2-DIPALMITOYL-PHOSPHATIDYL-GLYCEROLE (three-letter code: LHG) (formula: $C_{38}H_{75}O_{10}P$).

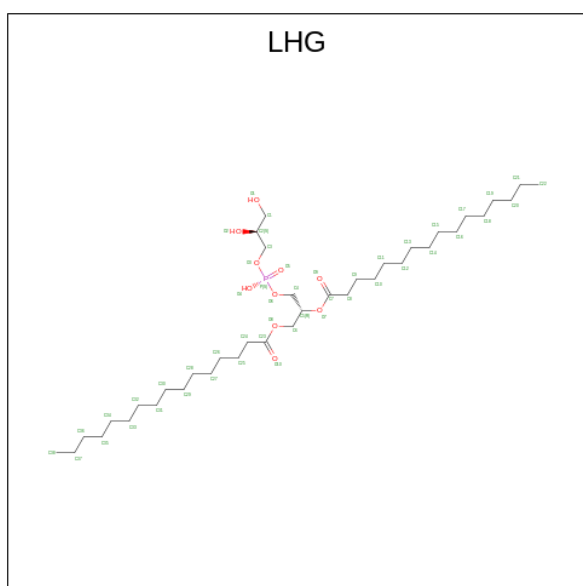

Mol	Chain	Residues	Atoms				ZeroOcc	AltConf
32	A	1	Total	C	O	P	0	1
			98	76	20	2		
32	D	1	Total	C	O	P	0	1
			98	76	20	2		
32	D	1	Total	C	O	P	0	1
			98	76	20	2		
32	E	1	Total	C	O	P	0	1
			84	62	20	2		
32	L	1	Total	C	O	P	0	1
			98	76	20	2		
32	a	1	Total	C	O	P	0	1
			84	62	20	2		
32	b	1	Total	C	O	P	0	1
			98	76	20	2		
32	d	1	Total	C	O	P	0	1
			98	76	20	2		
32	d	1	Total	C	O	P	0	1
			98	76	20	2		
32	d	1	Total	C	O	P	0	1
			98	76	20	2		

- Molecule 33 is 1,2-DISTEAROYL-MONOGALACTOSYL-DIGLYCERIDE (three-letter code: LMG) (formula: C₄₅H₈₆O₁₀).

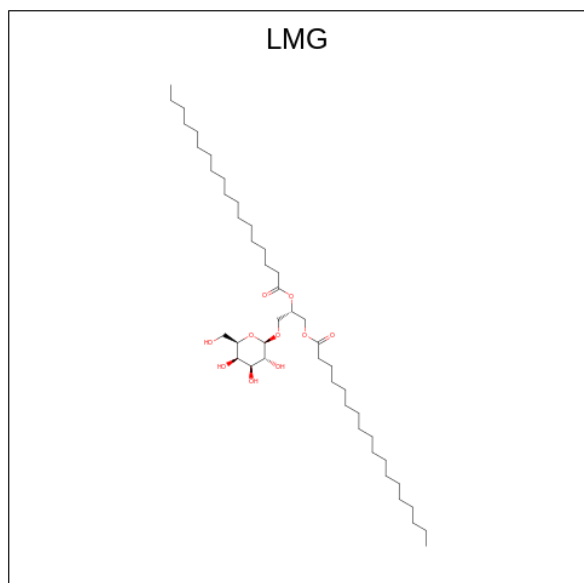

Mol	Chain	Residues	Atoms			ZeroOcc	AltConf
33	B	1	Total	C	O	0	0
			51	41	10		

Continued on next page...

Continued from previous page...

Mol	Chain	Residues	Atoms			ZeroOcc	AltConf
33	C	1	Total	C	O	0	0
			51	41	10		
33	C	1	Total	C	O	0	0
			51	41	10		
33	C	1	Total	C	O	0	0
			51	41	10		
33	D	1	Total	C	O	0	0
			51	41	10		
33	c	1	Total	C	O	0	0
			51	41	10		
33	c	1	Total	C	O	0	0
			51	41	10		
33	c	1	Total	C	O	0	0
			51	41	10		
33	d	1	Total	C	O	0	0
			51	41	10		
33	m	1	Total	C	O	0	0
			51	41	10		
33	Z	1	Total	C	O	0	0
			37	27	10		
33	z	1	Total	C	O	0	0
			39	29	10		

- Molecule 34 is heptyl 1-thio-beta-D-glucopyranoside (three-letter code: HTG) (formula: $C_{13}H_{26}O_5S$).

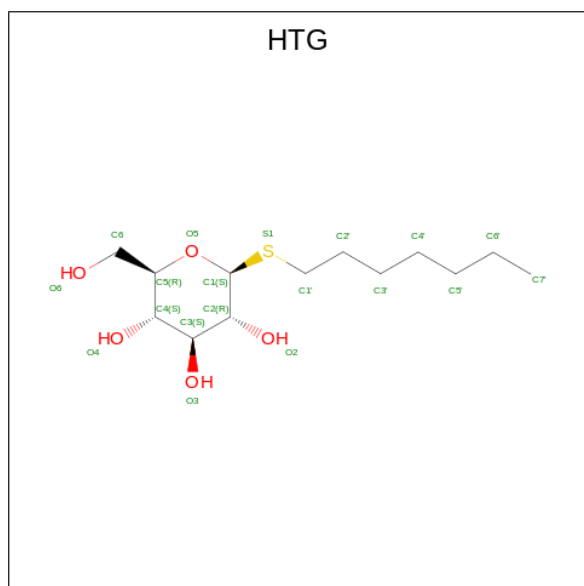

Mol	Chain	Residues	Atoms			ZeroOcc	AltConf
35	C	1	Total	C	O	0	1
			124	94	30		
35	C	1	Total	C	O	0	1
			124	94	30		
35	C	1	Total	C	O	0	0
			62	47	15		
35	H	1	Total	C	O	0	0
			62	47	15		
35	c	1	Total	C	O	0	1
			124	94	30		
35	c	1	Total	C	O	0	1
			124	94	30		
35	c	1	Total	C	O	0	0
			62	47	15		
35	h	1	Total	C	O	0	0
			62	47	15		

- Molecule 36 is CALCIUM ION (three-letter code: CA) (formula: Ca).

Mol	Chain	Residues	Atoms		ZeroOcc	AltConf
36	C	1	Total	Ca	0	0
			1	1		
36	F	1	Total	Ca	0	0
			1	1		
36	O	1	Total	Ca	0	0
			1	1		
36	c	2	Total	Ca	0	0
			2	2		
36	f	1	Total	Ca	0	0
			1	1		
36	o	1	Total	Ca	0	0
			1	1		

- Molecule 37 is BICARBONATE ION (three-letter code: BCT) (formula: CHO₃) (labeled as "Ligand of Interest" by depositor).

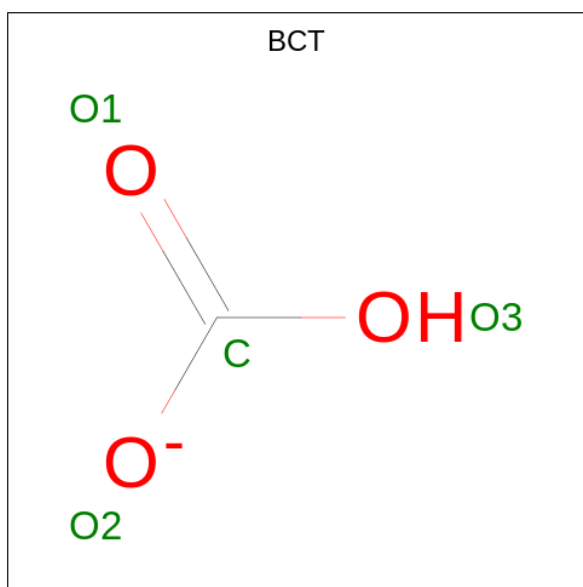

Mol	Chain	Residues	Atoms			ZeroOcc	AltConf
37	D	1	Total	C	O	0	1
			8	2	6		
37	d	1	Total	C	O	0	1
			8	2	6		

- Molecule 38 is PROTOPORPHYRIN IX CONTAINING FE (three-letter code: HEM) (formula: $C_{34}H_{32}FeN_4O_4$).

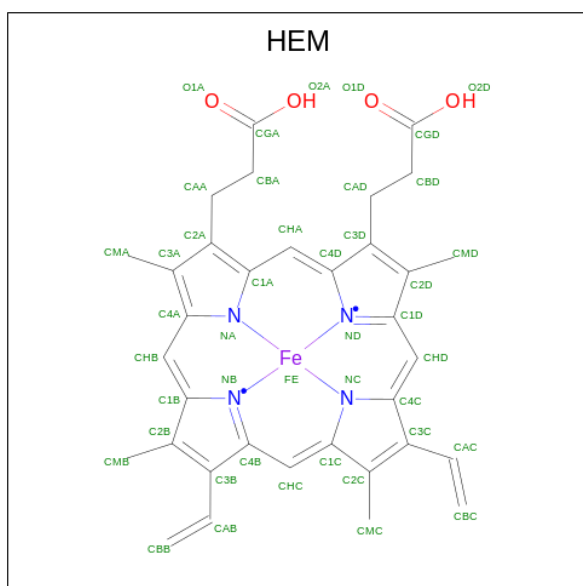

Mol	Chain	Residues	Atoms					ZeroOcc	AltConf
38	E	1	Total	C	Fe	N	O	0	0
			43	34	1	4	4		

Continued on next page...

Continued from previous page...

Mol	Chain	Residues	Atoms				ZeroOcc	AltConf	
38	f	1	Total	C	Fe	N	O	0	0
			43	34	1	4	4		

- Molecule 39 is MAGNESIUM ION (three-letter code: MG) (formula: Mg).

Mol	Chain	Residues	Atoms		ZeroOcc	AltConf
39	J	1	Total	Mg	0	0
			1	1		
39	j	1	Total	Mg	0	0
			1	1		

- Molecule 40 is HEME C (three-letter code: HEC) (formula: C₃₄H₃₄FeN₄O₄).

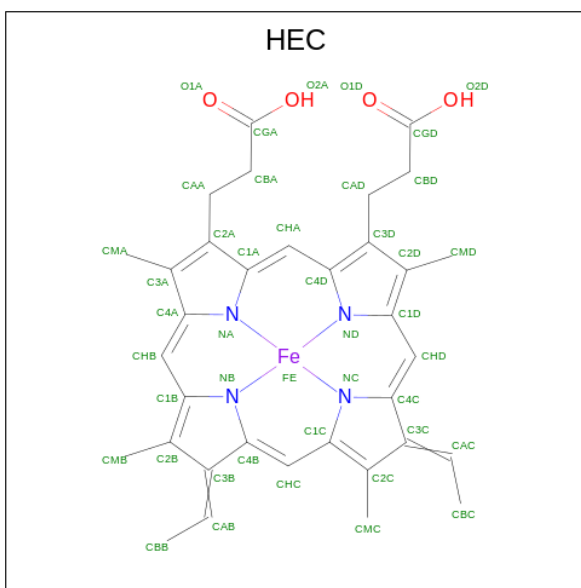

Mol	Chain	Residues	Atoms				ZeroOcc	AltConf	
40	V	1	Total	C	Fe	N	O	0	0
			43	34	1	4	4		
40	v	1	Total	C	Fe	N	O	0	0
			43	34	1	4	4		

- Molecule 41 is water.

Mol	Chain	Residues	Atoms		ZeroOcc	AltConf
41	A	141	Total	O	0	86
			226	226		
41	B	191	Total	O	0	2
			193	193		

Continued on next page...

Continued from previous page...

Mol	Chain	Residues	Atoms	ZeroOcc	AltConf
41	C	168	Total O 205 205	0	38
41	D	117	Total O 151 151	0	34
41	E	17	Total O 17 17	0	0
41	F	5	Total O 5 5	0	0
41	H	21	Total O 21 21	0	0
41	I	6	Total O 6 6	0	0
41	J	7	Total O 7 7	0	0
41	K	6	Total O 6 6	0	0
41	L	9	Total O 10 10	0	1
41	M	5	Total O 5 5	0	0
41	O	103	Total O 108 108	0	5
41	T	10	Total O 13 13	0	3
41	U	46	Total O 48 48	0	2
41	V	79	Total O 80 80	0	1
41	X	7	Total O 7 7	0	0
41	a	126	Total O 206 206	0	81
41	b	200	Total O 203 203	0	3
41	c	160	Total O 193 193	0	34
41	d	119	Total O 151 151	0	32
41	e	8	Total O 8 8	0	0
41	f	3	Total O 3 3	0	0

Continued on next page...

Continued from previous page...

Mol	Chain	Residues	Atoms	ZeroOcc	AltConf
41	h	16	Total O 16 16	0	0
41	i	2	Total O 2 2	0	0
41	j	1	Total O 1 1	0	0
41	k	3	Total O 3 3	0	0
41	l	8	Total O 10 10	0	2
41	m	13	Total O 13 13	0	0
41	o	103	Total O 107 107	0	4
41	t	9	Total O 12 12	0	3
41	u	48	Total O 49 49	0	1
41	v	59	Total O 61 61	0	2
41	x	7	Total O 7 7	0	0
41	y	2	Total O 2 2	0	0

3 Residue-property plots [i](#)

These plots are drawn for all protein, RNA, DNA and oligosaccharide chains in the entry. The first graphic for a chain summarises the proportions of the various outlier classes displayed in the second graphic. The second graphic shows the sequence view annotated by issues in geometry and electron density. Residues are color-coded according to the number of geometric quality criteria for which they contain at least one outlier: green = 0, yellow = 1, orange = 2 and red = 3 or more. A red dot above a residue indicates a poor fit to the electron density ($RSRZ > 2$). Stretches of 2 or more consecutive residues without any outlier are shown as a green connector. Residues present in the sample, but not in the model, are shown in grey.

- Molecule 1: Photosystem II protein D1

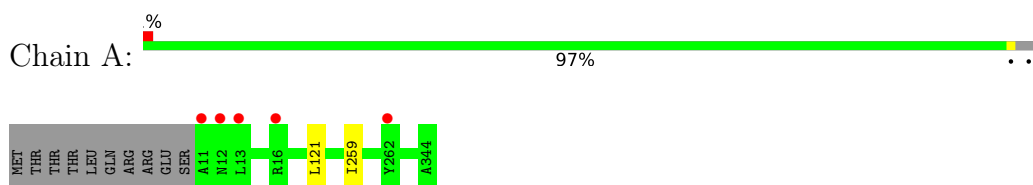

- Molecule 1: Photosystem II protein D1

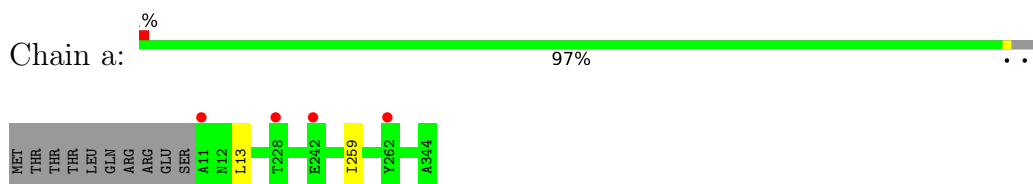

- Molecule 2: Photosystem II CP47 reaction center protein

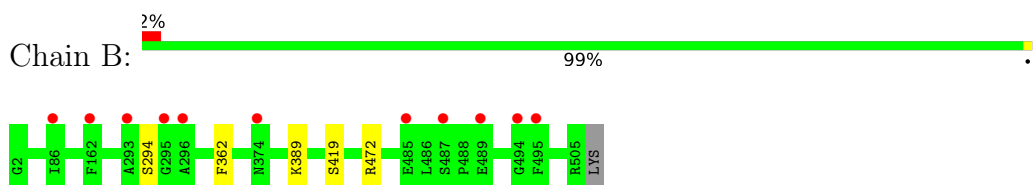

- Molecule 2: Photosystem II CP47 reaction center protein

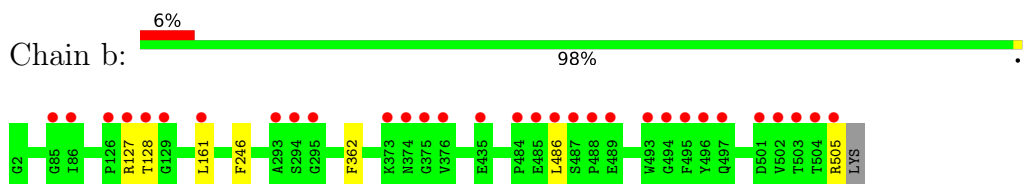

- Molecule 3: Photosystem II CP43 reaction center protein

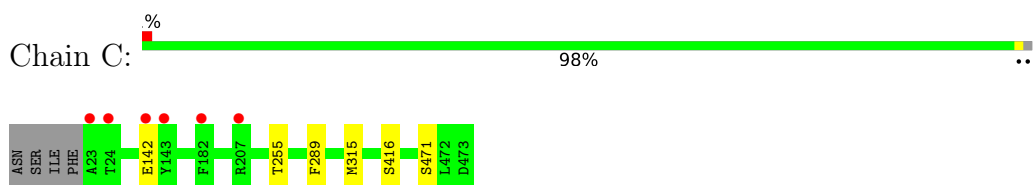

- Molecule 3: Photosystem II CP43 reaction center protein

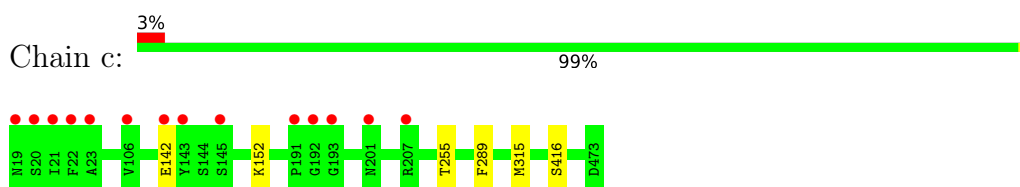

• Molecule 4: Photosystem II D2 protein

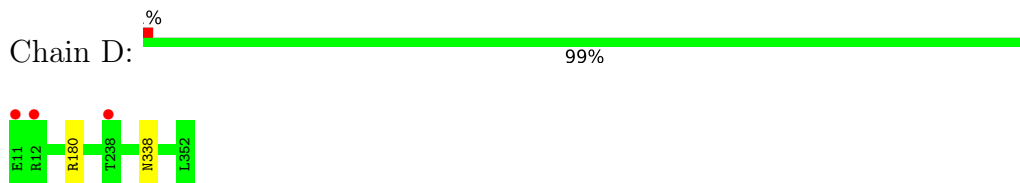

• Molecule 4: Photosystem II D2 protein

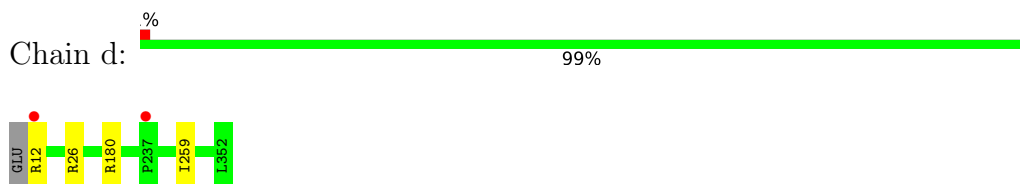

• Molecule 5: Cytochrome b559 subunit alpha

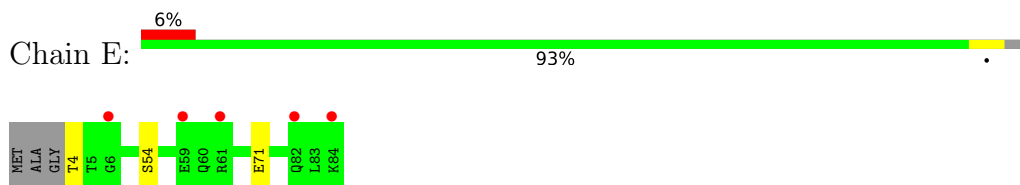

• Molecule 5: Cytochrome b559 subunit alpha

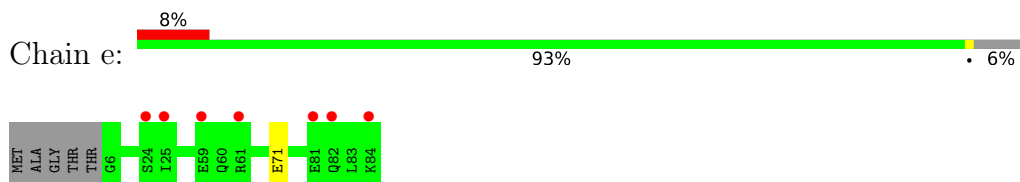

• Molecule 6: Cytochrome b559 subunit beta

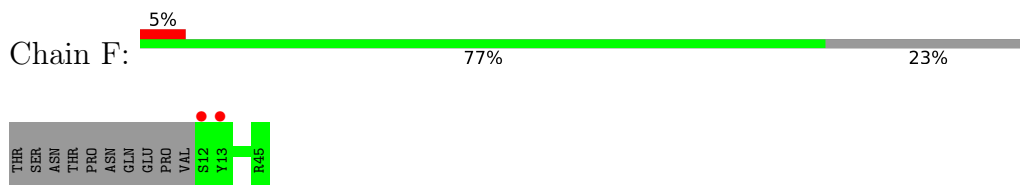

• Molecule 6: Cytochrome b559 subunit beta

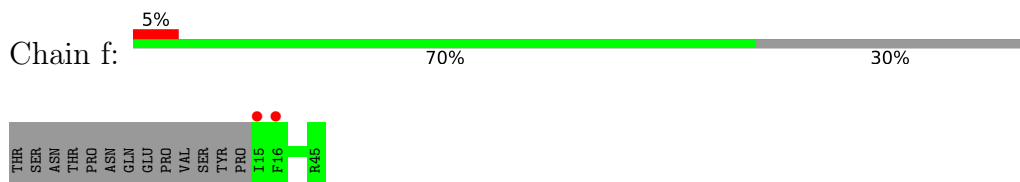

- Molecule 7: Photosystem II reaction center protein H

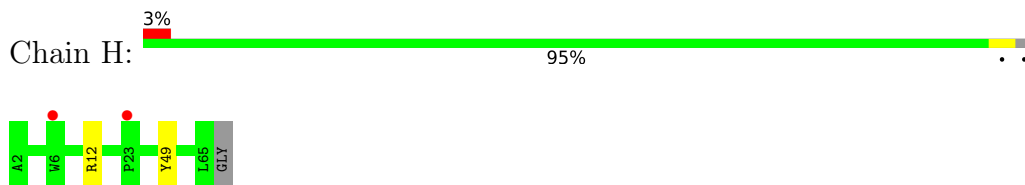

- Molecule 7: Photosystem II reaction center protein H

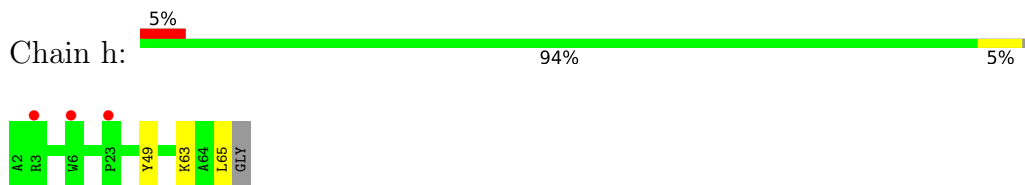

- Molecule 8: Photosystem II reaction center protein I

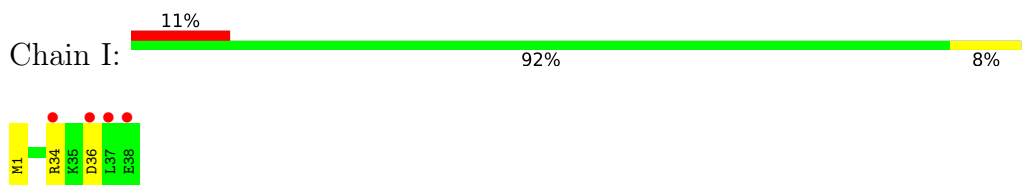

- Molecule 8: Photosystem II reaction center protein I

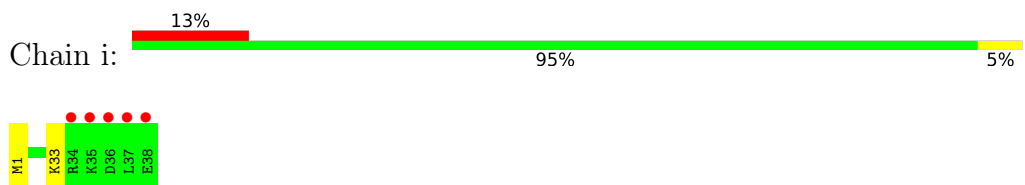

- Molecule 9: Photosystem II reaction center protein J

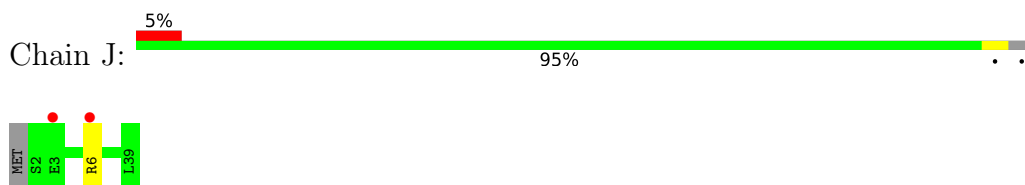

- Molecule 9: Photosystem II reaction center protein J

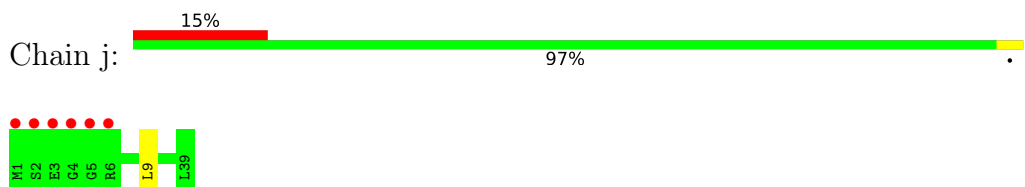

- Molecule 10: Photosystem II reaction center protein K

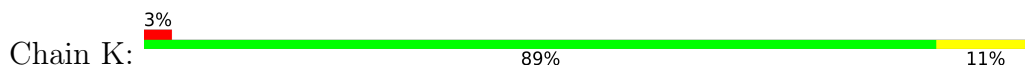

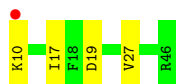

- Molecule 10: Photosystem II reaction center protein K

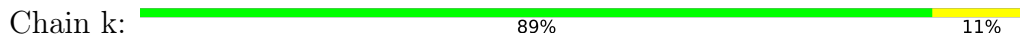

- Molecule 11: Photosystem II reaction center protein L

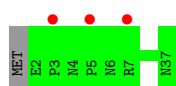

- Molecule 11: Photosystem II reaction center protein L

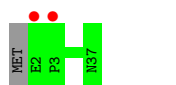

- Molecule 12: Photosystem II reaction center protein M

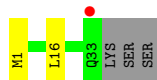
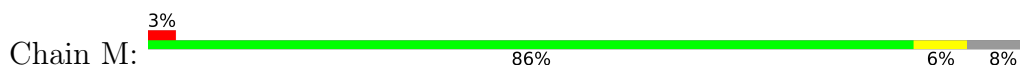

- Molecule 12: Photosystem II reaction center protein M

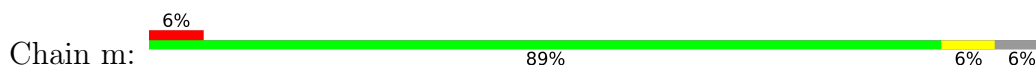

- Molecule 13: Photosystem II manganese-stabilizing polypeptide

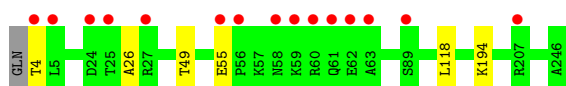

- Molecule 13: Photosystem II manganese-stabilizing polypeptide

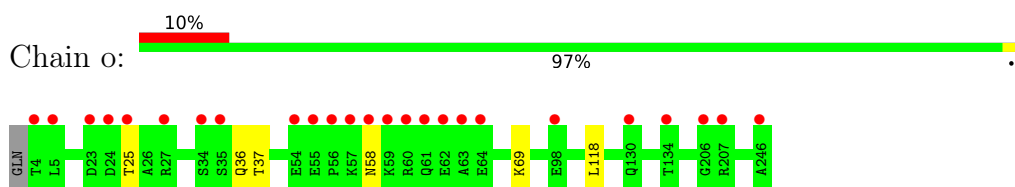

- Molecule 14: Photosystem II reaction center protein T

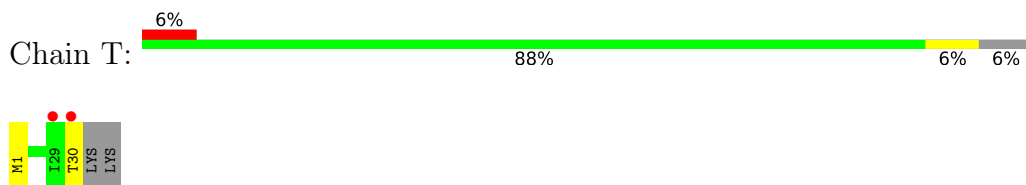

- Molecule 14: Photosystem II reaction center protein T

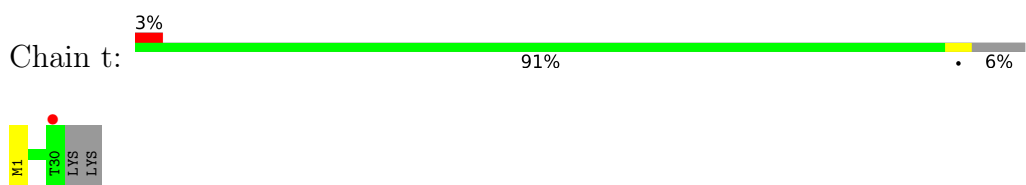

- Molecule 15: Photosystem II 12 kDa extrinsic protein

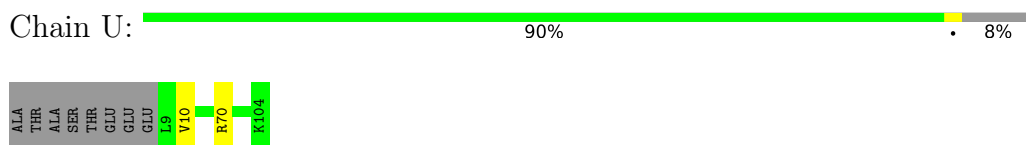

- Molecule 15: Photosystem II 12 kDa extrinsic protein

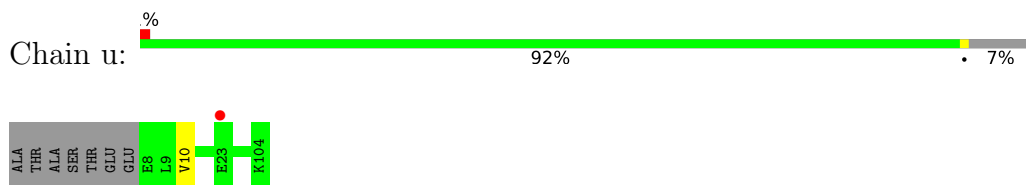

- Molecule 16: Cytochrome c-550

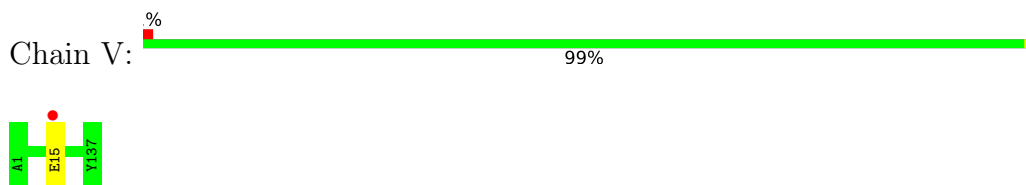

- Molecule 16: Cytochrome c-550

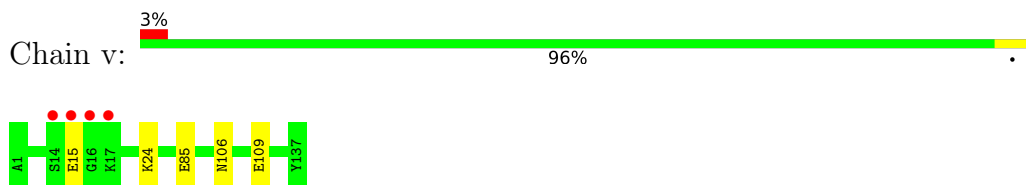

- Molecule 17: Photosystem II reaction center protein X

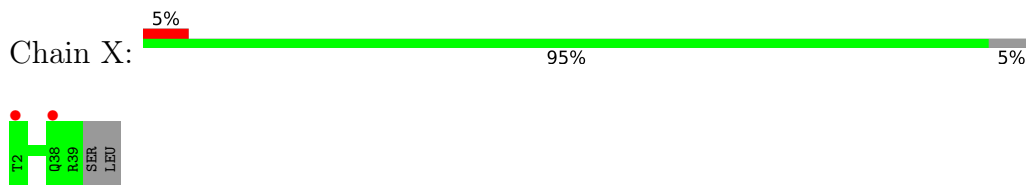

- Molecule 17: Photosystem II reaction center protein X

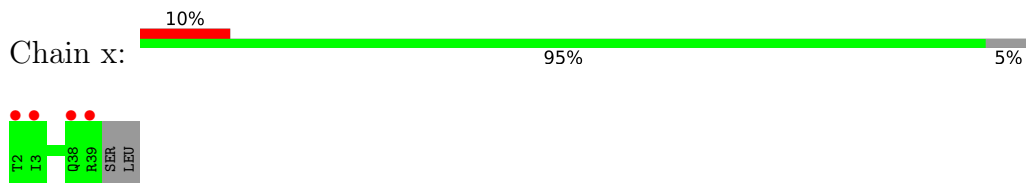

- Molecule 18: Photosystem II reaction center protein Ycf12

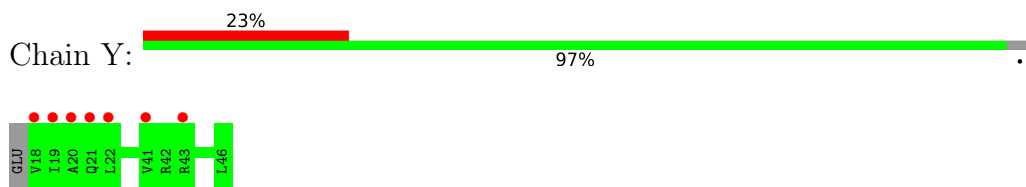

- Molecule 18: Photosystem II reaction center protein Ycf12

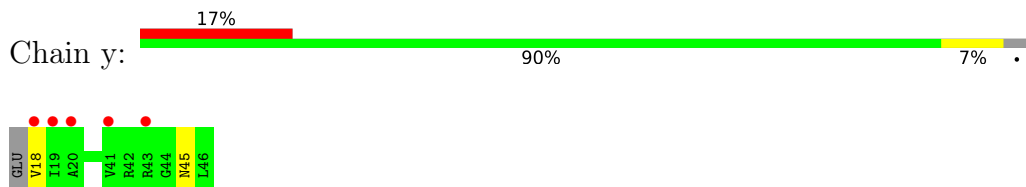

- Molecule 19: Photosystem II reaction center protein Z

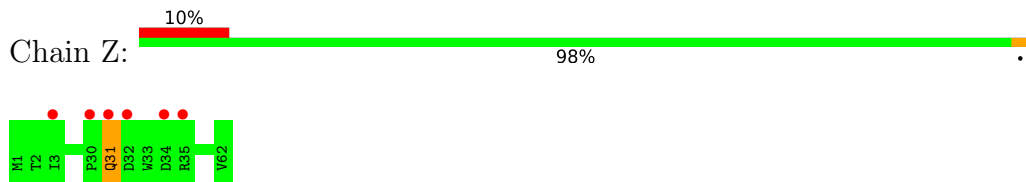

- Molecule 19: Photosystem II reaction center protein Z

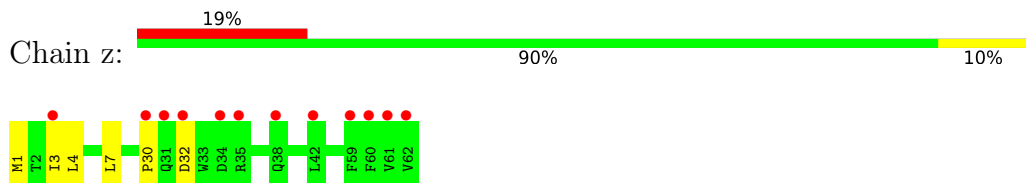

- Molecule 20: Photosystem II protein Y

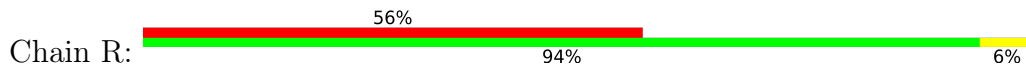

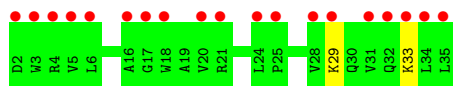

4 Data and refinement statistics

Property	Value	Source
Space group	P 21 21 21	Depositor
Cell constants a, b, c, α , β , γ	125.75Å 231.60Å 288.28Å 90.00° 90.00° 90.00°	Depositor
Resolution (Å)	19.98 – 2.25 19.98 – 2.25	Depositor EDS
% Data completeness (in resolution range)	99.9 (19.98-2.25) 99.9 (19.98-2.25)	Depositor EDS
R_{merge}	(Not available)	Depositor
R_{sym}	(Not available)	Depositor
$\langle I/\sigma(I) \rangle$ ¹	1.60 (at 2.26Å)	Xtrriage
Refinement program	PHENIX (1.19.2_4158: ???)	Depositor
R, R_{free}	0.139 , 0.175 0.139 , 0.175	Depositor DCC
R_{free} test set	19824 reflections (5.02%)	wwPDB-VP
Wilson B-factor (Å ²)	50.7	Xtrriage
Anisotropy	0.491	Xtrriage
Bulk solvent k_{sol} (e/Å ³), B_{sol} (Å ²)	0.35 , 84.8	EDS
L-test for twinning ²	$\langle L \rangle = 0.50$, $\langle L^2 \rangle = 0.34$	Xtrriage
Estimated twinning fraction	No twinning to report.	Xtrriage
F_o, F_c correlation	0.98	EDS
Total number of atoms	62674	wwPDB-VP
Average B, all atoms (Å ²)	64.0	wwPDB-VP

Xtrriage's analysis on translational NCS is as follows: *The largest off-origin peak in the Patterson function is 1.70% of the height of the origin peak. No significant pseudotranslation is detected.*

¹Intensities estimated from amplitudes.

²Theoretical values of $\langle |L| \rangle$, $\langle L^2 \rangle$ for acentric reflections are 0.5, 0.333 respectively for untwinned datasets, and 0.375, 0.2 for perfectly twinned datasets.

5 Model quality

5.1 Standard geometry

Bond lengths and bond angles in the following residue types are not validated in this section: FME, SQD, LMG, CL, DGD, HEM, HTG, PL9, BCT, UNL, PHO, CA, BCR, CLA, FE2, GOL, OEX, HEC, LMT, LHG, MG

The Z score for a bond length (or angle) is the number of standard deviations the observed value is removed from the expected value. A bond length (or angle) with $|Z| > 5$ is considered an outlier worth inspection. RMSZ is the root-mean-square of all Z scores of the bond lengths (or angles).

Mol	Chain	Bond lengths		Bond angles	
		RMSZ	# Z >5	RMSZ	# Z >5
1	A	0.43	0/4478	0.58	0/6098
1	a	0.42	0/4457	0.57	0/6069
2	B	0.43	0/4314	0.58	0/5879
2	b	0.41	0/4285	0.57	0/5841
3	C	0.40	0/4416	0.55	0/6013
3	c	0.40	0/4467	0.54	0/6082
4	D	0.46	0/3746	0.60	0/5102
4	d	0.44	0/3780	0.58	0/5147
5	E	0.40	0/681	0.58	0/928
5	e	0.38	0/690	0.54	0/939
6	F	0.40	0/284	0.55	0/387
6	f	0.36	0/269	0.51	0/365
7	H	0.39	0/519	0.60	0/708
7	h	0.37	0/530	0.57	0/722
8	I	0.37	0/311	0.53	0/419
8	i	0.40	0/311	0.54	0/419
9	J	0.40	0/278	0.52	0/376
9	j	0.37	0/283	0.53	0/383
10	K	0.39	0/303	0.52	0/416
10	k	0.39	0/303	0.50	0/416
11	L	0.40	0/318	0.58	0/433
11	l	0.45	0/318	0.53	0/433
12	M	0.43	0/261	0.51	0/357
12	m	0.41	0/279	0.53	0/380
13	O	0.42	0/1991	0.64	0/2698
13	o	0.39	0/1966	0.64	0/2665
14	T	0.45	0/310	0.60	0/419
14	t	0.42	0/301	0.57	0/406
15	U	0.44	0/811	0.61	0/1095
15	u	0.44	0/826	0.63	0/1116
16	V	0.39	0/1142	0.57	0/1545

Mol	Chain	Bond lengths		Bond angles	
		RMSZ	# Z >5	RMSZ	# Z >5
16	v	0.36	0/1139	0.56	0/1542
17	X	0.32	0/292	0.49	0/395
17	x	0.33	0/284	0.48	0/384
18	Y	0.33	0/216	0.53	0/289
18	y	0.31	0/216	0.51	0/289
19	Z	0.32	0/490	0.45	0/669
19	z	0.32	0/490	0.43	0/669
20	R	0.33	0/279	0.53	0/383
All	All	0.41	0/50634	0.57	0/68876

There are no bond length outliers.

There are no bond angle outliers.

There are no chirality outliers.

There are no planarity outliers.

5.2 Too-close contacts [i](#)

Due to software issues we are unable to calculate clashes - this section is therefore empty.

5.3 Torsion angles [i](#)

5.3.1 Protein backbone [i](#)

In the following table, the Percentiles column shows the percent Ramachandran outliers of the chain as a percentile score with respect to all X-ray entries followed by that with respect to entries of similar resolution.

The Analysed column shows the number of residues for which the backbone conformation was analysed, and the total number of residues.

Mol	Chain	Analysed	Favoured	Allowed	Outliers	Percentiles	
1	A	553/344 (161%)	544 (98%)	7 (1%)	2 (0%)	34	37
1	a	551/344 (160%)	539 (98%)	10 (2%)	2 (0%)	34	37
2	B	524/505 (104%)	515 (98%)	9 (2%)	0	100	100
2	b	521/505 (103%)	509 (98%)	12 (2%)	0	100	100
3	C	548/455 (120%)	540 (98%)	7 (1%)	1 (0%)	47	55
3	c	554/455 (122%)	544 (98%)	9 (2%)	1 (0%)	47	55

Continued on next page...

Continued from previous page...

Mol	Chain	Analysed	Favoured	Allowed	Outliers	Percentiles	
4	D	454/342 (133%)	439 (97%)	15 (3%)	0	100	100
4	d	457/342 (134%)	444 (97%)	13 (3%)	0	100	100
5	E	79/84 (94%)	78 (99%)	1 (1%)	0	100	100
5	e	79/84 (94%)	78 (99%)	1 (1%)	0	100	100
6	F	32/44 (73%)	32 (100%)	0	0	100	100
6	f	30/44 (68%)	30 (100%)	0	0	100	100
7	H	62/65 (95%)	60 (97%)	2 (3%)	0	100	100
7	h	63/65 (97%)	59 (94%)	3 (5%)	1 (2%)	9	5
8	I	36/38 (95%)	33 (92%)	2 (6%)	1 (3%)	5	2
8	i	36/38 (95%)	32 (89%)	4 (11%)	0	100	100
9	J	36/39 (92%)	35 (97%)	1 (3%)	0	100	100
9	j	37/39 (95%)	37 (100%)	0	0	100	100
10	K	35/37 (95%)	35 (100%)	0	0	100	100
10	k	35/37 (95%)	34 (97%)	1 (3%)	0	100	100
11	L	36/37 (97%)	36 (100%)	0	0	100	100
11	l	36/37 (97%)	36 (100%)	0	0	100	100
12	M	32/36 (89%)	32 (100%)	0	0	100	100
12	m	34/36 (94%)	33 (97%)	1 (3%)	0	100	100
13	O	251/244 (103%)	242 (96%)	8 (3%)	1 (0%)	34	37
13	o	249/244 (102%)	244 (98%)	5 (2%)	0	100	100
14	T	33/32 (103%)	33 (100%)	0	0	100	100
14	t	32/32 (100%)	32 (100%)	0	0	100	100
15	U	97/104 (93%)	93 (96%)	4 (4%)	0	100	100
15	u	99/104 (95%)	96 (97%)	3 (3%)	0	100	100
16	V	140/137 (102%)	136 (97%)	4 (3%)	0	100	100
16	v	140/137 (102%)	134 (96%)	6 (4%)	0	100	100
17	X	37/40 (92%)	36 (97%)	1 (3%)	0	100	100
17	x	36/40 (90%)	36 (100%)	0	0	100	100
18	Y	27/30 (90%)	24 (89%)	3 (11%)	0	100	100
18	y	27/30 (90%)	27 (100%)	0	0	100	100
19	Z	60/62 (97%)	58 (97%)	1 (2%)	1 (2%)	9	4

Continued on next page...

Continued from previous page...

Mol	Chain	Analysed	Favoured	Allowed	Outliers	Percentiles	
19	z	60/62 (97%)	59 (98%)	0	1 (2%)	9	4
20	R	32/34 (94%)	31 (97%)	1 (3%)	0	100	100
All	All	6180/5384 (115%)	6035 (98%)	134 (2%)	11 (0%)	47	55

5 of 11 Ramachandran outliers are listed below:

Mol	Chain	Res	Type
3	C	416	SER
8	I	36	ASP
13	O	26	ALA
3	c	416	SER
19	Z	31	GLN

5.3.2 Protein sidechains [i](#)

In the following table, the Percentiles column shows the percent sidechain outliers of the chain as a percentile score with respect to all X-ray entries followed by that with respect to entries of similar resolution.

The Analysed column shows the number of residues for which the sidechain conformation was analysed, and the total number of residues.

Mol	Chain	Analysed	Rotameric	Outliers	Percentiles	
1	A	444/279 (159%)	443 (100%)	1 (0%)	93	96
1	a	442/279 (158%)	441 (100%)	1 (0%)	93	96
2	B	423/403 (105%)	418 (99%)	5 (1%)	71	80
2	b	420/403 (104%)	412 (98%)	8 (2%)	57	66
3	C	431/356 (121%)	425 (99%)	6 (1%)	67	76
3	c	437/356 (123%)	431 (99%)	6 (1%)	67	76
4	D	368/277 (133%)	366 (100%)	2 (0%)	88	92
4	d	372/277 (134%)	367 (99%)	5 (1%)	69	79
5	E	72/73 (99%)	69 (96%)	3 (4%)	30	34
5	e	72/73 (99%)	71 (99%)	1 (1%)	67	76
6	F	28/38 (74%)	28 (100%)	0	100	100
6	f	26/38 (68%)	26 (100%)	0	100	100
7	H	54/54 (100%)	52 (96%)	2 (4%)	34	40
7	h	55/54 (102%)	53 (96%)	2 (4%)	35	42

Continued on next page...

Continued from previous page...

Mol	Chain	Analysed	Rotameric	Outliers	Percentiles	
8	I	34/34 (100%)	33 (97%)	1 (3%)	42	51
8	i	34/34 (100%)	33 (97%)	1 (3%)	42	51
9	J	26/27 (96%)	25 (96%)	1 (4%)	33	39
9	j	26/27 (96%)	25 (96%)	1 (4%)	33	39
10	K	30/30 (100%)	26 (87%)	4 (13%)	4	2
10	k	30/30 (100%)	26 (87%)	4 (13%)	4	2
11	L	36/35 (103%)	36 (100%)	0	100	100
11	l	36/35 (103%)	36 (100%)	0	100	100
12	M	30/32 (94%)	28 (93%)	2 (7%)	16	15
12	m	32/32 (100%)	30 (94%)	2 (6%)	18	17
13	O	216/207 (104%)	211 (98%)	5 (2%)	50	59
13	o	213/207 (103%)	207 (97%)	6 (3%)	43	52
14	T	32/28 (114%)	30 (94%)	2 (6%)	18	17
14	t	31/28 (111%)	31 (100%)	0	100	100
15	U	86/89 (97%)	84 (98%)	2 (2%)	50	59
15	u	88/89 (99%)	86 (98%)	2 (2%)	50	59
16	V	123/117 (105%)	122 (99%)	1 (1%)	81	88
16	v	123/117 (105%)	118 (96%)	5 (4%)	30	36
17	X	32/33 (97%)	32 (100%)	0	100	100
17	x	31/33 (94%)	31 (100%)	0	100	100
18	Y	22/23 (96%)	22 (100%)	0	100	100
18	y	22/23 (96%)	20 (91%)	2 (9%)	9	7
19	Z	52/52 (100%)	51 (98%)	1 (2%)	57	66
19	z	52/52 (100%)	47 (90%)	5 (10%)	8	6
20	R	29/29 (100%)	27 (93%)	2 (7%)	15	14
All	All	5110/4403 (116%)	5019 (98%)	91 (2%)	57	68

5 of 91 residues with a non-rotameric sidechain are listed below:

Mol	Chain	Res	Type
5	e	71	GLU
13	o	58	ASN
7	h	65	LEU

Continued on next page...

Continued from previous page...

Mol	Chain	Res	Type
10	k	24	VAL
15	u	10[B]	VAL

Sometimes sidechains can be flipped to improve hydrogen bonding and reduce clashes. All (2) such sidechains are listed below:

Mol	Chain	Res	Type
13	o	58	ASN
16	v	86	GLN

5.3.3 RNA [i](#)

There are no RNA molecules in this entry.

5.4 Non-standard residues in protein, DNA, RNA chains [i](#)

6 non-standard protein/DNA/RNA residues are modelled in this entry.

In the following table, the Counts columns list the number of bonds (or angles) for which Mogul statistics could be retrieved, the number of bonds (or angles) that are observed in the model and the number of bonds (or angles) that are defined in the Chemical Component Dictionary. The Link column lists molecule types, if any, to which the group is linked. The Z score for a bond length (or angle) is the number of standard deviations the observed value is removed from the expected value. A bond length (or angle) with $|Z| > 2$ is considered an outlier worth inspection. RMSZ is the root-mean-square of all Z scores of the bond lengths (or angles).

Mol	Type	Chain	Res	Link	Bond lengths			Bond angles		
					Counts	RMSZ	# Z > 2	Counts	RMSZ	# Z > 2
8	FME	i	1	8	8,9,10	0.63	0	7,9,11	1.42	1 (14%)
14	FME	T	1	14	8,9,10	0.66	0	7,9,11	1.58	2 (28%)
12	FME	M	1	12	8,9,10	0.60	0	7,9,11	1.12	1 (14%)
8	FME	I	1	8	8,9,10	0.61	0	7,9,11	1.24	1 (14%)
12	FME	m	1	12	8,9,10	0.56	0	7,9,11	1.59	2 (28%)
14	FME	t	1	14	8,9,10	0.75	0	7,9,11	1.70	2 (28%)

In the following table, the Chirals column lists the number of chiral outliers, the number of chiral centers analysed, the number of these observed in the model and the number defined in the Chemical Component Dictionary. Similar counts are reported in the Torsion and Rings columns. '-' means no outliers of that kind were identified.

Mol	Type	Chain	Res	Link	Chirals	Torsions	Rings
8	FME	i	1	8	-	1/7/9/11	-
14	FME	T	1	14	-	2/7/9/11	-
12	FME	M	1	12	-	1/7/9/11	-
8	FME	I	1	8	-	0/7/9/11	-
12	FME	m	1	12	-	2/7/9/11	-
14	FME	t	1	14	-	1/7/9/11	-

There are no bond length outliers.

The worst 5 of 9 bond angle outliers are listed below:

Mol	Chain	Res	Type	Atoms	Z	Observed(°)	Ideal(°)
12	m	1	FME	CA-N-CN	-2.80	118.51	122.82
14	T	1	FME	CG-CB-CA	2.58	120.12	112.95
14	t	1	FME	O-C-CA	-2.54	118.11	124.78
12	m	1	FME	O1-CN-N	-2.53	118.60	125.27
14	t	1	FME	CA-N-CN	-2.52	118.95	122.82

There are no chirality outliers.

5 of 7 torsion outliers are listed below:

Mol	Chain	Res	Type	Atoms
12	M	1	FME	O1-CN-N-CA
8	i	1	FME	O-C-CA-CB
12	m	1	FME	O1-CN-N-CA
12	m	1	FME	O-C-CA-CB
14	t	1	FME	O-C-CA-CB

There are no ring outliers.

No monomer is involved in short contacts.

5.5 Carbohydrates [i](#)

There are no monosaccharides in this entry.

5.6 Ligand geometry [i](#)

Of 274 ligands modelled in this entry, 21 are monoatomic and 20 are unknown - leaving 233 for Mogul analysis.

In the following table, the Counts columns list the number of bonds (or angles) for which Mogul statistics could be retrieved, the number of bonds (or angles) that are observed in the model and

the number of bonds (or angles) that are defined in the Chemical Component Dictionary. The Link column lists molecule types, if any, to which the group is linked. The Z score for a bond length (or angle) is the number of standard deviations the observed value is removed from the expected value. A bond length (or angle) with $|Z| > 2$ is considered an outlier worth inspection. RMSZ is the root-mean-square of all Z scores of the bond lengths (or angles).

Mol	Type	Chain	Res	Link	Bond lengths			Bond angles		
					Counts	RMSZ	# Z > 2	Counts	RMSZ	# Z > 2
23	CLA	c	506	41	65,73,73	2.10	17 (26%)	76,113,113	2.70	29 (38%)
23	CLA	B	606	-	65,73,73	1.96	17 (26%)	76,113,113	2.97	25 (32%)
23	CLA	C	511	-	65,73,73	2.06	16 (24%)	76,113,113	2.80	30 (39%)
34	HTG	d	411	-	16,16,19	1.00	1 (6%)	20,21,24	1.64	1 (5%)
23	CLA	B	611	-	65,73,73	2.65	18 (27%)	76,113,113	3.07	27 (35%)
31	LMT	F	101	-	36,36,36	1.05	1 (2%)	47,47,47	1.05	3 (6%)
26	SQD	f	102	-	42,43,54	1.18	3 (7%)	51,54,65	1.53	10 (19%)
34	HTG	b	625	-	19,19,19	1.07	2 (10%)	23,24,24	1.57	4 (17%)
25	BCR	C	515	-	41,41,41	1.04	1 (2%)	56,56,56	1.31	5 (8%)
23	CLA	C	509	-	65,73,73	2.15	16 (24%)	76,113,113	2.74	25 (32%)
32	LHG	L	101[A]	-	48,48,48	0.89	2 (4%)	51,54,54	1.15	3 (5%)
23	CLA	B	613	-	65,73,73	2.03	16 (24%)	76,113,113	2.75	28 (36%)
27	GOL	c	527[B]	-	5,5,5	0.97	0	5,5,5	0.95	0
37	BCT	d	401[B]	21	2,3,3	0.66	0	2,3,3	1.24	0
27	GOL	C	523[A]	-	5,5,5	1.18	0	5,5,5	0.83	0
33	LMG	Z	101	-	37,37,55	1.01	2 (5%)	45,45,63	1.42	6 (13%)
25	BCR	t	102	-	41,41,41	1.05	1 (2%)	56,56,56	1.61	11 (19%)
37	BCT	D	401[B]	21	2,3,3	0.61	0	2,3,3	1.21	0
27	GOL	A	411	-	5,5,5	1.24	0	5,5,5	0.71	0
23	CLA	B	616	-	65,73,73	2.03	16 (24%)	76,113,113	2.84	23 (30%)
25	BCR	A	409	-	41,41,41	0.99	1 (2%)	56,56,56	1.38	7 (12%)
35	DGD	c	519[B]	-	63,63,67	0.86	2 (3%)	77,77,81	0.98	3 (3%)
27	GOL	B	628	-	5,5,5	0.97	0	5,5,5	1.10	0
27	GOL	v	202[B]	-	5,5,5	1.09	0	5,5,5	0.87	0
23	CLA	A	404[A]	-	65,73,73	2.02	16 (24%)	76,113,113	2.77	32 (42%)
29	PL9	d	406[B]	-	55,55,55	0.67	1 (1%)	68,69,69	1.66	21 (30%)
23	CLA	B	609	-	65,73,73	2.02	17 (26%)	76,113,113	2.73	28 (36%)
23	CLA	B	612	-	65,73,73	2.00	17 (26%)	76,113,113	2.88	28 (36%)
23	CLA	b	605	-	65,73,73	1.92	16 (24%)	76,113,113	2.99	26 (34%)
25	BCR	B	618	-	41,41,41	0.99	1 (2%)	56,56,56	1.40	9 (16%)
32	LHG	a	417[B]	-	41,41,48	1.03	2 (4%)	44,47,54	0.94	2 (4%)
40	HEC	V	201	16	32,50,50	1.98	4 (12%)	24,82,82	2.06	7 (29%)

Mol	Type	Chain	Res	Link	Bond lengths			Bond angles		
					Counts	RMSZ	# Z > 2	Counts	RMSZ	# Z > 2
38	HEM	f	101	6,5	41,50,50	1.29	5 (12%)	45,82,82	1.78	11 (24%)
23	CLA	D	403	-	65,73,73	2.08	15 (23%)	76,113,113	2.73	28 (36%)
25	BCR	h	101	-	41,41,41	1.01	1 (2%)	56,56,56	1.41	8 (14%)
34	HTG	b	622	-	19,19,19	1.15	2 (10%)	23,24,24	1.95	8 (34%)
23	CLA	b	608	-	65,73,73	2.01	18 (27%)	76,113,113	2.79	31 (40%)
23	CLA	A	408	-	65,73,73	1.99	15 (23%)	76,113,113	2.91	32 (42%)
34	HTG	o	301	-	19,19,19	1.16	2 (10%)	23,24,24	1.60	6 (26%)
24	PHO	A	407[A]	-	51,69,69	1.78	8 (15%)	47,99,99	1.77	11 (23%)
35	DGD	c	518[B]	-	63,63,67	0.85	2 (3%)	77,77,81	1.04	5 (6%)
33	LMG	C	521	-	51,51,55	1.08	3 (5%)	59,59,63	1.34	7 (11%)
34	HTG	C	522	-	19,19,19	0.86	1 (5%)	23,24,24	1.27	1 (4%)
23	CLA	D	402[A]	-	65,73,73	1.99	16 (24%)	76,113,113	2.87	29 (38%)
25	BCR	a	408	-	41,41,41	1.04	1 (2%)	56,56,56	1.33	7 (12%)
23	CLA	d	403[A]	-	65,73,73	1.94	17 (26%)	76,113,113	2.79	29 (38%)
23	CLA	A	405[B]	41	65,73,73	2.00	15 (23%)	76,113,113	2.75	29 (38%)
32	LHG	b	629[B]	-	48,48,48	0.88	2 (4%)	51,54,54	1.05	4 (7%)
27	GOL	B	623	-	5,5,5	0.80	0	5,5,5	1.24	1 (20%)
32	LHG	d	408[A]	-	48,48,48	0.92	2 (4%)	51,54,54	0.99	3 (5%)
23	CLA	c	511	-	65,73,73	2.07	16 (24%)	76,113,113	2.83	29 (38%)
27	GOL	O	303	-	5,5,5	0.83	0	5,5,5	1.06	0
32	LHG	E	101[A]	-	41,41,48	1.06	2 (4%)	44,47,54	1.11	3 (6%)
23	CLA	b	601	41	65,73,73	2.14	15 (23%)	76,113,113	2.77	26 (34%)
23	CLA	B	614	-	65,73,73	2.00	16 (24%)	76,113,113	2.92	30 (39%)
23	CLA	B	601	41	65,73,73	2.10	17 (26%)	76,113,113	2.77	28 (36%)
23	CLA	a	404[A]	-	65,73,73	1.99	15 (23%)	76,113,113	2.87	32 (42%)
26	SQD	a	410	-	53,54,54	1.05	3 (5%)	62,65,65	1.23	8 (12%)
23	CLA	c	508	-	65,73,73	2.05	16 (24%)	76,113,113	2.75	28 (36%)
27	GOL	D	412	-	5,5,5	1.40	1 (20%)	5,5,5	0.85	0
35	DGD	C	517[A]	-	63,63,67	0.81	2 (3%)	77,77,81	1.21	8 (10%)
38	HEM	E	102	6,5	41,50,50	1.28	5 (12%)	45,82,82	2.06	14 (31%)
23	CLA	a	405[A]	41	65,73,73	1.94	16 (24%)	76,113,113	2.81	27 (35%)
35	DGD	h	102	-	63,63,67	0.87	3 (4%)	77,77,81	1.05	5 (6%)
29	PL9	A	414[B]	-	55,55,55	0.67	2 (3%)	68,69,69	2.00	25 (36%)
31	LMT	B	629	-	36,36,36	1.01	3 (8%)	47,47,47	1.19	6 (12%)
35	DGD	C	519	-	63,63,67	0.88	3 (4%)	77,77,81	0.96	3 (3%)

Mol	Type	Chain	Res	Link	Bond lengths			Bond angles		
					Counts	RMSZ	# Z > 2	Counts	RMSZ	# Z > 2
28	OEX	a	411[A]	1,3,41	0,15,15	-	-	-	-	-
32	LHG	D	407[B]	-	48,48,48	0.93	2 (4%)	51,54,54	1.00	3 (5%)
23	CLA	d	404	-	65,73,73	2.04	16 (24%)	76,113,113	2.87	30 (39%)
26	SQD	A	410[B]	-	53,54,54	0.94	3 (5%)	62,65,65	1.84	10 (16%)
31	LMT	M	101	-	36,36,36	1.12	3 (8%)	47,47,47	1.19	4 (8%)
40	HEC	v	201	16	32,50,50	2.05	3 (9%)	24,82,82	2.08	6 (25%)
34	HTG	B	622	-	19,19,19	0.81	1 (5%)	23,24,24	1.36	1 (4%)
23	CLA	b	616	-	65,73,73	2.04	15 (23%)	76,113,113	2.89	28 (36%)
25	BCR	D	404	-	41,41,41	1.10	1 (2%)	56,56,56	1.83	14 (25%)
25	BCR	c	516	-	41,41,41	0.99	1 (2%)	56,56,56	1.59	10 (17%)
23	CLA	C	506	-	65,73,73	2.00	16 (24%)	76,113,113	2.68	26 (34%)
24	PHO	a	406[B]	-	51,69,69	1.83	7 (13%)	47,99,99	1.80	8 (17%)
32	LHG	D	406[A]	-	48,48,48	0.86	2 (4%)	51,54,54	0.99	3 (5%)
27	GOL	V	203[A]	-	5,5,5	1.22	0	5,5,5	0.91	0
23	CLA	c	514	-	65,73,73	2.05	16 (24%)	76,113,113	2.76	29 (38%)
29	PL9	D	405[B]	-	55,55,55	0.63	2 (3%)	68,69,69	1.61	15 (22%)
34	HTG	D	410	-	16,16,19	1.06	2 (12%)	20,21,24	1.47	1 (5%)
32	LHG	d	414[B]	-	48,48,48	0.88	2 (4%)	51,54,54	1.06	5 (9%)
31	LMT	A	417	-	36,36,36	0.92	0	47,47,47	1.06	1 (2%)
26	SQD	a	409[B]	-	53,54,54	0.99	3 (5%)	62,65,65	1.64	10 (16%)
23	CLA	A	406[B]	41	65,73,73	2.03	16 (24%)	76,113,113	2.77	28 (36%)
25	BCR	C	516	-	41,41,41	1.04	1 (2%)	56,56,56	1.37	7 (12%)
23	CLA	b	612	-	65,73,73	2.03	16 (24%)	76,113,113	2.73	27 (35%)
27	GOL	o	303	-	5,5,5	1.03	0	5,5,5	0.94	0
26	SQD	F	102	-	42,43,54	1.19	4 (9%)	51,54,65	2.14	14 (27%)
25	BCR	B	617	-	41,41,41	1.08	1 (2%)	56,56,56	1.31	6 (10%)
27	GOL	o	304	-	5,5,5	1.11	1 (20%)	5,5,5	1.04	0
28	OEX	A	413[B]	1,3,41	0,15,15	-	-	-	-	-
23	CLA	c	507	-	65,73,73	1.96	16 (24%)	76,113,113	2.74	25 (32%)
31	LMT	b	621	-	25,25,36	0.95	1 (4%)	30,30,47	1.20	3 (10%)
25	BCR	Y	101	-	41,41,41	1.00	1 (2%)	56,56,56	1.62	13 (23%)
23	CLA	C	507	-	65,73,73	2.04	18 (27%)	76,113,113	2.78	29 (38%)
23	CLA	c	504	-	65,73,73	2.08	16 (24%)	76,113,113	2.72	25 (32%)
24	PHO	A	416[B]	-	51,69,69	1.91	8 (15%)	47,99,99	1.86	11 (23%)
32	LHG	L	101[B]	-	48,48,48	0.91	2 (4%)	51,54,54	1.09	3 (5%)

Mol	Type	Chain	Res	Link	Bond lengths			Bond angles		
					Counts	RMSZ	# Z > 2	Counts	RMSZ	# Z > 2
33	LMG	m	101	-	51,51,55	0.87	2 (3%)	59,59,63	1.30	8 (13%)
34	HTG	V	202	-	11,11,19	0.36	0	15,15,24	1.12	1 (6%)
33	LMG	z	101	-	39,39,55	1.09	2 (5%)	47,47,63	1.09	3 (6%)
35	DGD	H	101	-	63,63,67	0.88	3 (4%)	77,77,81	1.07	6 (7%)
37	BCT	d	401[A]	21	2,3,3	0.57	0	2,3,3	1.58	1 (50%)
25	BCR	d	405	-	41,41,41	1.13	2 (4%)	56,56,56	1.95	17 (30%)
37	BCT	D	401[A]	21	2,3,3	0.54	0	2,3,3	1.81	1 (50%)
23	CLA	B	608	-	65,73,73	1.98	17 (26%)	76,113,113	2.77	32 (42%)
25	BCR	B	619	-	41,41,41	1.10	2 (4%)	56,56,56	1.35	9 (16%)
23	CLA	C	504	-	65,73,73	1.99	16 (24%)	76,113,113	2.88	27 (35%)
23	CLA	b	606	-	65,73,73	1.98	15 (23%)	76,113,113	2.83	28 (36%)
31	LMT	A	420	-	36,36,36	1.06	2 (5%)	47,47,47	1.16	4 (8%)
27	GOL	B	626	-	5,5,5	1.11	0	5,5,5	0.98	0
27	GOL	v	202[A]	-	5,5,5	1.27	0	5,5,5	0.72	0
23	CLA	B	603	-	65,73,73	2.07	16 (24%)	76,113,113	2.98	30 (39%)
29	PL9	d	406[A]	-	55,55,55	0.65	1 (1%)	68,69,69	1.63	17 (25%)
32	LHG	d	407[A]	-	48,48,48	0.86	2 (4%)	51,54,54	1.08	4 (7%)
27	GOL	a	416	-	5,5,5	1.20	1 (20%)	5,5,5	0.93	0
27	GOL	l	801[A]	-	5,5,5	0.96	0	5,5,5	0.97	0
23	CLA	A	404[B]	-	65,73,73	2.09	15 (23%)	76,113,113	2.75	31 (40%)
32	LHG	a	417[A]	-	41,41,48	1.04	2 (4%)	44,47,54	0.92	2 (4%)
31	LMT	B	630	-	25,25,36	0.88	1 (4%)	30,30,47	1.16	3 (10%)
23	CLA	b	610	41	65,73,73	2.00	17 (26%)	76,113,113	2.80	29 (38%)
23	CLA	b	613	-	65,73,73	2.02	15 (23%)	76,113,113	2.79	28 (36%)
33	LMG	C	501	-	51,51,55	0.92	2 (3%)	59,59,63	1.50	8 (13%)
23	CLA	c	509	41	65,73,73	2.02	16 (24%)	76,113,113	2.86	27 (35%)
35	DGD	C	518[A]	-	63,63,67	0.89	3 (4%)	77,77,81	1.02	5 (6%)
24	PHO	A	407[B]	-	51,69,69	1.79	7 (13%)	47,99,99	1.84	11 (23%)
25	BCR	T	101	-	41,41,41	1.01	1 (2%)	56,56,56	1.54	10 (17%)
23	CLA	d	402[B]	41	65,73,73	2.03	16 (24%)	76,113,113	2.77	28 (36%)
25	BCR	c	517	-	41,41,41	1.04	1 (2%)	56,56,56	1.40	12 (21%)
23	CLA	B	605	-	65,73,73	1.98	15 (23%)	76,113,113	2.87	27 (35%)
34	HTG	c	523	-	19,19,19	0.97	1 (5%)	23,24,24	1.54	2 (8%)
31	LMT	B	627	-	36,36,36	1.16	4 (11%)	47,47,47	1.36	6 (12%)
23	CLA	B	607	41	65,73,73	1.98	17 (26%)	76,113,113	2.79	26 (34%)

Mol	Type	Chain	Res	Link	Bond lengths			Bond angles		
					Counts	RMSZ	# Z > 2	Counts	RMSZ	# Z > 2
23	CLA	D	402[B]	-	65,73,73	1.98	16 (24%)	76,113,113	2.87	30 (39%)
23	CLA	C	508	41	65,73,73	2.00	16 (24%)	76,113,113	2.79	28 (36%)
25	BCR	k	101	-	41,41,41	1.07	1 (2%)	56,56,56	1.53	12 (21%)
23	CLA	C	514	-	65,73,73	2.06	16 (24%)	76,113,113	2.76	27 (35%)
24	PHO	a	414[A]	-	51,69,69	1.86	9 (17%)	47,99,99	1.99	13 (27%)
23	CLA	c	512	-	65,73,73	2.00	15 (23%)	76,113,113	2.84	30 (39%)
23	CLA	b	615	-	65,73,73	2.02	16 (24%)	76,113,113	2.77	28 (36%)
32	LHG	d	408[B]	-	48,48,48	0.95	2 (4%)	51,54,54	1.07	5 (9%)
32	LHG	A	419[A]	-	48,48,48	0.84	2 (4%)	51,54,54	1.31	6 (11%)
23	CLA	C	512	3	65,73,73	2.06	18 (27%)	76,113,113	2.69	26 (34%)
29	PL9	a	412[A]	-	55,55,55	0.65	2 (3%)	68,69,69	2.00	22 (32%)
23	CLA	a	407	-	65,73,73	1.96	16 (24%)	76,113,113	2.90	28 (36%)
23	CLA	b	603	-	65,73,73	2.00	16 (24%)	76,113,113	2.84	31 (40%)
23	CLA	c	515	-	65,73,73	2.10	17 (26%)	76,113,113	2.79	28 (36%)
34	HTG	B	624	-	19,19,19	1.01	2 (10%)	23,24,24	1.22	4 (17%)
23	CLA	b	602	-	65,73,73	2.04	16 (24%)	76,113,113	2.92	32 (42%)
27	GOL	b	624	-	5,5,5	1.23	1 (20%)	5,5,5	0.75	0
29	PL9	A	414[A]	-	55,55,55	0.68	2 (3%)	68,69,69	2.08	25 (36%)
26	SQD	B	620	-	53,54,54	1.04	3 (5%)	62,65,65	1.81	12 (19%)
32	LHG	D	407[A]	-	48,48,48	0.92	2 (4%)	51,54,54	0.99	4 (7%)
23	CLA	C	502	-	65,73,73	1.98	16 (24%)	76,113,113	2.81	29 (38%)
26	SQD	A	410[A]	-	53,54,54	0.93	3 (5%)	62,65,65	1.81	10 (16%)
27	GOL	c	527[A]	-	5,5,5	0.94	0	5,5,5	0.95	0
25	BCR	X	101	-	41,41,41	1.05	1 (2%)	56,56,56	1.40	7 (12%)
25	BCR	b	618	-	41,41,41	1.01	1 (2%)	56,56,56	1.17	5 (8%)
35	DGD	c	520	-	63,63,67	0.88	4 (6%)	77,77,81	1.03	5 (6%)
33	LMG	C	520	-	51,51,55	0.96	2 (3%)	59,59,63	1.11	4 (6%)
25	BCR	b	619	-	41,41,41	1.07	1 (2%)	56,56,56	1.36	8 (14%)
32	LHG	D	406[B]	-	48,48,48	0.88	2 (4%)	51,54,54	0.99	3 (5%)
27	GOL	C	523[B]	-	5,5,5	1.07	0	5,5,5	0.88	0
32	LHG	d	414[A]	-	48,48,48	0.89	2 (4%)	51,54,54	1.12	4 (7%)
31	LMT	M	103	-	36,36,36	1.08	3 (8%)	47,47,47	1.08	2 (4%)
35	DGD	c	519[A]	-	63,63,67	0.84	2 (3%)	77,77,81	0.97	5 (6%)
33	LMG	d	412	39	51,51,55	0.89	2 (3%)	59,59,63	1.11	4 (6%)
28	OEX	A	413[A]	1,3,41	0,15,15	-	-	-	-	-

Mol	Type	Chain	Res	Link	Bond lengths			Bond angles		
					Counts	RMSZ	# Z > 2	Counts	RMSZ	# Z > 2
33	LMG	B	621	-	51,51,55	0.92	2 (3%)	59,59,63	1.31	7 (11%)
33	LMG	c	501	-	51,51,55	0.91	2 (3%)	59,59,63	1.21	5 (8%)
31	LMT	b	627	-	25,25,36	0.90	0	30,30,47	1.08	2 (6%)
23	CLA	c	503	-	65,73,73	2.02	17 (26%)	76,113,113	2.82	26 (34%)
27	GOL	a	415	-	5,5,5	1.05	0	5,5,5	0.97	0
24	PHO	A	416[A]	-	51,69,69	1.87	8 (15%)	47,99,99	1.93	12 (25%)
33	LMG	c	521	-	51,51,55	0.91	2 (3%)	59,59,63	1.15	5 (8%)
25	BCR	b	617	-	41,41,41	1.08	1 (2%)	56,56,56	1.40	7 (12%)
27	GOL	O	302	-	5,5,5	0.89	0	5,5,5	0.92	0
35	DGD	c	518[A]	-	63,63,67	0.85	2 (3%)	77,77,81	1.12	6 (7%)
23	CLA	B	604	-	65,73,73	2.04	18 (27%)	76,113,113	2.57	27 (35%)
23	CLA	c	510	-	65,73,73	2.17	16 (24%)	76,113,113	2.57	26 (34%)
23	CLA	C	505	41	65,73,73	2.03	15 (23%)	76,113,113	2.70	25 (32%)
26	SQD	b	620	-	53,54,54	1.03	3 (5%)	62,65,65	1.68	11 (17%)
23	CLA	A	405[A]	41	65,73,73	1.90	16 (24%)	76,113,113	2.85	30 (39%)
32	LHG	b	629[A]	-	48,48,48	0.85	3 (6%)	51,54,54	1.03	4 (7%)
23	CLA	b	614	-	65,73,73	1.98	15 (23%)	76,113,113	2.80	27 (35%)
23	CLA	d	403[B]	-	65,73,73	2.02	16 (24%)	76,113,113	2.78	30 (39%)
34	HTG	b	623	-	19,19,19	1.08	1 (5%)	23,24,24	1.85	2 (8%)
27	GOL	d	413	-	5,5,5	1.11	0	5,5,5	0.97	0
32	LHG	d	407[B]	-	48,48,48	0.89	2 (4%)	51,54,54	1.10	5 (9%)
33	LMG	D	411	39	51,51,55	0.81	2 (3%)	59,59,63	1.10	3 (5%)
27	GOL	l	801[B]	-	5,5,5	0.92	0	5,5,5	0.98	0
23	CLA	B	602	-	65,73,73	2.07	16 (24%)	76,113,113	2.88	31 (40%)
31	LMT	e	101	-	36,36,36	1.04	3 (8%)	47,47,47	0.95	1 (2%)
23	CLA	b	611	-	65,73,73	2.01	16 (24%)	76,113,113	2.90	26 (34%)
25	BCR	y	101	-	41,41,41	1.03	1 (2%)	56,56,56	1.55	10 (17%)
23	CLA	C	503	-	65,73,73	2.03	16 (24%)	76,113,113	2.67	27 (35%)
32	LHG	E	101[B]	-	41,41,48	1.05	2 (4%)	44,47,54	1.09	4 (9%)
33	LMG	c	522	-	51,51,55	1.00	2 (3%)	59,59,63	1.38	7 (11%)
31	LMT	c	502	-	36,36,36	1.01	1 (2%)	47,47,47	1.01	1 (2%)
23	CLA	B	615	-	65,73,73	1.97	14 (21%)	76,113,113	2.85	29 (38%)
23	CLA	a	404[B]	-	65,73,73	2.01	16 (24%)	76,113,113	2.87	32 (42%)
35	DGD	C	517[B]	-	63,63,67	0.83	2 (3%)	77,77,81	1.10	6 (7%)
31	LMT	t	101	-	26,26,36	0.92	2 (7%)	31,31,47	1.35	2 (6%)

Mol	Type	Chain	Res	Link	Bond lengths			Bond angles		
					Counts	RMSZ	# Z > 2	Counts	RMSZ	# Z > 2
25	BCR	K	102	-	41,41,41	1.05	1 (2%)	56,56,56	1.41	9 (16%)
23	CLA	d	402[A]	41	65,73,73	2.00	14 (21%)	76,113,113	2.75	26 (34%)
23	CLA	a	405[B]	41	65,73,73	2.04	16 (24%)	76,113,113	2.76	26 (34%)
35	DGD	C	518[B]	-	63,63,67	0.87	3 (4%)	77,77,81	1.01	5 (6%)
23	CLA	B	610	41	65,73,73	2.02	17 (26%)	76,113,113	2.88	30 (39%)
23	CLA	c	513	3	65,73,73	2.11	16 (24%)	76,113,113	2.76	29 (38%)
23	CLA	C	510	-	65,73,73	2.11	17 (26%)	76,113,113	2.83	29 (38%)
23	CLA	b	604	-	65,73,73	1.98	17 (26%)	76,113,113	2.72	25 (32%)
23	CLA	c	505	-	65,73,73	2.02	16 (24%)	76,113,113	2.81	27 (35%)
27	GOL	b	628	-	5,5,5	0.58	0	5,5,5	1.35	1 (20%)
28	OEX	a	411[B]	1,3,41	0,15,15	-	-	-	-	-
23	CLA	b	607	41	65,73,73	1.97	17 (26%)	76,113,113	2.78	25 (32%)
31	LMT	m	103	-	36,36,36	1.09	3 (8%)	47,47,47	1.11	4 (8%)
27	GOL	c	528	-	5,5,5	1.22	1 (20%)	5,5,5	0.94	0
23	CLA	C	513	-	65,73,73	2.05	16 (24%)	76,113,113	2.78	31 (40%)
23	CLA	b	609	-	65,73,73	1.99	16 (24%)	76,113,113	2.80	32 (42%)
24	PHO	a	406[A]	-	51,69,69	1.83	8 (15%)	47,99,99	1.71	10 (21%)
24	PHO	a	414[B]	-	51,69,69	1.88	8 (15%)	47,99,99	1.96	13 (27%)
29	PL9	D	405[A]	-	55,55,55	0.62	2 (3%)	68,69,69	1.64	18 (26%)
27	GOL	A	418	-	5,5,5	1.62	2 (40%)	5,5,5	0.94	1 (20%)
27	GOL	V	203[B]	-	5,5,5	1.18	0	5,5,5	0.90	0
26	SQD	a	409[A]	-	53,54,54	0.95	3 (5%)	62,65,65	1.77	13 (20%)
23	CLA	A	406[A]	41	65,73,73	1.96	16 (24%)	76,113,113	2.81	29 (38%)
32	LHG	A	419[B]	-	48,48,48	0.87	2 (4%)	51,54,54	1.19	5 (9%)
26	SQD	A	412	-	53,54,54	1.01	3 (5%)	62,65,65	1.24	6 (9%)
29	PL9	a	412[B]	-	55,55,55	0.63	2 (3%)	68,69,69	2.00	22 (32%)

In the following table, the Chirals column lists the number of chiral outliers, the number of chiral centers analysed, the number of these observed in the model and the number defined in the Chemical Component Dictionary. Similar counts are reported in the Torsion and Rings columns. '-' means no outliers of that kind were identified.

Mol	Type	Chain	Res	Link	Chirals	Torsions	Rings
23	CLA	c	506	41	1/1/15/20	6/37/115/115	-
23	CLA	B	606	-	1/1/15/20	10/37/115/115	-
23	CLA	C	511	-	1/1/15/20	14/37/115/115	-

Continued on next page...

Continued from previous page...

Mol	Type	Chain	Res	Link	Chirals	Torsions	Rings
34	HTG	d	411	-	-	1/7/27/30	0/1/1/1
23	CLA	B	611	-	1/1/15/20	2/37/115/115	-
31	LMT	F	101	-	-	8/21/61/61	0/2/2/2
26	SQD	f	102	-	-	12/38/58/69	0/1/1/1
34	HTG	b	625	-	-	3/10/30/30	0/1/1/1
25	BCR	C	515	-	-	1/29/63/63	0/2/2/2
23	CLA	C	509	-	1/1/15/20	5/37/115/115	-
32	LHG	L	101[A]	-	-	19/53/53/53	-
23	CLA	B	613	-	1/1/15/20	7/37/115/115	-
27	GOL	c	527[B]	-	-	0/4/4/4	-
27	GOL	C	523[A]	-	-	0/4/4/4	-
33	LMG	Z	101	-	-	10/31/51/70	0/1/1/1
25	BCR	t	102	-	-	4/29/63/63	0/2/2/2
27	GOL	A	411	-	-	2/4/4/4	-
23	CLA	B	616	-	1/1/15/20	6/37/115/115	-
25	BCR	A	409	-	-	0/29/63/63	0/2/2/2
35	DGD	c	519[B]	-	-	16/51/91/95	0/2/2/2
27	GOL	B	628	-	-	4/4/4/4	-
27	GOL	v	202[B]	-	-	2/4/4/4	-
23	CLA	A	404[A]	-	1/1/15/20	5/37/115/115	-
29	PL9	d	406[B]	-	-	7/53/73/73	0/1/1/1
23	CLA	B	609	-	1/1/15/20	1/37/115/115	-
23	CLA	B	612	-	1/1/15/20	4/37/115/115	-
23	CLA	b	605	-	1/1/15/20	7/37/115/115	-
25	BCR	B	618	-	-	0/29/63/63	0/2/2/2
32	LHG	a	417[B]	-	-	16/46/46/53	-
40	HEC	V	201	16	-	2/10/54/54	-
38	HEM	f	101	6,5	-	6/12/54/54	-
23	CLA	D	403	-	1/1/15/20	13/37/115/115	-
25	BCR	h	101	-	-	2/29/63/63	0/2/2/2
34	HTG	b	622	-	-	5/10/30/30	0/1/1/1
23	CLA	b	608	-	-	4/37/115/115	-
23	CLA	A	408	-	1/1/15/20	8/37/115/115	-
34	HTG	o	301	-	-	4/10/30/30	0/1/1/1
24	PHO	A	407[A]	-	-	4/37/103/103	0/5/6/6

Continued on next page...

Continued from previous page...

Mol	Type	Chain	Res	Link	Chirals	Torsions	Rings
35	DGD	c	518[B]	-	-	19/51/91/95	0/2/2/2
33	LMG	C	521	-	-	12/46/66/70	0/1/1/1
34	HTG	C	522	-	-	0/10/30/30	0/1/1/1
23	CLA	D	402[A]	-	1/1/15/20	0/37/115/115	-
25	BCR	a	408	-	-	0/29/63/63	0/2/2/2
23	CLA	d	403[A]	-	1/1/15/20	2/37/115/115	-
23	CLA	A	405[B]	41	1/1/15/20	4/37/115/115	-
32	LHG	b	629[B]	-	-	16/53/53/53	-
27	GOL	B	623	-	-	4/4/4/4	-
32	LHG	d	408[A]	-	-	11/53/53/53	-
23	CLA	c	511	-	1/1/15/20	12/37/115/115	-
27	GOL	O	303	-	-	1/4/4/4	-
32	LHG	E	101[A]	-	-	22/46/46/53	-
23	CLA	b	601	41	1/1/15/20	17/37/115/115	-
23	CLA	B	614	-	1/1/15/20	13/37/115/115	-
23	CLA	B	601	41	1/1/15/20	12/37/115/115	-
23	CLA	a	404[A]	-	1/1/15/20	3/37/115/115	-
26	SQD	a	410	-	-	12/49/69/69	0/1/1/1
23	CLA	c	508	-	1/1/15/20	9/37/115/115	-
27	GOL	D	412	-	-	4/4/4/4	-
35	DGD	C	517[A]	-	-	11/51/91/95	0/2/2/2
38	HEM	E	102	6,5	-	3/12/54/54	-
23	CLA	a	405[A]	41	-	5/37/115/115	-
35	DGD	h	102	-	-	14/51/91/95	0/2/2/2
29	PL9	A	414[B]	-	-	16/53/73/73	0/1/1/1
31	LMT	B	629	-	-	12/21/61/61	0/2/2/2
35	DGD	C	519	-	-	18/51/91/95	0/2/2/2
32	LHG	D	407[B]	-	-	13/53/53/53	-
23	CLA	d	404	-	1/1/15/20	9/37/115/115	-
26	SQD	A	410[B]	-	-	10/49/69/69	0/1/1/1
31	LMT	M	101	-	-	4/21/61/61	0/2/2/2
40	HEC	v	201	16	-	2/10/54/54	-
34	HTG	B	622	-	-	2/10/30/30	0/1/1/1
23	CLA	b	616	-	1/1/15/20	8/37/115/115	-
25	BCR	D	404	-	-	3/29/63/63	0/2/2/2

Continued on next page...

Continued from previous page...

Mol	Type	Chain	Res	Link	Chirals	Torsions	Rings
25	BCR	c	516	-	-	1/29/63/63	0/2/2/2
23	CLA	C	506	-	1/1/15/20	6/37/115/115	-
24	PHO	a	406[B]	-	-	4/37/103/103	0/5/6/6
32	LHG	D	406[A]	-	-	16/53/53/53	-
27	GOL	V	203[A]	-	-	2/4/4/4	-
23	CLA	c	514	-	1/1/15/20	12/37/115/115	-
29	PL9	D	405[B]	-	-	8/53/73/73	0/1/1/1
34	HTG	D	410	-	-	3/7/27/30	0/1/1/1
32	LHG	d	414[B]	-	-	10/53/53/53	-
31	LMT	A	417	-	-	7/21/61/61	0/2/2/2
26	SQD	a	409[B]	-	-	10/49/69/69	0/1/1/1
23	CLA	A	406[B]	41	-	5/37/115/115	-
25	BCR	C	516	-	-	0/29/63/63	0/2/2/2
23	CLA	b	612	-	1/1/15/20	3/37/115/115	-
27	GOL	o	303	-	-	2/4/4/4	-
26	SQD	F	102	-	-	16/38/58/69	0/1/1/1
25	BCR	B	617	-	-	2/29/63/63	0/2/2/2
27	GOL	o	304	-	-	4/4/4/4	-
23	CLA	c	507	-	1/1/15/20	7/37/115/115	-
31	LMT	b	621	-	-	8/17/37/61	0/1/1/2
25	BCR	Y	101	-	-	4/29/63/63	0/2/2/2
23	CLA	C	507	-	1/1/15/20	10/37/115/115	-
23	CLA	c	504	-	1/1/15/20	7/37/115/115	-
24	PHO	A	416[B]	-	-	3/37/103/103	0/5/6/6
32	LHG	L	101[B]	-	-	16/53/53/53	-
33	LMG	m	101	-	-	11/46/66/70	0/1/1/1
34	HTG	V	202	-	-	1/2/19/30	0/1/1/1
33	LMG	z	101	-	-	9/34/54/70	0/1/1/1
35	DGD	H	101	-	-	10/51/91/95	0/2/2/2
25	BCR	d	405	-	-	6/29/63/63	0/2/2/2
23	CLA	B	608	-	-	4/37/115/115	-
25	BCR	B	619	-	-	0/29/63/63	0/2/2/2
23	CLA	C	504	-	-	3/37/115/115	-
23	CLA	b	606	-	1/1/15/20	12/37/115/115	-
31	LMT	A	420	-	-	16/21/61/61	0/2/2/2

Continued on next page...

Continued from previous page...

Mol	Type	Chain	Res	Link	Chirals	Torsions	Rings
27	GOL	B	626	-	-	1/4/4/4	-
27	GOL	v	202[A]	-	-	1/4/4/4	-
23	CLA	B	603	-	1/1/15/20	8/37/115/115	-
29	PL9	d	406[A]	-	-	6/53/73/73	0/1/1/1
32	LHG	d	407[A]	-	-	13/53/53/53	-
27	GOL	a	416	-	-	0/4/4/4	-
27	GOL	l	801[A]	-	-	2/4/4/4	-
23	CLA	A	404[B]	-	1/1/15/20	4/37/115/115	-
32	LHG	a	417[A]	-	-	16/46/46/53	-
31	LMT	B	630	-	-	10/17/37/61	0/1/1/2
23	CLA	b	610	41	1/1/15/20	9/37/115/115	-
23	CLA	b	613	-	1/1/15/20	4/37/115/115	-
33	LMG	C	501	-	-	14/46/66/70	0/1/1/1
23	CLA	c	509	41	1/1/15/20	6/37/115/115	-
35	DGD	C	518[A]	-	-	15/51/91/95	0/2/2/2
24	PHO	A	407[B]	-	-	5/37/103/103	0/5/6/6
25	BCR	T	101	-	-	3/29/63/63	0/2/2/2
23	CLA	d	402[B]	41	1/1/15/20	4/37/115/115	-
25	BCR	c	517	-	-	1/29/63/63	0/2/2/2
23	CLA	B	605	-	1/1/15/20	5/37/115/115	-
34	HTG	c	523	-	-	2/10/30/30	0/1/1/1
31	LMT	B	627	-	-	11/21/61/61	0/2/2/2
23	CLA	B	607	41	1/1/15/20	5/37/115/115	-
23	CLA	D	402[B]	-	1/1/15/20	0/37/115/115	-
23	CLA	C	508	41	1/1/15/20	7/37/115/115	-
25	BCR	k	101	-	-	0/29/63/63	0/2/2/2
23	CLA	C	514	-	1/1/15/20	7/37/115/115	-
24	PHO	a	414[A]	-	-	2/37/103/103	0/5/6/6
23	CLA	c	512	-	1/1/15/20	12/37/115/115	-
23	CLA	b	615	-	1/1/15/20	7/37/115/115	-
32	LHG	d	408[B]	-	-	12/53/53/53	-
32	LHG	A	419[A]	-	-	10/53/53/53	-
23	CLA	C	512	3	1/1/15/20	4/37/115/115	-
29	PL9	a	412[A]	-	-	14/53/73/73	0/1/1/1
23	CLA	a	407	-	1/1/15/20	9/37/115/115	-

Continued on next page...

Continued from previous page...

Mol	Type	Chain	Res	Link	Chirals	Torsions	Rings
23	CLA	b	603	-	1/1/15/20	5/37/115/115	-
23	CLA	c	515	-	1/1/15/20	7/37/115/115	-
34	HTG	B	624	-	-	3/10/30/30	0/1/1/1
23	CLA	b	602	-	1/1/15/20	4/37/115/115	-
27	GOL	b	624	-	-	2/4/4/4	-
29	PL9	A	414[A]	-	-	15/53/73/73	0/1/1/1
26	SQD	B	620	-	-	13/49/69/69	0/1/1/1
32	LHG	D	407[A]	-	-	14/53/53/53	-
23	CLA	C	502	-	1/1/15/20	5/37/115/115	-
26	SQD	A	410[A]	-	-	12/49/69/69	0/1/1/1
27	GOL	c	527[A]	-	-	0/4/4/4	-
25	BCR	X	101	-	-	2/29/63/63	0/2/2/2
25	BCR	b	618	-	-	0/29/63/63	0/2/2/2
35	DGD	c	520	-	-	8/51/91/95	0/2/2/2
33	LMG	C	520	-	-	9/46/66/70	0/1/1/1
25	BCR	b	619	-	-	2/29/63/63	0/2/2/2
32	LHG	D	406[B]	-	-	15/53/53/53	-
27	GOL	C	523[B]	-	-	0/4/4/4	-
32	LHG	d	414[A]	-	-	13/53/53/53	-
31	LMT	M	103	-	-	6/21/61/61	0/2/2/2
35	DGD	c	519[A]	-	-	17/51/91/95	0/2/2/2
33	LMG	d	412	39	-	11/46/66/70	0/1/1/1
33	LMG	B	621	-	-	17/46/66/70	0/1/1/1
33	LMG	c	501	-	-	13/46/66/70	0/1/1/1
31	LMT	b	627	-	-	11/17/37/61	0/1/1/2
23	CLA	c	503	-	1/1/15/20	1/37/115/115	-
27	GOL	a	415	-	-	2/4/4/4	-
24	PHO	A	416[A]	-	-	1/37/103/103	0/5/6/6
33	LMG	c	521	-	-	11/46/66/70	0/1/1/1
25	BCR	b	617	-	-	2/29/63/63	0/2/2/2
27	GOL	O	302	-	-	2/4/4/4	-
35	DGD	c	518[A]	-	-	20/51/91/95	0/2/2/2
23	CLA	B	604	-	1/1/15/20	3/37/115/115	-
23	CLA	c	510	-	1/1/15/20	5/37/115/115	-
23	CLA	C	505	41	1/1/15/20	6/37/115/115	-

Continued on next page...

Continued from previous page...

Mol	Type	Chain	Res	Link	Chirals	Torsions	Rings
26	SQD	b	620	-	-	17/49/69/69	0/1/1/1
23	CLA	A	405[A]	41	-	4/37/115/115	-
32	LHG	b	629[A]	-	-	20/53/53/53	-
23	CLA	b	614	-	1/1/15/20	16/37/115/115	-
23	CLA	d	403[B]	-	1/1/15/20	4/37/115/115	-
34	HTG	b	623	-	-	5/10/30/30	0/1/1/1
27	GOL	d	413	-	-	1/4/4/4	-
32	LHG	d	407[B]	-	-	19/53/53/53	-
33	LMG	D	411	39	-	8/46/66/70	0/1/1/1
27	GOL	l	801[B]	-	-	2/4/4/4	-
23	CLA	B	602	-	1/1/15/20	7/37/115/115	-
31	LMT	e	101	-	-	15/21/61/61	0/2/2/2
23	CLA	b	611	-	1/1/15/20	2/37/115/115	-
25	BCR	y	101	-	-	4/29/63/63	0/2/2/2
23	CLA	C	503	-	-	10/37/115/115	-
32	LHG	E	101[B]	-	-	22/46/46/53	-
33	LMG	c	522	-	-	9/46/66/70	0/1/1/1
31	LMT	c	502	-	-	11/21/61/61	0/2/2/2
23	CLA	B	615	-	1/1/15/20	7/37/115/115	-
23	CLA	a	404[B]	-	1/1/15/20	3/37/115/115	-
35	DGD	C	517[B]	-	-	14/51/91/95	0/2/2/2
31	LMT	t	101	-	-	8/17/38/61	0/1/1/2
25	BCR	K	102	-	-	3/29/63/63	0/2/2/2
23	CLA	d	402[A]	41	1/1/15/20	8/37/115/115	-
23	CLA	a	405[B]	41	-	6/37/115/115	-
35	DGD	C	518[B]	-	-	14/51/91/95	0/2/2/2
23	CLA	B	610	41	1/1/15/20	9/37/115/115	-
23	CLA	c	513	3	1/1/15/20	3/37/115/115	-
23	CLA	C	510	-	1/1/15/20	7/37/115/115	-
23	CLA	b	604	-	1/1/15/20	8/37/115/115	-
23	CLA	c	505	-	1/1/15/20	3/37/115/115	-
27	GOL	b	628	-	-	0/4/4/4	-
23	CLA	b	607	41	1/1/15/20	3/37/115/115	-
31	LMT	m	103	-	-	5/21/61/61	0/2/2/2

Continued on next page...

Continued from previous page...

Mol	Type	Chain	Res	Link	Chirals	Torsions	Rings
27	GOL	c	528	-	-	3/4/4/4	-
23	CLA	C	513	-	1/1/15/20	8/37/115/115	-
23	CLA	b	609	-	1/1/15/20	3/37/115/115	-
24	PHO	a	406[A]	-	-	6/37/103/103	0/5/6/6
24	PHO	a	414[B]	-	-	4/37/103/103	0/5/6/6
29	PL9	D	405[A]	-	-	8/53/73/73	0/1/1/1
27	GOL	A	418	-	-	0/4/4/4	-
27	GOL	V	203[B]	-	-	2/4/4/4	-
26	SQD	a	409[A]	-	-	10/49/69/69	0/1/1/1
23	CLA	A	406[A]	41	-	5/37/115/115	-
32	LHG	A	419[B]	-	-	10/53/53/53	-
26	SQD	A	412	-	-	14/49/69/69	0/1/1/1
29	PL9	a	412[B]	-	-	14/53/73/73	0/1/1/1

The worst 5 of 1551 bond length outliers are listed below:

Mol	Chain	Res	Type	Atoms	Z	Observed(Å)	Ideal(Å)
23	B	611	CLA	C3B-C2B	10.60	1.55	1.40
23	C	509	CLA	C3B-C2B	7.33	1.50	1.40
23	c	504	CLA	C3B-C2B	6.92	1.50	1.40
23	B	611	CLA	C1D-ND	6.88	1.46	1.37
23	b	612	CLA	C3B-C2B	6.76	1.49	1.40

The worst 5 of 3082 bond angle outliers are listed below:

Mol	Chain	Res	Type	Atoms	Z	Observed(°)	Ideal(°)
23	B	611	CLA	C1D-ND-C4D	-11.52	98.15	106.33
23	B	612	CLA	C1D-ND-C4D	-10.49	98.88	106.33
23	a	407	CLA	C1D-ND-C4D	-10.37	98.97	106.33
23	b	605	CLA	C1D-ND-C4D	-10.10	99.16	106.33
23	d	404	CLA	C1D-ND-C4D	-10.04	99.20	106.33

5 of 69 chirality outliers are listed below:

Mol	Chain	Res	Type	Atom
23	A	404[A]	CLA	ND
23	A	404[B]	CLA	ND
23	A	405[B]	CLA	ND
23	A	408	CLA	ND

Continued on next page...

Continued from previous page...

Mol	Chain	Res	Type	Atom
23	B	601	CLA	ND

5 of 1611 torsion outliers are listed below:

Mol	Chain	Res	Type	Atoms
23	A	408	CLA	C4-C3-C5-C6
23	B	614	CLA	CHA-CBD-CGD-O1D
23	B	614	CLA	CAD-CBD-CGD-O1D
23	B	614	CLA	CAD-CBD-CGD-O2D
23	C	509	CLA	CHA-CBD-CGD-O1D

There are no ring outliers.

No monomer is involved in short contacts.

The following is a two-dimensional graphical depiction of Mogul quality analysis of bond lengths, bond angles, torsion angles, and ring geometry for all instances of the Ligand of Interest. In addition, ligands with molecular weight > 250 and outliers as shown on the validation Tables will also be included. For torsion angles, if less than 5% of the Mogul distribution of torsion angles is within 10 degrees of the torsion angle in question, then that torsion angle is considered an outlier. Any bond that is central to one or more torsion angles identified as an outlier by Mogul will be highlighted in the graph. For rings, the root-mean-square deviation (RMSD) between the ring in question and similar rings identified by Mogul is calculated over all ring torsion angles. If the average RMSD is greater than 60 degrees and the minimal RMSD between the ring in question and any Mogul-identified rings is also greater than 60 degrees, then that ring is considered an outlier. The outliers are highlighted in purple. The color gray indicates Mogul did not find sufficient equivalents in the CSD to analyse the geometry.

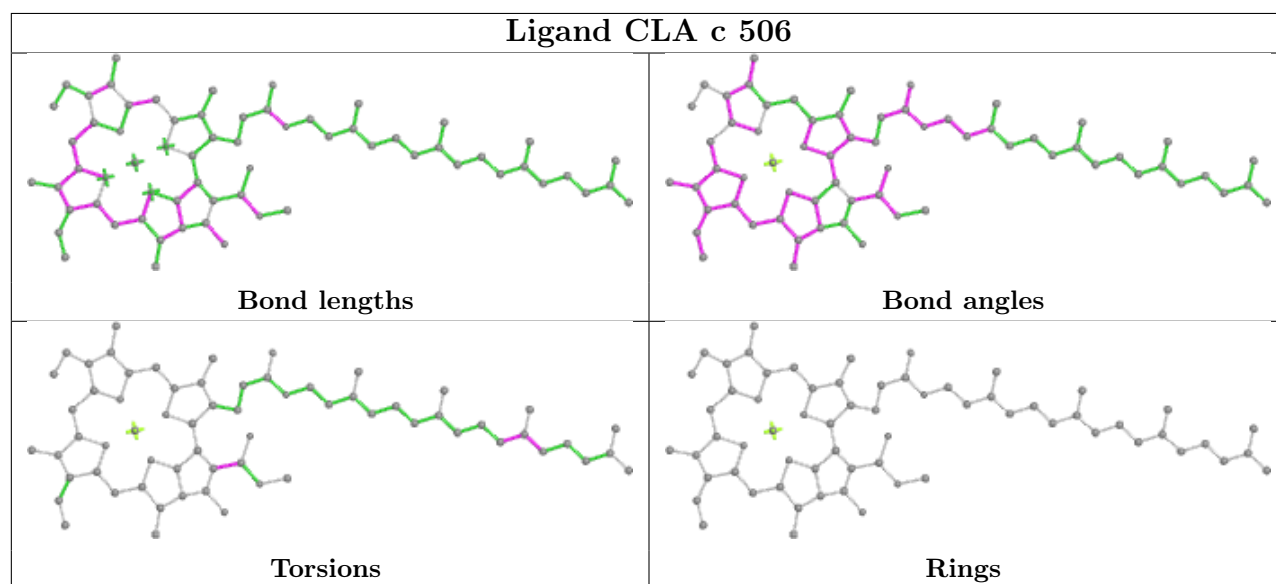

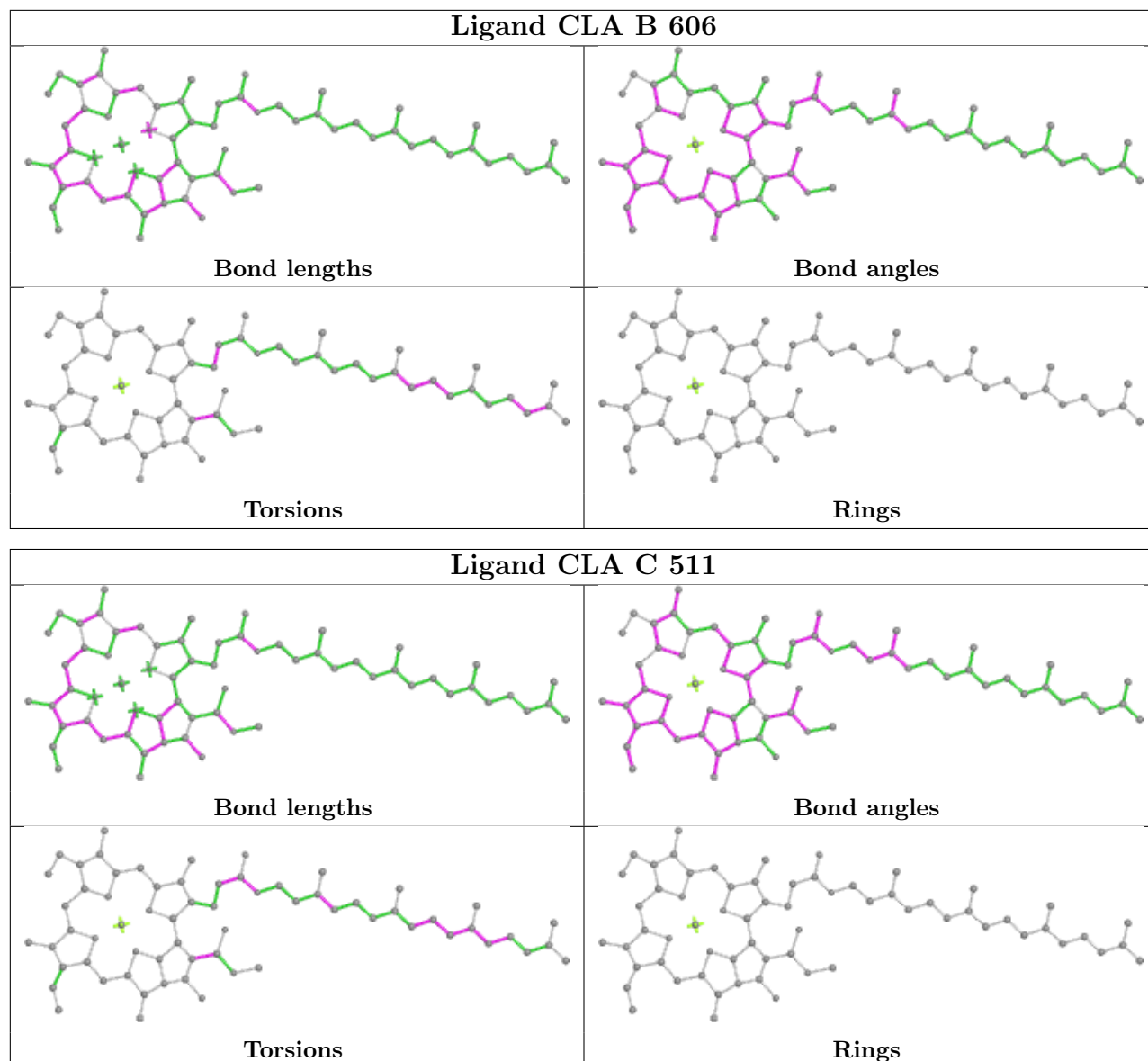

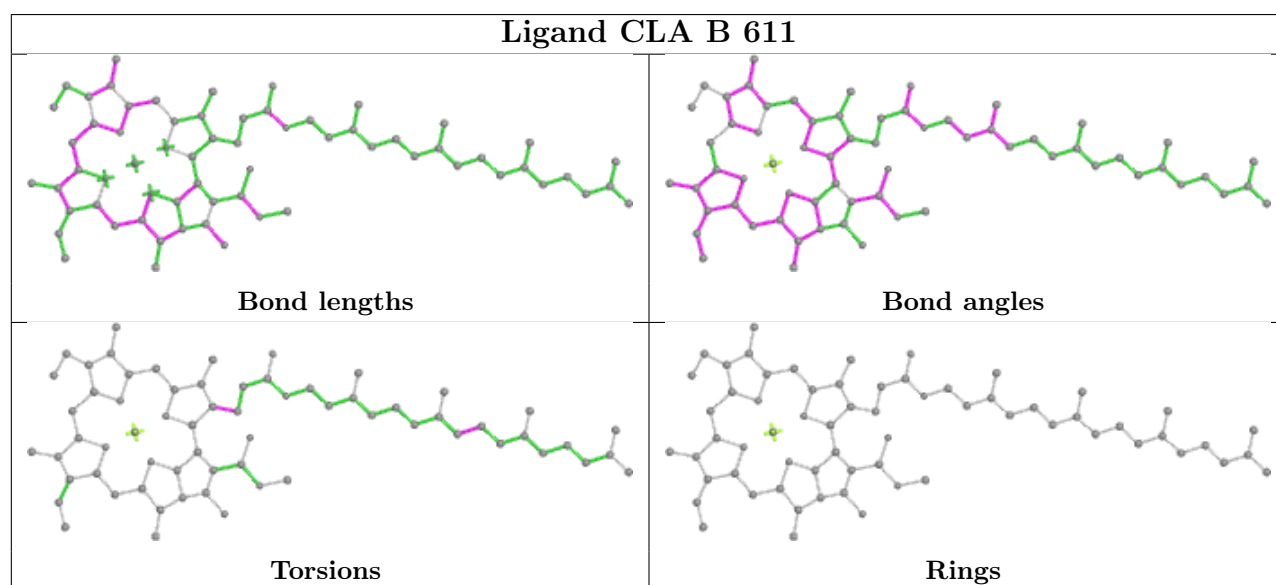
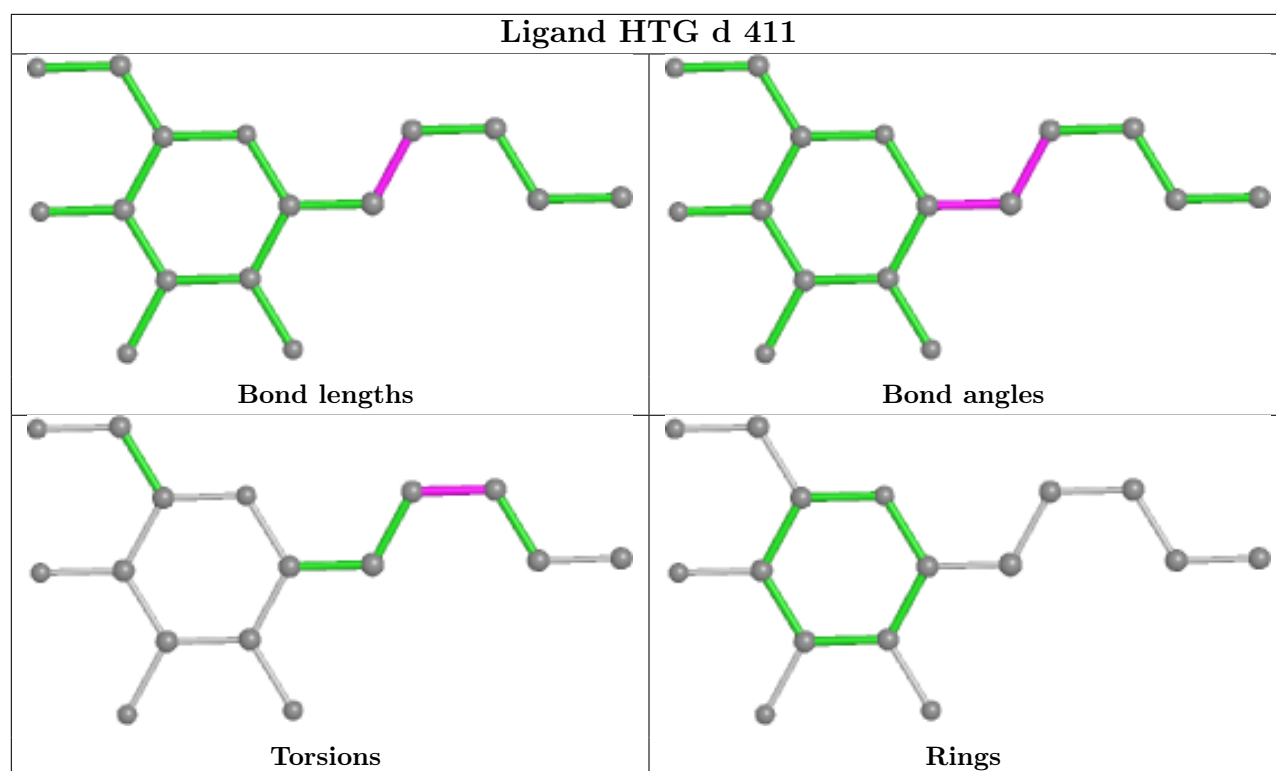

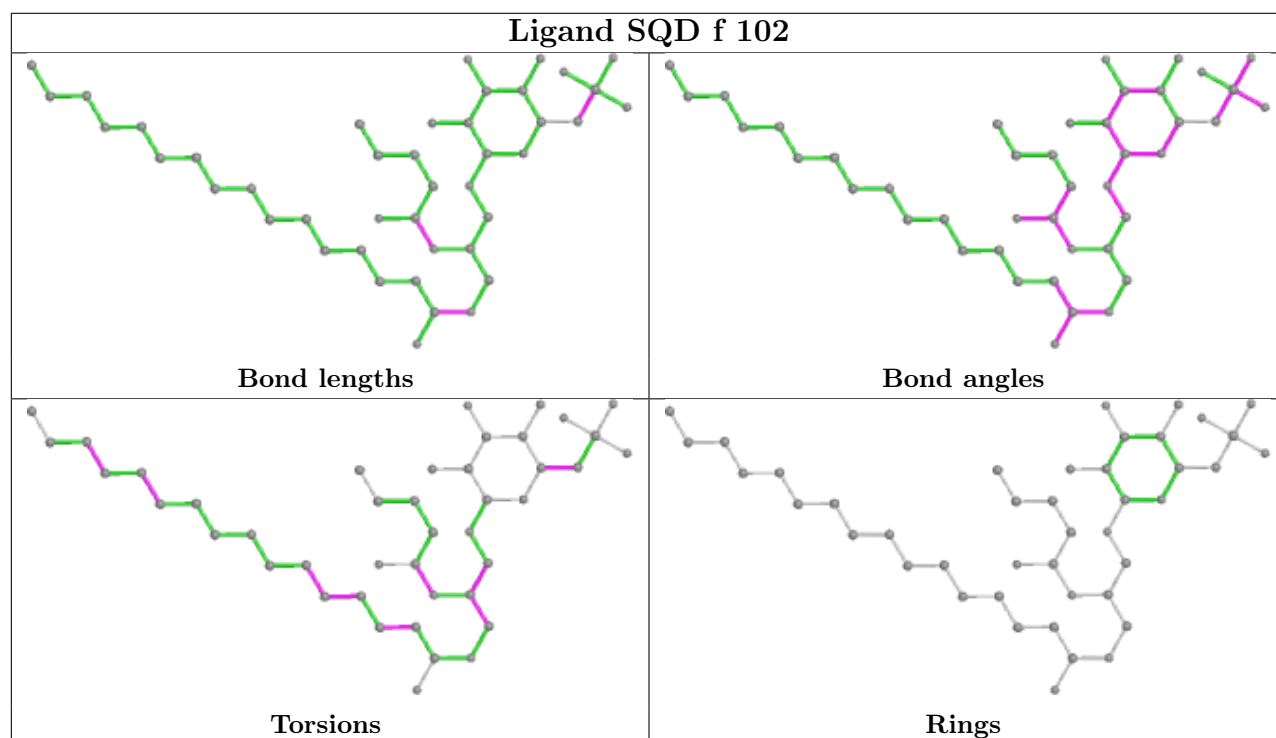
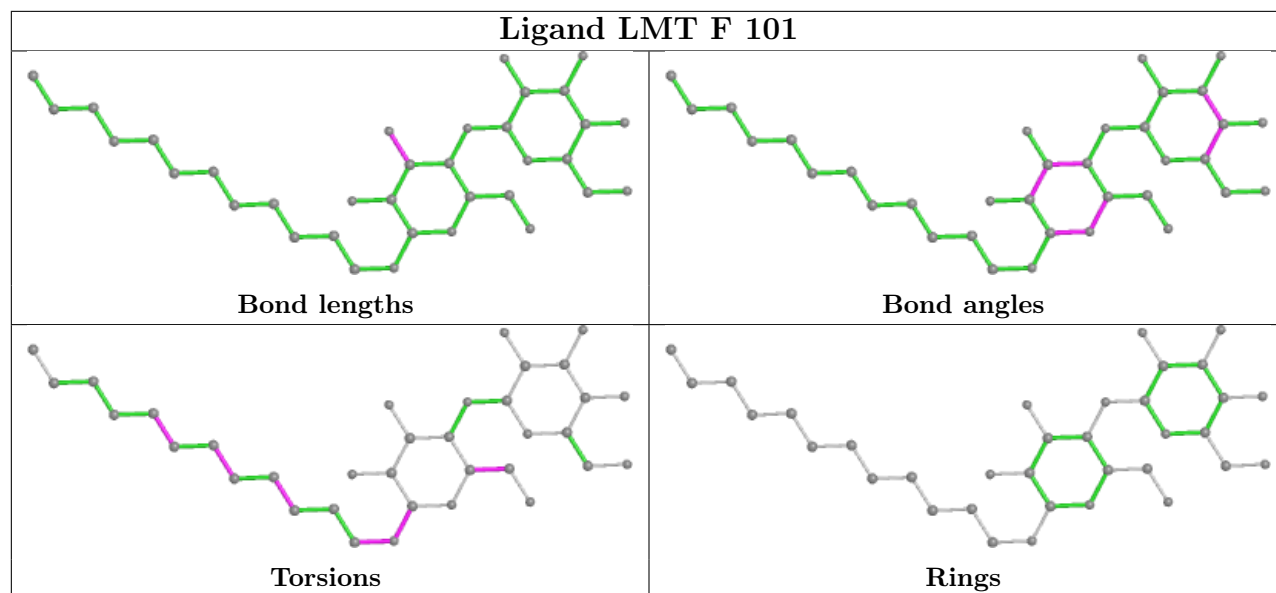

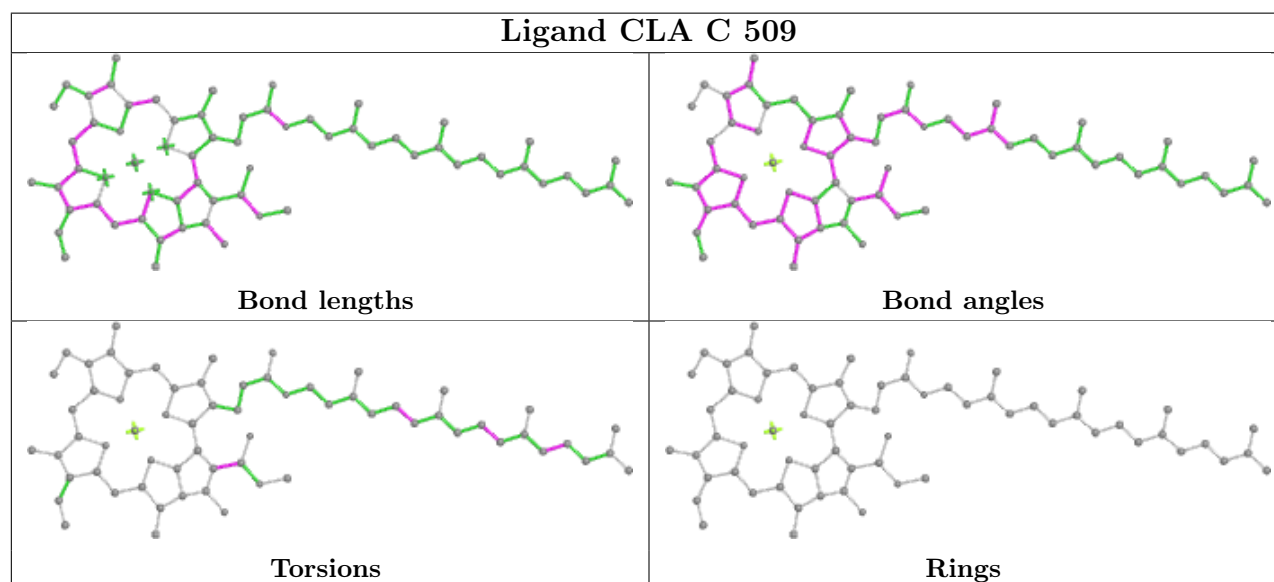
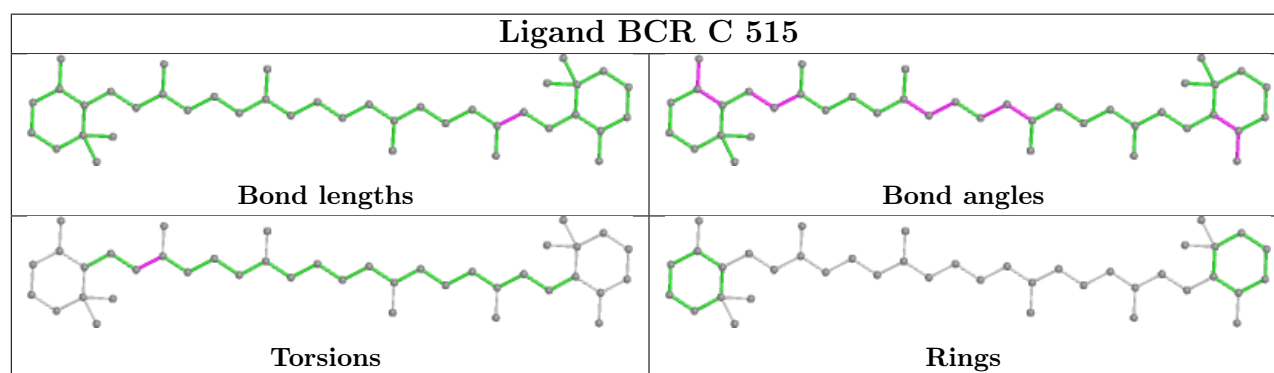
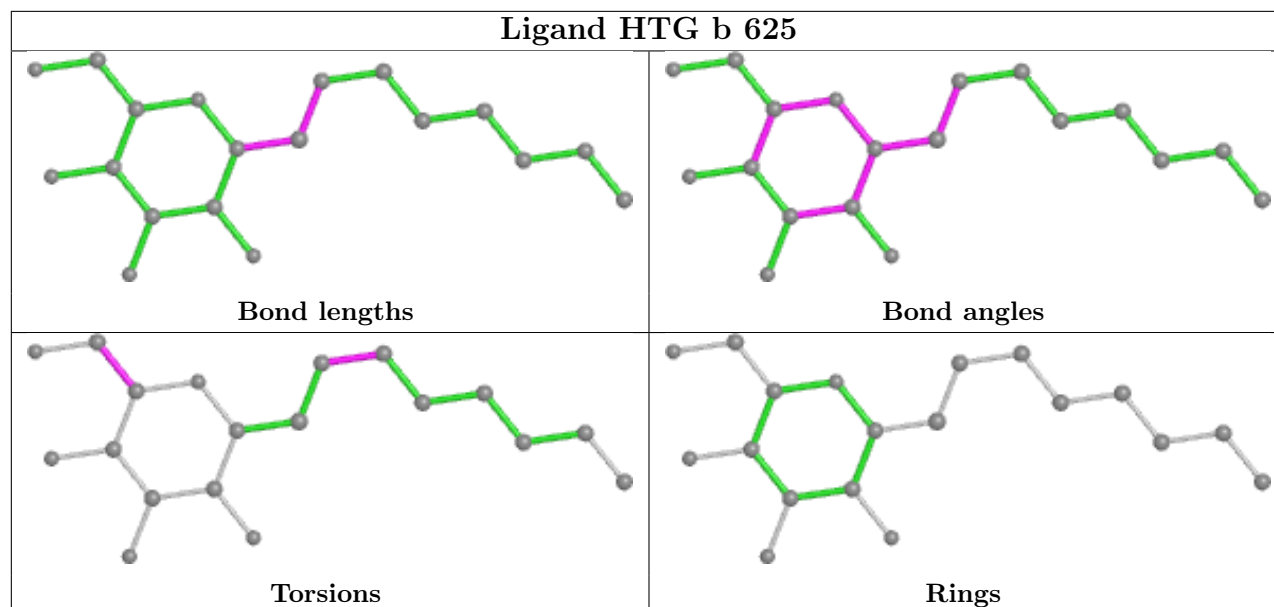

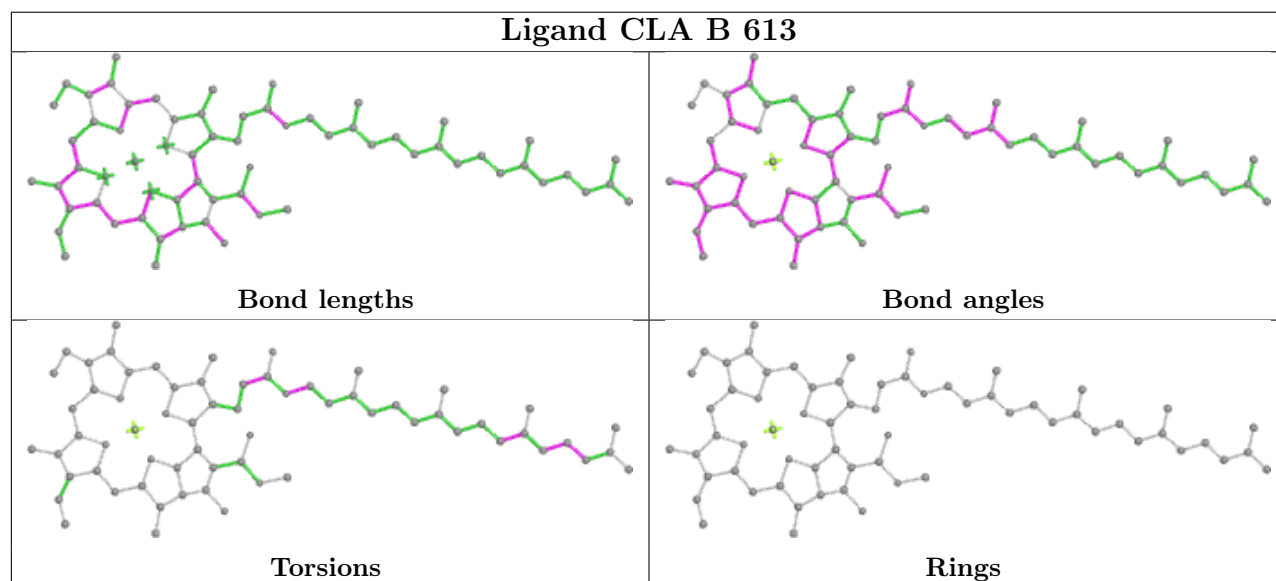
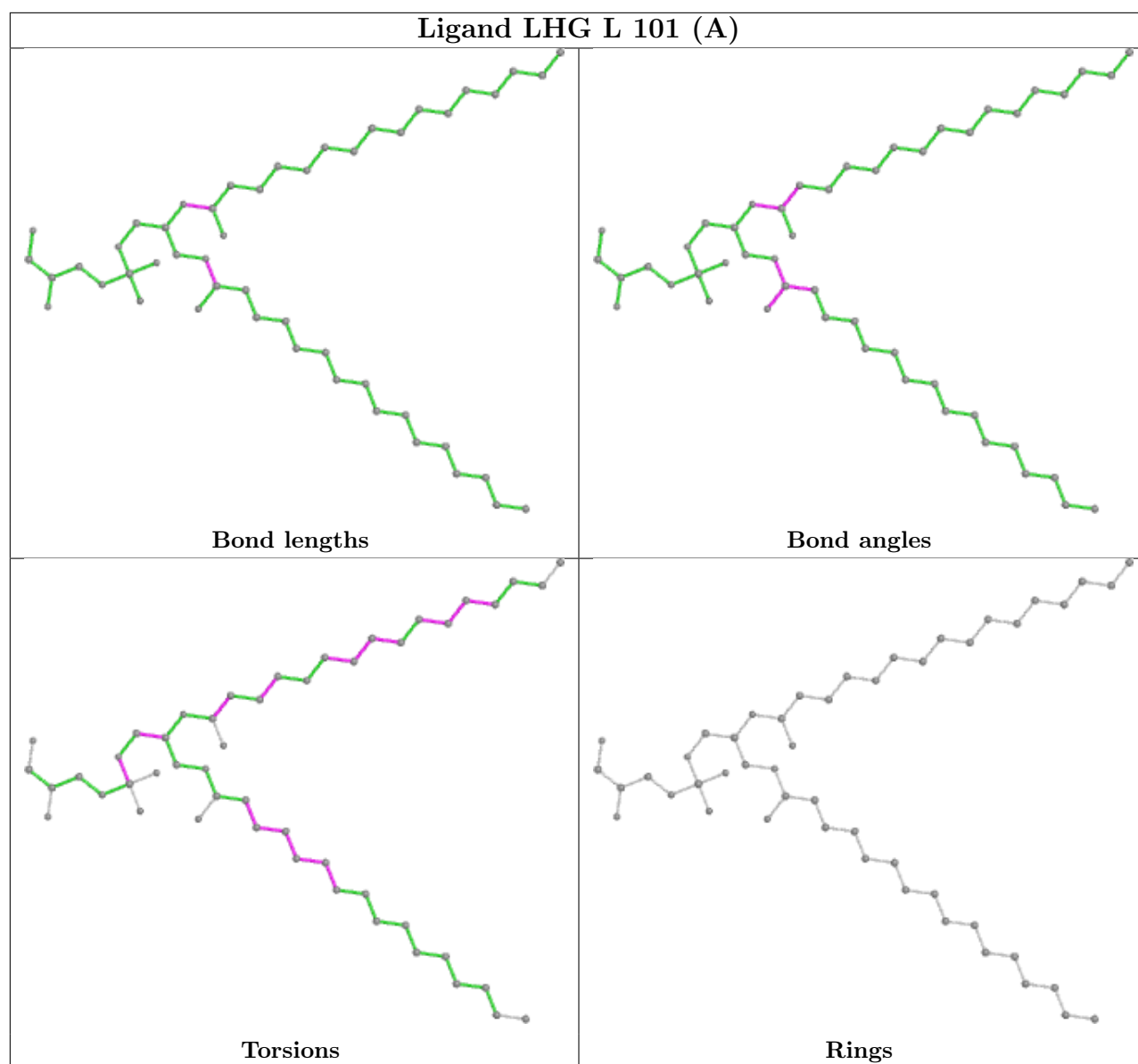

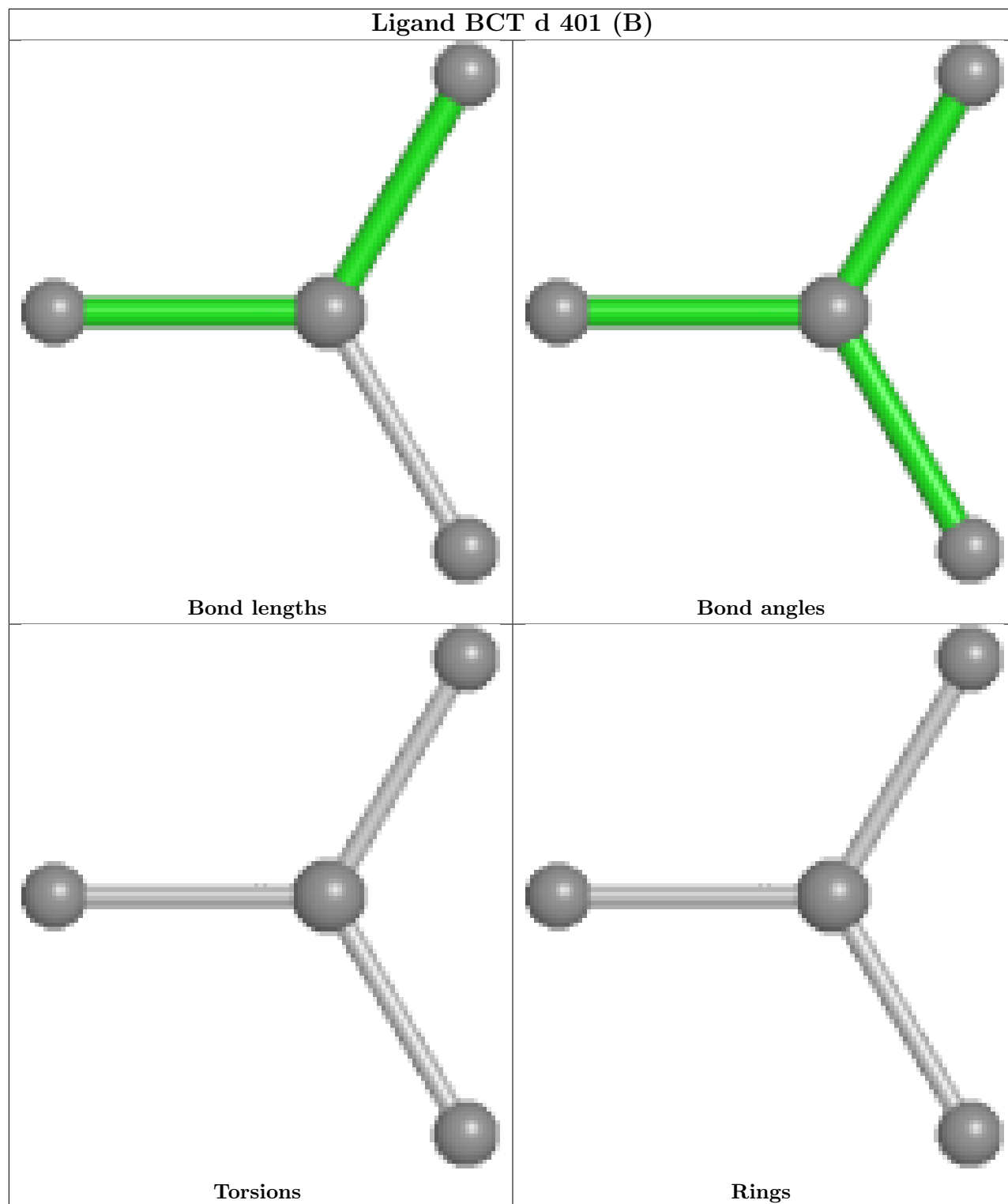

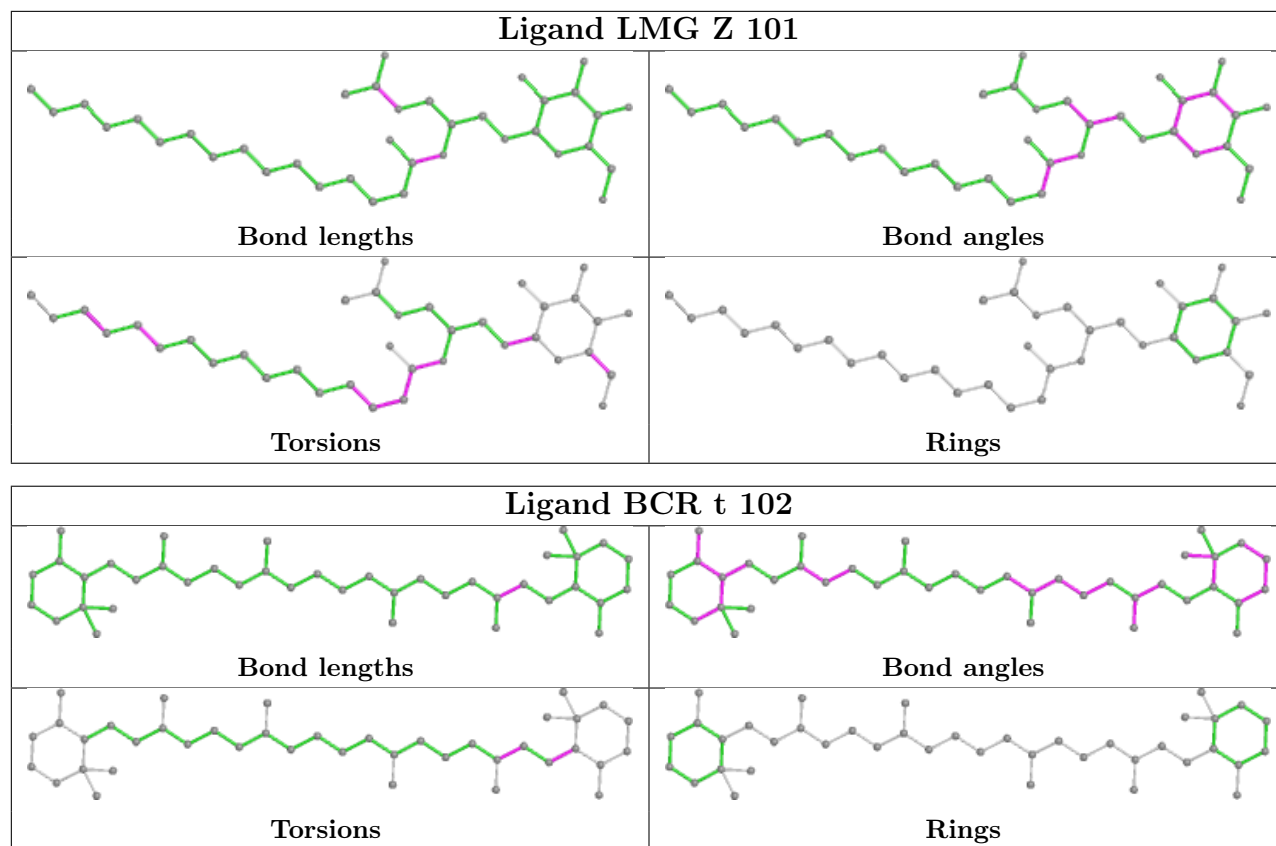

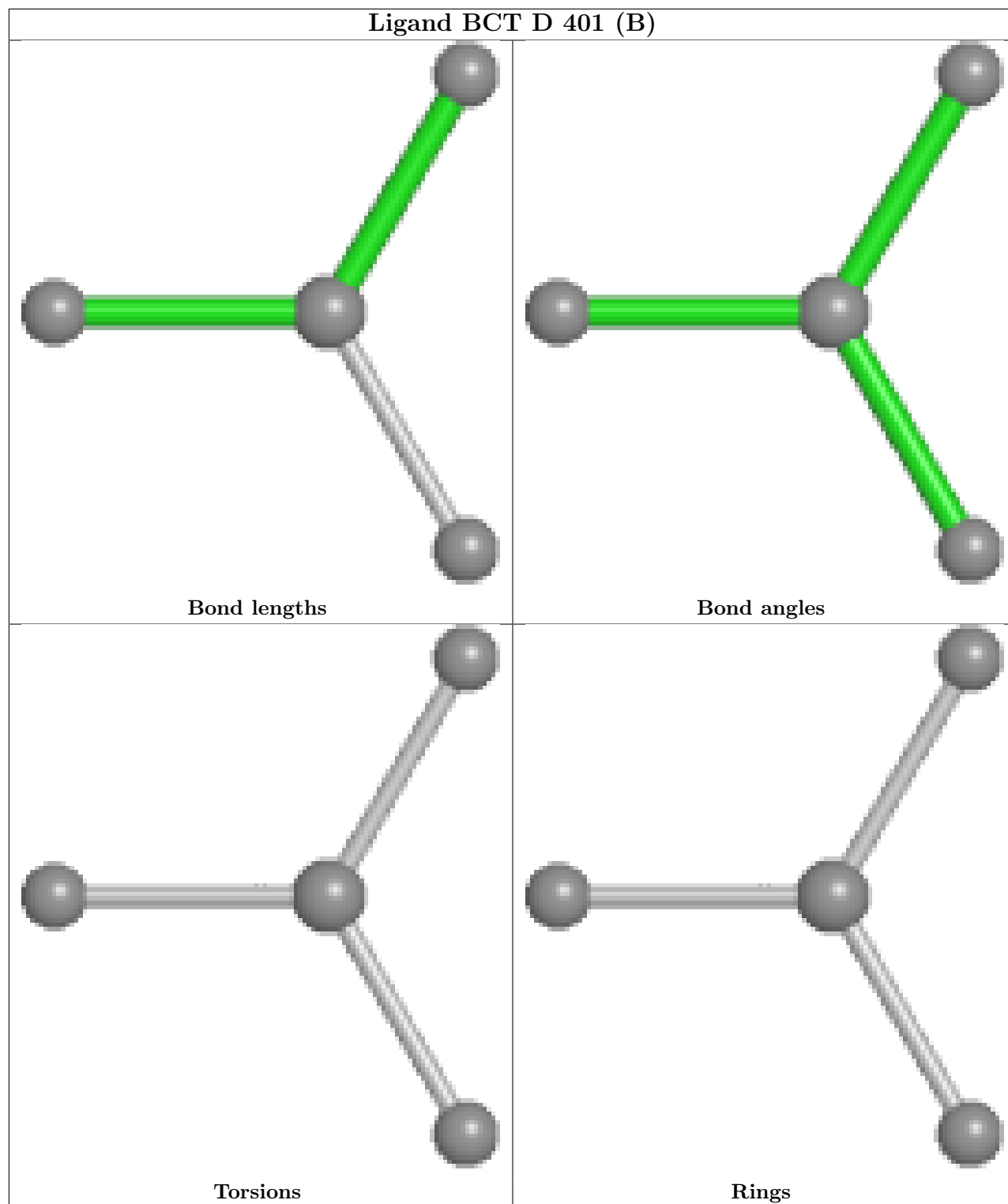

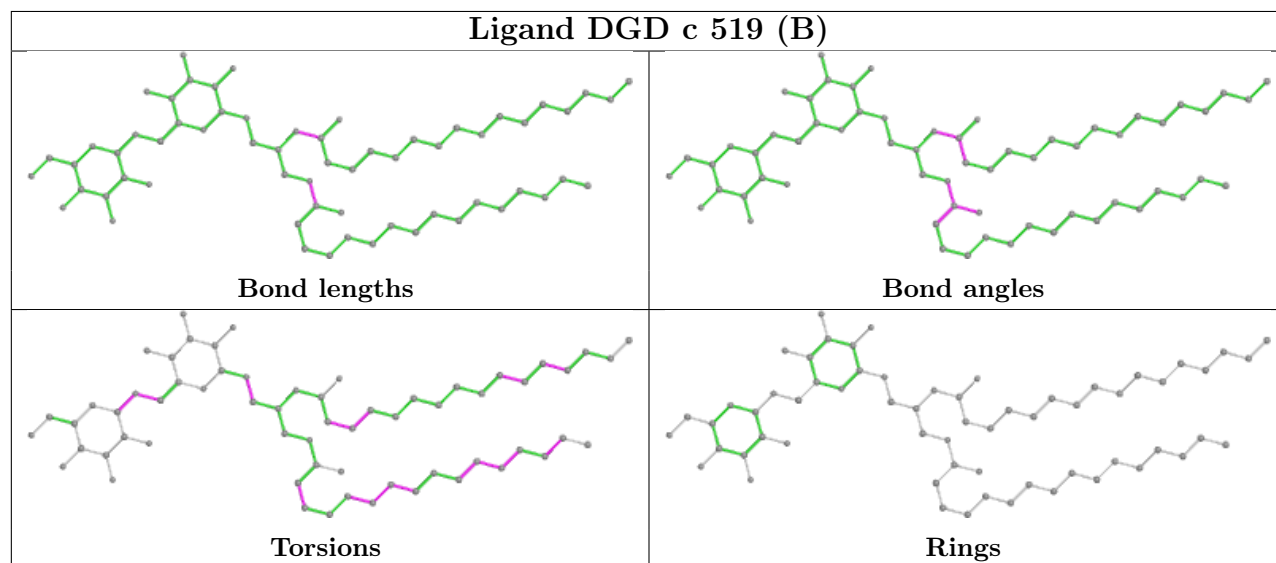
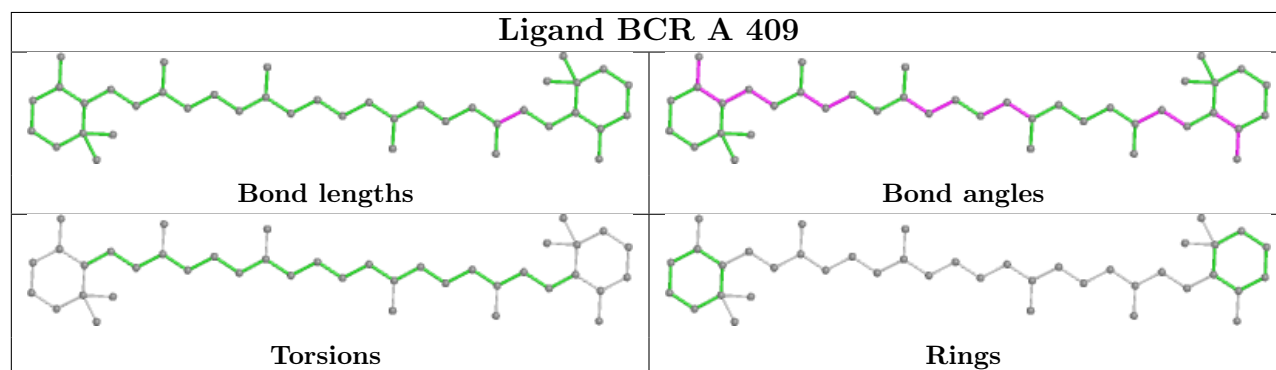
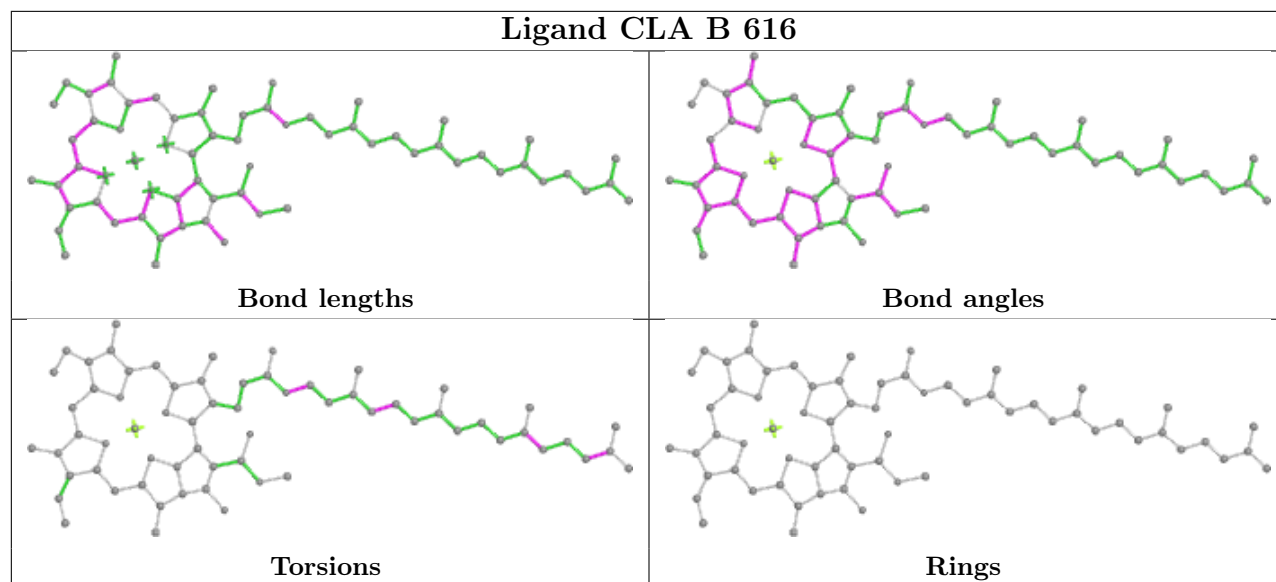

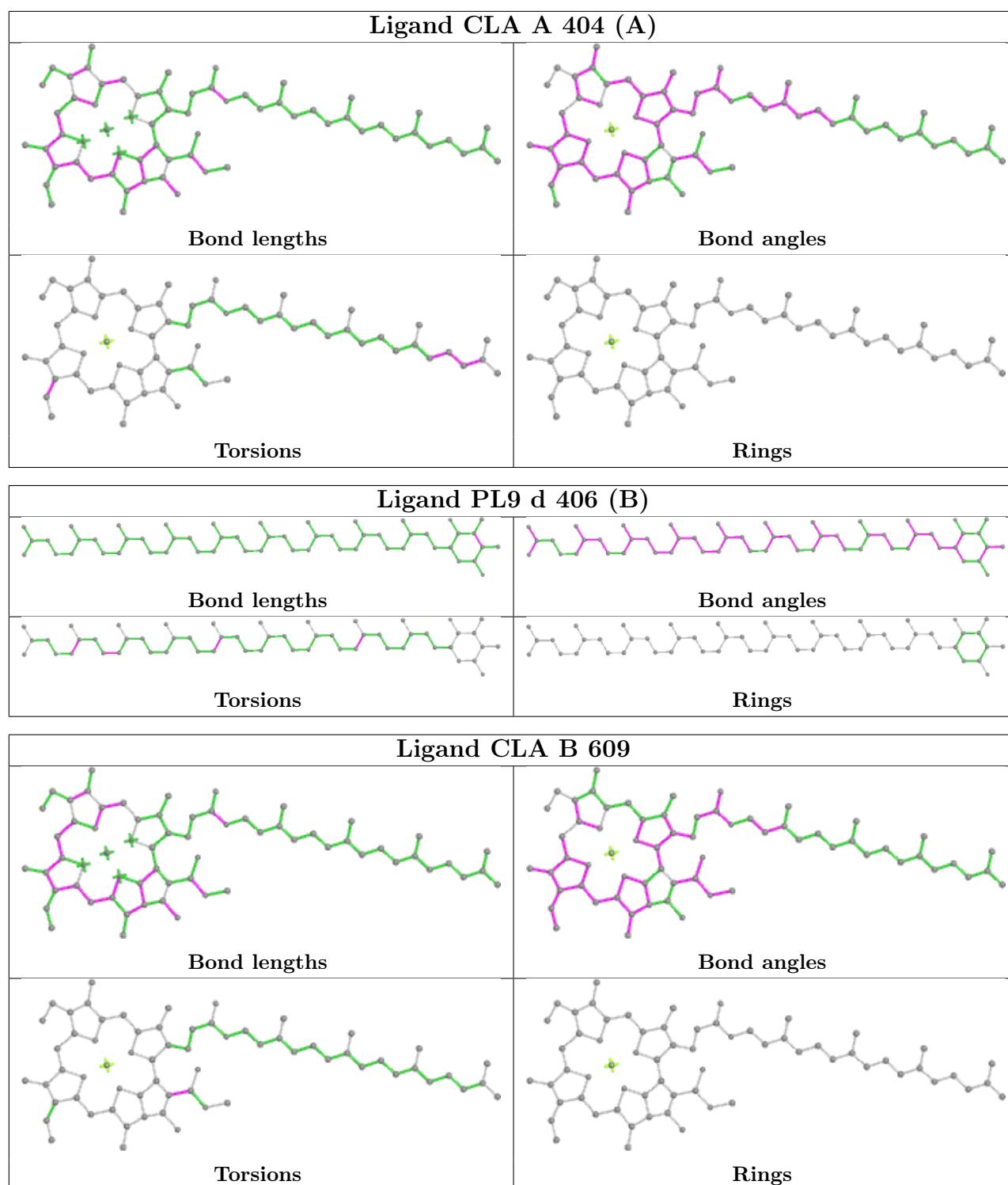

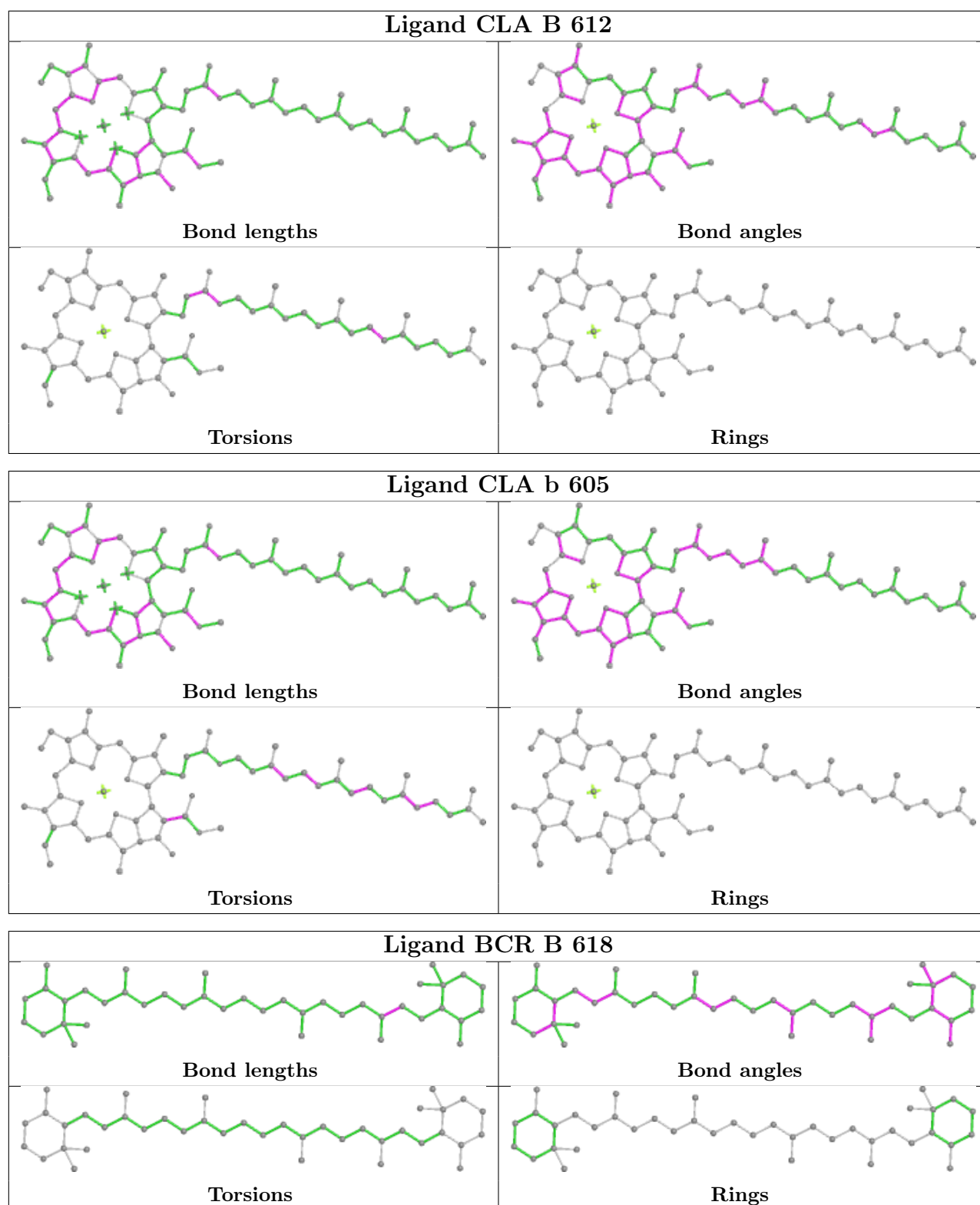

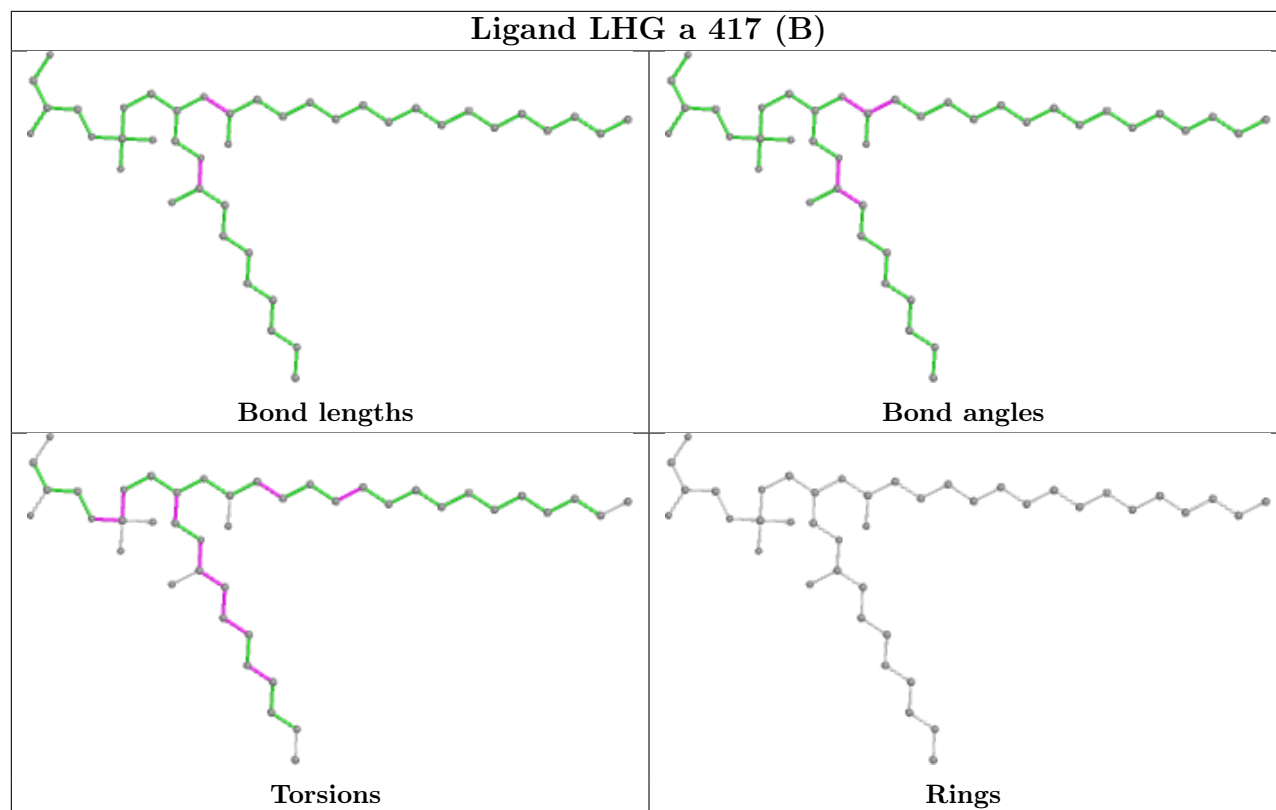

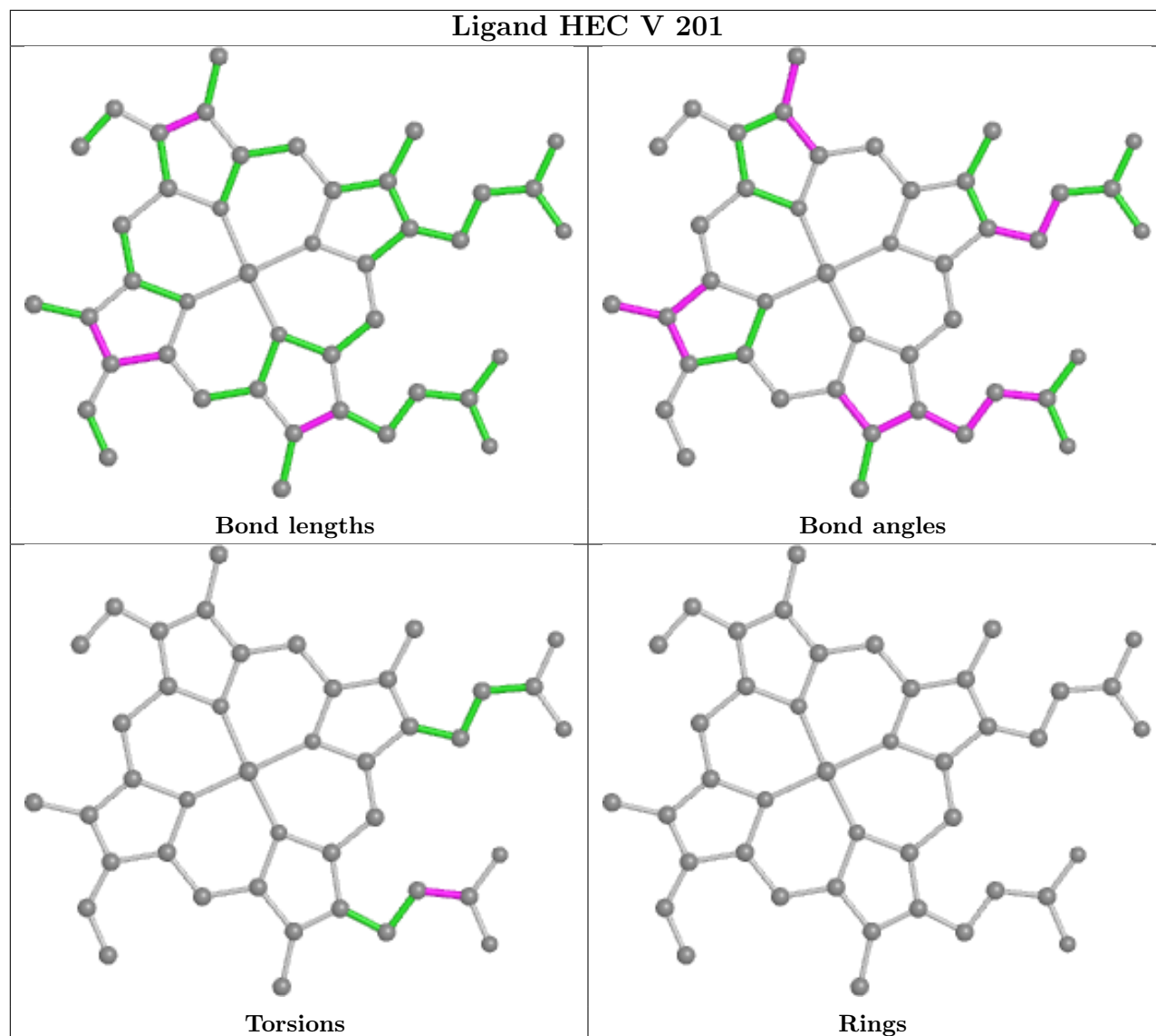

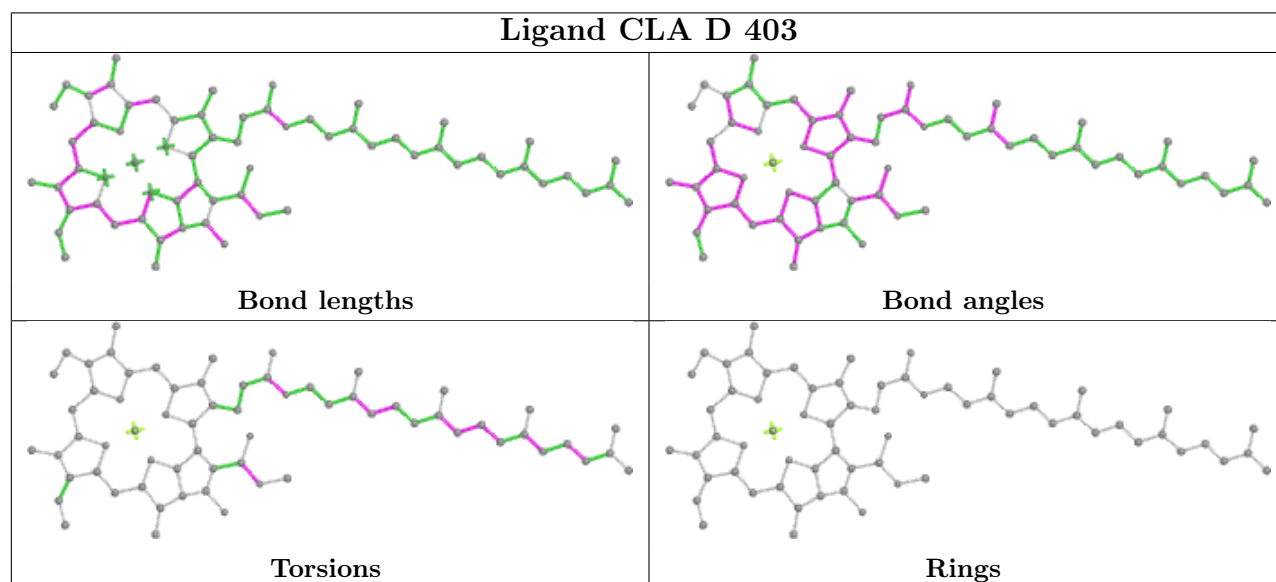
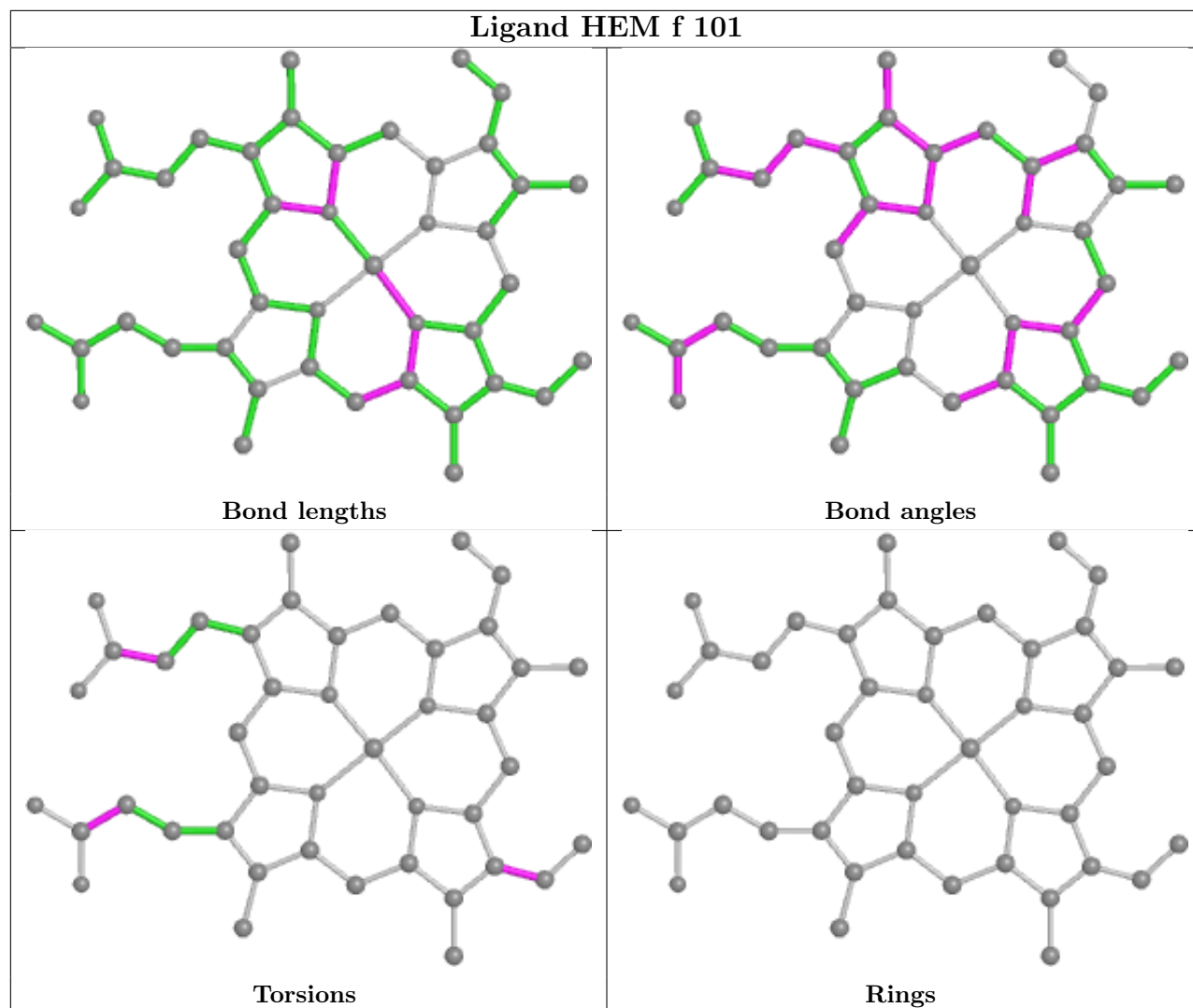

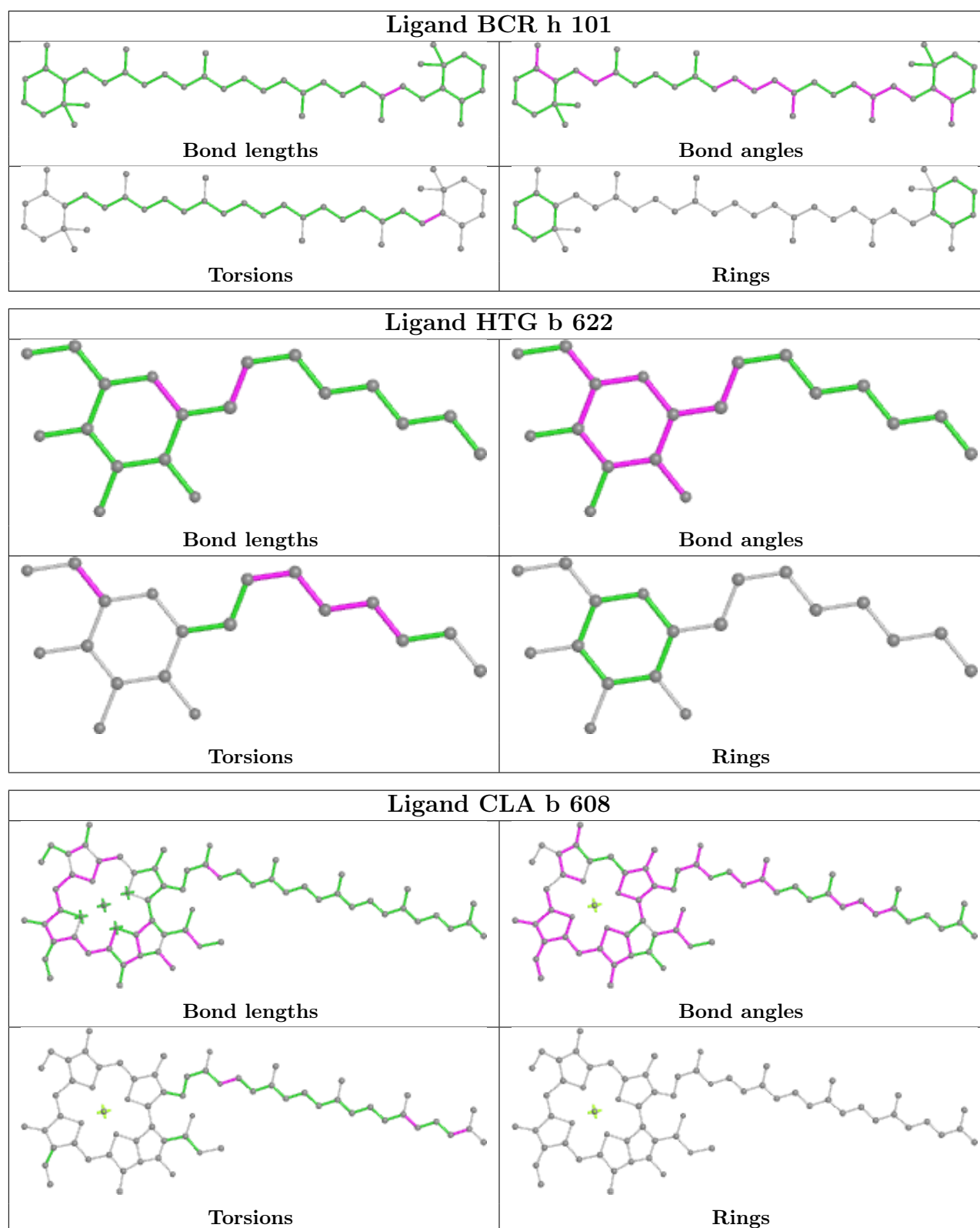

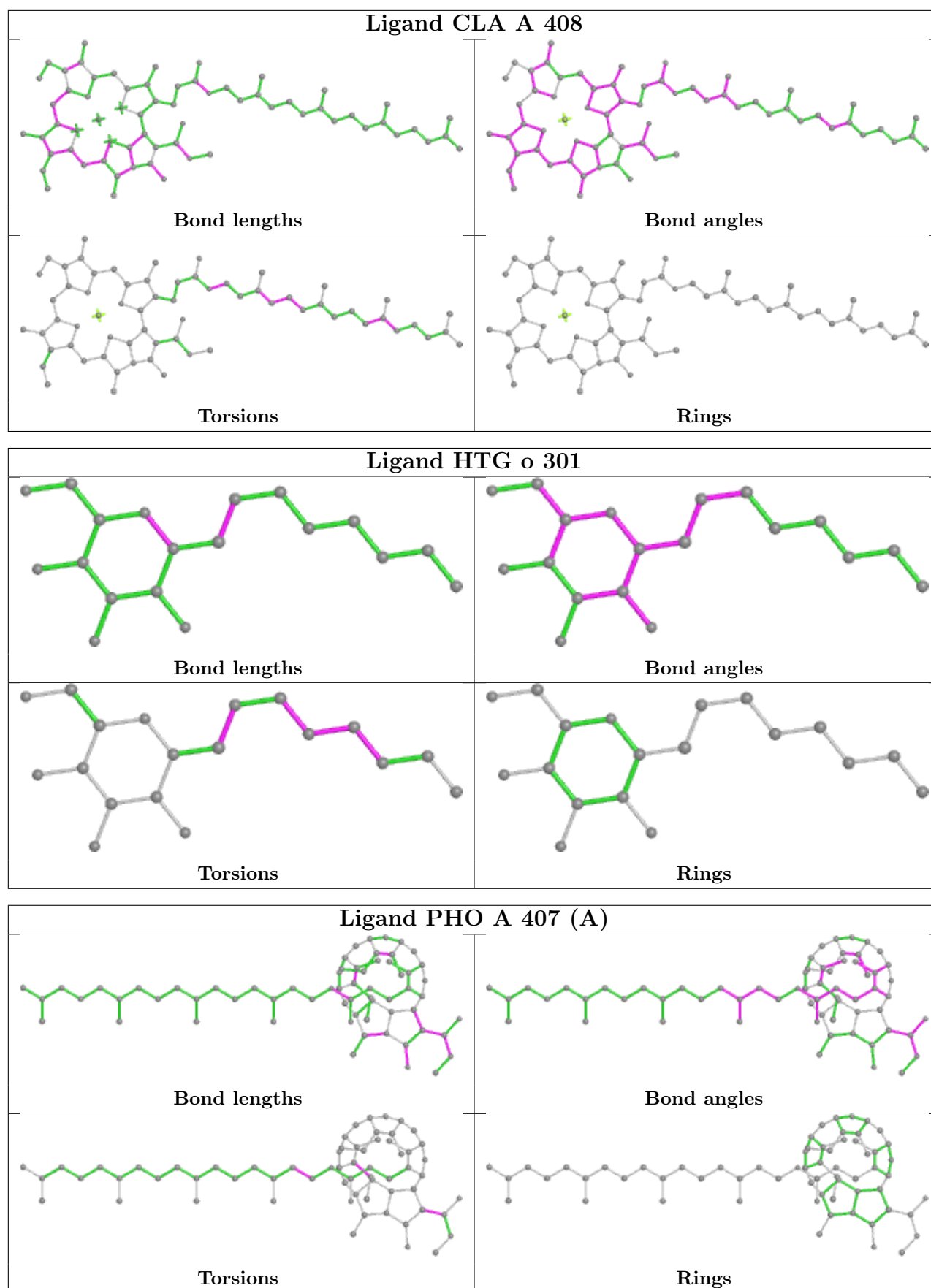

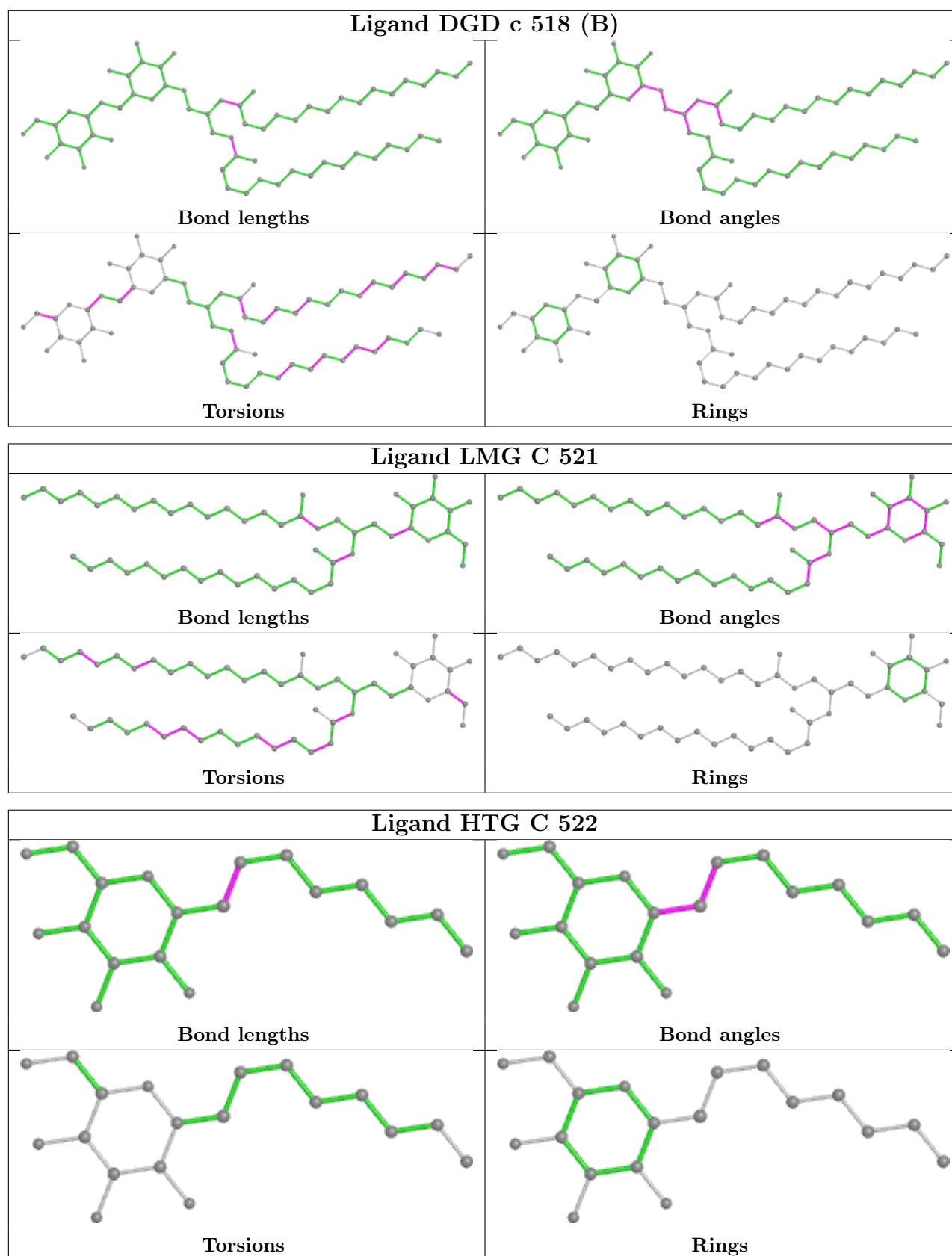

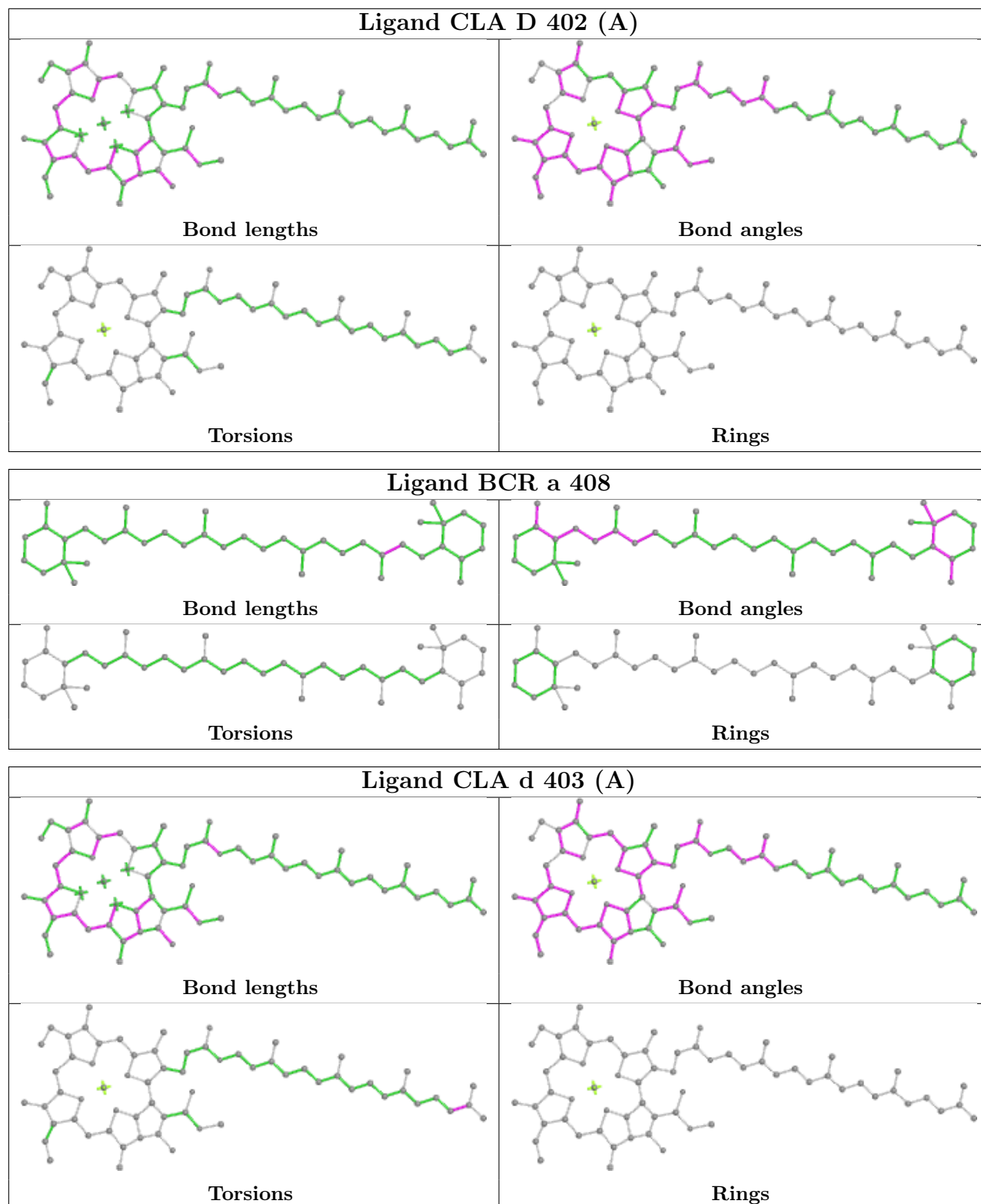

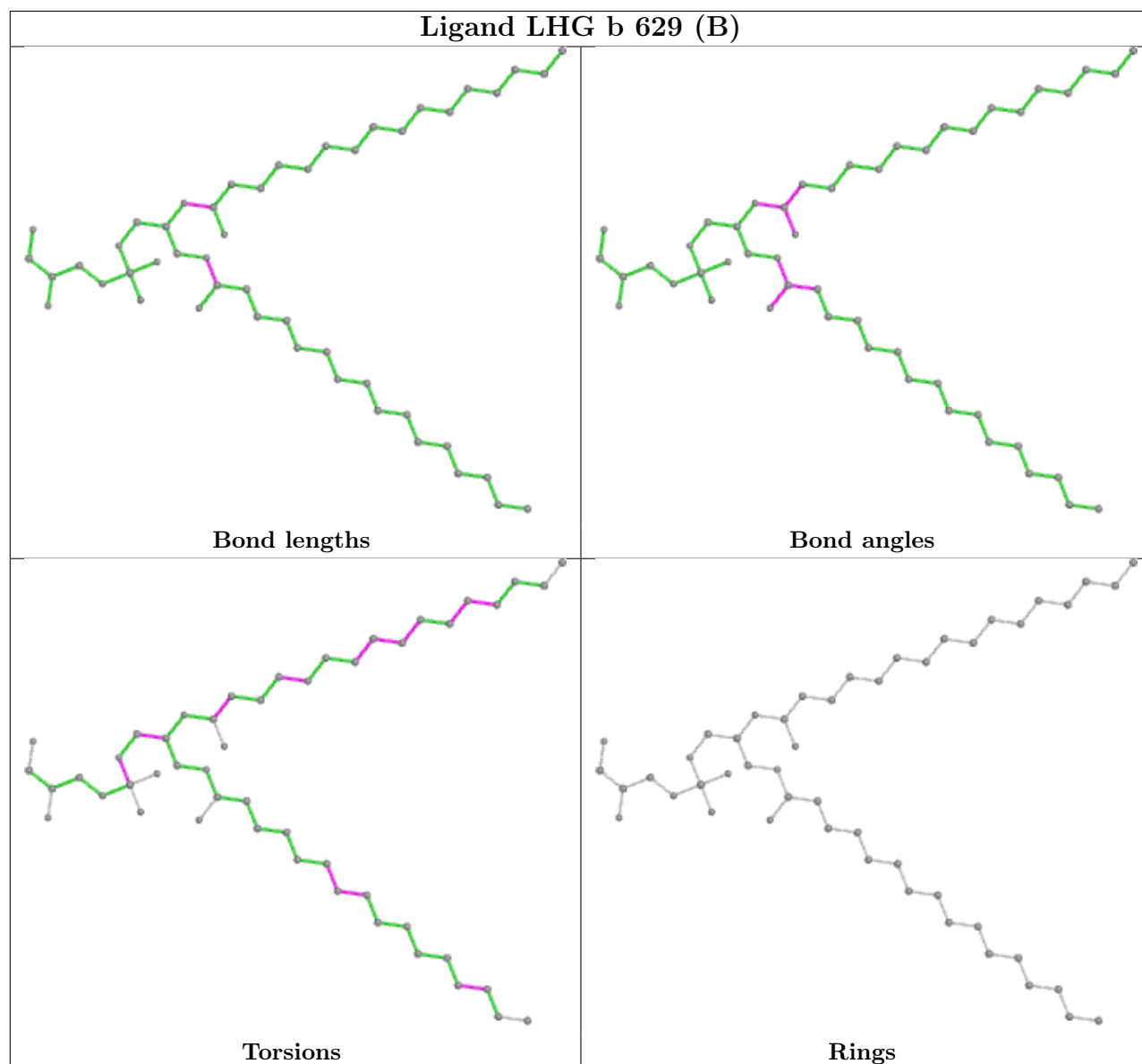
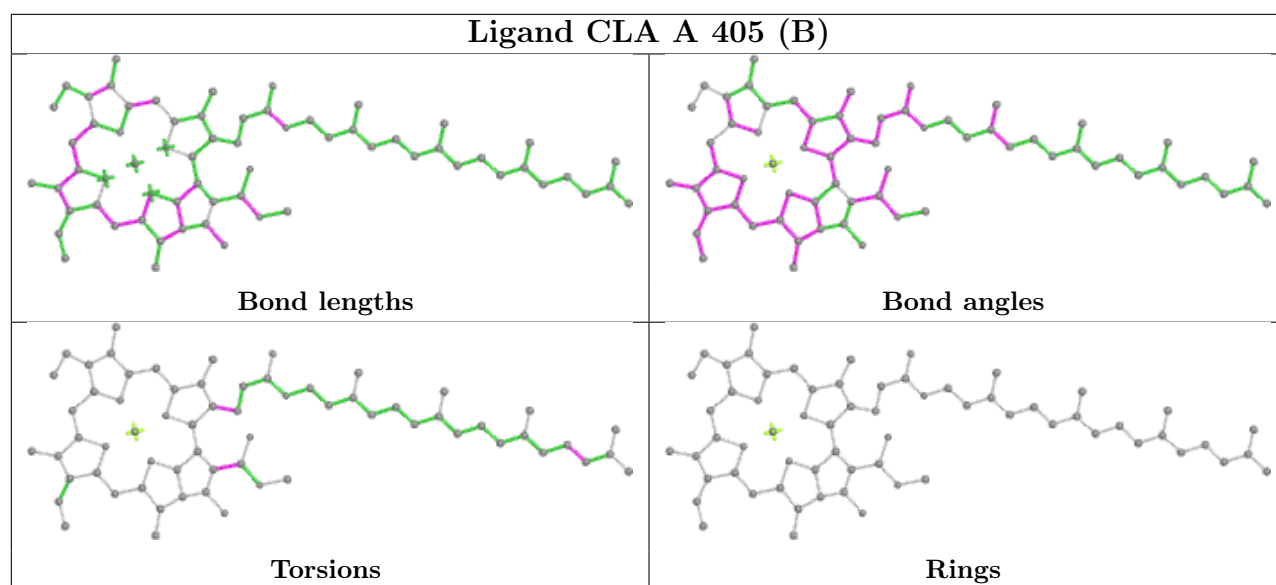

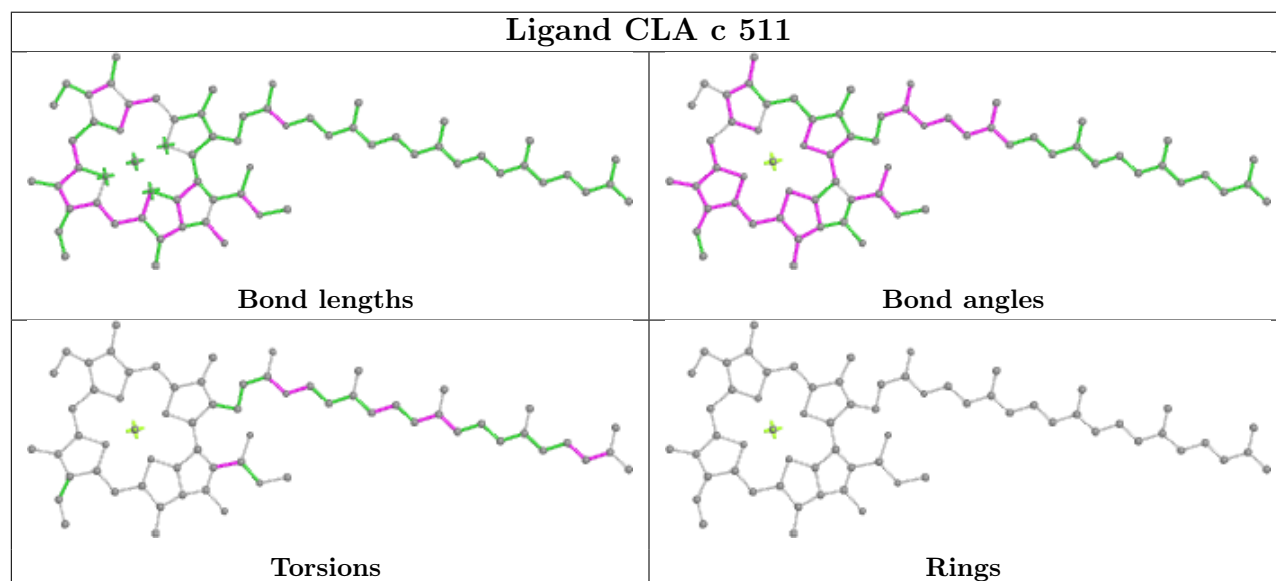
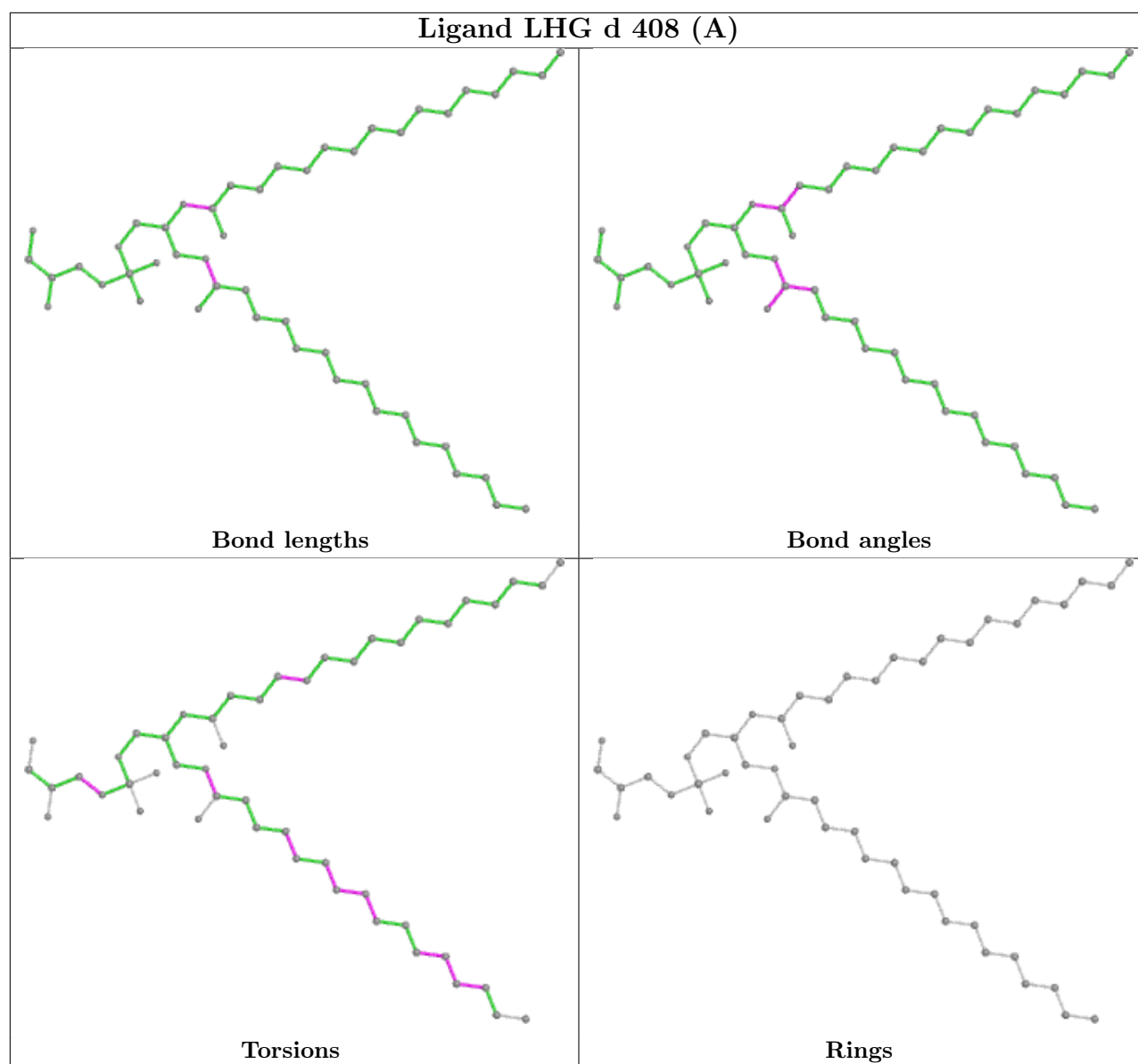

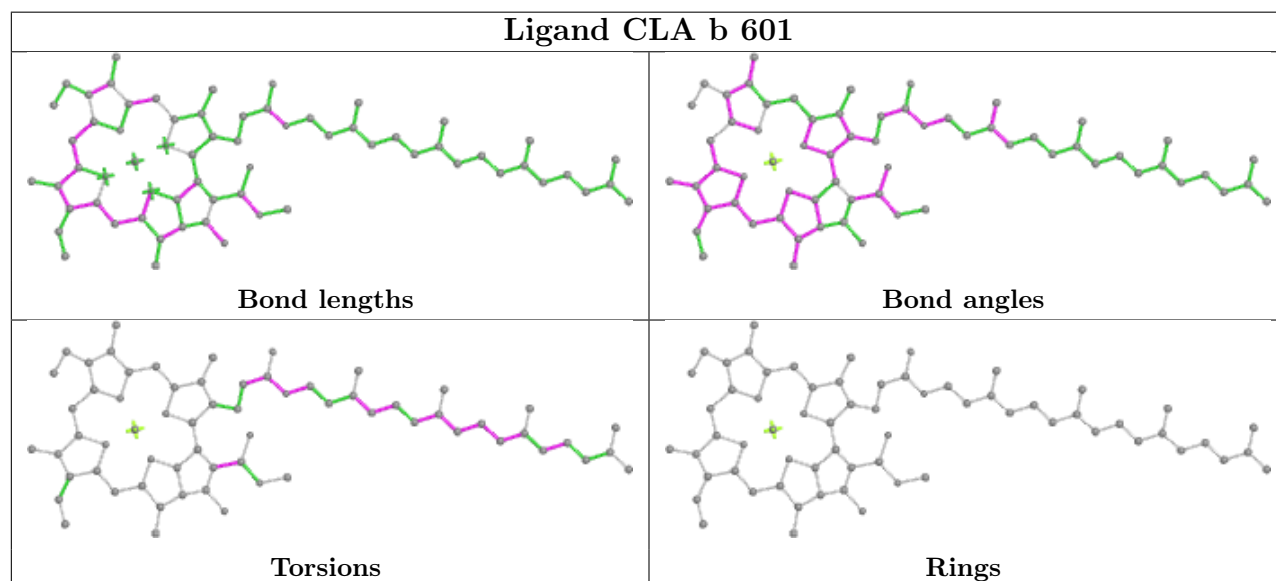
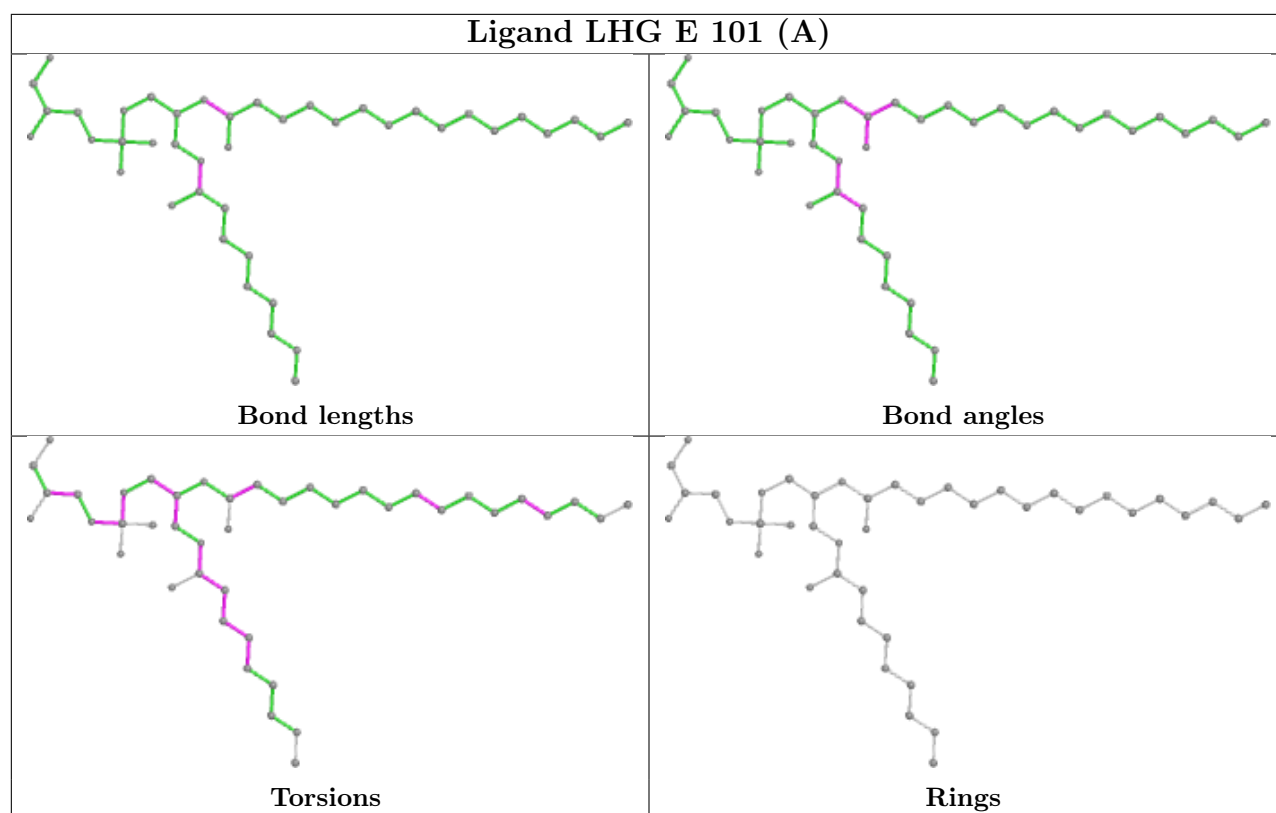

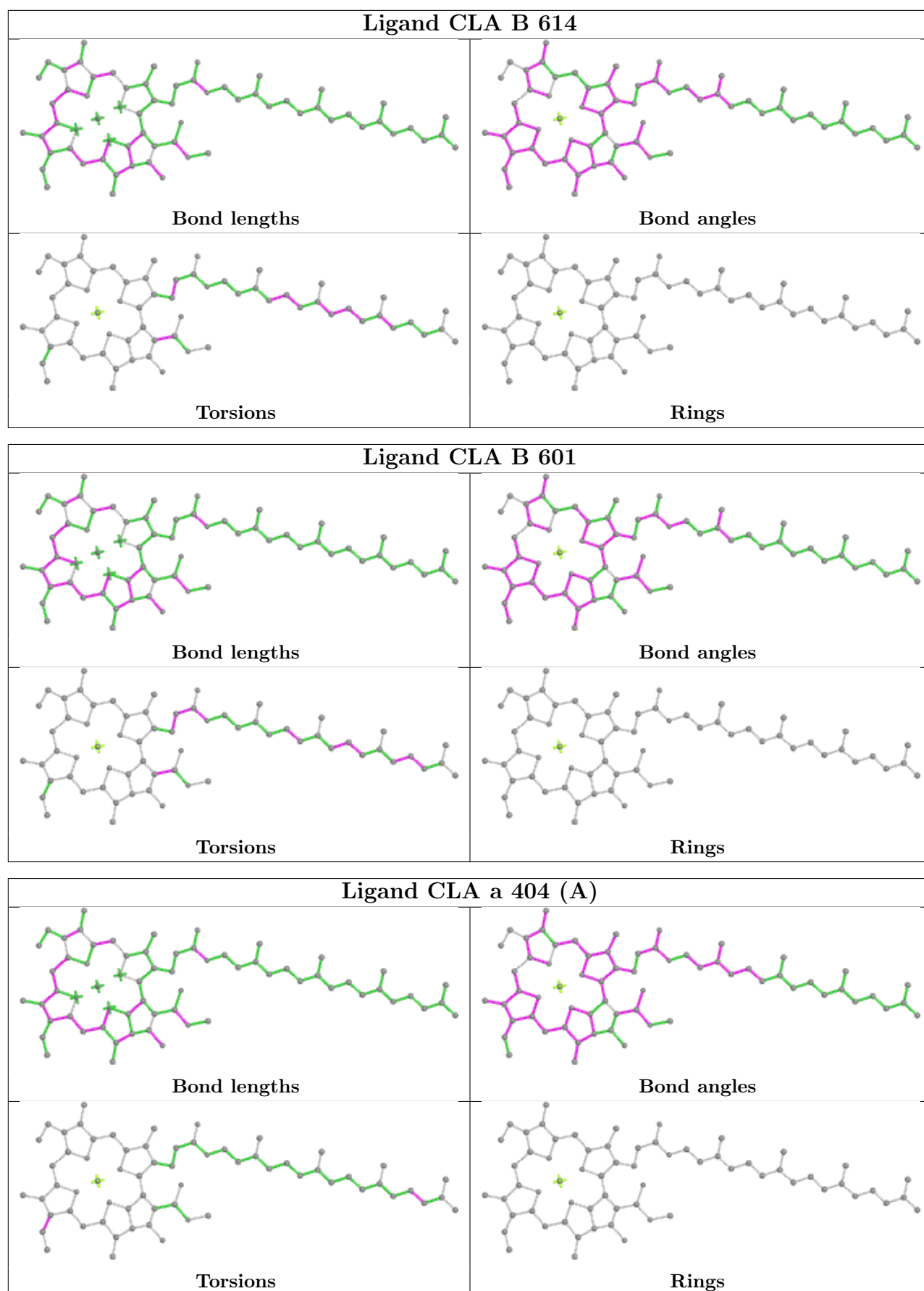

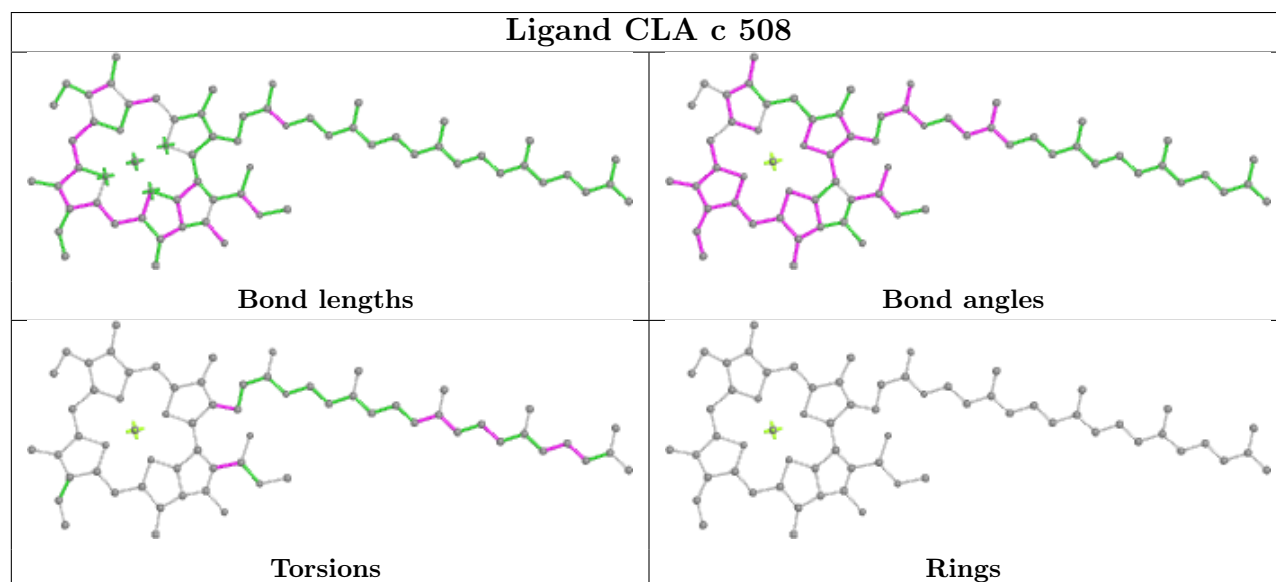
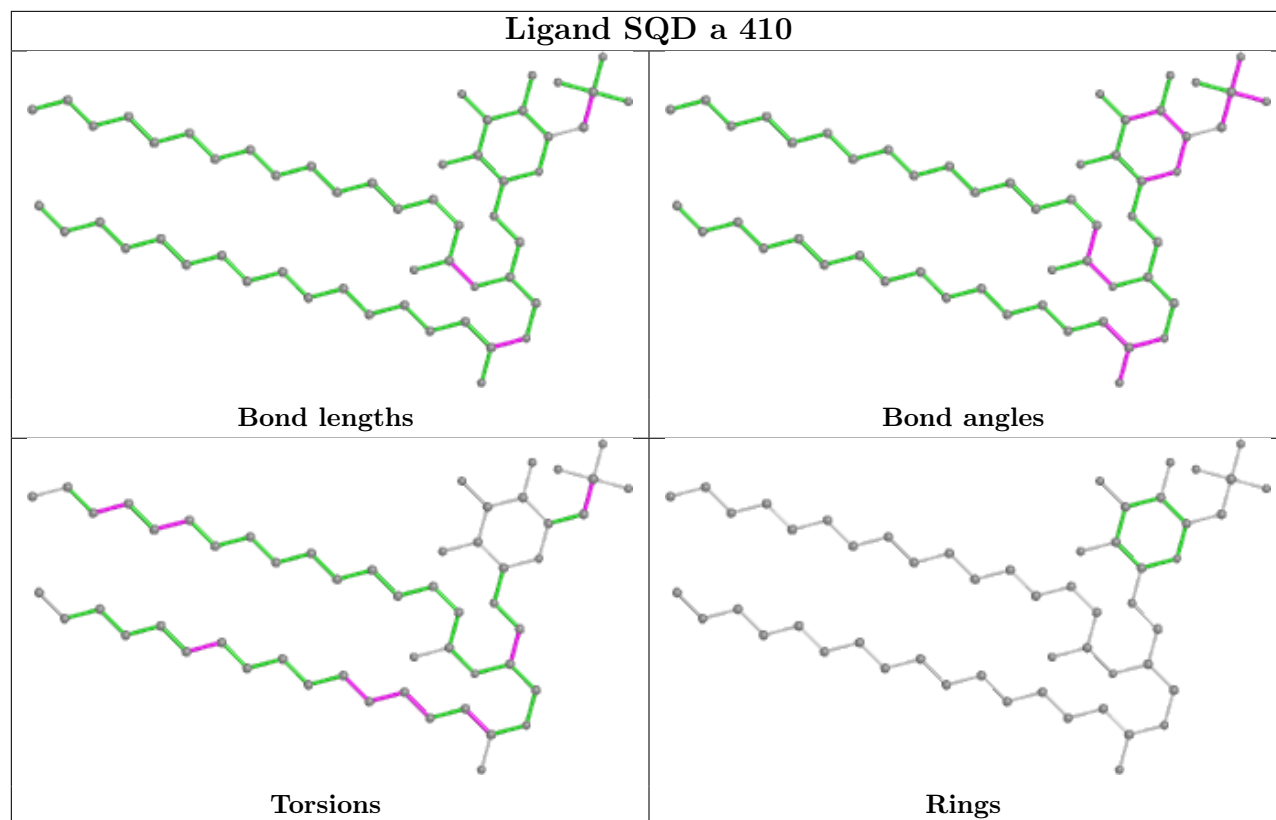

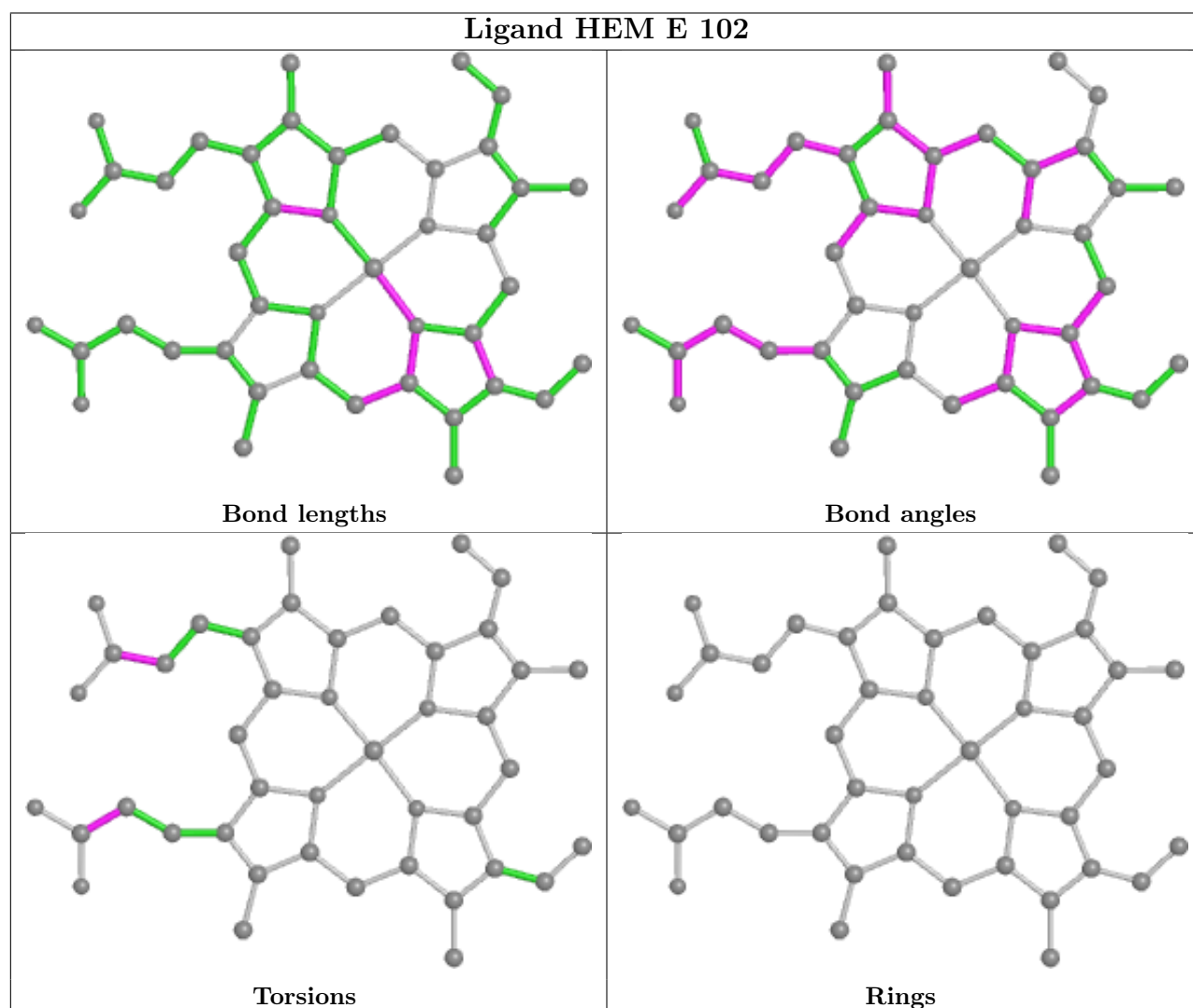
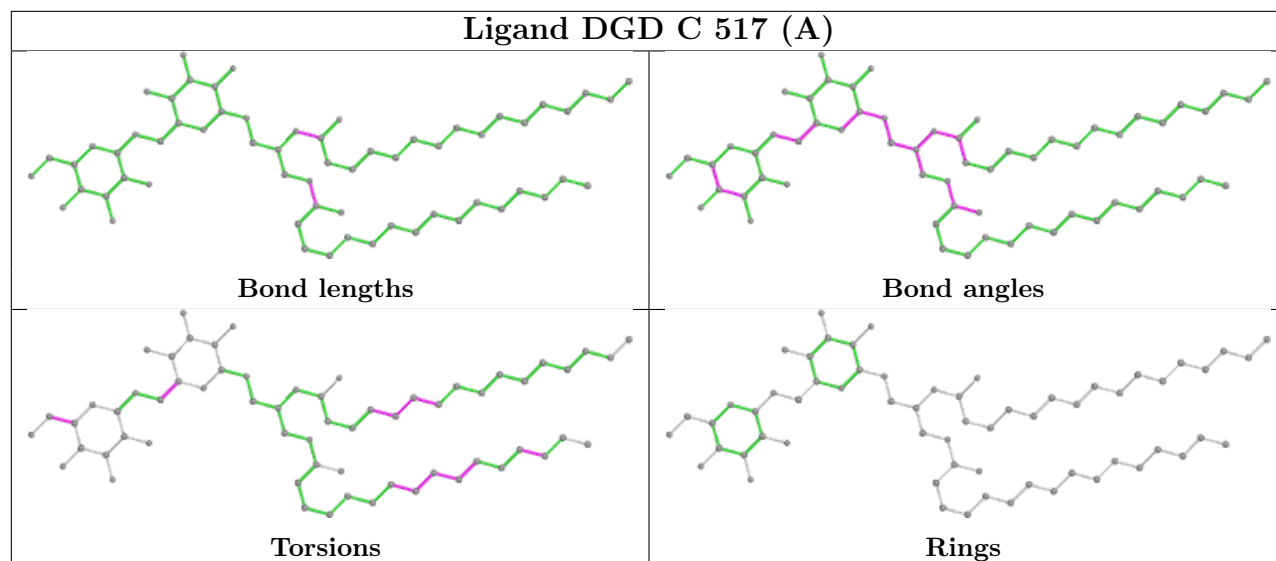

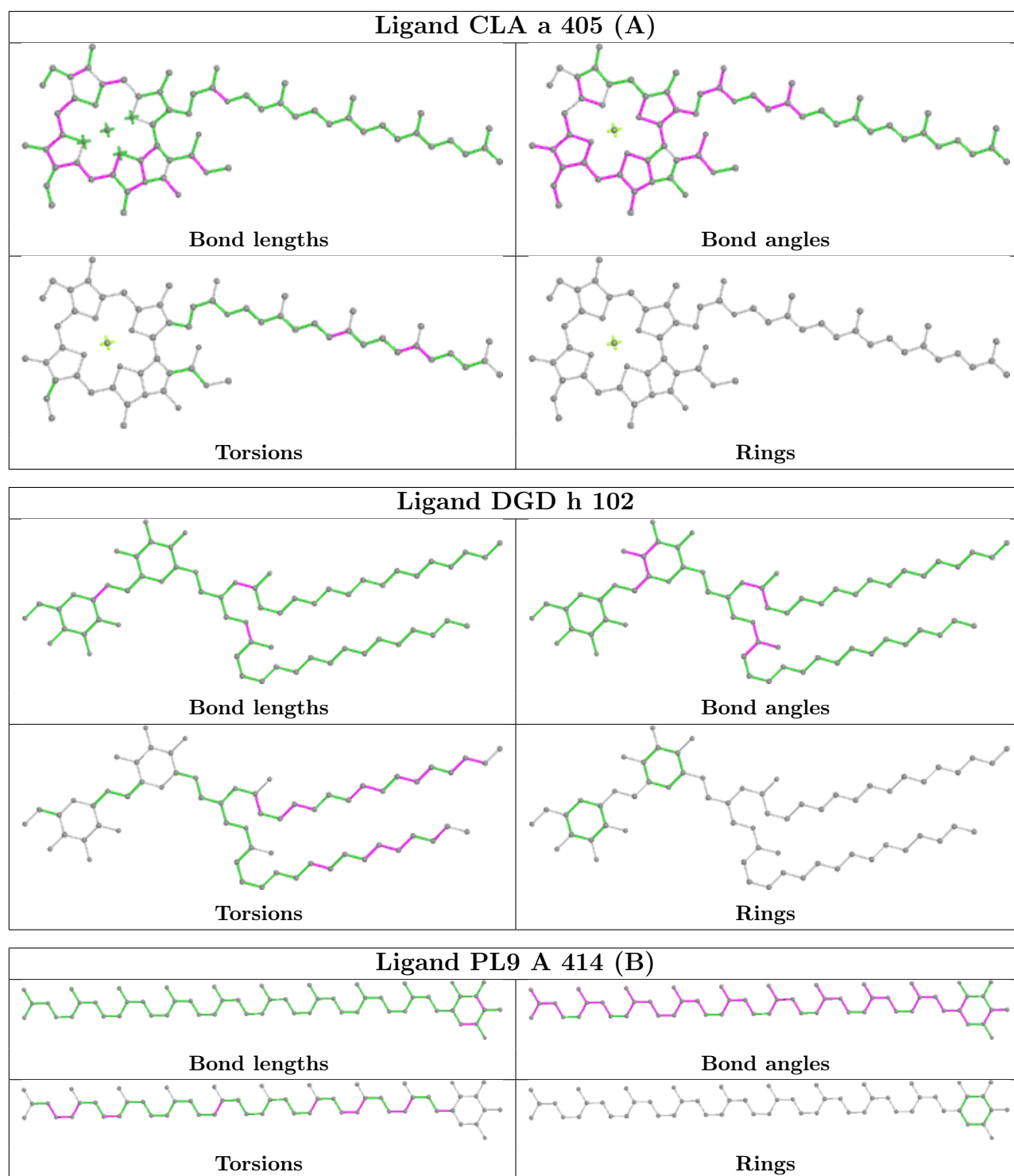

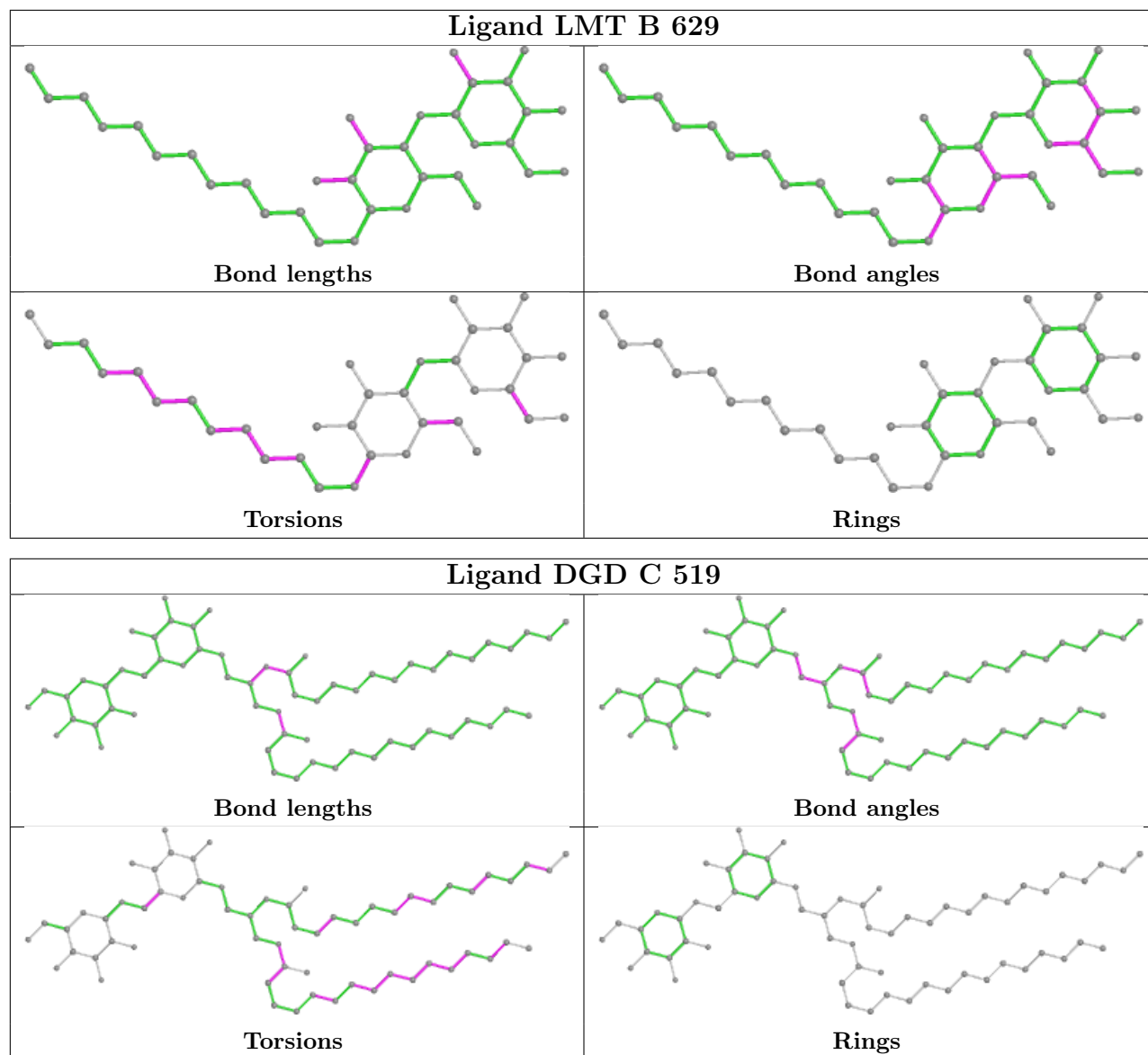

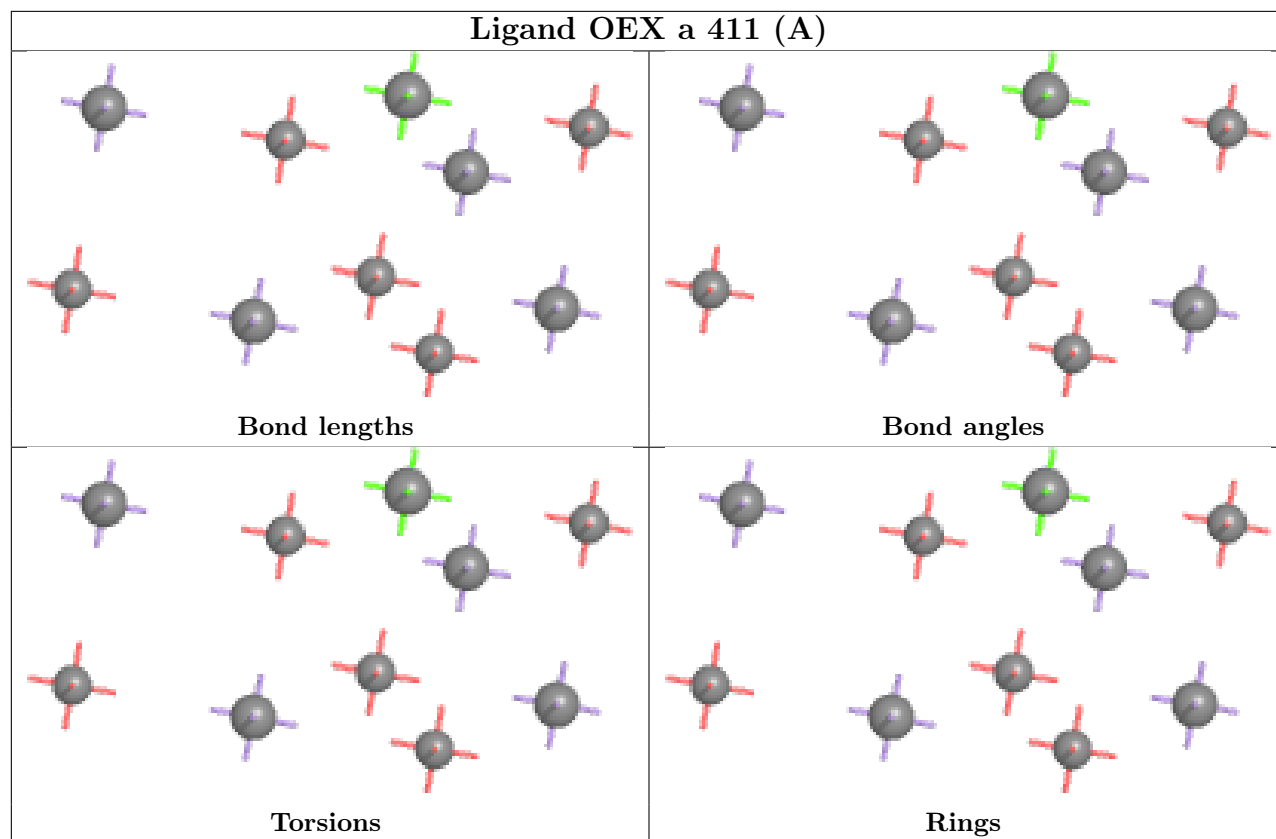

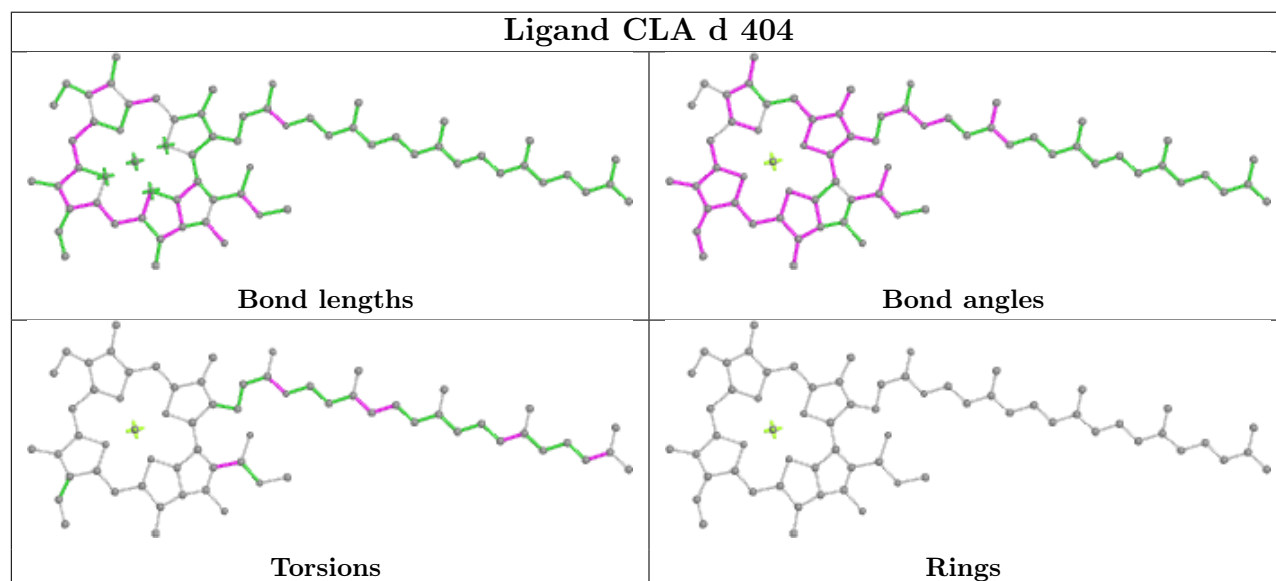
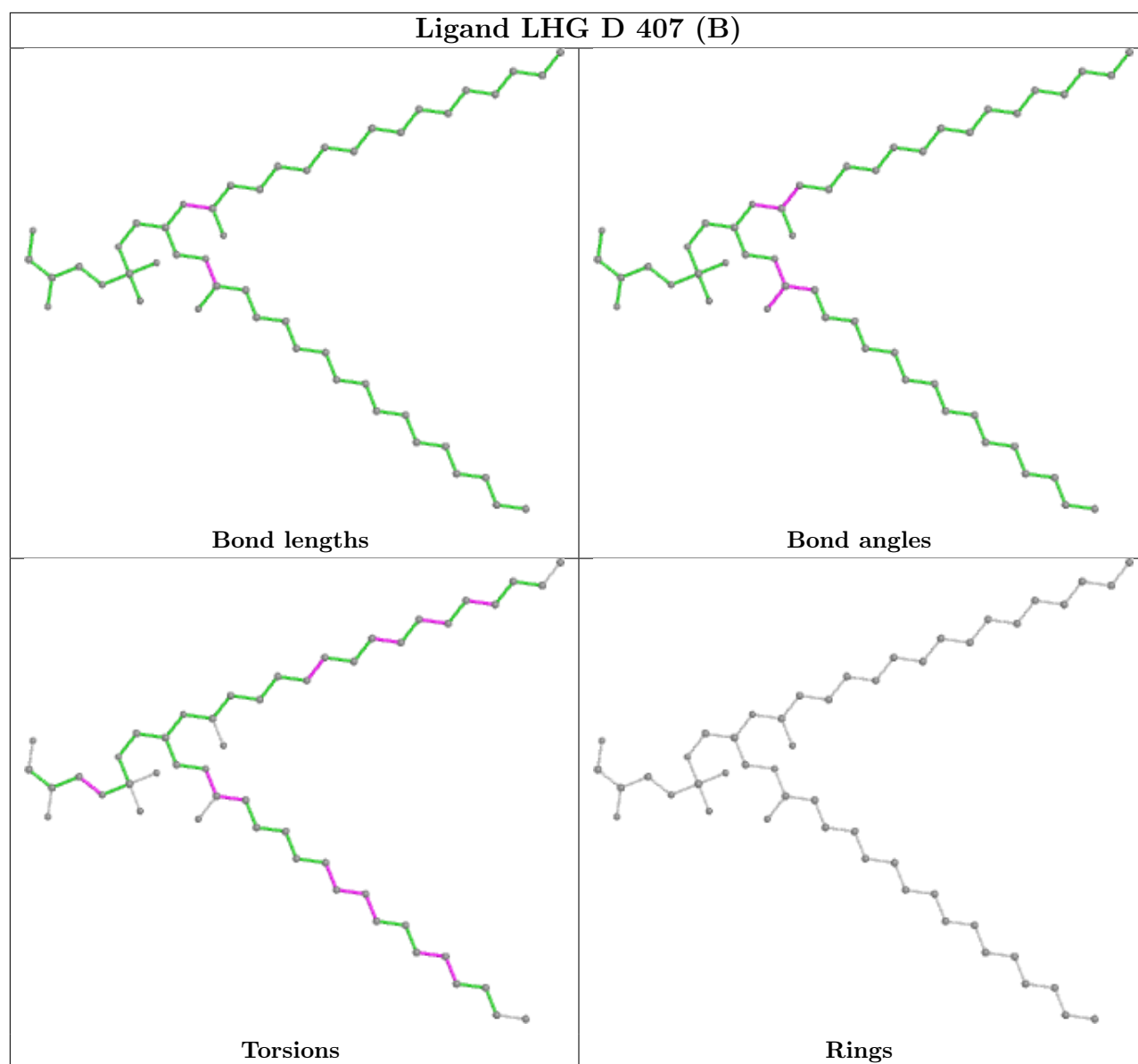

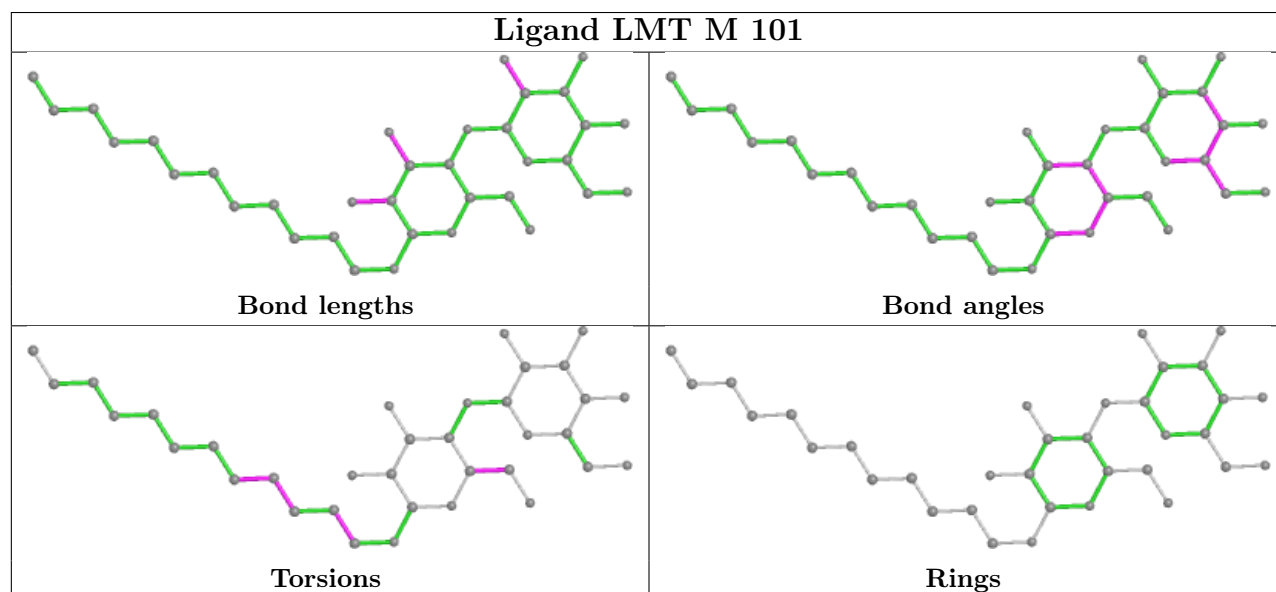
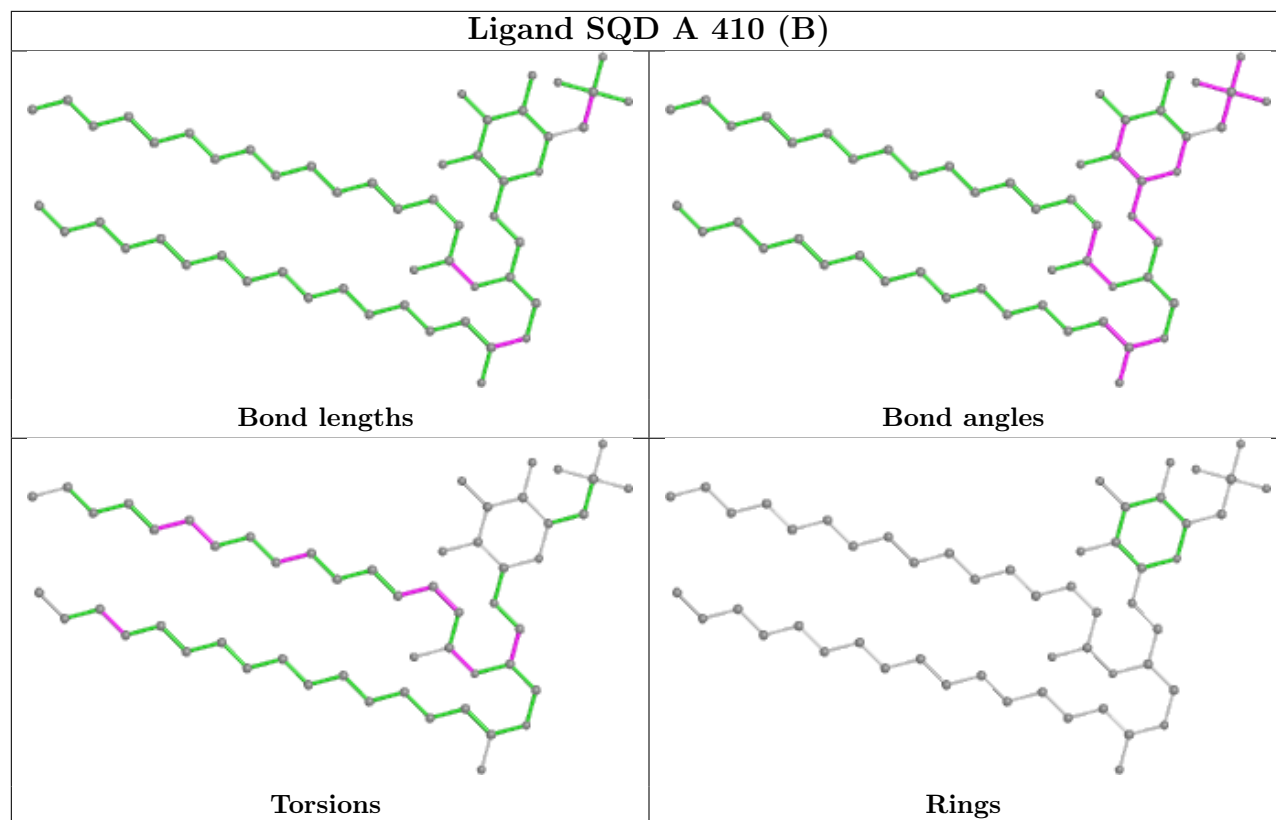

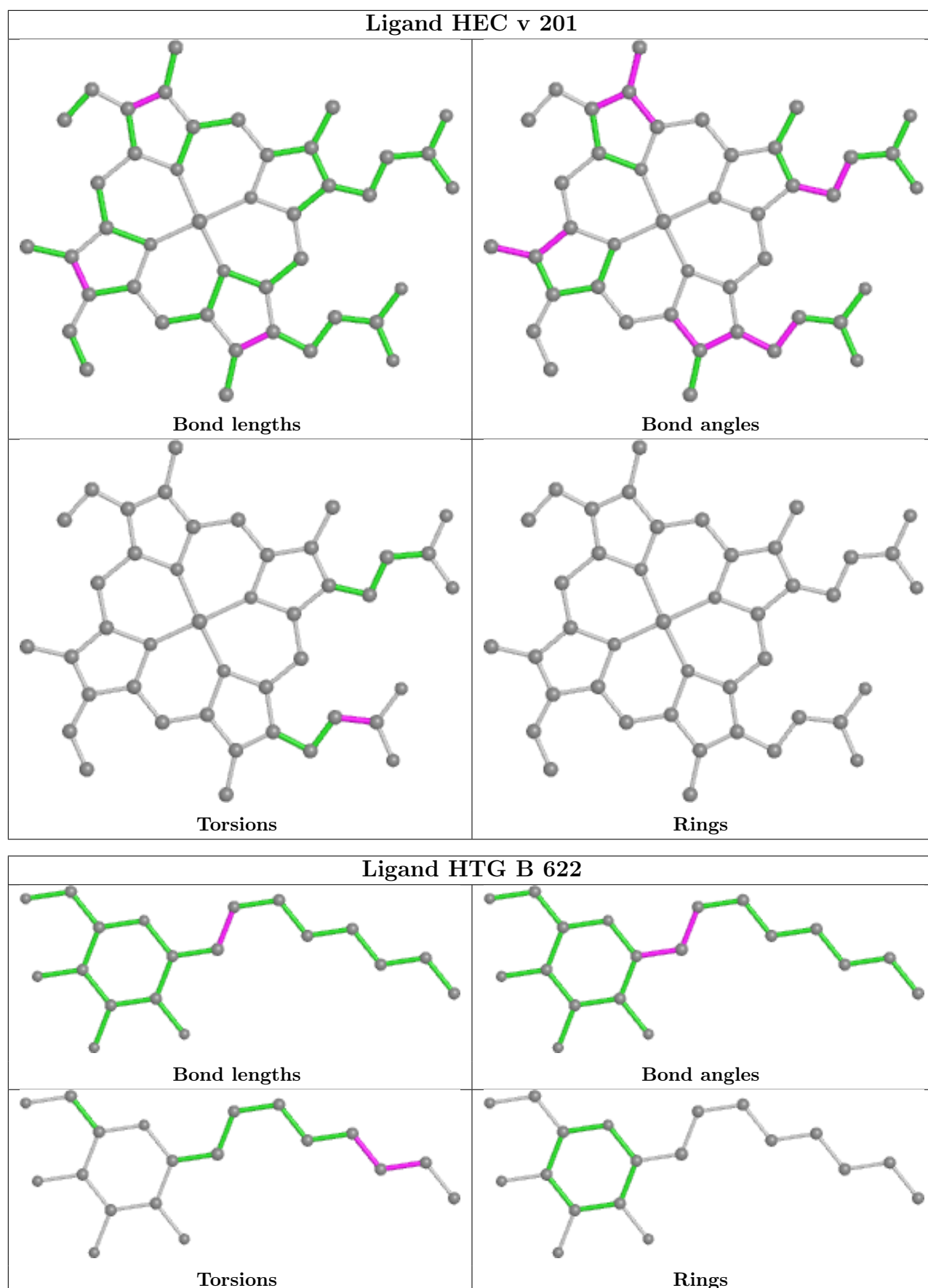

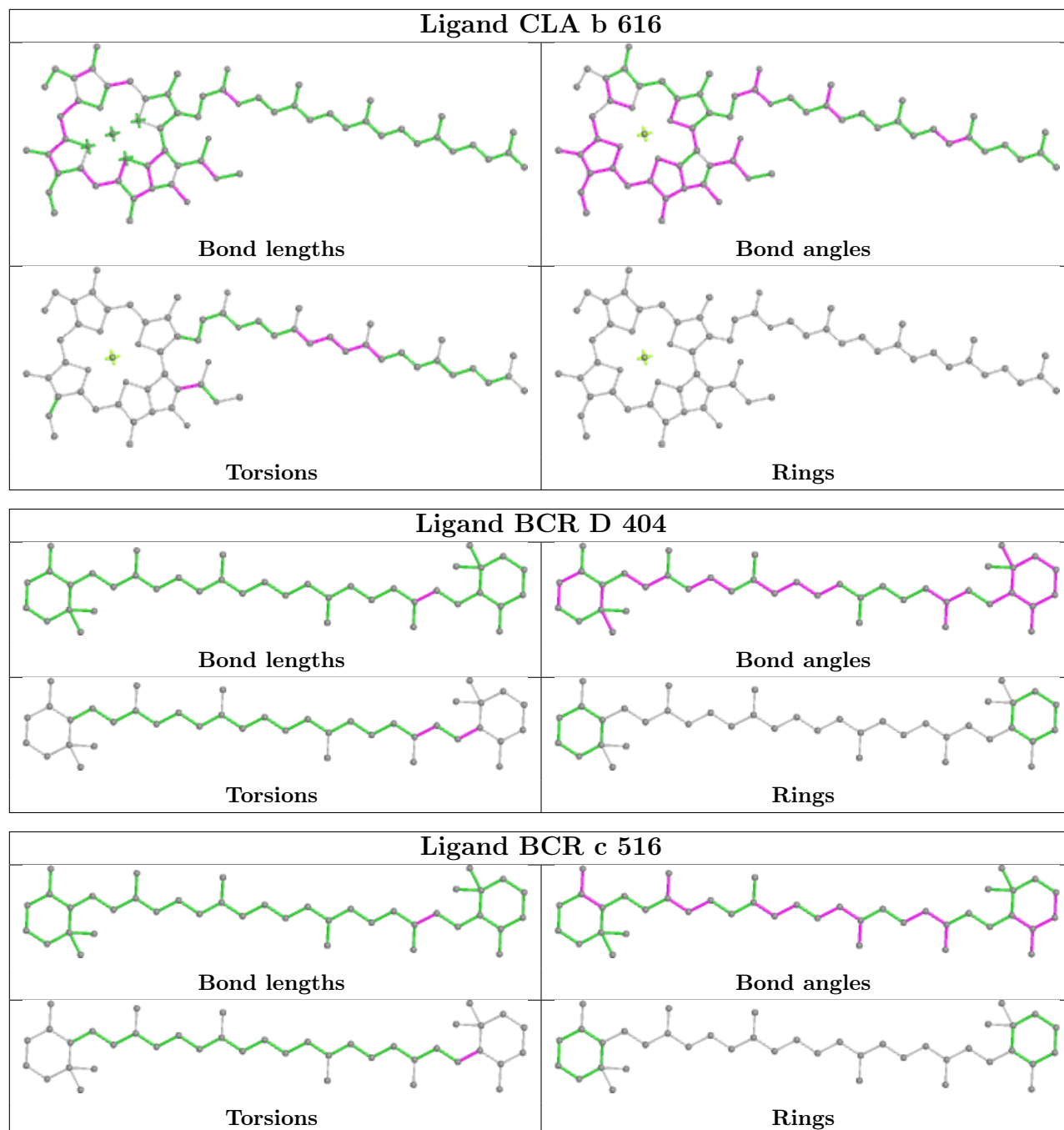

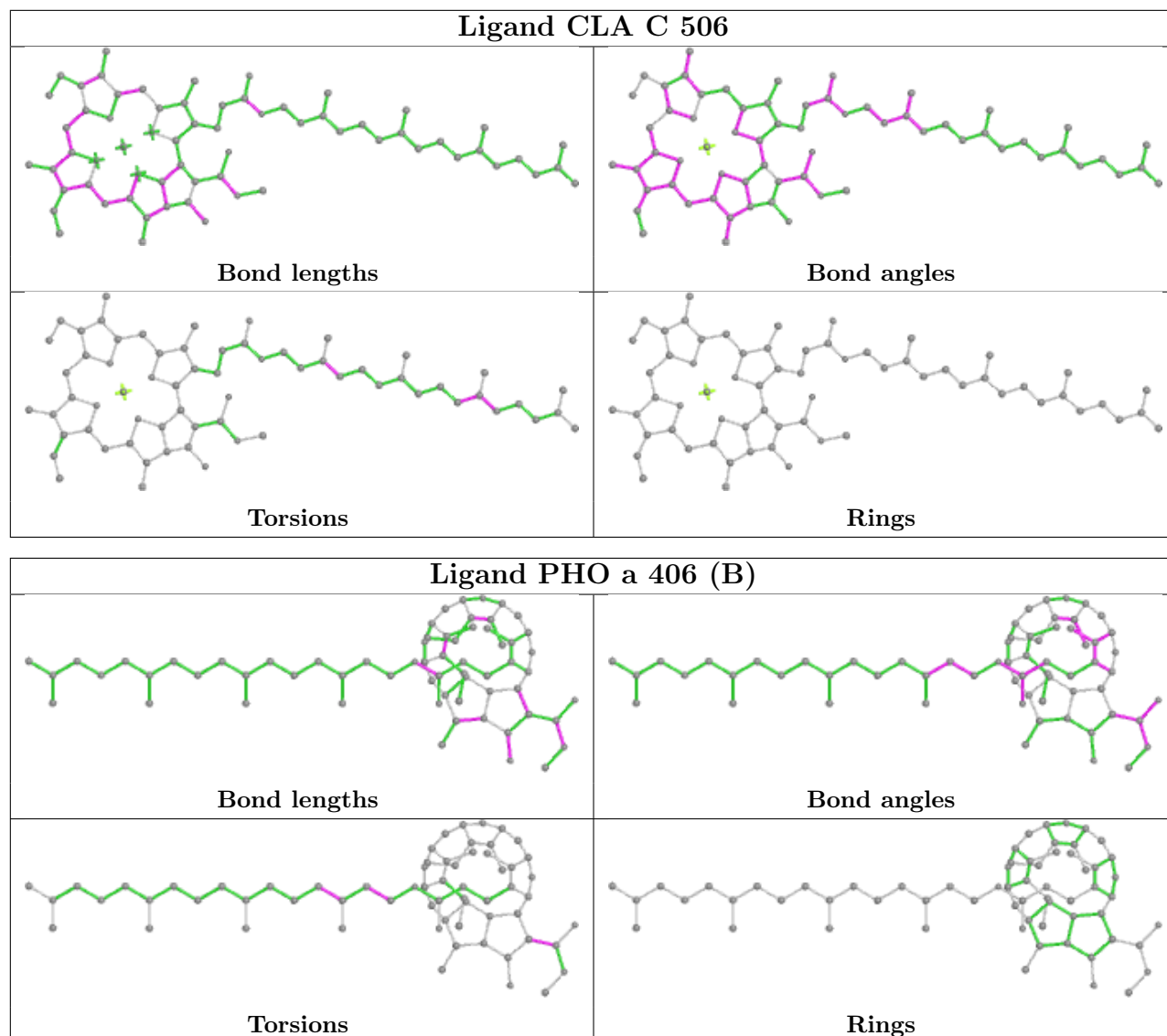

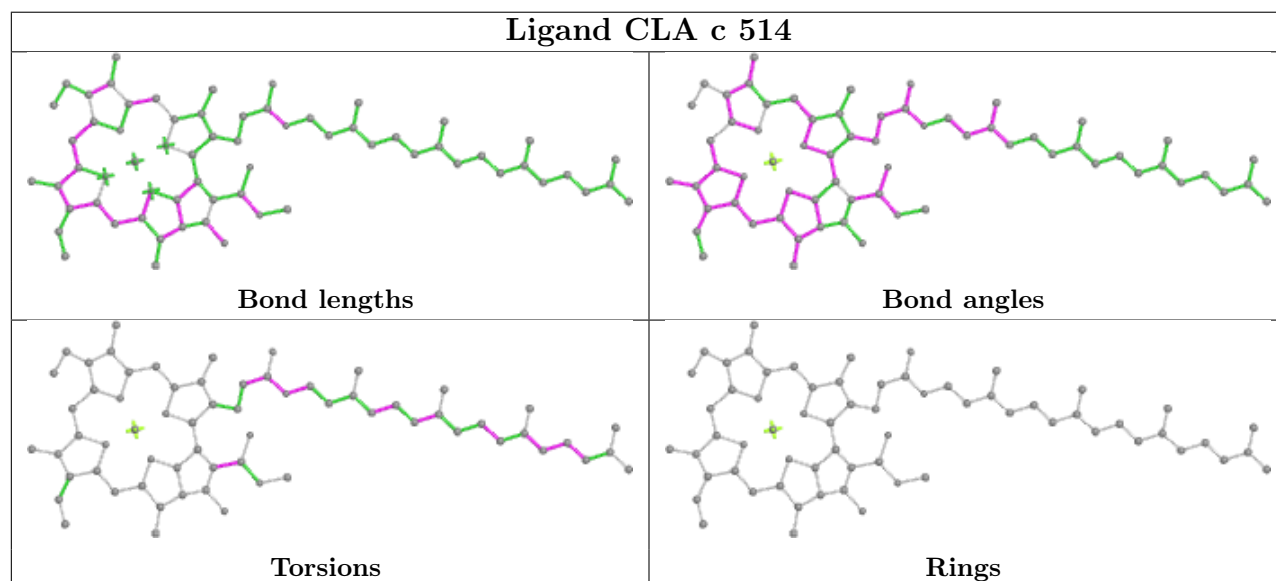
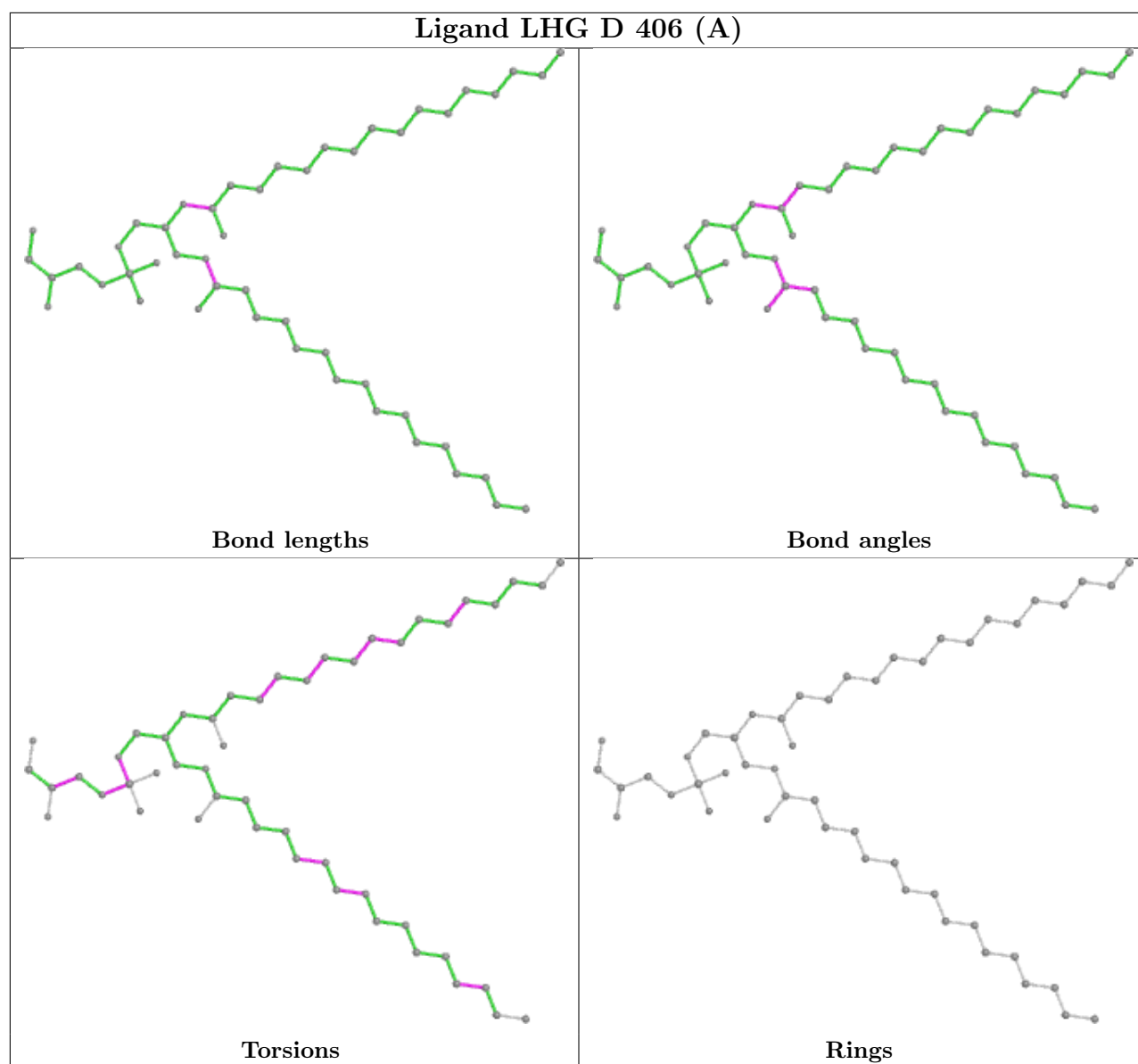

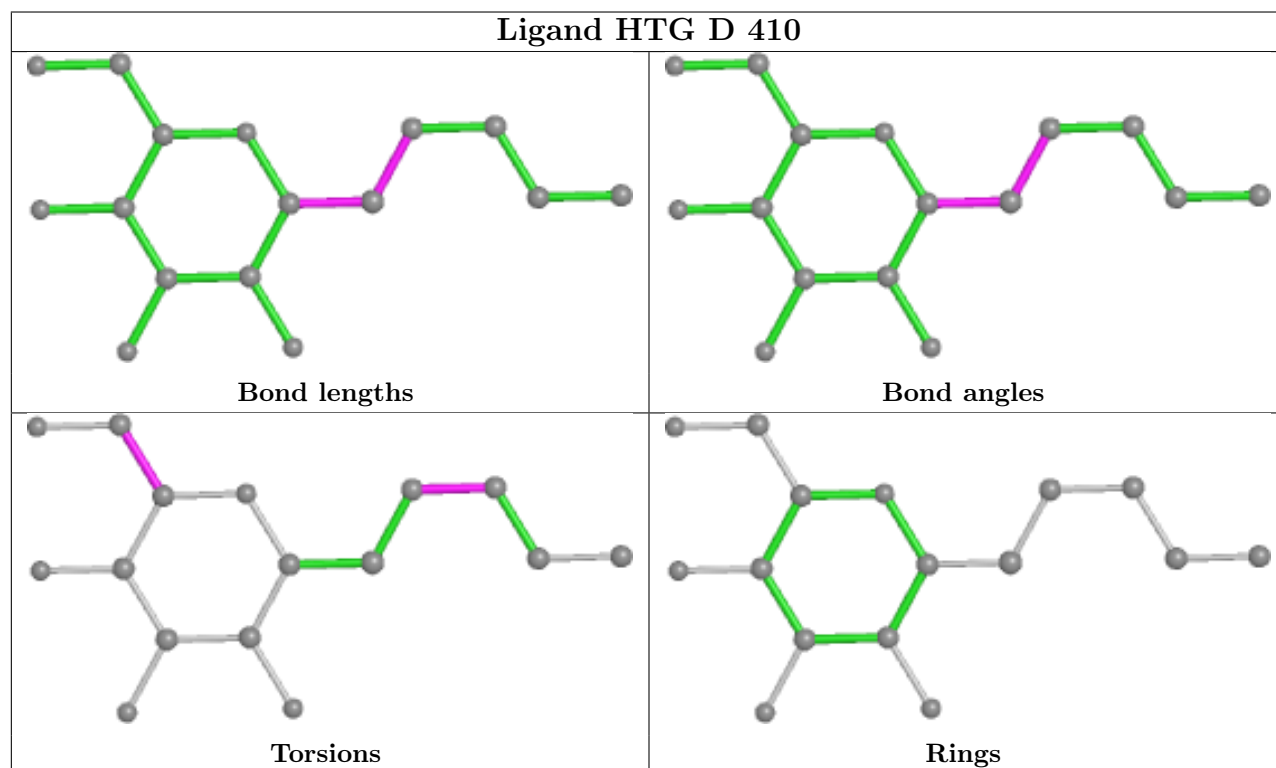
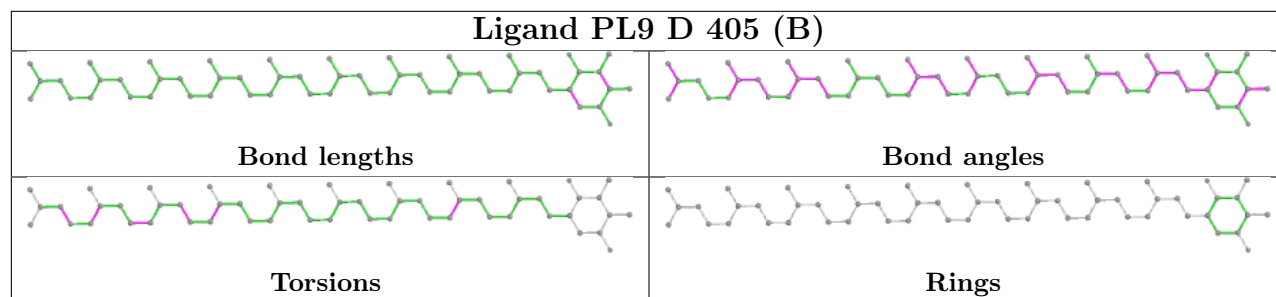

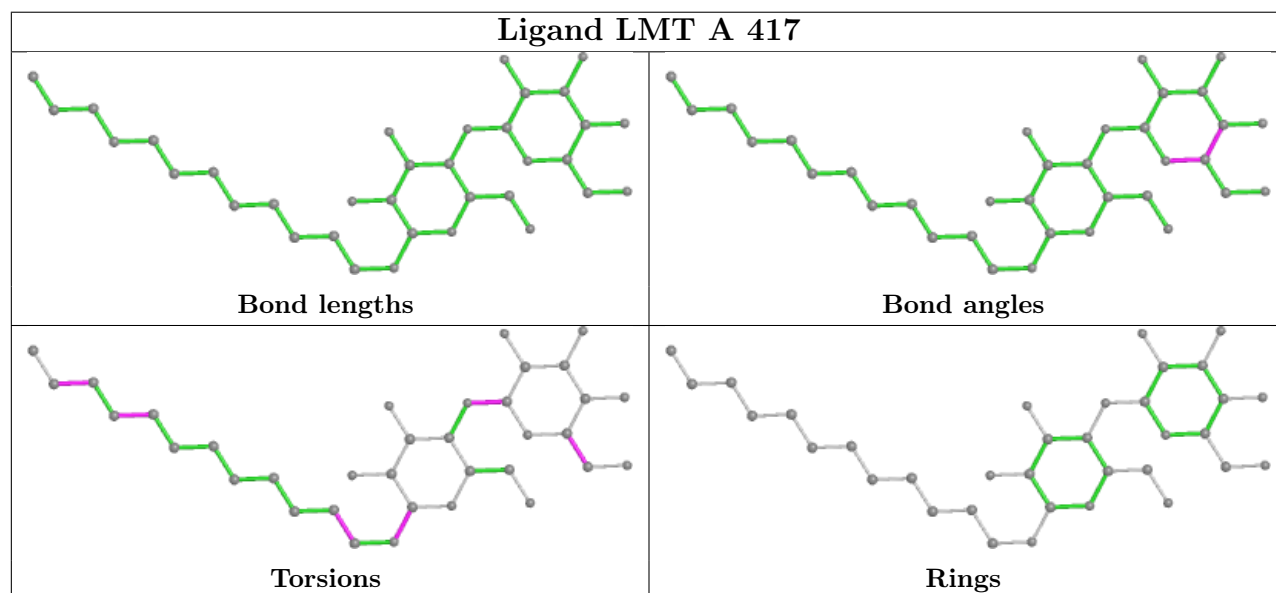
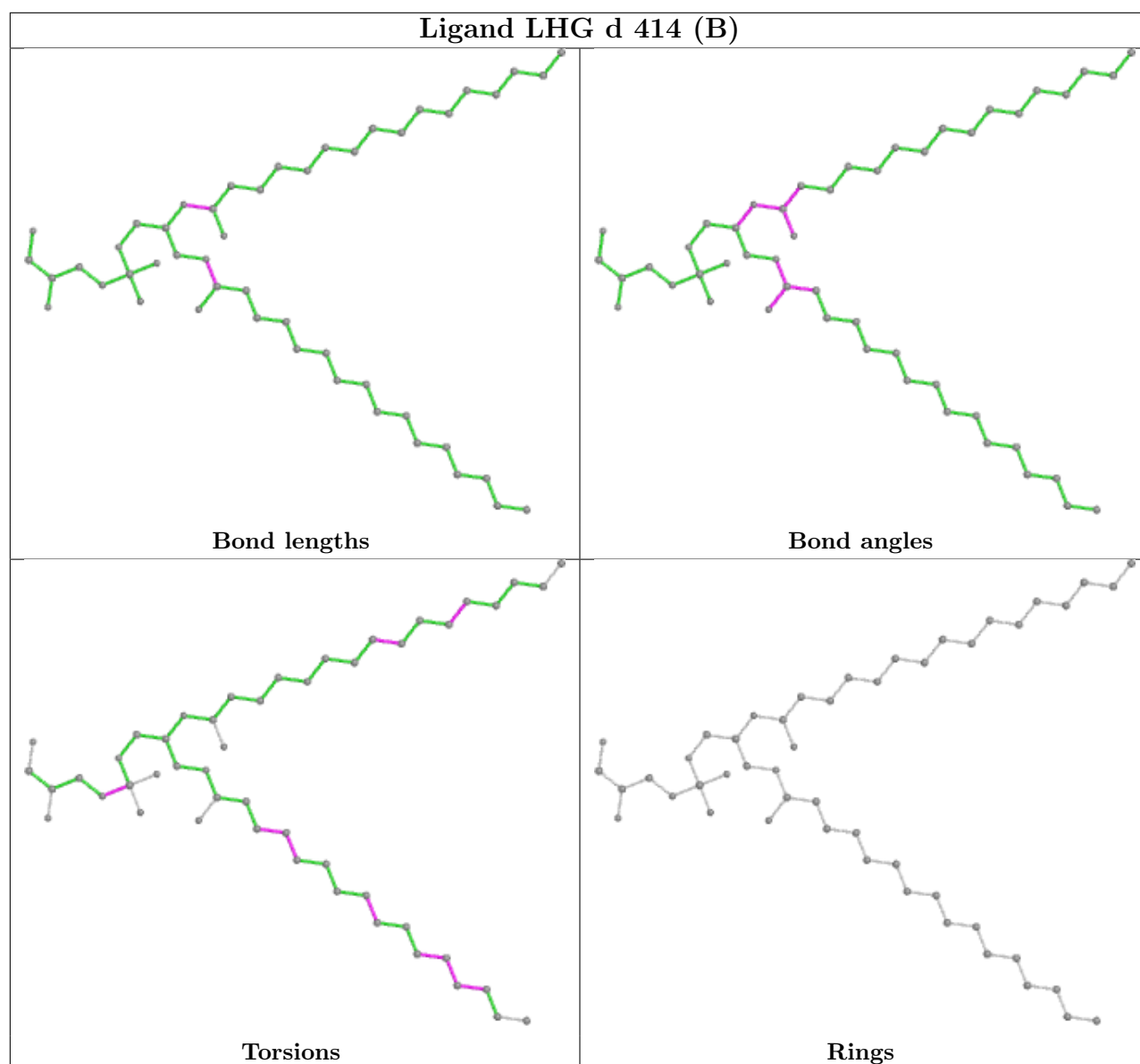

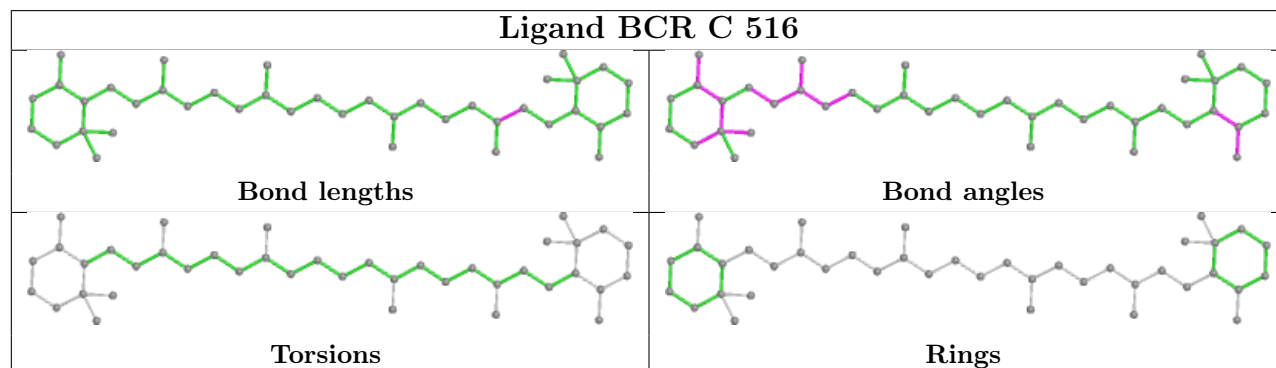
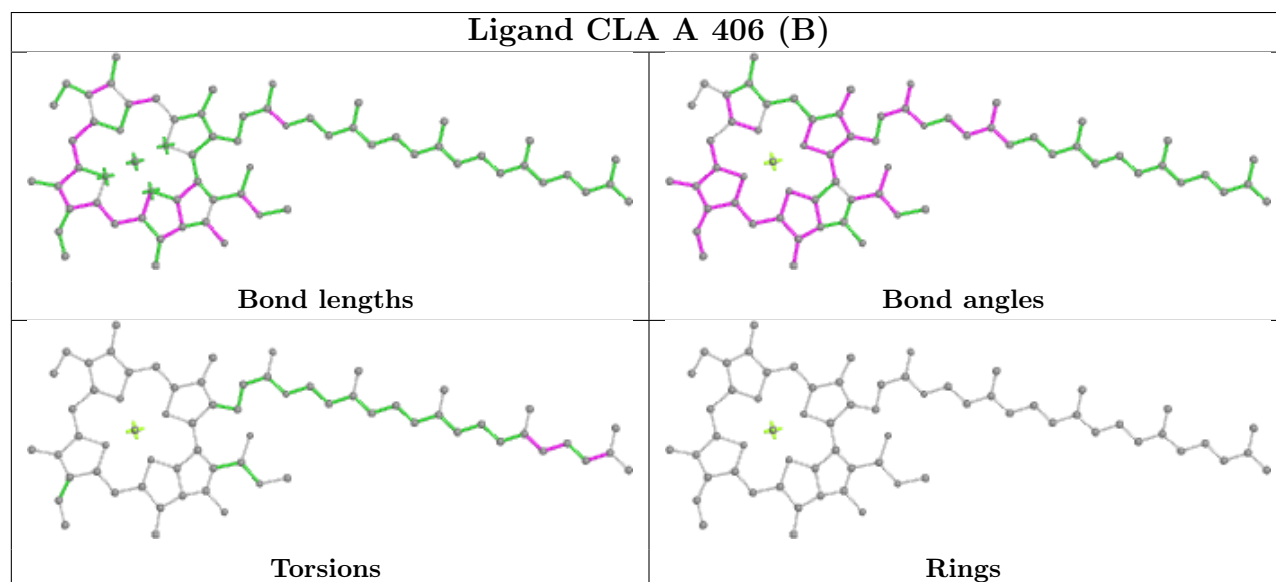
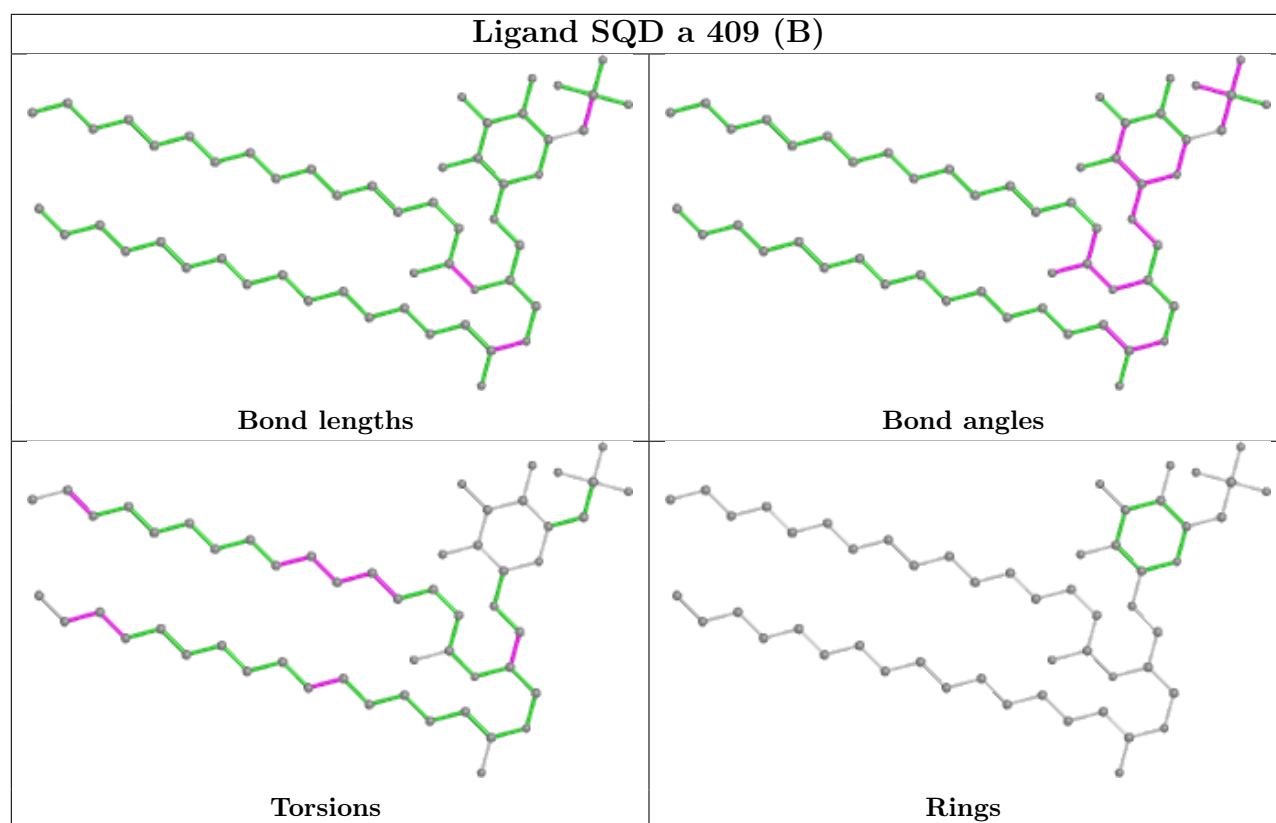

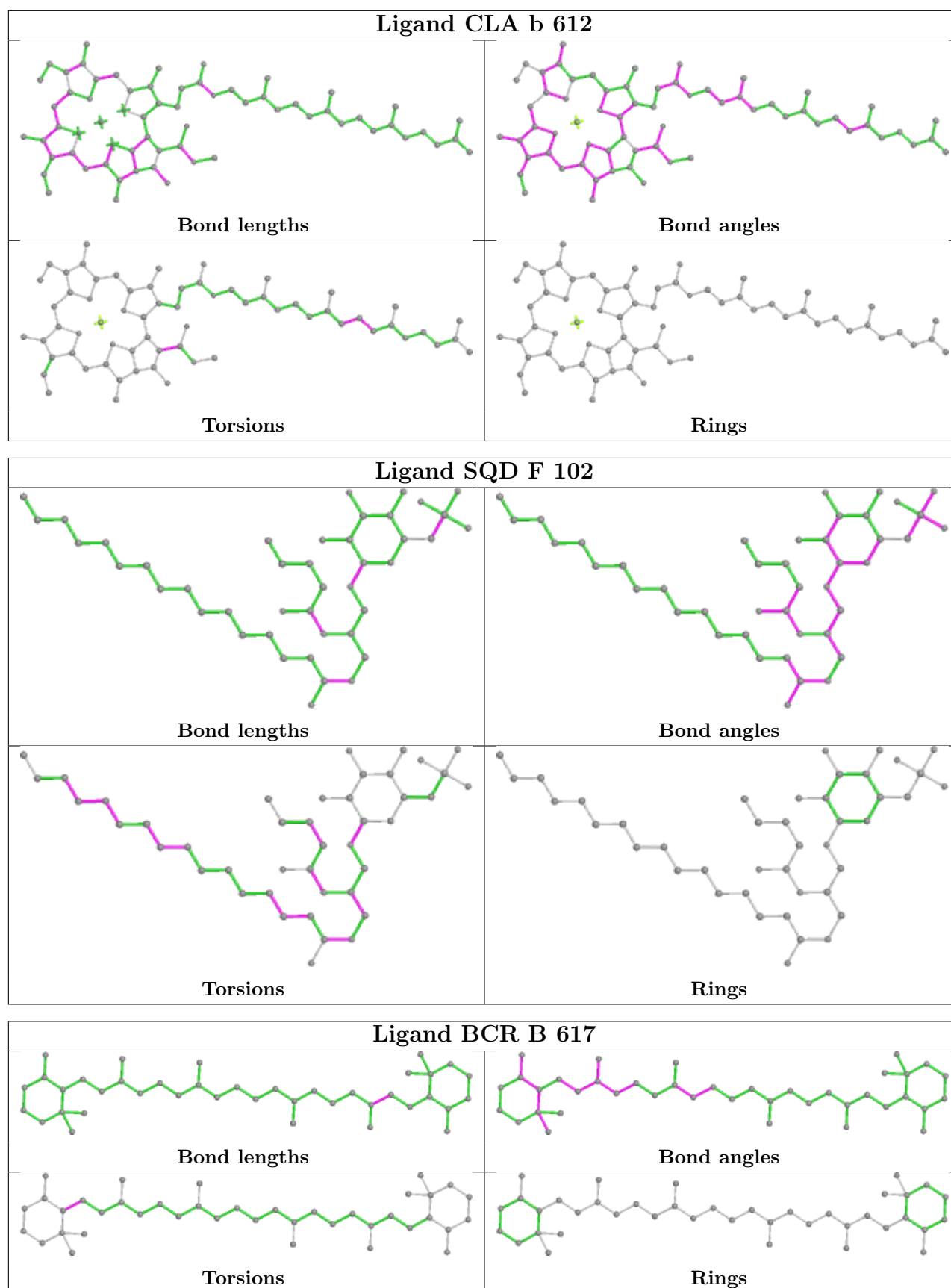

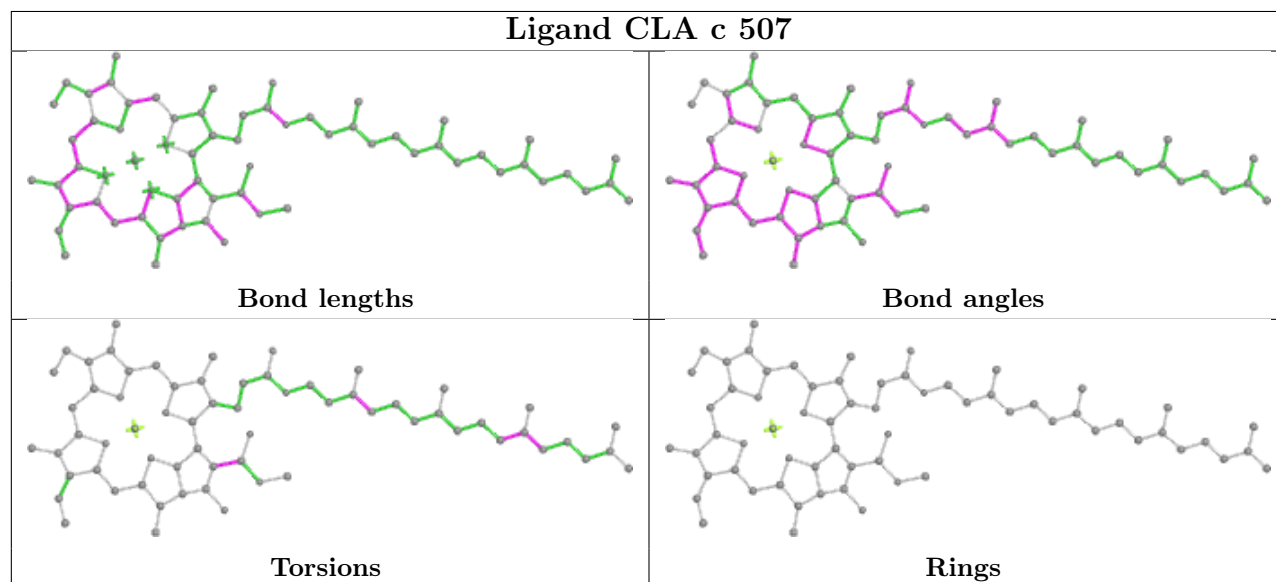
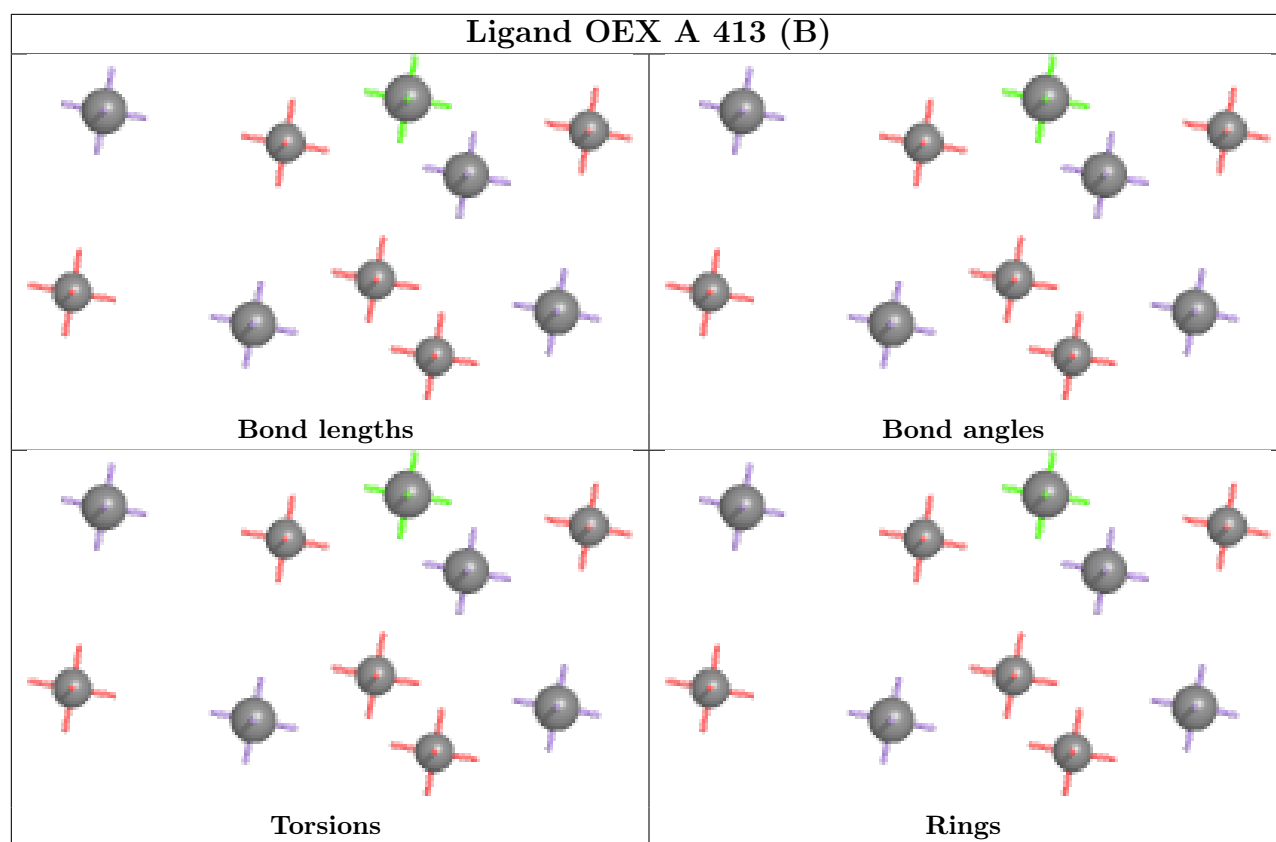

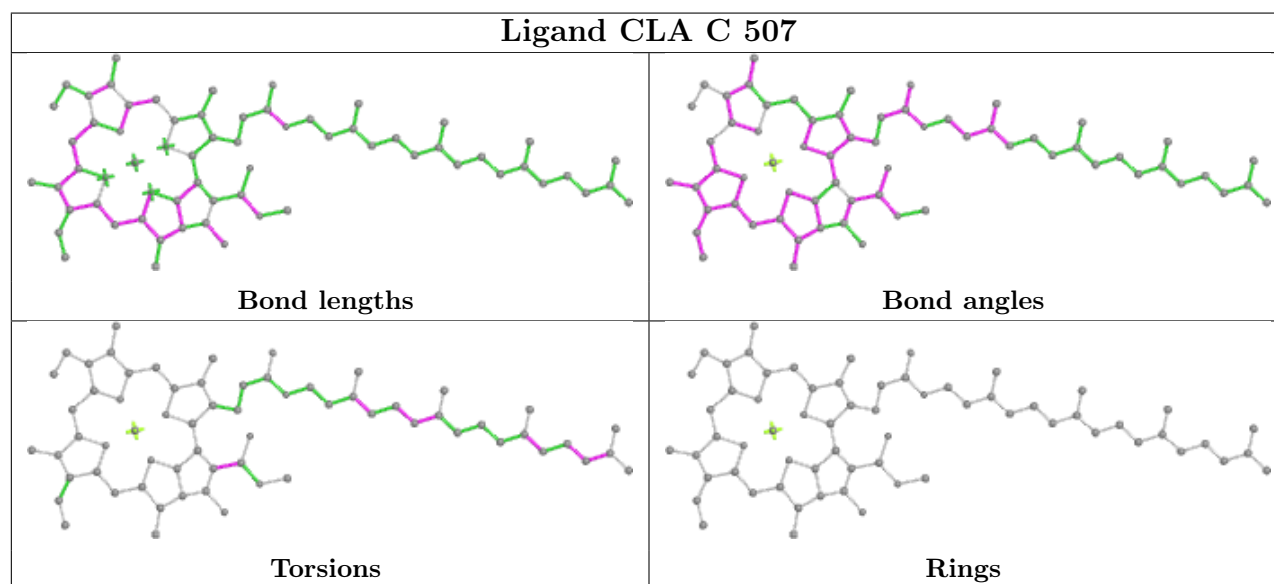
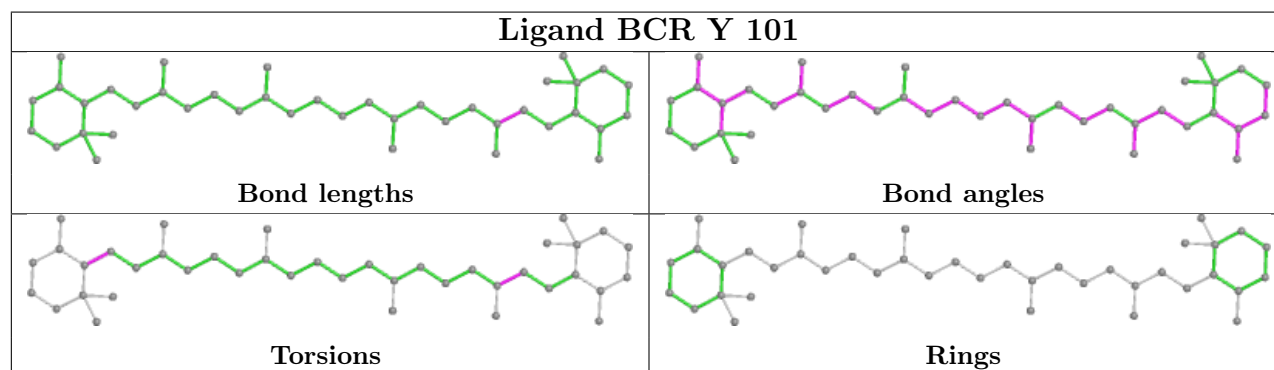
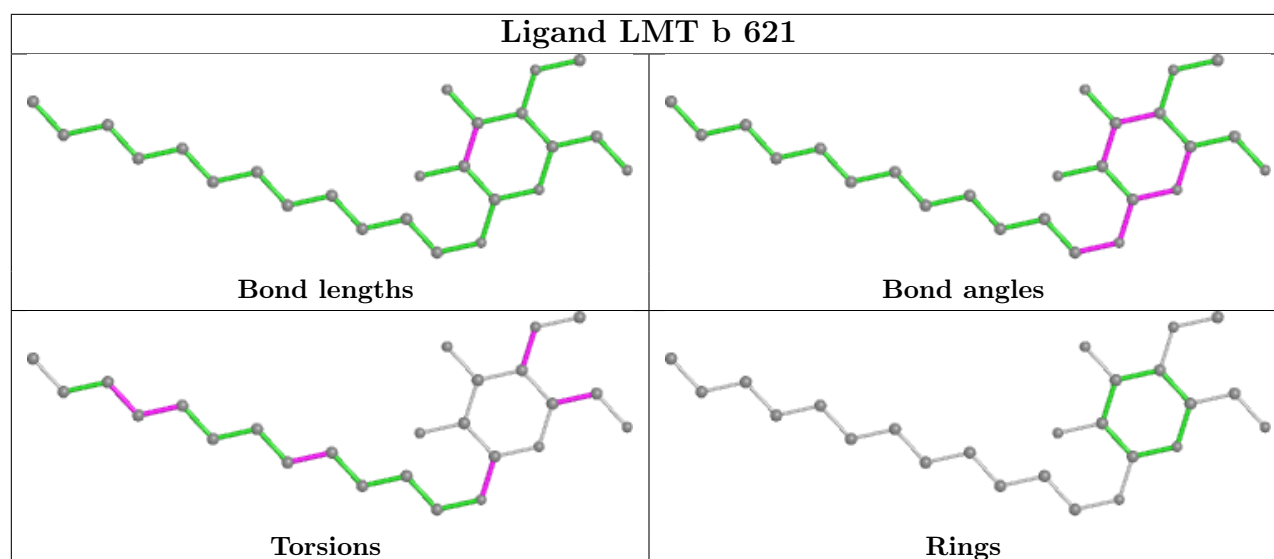

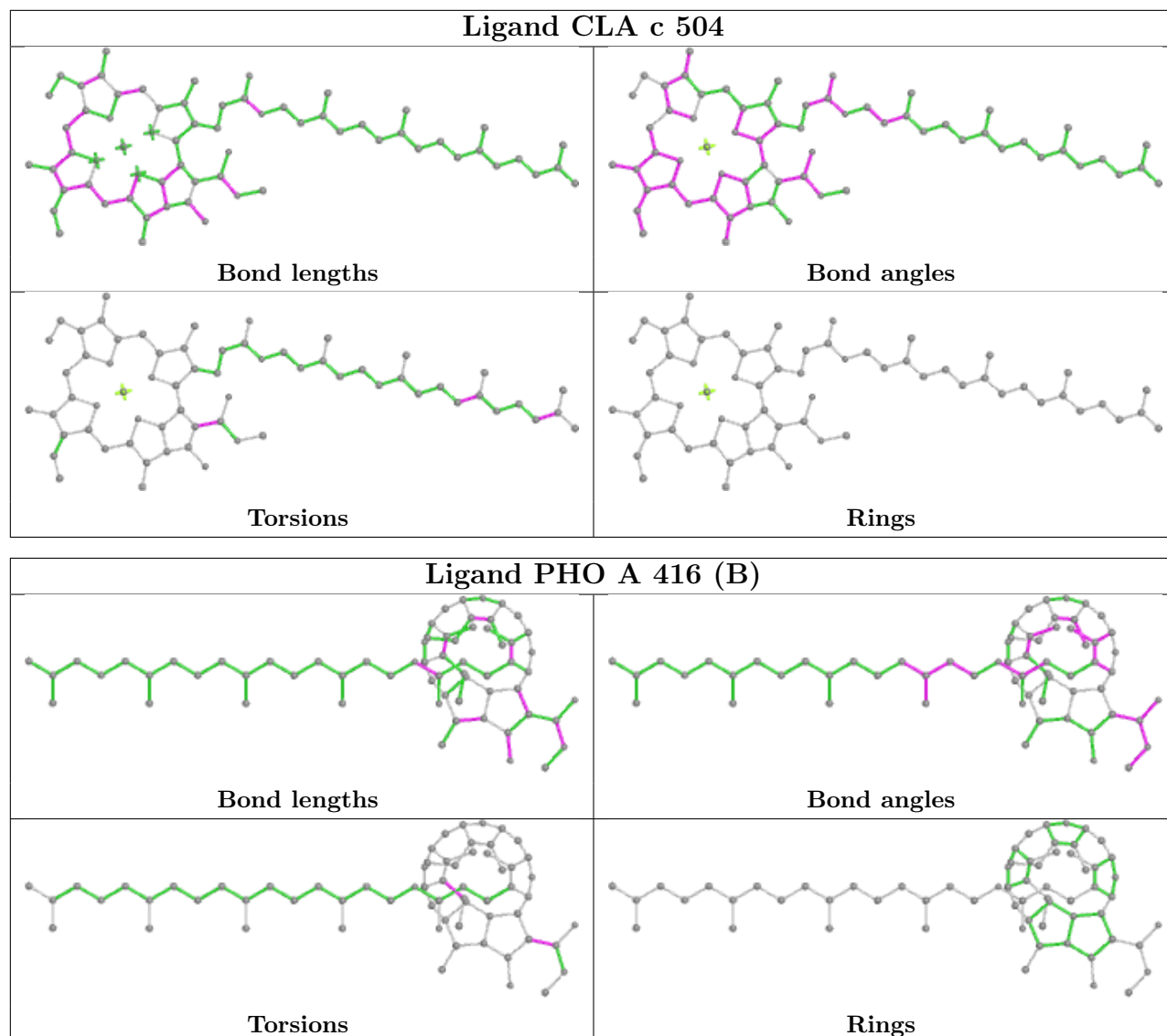

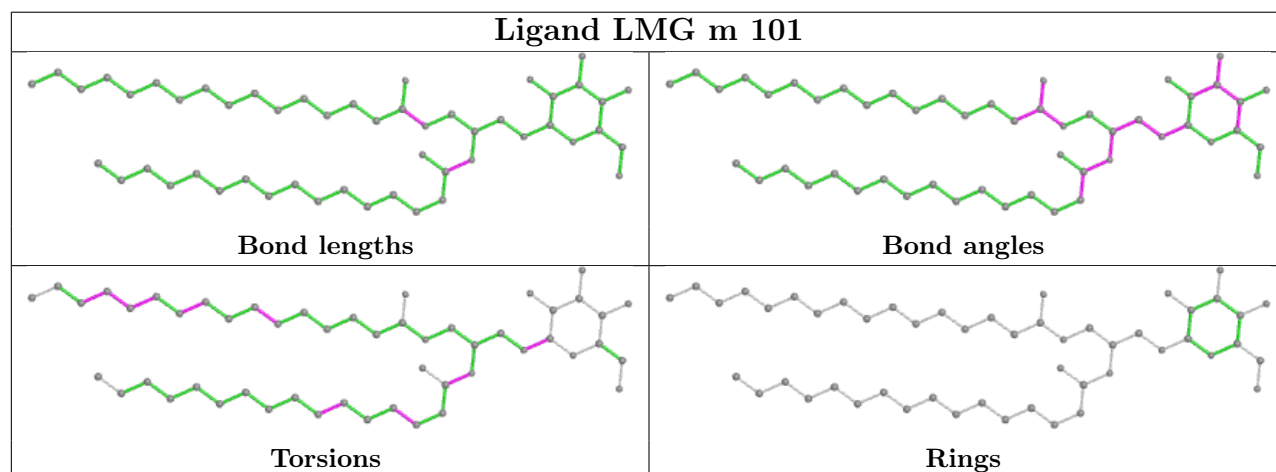
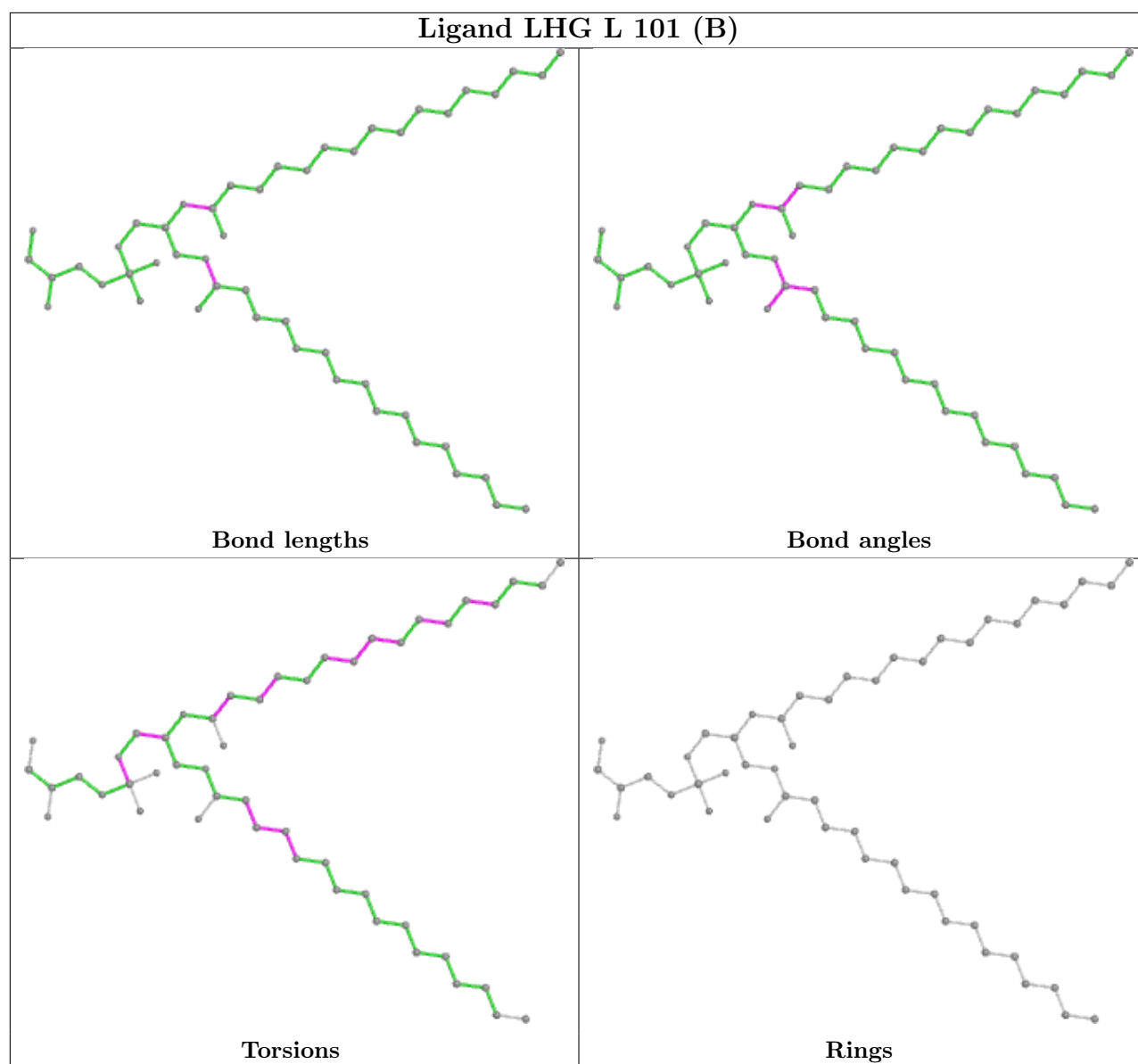

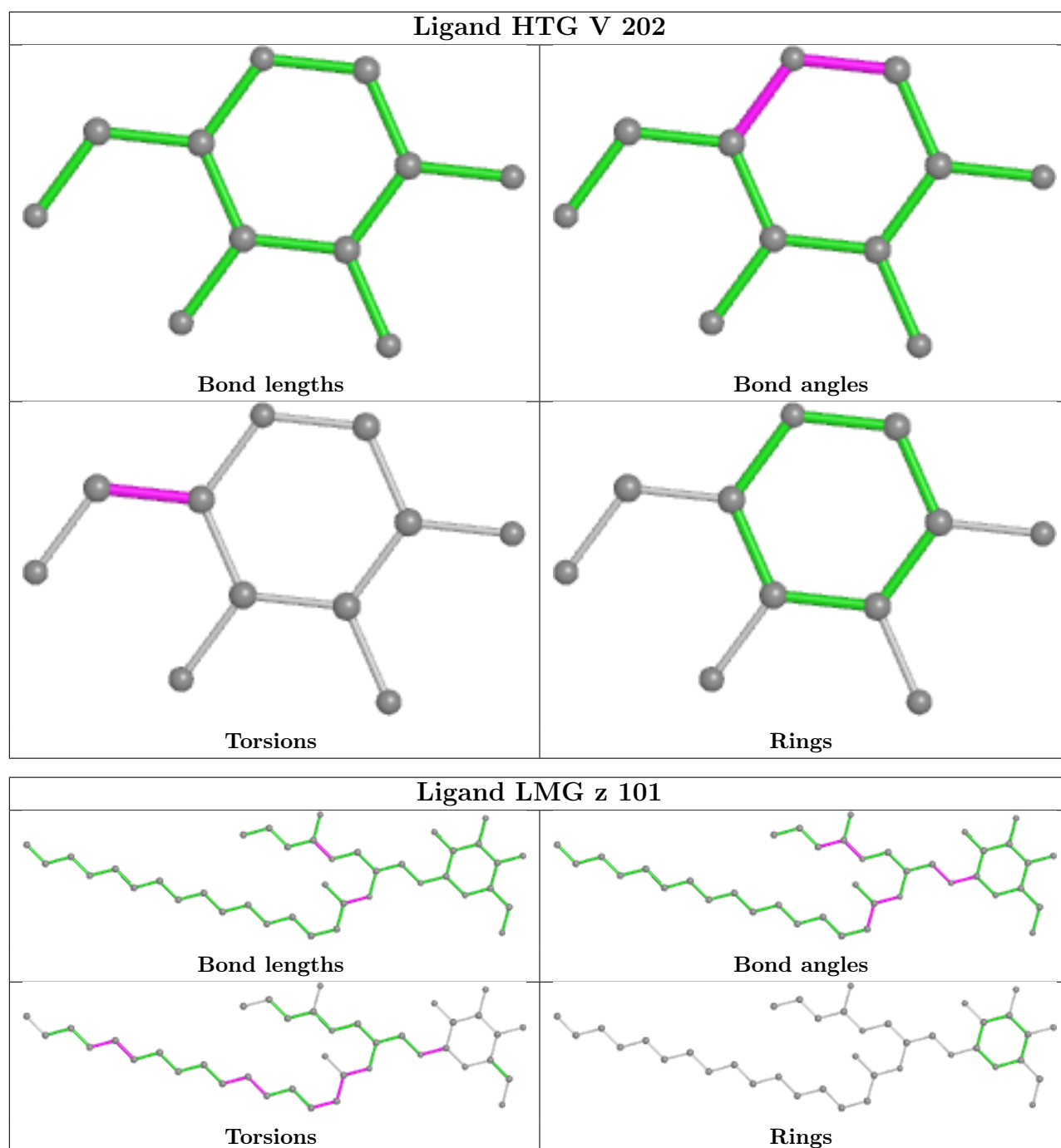

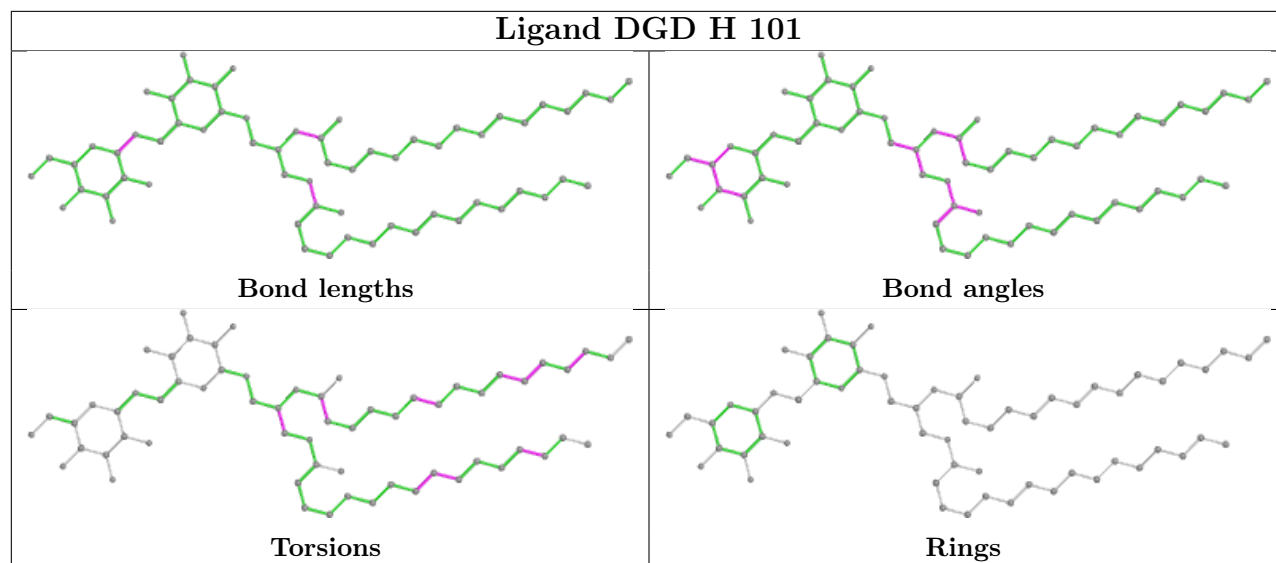

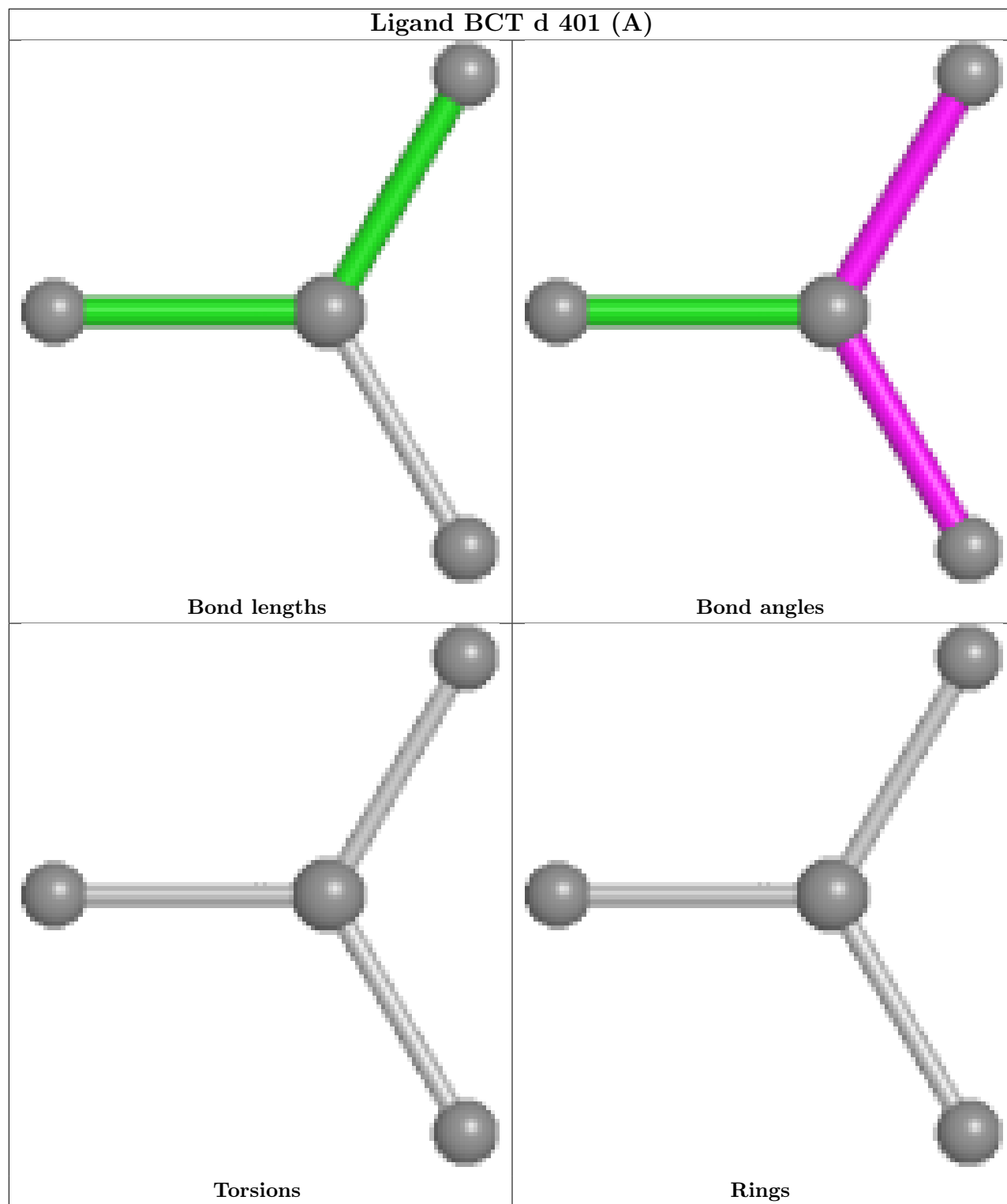

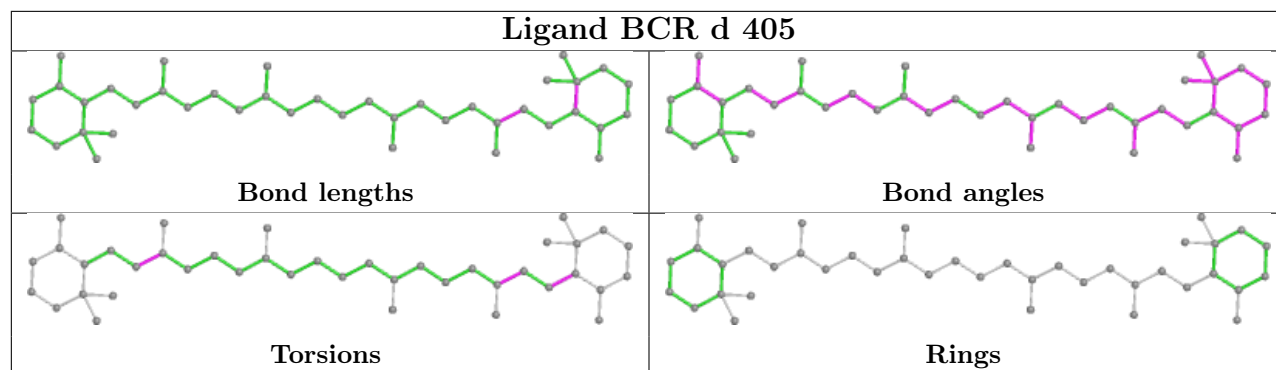

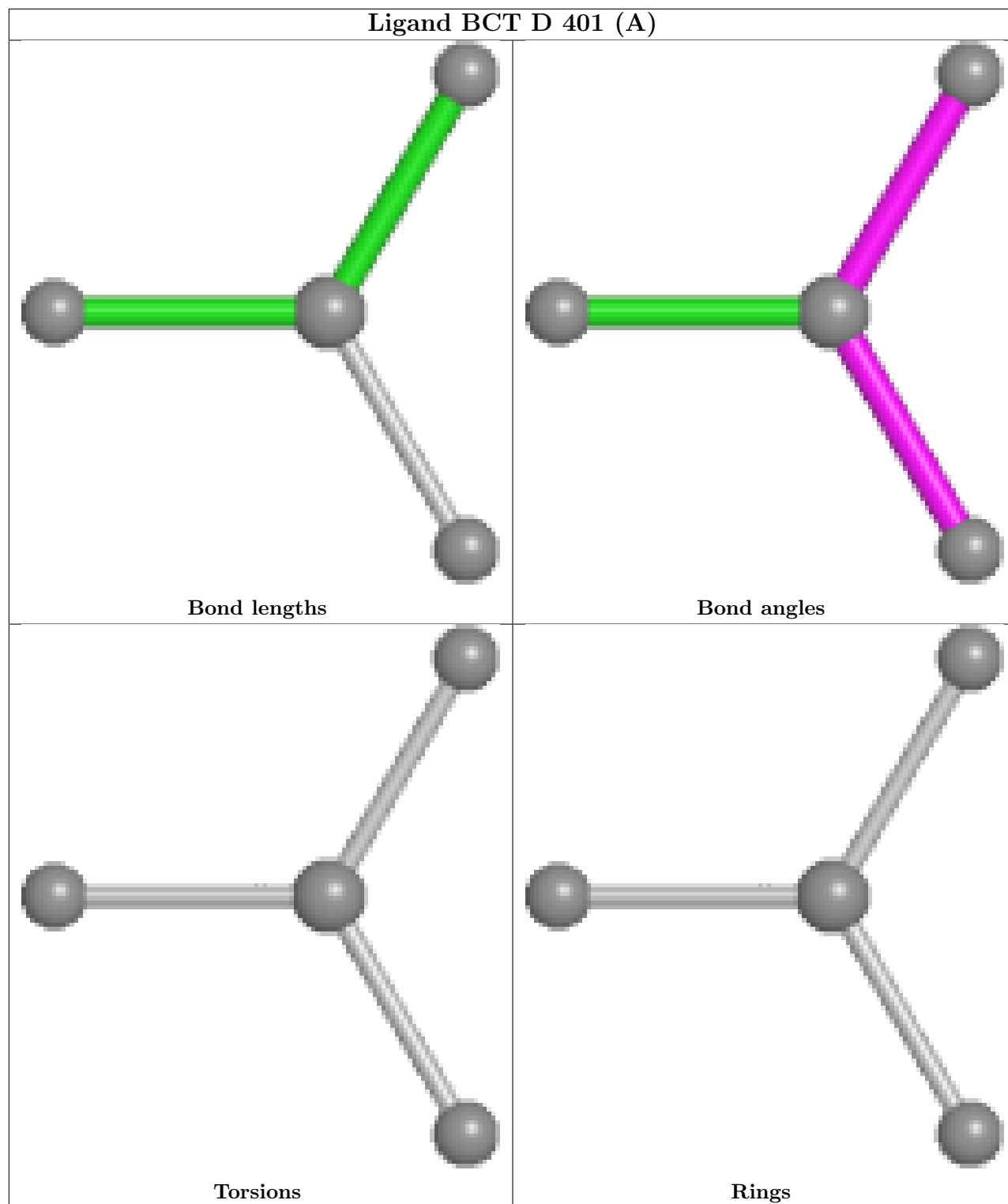

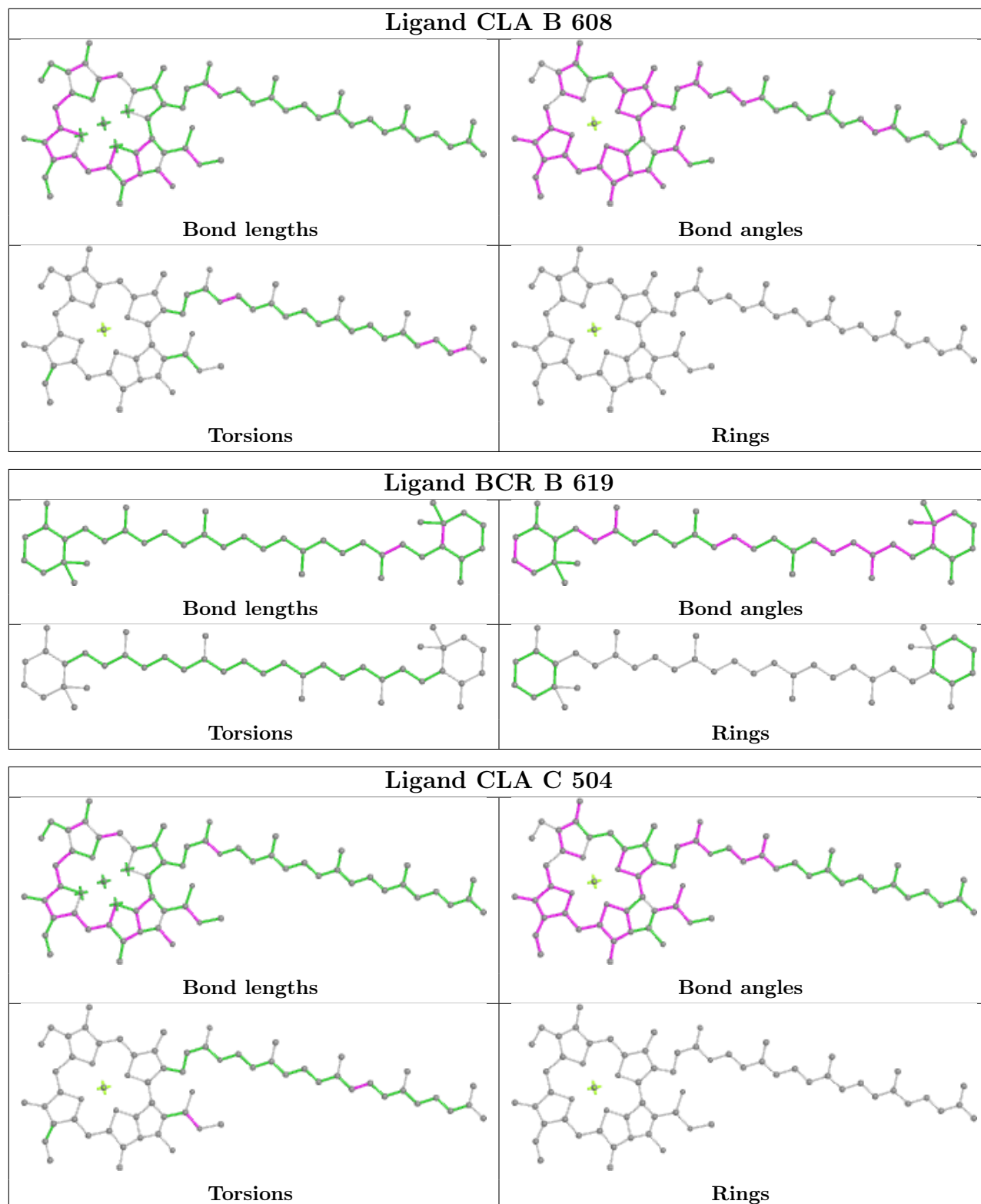

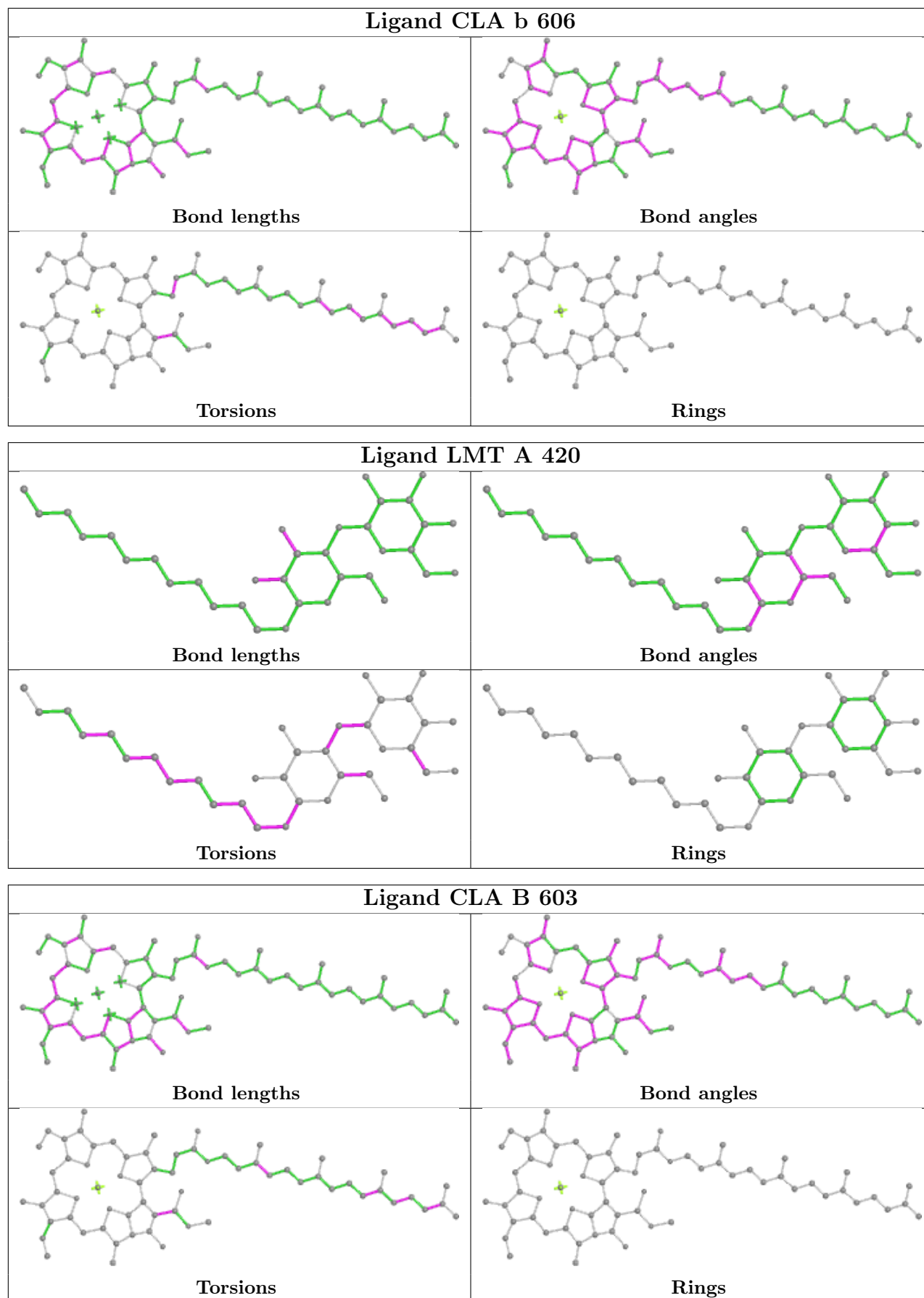

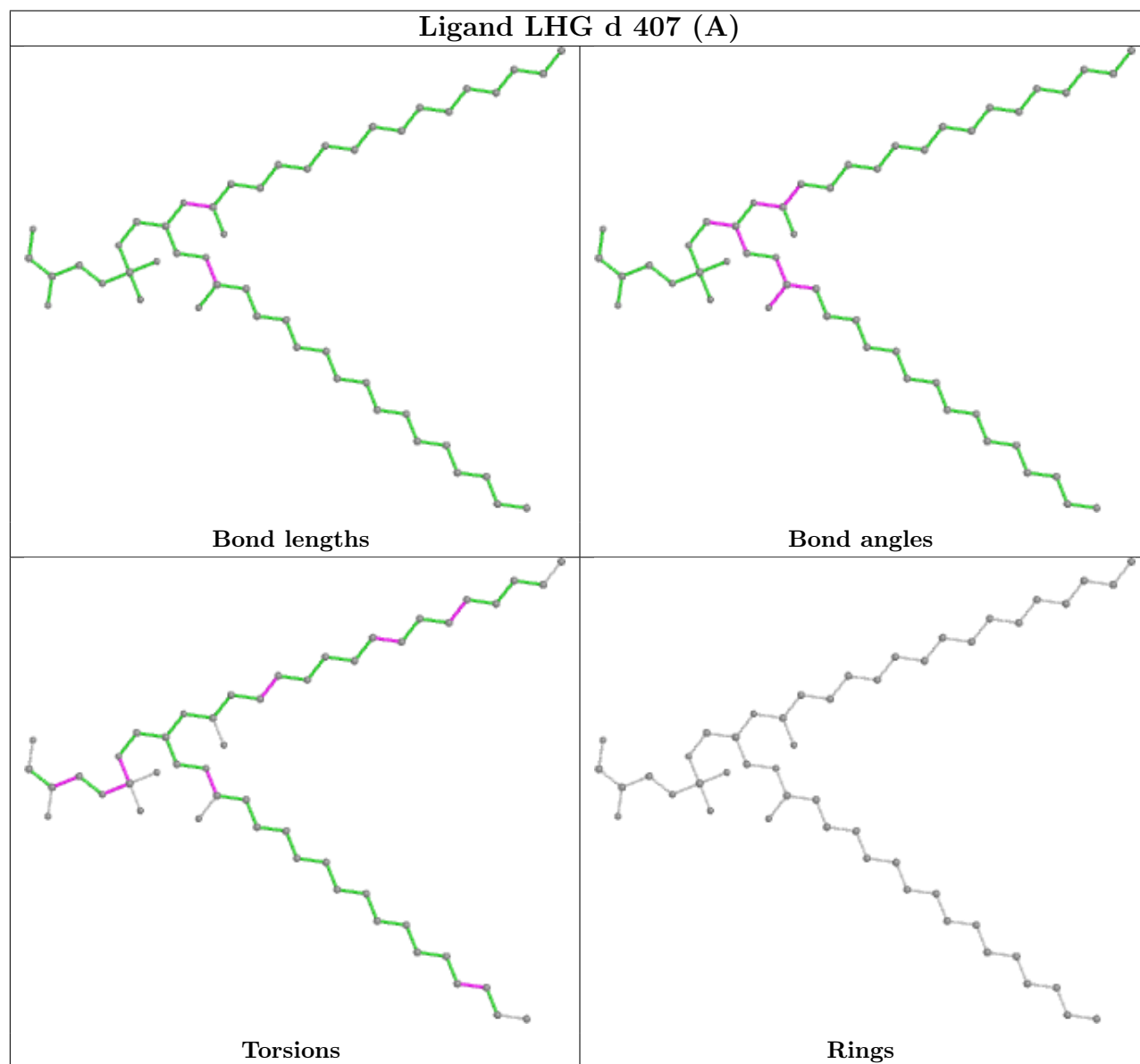
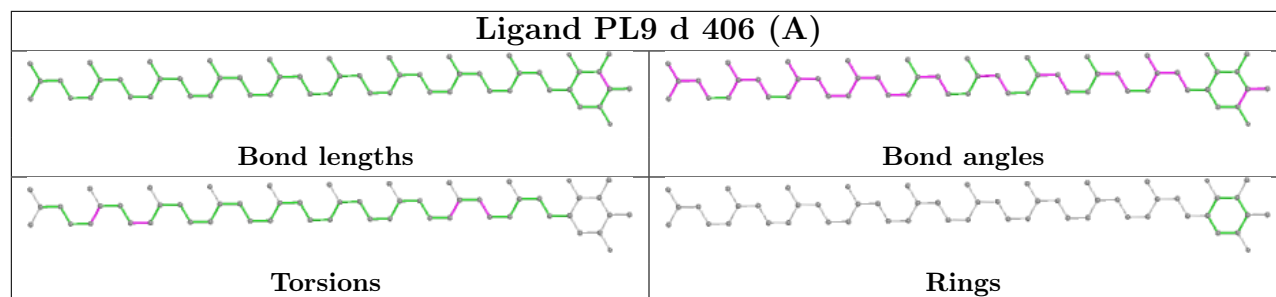

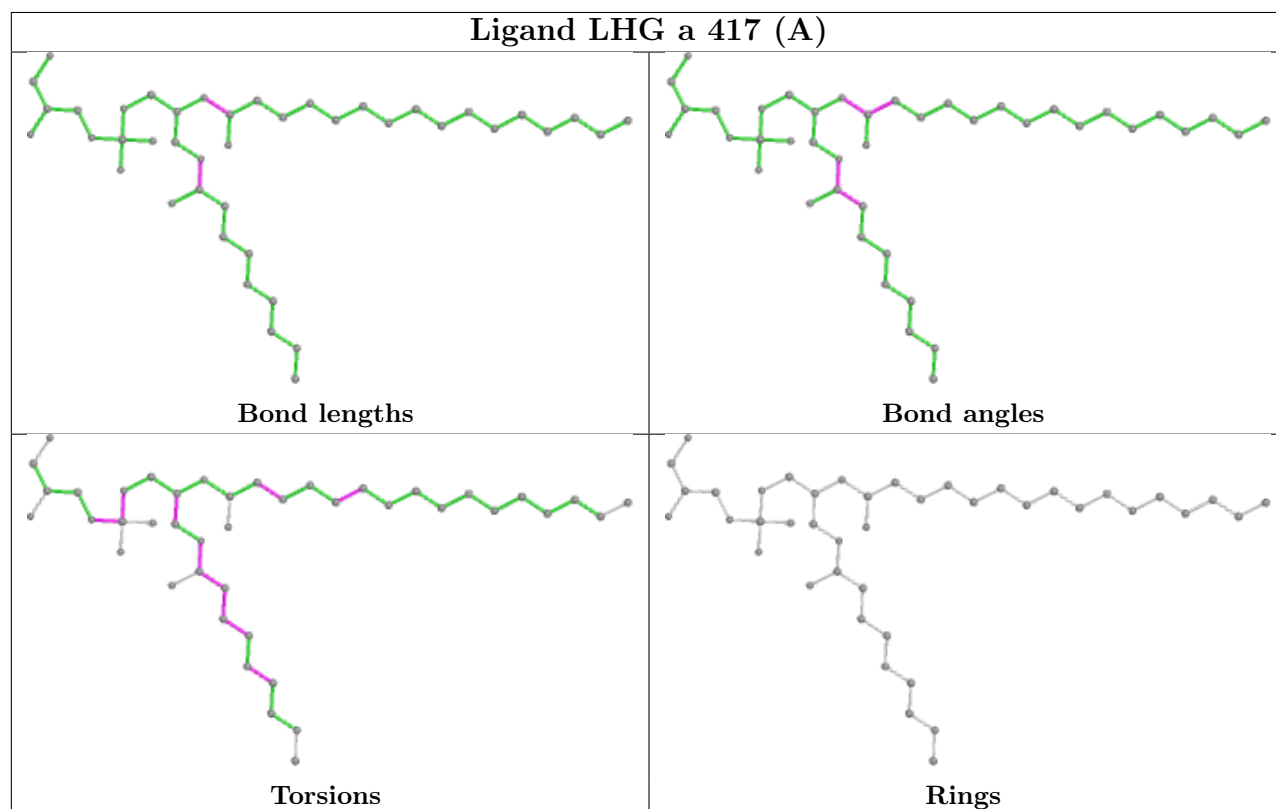
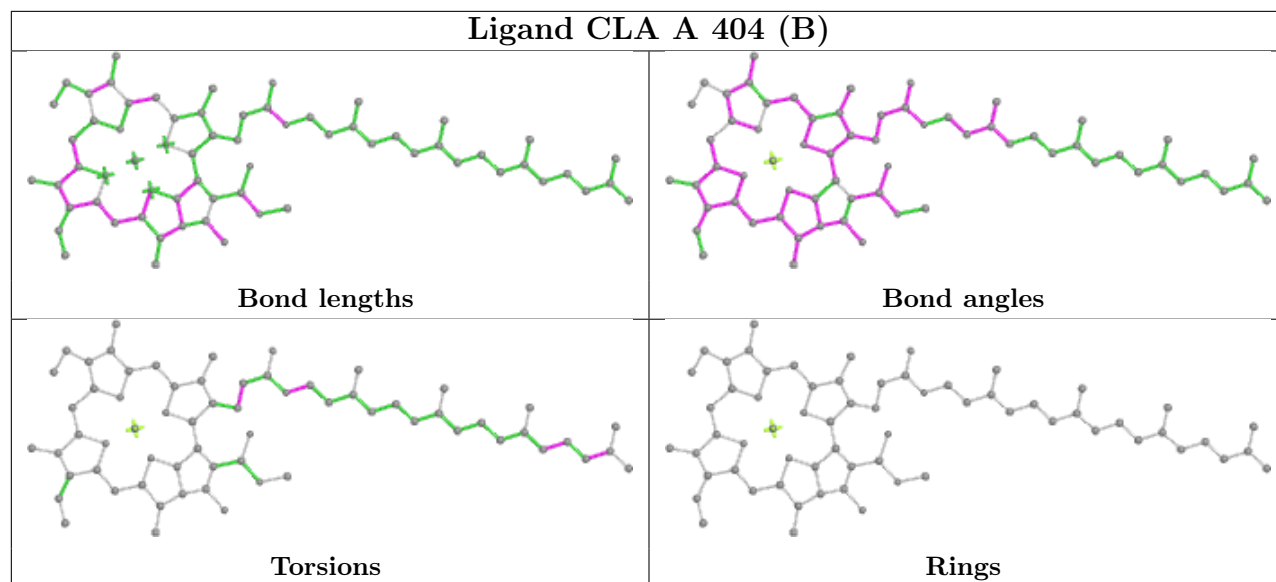

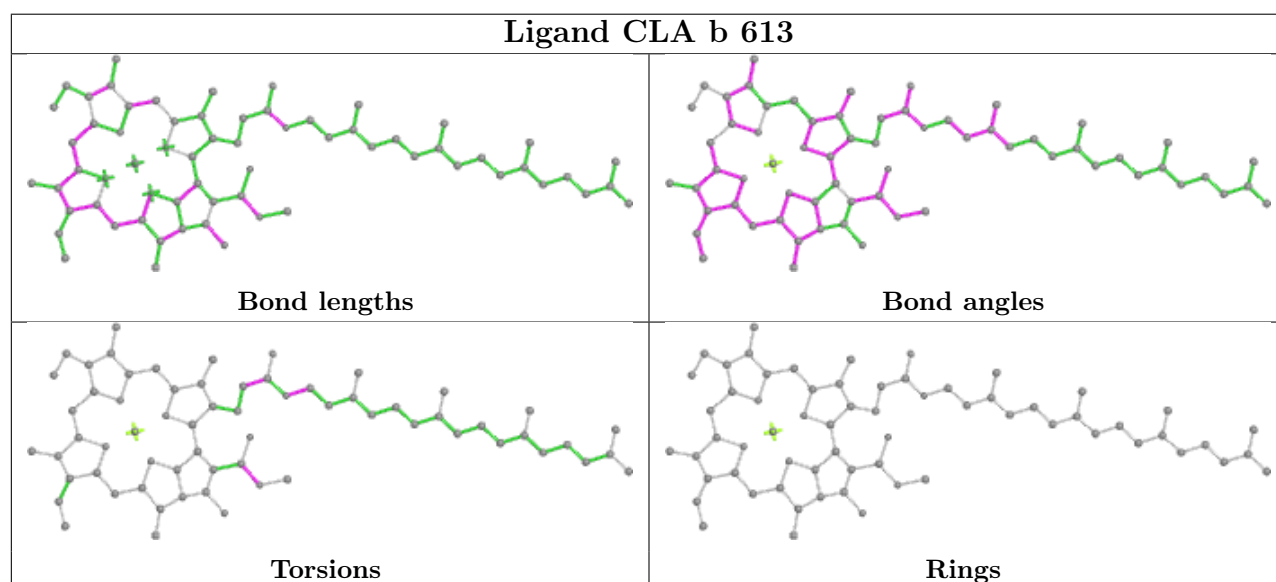
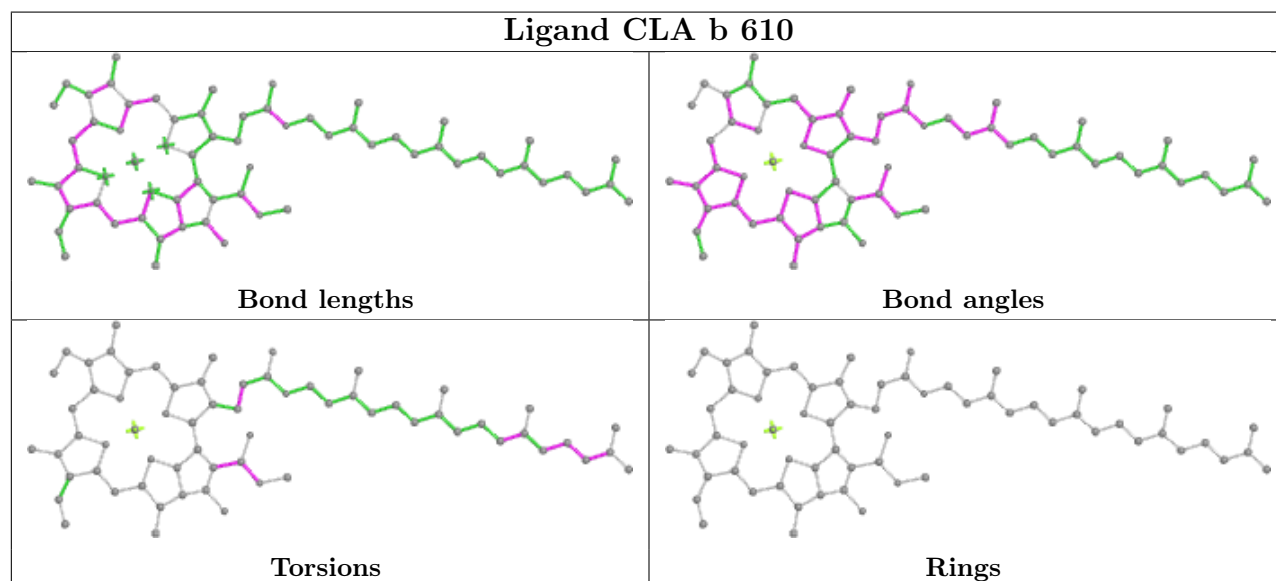
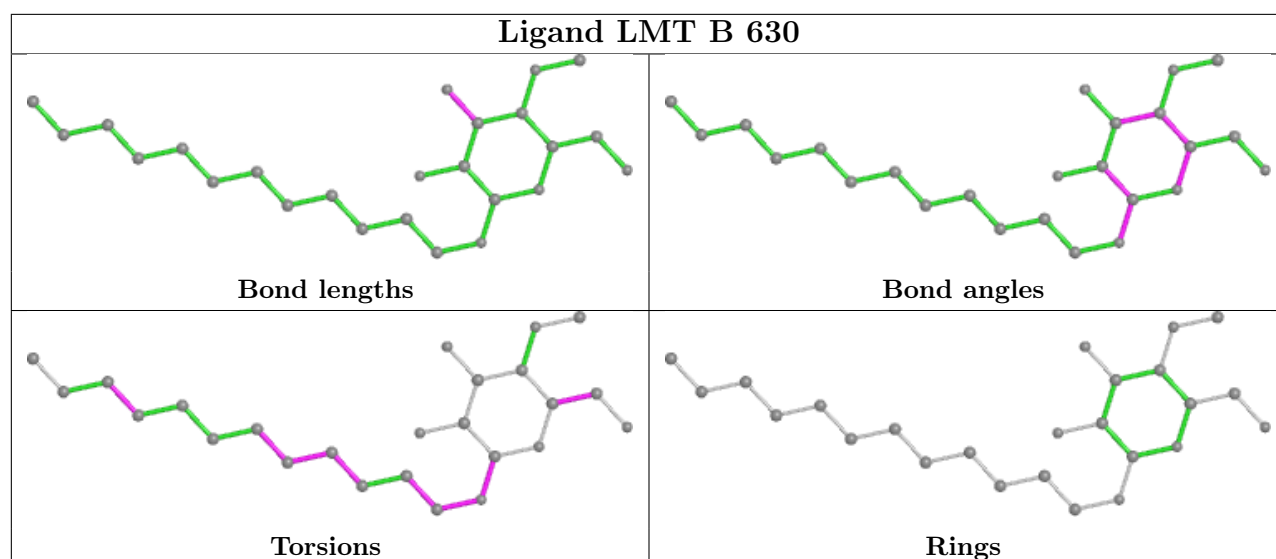

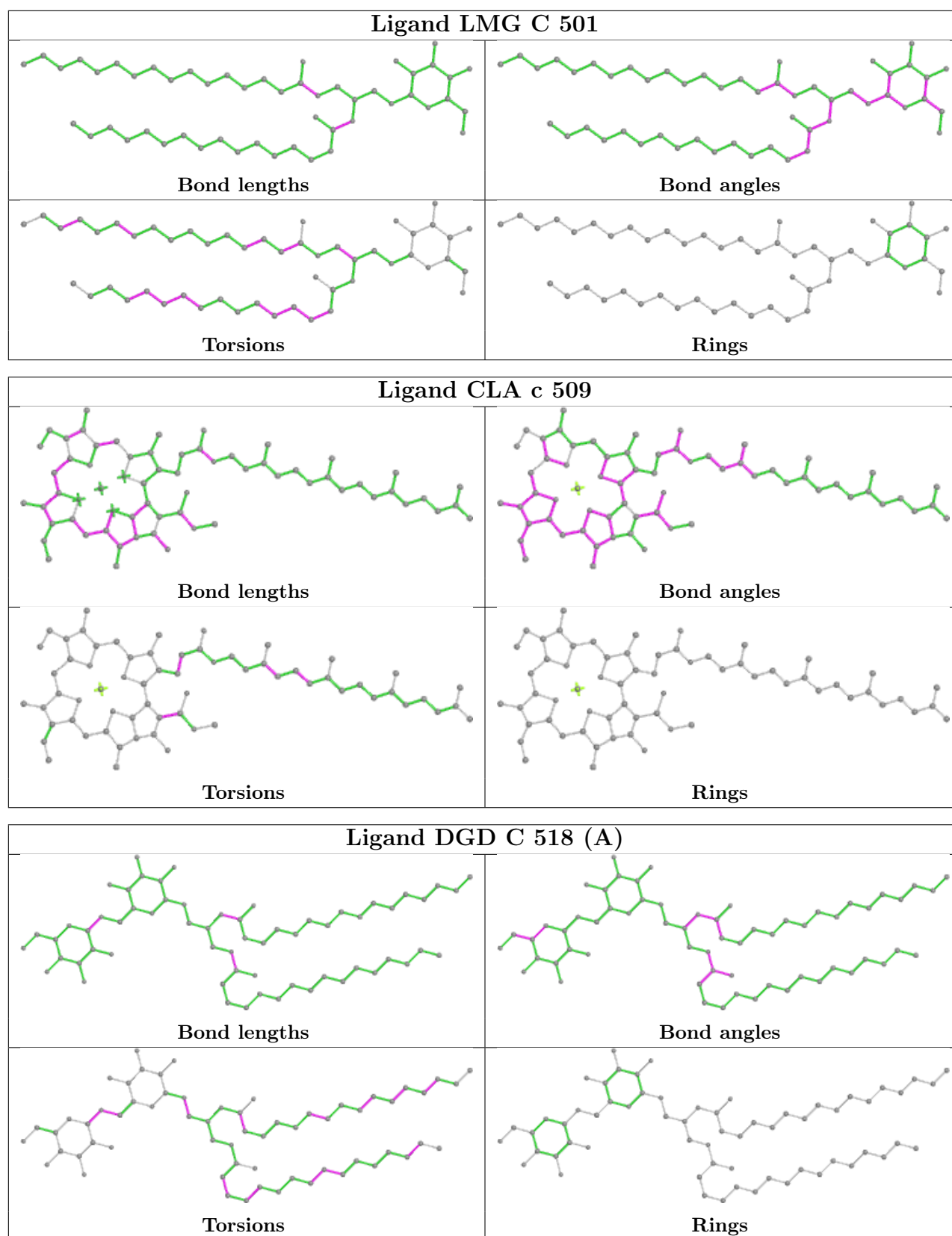

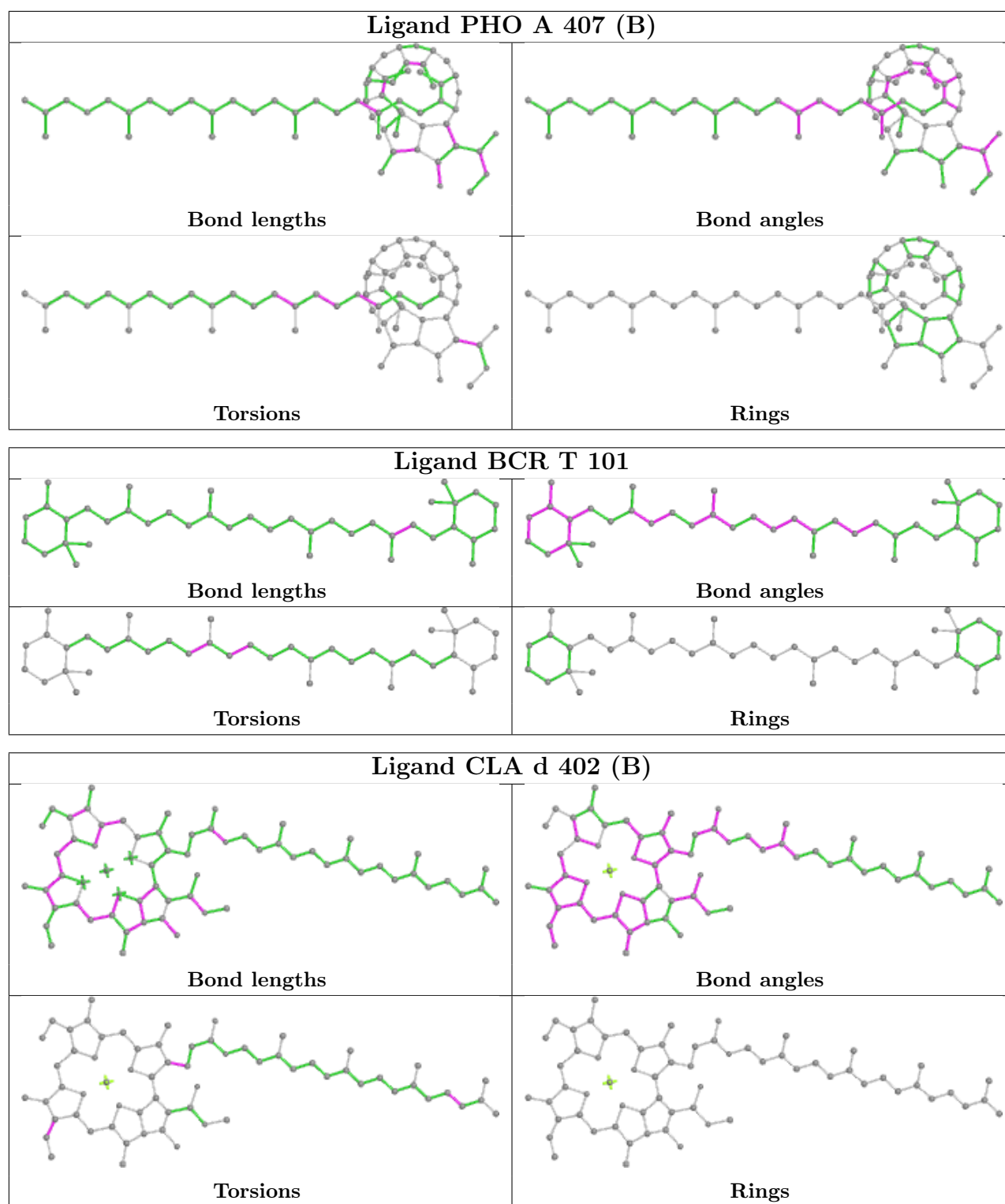

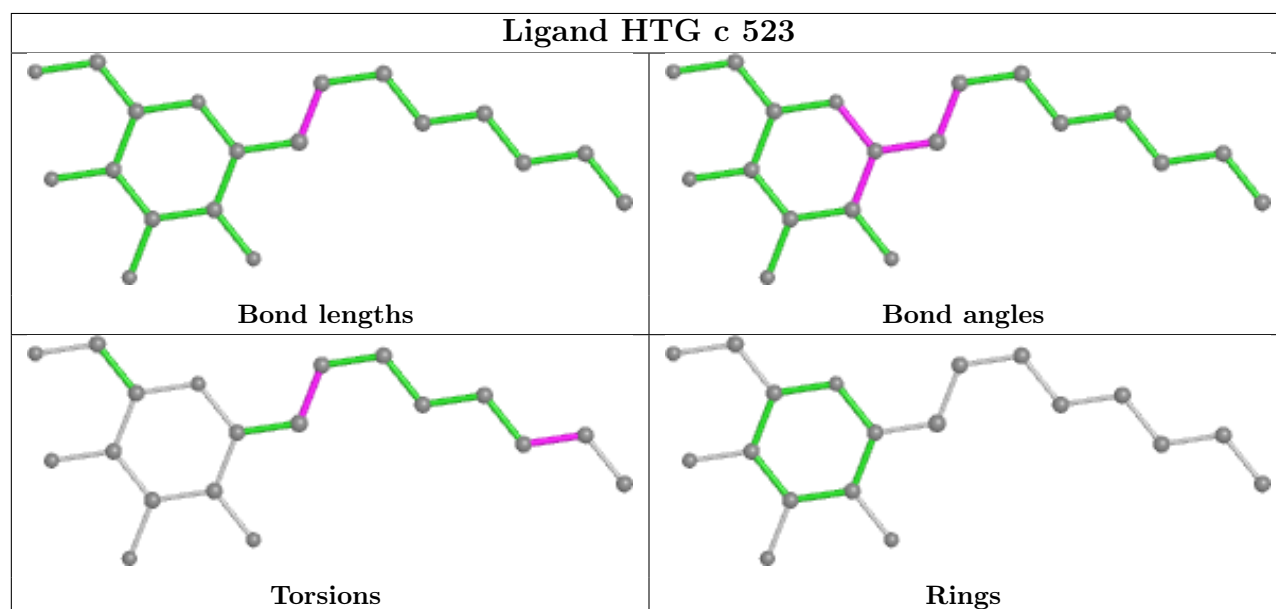
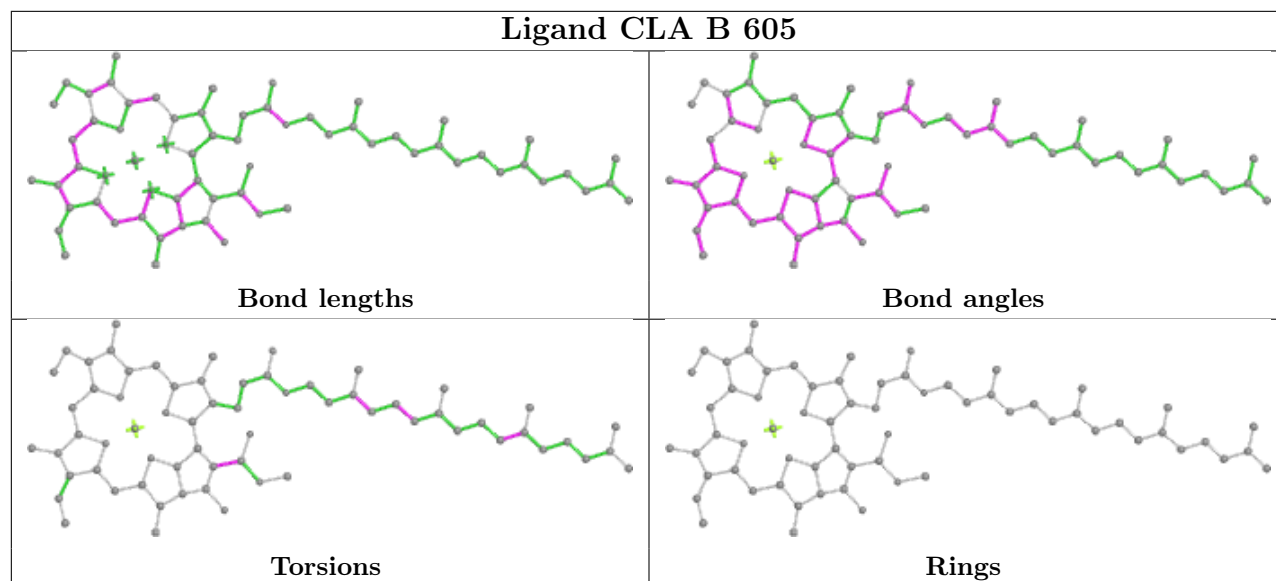
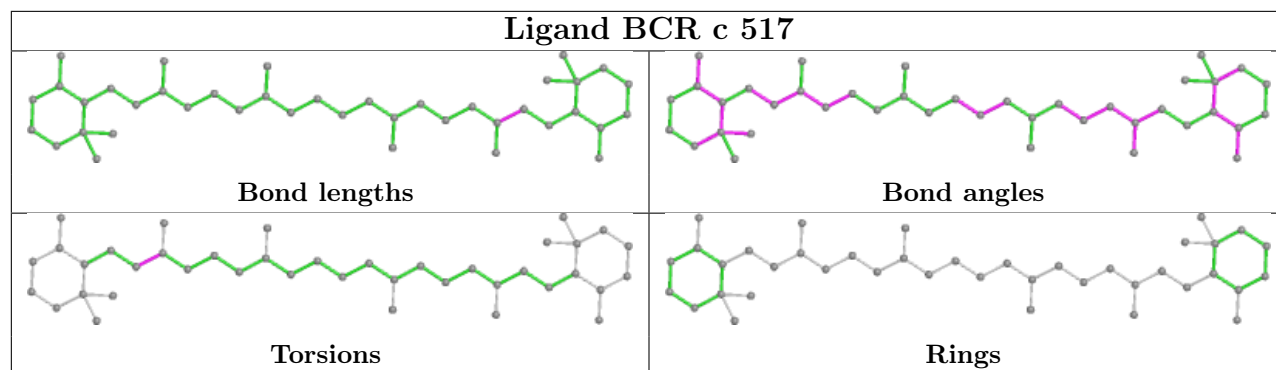

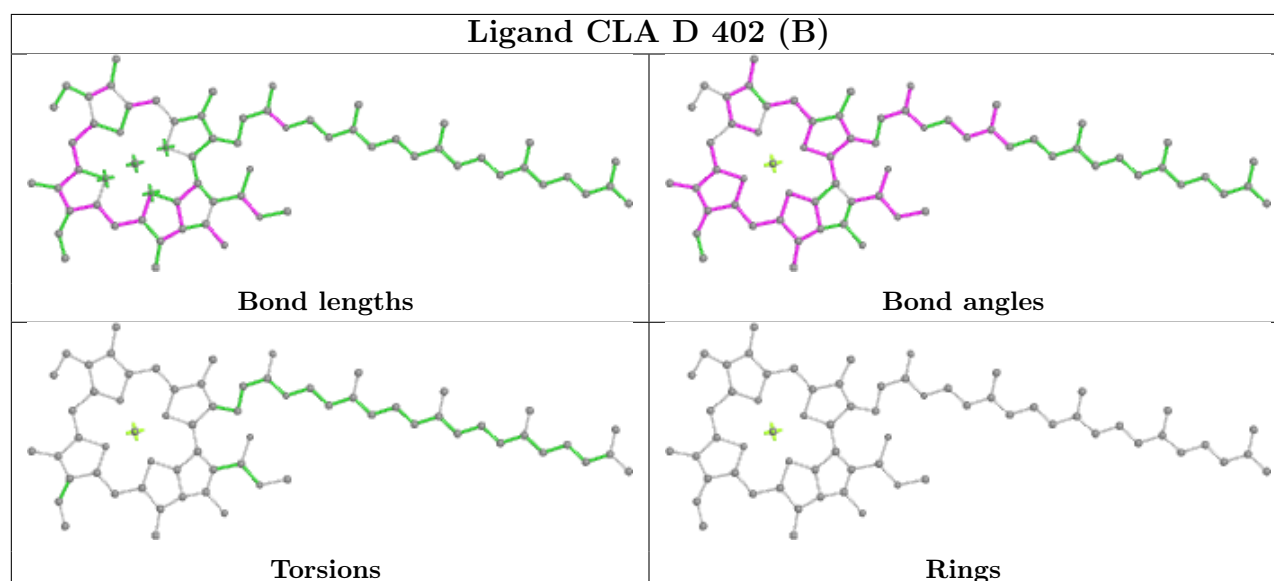
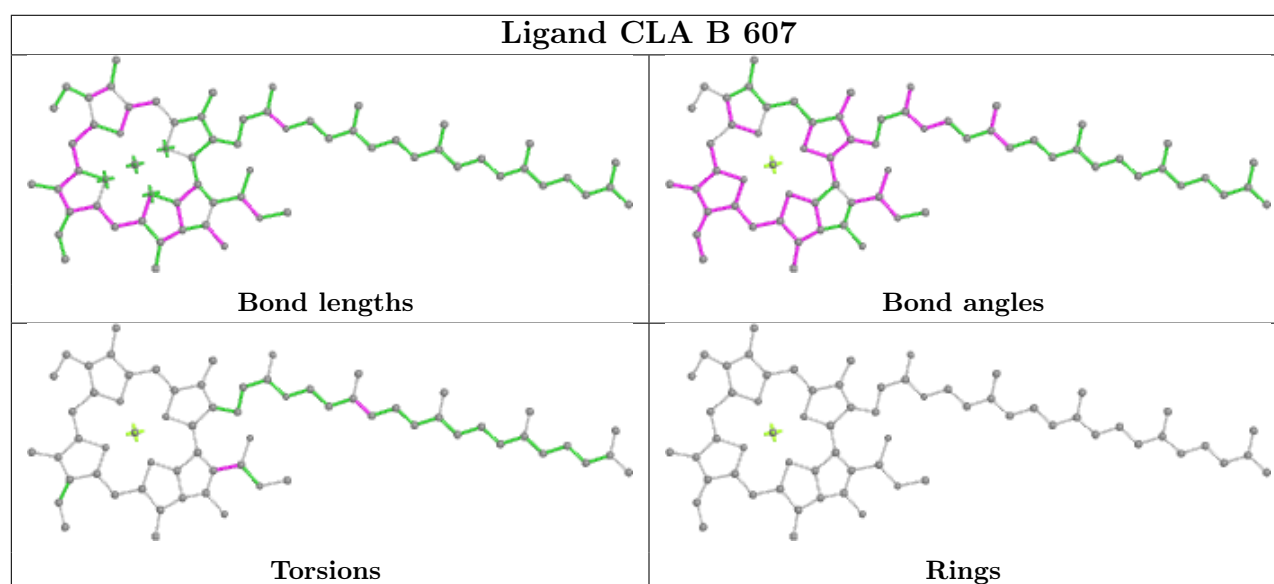
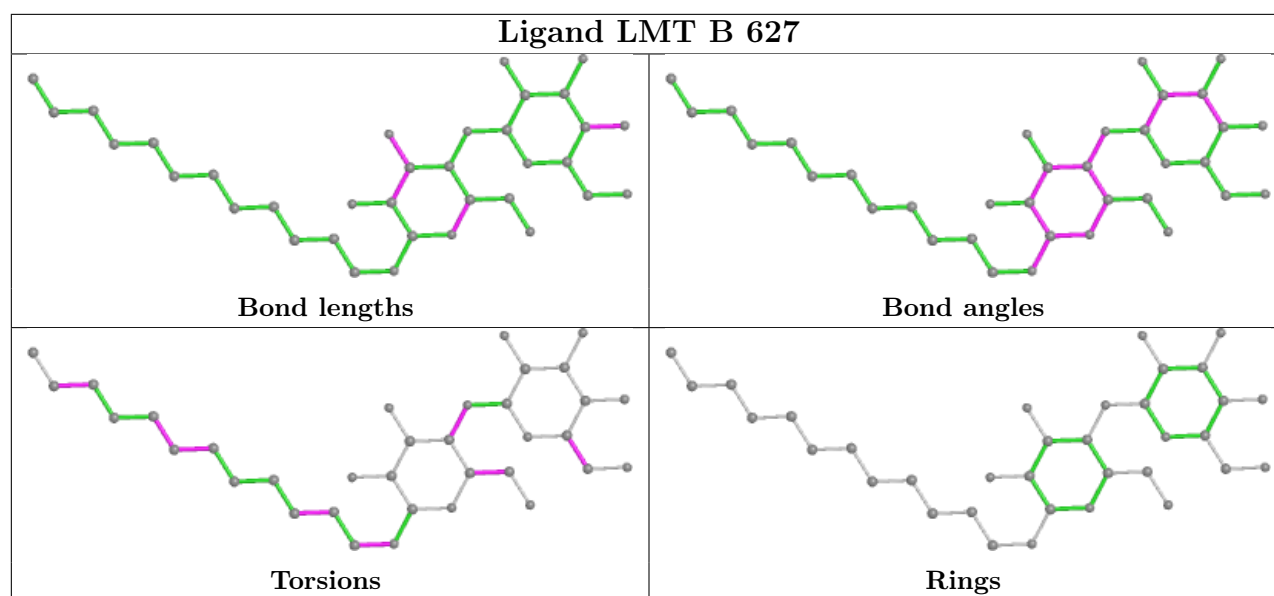

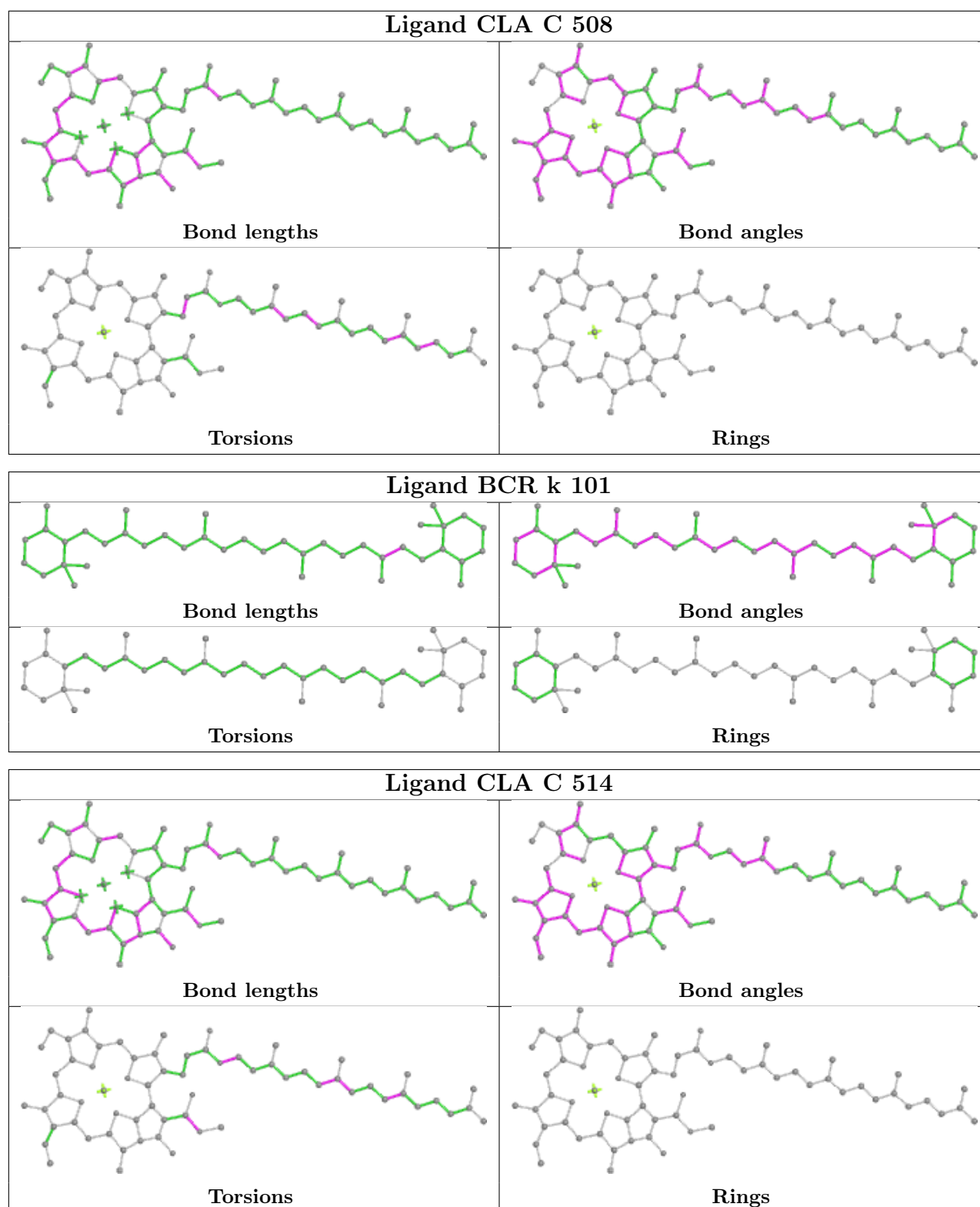

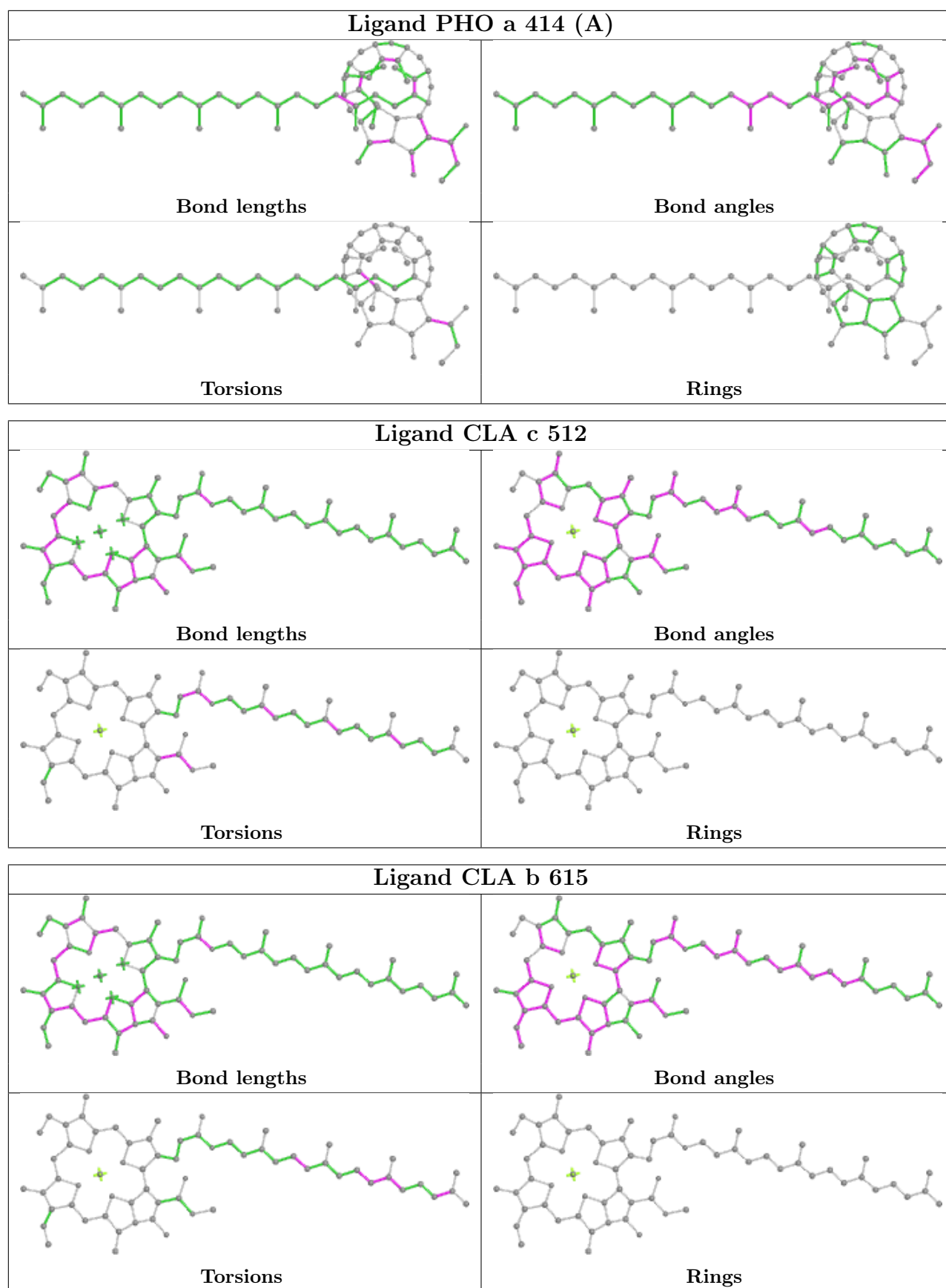

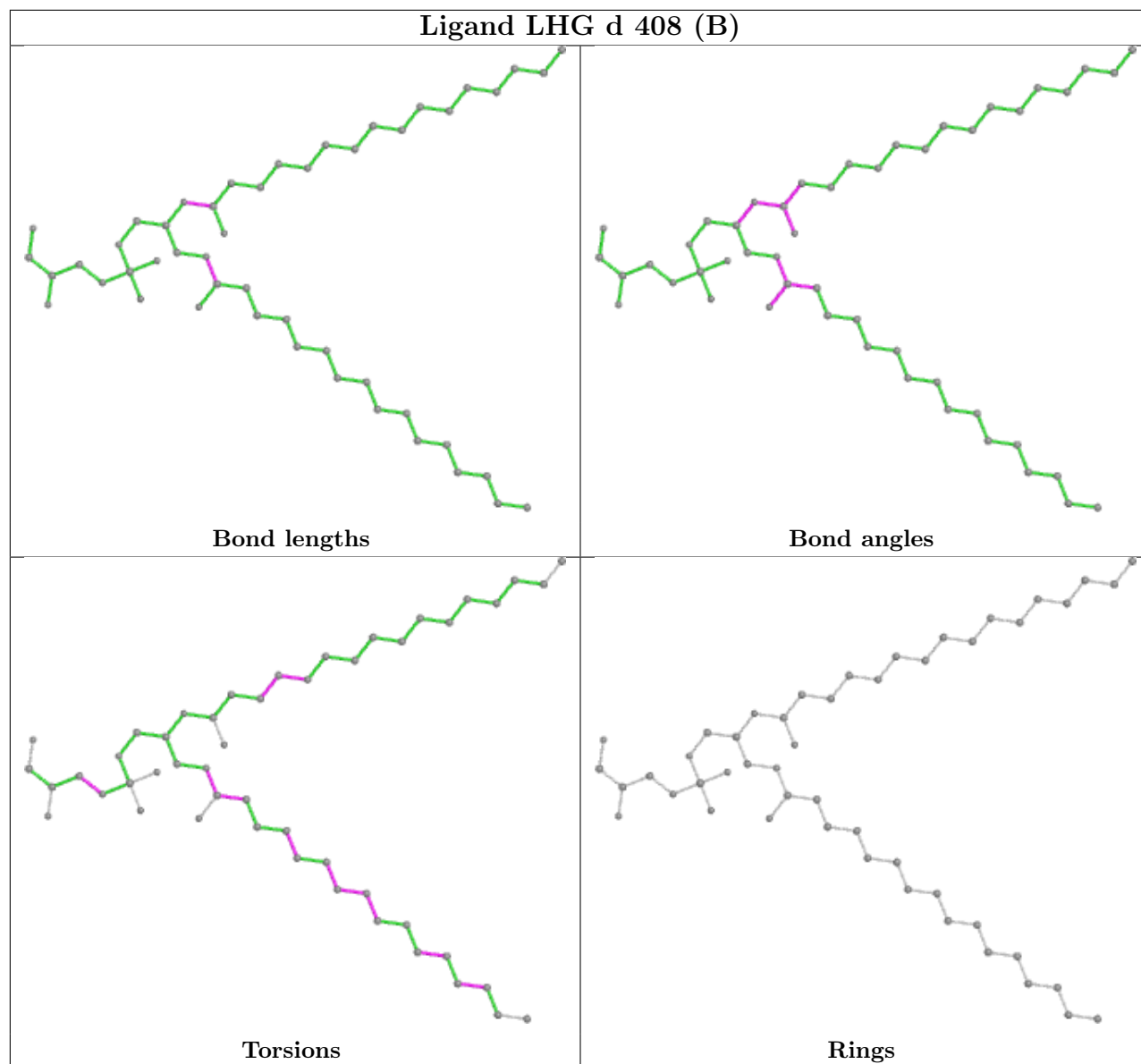

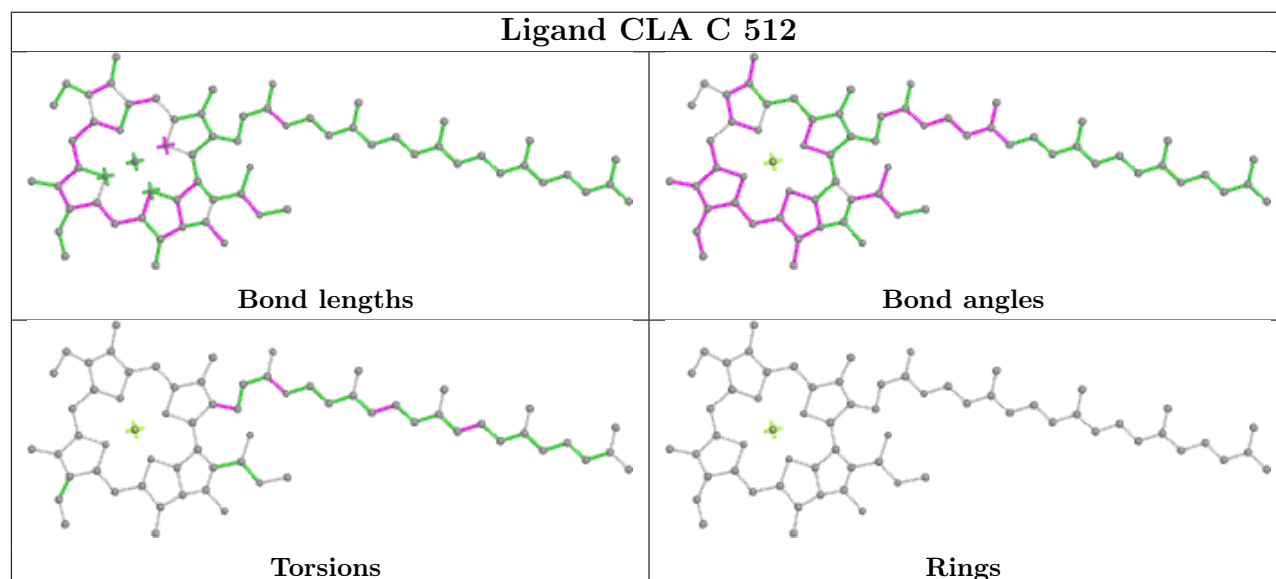
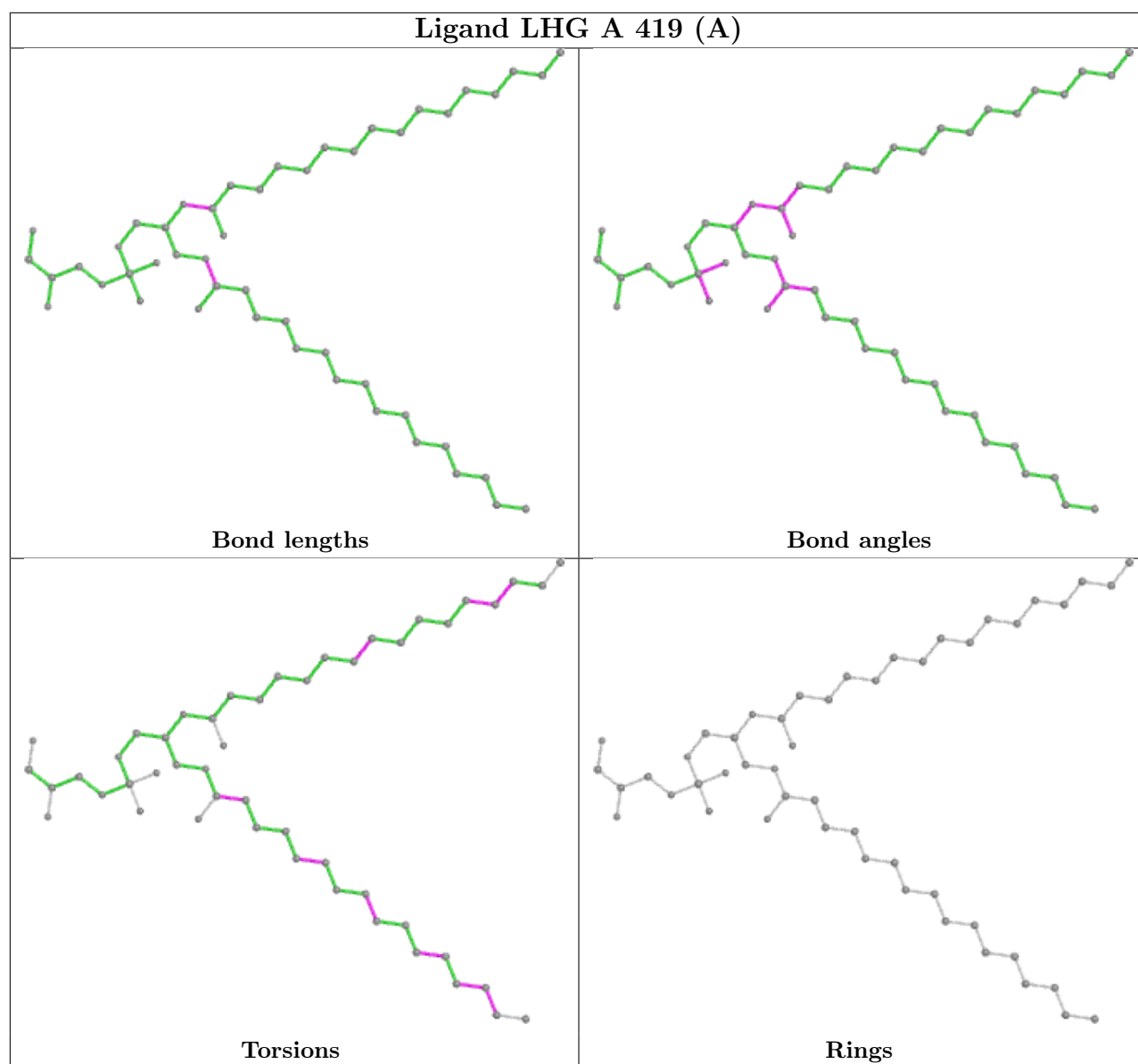

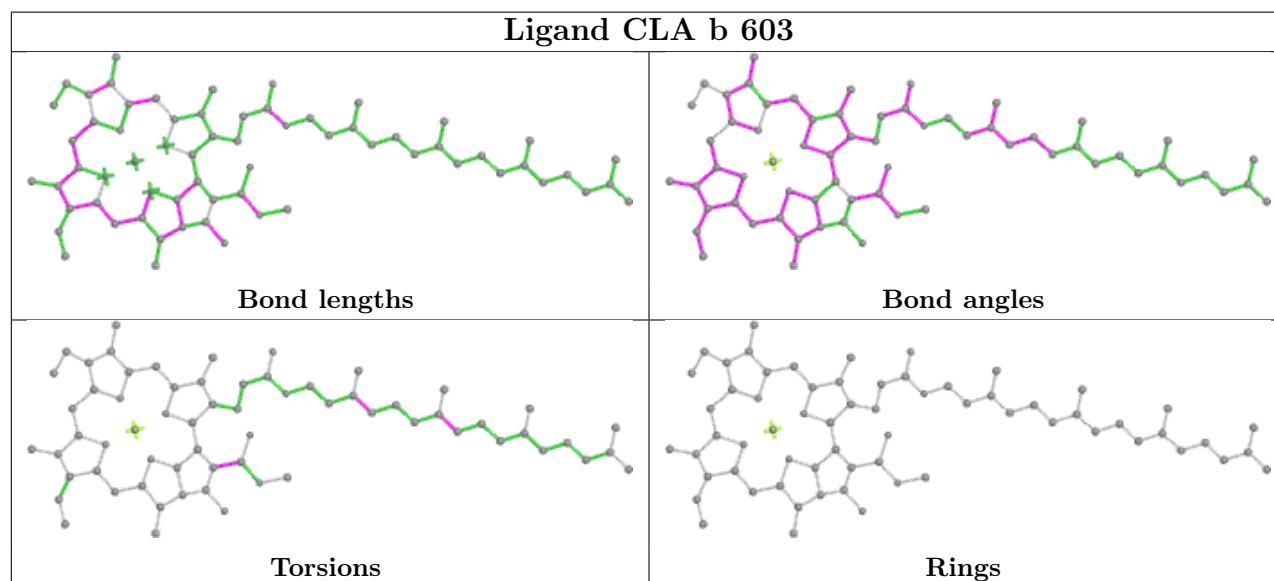
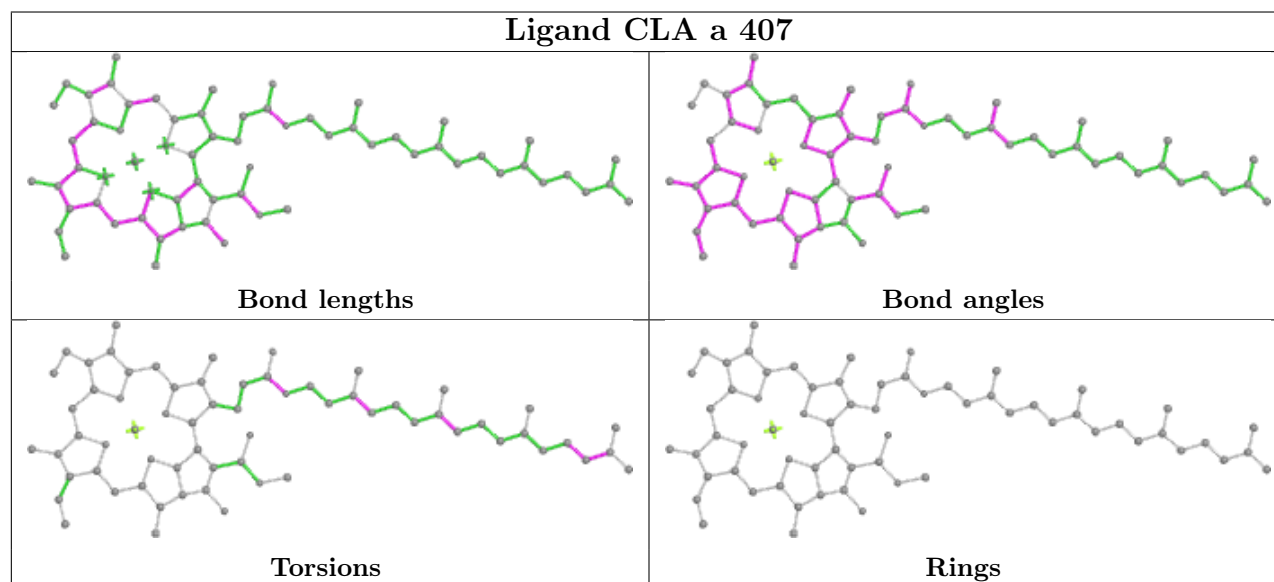
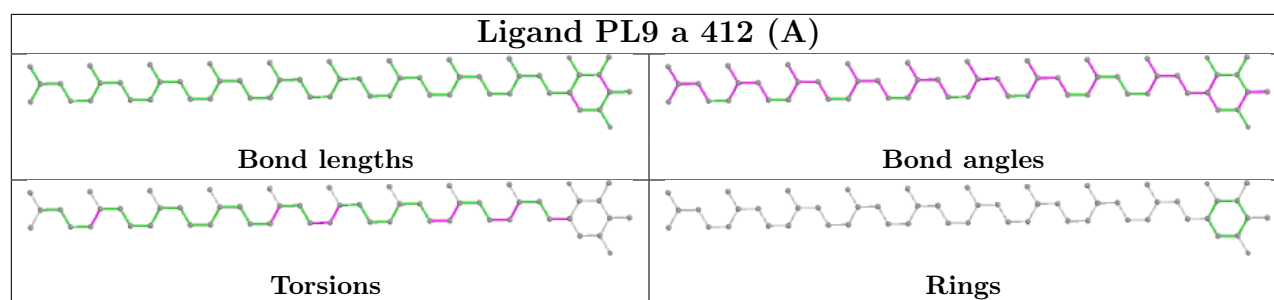

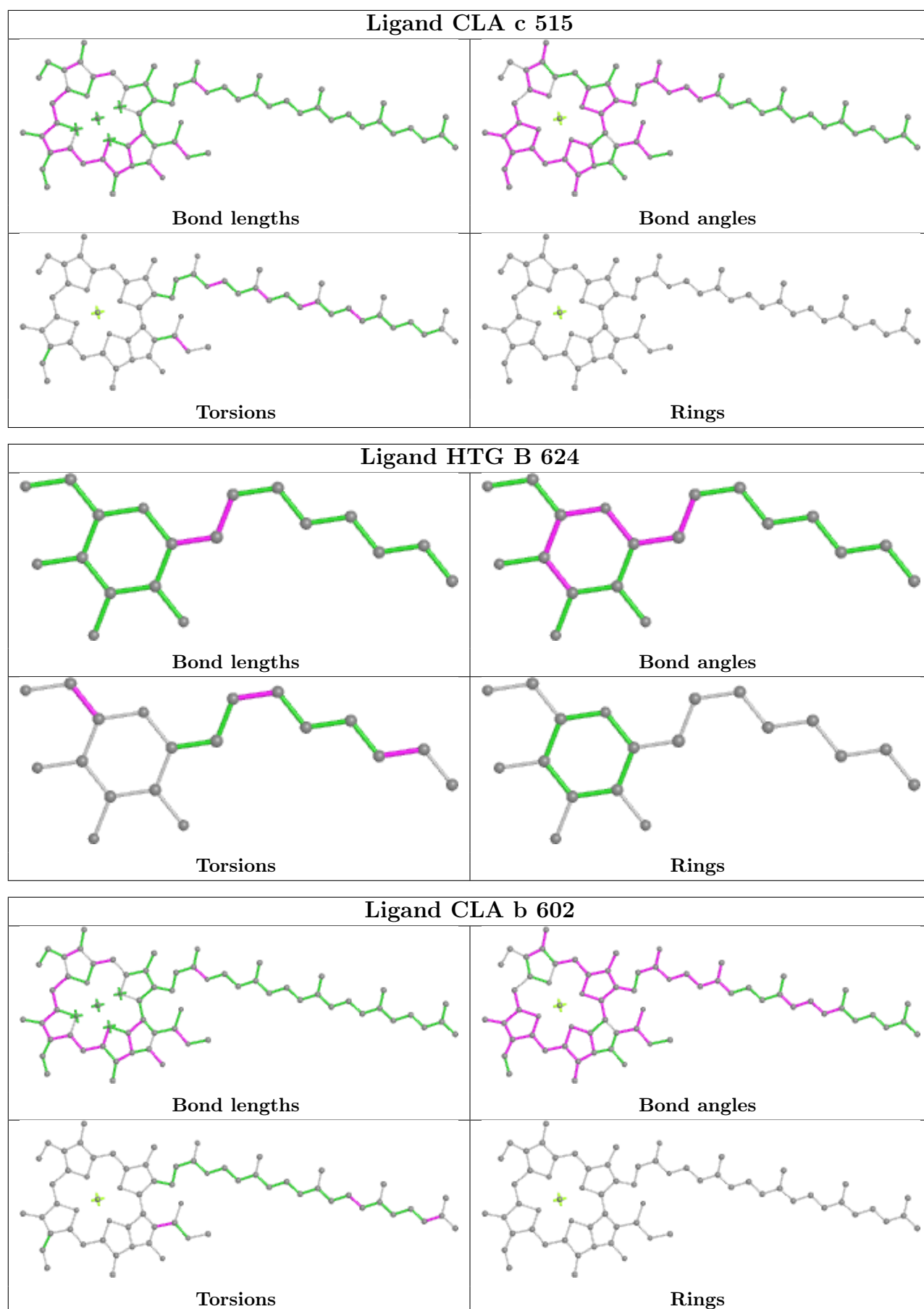

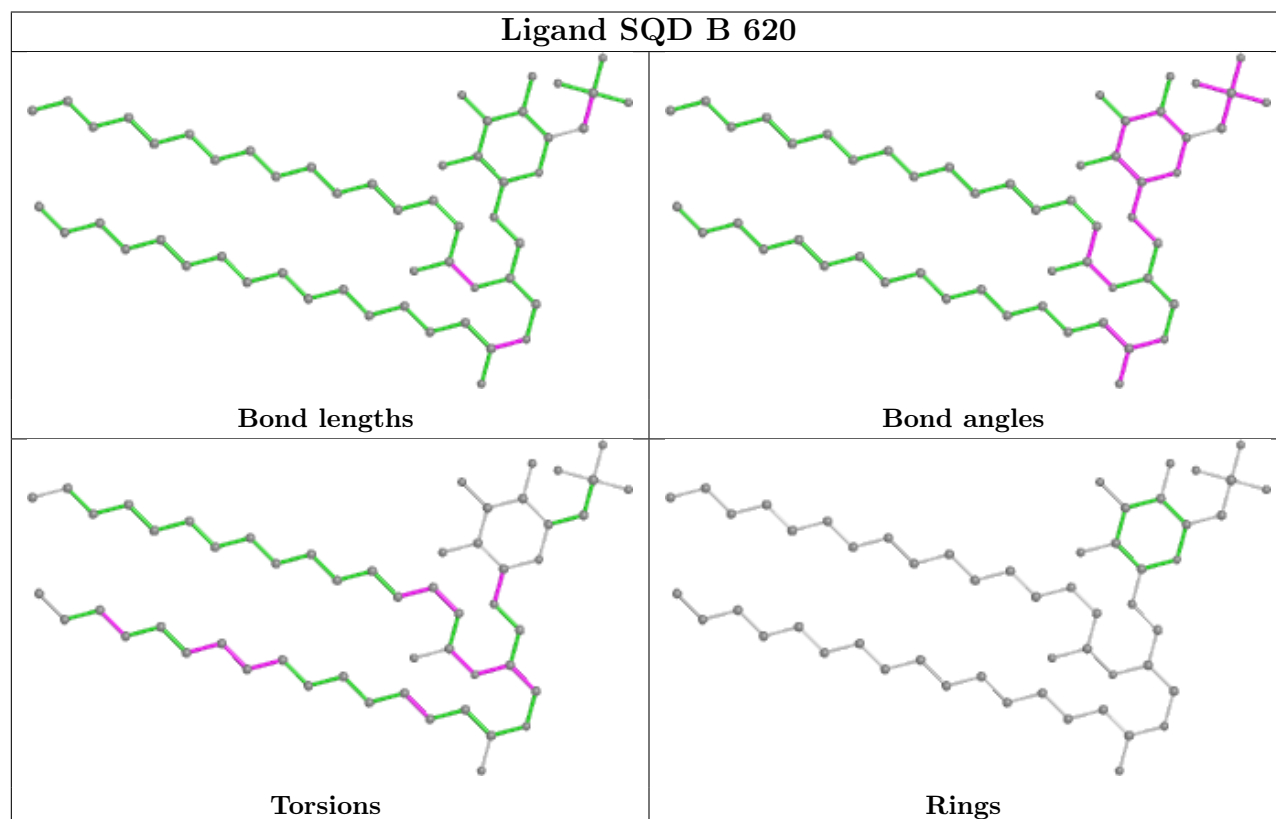
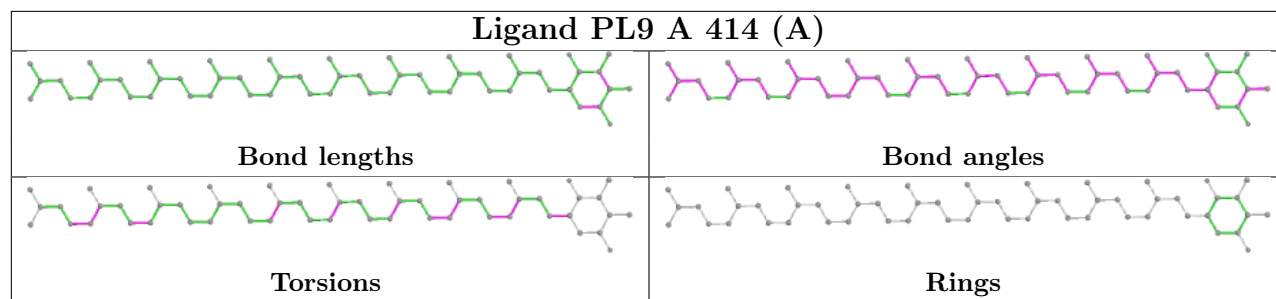

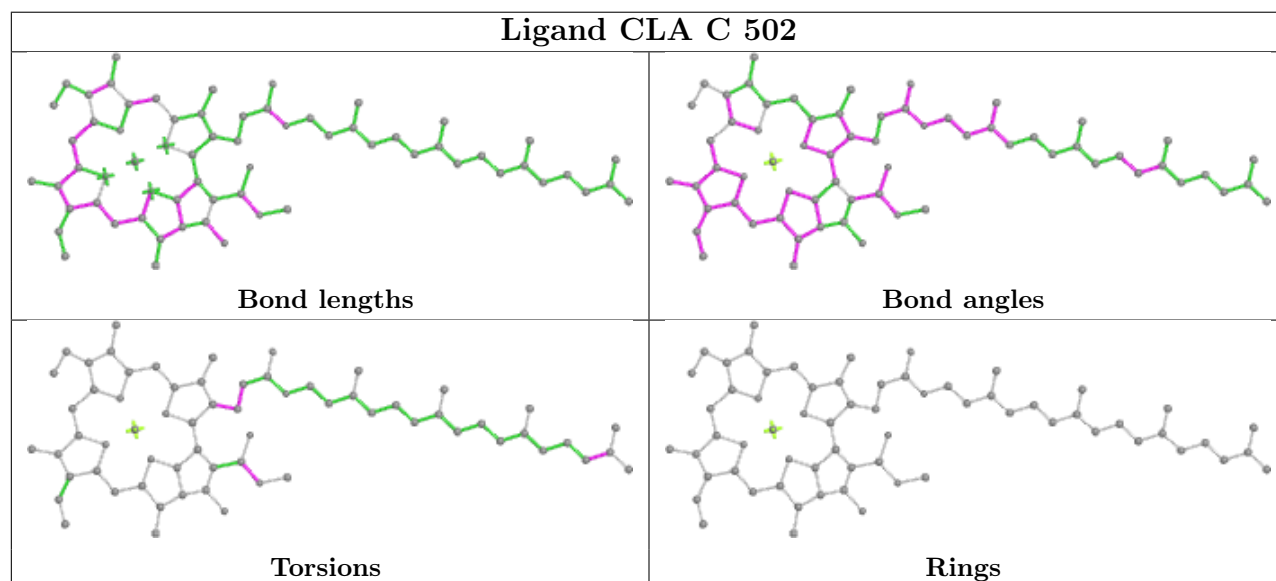
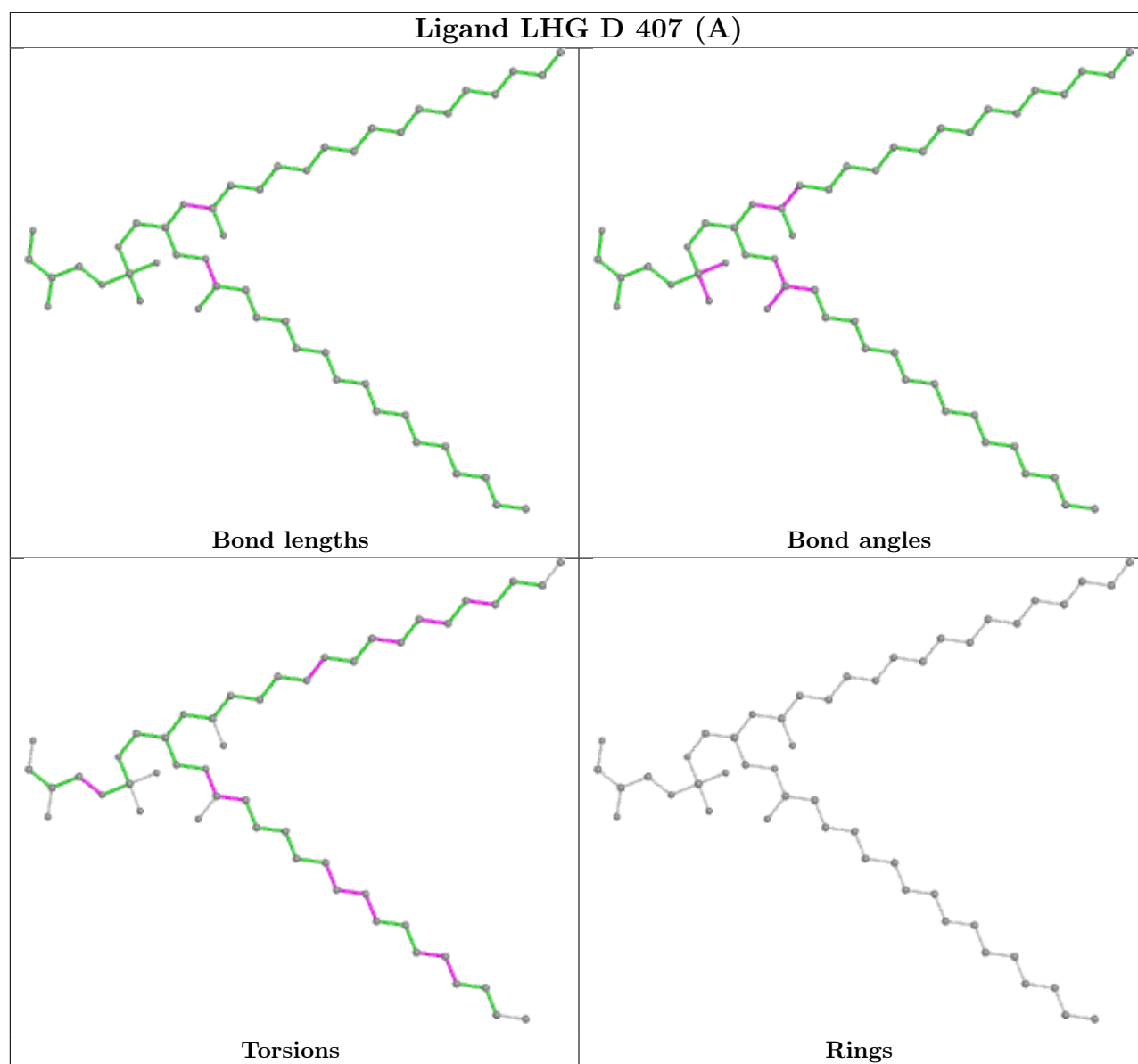

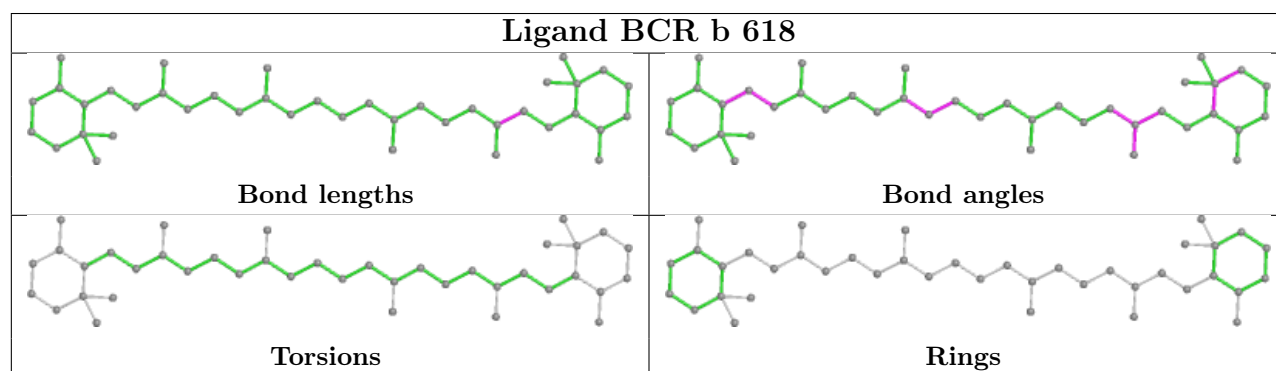
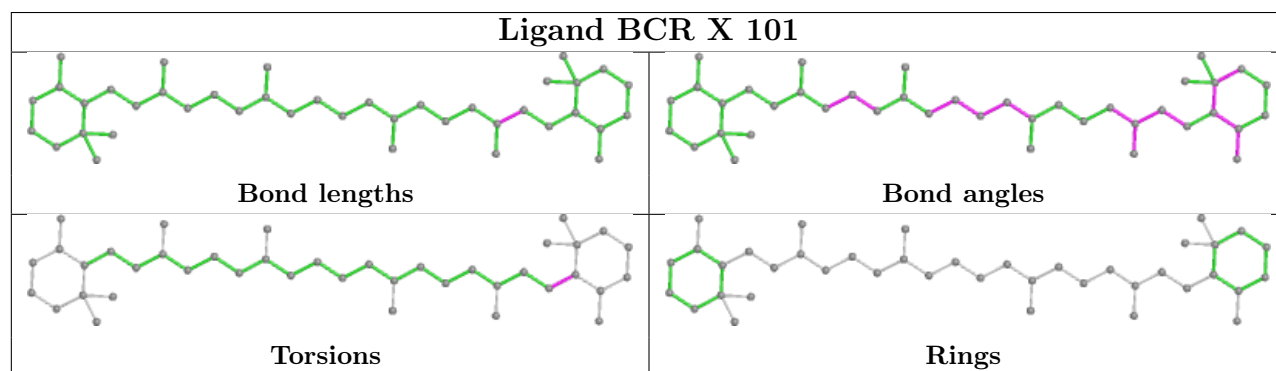
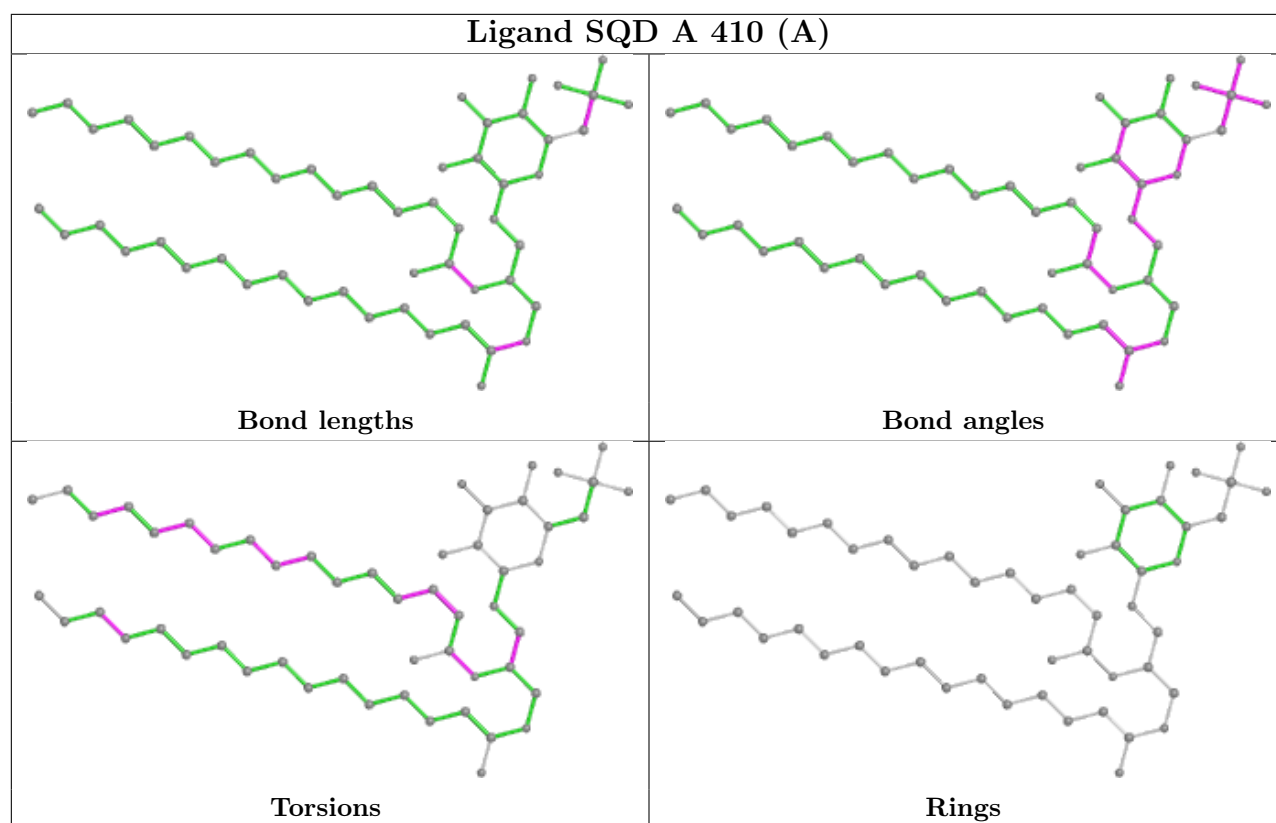

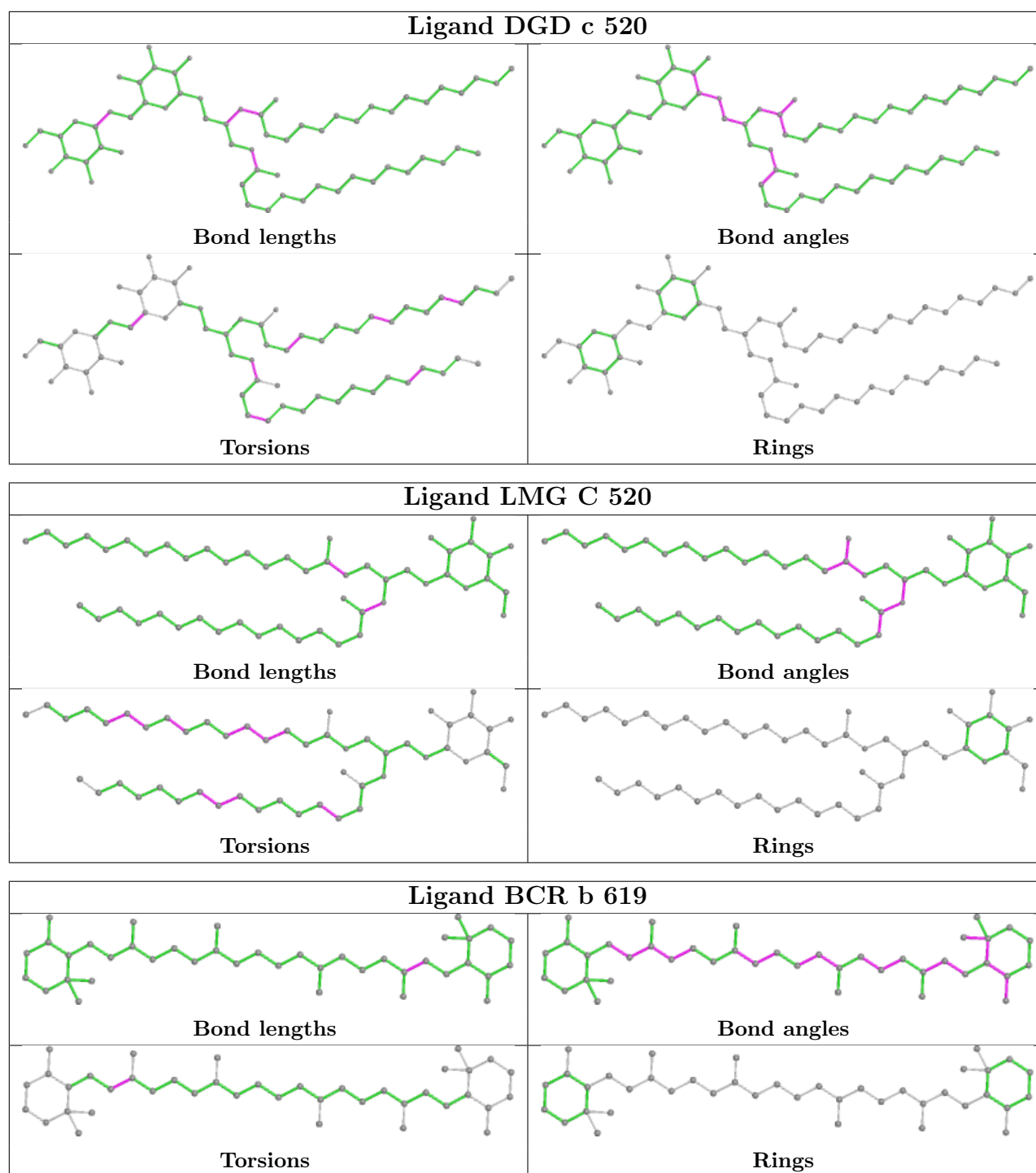

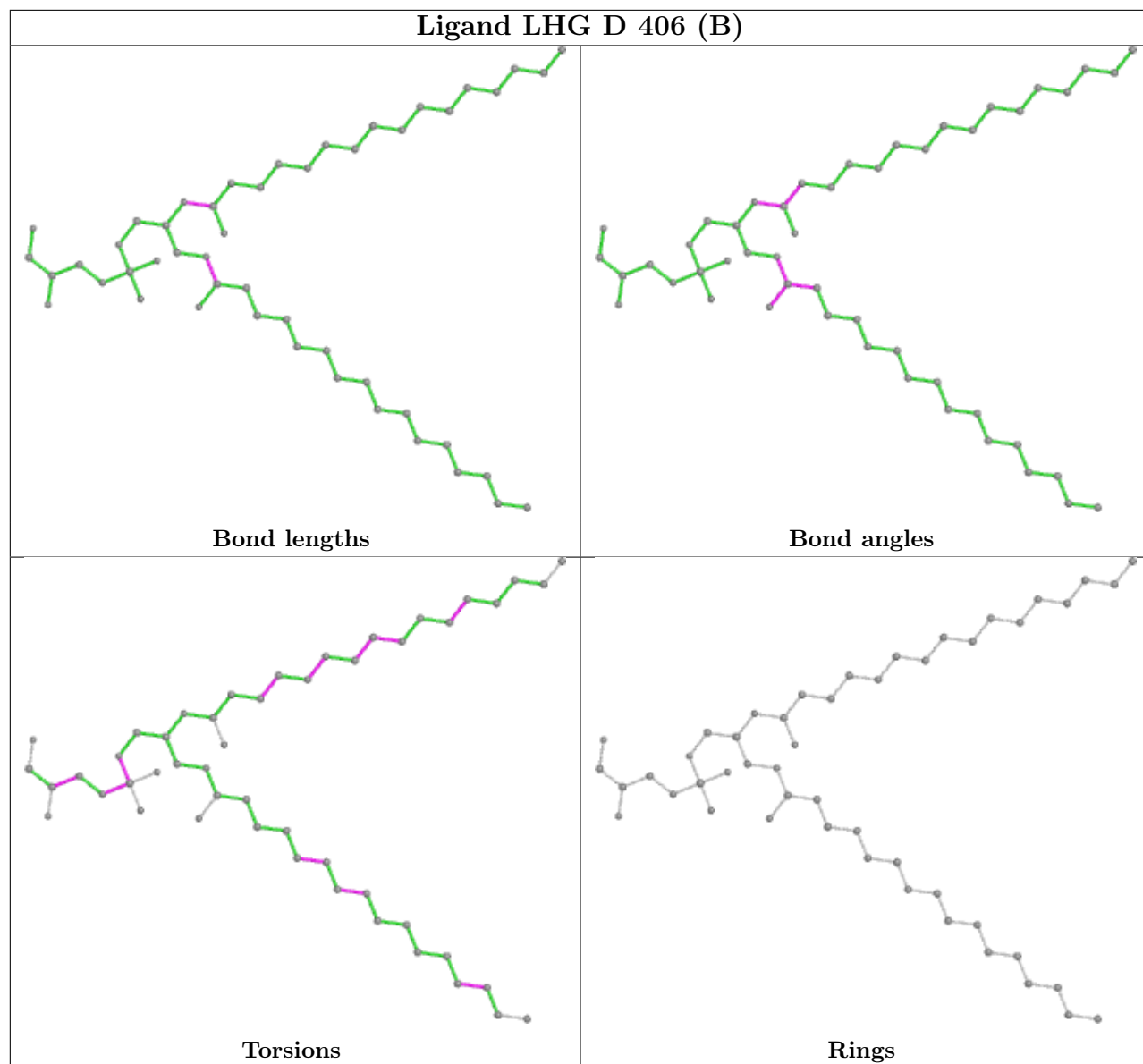

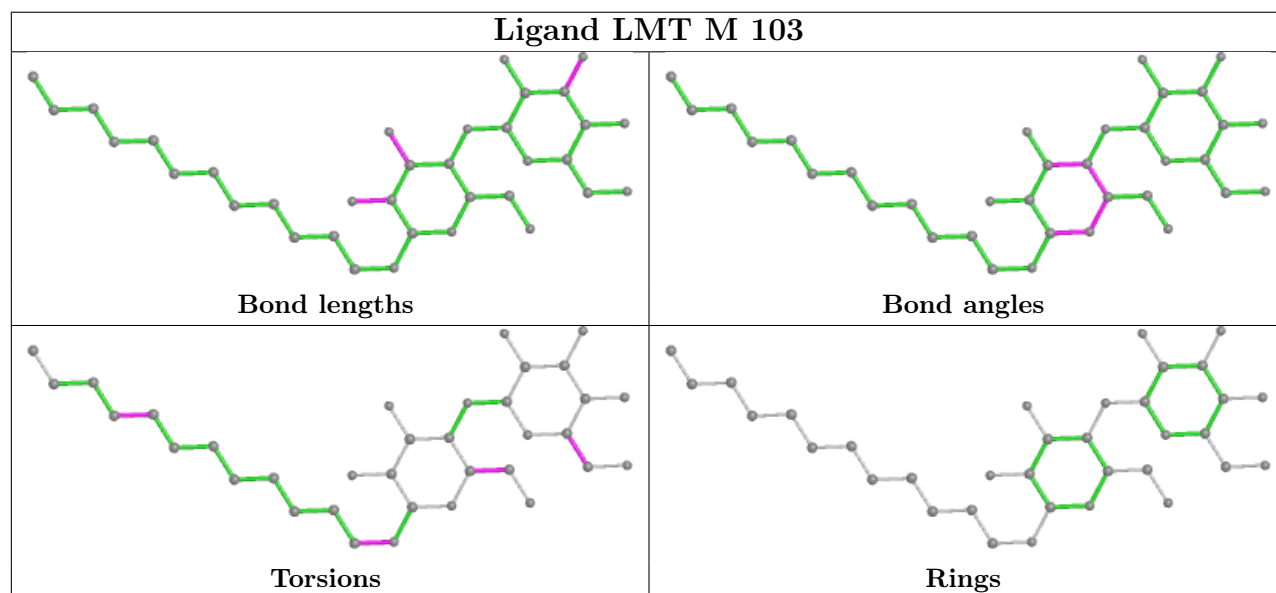
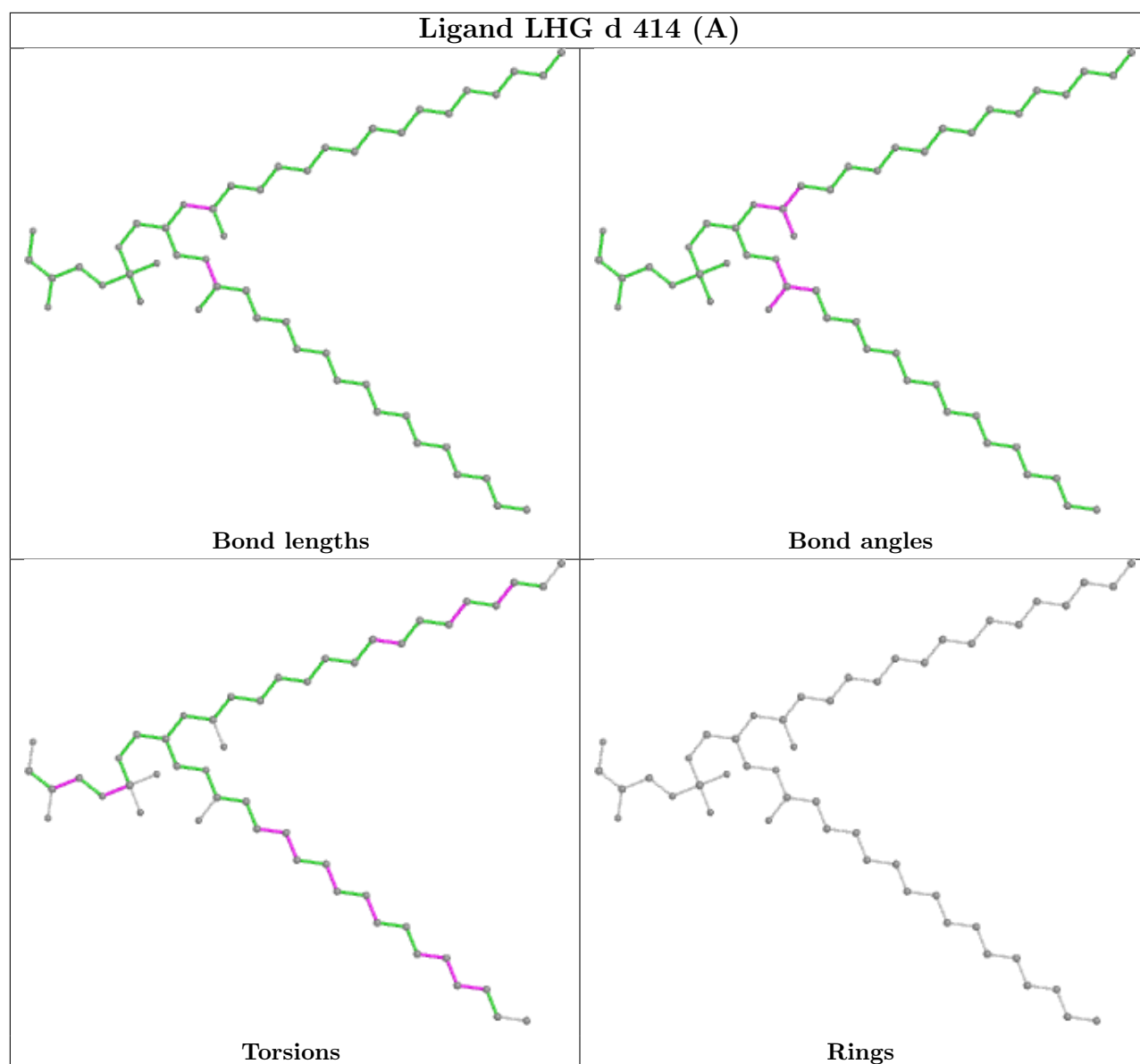

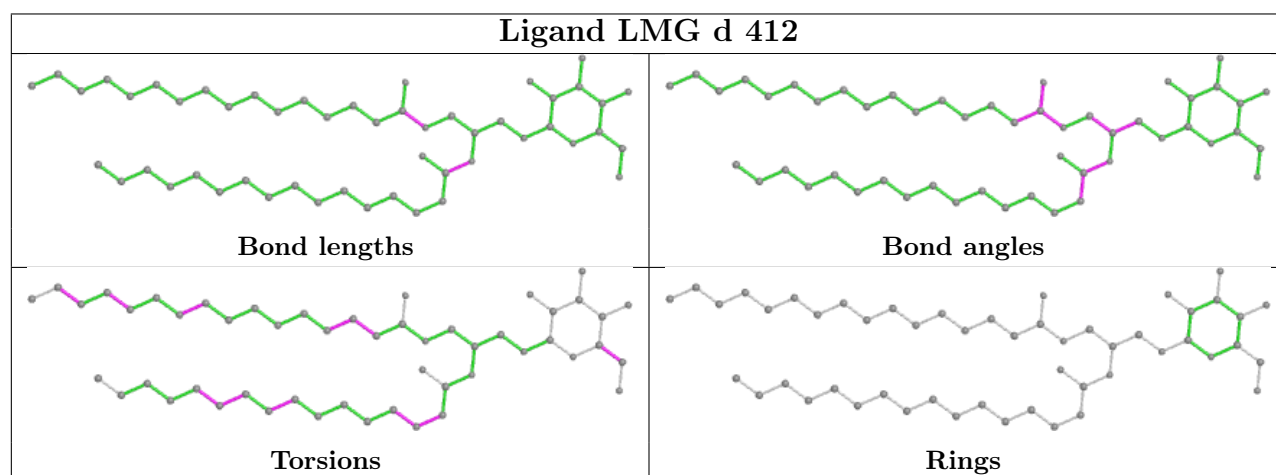
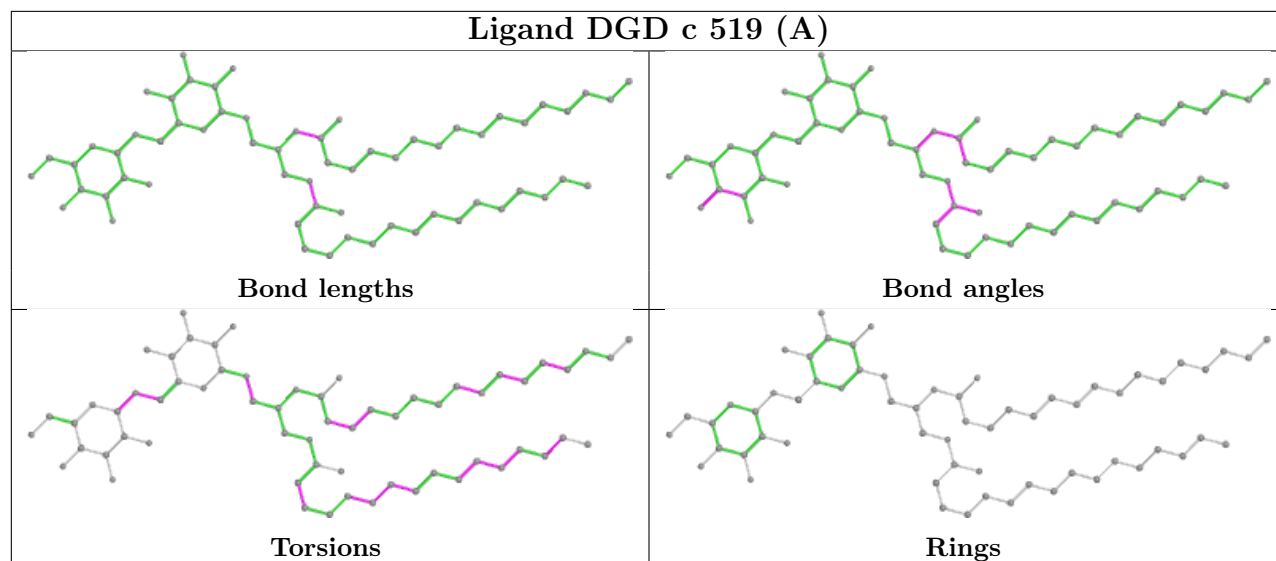

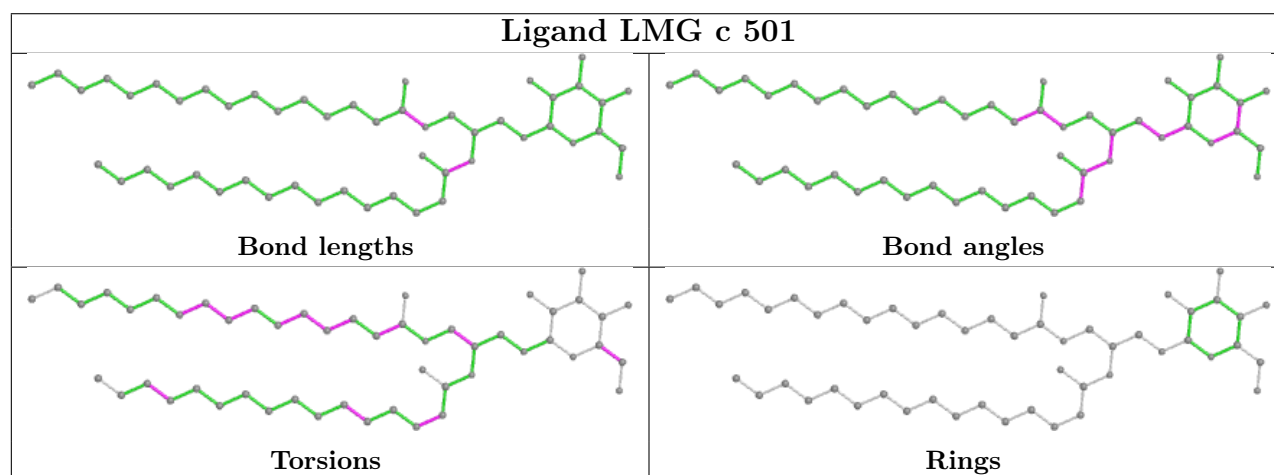
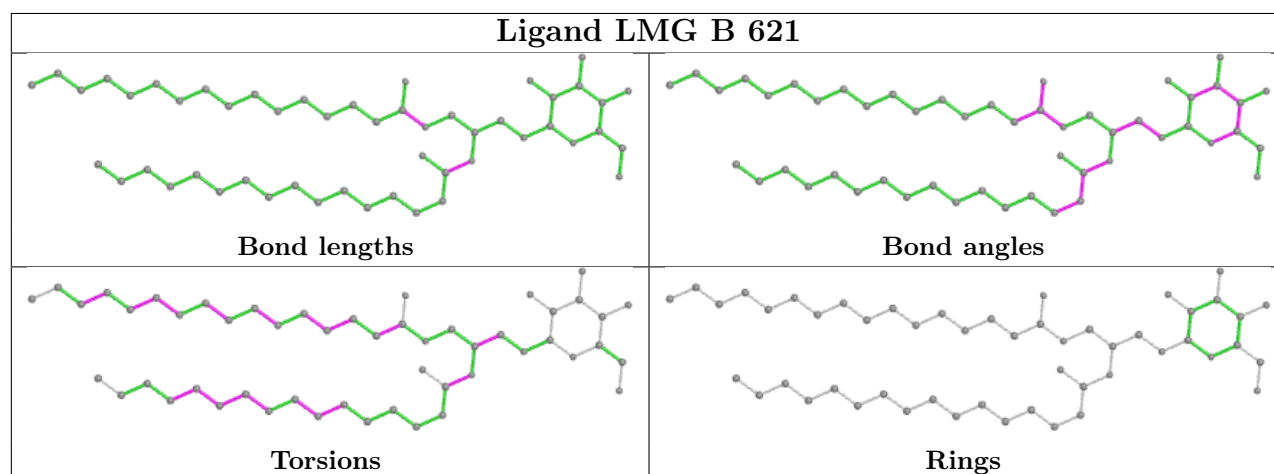
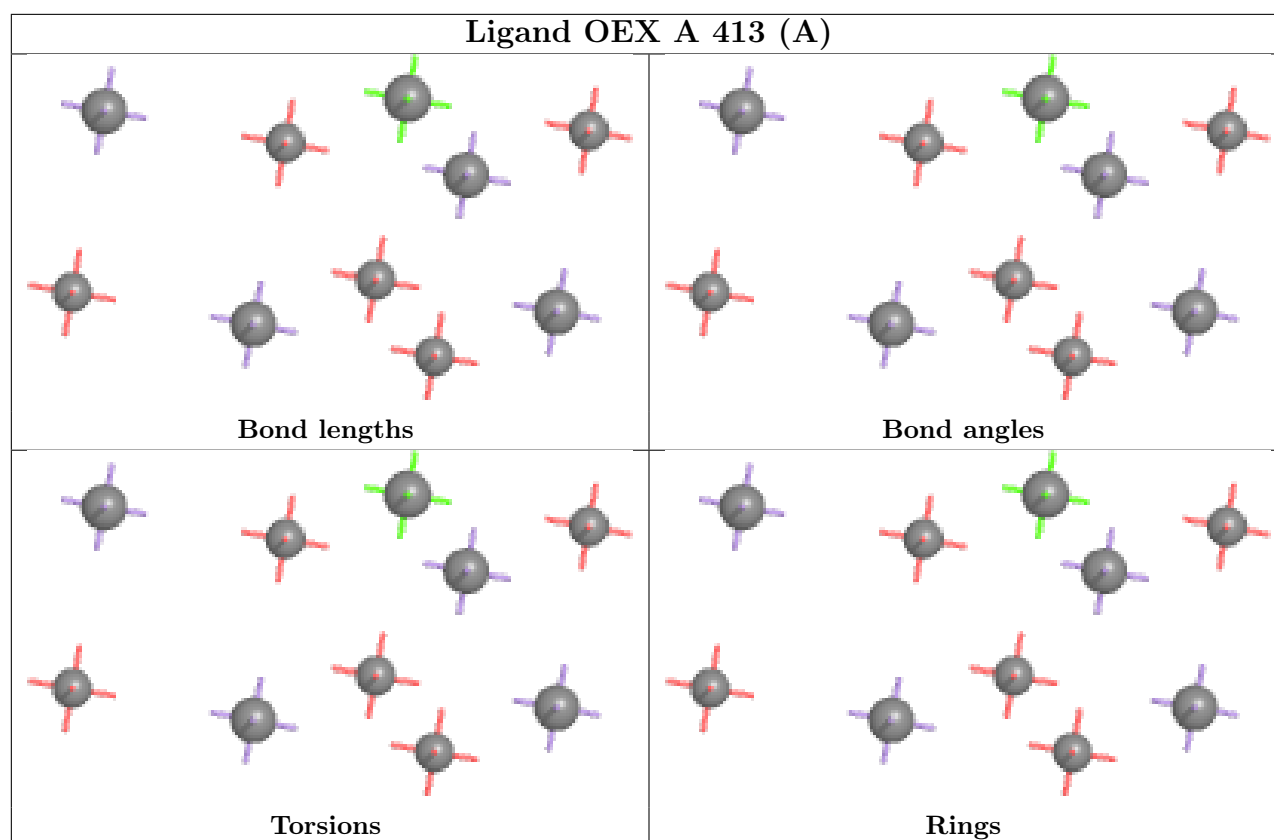

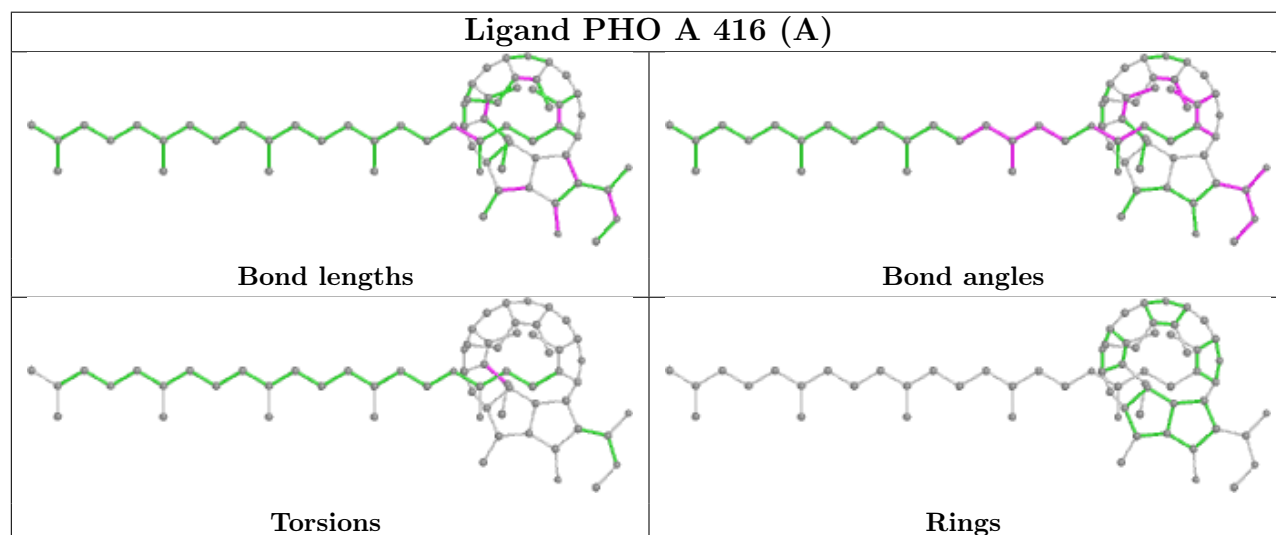
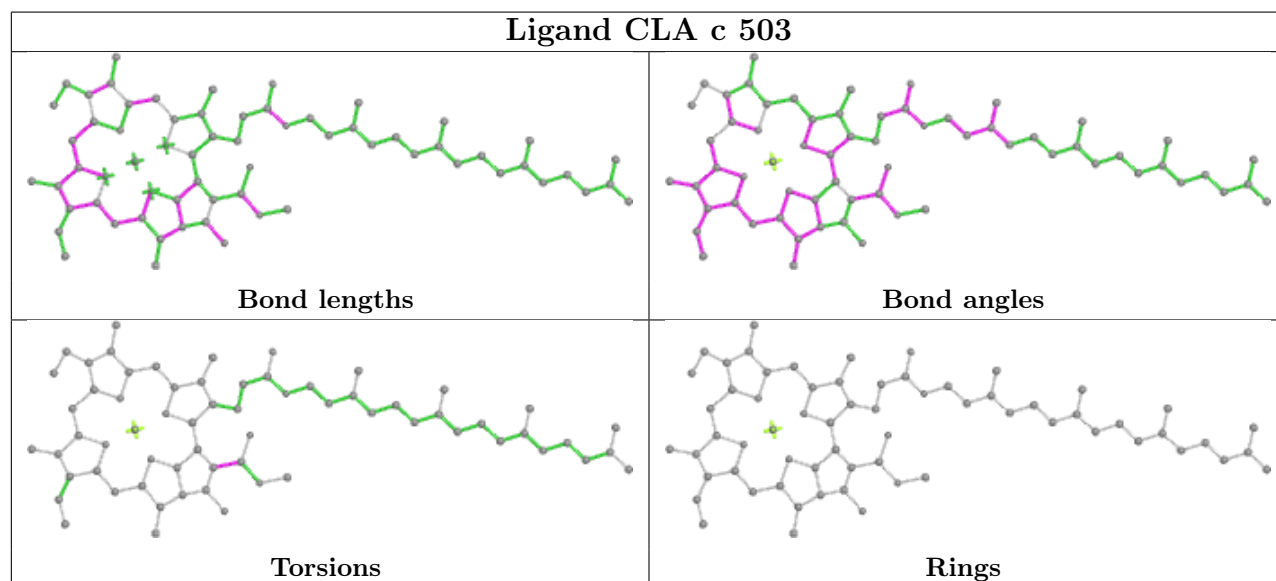
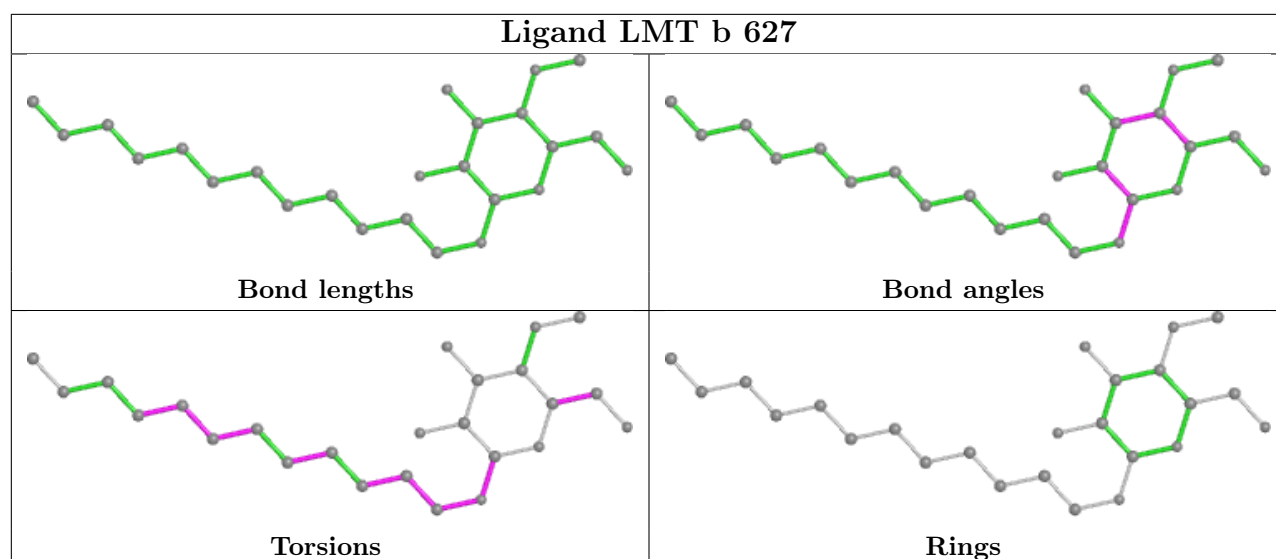

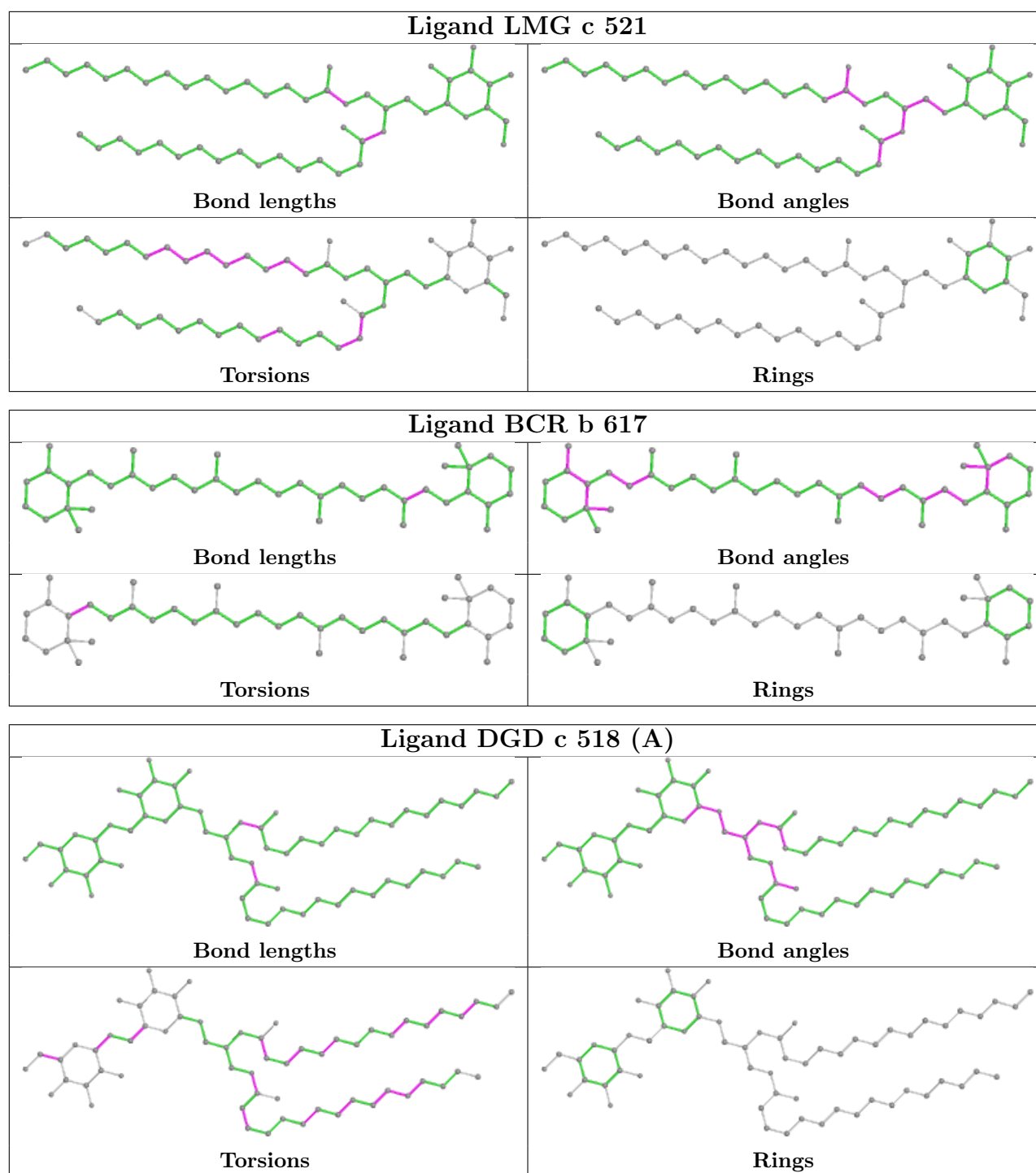

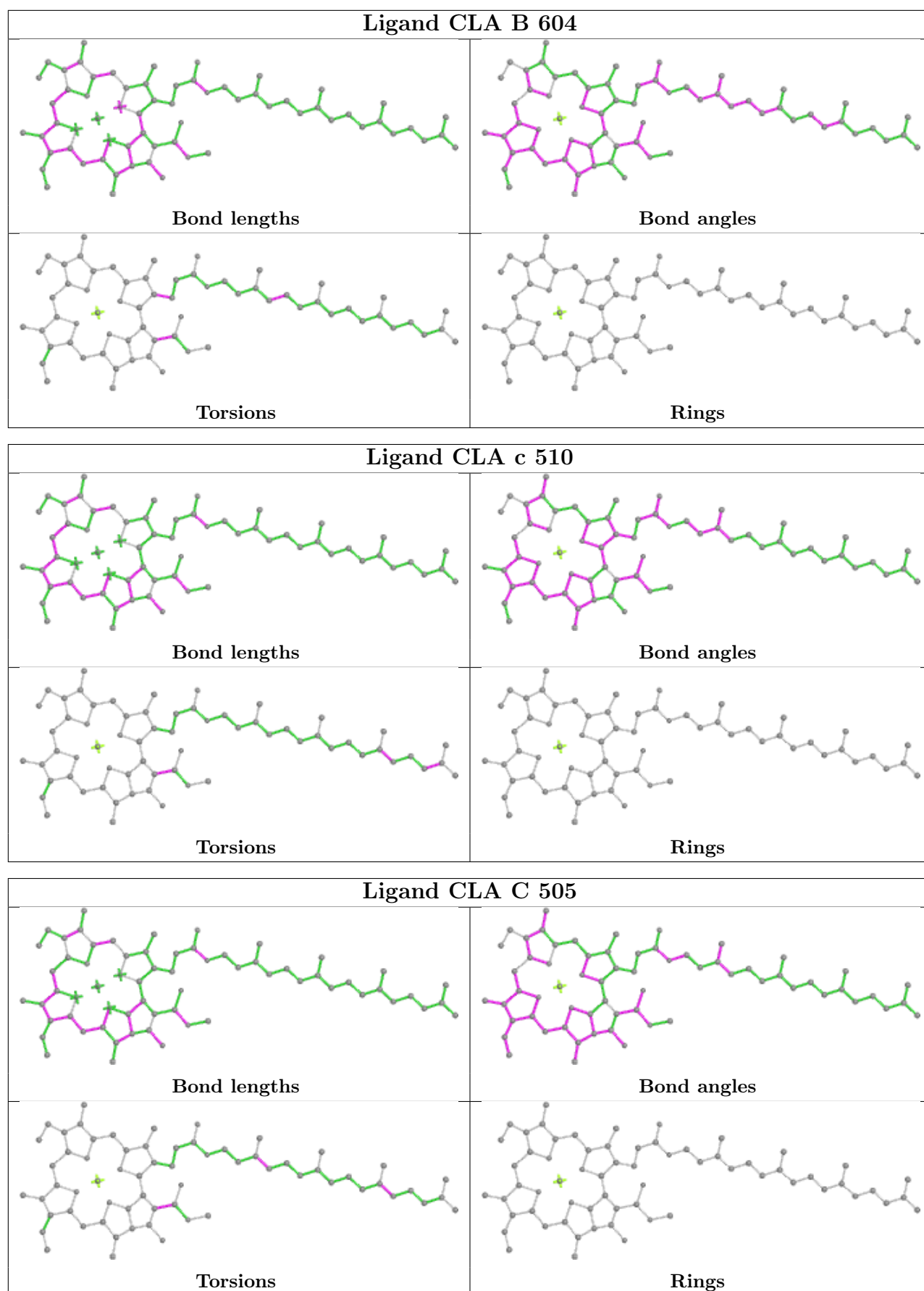

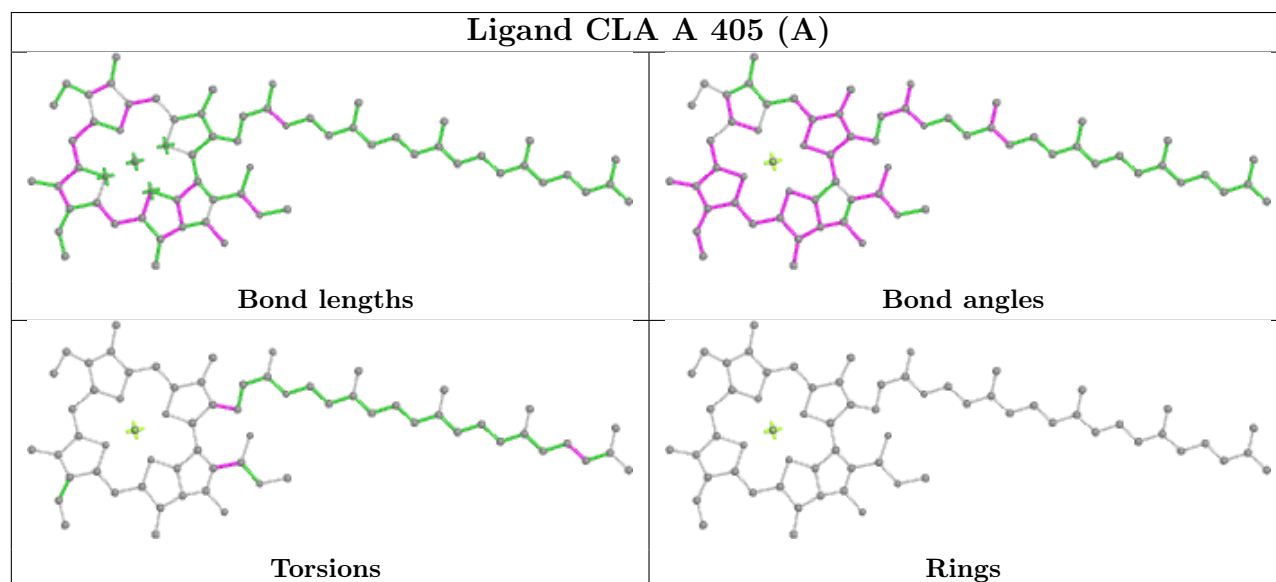
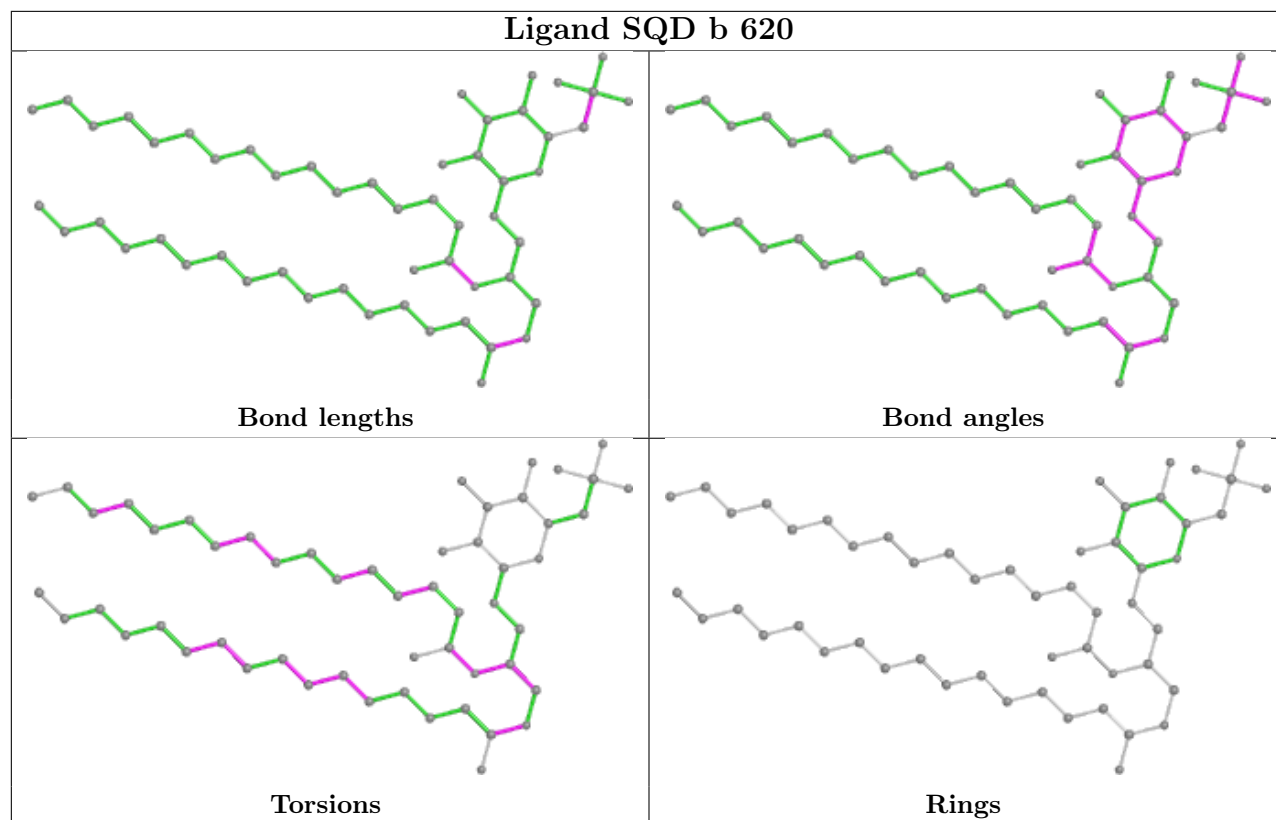

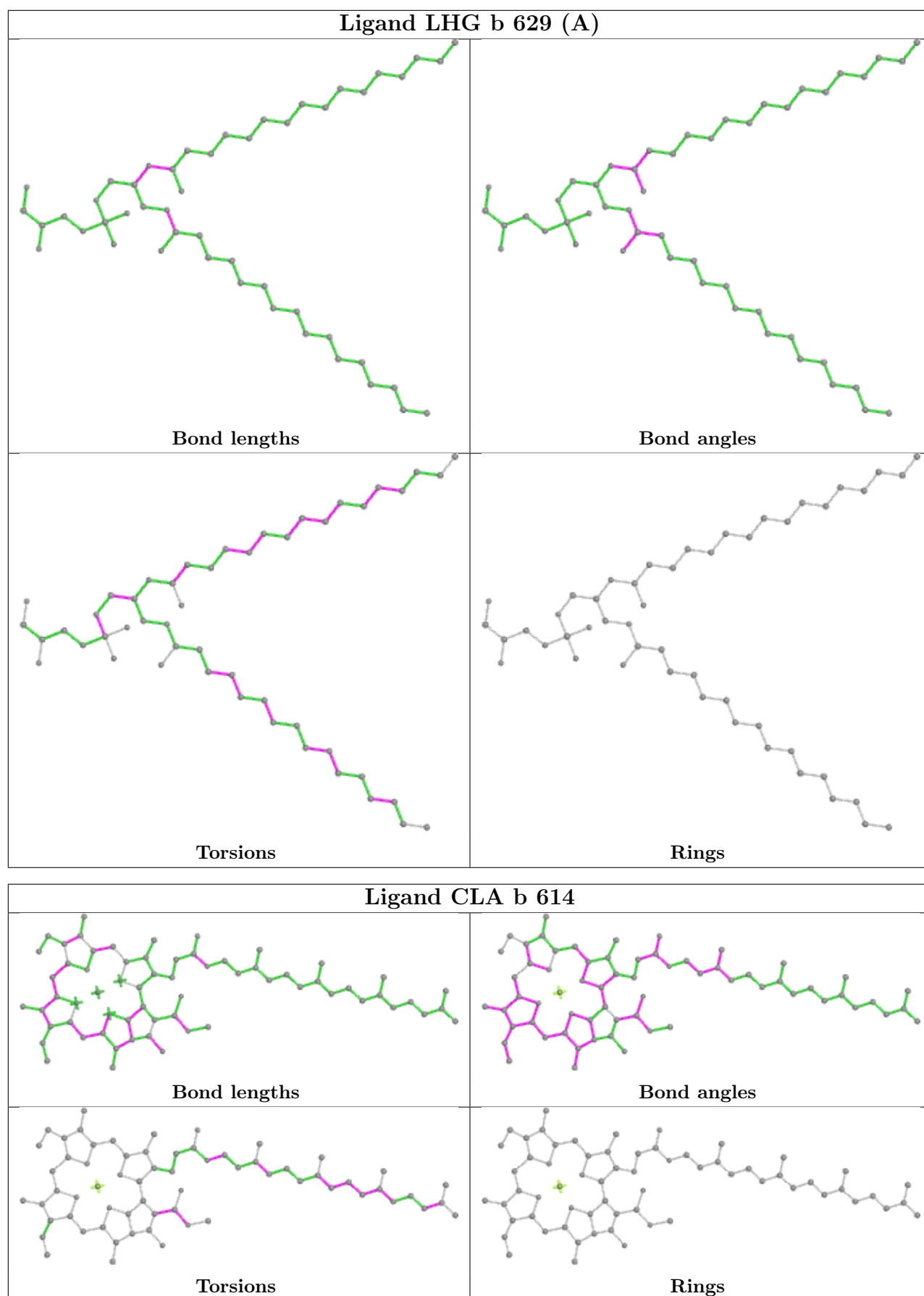

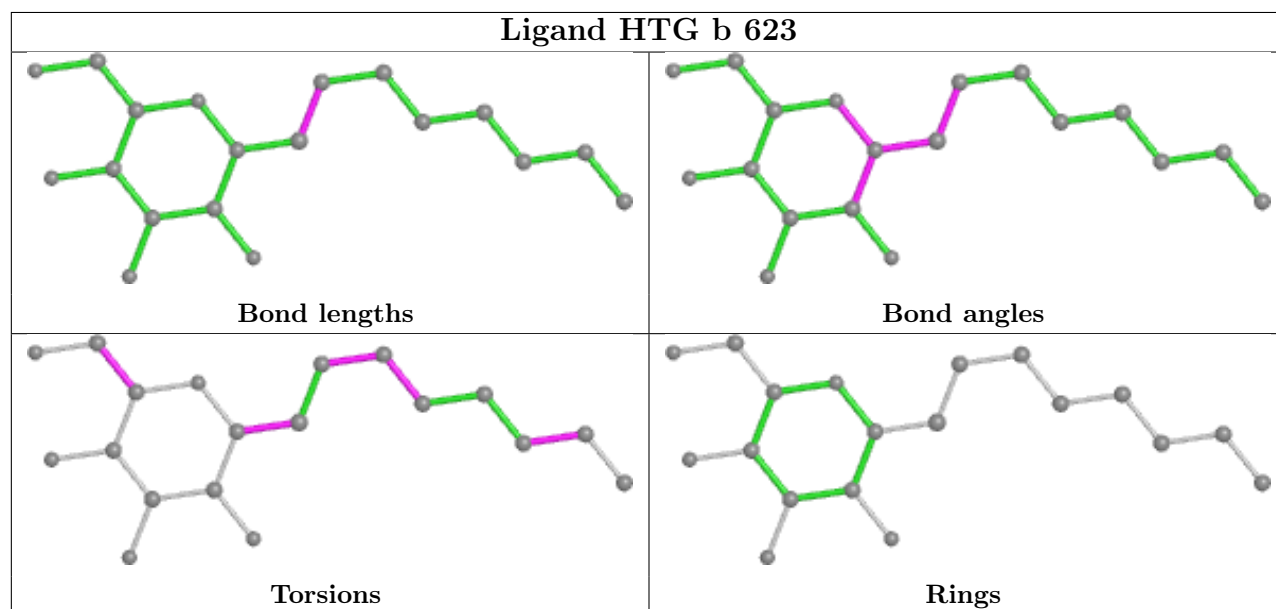
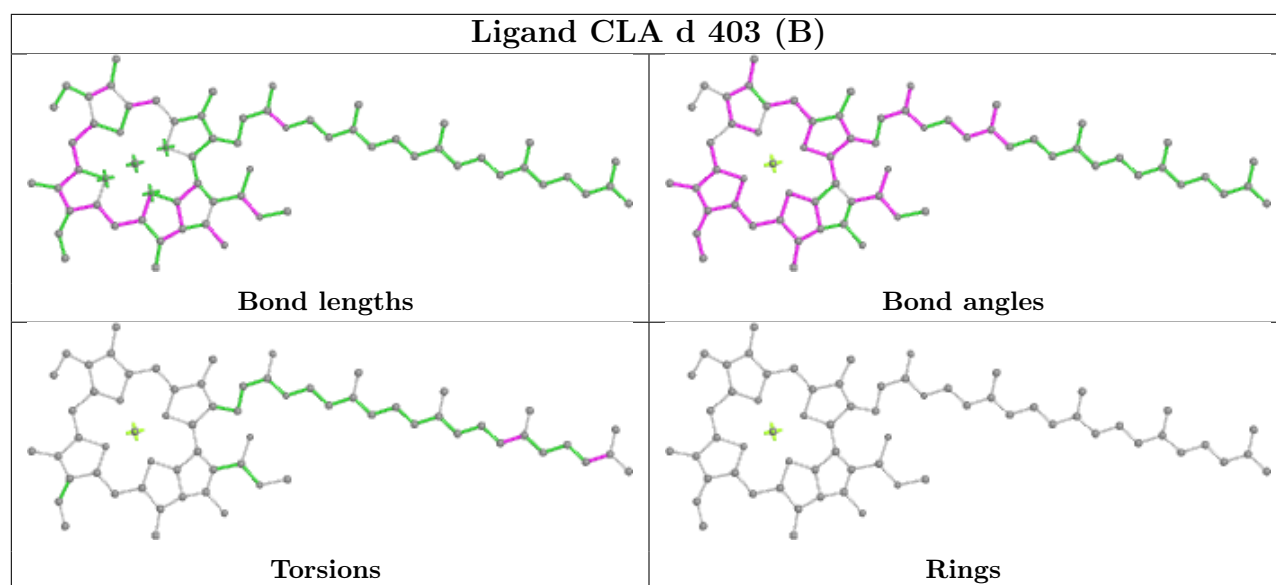

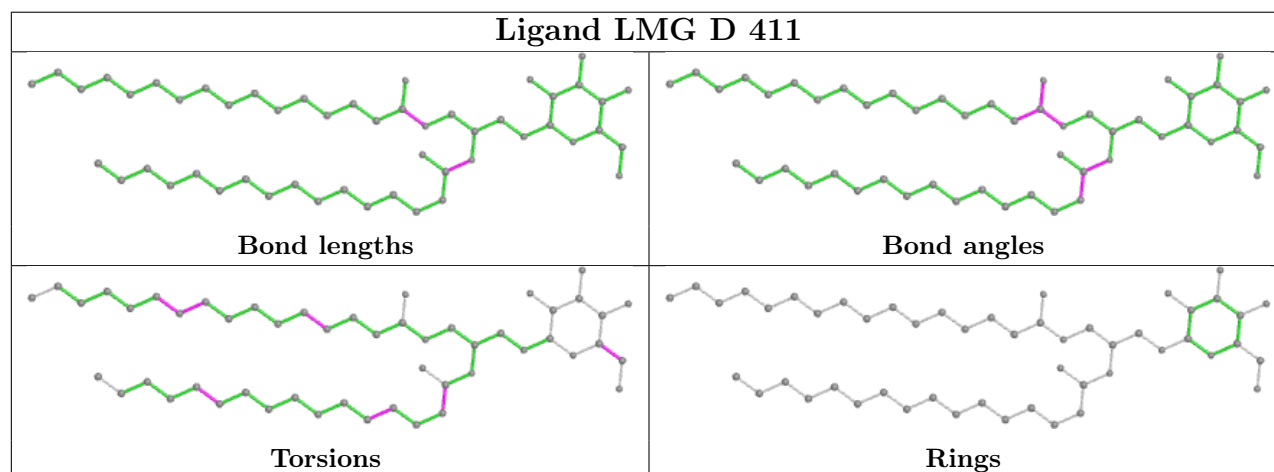
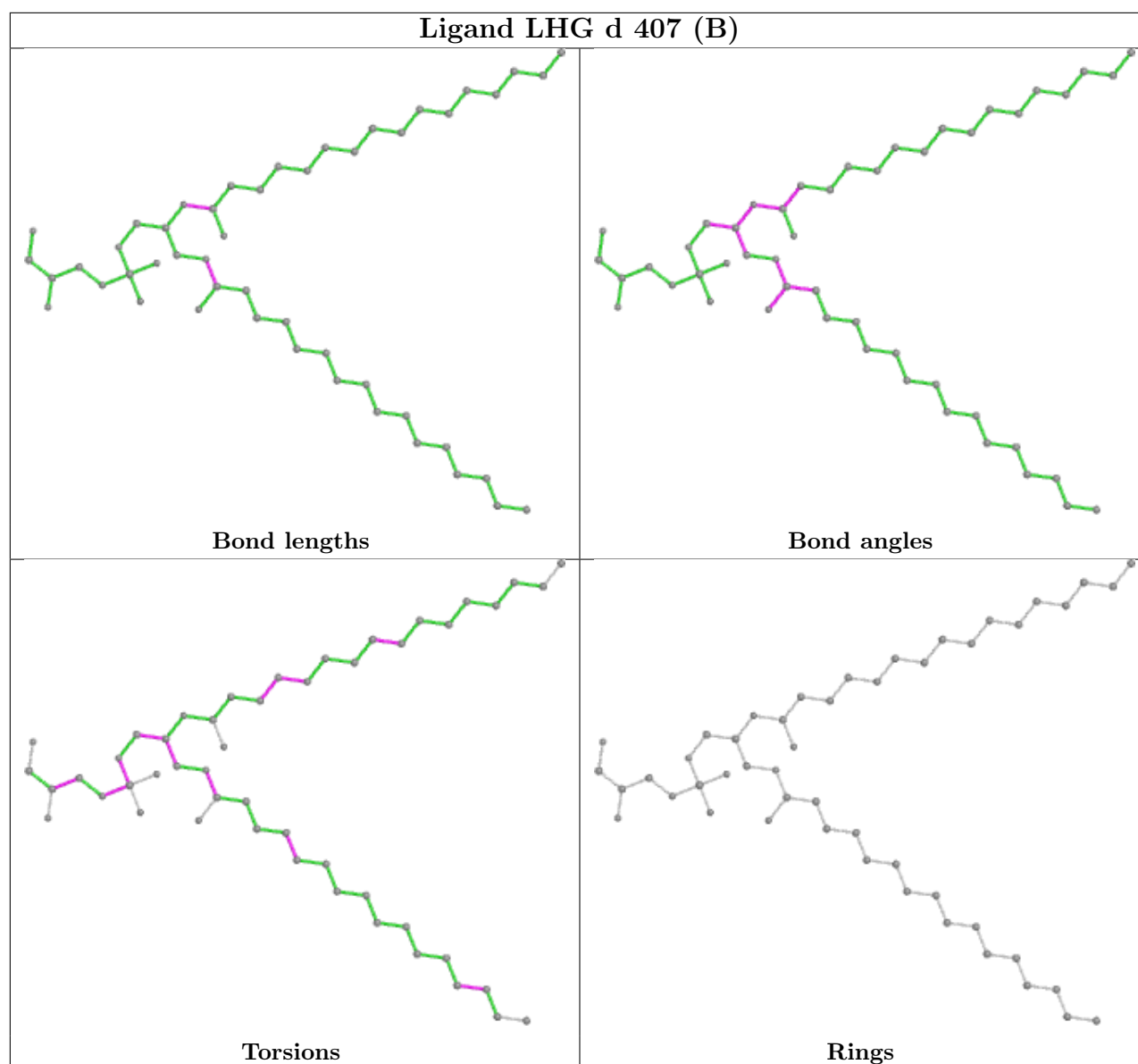

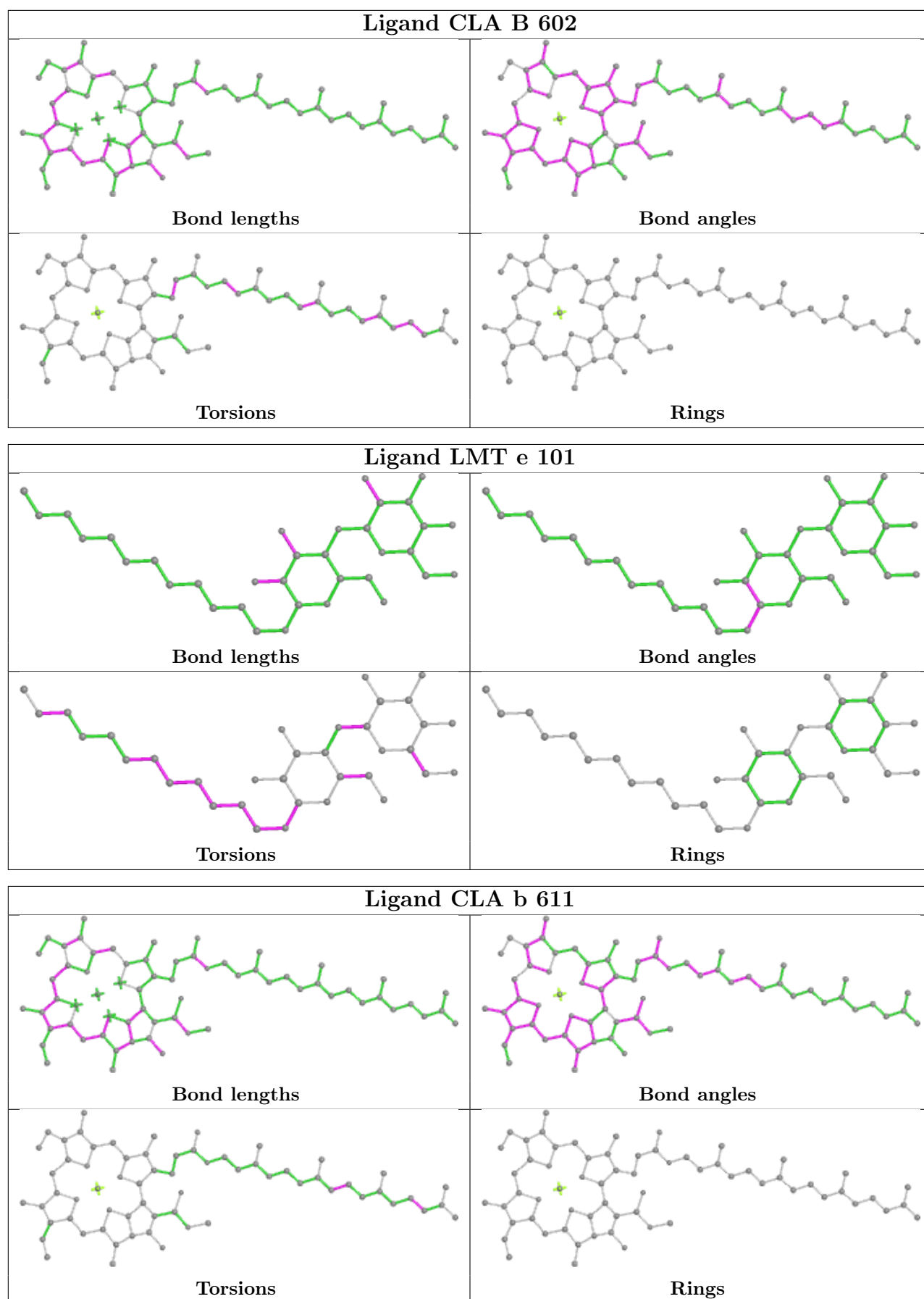

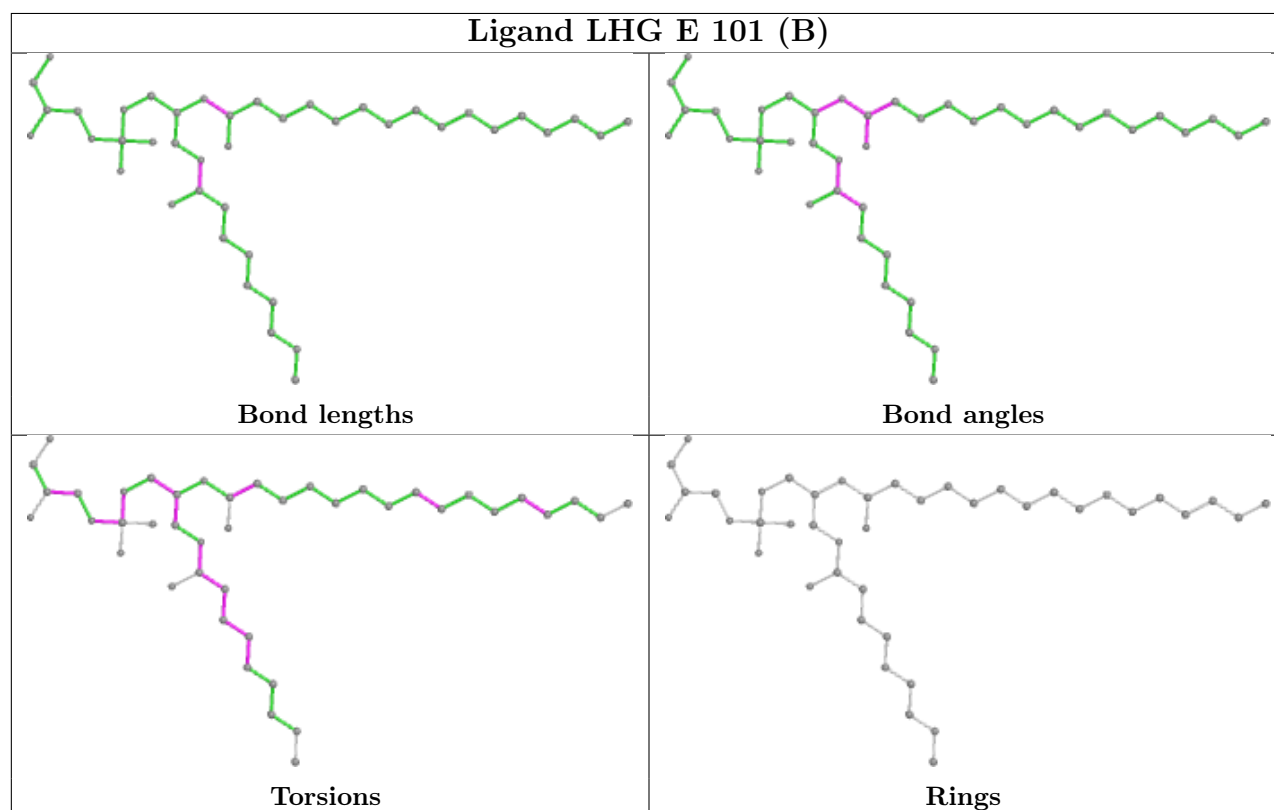
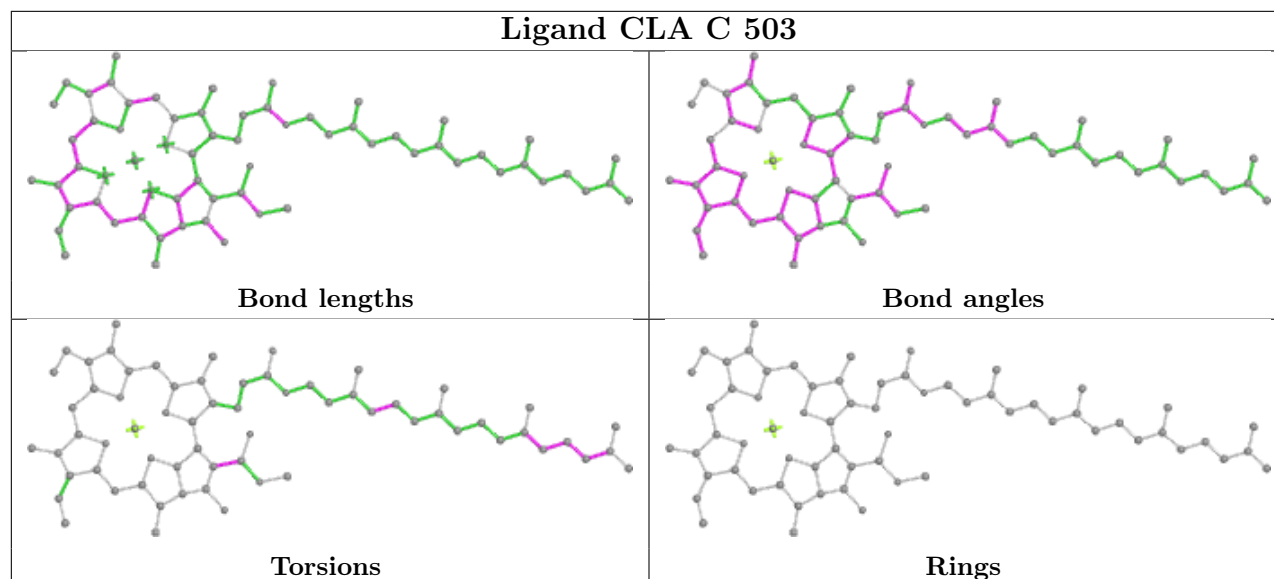
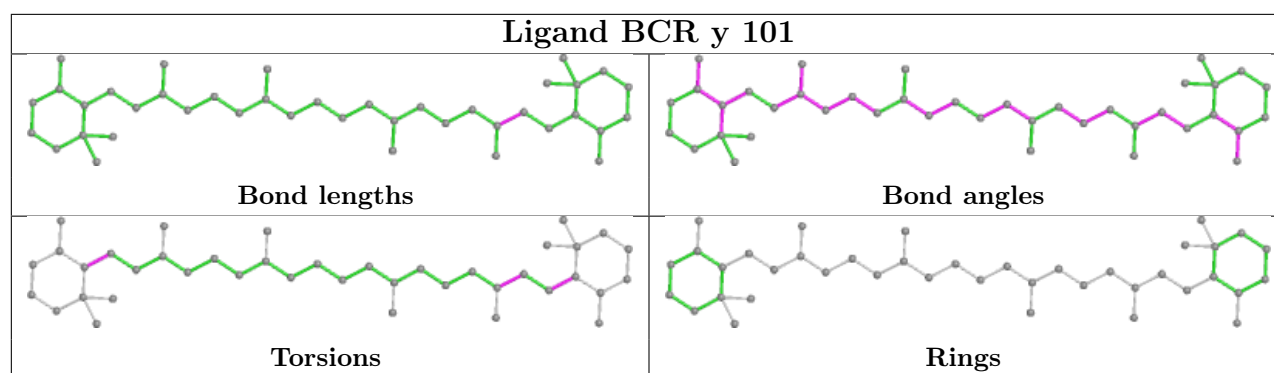

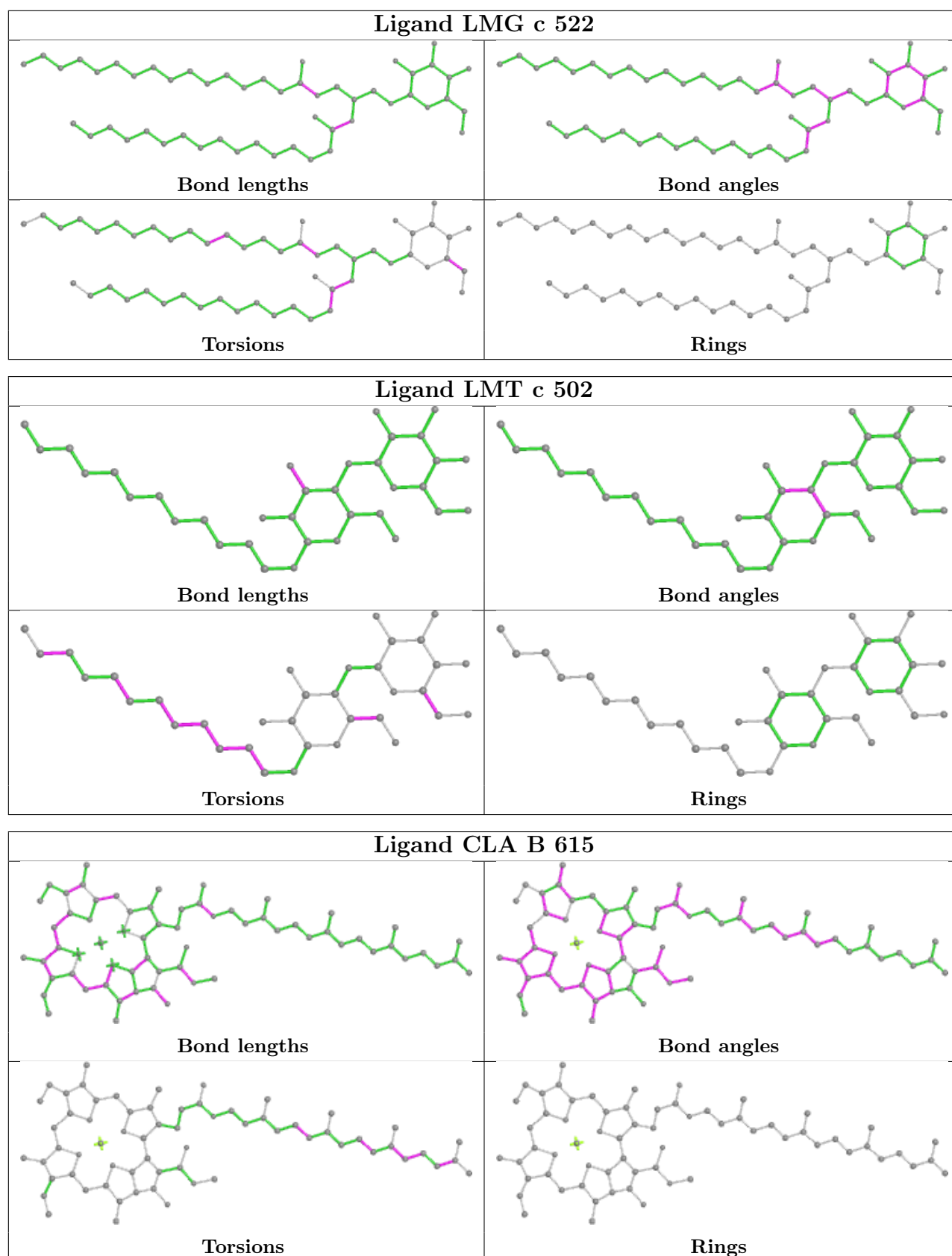

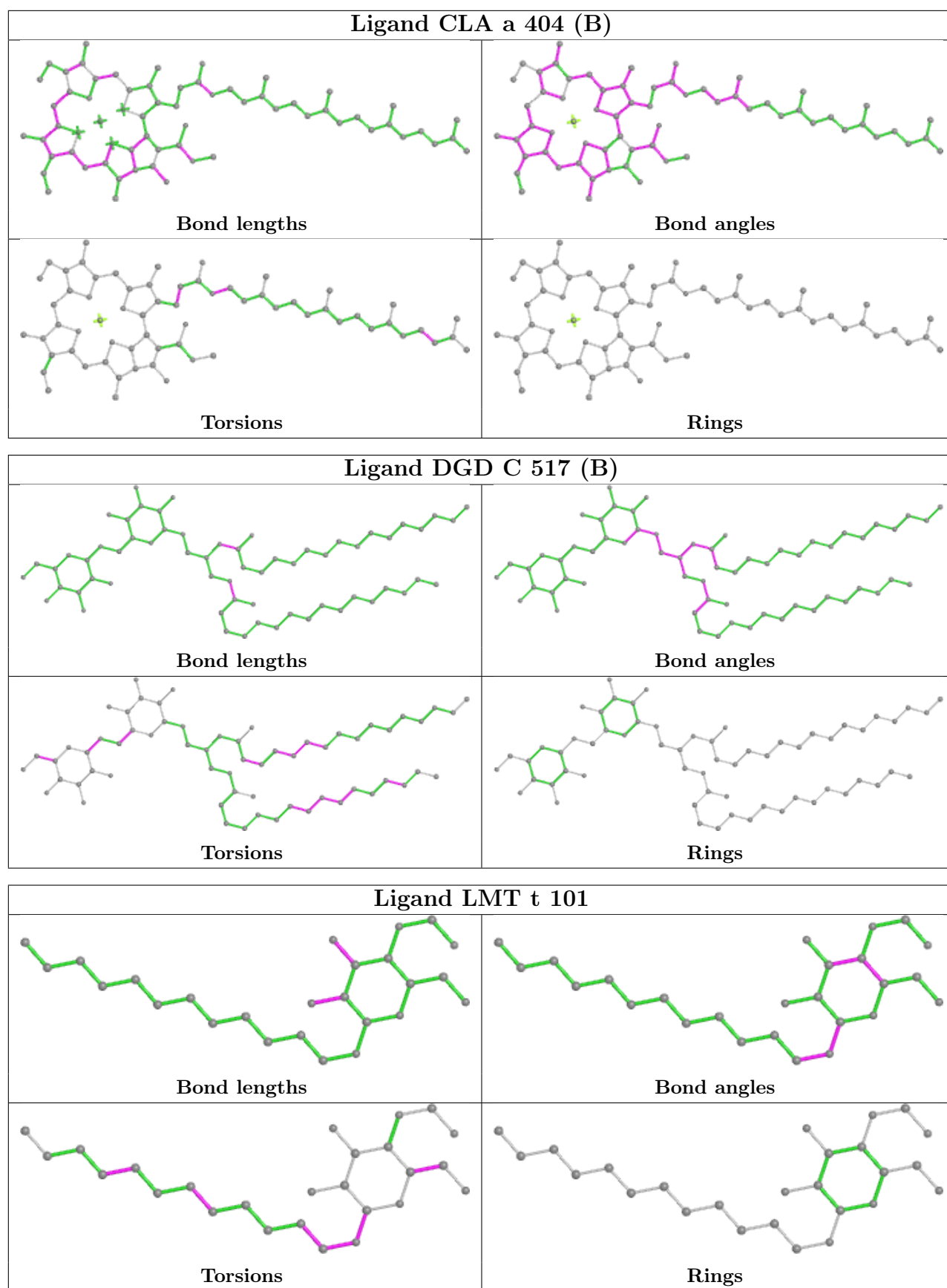

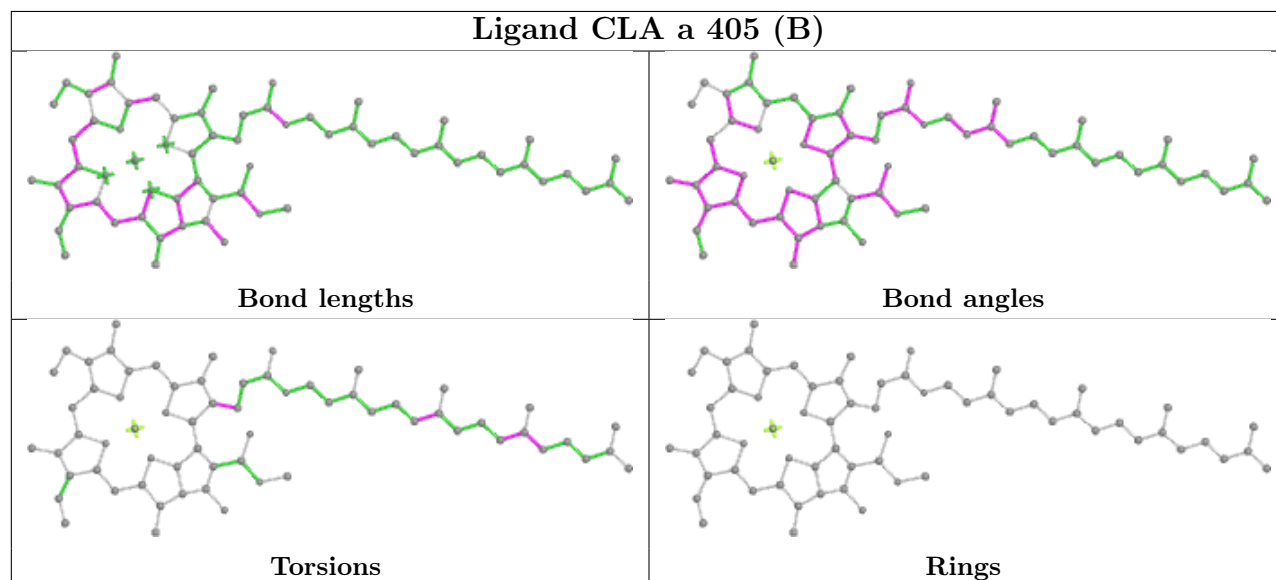
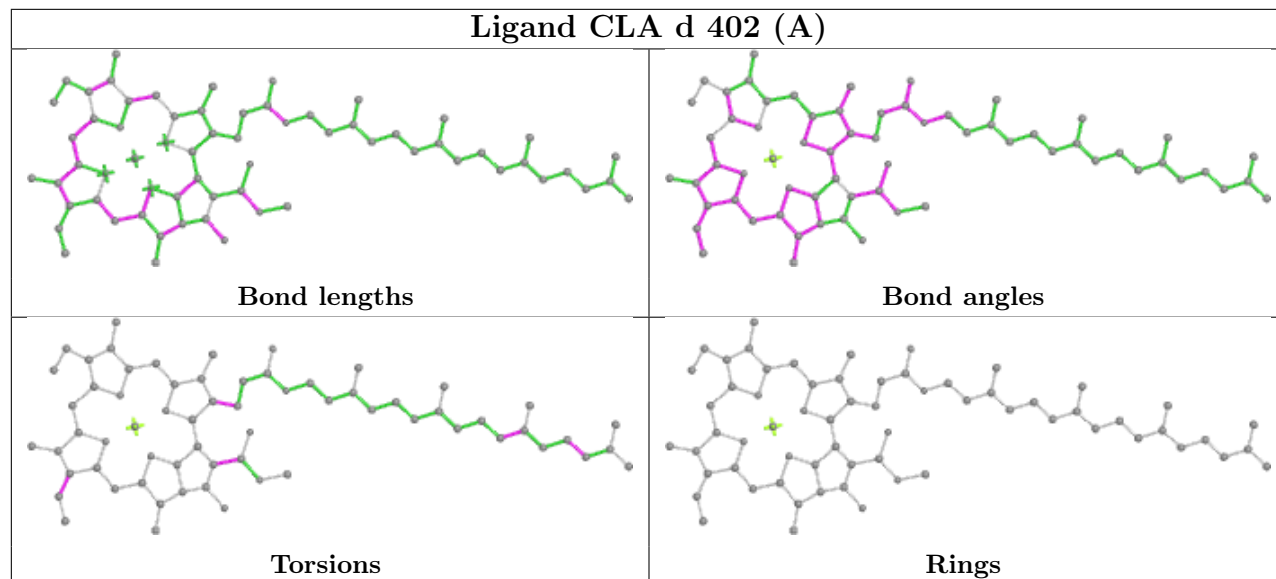
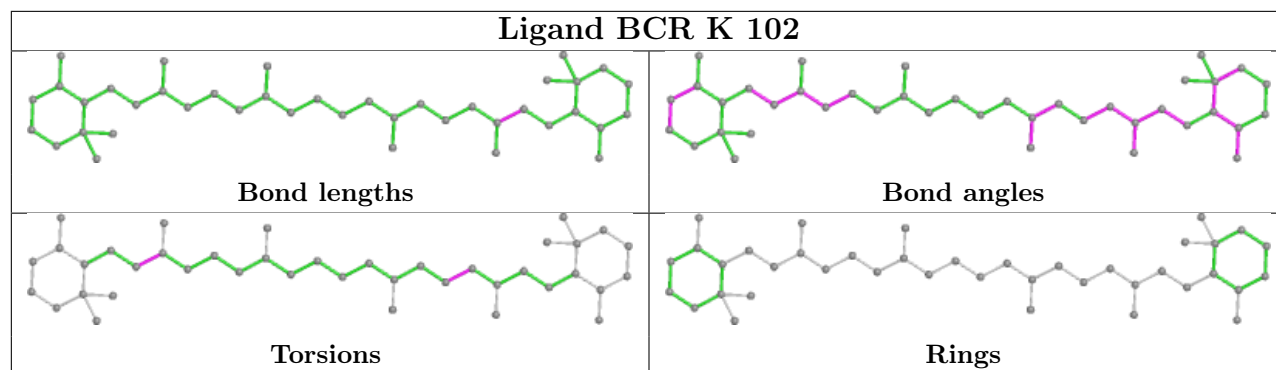

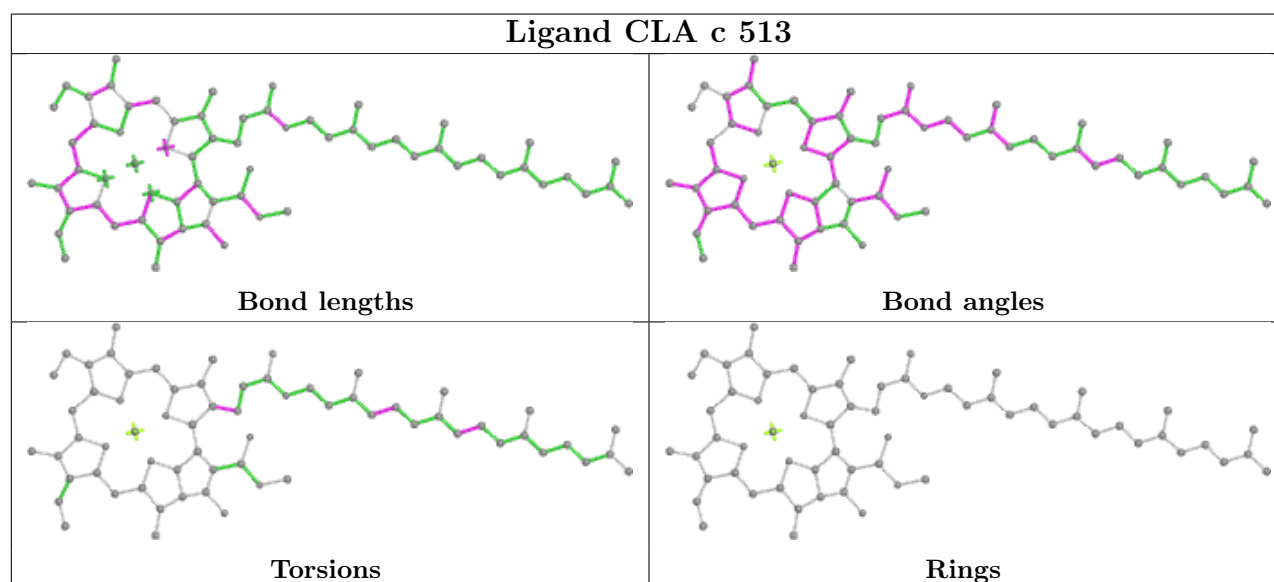
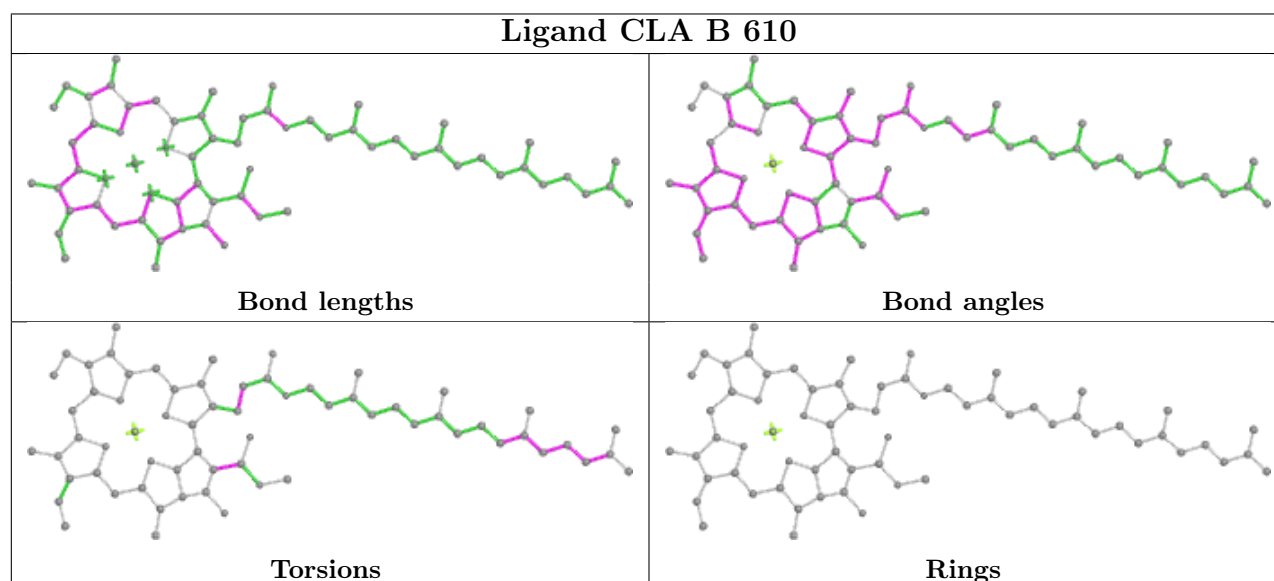
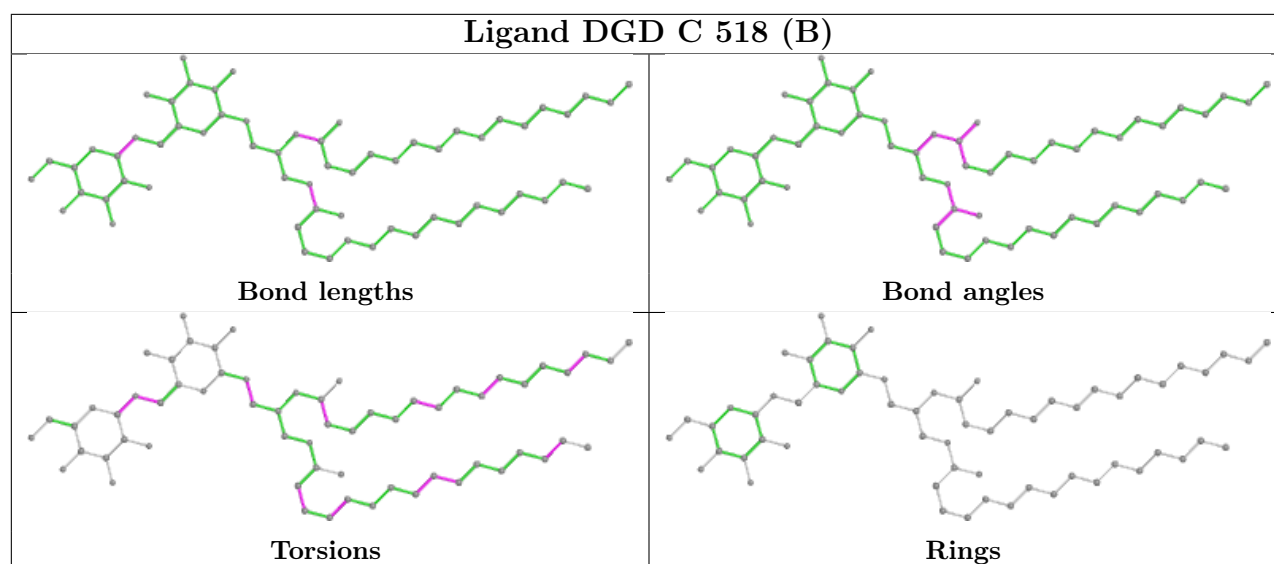

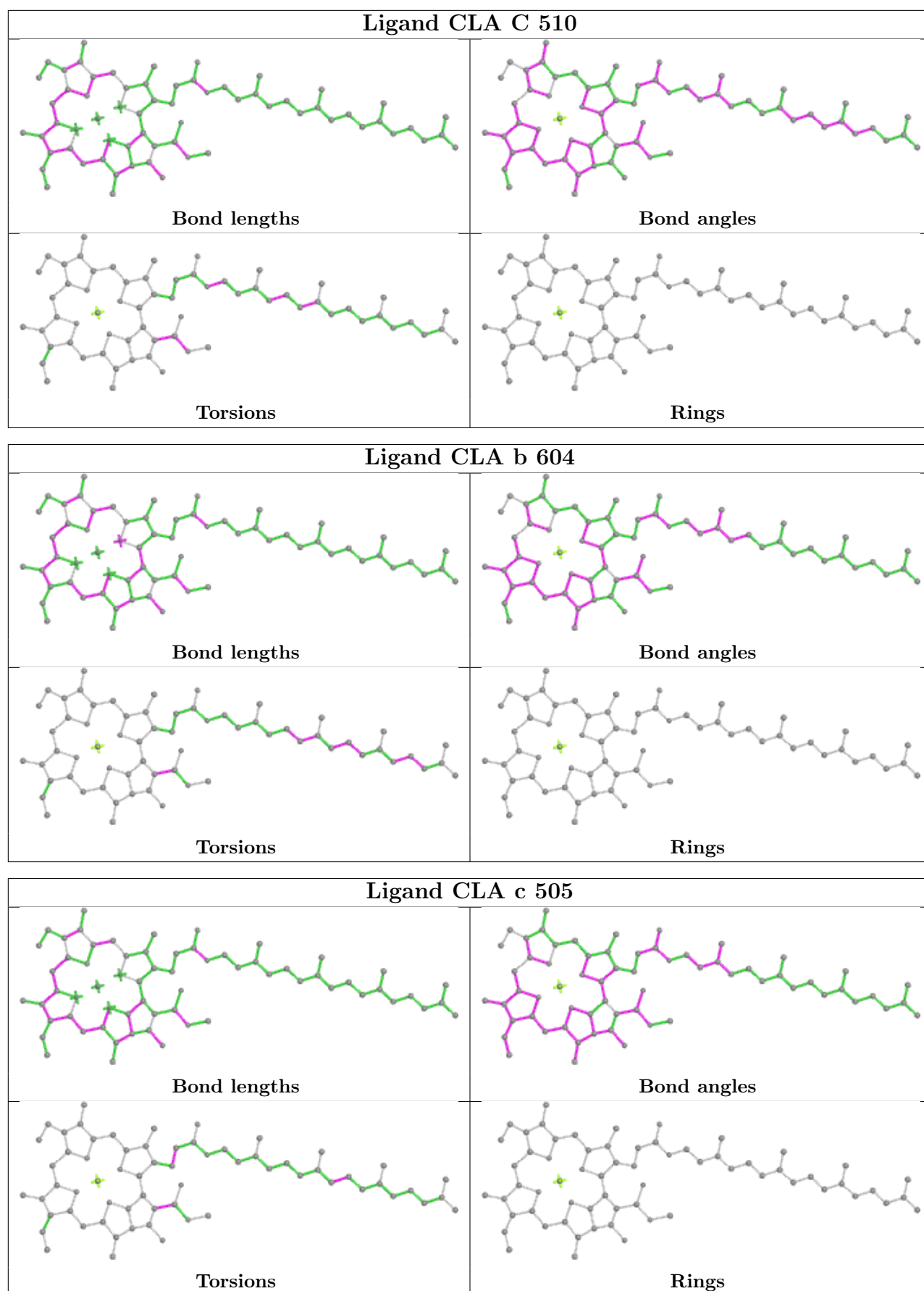

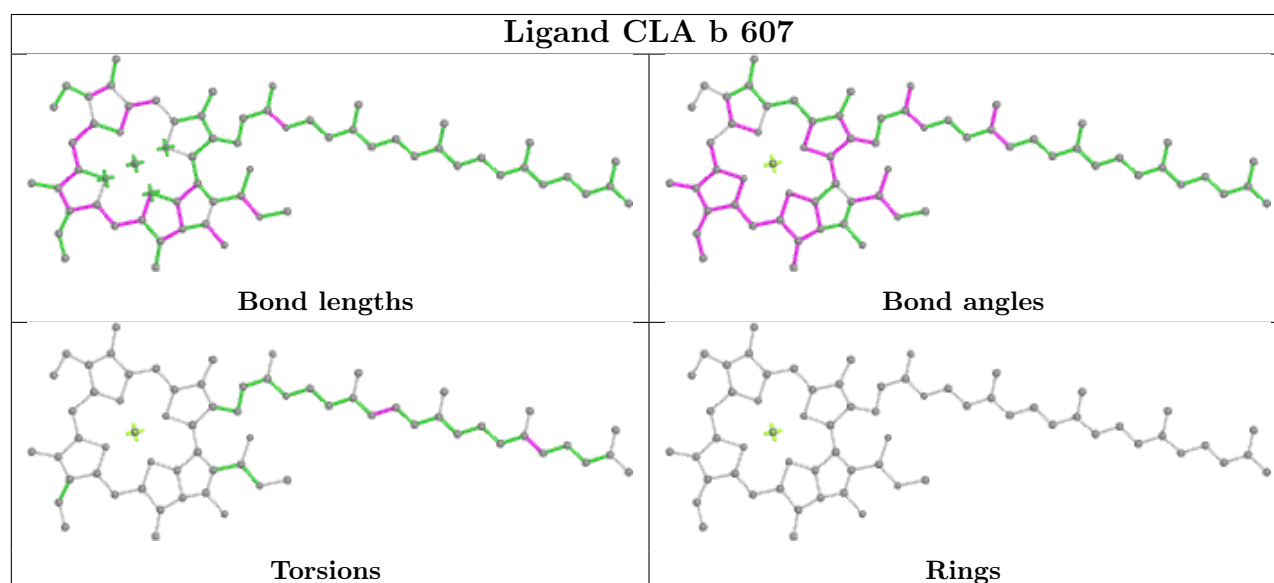
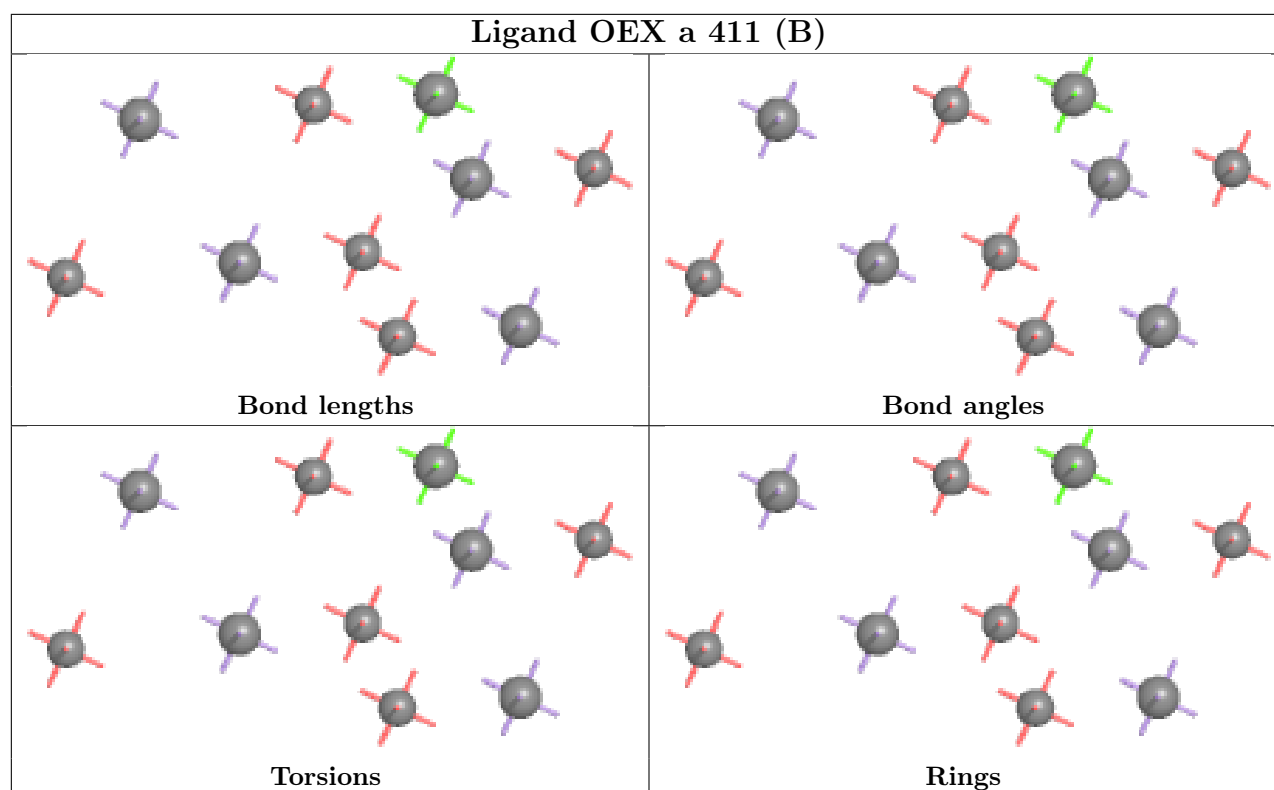

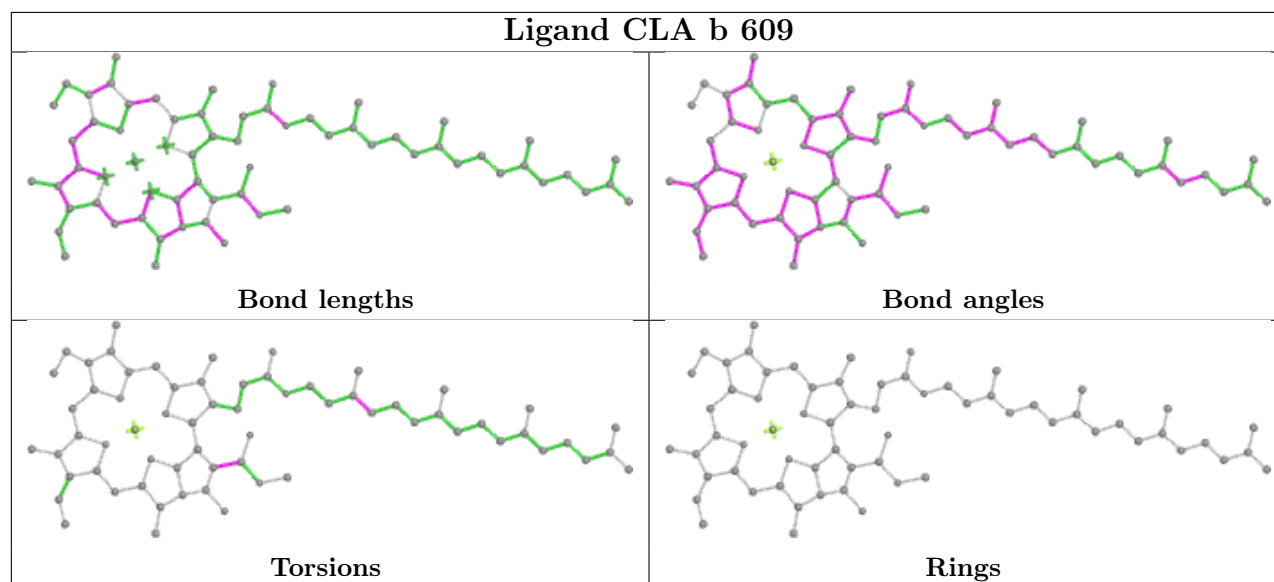
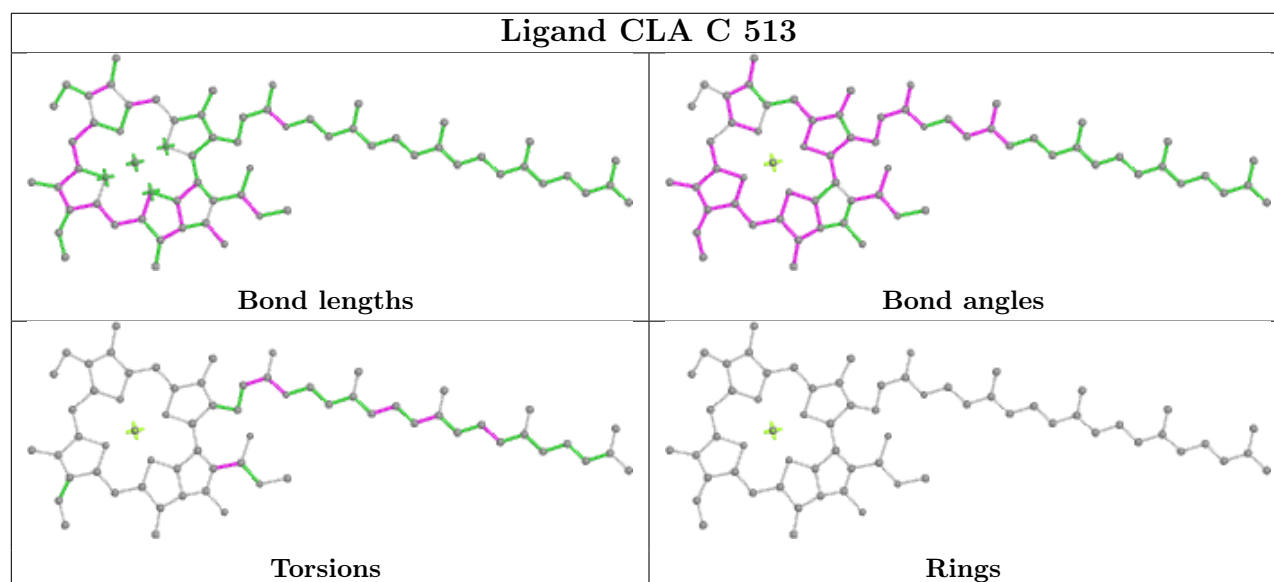
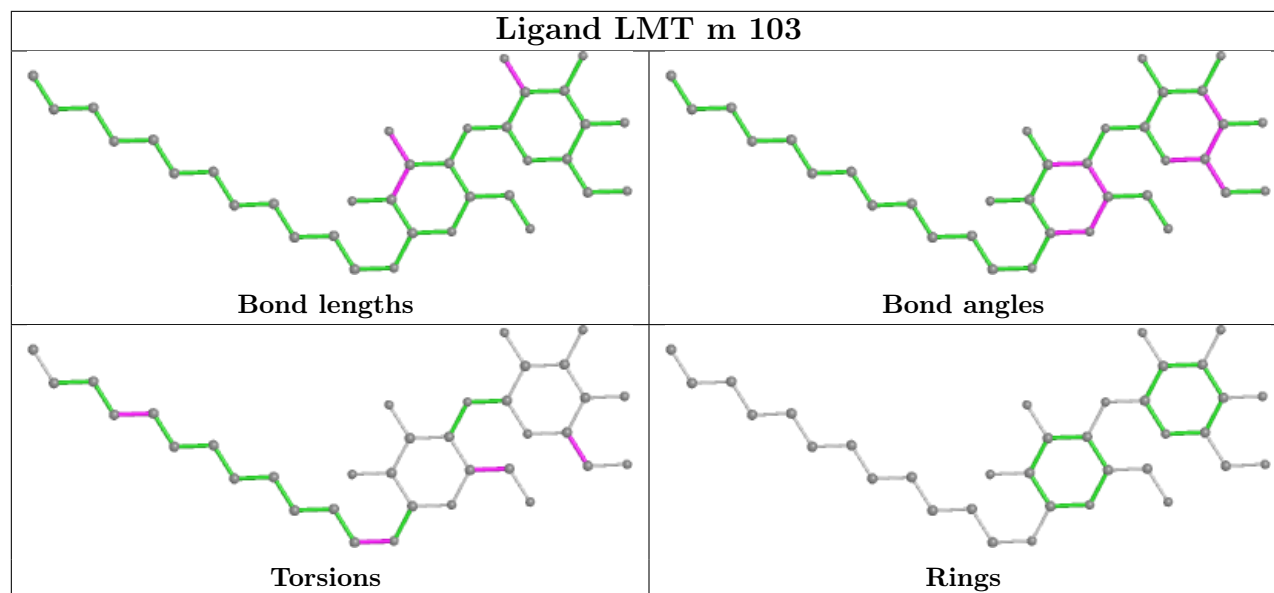

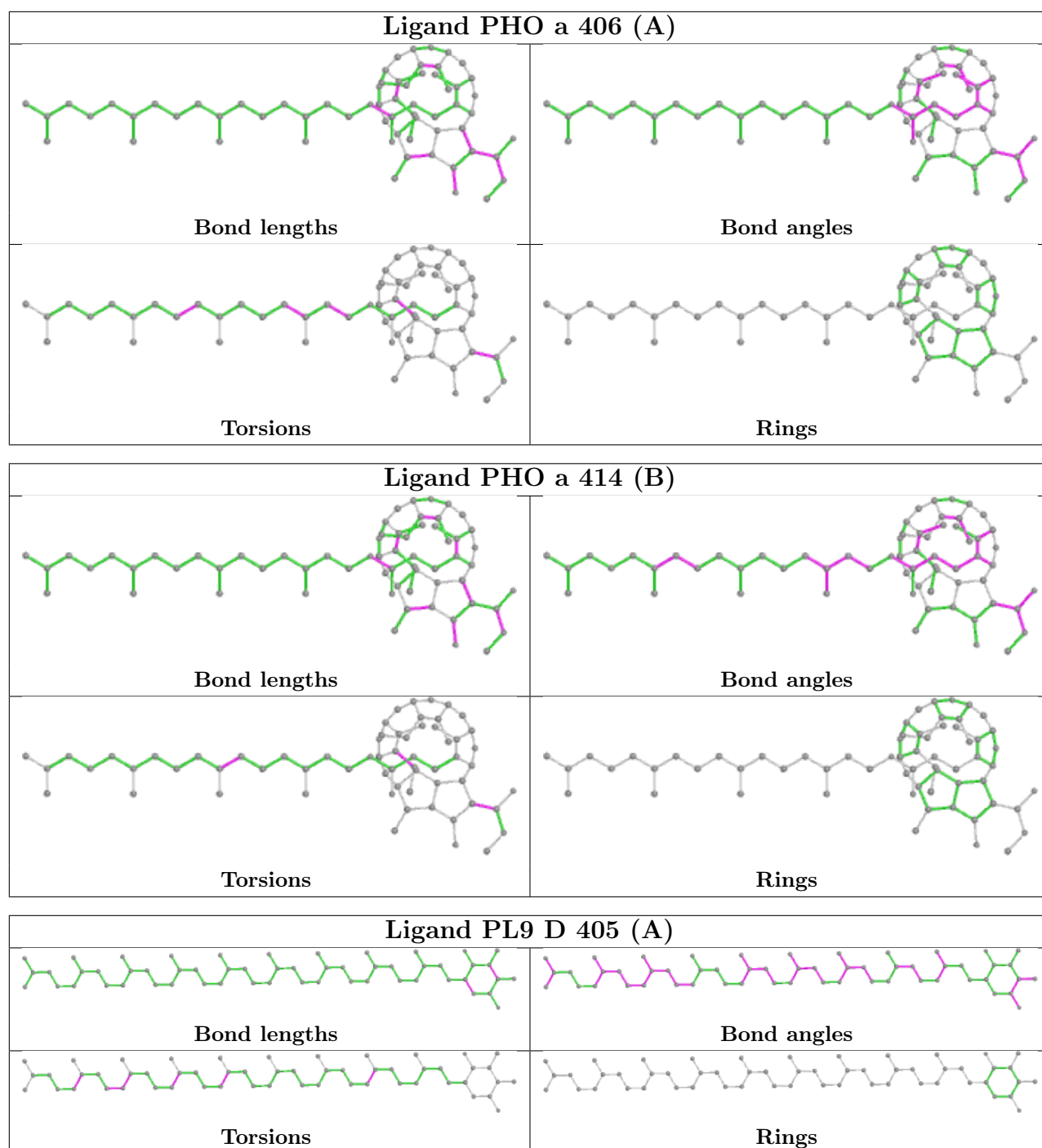

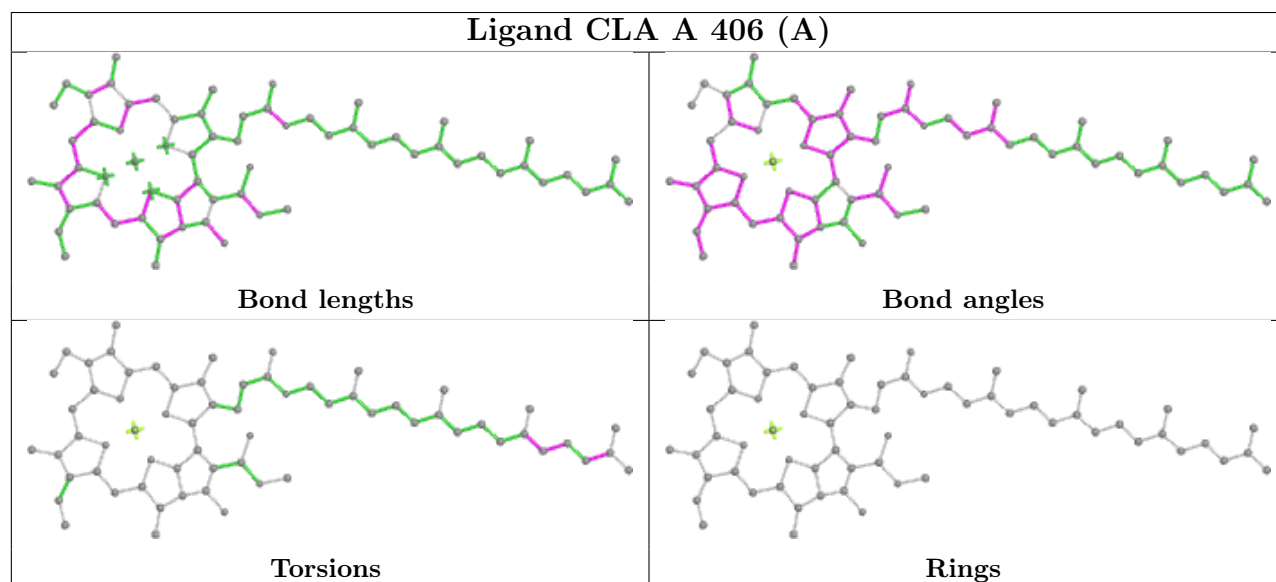
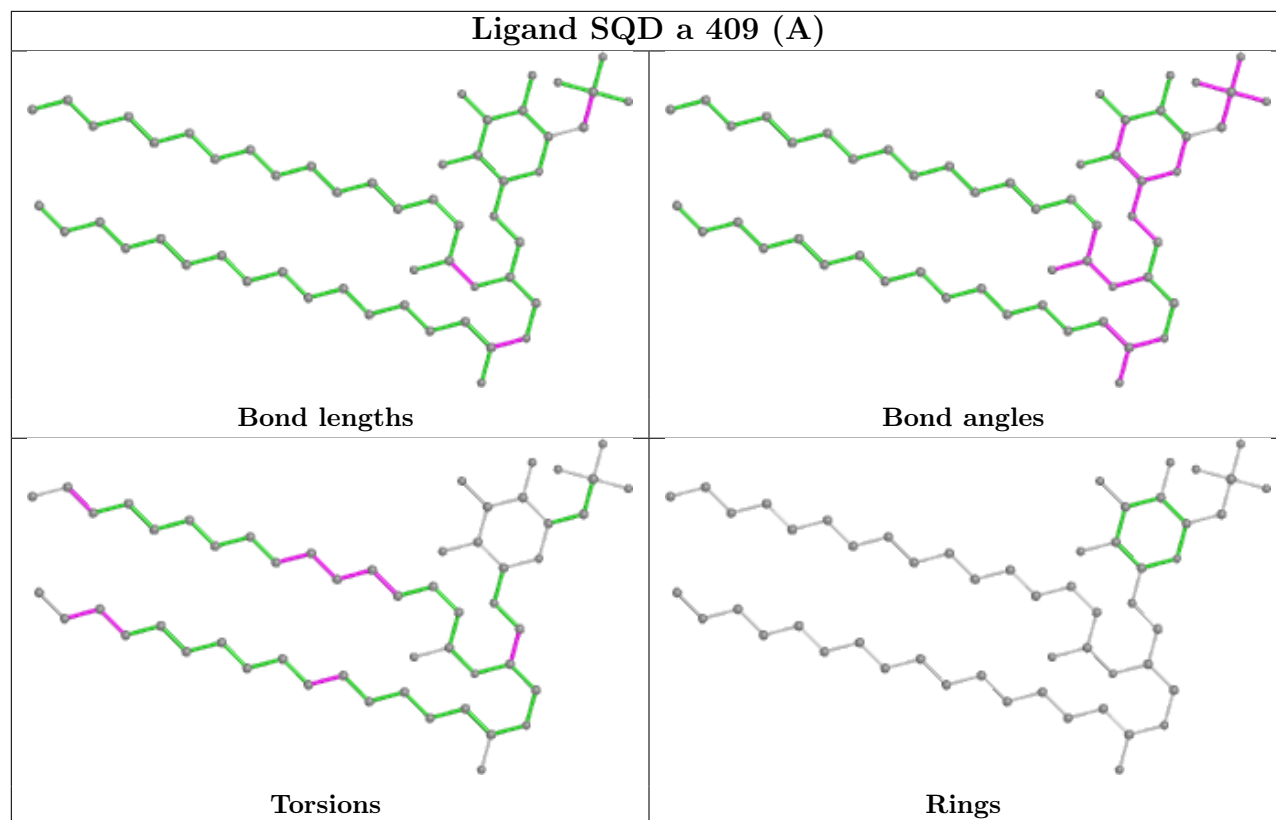

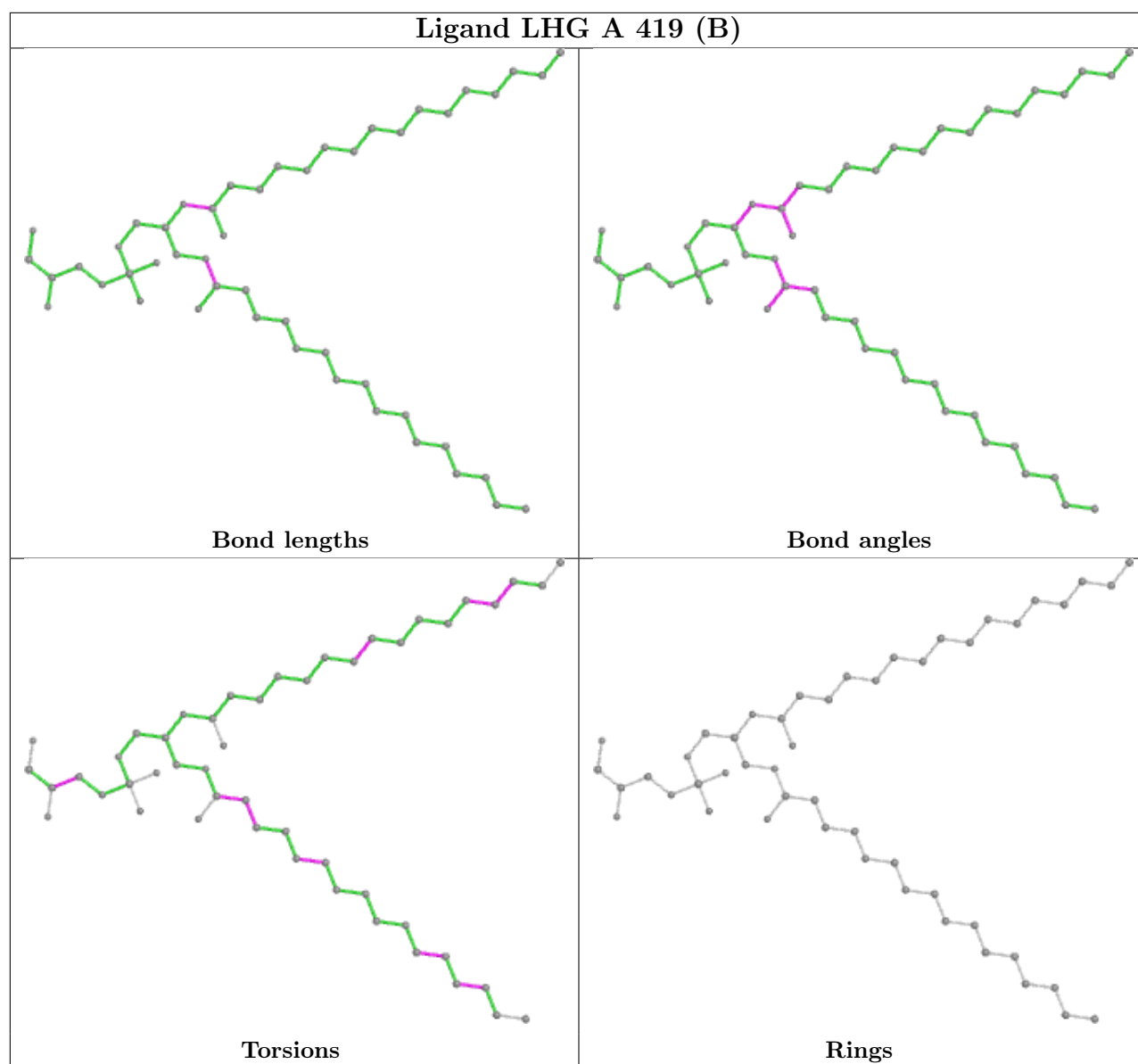

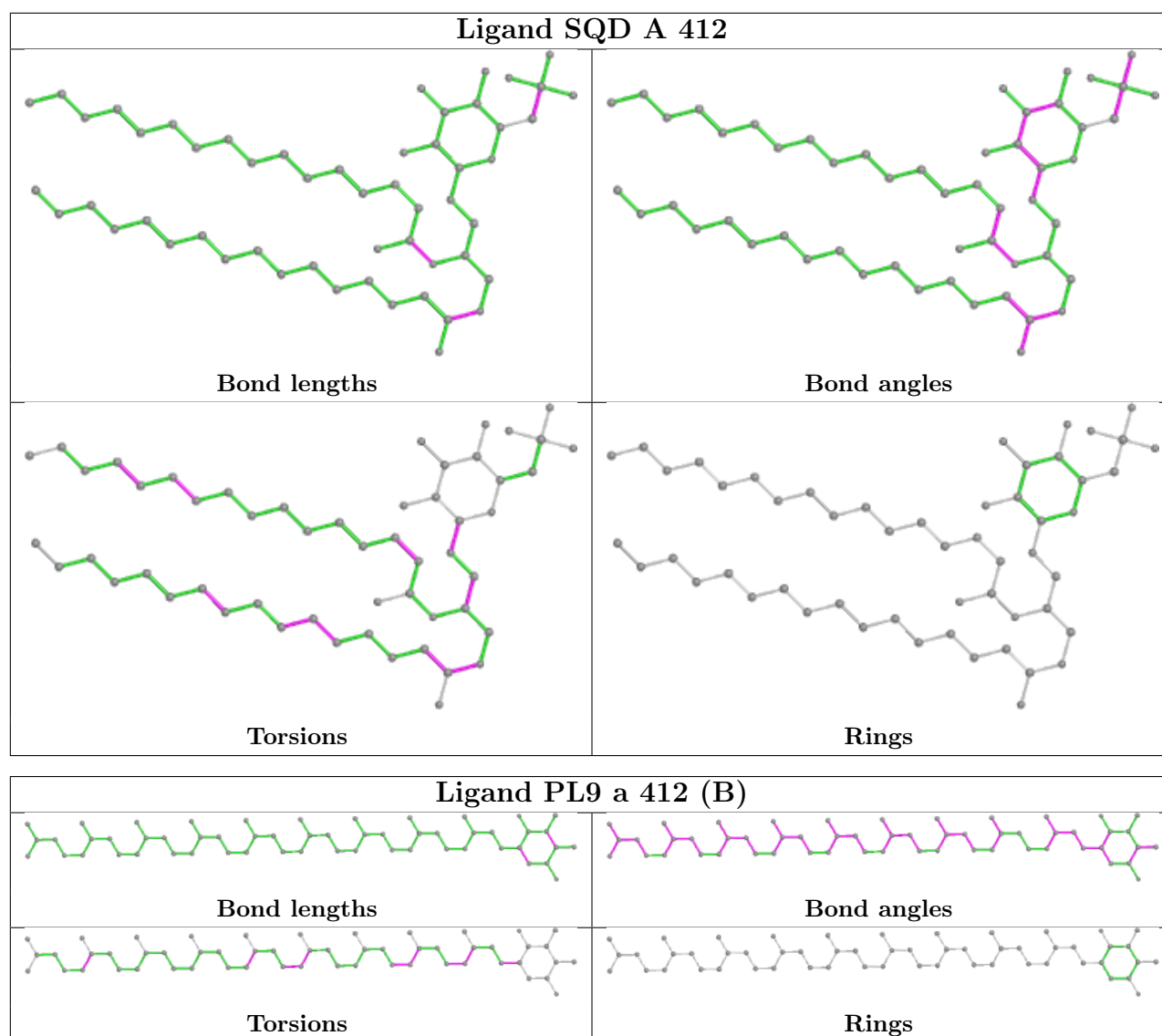

5.7 Other polymers [\(i\)](#)

There are no such residues in this entry.

5.8 Polymer linkage issues [\(i\)](#)

There are no chain breaks in this entry.

6 Fit of model and data [i](#)

6.1 Protein, DNA and RNA chains [i](#)

In the following table, the column labelled ‘#RSRZ > 2’ contains the number (and percentage) of RSRZ outliers, followed by percent RSRZ outliers for the chain as percentile scores relative to all X-ray entries and entries of similar resolution. The OWAB column contains the minimum, median, 95th percentile and maximum values of the occupancy-weighted average B-factor per residue. The column labelled ‘Q < 0.9’ lists the number of (and percentage) of residues with an average occupancy less than 0.9.

Mol	Chain	Analysed	<RSRZ>	#RSRZ>2	OWAB(Å ²)	Q<0.9
1	A	334/344 (97%)	-0.80	5 (1%) 73 75	41, 47, 69, 119	0
1	a	334/344 (97%)	-0.71	4 (1%) 79 81	42, 51, 78, 122	0
2	B	504/505 (99%)	-0.55	11 (2%) 62 65	42, 54, 81, 113	0
2	b	504/505 (99%)	-0.37	31 (6%) 20 22	44, 57, 93, 146	1 (0%)
3	C	451/455 (99%)	-0.62	6 (1%) 77 79	45, 59, 79, 145	0
3	c	455/455 (100%)	-0.52	14 (3%) 49 52	49, 65, 85, 123	2 (0%)
4	D	342/342 (100%)	-0.71	3 (0%) 84 85	40, 49, 66, 135	0
4	d	341/342 (99%)	-0.70	2 (0%) 89 89	43, 54, 75, 131	0
5	E	81/84 (96%)	-0.13	5 (6%) 20 22	52, 69, 97, 160	0
5	e	79/84 (94%)	0.17	7 (8%) 9 10	62, 74, 112, 139	0
6	F	34/44 (77%)	-0.51	2 (5%) 22 24	54, 63, 84, 110	0
6	f	31/44 (70%)	-0.31	2 (6%) 18 20	58, 68, 94, 144	0
7	H	64/65 (98%)	-0.33	2 (3%) 49 52	49, 61, 81, 106	0
7	h	64/65 (98%)	-0.30	3 (4%) 31 34	56, 68, 90, 105	0
8	I	37/38 (97%)	-0.21	4 (10%) 5 5	55, 62, 118, 153	0
8	i	37/38 (97%)	-0.04	5 (13%) 3 2	55, 63, 114, 137	0
9	J	38/39 (97%)	-0.31	2 (5%) 26 29	53, 68, 115, 163	0
9	j	39/39 (100%)	0.17	6 (15%) 2 2	60, 77, 117, 150	0
10	K	37/37 (100%)	-0.64	1 (2%) 54 57	60, 67, 86, 109	0
10	k	37/37 (100%)	-0.59	0 100 100	66, 73, 97, 108	0
11	L	36/37 (97%)	-0.40	3 (8%) 11 12	41, 46, 98, 137	0
11	l	36/37 (97%)	-0.39	2 (5%) 24 26	43, 48, 97, 118	0
12	M	32/36 (88%)	-0.72	1 (3%) 49 52	45, 49, 72, 137	0
12	m	33/36 (91%)	-0.53	2 (6%) 21 23	44, 49, 71, 142	0

Continued on next page...

Continued from previous page...

Mol	Chain	Analysed	<RSRZ>	#RSRZ>2	OWAB(Å ²)	Q<0.9
13	O	243/244 (99%)	-0.12	15 (6%) 20 22	43, 65, 115, 173	0
13	o	243/244 (99%)	0.00	25 (10%) 6 6	45, 66, 120, 164	0
14	T	29/32 (90%)	-0.69	2 (6%) 16 18	42, 48, 77, 113	0
14	t	29/32 (90%)	-0.79	1 (3%) 45 47	44, 50, 77, 129	0
15	U	96/104 (92%)	-0.50	0 100 100	48, 59, 89, 94	0
15	u	97/104 (93%)	-0.45	1 (1%) 82 84	53, 62, 82, 133	0
16	V	137/137 (100%)	-0.60	1 (0%) 87 88	48, 58, 81, 106	0
16	v	137/137 (100%)	-0.20	4 (2%) 51 55	55, 70, 102, 130	0
17	X	38/40 (95%)	-0.39	2 (5%) 26 29	61, 70, 92, 111	0
17	x	38/40 (95%)	-0.01	4 (10%) 6 6	64, 76, 115, 152	0
18	Y	29/30 (96%)	1.12	7 (24%) 0 0	70, 83, 122, 128	0
18	y	29/30 (96%)	0.34	5 (17%) 1 1	75, 92, 108, 116	0
19	Z	62/62 (100%)	-0.02	6 (9%) 7 8	66, 80, 133, 155	0
19	z	62/62 (100%)	0.33	12 (19%) 1 1	80, 94, 139, 191	0
20	R	34/34 (100%)	1.98	19 (55%) 0 0	82, 99, 125, 134	0
All	All	5283/5384 (98%)	-0.44	227 (4%) 35 37	40, 59, 98, 191	3 (0%)

The worst 5 of 227 RSRZ outliers are listed below:

Mol	Chain	Res	Type	RSRZ
1	a	11	ALA	8.5
3	c	20	SER	7.5
5	E	84	LYS	7.5
3	C	23	ALA	7.2
13	O	60	ARG	7.1

6.2 Non-standard residues in protein, DNA, RNA chains [i](#)

In the following table, the Atoms column lists the number of modelled atoms in the group and the number defined in the chemical component dictionary. The B-factors column lists the minimum, median, 95th percentile and maximum values of B factors of atoms in the group. The column labelled 'Q< 0.9' lists the number of atoms with occupancy less than 0.9.

Mol	Type	Chain	Res	Atoms	RSCC	RSR	B-factors(Å ²)	Q<0.9
8	FME	i	1	10/11	0.93	0.16	54,68,77,86	0
14	FME	T	1	10/11	0.96	0.08	46,53,69,73	0

Continued on next page...

Continued from previous page...

Mol	Type	Chain	Res	Atoms	RSCC	RSR	B-factors(Å ²)	Q<0.9
12	FME	M	1	10/11	0.97	0.12	43,64,87,109	0
14	FME	t	1	10/11	0.97	0.09	45,48,65,80	0
12	FME	m	1	10/11	0.98	0.12	48,62,89,110	0
8	FME	I	1	10/11	0.98	0.07	59,67,78,85	0

6.3 Carbohydrates [i](#)

There are no monosaccharides in this entry.

6.4 Ligands [i](#)

In the following table, the Atoms column lists the number of modelled atoms in the group and the number defined in the chemical component dictionary. The B-factors column lists the minimum, median, 95th percentile and maximum values of B factors of atoms in the group. The column labelled 'Q< 0.9' lists the number of atoms with occupancy less than 0.9.

Mol	Type	Chain	Res	Atoms	RSCC	RSR	B-factors(Å ²)	Q<0.9
30	UNL	B	625	33/-	0.42	0.36	61,108,138,141	0
30	UNL	b	626	33/-	0.50	0.38	64,96,170,174	0
31	LMT	M	103	35/35	0.53	0.30	69,130,181,184	0
30	UNL	I	101	40/-	0.56	0.32	66,107,159,166	0
33	LMG	C	521	51/55	0.58	0.34	59,121,154,164	0
31	LMT	b	621	25/35	0.59	0.28	72,110,159,162	0
30	UNL	i	101	40/-	0.61	0.29	72,107,159,163	0
31	LMT	B	629	35/35	0.62	0.37	57,108,139,145	0
30	UNL	j	101	10/-	0.63	0.25	72,89,103,104	0
27	GOL	a	415	6/6	0.64	0.51	69,88,99,108	0
30	UNL	c	526[A]	32/-	0.65	0.40	97,112,129,132	32
30	UNL	c	526[B]	32/-	0.65	0.40	97,112,129,132	32
31	LMT	M	101	35/35	0.66	0.26	57,90,104,109	0
30	UNL	K	101[A]	34/-	0.67	0.36	85,106,123,126	34
30	UNL	K	101[B]	34/-	0.67	0.36	85,106,123,127	34
30	UNL	A	415	28/-	0.69	0.37	93,115,130,146	0
31	LMT	F	101	35/35	0.70	0.51	89,132,181,189	0
33	LMG	Z	101	37/55	0.70	0.30	65,125,151,166	0
30	UNL	x	101	18/-	0.71	0.23	64,77,119,131	0
31	LMT	B	630	25/35	0.71	0.23	55,83,149,173	0
30	UNL	a	413	30/-	0.72	0.33	91,117,135,149	0
31	LMT	m	103	35/35	0.72	0.26	62,86,103,106	0
30	UNL	d	410	36/-	0.72	0.19	70,91,130,143	0
33	LMG	c	522	51/55	0.72	0.28	76,135,166,173	0

Continued on next page...

Continued from previous page...

Mol	Type	Chain	Res	Atoms	RSCC	RSR	B-factors(Å ²)	Q<0.9
30	UNL	m	102	10/-	0.72	0.31	70,77,94,97	0
34	HTG	D	410	16/19	0.72	0.28	80,104,130,149	0
32	LHG	a	417[A]	42/49	0.73	0.37	87,142,151,156	42
32	LHG	a	417[B]	42/49	0.73	0.37	87,142,151,156	42
31	LMT	A	417	35/35	0.73	0.32	64,111,132,139	0
31	LMT	e	101	35/35	0.74	0.57	105,143,191,202	0
27	GOL	b	624	6/6	0.74	0.21	85,92,97,98	0
31	LMT	b	627	25/35	0.75	0.23	56,99,149,162	0
31	LMT	A	420	35/35	0.75	0.38	91,134,160,167	0
31	LMT	B	627	35/35	0.75	0.27	66,104,133,139	0
30	UNL	X	102	18/-	0.77	0.22	59,73,102,109	0
34	HTG	b	623	19/19	0.77	0.47	86,133,158,165	0
27	GOL	O	302	6/6	0.78	0.23	73,85,93,100	0
33	LMG	z	101	39/55	0.78	0.26	76,122,156,170	0
30	UNL	M	102	10/-	0.79	0.28	72,78,86,87	0
31	LMT	c	502	35/35	0.79	0.43	99,135,153,158	0
27	GOL	o	303	6/6	0.79	0.25	82,98,113,117	0
34	HTG	d	411	16/19	0.79	0.31	91,113,133,153	0
30	UNL	J	101	10/-	0.80	0.17	76,81,94,98	0
27	GOL	o	304	6/6	0.81	0.20	84,87,96,106	0
26	SQD	f	102	43/54	0.82	0.34	96,127,168,182	0
32	LHG	E	101[A]	42/49	0.82	0.26	70,102,119,127	42
32	LHG	E	101[B]	42/49	0.82	0.26	70,102,120,127	42
29	PL9	A	414[A]	55/55	0.82	0.23	70,94,112,116	55
29	PL9	A	414[B]	55/55	0.82	0.23	70,94,112,116	55
27	GOL	B	626	6/6	0.82	0.21	67,79,94,115	0
27	GOL	A	411	6/6	0.83	0.17	62,77,80,84	0
27	GOL	c	528	6/6	0.83	0.23	103,113,122,124	0
30	UNL	D	409	40/-	0.83	0.17	62,93,134,146	0
26	SQD	b	620	54/54	0.84	0.17	61,90,111,124	0
29	PL9	a	412[A]	55/55	0.84	0.22	82,105,120,125	55
34	HTG	c	523	19/19	0.84	0.27	104,126,144,148	0
29	PL9	a	412[B]	55/55	0.84	0.22	82,105,120,125	55
31	LMT	t	101	26/35	0.85	0.17	66,105,152,163	0
34	HTG	C	522	19/19	0.85	0.34	107,121,154,156	0
26	SQD	a	410	54/54	0.85	0.19	61,96,133,146	0
33	LMG	c	501	51/55	0.85	0.17	62,89,109,115	0
26	SQD	A	412	54/54	0.85	0.17	65,87,121,141	0
27	GOL	A	418	6/6	0.85	0.40	51,77,78,88	0
36	CA	F	103	1/1	0.85	0.20	123,123,123,123	0
33	LMG	C	501	51/55	0.86	0.16	66,89,113,123	0
27	GOL	a	416	6/6	0.86	0.44	57,74,81,82	0

Continued on next page...

Continued from previous page...

Mol	Type	Chain	Res	Atoms	RSCC	RSR	B-factors(Å ²)	Q<0.9
27	GOL	v	202[B]	6/6	0.87	0.15	67,78,84,84	6
34	HTG	b	622	19/19	0.87	0.16	60,85,107,122	0
26	SQD	B	620	54/54	0.87	0.15	57,89,120,138	0
25	BCR	C	515	40/40	0.87	0.14	63,74,89,91	0
34	HTG	B	622	19/19	0.87	0.25	67,88,107,120	0
34	HTG	o	301	19/19	0.87	0.16	56,84,108,111	0
27	GOL	v	202[A]	6/6	0.87	0.15	66,78,83,84	6
27	GOL	l	801[B]	6/6	0.88	0.71	69,97,103,105	6
27	GOL	l	801[A]	6/6	0.88	0.71	69,97,102,105	6
27	GOL	d	413	6/6	0.89	0.29	51,71,80,86	0
33	LMG	D	411	51/55	0.89	0.17	50,67,119,138	0
27	GOL	O	303	6/6	0.89	0.26	80,92,96,101	0
23	CLA	b	616	65/65	0.89	0.16	45,62,127,136	0
33	LMG	d	412	51/55	0.89	0.17	56,72,115,135	0
23	CLA	b	601	65/65	0.89	0.15	61,84,128,149	0
27	GOL	B	628	6/6	0.89	0.25	71,75,94,95	0
25	BCR	K	102	40/40	0.89	0.17	54,64,75,75	0
36	CA	f	103	1/1	0.89	0.07	121,121,121,121	0
27	GOL	D	412	6/6	0.90	0.22	50,64,75,85	0
23	CLA	B	601	65/65	0.90	0.14	54,74,116,147	0
23	CLA	c	515	65/65	0.90	0.16	66,88,128,143	0
27	GOL	V	203[A]	6/6	0.90	0.14	58,66,71,73	6
27	GOL	V	203[B]	6/6	0.90	0.14	58,66,71,74	6
25	BCR	h	101	40/40	0.90	0.14	53,69,85,87	0
33	LMG	c	521	51/55	0.90	0.18	59,92,124,153	0
23	CLA	C	514	65/65	0.91	0.13	60,80,114,122	0
23	CLA	c	514	65/65	0.91	0.16	61,79,125,135	0
25	BCR	Y	101	40/40	0.91	0.12	55,68,80,83	0
23	CLA	B	616	65/65	0.91	0.17	48,57,130,136	0
23	CLA	d	404	65/65	0.91	0.14	53,63,122,147	0
33	LMG	C	520	51/55	0.91	0.17	52,83,121,135	0
33	LMG	B	621	51/55	0.92	0.12	50,70,94,110	0
23	CLA	C	513	65/65	0.92	0.14	58,74,111,124	0
30	UNL	D	408	17/-	0.92	0.13	59,76,100,119	0
26	SQD	F	102	43/54	0.92	0.18	66,102,129,143	0
34	HTG	V	202	11/19	0.92	0.42	76,110,122,123	0
25	BCR	d	405	40/40	0.92	0.12	52,66,98,102	0
36	CA	o	302	1/1	0.92	0.08	103,103,103,103	0
23	CLA	b	606	65/65	0.93	0.12	44,56,108,125	0
23	CLA	C	507	65/65	0.93	0.13	57,69,125,136	0
35	DGD	H	101	62/66	0.93	0.12	48,61,73,78	0
35	DGD	c	519[A]	62/66	0.93	0.12	54,68,124,138	62

Continued on next page...

Continued from previous page...

Mol	Type	Chain	Res	Atoms	RSCC	RSR	B-factors(\AA^2)	Q<0.9
35	DGD	c	519[B]	62/66	0.93	0.12	54,68,124,138	62
35	DGD	h	102	62/66	0.93	0.12	53,64,73,78	0
33	LMG	m	101	51/55	0.93	0.11	50,72,93,115	0
34	HTG	b	625	19/19	0.93	0.10	62,76,95,98	0
23	CLA	B	606	65/65	0.93	0.13	43,55,121,129	0
23	CLA	B	609	65/65	0.94	0.14	49,58,69,80	0
34	HTG	B	624	19/19	0.94	0.10	67,78,94,96	0
35	DGD	C	518[A]	62/66	0.94	0.12	50,63,118,122	62
35	DGD	C	518[B]	62/66	0.94	0.12	49,63,118,122	62
35	DGD	C	519	62/66	0.94	0.11	45,59,98,111	0
23	CLA	C	509	65/65	0.94	0.10	46,56,116,136	0
23	CLA	D	403	65/65	0.94	0.13	47,58,119,130	0
25	BCR	D	404	40/40	0.94	0.10	47,61,105,111	0
35	DGD	c	520	62/66	0.94	0.11	51,63,104,131	0
30	UNL	d	409	17/-	0.94	0.12	63,80,111,112	0
23	CLA	c	508	65/65	0.94	0.12	54,71,122,133	0
23	CLA	a	407	65/65	0.94	0.16	46,55,138,152	0
25	BCR	b	618	40/40	0.94	0.10	45,57,74,78	0
25	BCR	A	409	40/40	0.95	0.10	39,53,63,66	0
23	CLA	a	405[A]	65/65	0.95	0.11	44,52,123,132	65
25	BCR	k	101	40/40	0.95	0.13	59,72,86,88	0
25	BCR	y	101	40/40	0.95	0.08	56,71,86,95	0
27	GOL	C	523[A]	6/6	0.95	0.14	57,59,60,66	6
27	GOL	C	523[B]	6/6	0.95	0.14	57,59,60,66	6
26	SQD	A	410[A]	54/54	0.95	0.14	58,78,116,119	54
26	SQD	A	410[B]	54/54	0.95	0.14	59,78,117,119	54
25	BCR	C	516	40/40	0.95	0.12	54,64,75,81	0
23	CLA	a	405[B]	65/65	0.95	0.11	43,53,123,132	65
23	CLA	C	505	65/65	0.95	0.09	42,56,103,124	0
23	CLA	B	611	65/65	0.95	0.10	35,47,64,71	0
36	CA	c	525	1/1	0.95	0.04	78,78,78,78	0
23	CLA	A	408	65/65	0.95	0.12	43,52,128,143	0
25	BCR	c	516	40/40	0.95	0.10	74,83,92,99	0
23	CLA	C	502	65/65	0.96	0.08	48,60,73,81	0
25	BCR	T	101	40/40	0.96	0.07	46,56,70,73	0
25	BCR	X	101	40/40	0.96	0.09	50,65,78,82	0
23	CLA	b	609	65/65	0.96	0.13	51,60,78,93	0
23	CLA	b	612	65/65	0.96	0.09	42,52,64,70	0
26	SQD	a	409[A]	54/54	0.96	0.13	62,81,121,124	54
26	SQD	a	409[B]	54/54	0.96	0.13	62,81,121,124	54
32	LHG	A	419[A]	49/49	0.96	0.12	50,62,83,89	49
32	LHG	A	419[B]	49/49	0.96	0.12	50,63,84,89	49

Continued on next page...

Continued from previous page...

Mol	Type	Chain	Res	Atoms	RSCC	RSR	B-factors(\AA^2)	Q<0.9
32	LHG	D	407[A]	49/49	0.96	0.15	51,60,106,112	49
32	LHG	D	407[B]	49/49	0.96	0.15	51,60,106,113	49
23	CLA	C	512	65/65	0.96	0.12	50,65,79,86	0
25	BCR	c	517	40/40	0.96	0.11	54,67,78,83	0
25	BCR	B	618	40/40	0.96	0.08	43,55,70,79	0
27	GOL	c	527[A]	6/6	0.96	0.30	62,66,67,70	6
32	LHG	b	629[A]	49/49	0.96	0.12	51,58,71,93	49
32	LHG	b	629[B]	49/49	0.96	0.12	51,58,71,93	49
32	LHG	d	407[A]	49/49	0.96	0.15	48,56,68,80	49
32	LHG	d	407[B]	49/49	0.96	0.15	48,56,68,80	49
32	LHG	d	408[A]	49/49	0.96	0.14	53,65,115,128	49
32	LHG	d	408[B]	49/49	0.96	0.14	53,65,115,128	49
35	DGD	c	518[A]	62/66	0.96	0.10	50,64,105,112	62
35	DGD	c	518[B]	62/66	0.96	0.10	50,64,105,112	62
32	LHG	d	414[A]	49/49	0.96	0.13	49,66,83,89	49
32	LHG	d	414[B]	49/49	0.96	0.13	49,66,83,89	49
27	GOL	c	527[B]	6/6	0.96	0.30	62,66,69,71	6
23	CLA	c	506	65/65	0.96	0.10	50,62,107,131	0
23	CLA	C	508	65/65	0.96	0.10	48,60,80,90	0
36	CA	c	524	1/1	0.96	0.05	74,74,74,74	0
27	GOL	B	623	6/6	0.96	0.21	70,82,87,88	0
25	BCR	t	102	40/40	0.96	0.08	39,59,75,79	0
23	CLA	c	510	65/65	0.96	0.11	44,62,129,146	0
38	HEM	f	101	43/43	0.96	0.13	62,80,114,125	0
25	BCR	b	617	40/40	0.97	0.08	47,54,64,70	0
23	CLA	b	611	65/65	0.97	0.09	42,49,72,81	0
25	BCR	b	619	40/40	0.97	0.08	51,63,84,87	0
27	GOL	b	628	6/6	0.97	0.21	77,82,88,92	0
23	CLA	C	510	65/65	0.97	0.10	50,59,82,87	0
23	CLA	b	614	65/65	0.97	0.09	41,51,102,113	0
23	CLA	b	615	65/65	0.97	0.10	44,57,81,89	0
23	CLA	C	511	65/65	0.97	0.08	49,60,80,86	0
23	CLA	c	503	65/65	0.97	0.10	52,66,77,88	0
23	CLA	c	505	65/65	0.97	0.08	51,67,78,87	0
23	CLA	B	612	65/65	0.97	0.07	37,49,62,70	0
23	CLA	c	507	65/65	0.97	0.09	49,61,89,102	0
23	CLA	B	614	65/65	0.97	0.10	41,51,103,120	0
23	CLA	c	509	65/65	0.97	0.09	54,66,81,89	0
23	CLA	B	603	65/65	0.97	0.10	41,53,72,79	0
23	CLA	c	511	65/65	0.97	0.09	49,61,87,93	0
29	PL9	D	405[A]	55/55	0.97	0.11	39,48,57,67	55
29	PL9	D	405[B]	55/55	0.97	0.11	38,48,57,67	55

Continued on next page...

Continued from previous page...

Mol	Type	Chain	Res	Atoms	RSCC	RSR	B-factors(\AA^2)	Q<0.9
23	CLA	c	513	65/65	0.97	0.10	56,67,82,90	0
23	CLA	A	406[A]	65/65	0.97	0.09	40,48,115,121	65
29	PL9	d	406[A]	55/55	0.97	0.10	40,50,59,69	55
35	DGD	C	517[A]	62/66	0.97	0.10	47,58,100,107	62
35	DGD	C	517[B]	62/66	0.97	0.10	46,58,100,107	62
29	PL9	d	406[B]	55/55	0.97	0.10	40,50,59,69	55
23	CLA	C	503	65/65	0.97	0.08	48,56,74,84	0
23	CLA	C	504	65/65	0.97	0.08	52,60,72,87	0
24	PHO	a	414[A]	64/64	0.97	0.11	46,54,60,66	64
24	PHO	a	414[B]	64/64	0.97	0.11	46,54,60,66	64
23	CLA	B	607	65/65	0.97	0.09	38,47,75,85	0
23	CLA	A	406[B]	65/65	0.97	0.09	40,48,115,121	65
25	BCR	B	619	40/40	0.97	0.08	47,62,87,94	0
23	CLA	b	602	65/65	0.97	0.12	48,60,78,87	0
23	CLA	b	604	65/65	0.97	0.10	42,51,101,112	0
36	CA	C	524	1/1	0.97	0.07	71,71,71,71	0
23	CLA	b	605	65/65	0.97	0.10	42,50,71,74	0
23	CLA	B	610	65/65	0.97	0.11	41,55,66,81	0
23	CLA	b	607	65/65	0.97	0.08	38,48,79,91	0
23	CLA	B	602	65/65	0.97	0.11	43,55,76,96	0
23	CLA	b	610	65/65	0.97	0.08	48,56,70,77	0
25	BCR	a	408	40/40	0.97	0.07	45,53,64,69	0
40	HEC	v	201	43/43	0.97	0.11	50,62,70,75	0
23	CLA	c	504	65/65	0.98	0.08	45,59,86,106	0
23	CLA	A	405[A]	65/65	0.98	0.09	35,44,55,66	65
23	CLA	B	615	65/65	0.98	0.10	41,52,77,89	0
23	CLA	b	603	65/65	0.98	0.07	45,55,76,89	0
23	CLA	A	405[B]	65/65	0.98	0.09	35,44,55,66	65
23	CLA	B	608	65/65	0.98	0.07	42,52,66,76	0
23	CLA	A	404[A]	65/65	0.98	0.11	38,43,60,67	65
32	LHG	D	406[A]	49/49	0.98	0.13	47,54,65,78	49
32	LHG	D	406[B]	49/49	0.98	0.13	47,54,65,78	49
23	CLA	A	404[B]	65/65	0.98	0.11	38,43,60,67	65
23	CLA	c	512	65/65	0.98	0.09	49,63,78,94	0
23	CLA	b	608	65/65	0.98	0.07	45,56,76,83	0
23	CLA	D	402[A]	65/65	0.98	0.12	35,43,68,76	65
32	LHG	L	101[A]	49/49	0.98	0.11	49,57,70,88	49
32	LHG	L	101[B]	49/49	0.98	0.11	49,57,70,88	49
23	CLA	D	402[B]	65/65	0.98	0.12	35,43,68,77	65
23	CLA	d	402[A]	65/65	0.98	0.07	40,45,61,73	65
23	CLA	d	402[B]	65/65	0.98	0.07	40,45,61,73	65
23	CLA	d	403[A]	65/65	0.98	0.11	40,47,73,87	65

Continued on next page...

Continued from previous page...

Mol	Type	Chain	Res	Atoms	RSCC	RSR	B-factors(\AA^2)	Q<0.9
23	CLA	d	403[B]	65/65	0.98	0.11	40,47,73,87	65
23	CLA	B	604	65/65	0.98	0.09	37,47,107,124	0
24	PHO	A	407[A]	64/64	0.98	0.08	39,45,50,53	64
24	PHO	A	407[B]	64/64	0.98	0.08	39,45,50,53	64
24	PHO	A	416[A]	64/64	0.98	0.10	42,51,57,62	64
24	PHO	A	416[B]	64/64	0.98	0.10	42,51,57,62	64
24	PHO	a	406[A]	64/64	0.98	0.08	42,48,53,57	64
24	PHO	a	406[B]	64/64	0.98	0.08	42,48,53,57	64
23	CLA	a	404[A]	65/65	0.98	0.13	41,47,64,78	65
36	CA	O	301	1/1	0.98	0.11	103,103,103,103	0
23	CLA	b	613	65/65	0.98	0.08	42,50,89,101	0
23	CLA	a	404[B]	65/65	0.98	0.13	41,47,65,79	65
25	BCR	B	617	40/40	0.98	0.09	43,52,63,67	0
23	CLA	C	506	65/65	0.98	0.08	49,57,91,103	0
37	BCT	d	401[A]	4/4	0.98	0.07	55,57,64,73	4
37	BCT	d	401[B]	4/4	0.98	0.07	56,57,65,74	4
38	HEM	E	102	43/43	0.98	0.09	57,67,78,91	0
23	CLA	B	605	65/65	0.98	0.10	39,49,67,80	0
40	HEC	V	201	43/43	0.98	0.12	41,51,57,61	0
23	CLA	B	613	65/65	0.98	0.08	38,47,96,106	0
37	BCT	D	401[A]	4/4	0.99	0.12	54,55,59,64	4
37	BCT	D	401[B]	4/4	0.99	0.12	54,55,59,65	4
22	CL	a	402[A]	1/1	0.99	0.05	49,49,49,49	1
22	CL	a	402[B]	1/1	0.99	0.05	50,50,50,50	1
28	OEX	A	413[A]	10/10	0.99	0.05	42,44,49,50	10
28	OEX	A	413[B]	10/10	0.99	0.05	41,44,50,50	10
39	MG	J	102	1/1	0.99	0.02	59,59,59,59	0
39	MG	j	102	1/1	0.99	0.04	62,62,62,62	0
22	CL	A	403[A]	1/1	0.99	0.04	47,47,47,47	1
22	CL	A	403[B]	1/1	0.99	0.04	47,47,47,47	1
22	CL	a	403[A]	1/1	1.00	0.03	52,52,52,52	1
22	CL	a	403[B]	1/1	1.00	0.03	52,52,52,52	1
22	CL	A	402[A]	1/1	1.00	0.02	43,43,43,43	1
22	CL	A	402[B]	1/1	1.00	0.02	42,42,42,42	1
28	OEX	a	411[A]	10/10	1.00	0.06	46,49,50,56	10
28	OEX	a	411[B]	10/10	1.00	0.06	46,49,50,56	10
21	FE2	A	401[A]	1/1	1.00	0.05	51,51,51,51	1
21	FE2	A	401[B]	1/1	1.00	0.05	51,51,51,51	1
21	FE2	a	401[A]	1/1	1.00	0.05	53,53,53,53	1
21	FE2	a	401[B]	1/1	1.00	0.05	53,53,53,53	1

The following is a graphical depiction of the model fit to experimental electron density of all instances of the Ligand of Interest. In addition, ligands with molecular weight > 250 and outliers

as shown on the geometry validation Tables will also be included. Each fit is shown from different orientation to approximate a three-dimensional view.

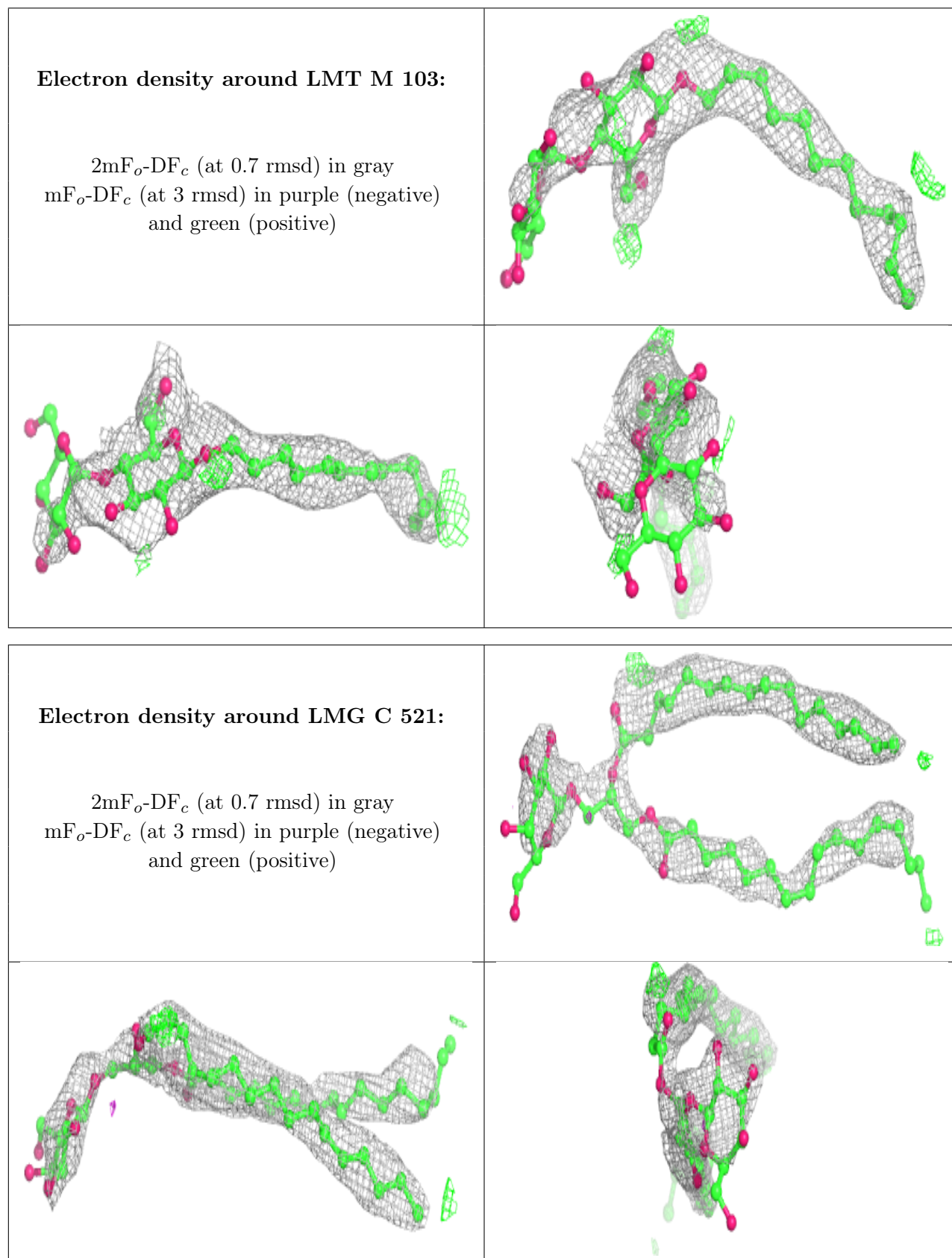

Electron density around LMT b 621:

$2mF_o-DF_c$ (at 0.7 rmsd) in gray
 mF_o-DF_c (at 3 rmsd) in purple (negative)
and green (positive)

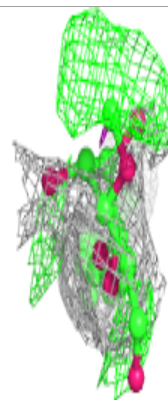
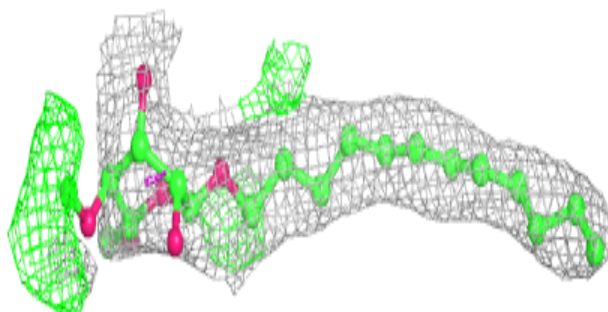
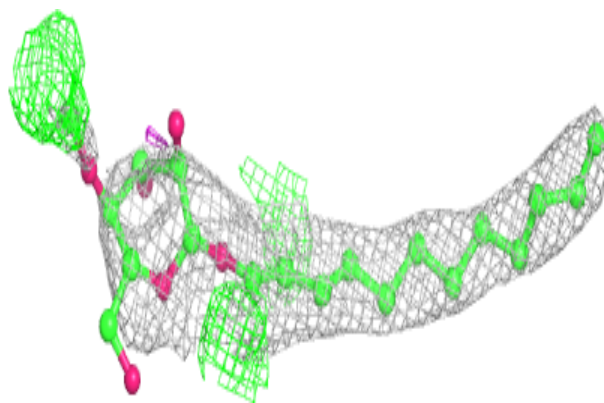
**Electron density around LMT B 629:**

$2mF_o-DF_c$ (at 0.7 rmsd) in gray
 mF_o-DF_c (at 3 rmsd) in purple (negative)
and green (positive)

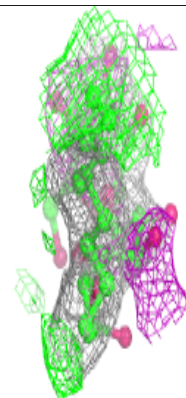
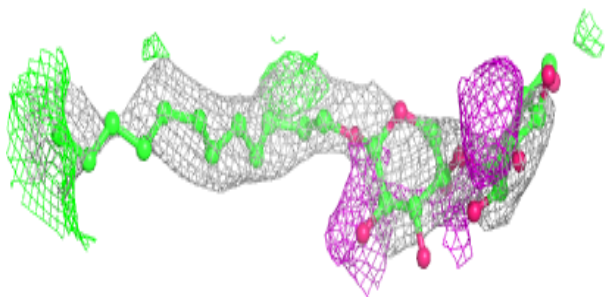
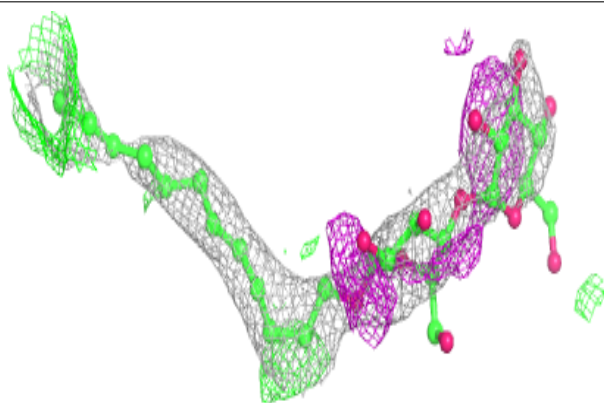

Electron density around UNL c 526 (A):

$2mF_o-DF_c$ (at 0.7 rmsd) in gray
 mF_o-DF_c (at 3 rmsd) in purple (negative)
and green (positive)

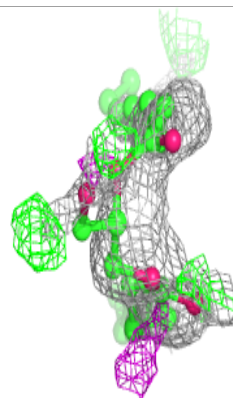
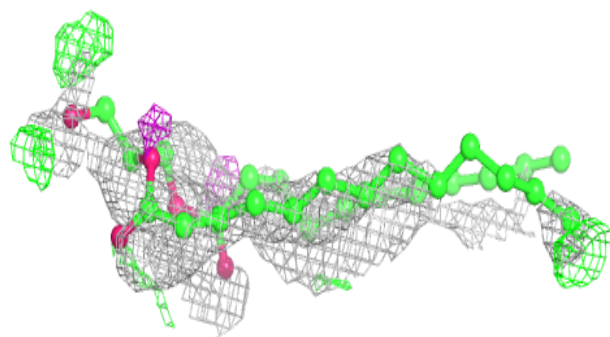
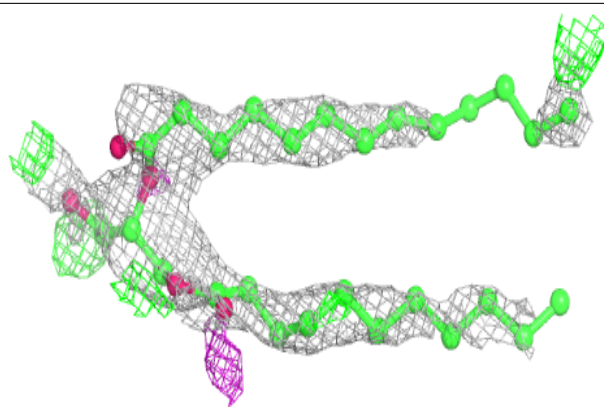
**Electron density around UNL c 526 (B):**

$2mF_o-DF_c$ (at 0.7 rmsd) in gray
 mF_o-DF_c (at 3 rmsd) in purple (negative)
and green (positive)

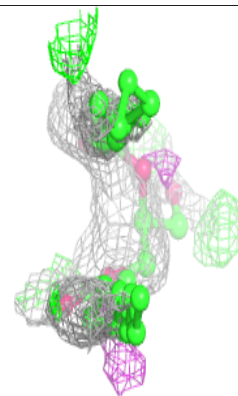
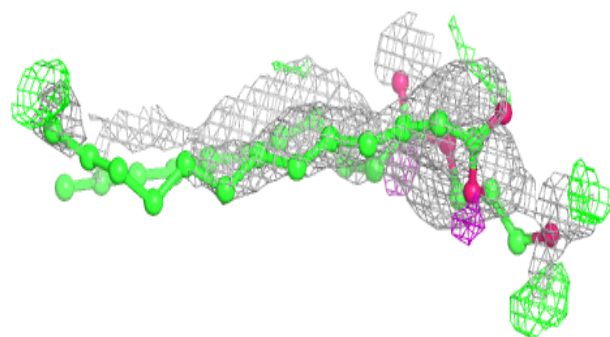
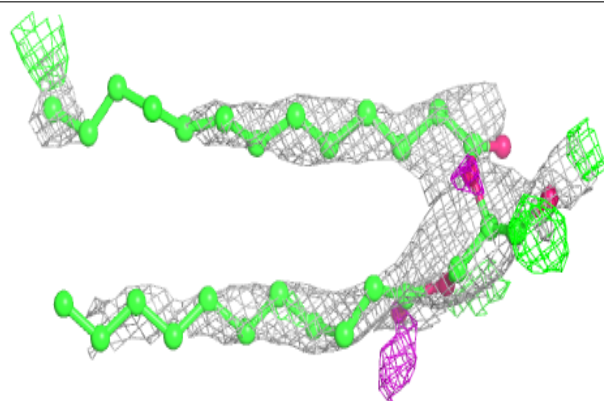

Electron density around LMT M 101:

$2mF_o-DF_c$ (at 0.7 rmsd) in gray
 mF_o-DF_c (at 3 rmsd) in purple (negative)
and green (positive)

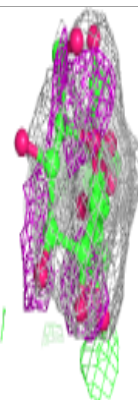
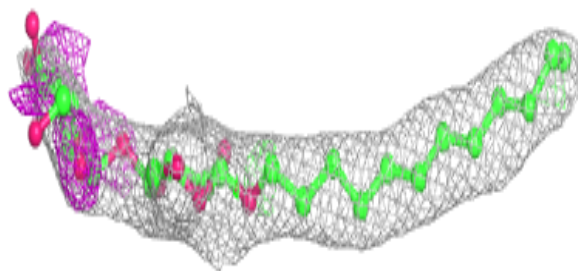
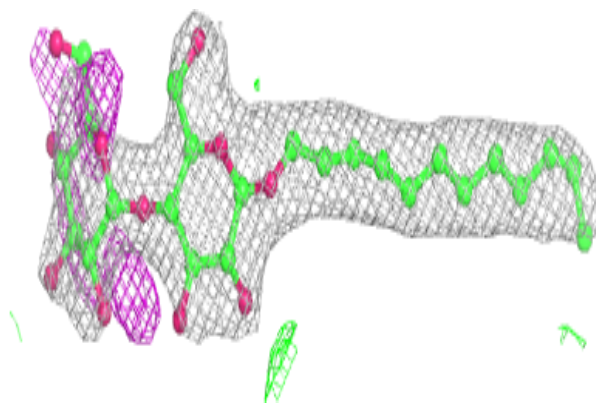
**Electron density around LMT F 101:**

$2mF_o-DF_c$ (at 0.7 rmsd) in gray
 mF_o-DF_c (at 3 rmsd) in purple (negative)
and green (positive)

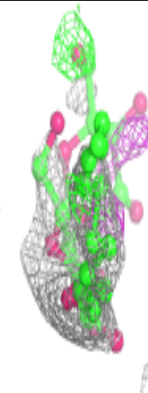
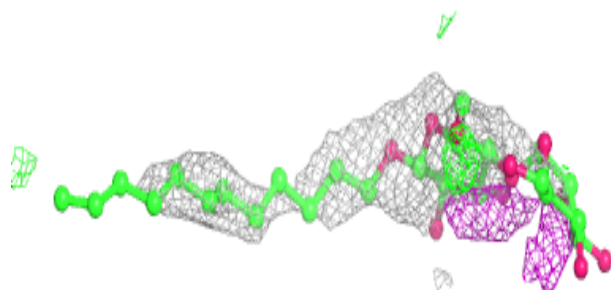
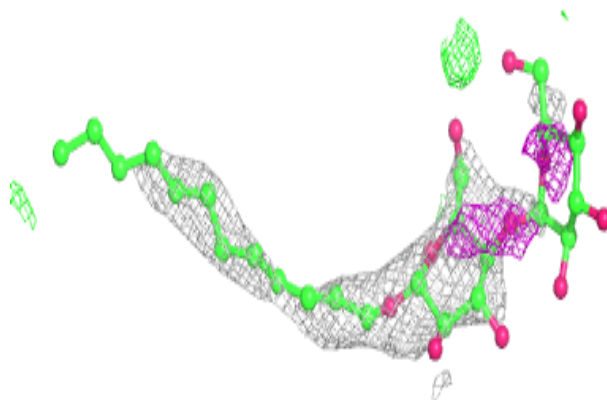

Electron density around LMG Z 101:

$2mF_o-DF_c$ (at 0.7 rmsd) in gray
 mF_o-DF_c (at 3 rmsd) in purple (negative)
and green (positive)

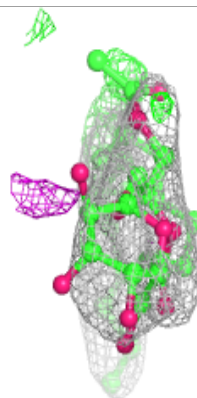
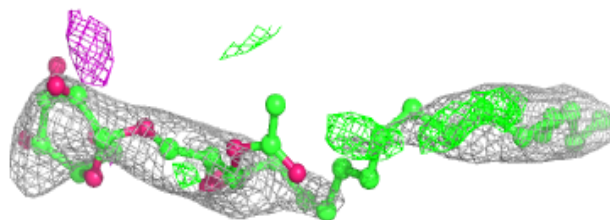
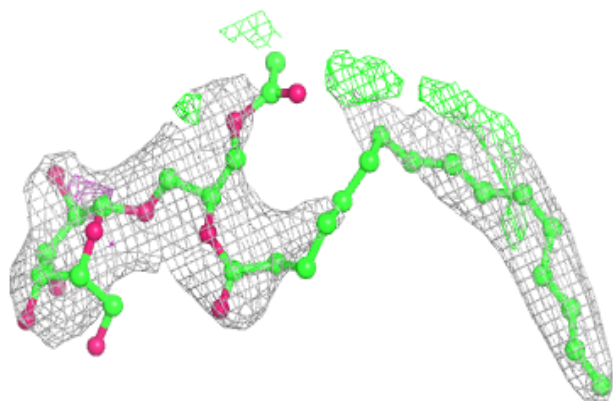
**Electron density around LMT B 630:**

$2mF_o-DF_c$ (at 0.7 rmsd) in gray
 mF_o-DF_c (at 3 rmsd) in purple (negative)
and green (positive)

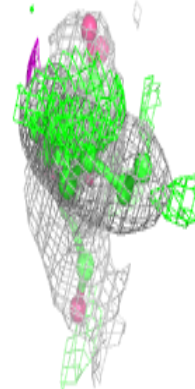
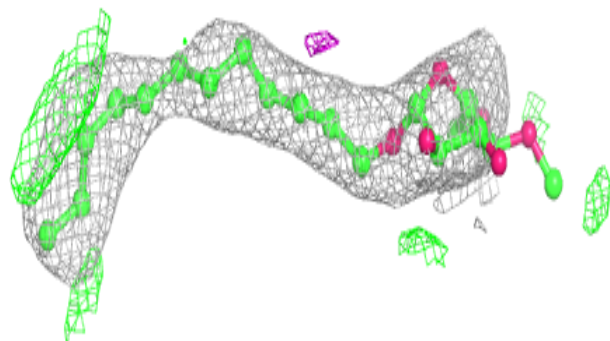
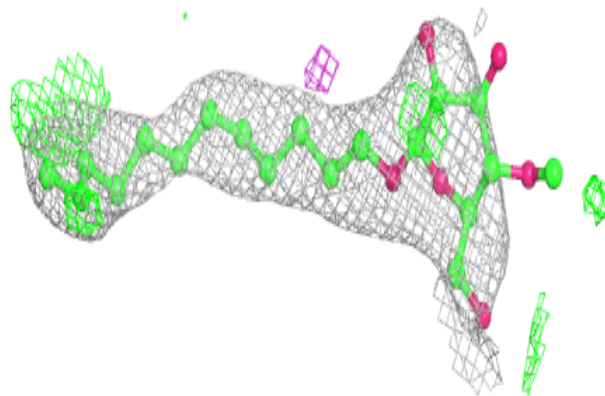

Electron density around LMT m 103:

$2mF_o-DF_c$ (at 0.7 rmsd) in gray
 mF_o-DF_c (at 3 rmsd) in purple (negative)
and green (positive)

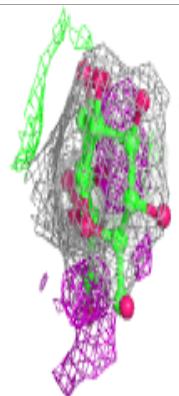
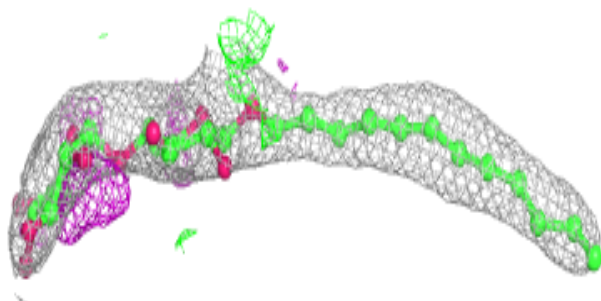
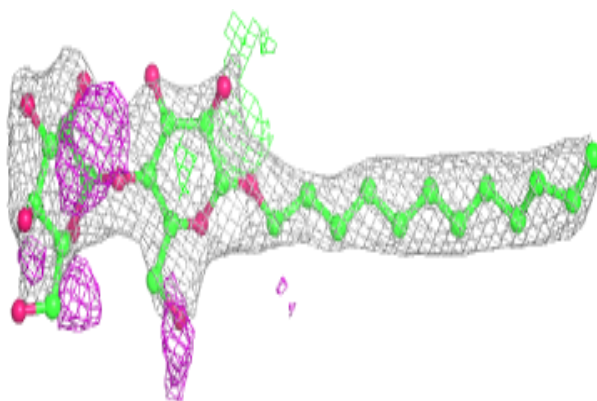
**Electron density around LMG c 522:**

$2mF_o-DF_c$ (at 0.7 rmsd) in gray
 mF_o-DF_c (at 3 rmsd) in purple (negative)
and green (positive)

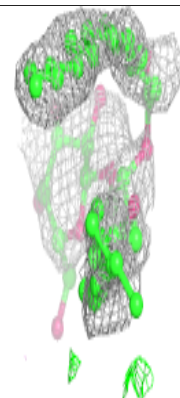
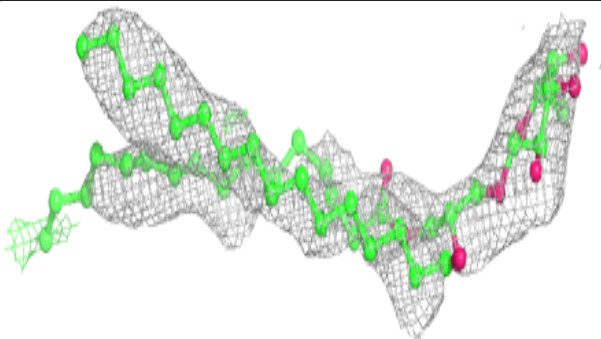
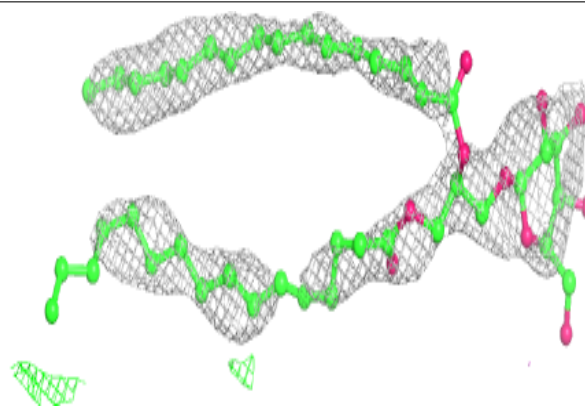

Electron density around HTG D 410:

$2mF_o-DF_c$ (at 0.7 rmsd) in gray
 mF_o-DF_c (at 3 rmsd) in purple (negative)
and green (positive)

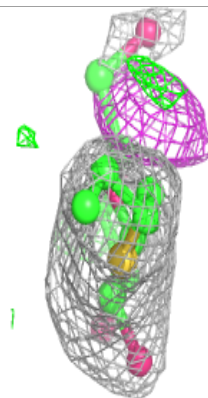
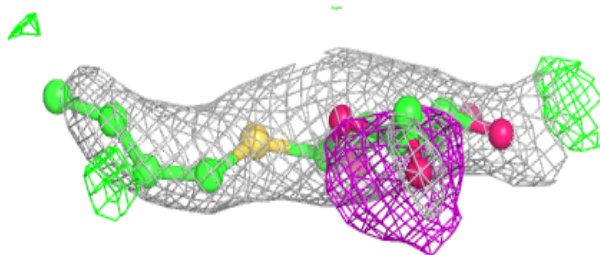
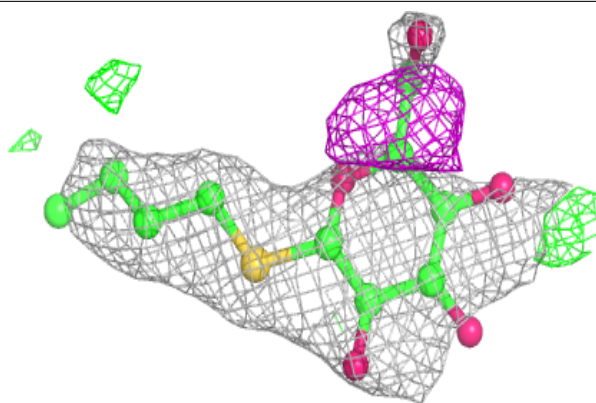
**Electron density around LHG a 417 (A):**

$2mF_o-DF_c$ (at 0.7 rmsd) in gray
 mF_o-DF_c (at 3 rmsd) in purple (negative)
and green (positive)

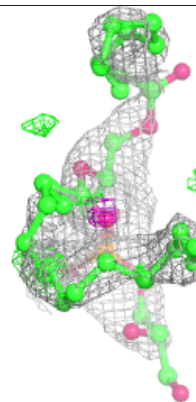
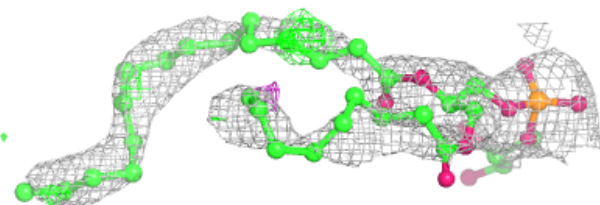
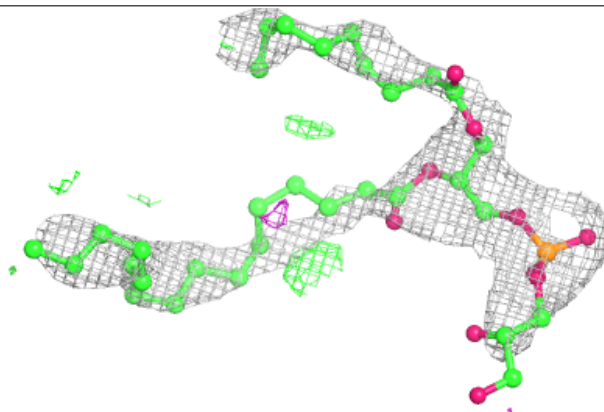

Electron density around LHG a 417 (B):

$2mF_o-DF_c$ (at 0.7 rmsd) in gray
 mF_o-DF_c (at 3 rmsd) in purple (negative)
and green (positive)

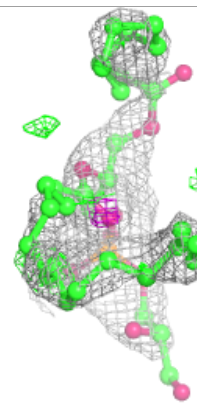
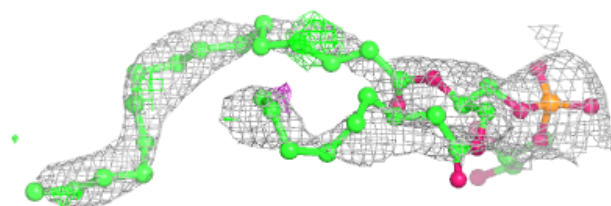
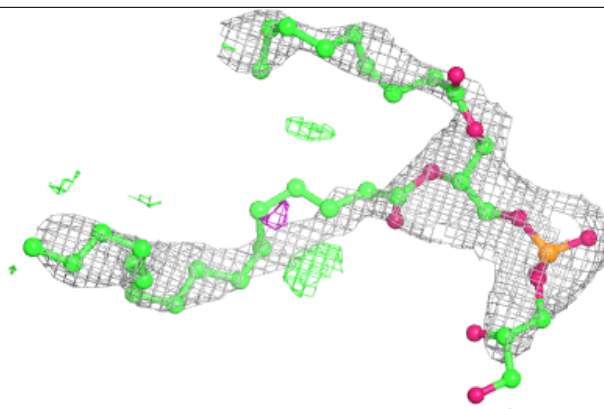
**Electron density around LMT A 417:**

$2mF_o-DF_c$ (at 0.7 rmsd) in gray
 mF_o-DF_c (at 3 rmsd) in purple (negative)
and green (positive)

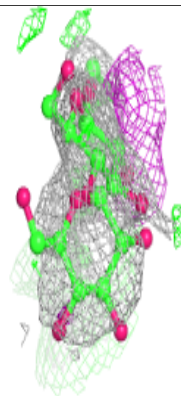
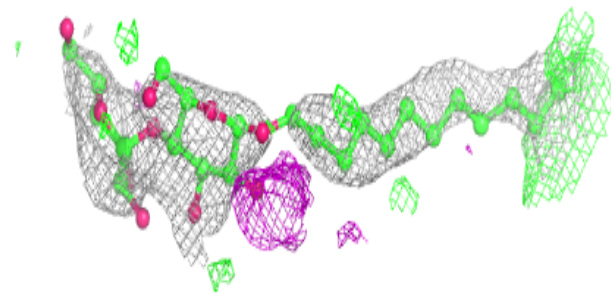
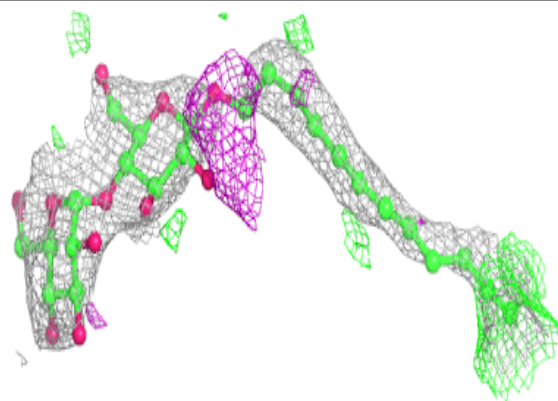

Electron density around LMT e 101:

$2mF_o-DF_c$ (at 0.7 rmsd) in gray
 mF_o-DF_c (at 3 rmsd) in purple (negative)
and green (positive)

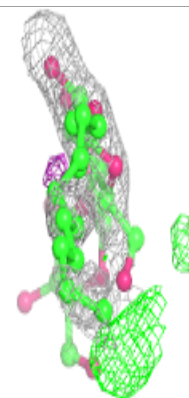
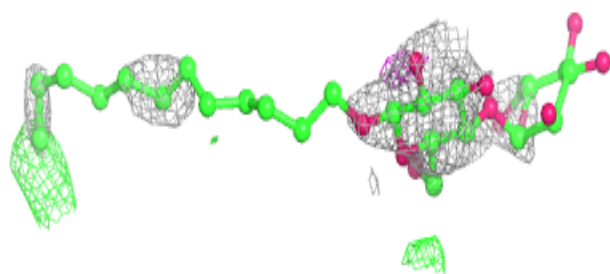
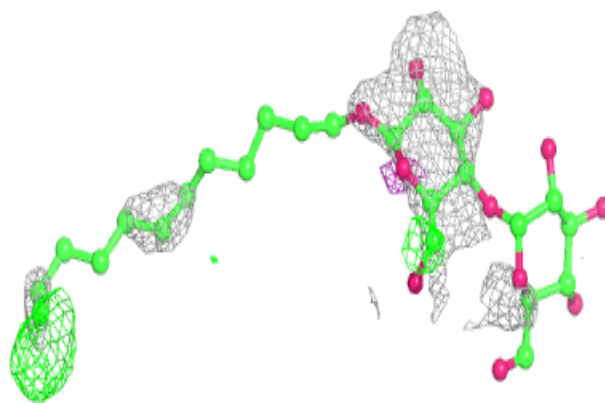
**Electron density around LMT b 627:**

$2mF_o-DF_c$ (at 0.7 rmsd) in gray
 mF_o-DF_c (at 3 rmsd) in purple (negative)
and green (positive)

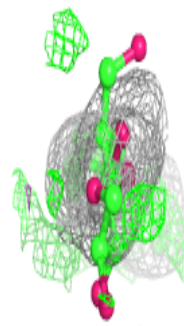
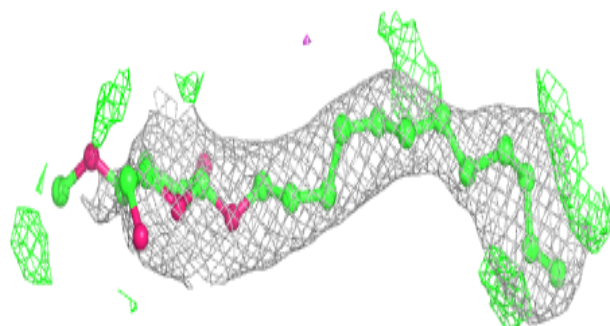
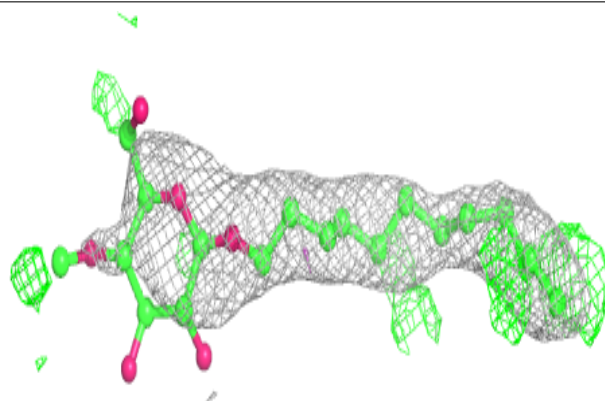

Electron density around LMT A 420:

$2mF_o-DF_c$ (at 0.7 rmsd) in gray
 mF_o-DF_c (at 3 rmsd) in purple (negative)
and green (positive)

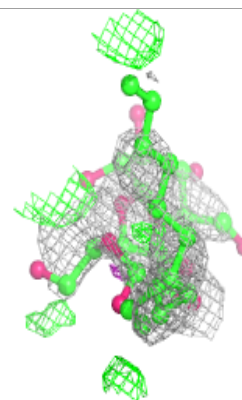
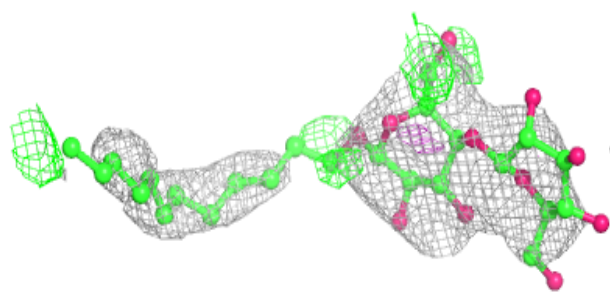
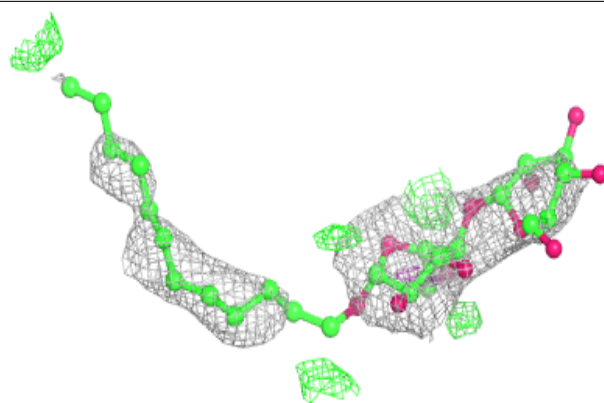
**Electron density around LMT B 627:**

$2mF_o-DF_c$ (at 0.7 rmsd) in gray
 mF_o-DF_c (at 3 rmsd) in purple (negative)
and green (positive)

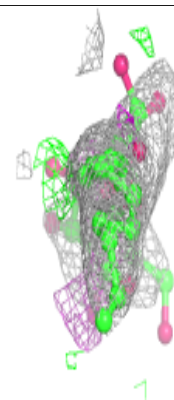
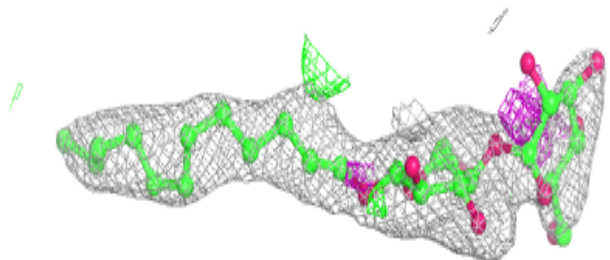
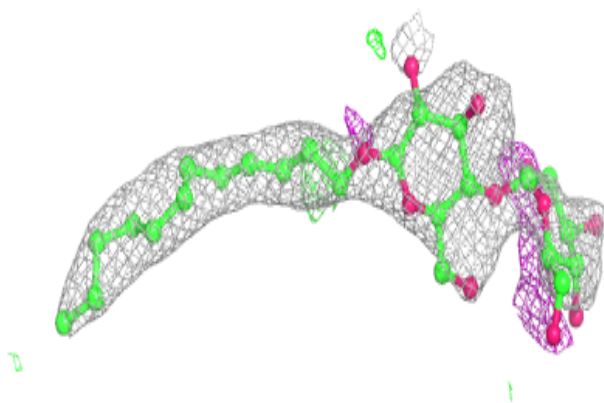

Electron density around HTG b 623:

$2mF_o-DF_c$ (at 0.7 rmsd) in gray
 mF_o-DF_c (at 3 rmsd) in purple (negative)
and green (positive)

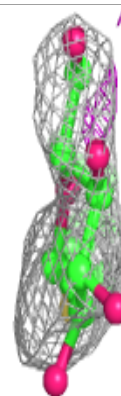
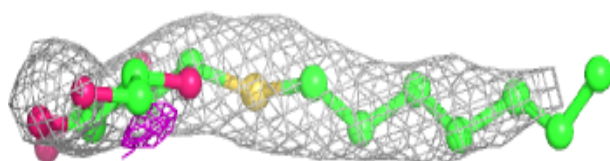
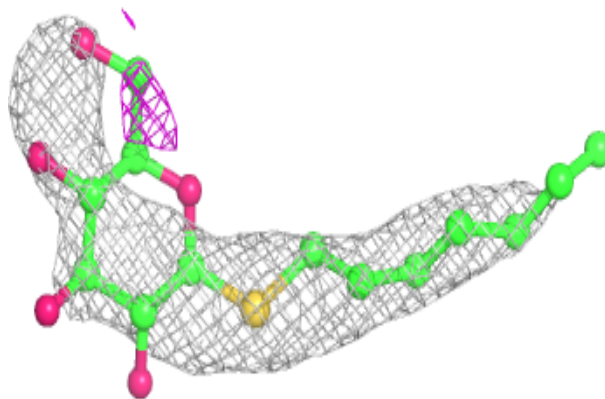
**Electron density around LMG z 101:**

$2mF_o-DF_c$ (at 0.7 rmsd) in gray
 mF_o-DF_c (at 3 rmsd) in purple (negative)
and green (positive)

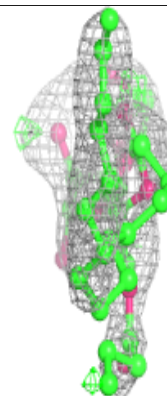
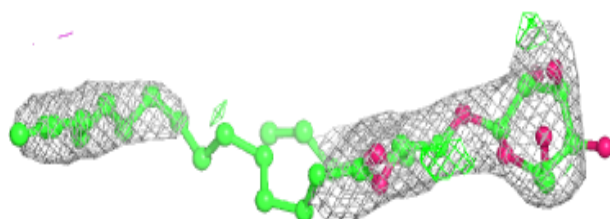
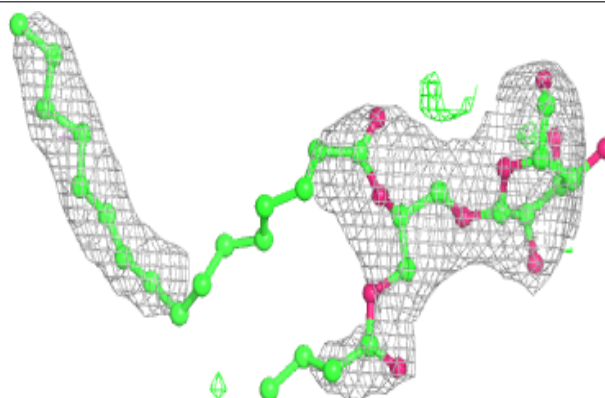

Electron density around LMT c 502:

$2mF_o-DF_c$ (at 0.7 rmsd) in gray
 mF_o-DF_c (at 3 rmsd) in purple (negative)
and green (positive)

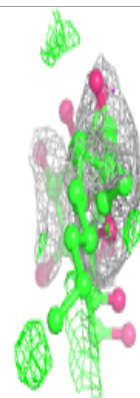
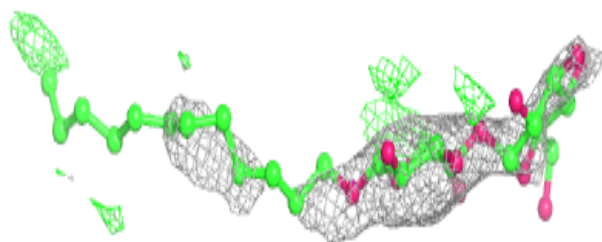
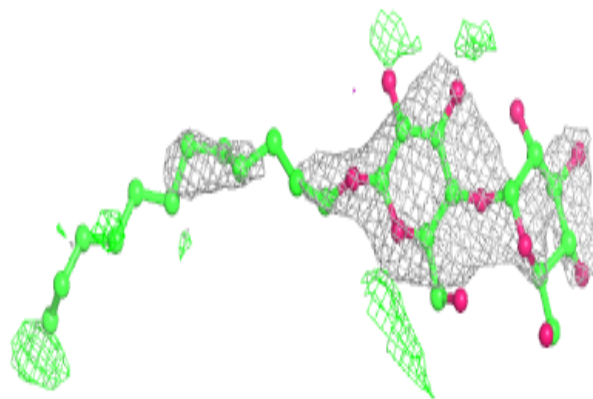
**Electron density around HTG d 411:**

$2mF_o-DF_c$ (at 0.7 rmsd) in gray
 mF_o-DF_c (at 3 rmsd) in purple (negative)
and green (positive)

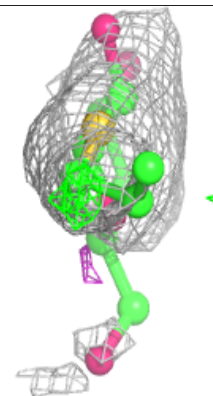
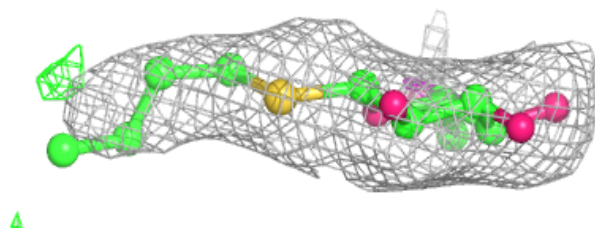
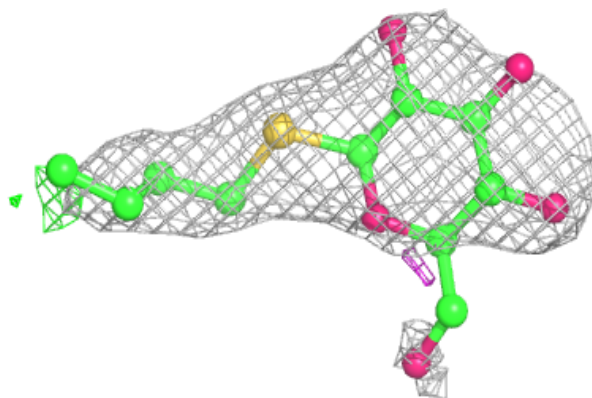

Electron density around SQD f 102:

$2mF_o-DF_c$ (at 0.7 rmsd) in gray
 mF_o-DF_c (at 3 rmsd) in purple (negative)
and green (positive)

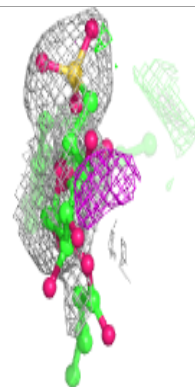
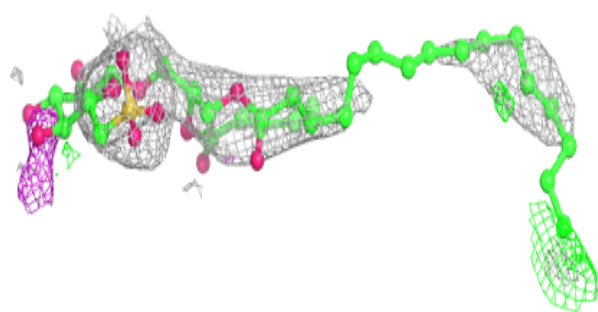
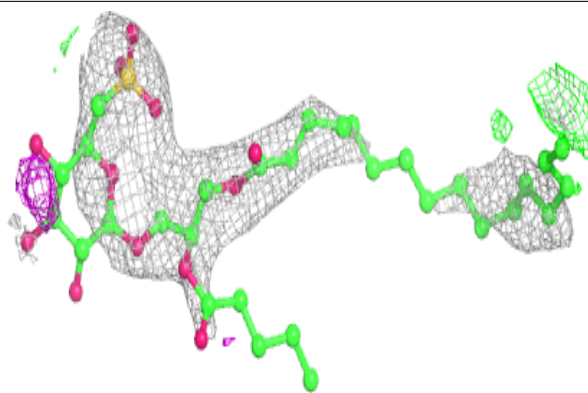
**Electron density around LHG E 101 (A):**

$2mF_o-DF_c$ (at 0.7 rmsd) in gray
 mF_o-DF_c (at 3 rmsd) in purple (negative)
and green (positive)

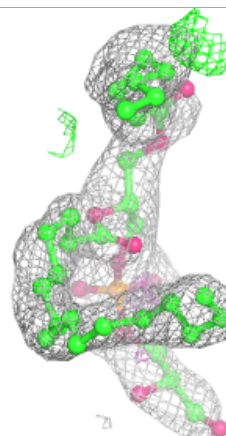
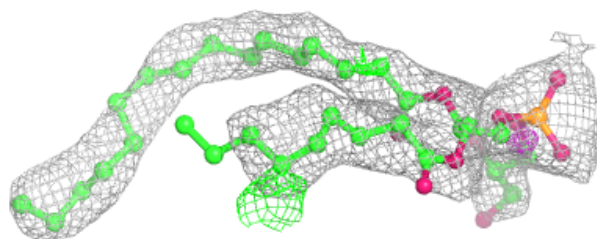
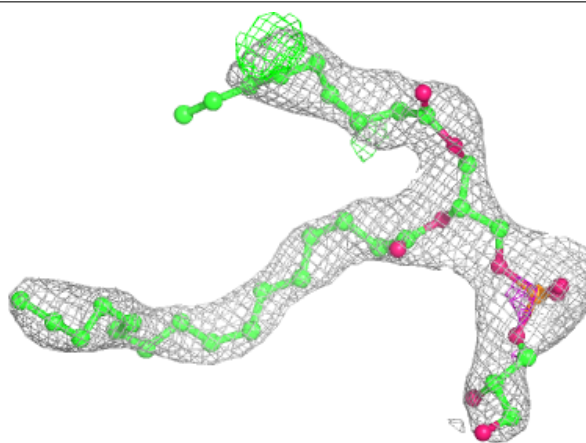

Electron density around LHG E 101 (B):

$2mF_o-DF_c$ (at 0.7 rmsd) in gray
 mF_o-DF_c (at 3 rmsd) in purple (negative)
and green (positive)

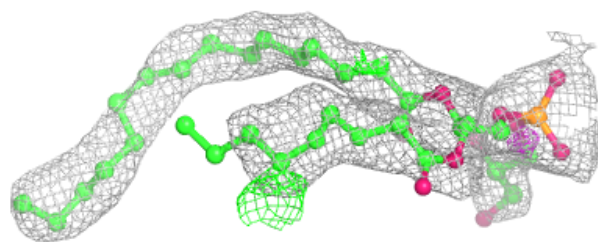
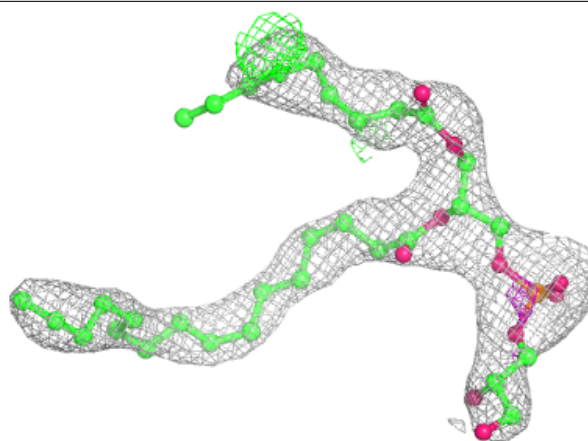
**Electron density around PL9 A 414 (A):**

$2mF_o-DF_c$ (at 0.7 rmsd) in gray
 mF_o-DF_c (at 3 rmsd) in purple (negative)
and green (positive)

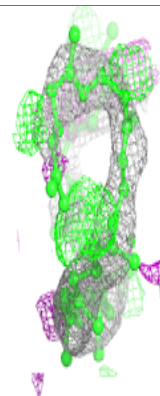
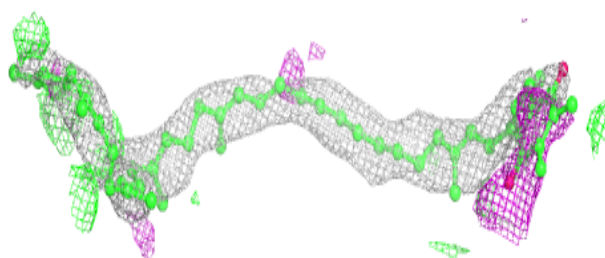
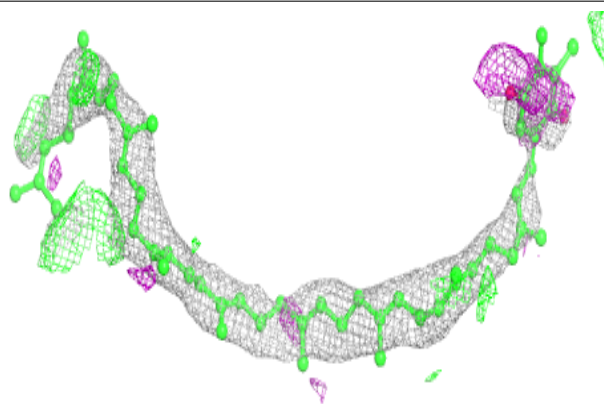

Electron density around PL9 A 414 (B):

$2mF_o-DF_c$ (at 0.7 rmsd) in gray
 mF_o-DF_c (at 3 rmsd) in purple (negative)
and green (positive)

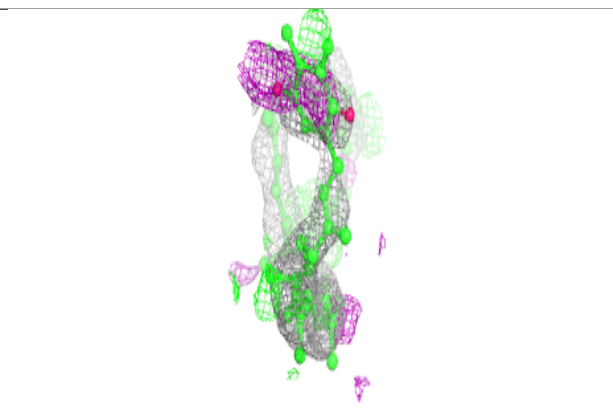
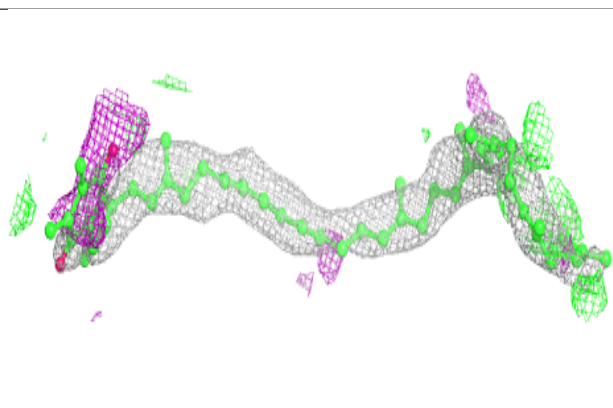
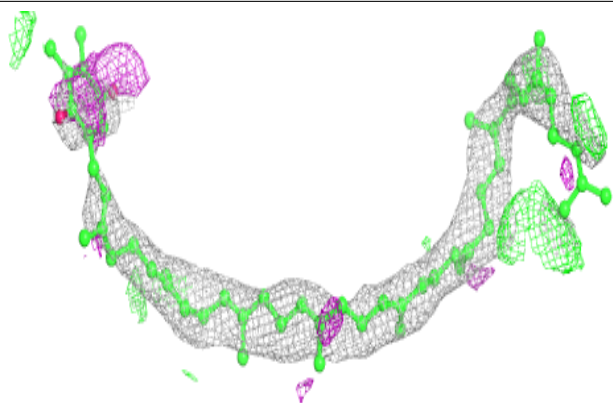
**Electron density around SQD b 620:**

$2mF_o-DF_c$ (at 0.7 rmsd) in gray
 mF_o-DF_c (at 3 rmsd) in purple (negative)
and green (positive)

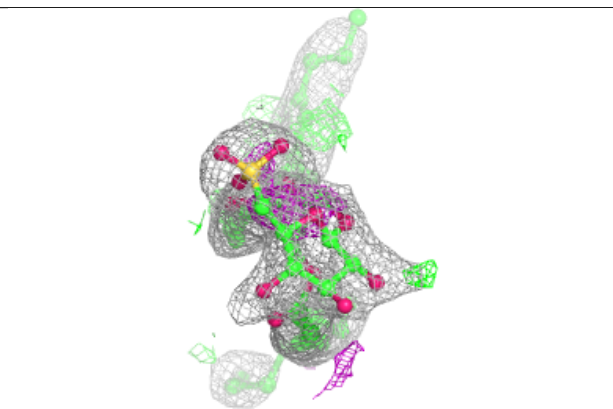
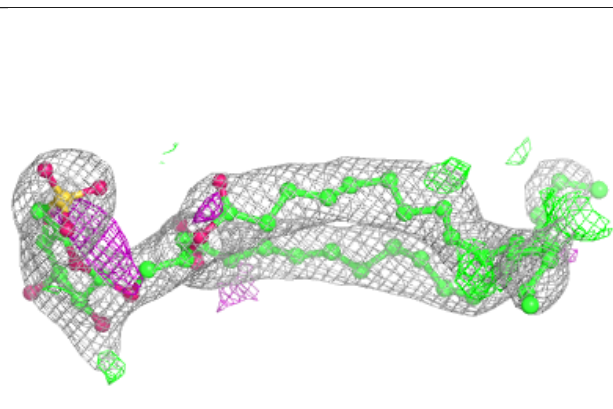
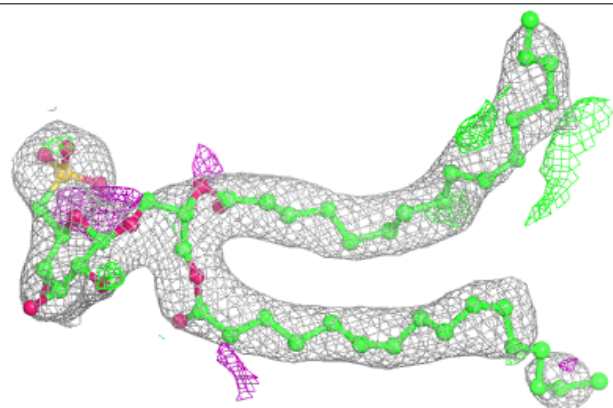

Electron density around PL9 a 412 (A):

$2mF_o-DF_c$ (at 0.7 rnsd) in gray
 mF_o-DF_c (at 3 rnsd) in purple (negative)
and green (positive)

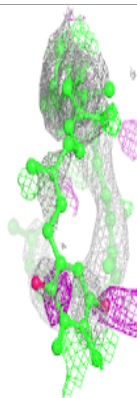
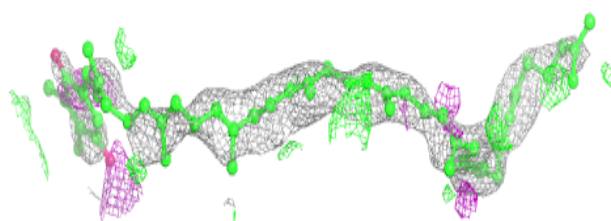
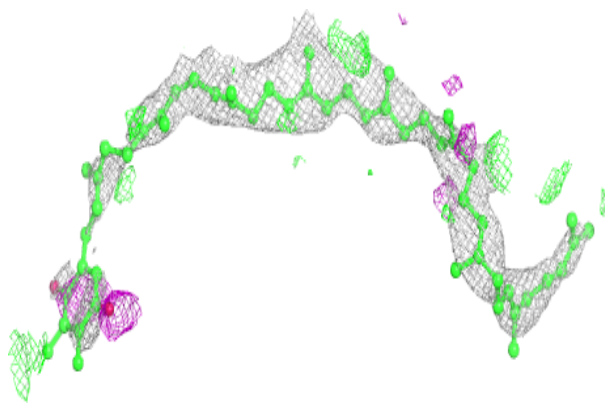
**Electron density around HTG c 523:**

$2mF_o-DF_c$ (at 0.7 rnsd) in gray
 mF_o-DF_c (at 3 rnsd) in purple (negative)
and green (positive)

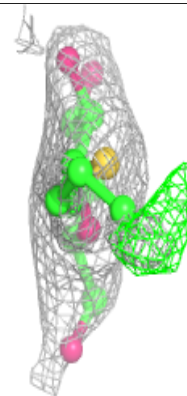
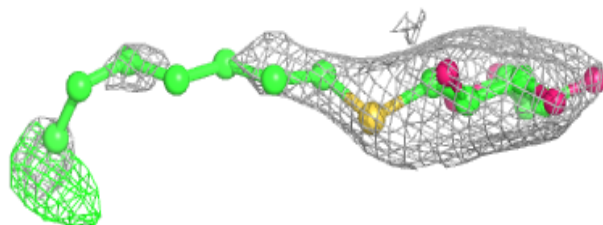
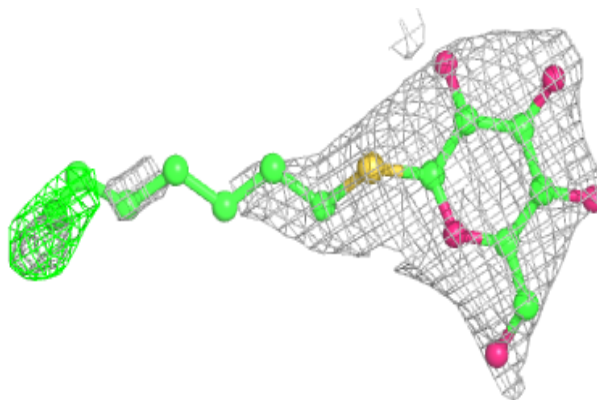

Electron density around PL9 a 412 (B):

$2mF_o-DF_c$ (at 0.7 rmsd) in gray
 mF_o-DF_c (at 3 rmsd) in purple (negative)
and green (positive)

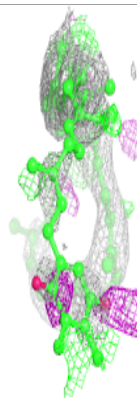
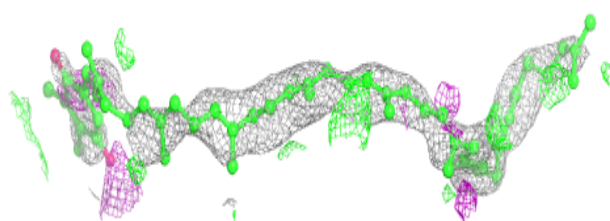
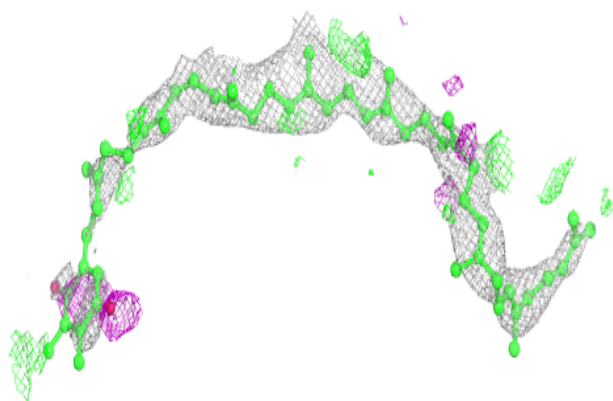
**Electron density around LMT t 101:**

$2mF_o-DF_c$ (at 0.7 rmsd) in gray
 mF_o-DF_c (at 3 rmsd) in purple (negative)
and green (positive)

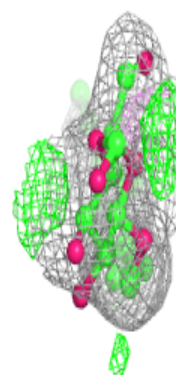
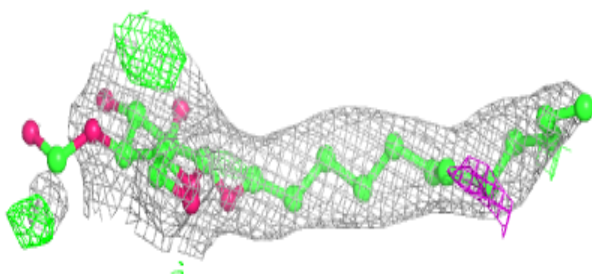
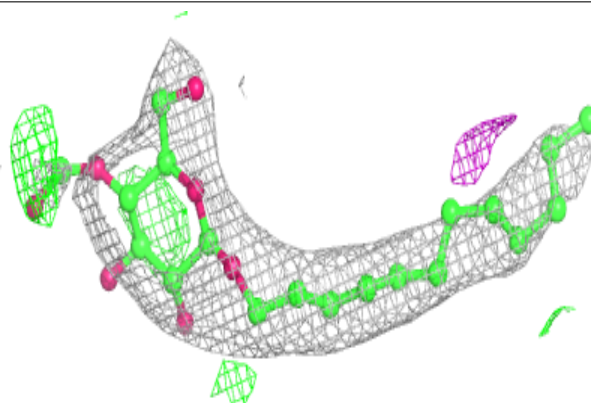

Electron density around HTG C 522:

$2mF_o-DF_c$ (at 0.7 rmsd) in gray
 mF_o-DF_c (at 3 rmsd) in purple (negative)
and green (positive)

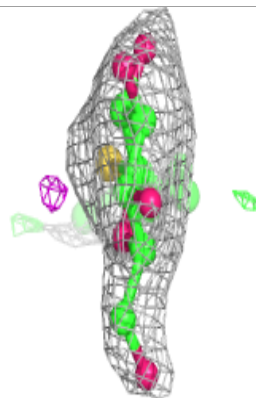
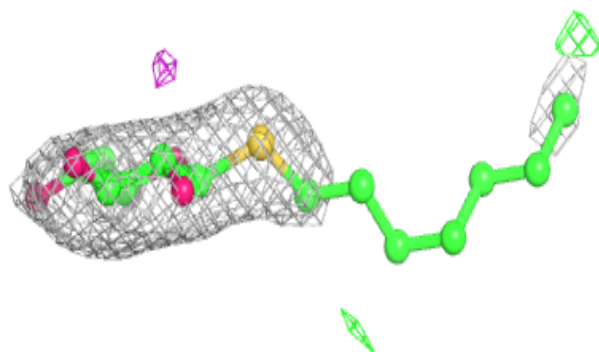
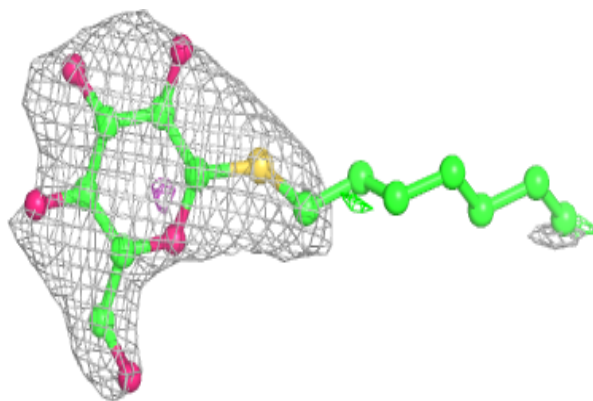
**Electron density around SQD a 410:**

$2mF_o-DF_c$ (at 0.7 rmsd) in gray
 mF_o-DF_c (at 3 rmsd) in purple (negative)
and green (positive)

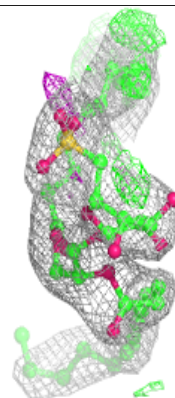
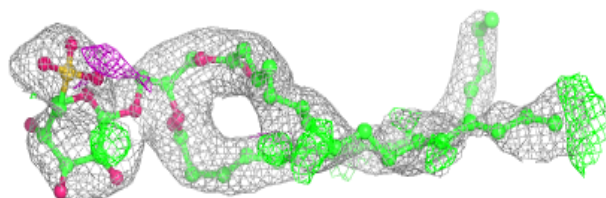
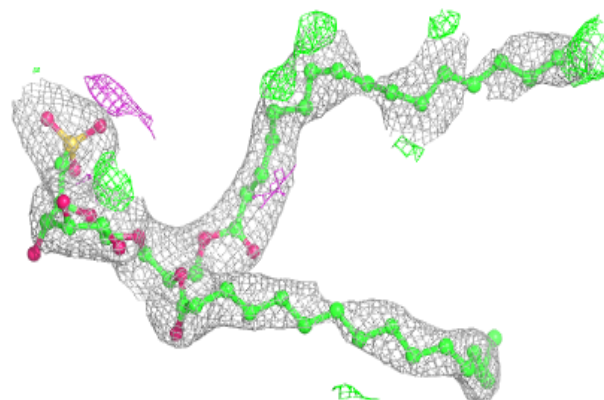

Electron density around LMG c 501:

$2mF_o-DF_c$ (at 0.7 rmsd) in gray
 mF_o-DF_c (at 3 rmsd) in purple (negative)
and green (positive)

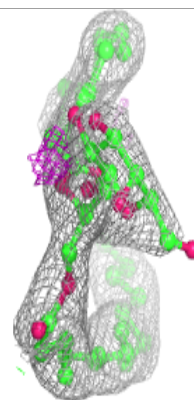
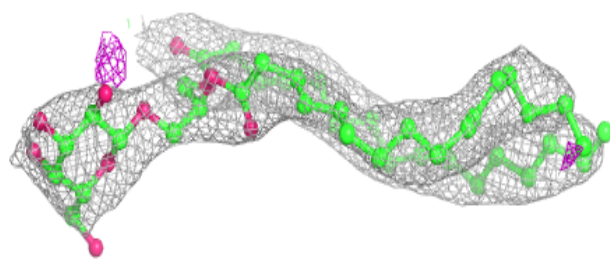
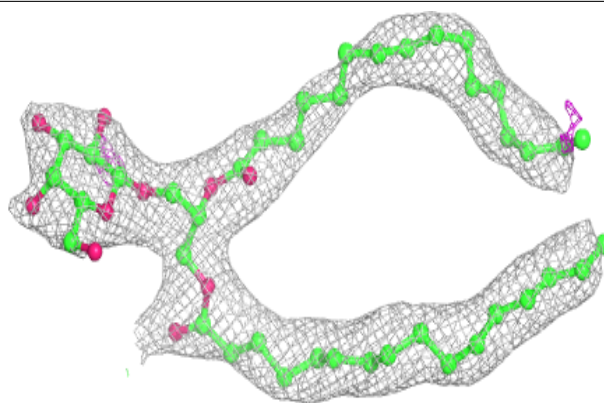
**Electron density around SQD A 412:**

$2mF_o-DF_c$ (at 0.7 rmsd) in gray
 mF_o-DF_c (at 3 rmsd) in purple (negative)
and green (positive)

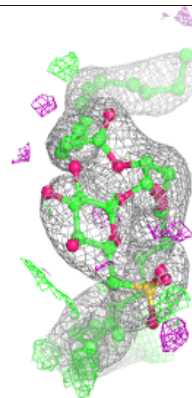
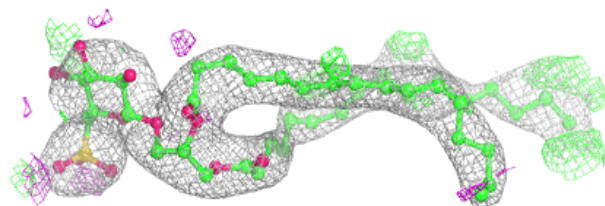
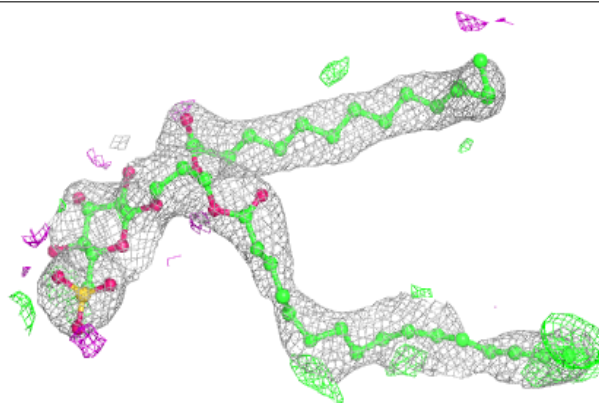

Electron density around LMG C 501:

$2mF_o-DF_c$ (at 0.7 rnsd) in gray
 mF_o-DF_c (at 3 rnsd) in purple (negative)
and green (positive)

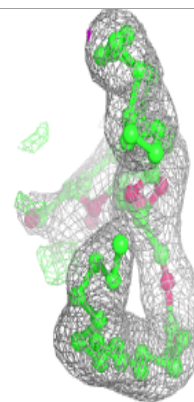
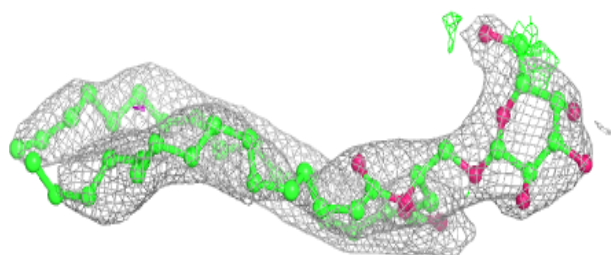
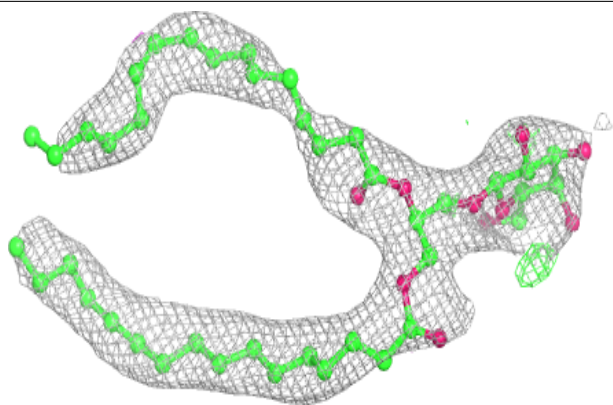
**Electron density around HTG b 622:**

$2mF_o-DF_c$ (at 0.7 rnsd) in gray
 mF_o-DF_c (at 3 rnsd) in purple (negative)
and green (positive)

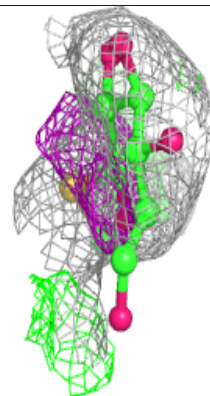
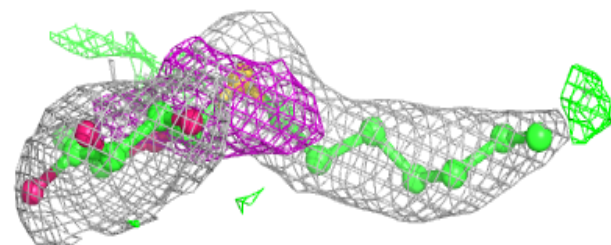
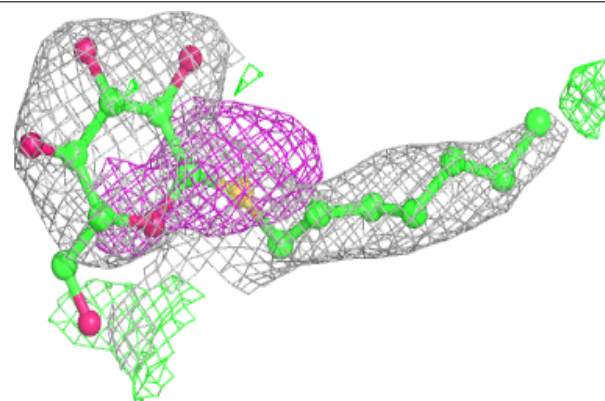

Electron density around SQD B 620:

$2mF_o-DF_c$ (at 0.7 rmsd) in gray
 mF_o-DF_c (at 3 rmsd) in purple (negative)
and green (positive)

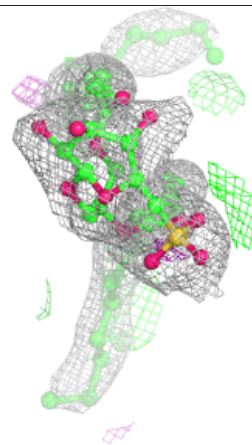
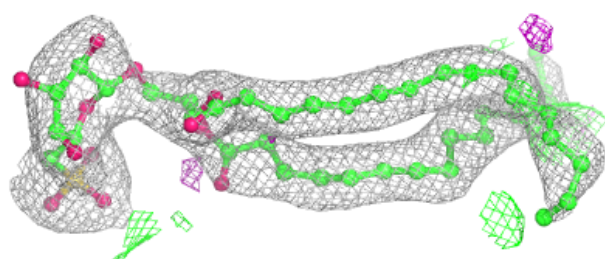
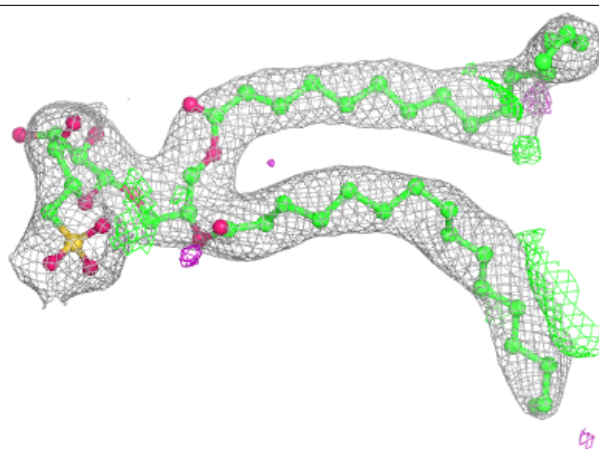
**Electron density around BCR C 515:**

$2mF_o-DF_c$ (at 0.7 rmsd) in gray
 mF_o-DF_c (at 3 rmsd) in purple (negative)
and green (positive)

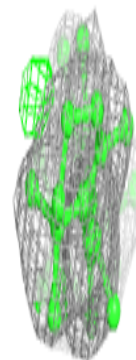
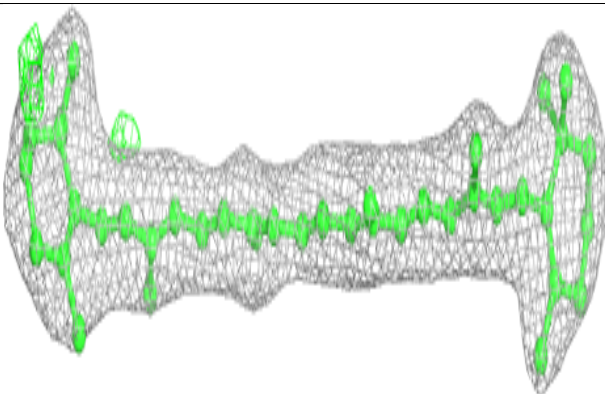
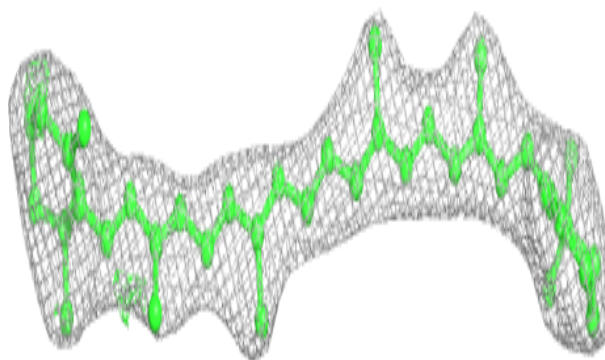

Electron density around HTG B 622:

$2mF_o-DF_c$ (at 0.7 rmsd) in gray
 mF_o-DF_c (at 3 rmsd) in purple (negative)
and green (positive)

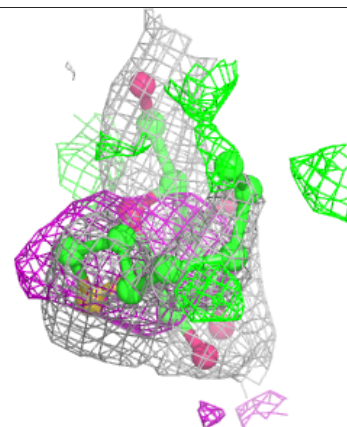
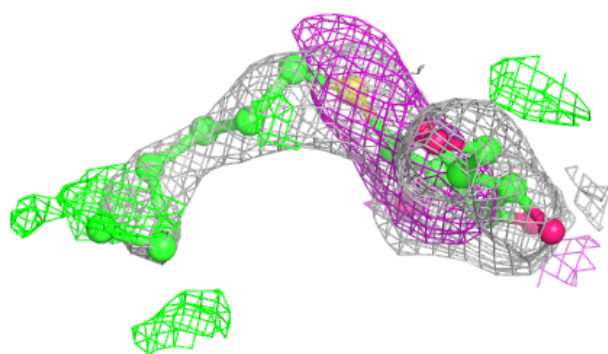
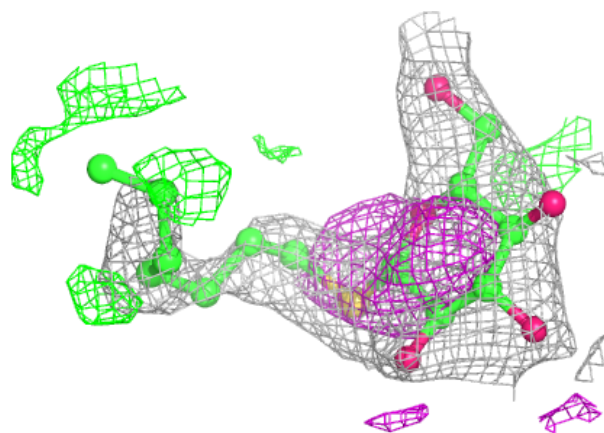
**Electron density around HTG o 301:**

$2mF_o-DF_c$ (at 0.7 rmsd) in gray
 mF_o-DF_c (at 3 rmsd) in purple (negative)
and green (positive)

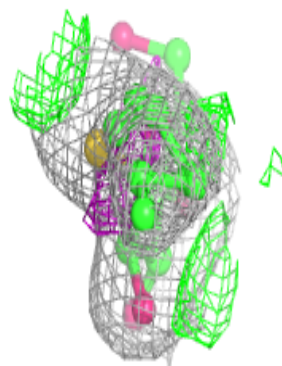
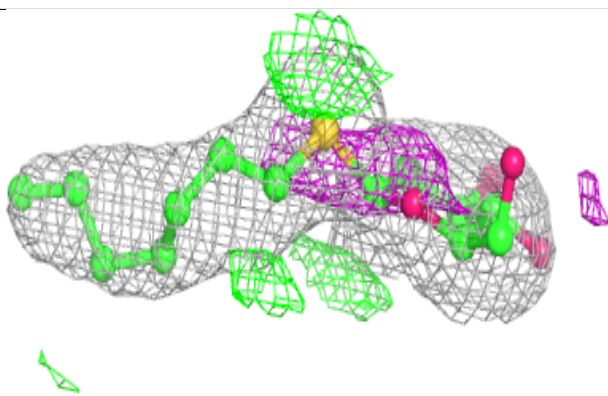
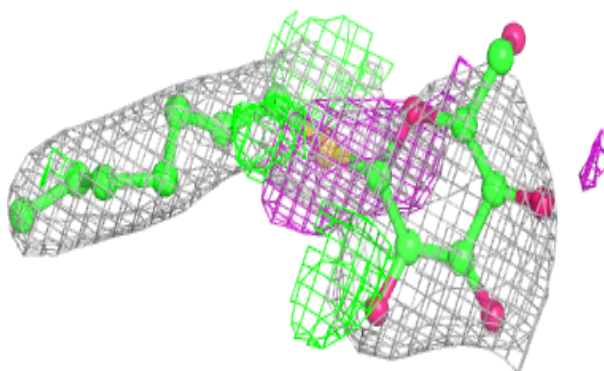

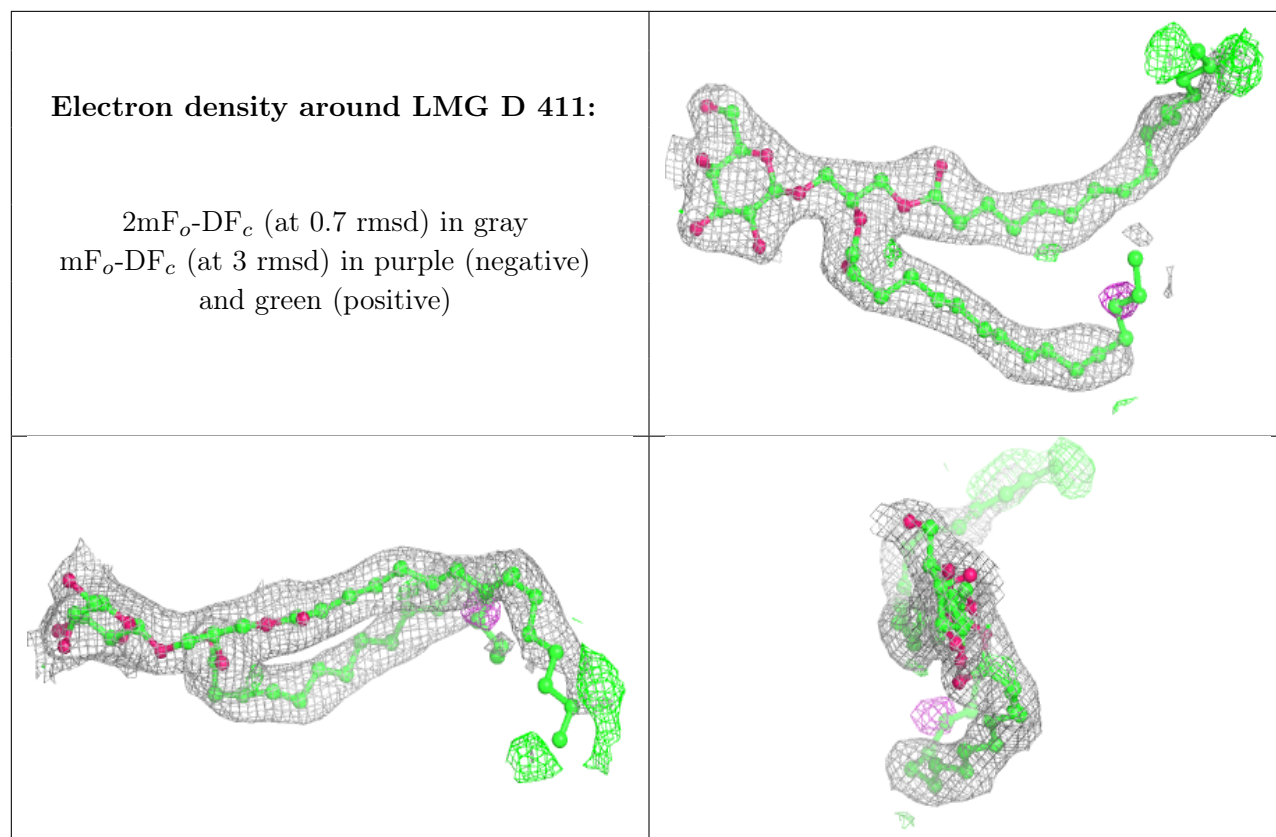

Electron density around CLA b 616:

$2mF_o-DF_c$ (at 0.7 rmsd) in gray
 mF_o-DF_c (at 3 rmsd) in purple (negative)
and green (positive)

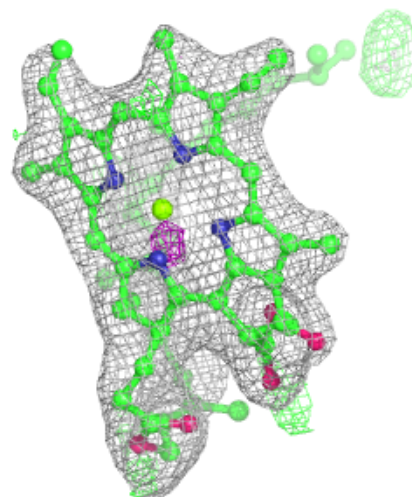
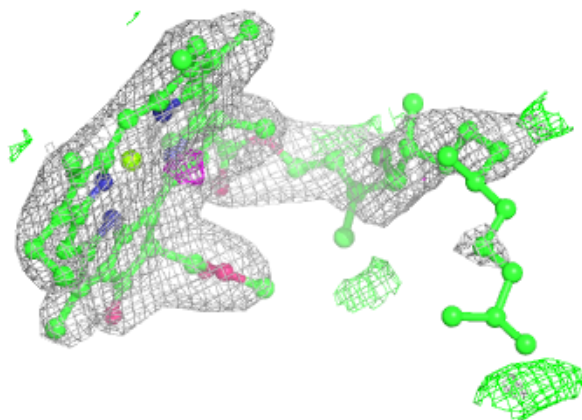
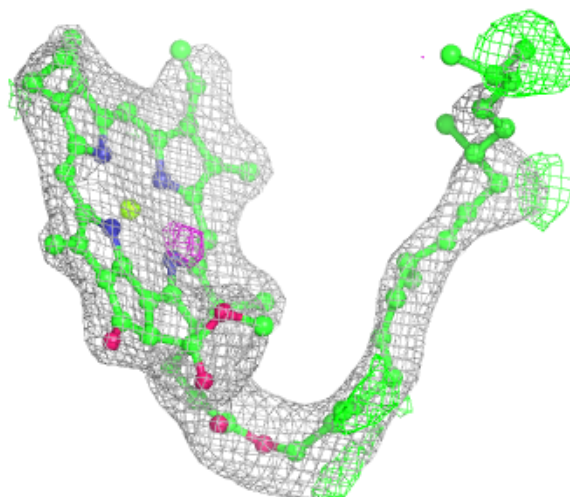

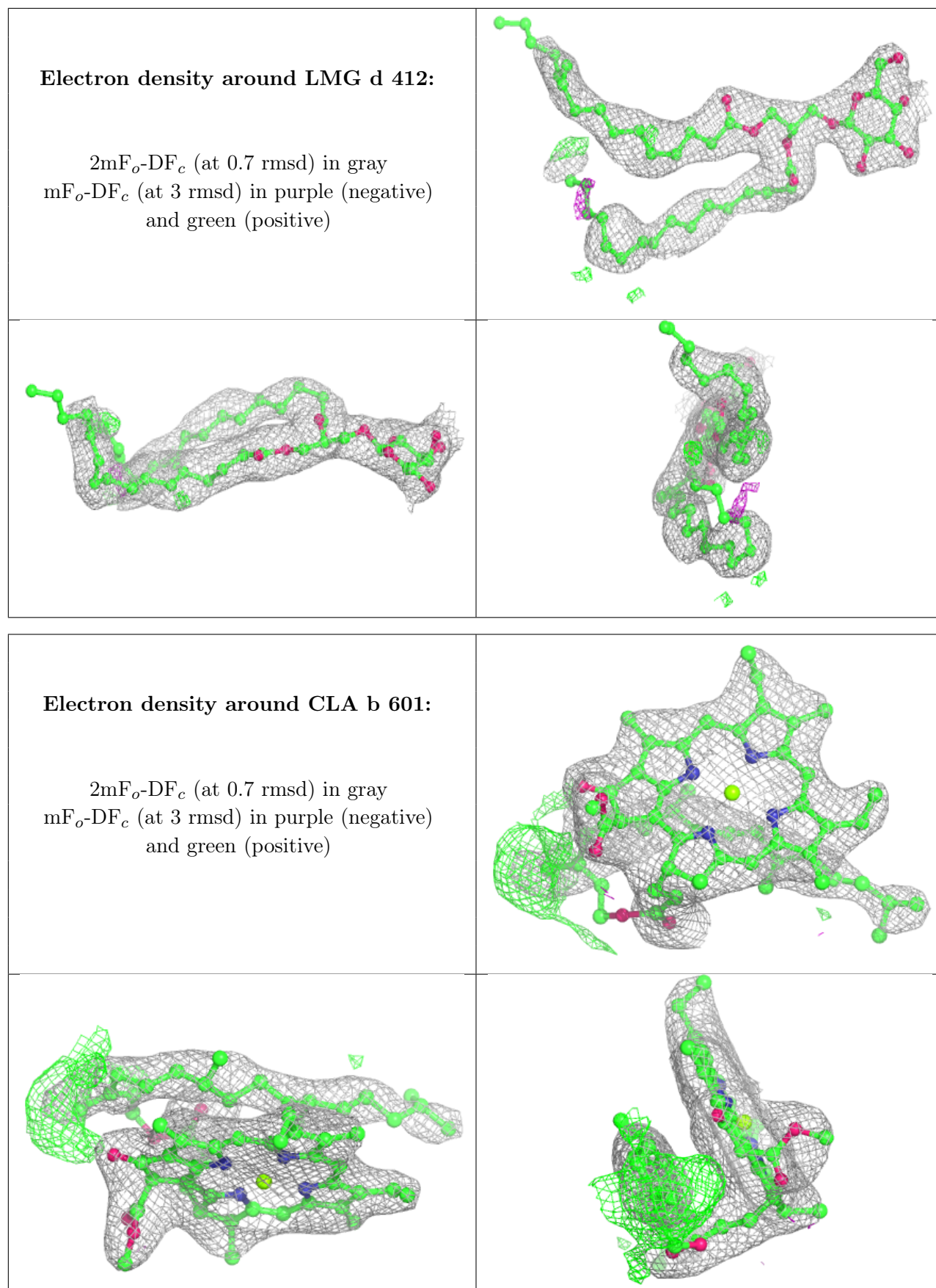

Electron density around BCR K 102:

$2mF_o-DF_c$ (at 0.7 rmsd) in gray
 mF_o-DF_c (at 3 rmsd) in purple (negative)
and green (positive)

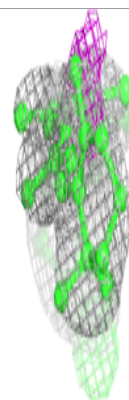
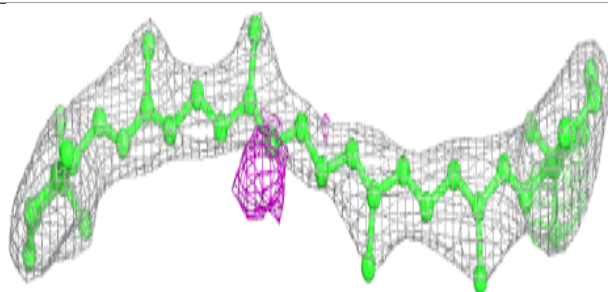
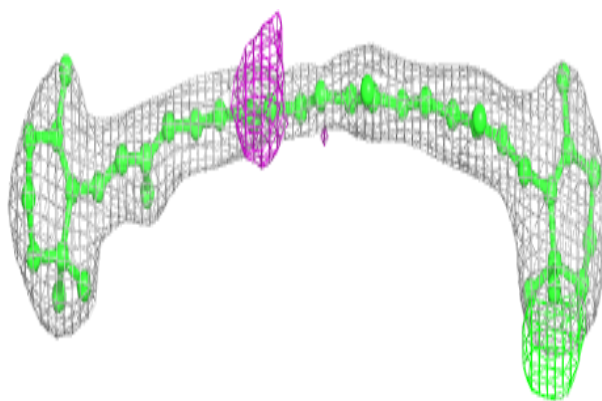
**Electron density around CLA B 601:**

$2mF_o-DF_c$ (at 0.7 rmsd) in gray
 mF_o-DF_c (at 3 rmsd) in purple (negative)
and green (positive)

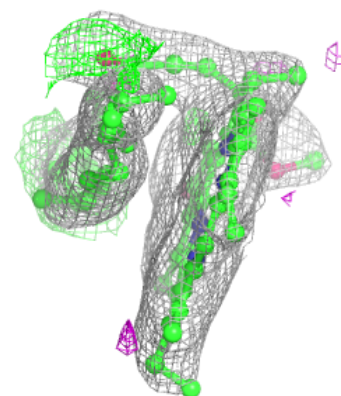
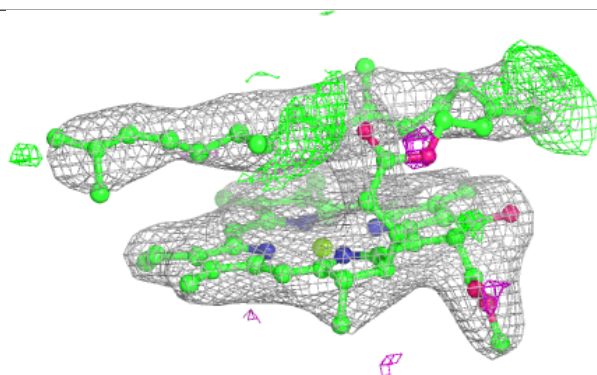
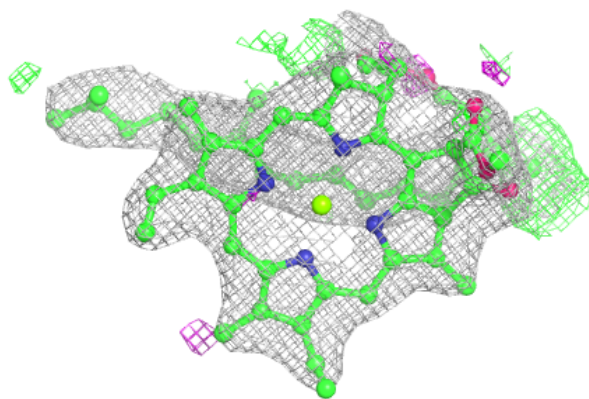

Electron density around CLA c 515:

$2mF_o-DF_c$ (at 0.7 rmsd) in gray
 mF_o-DF_c (at 3 rmsd) in purple (negative)
and green (positive)

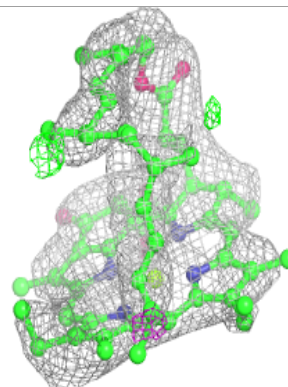
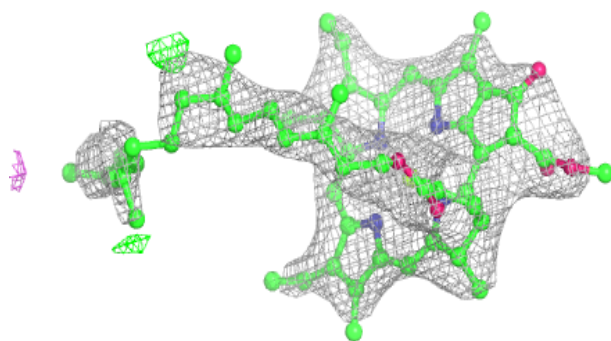
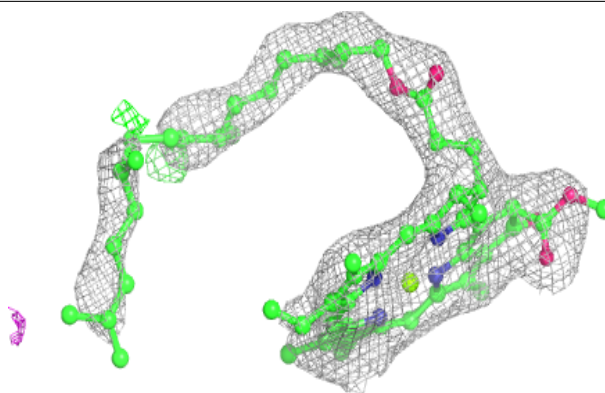
**Electron density around BCR h 101:**

$2mF_o-DF_c$ (at 0.7 rmsd) in gray
 mF_o-DF_c (at 3 rmsd) in purple (negative)
and green (positive)

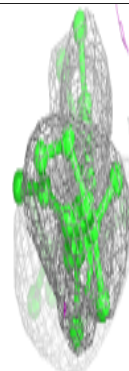
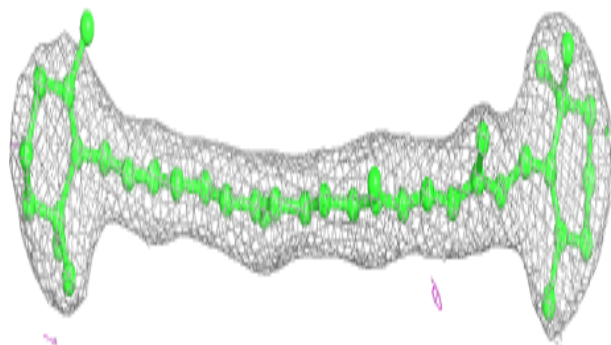
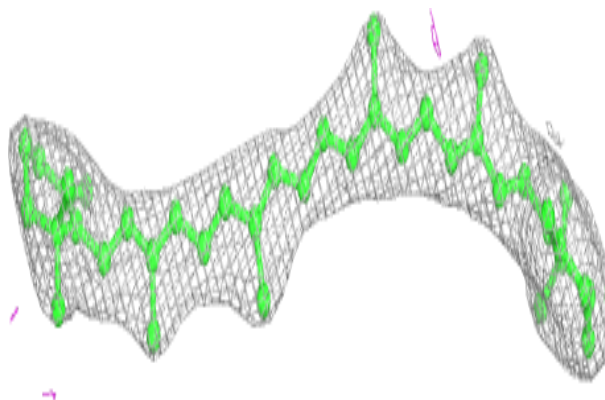

Electron density around LMG c 521:

$2mF_o-DF_c$ (at 0.7 rmsd) in gray
 mF_o-DF_c (at 3 rmsd) in purple (negative)
and green (positive)

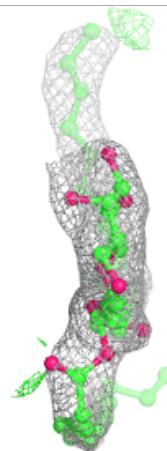
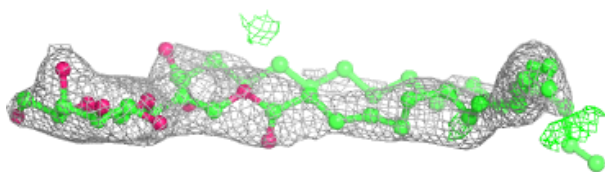
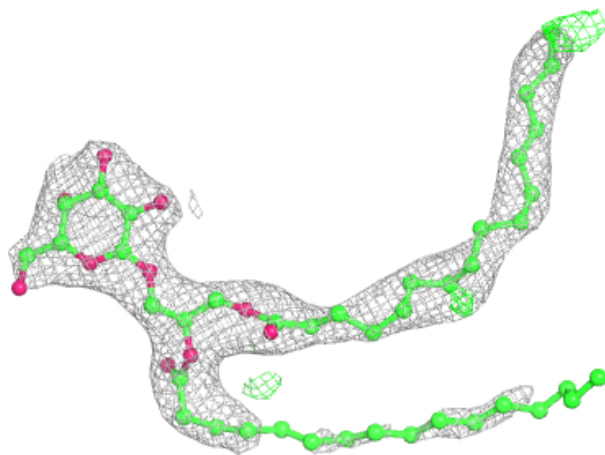

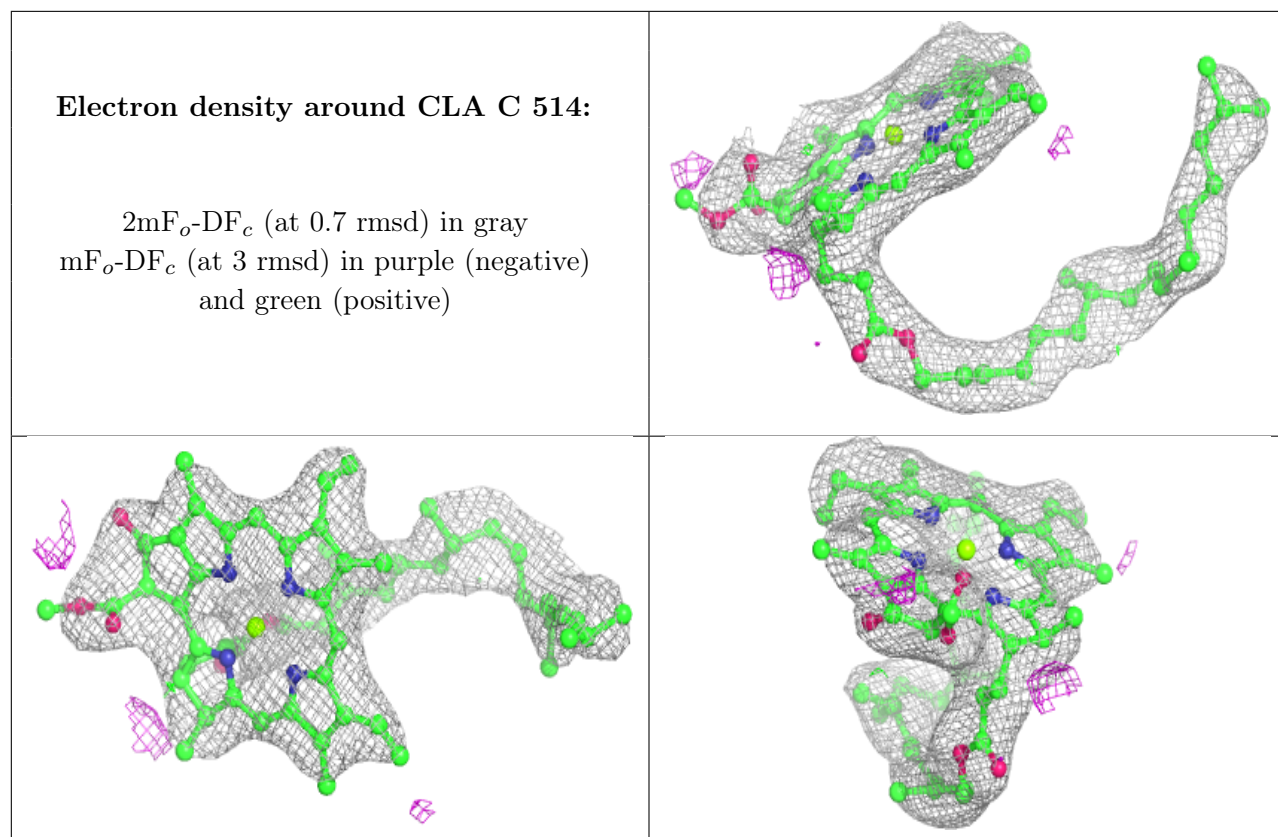

Electron density around CLA c 514:

$2mF_o-DF_c$ (at 0.7 rmsd) in gray
 mF_o-DF_c (at 3 rmsd) in purple (negative)
and green (positive)

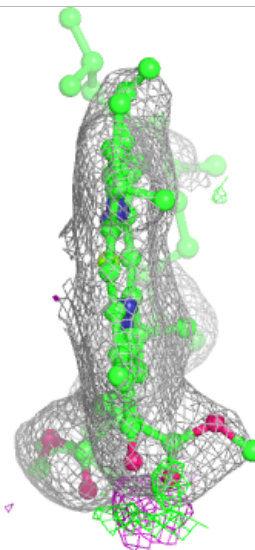
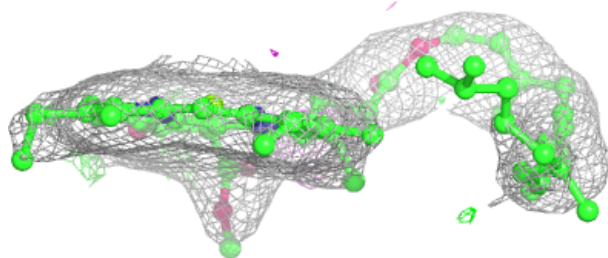
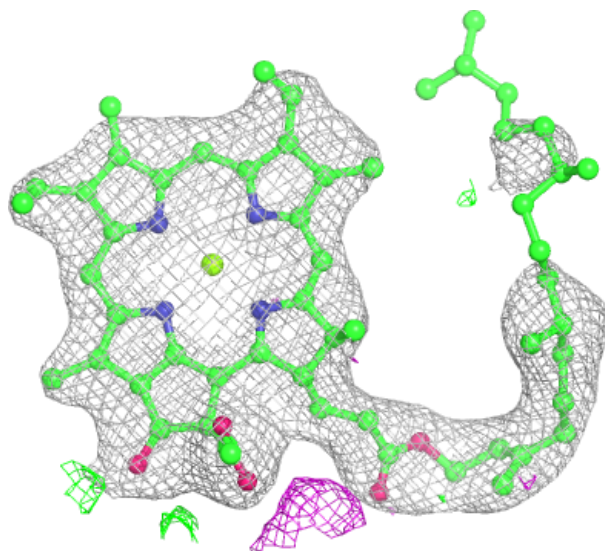

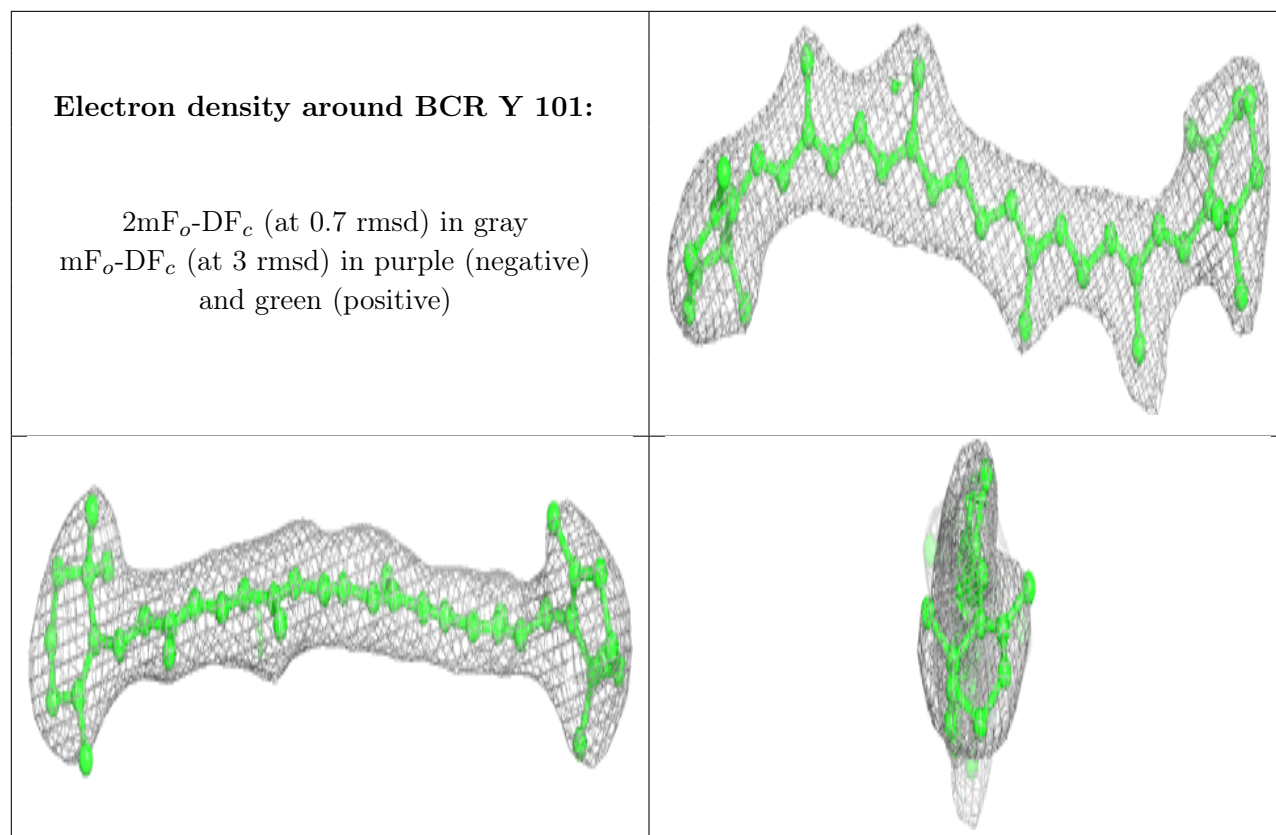

Electron density around CLA B 616:

$2mF_o-DF_c$ (at 0.7 rmsd) in gray
 mF_o-DF_c (at 3 rmsd) in purple (negative)
and green (positive)

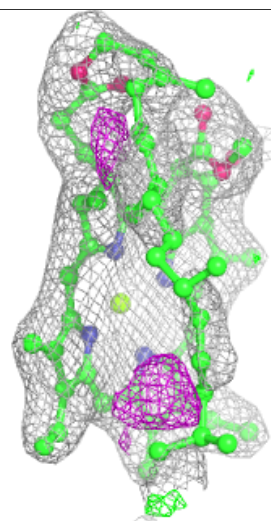
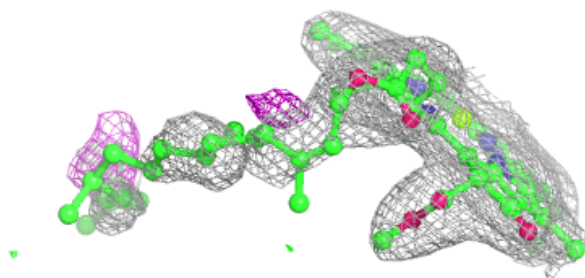
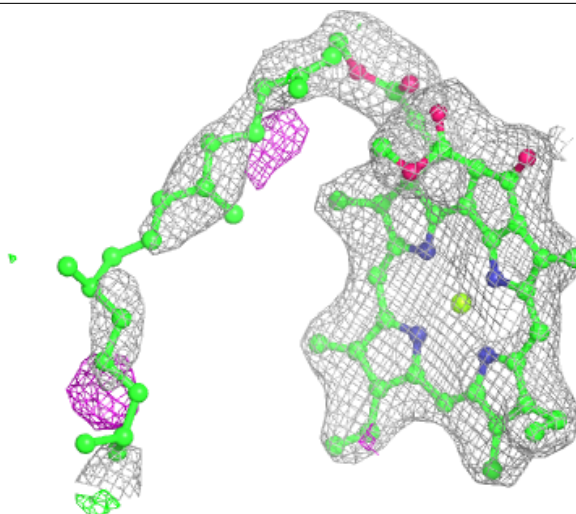

Electron density around CLA d 404:

$2mF_o-DF_c$ (at 0.7 rmsd) in gray
 mF_o-DF_c (at 3 rmsd) in purple (negative)
and green (positive)

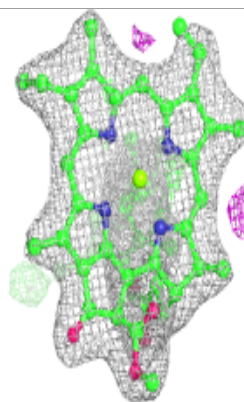
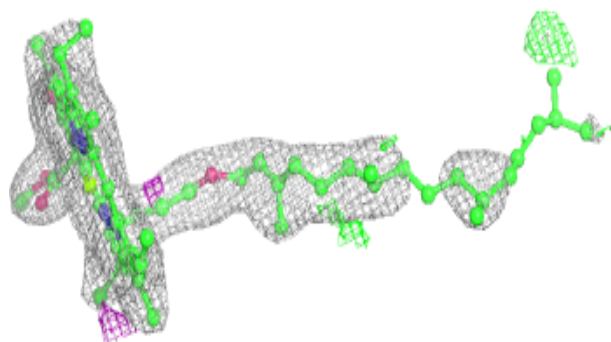
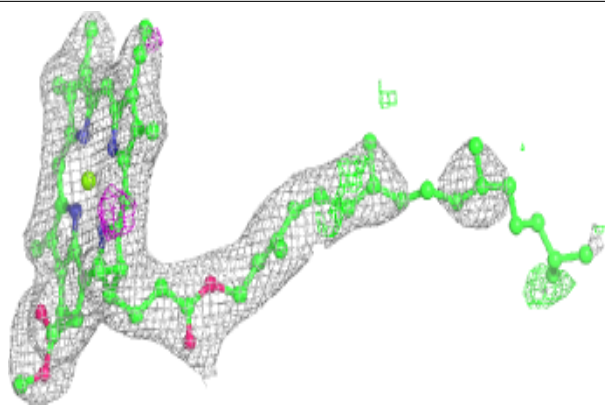
**Electron density around LMG C 520:**

$2mF_o-DF_c$ (at 0.7 rmsd) in gray
 mF_o-DF_c (at 3 rmsd) in purple (negative)
and green (positive)

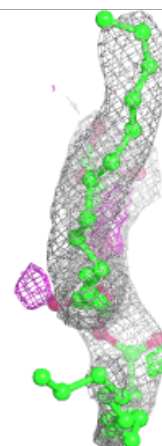
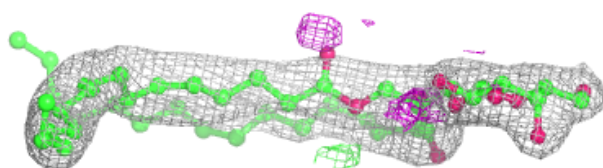
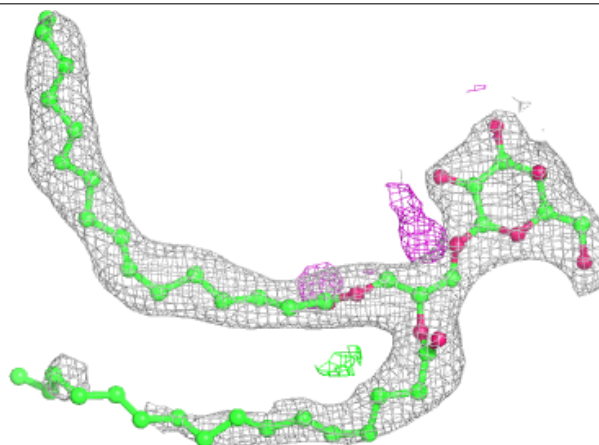

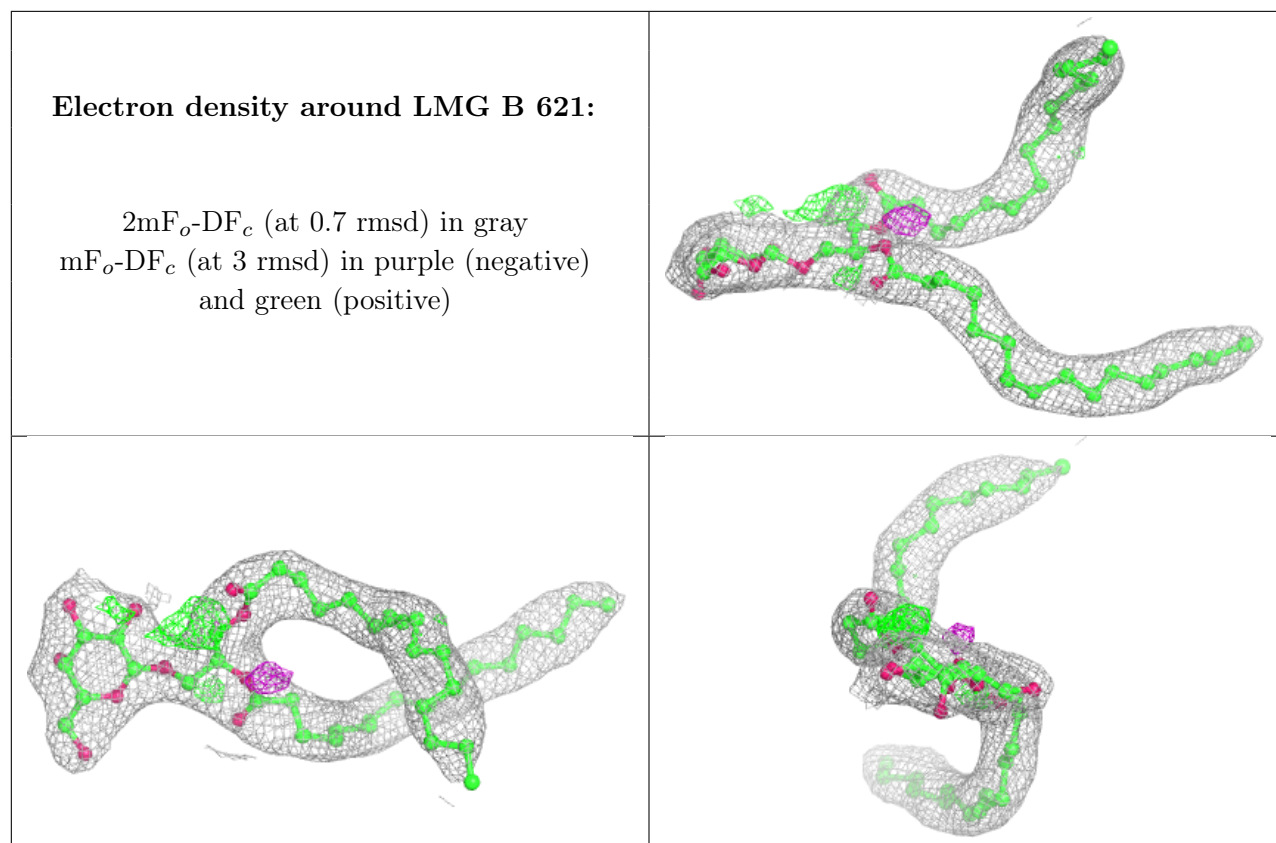

Electron density around CLA C 513:

$2mF_o-DF_c$ (at 0.7 rmsd) in gray
 mF_o-DF_c (at 3 rmsd) in purple (negative)
and green (positive)

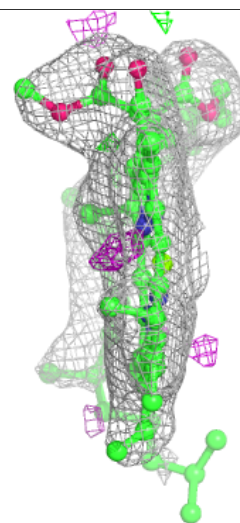
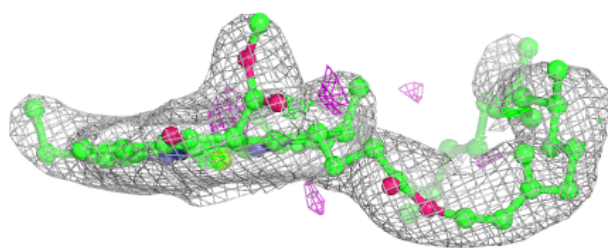
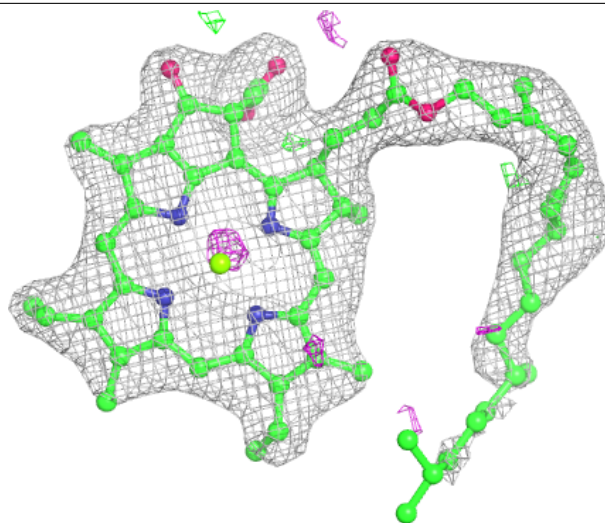

Electron density around SQD F 102:

$2mF_o-DF_c$ (at 0.7 rmsd) in gray
 mF_o-DF_c (at 3 rmsd) in purple (negative)
and green (positive)

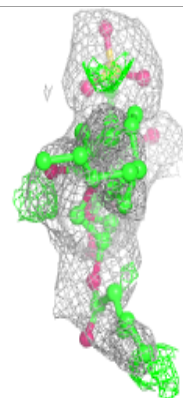
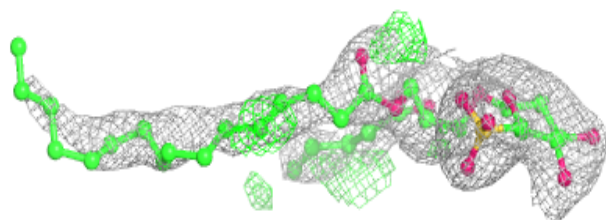
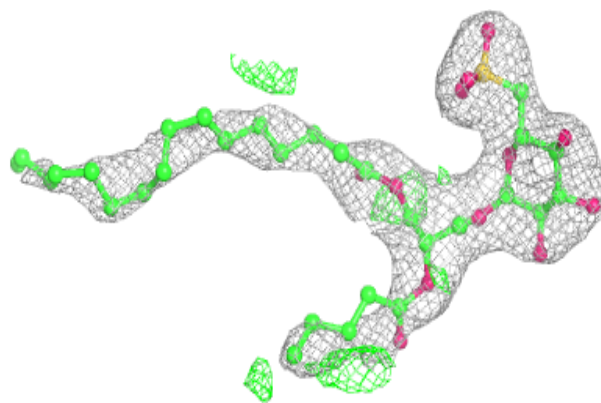

Electron density around HTG V 202:

$2mF_o-DF_c$ (at 0.7 rmsd) in gray
 mF_o-DF_c (at 3 rmsd) in purple (negative)
and green (positive)

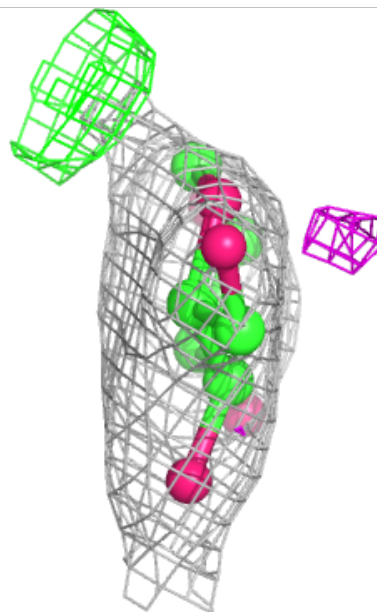
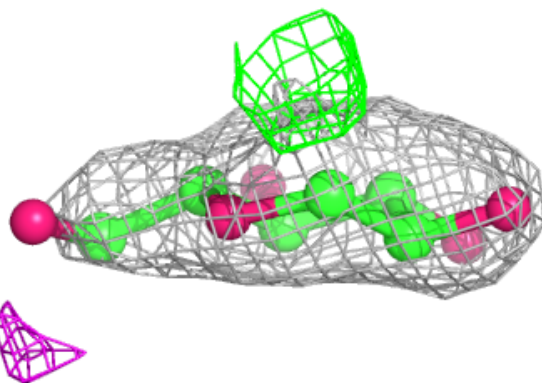
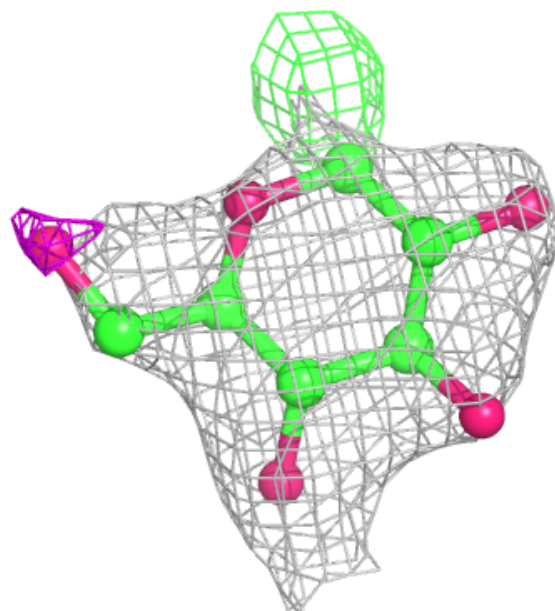

Electron density around BCR d 405:

$2mF_o-DF_c$ (at 0.7 rmsd) in gray
 mF_o-DF_c (at 3 rmsd) in purple (negative)
and green (positive)

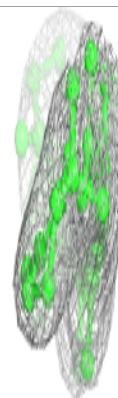
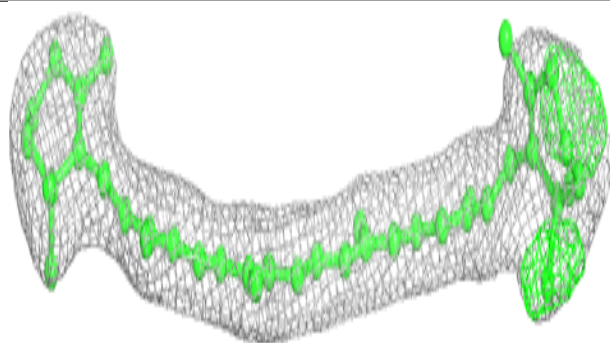
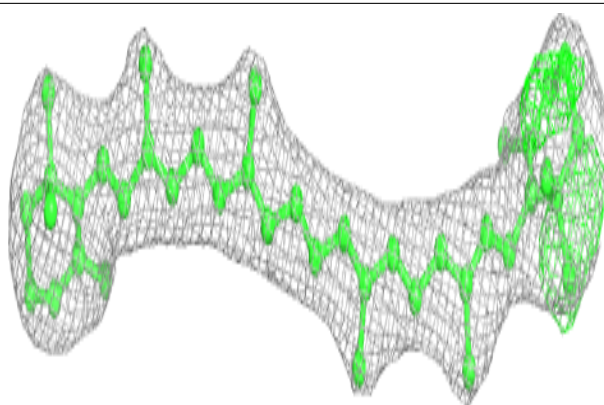
**Electron density around CLA b 606:**

$2mF_o-DF_c$ (at 0.7 rmsd) in gray
 mF_o-DF_c (at 3 rmsd) in purple (negative)
and green (positive)

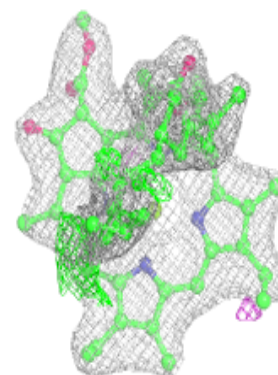
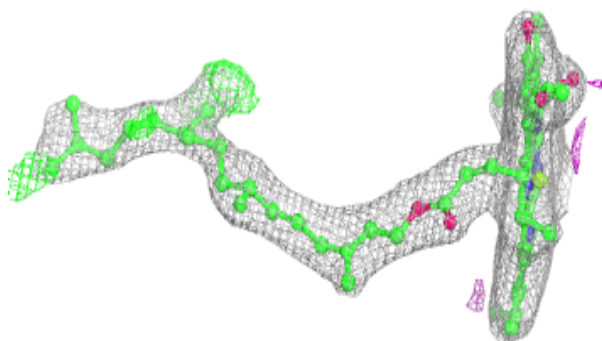
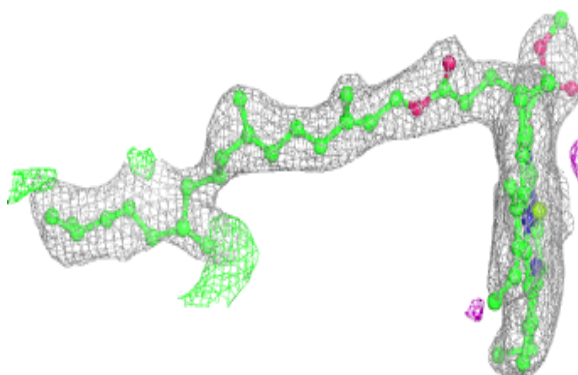

Electron density around CLA C 507:

$2mF_o-DF_c$ (at 0.7 rmsd) in gray
 mF_o-DF_c (at 3 rmsd) in purple (negative)
and green (positive)

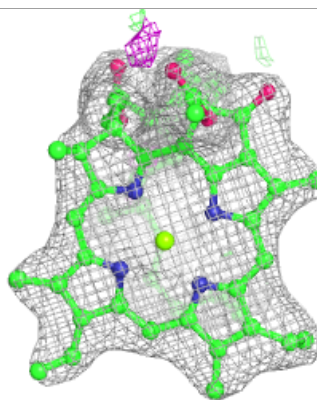
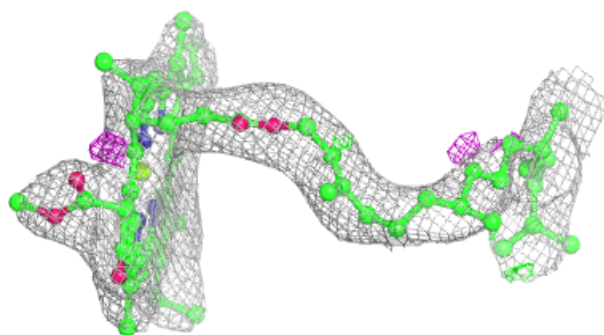
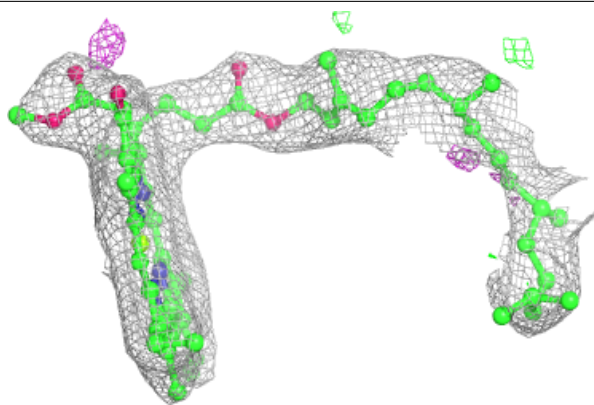
**Electron density around DGD H 101:**

$2mF_o-DF_c$ (at 0.7 rmsd) in gray
 mF_o-DF_c (at 3 rmsd) in purple (negative)
and green (positive)

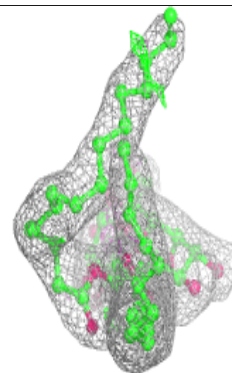
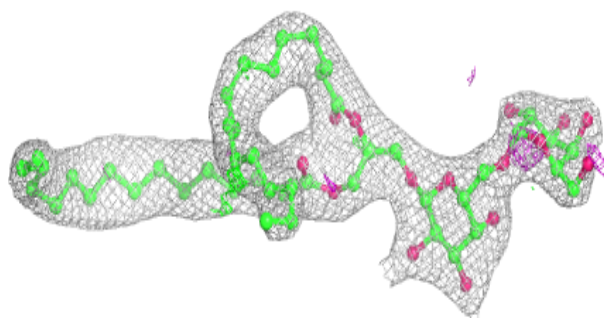
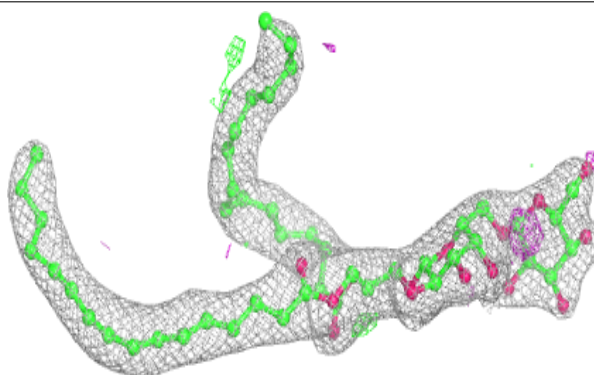

Electron density around DGD c 519 (A):

$2mF_o-DF_c$ (at 0.7 rmsd) in gray
 mF_o-DF_c (at 3 rmsd) in purple (negative)
and green (positive)

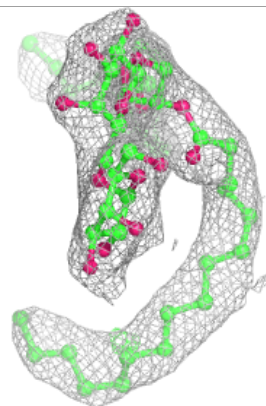
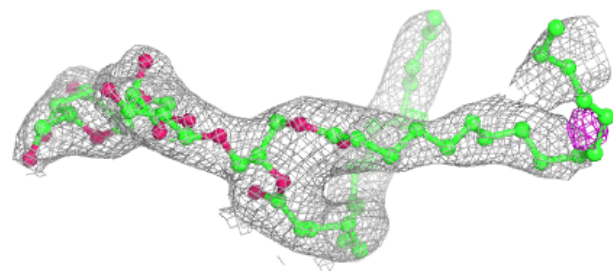
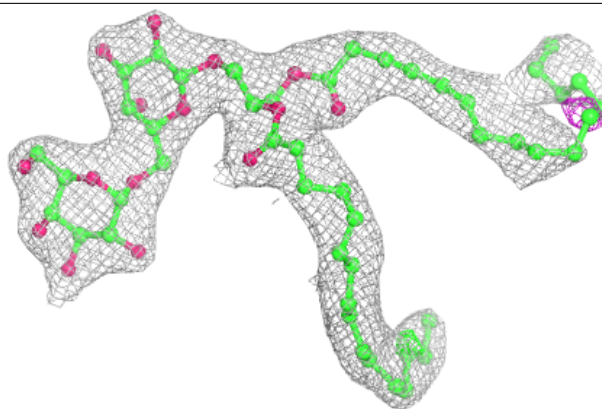
**Electron density around DGD c 519 (B):**

$2mF_o-DF_c$ (at 0.7 rmsd) in gray
 mF_o-DF_c (at 3 rmsd) in purple (negative)
and green (positive)

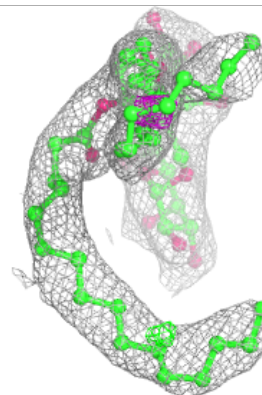
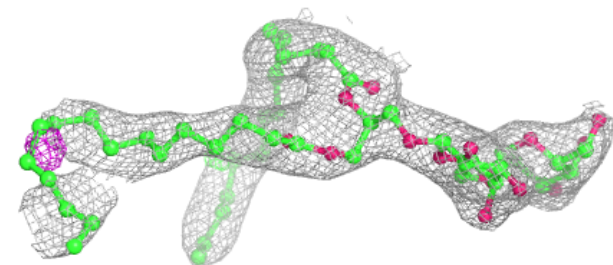
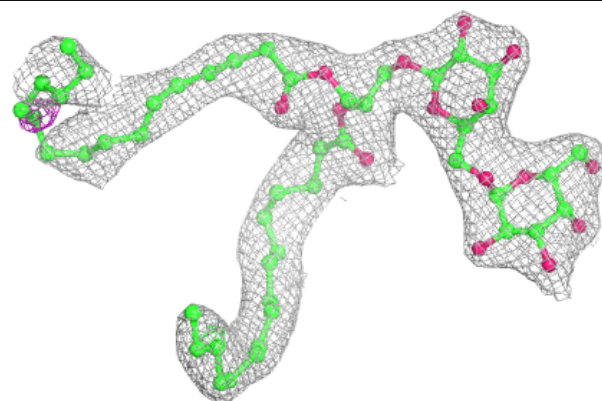

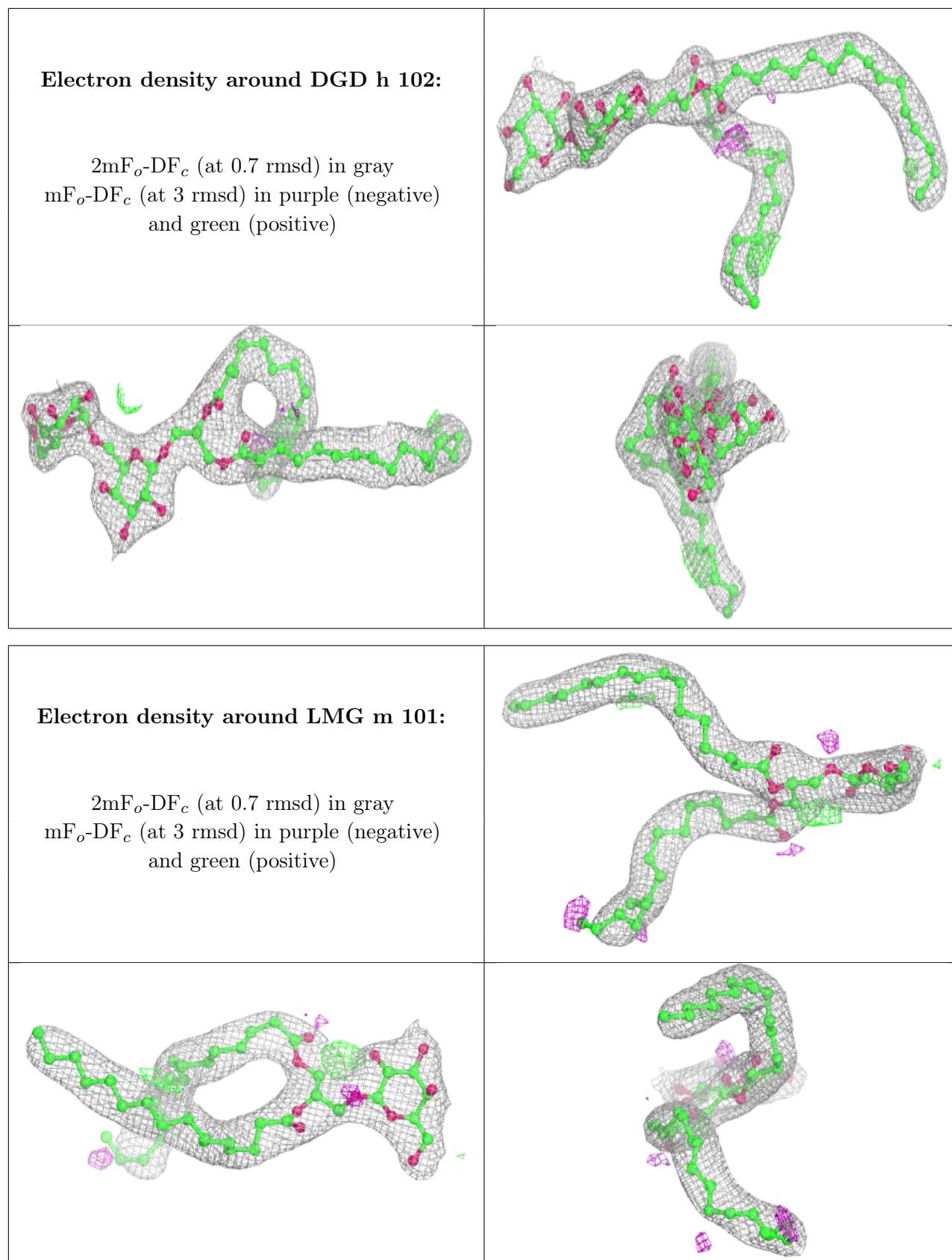

Electron density around HTG b 625:

$2mF_o-DF_c$ (at 0.7 rmsd) in gray
 mF_o-DF_c (at 3 rmsd) in purple (negative)
and green (positive)

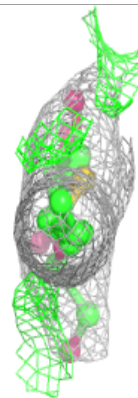
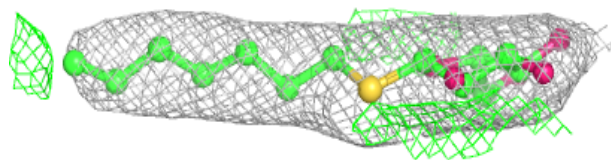
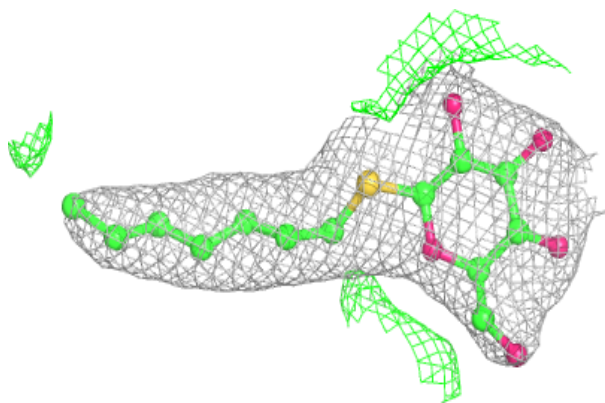
**Electron density around CLA B 606:**

$2mF_o-DF_c$ (at 0.7 rmsd) in gray
 mF_o-DF_c (at 3 rmsd) in purple (negative)
and green (positive)

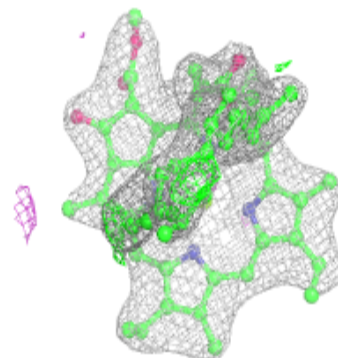
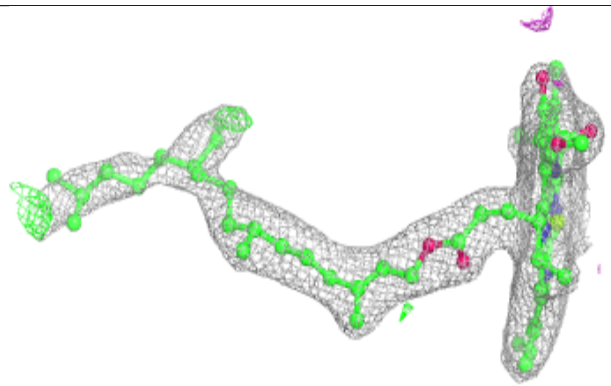
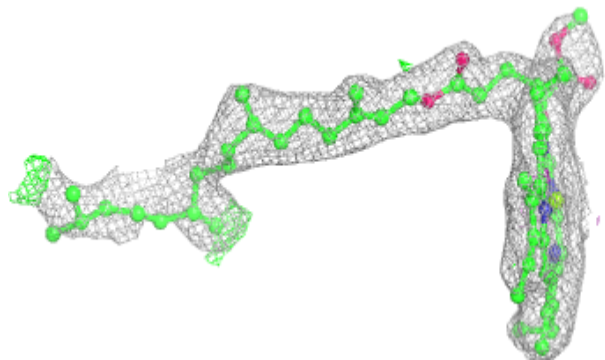

Electron density around CLA B 609:

$2mF_o-DF_c$ (at 0.7 rmsd) in gray
 mF_o-DF_c (at 3 rmsd) in purple (negative)
and green (positive)

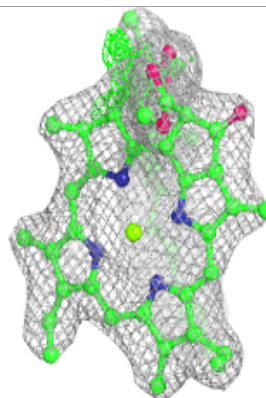
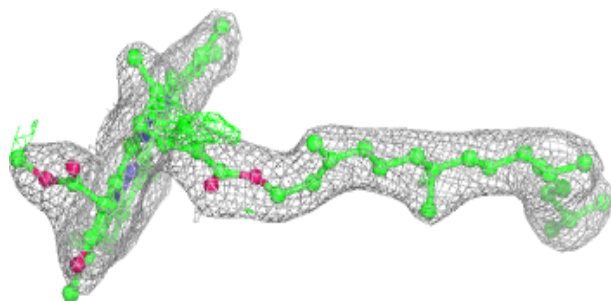
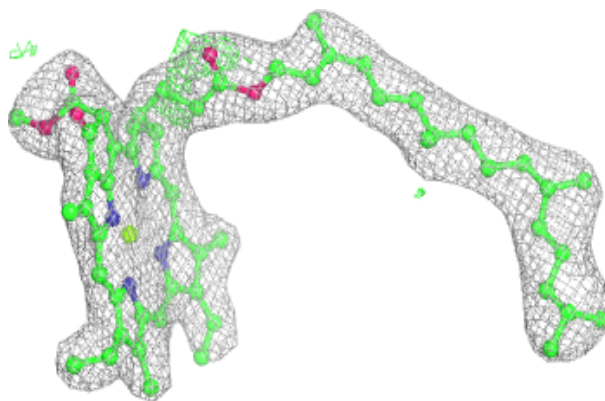
**Electron density around HTG B 624:**

$2mF_o-DF_c$ (at 0.7 rmsd) in gray
 mF_o-DF_c (at 3 rmsd) in purple (negative)
and green (positive)

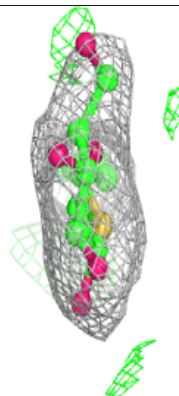
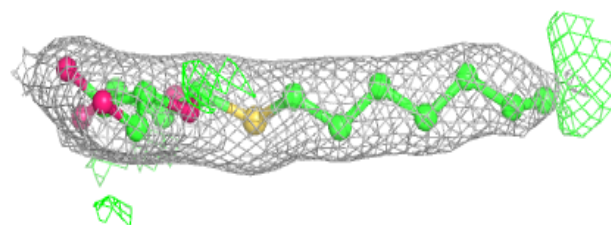
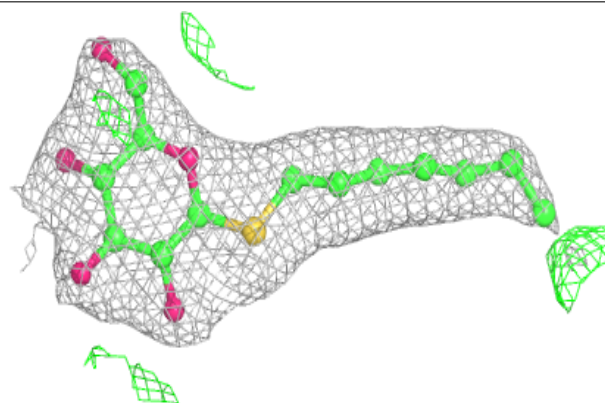

Electron density around DGD C 518 (A):

$2mF_o-DF_c$ (at 0.7 rmsd) in gray
 mF_o-DF_c (at 3 rmsd) in purple (negative)
and green (positive)

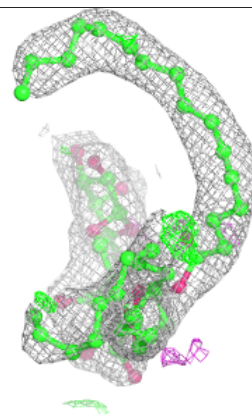
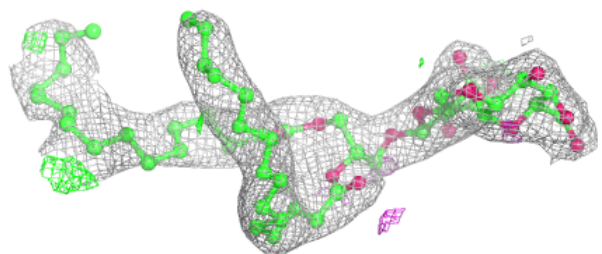
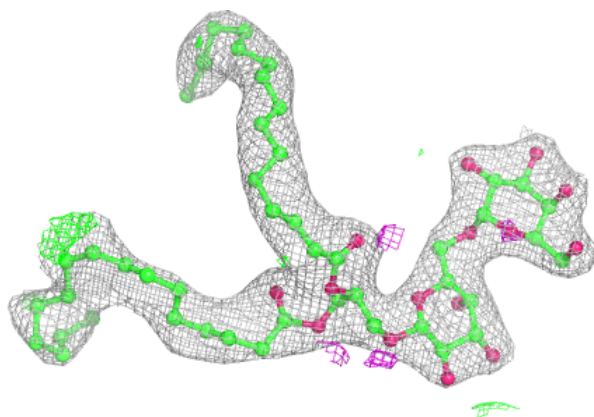
**Electron density around DGD C 518 (B):**

$2mF_o-DF_c$ (at 0.7 rmsd) in gray
 mF_o-DF_c (at 3 rmsd) in purple (negative)
and green (positive)

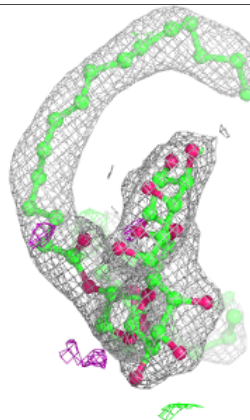
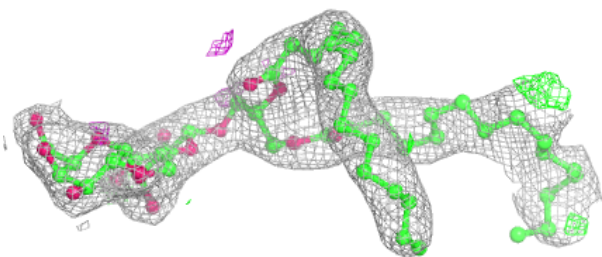
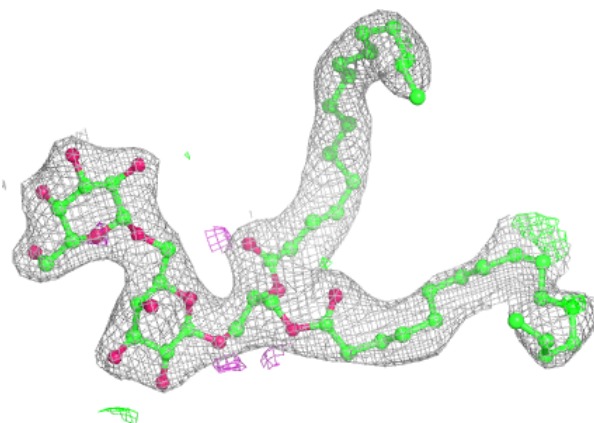

Electron density around DGD C 519:

$2mF_o-DF_c$ (at 0.7 rmsd) in gray
 mF_o-DF_c (at 3 rmsd) in purple (negative)
and green (positive)

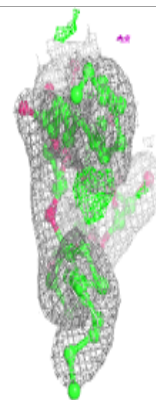
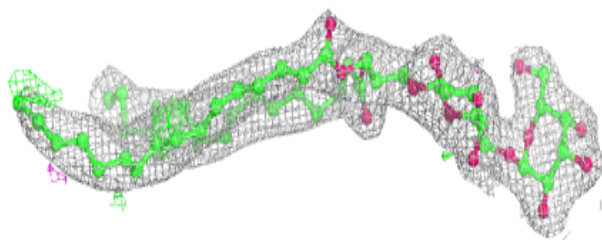
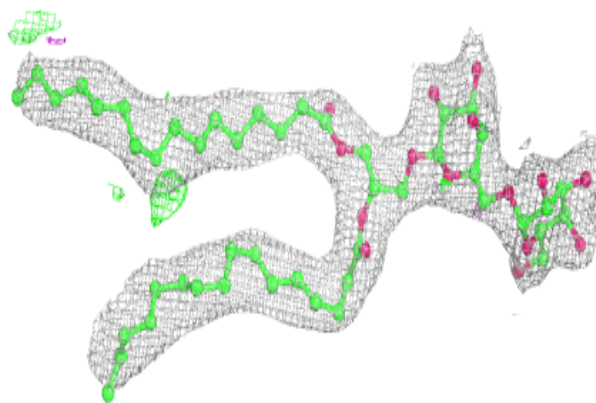
**Electron density around CLA C 509:**

$2mF_o-DF_c$ (at 0.7 rmsd) in gray
 mF_o-DF_c (at 3 rmsd) in purple (negative)
and green (positive)

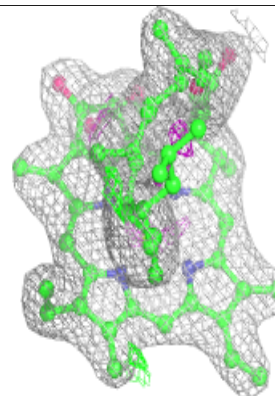
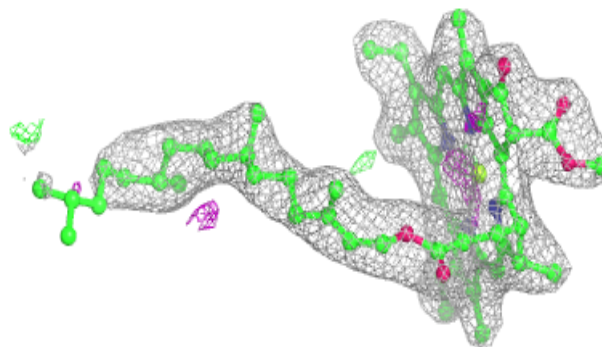
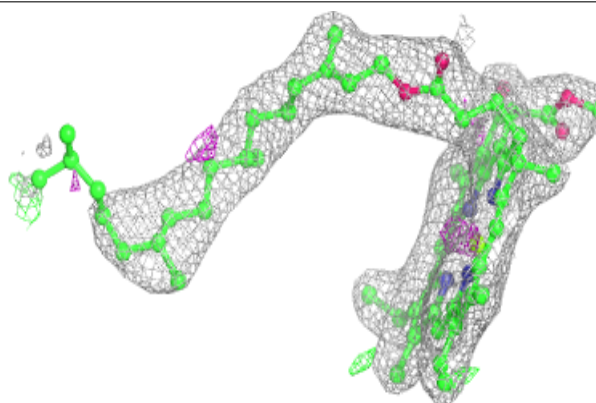

Electron density around CLA D 403:

$2mF_o-DF_c$ (at 0.7 rmsd) in gray
 mF_o-DF_c (at 3 rmsd) in purple (negative)
and green (positive)

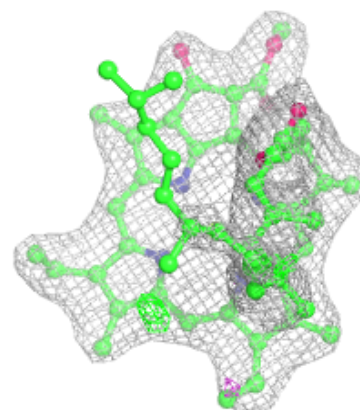
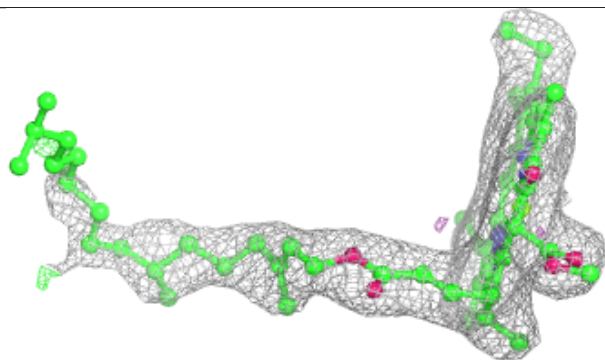
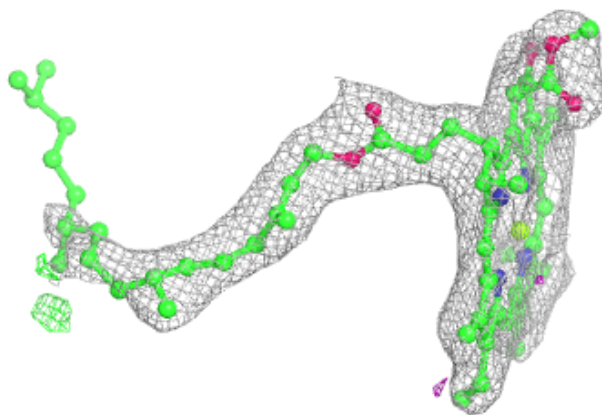
**Electron density around BCR D 404:**

$2mF_o-DF_c$ (at 0.7 rmsd) in gray
 mF_o-DF_c (at 3 rmsd) in purple (negative)
and green (positive)

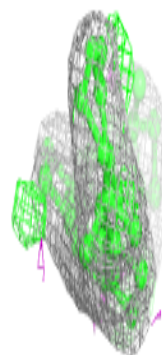
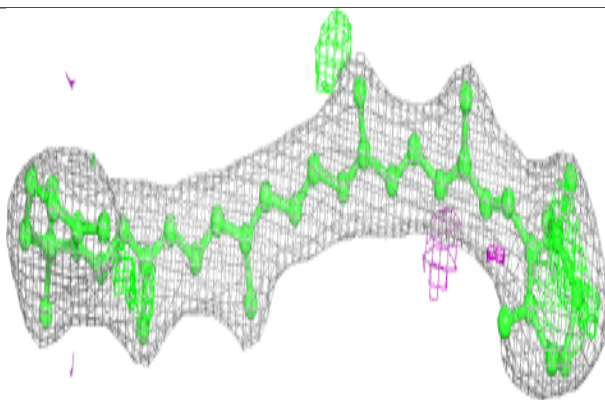
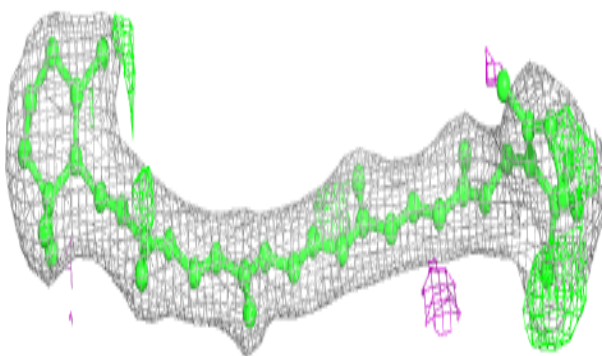

Electron density around DGD c 520:

$2mF_o-DF_c$ (at 0.7 rmsd) in gray
 mF_o-DF_c (at 3 rmsd) in purple (negative)
and green (positive)

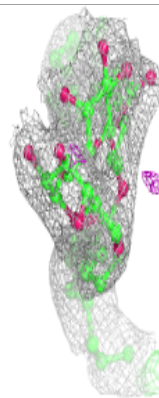
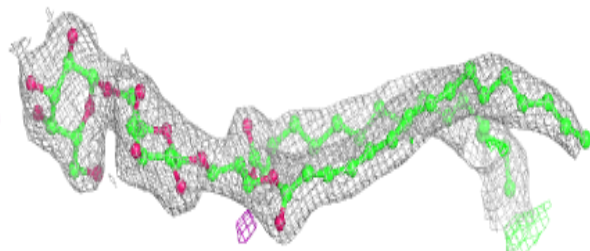
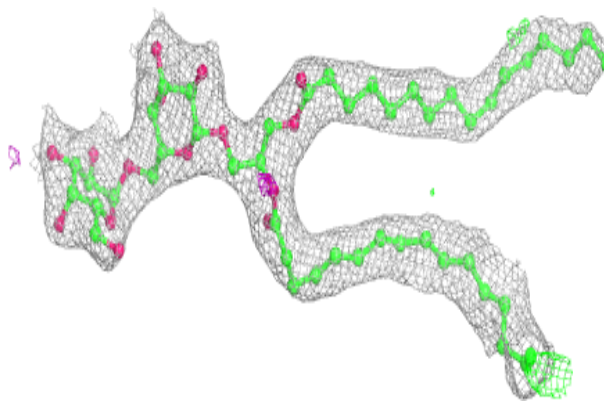
**Electron density around CLA c 508:**

$2mF_o-DF_c$ (at 0.7 rmsd) in gray
 mF_o-DF_c (at 3 rmsd) in purple (negative)
and green (positive)

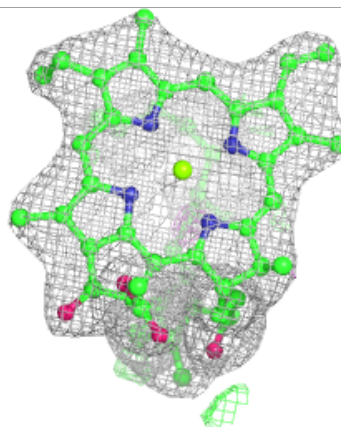
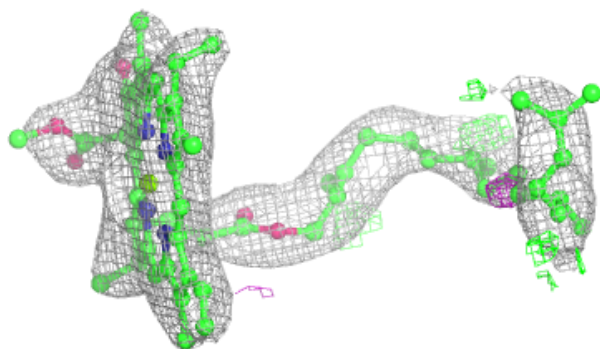
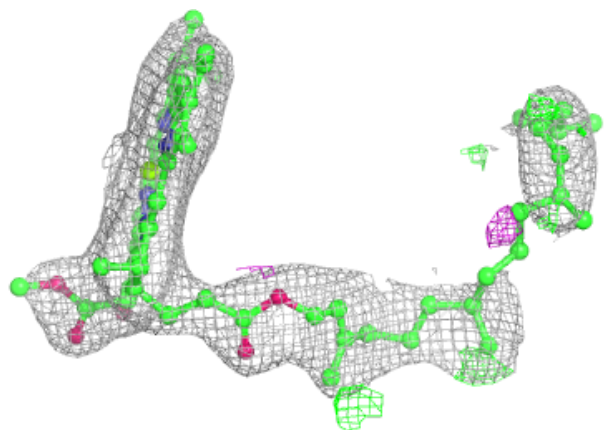

Electron density around CLA a 407:

$2mF_o-DF_c$ (at 0.7 rmsd) in gray
 mF_o-DF_c (at 3 rmsd) in purple (negative)
and green (positive)

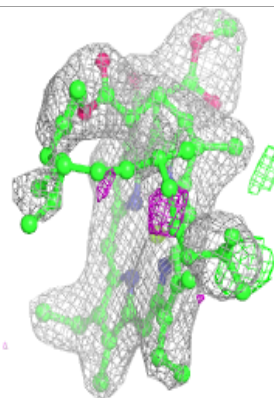
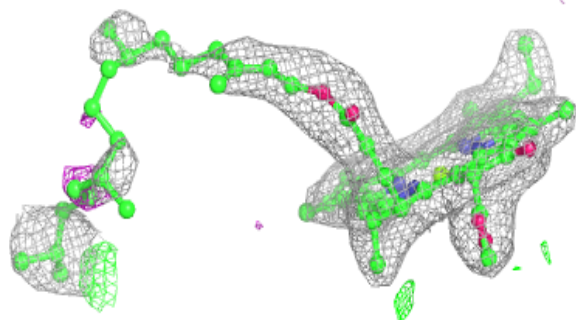
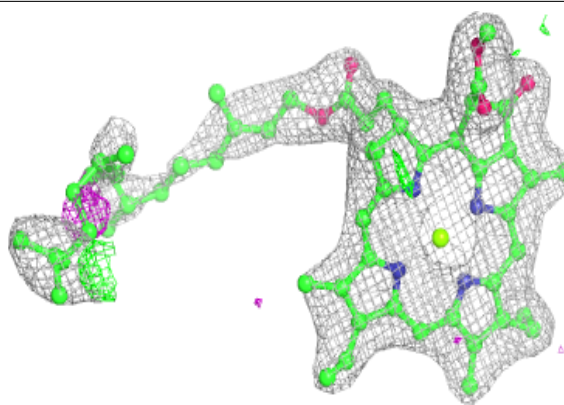
**Electron density around BCR b 618:**

$2mF_o-DF_c$ (at 0.7 rmsd) in gray
 mF_o-DF_c (at 3 rmsd) in purple (negative)
and green (positive)

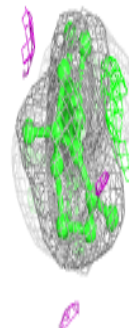
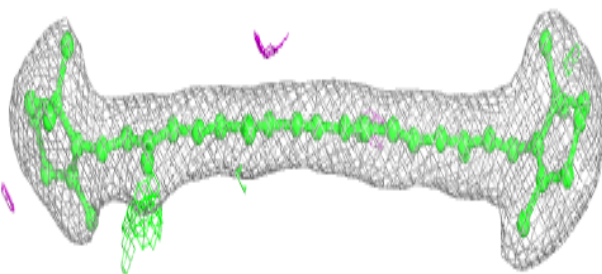
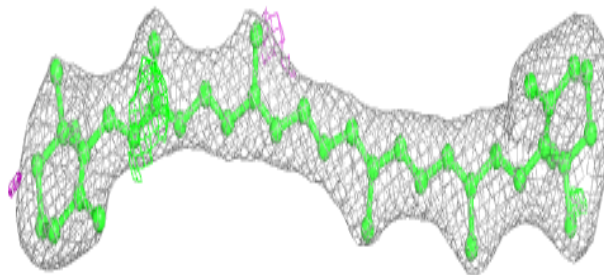

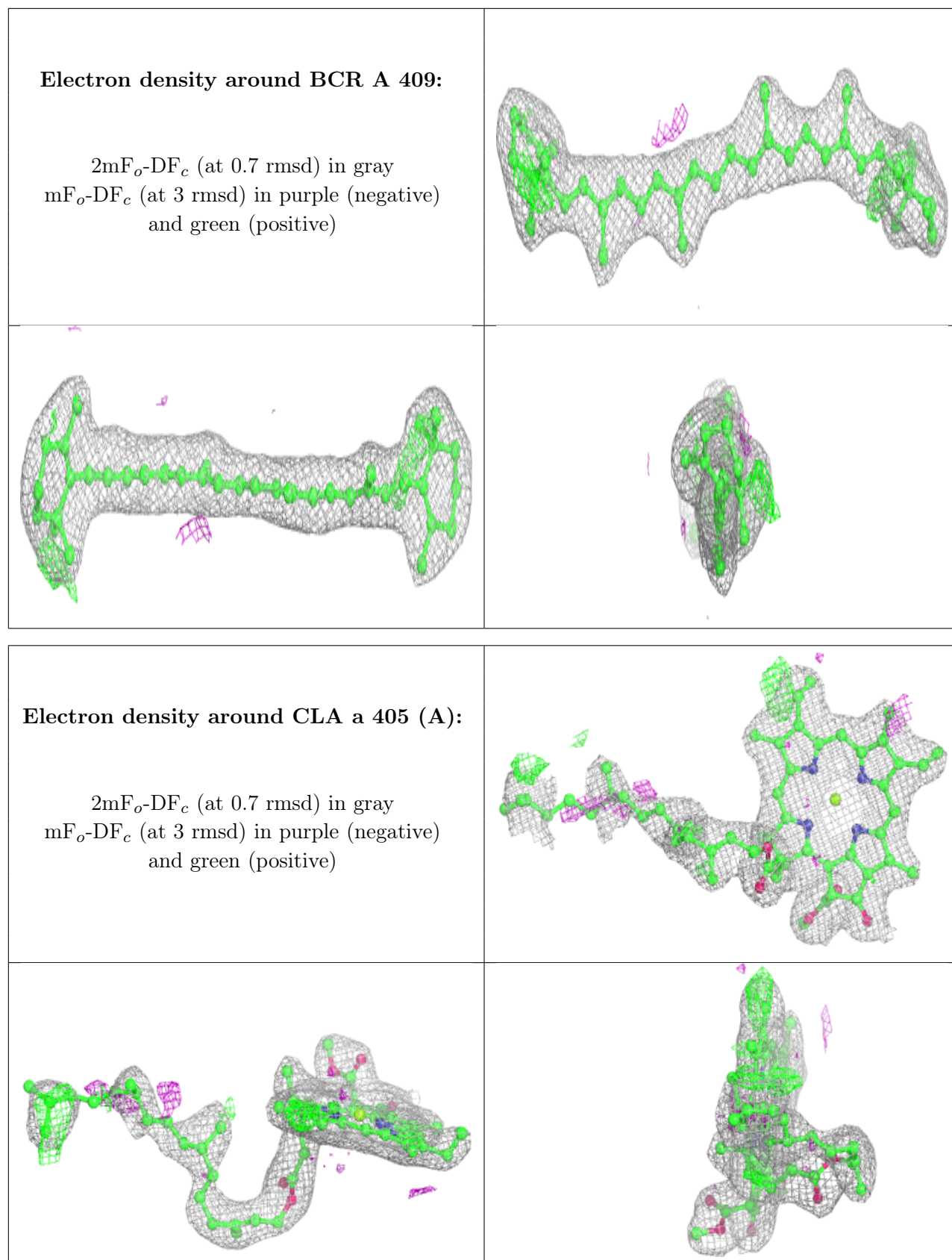

Electron density around BCR k 101:

$2mF_o-DF_c$ (at 0.7 rmsd) in gray
 mF_o-DF_c (at 3 rmsd) in purple (negative)
and green (positive)

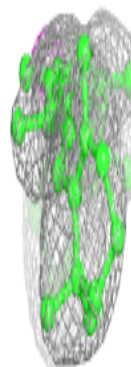
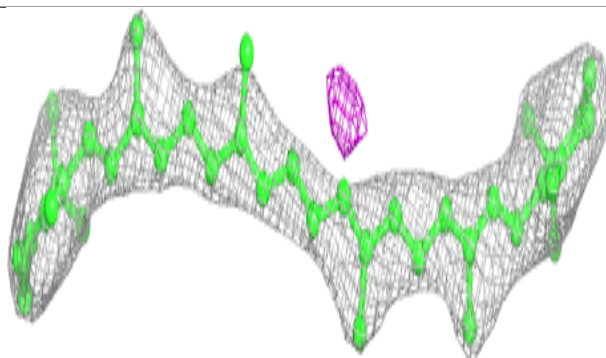
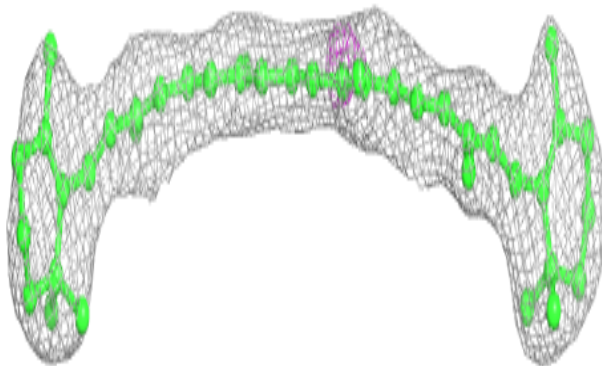
**Electron density around BCR y 101:**

$2mF_o-DF_c$ (at 0.7 rmsd) in gray
 mF_o-DF_c (at 3 rmsd) in purple (negative)
and green (positive)

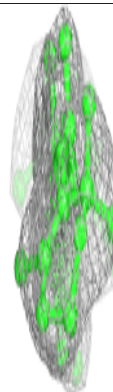
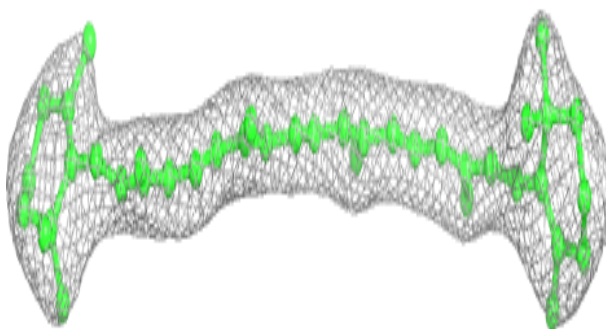
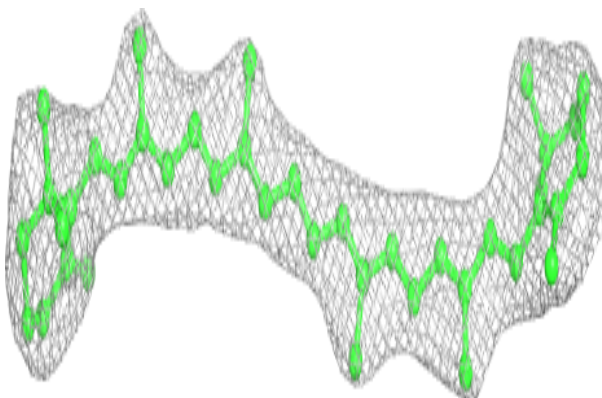

Electron density around SQD A 410 (A):

$2mF_o-DF_c$ (at 0.7 rmsd) in gray
 mF_o-DF_c (at 3 rmsd) in purple (negative)
and green (positive)

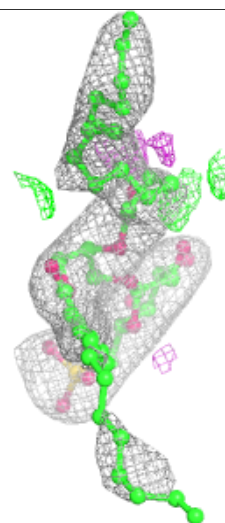
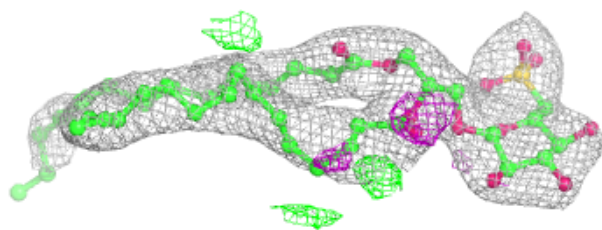
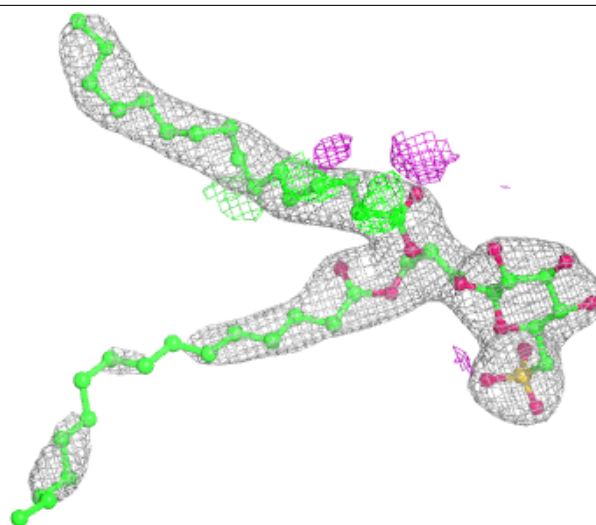

Electron density around SQD A 410 (B):

$2mF_o-DF_c$ (at 0.7 rmsd) in gray
 mF_o-DF_c (at 3 rmsd) in purple (negative)
and green (positive)

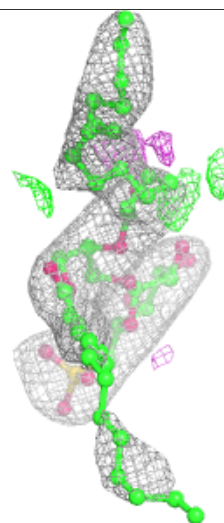
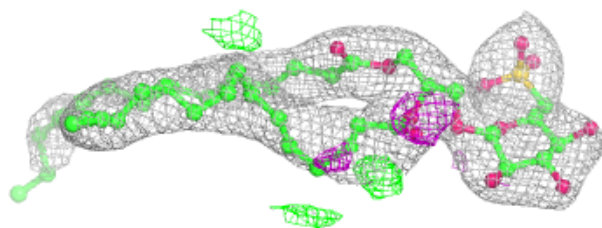
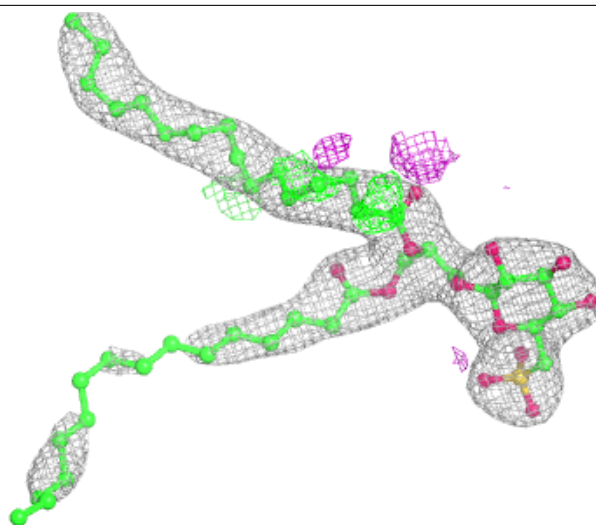

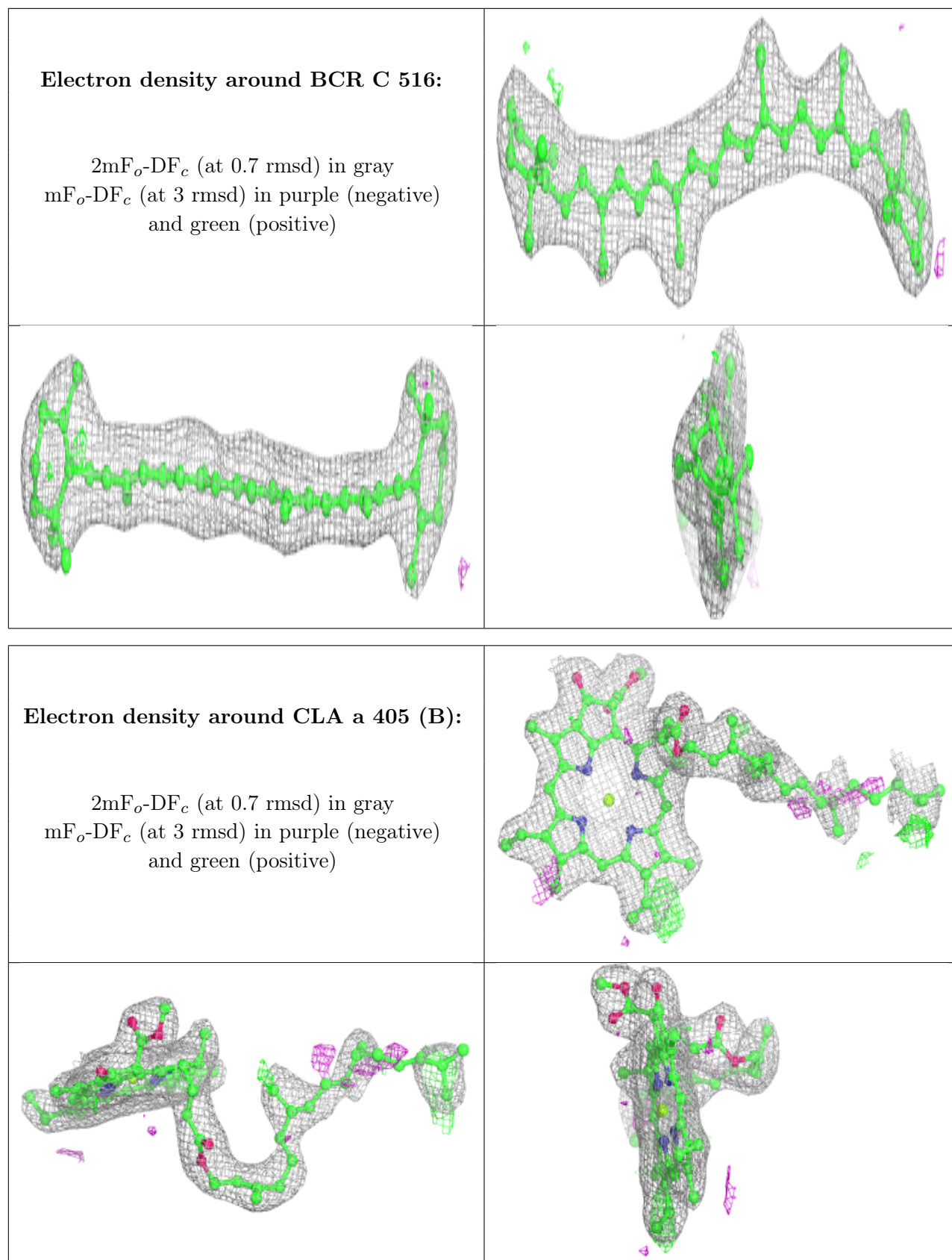

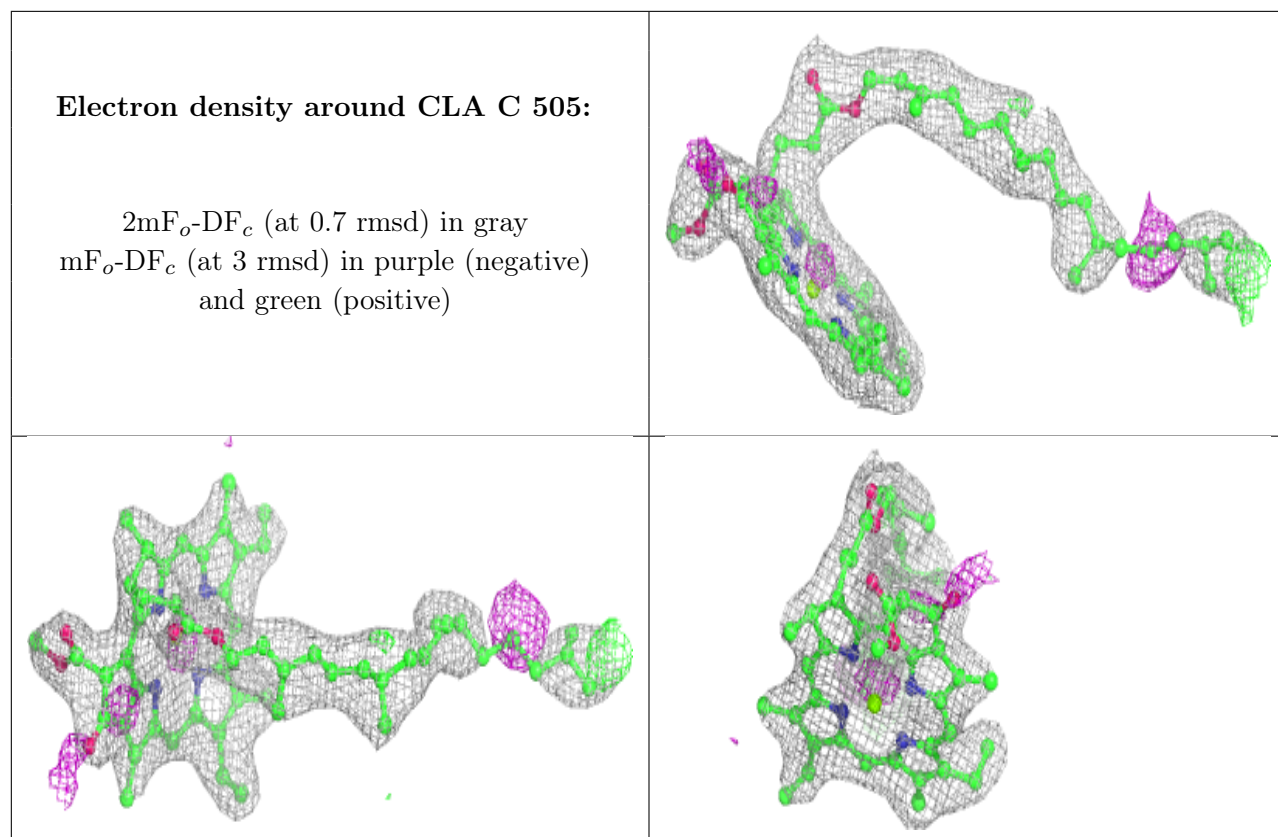

Electron density around CLA B 611:

$2mF_o-DF_c$ (at 0.7 rmsd) in gray
 mF_o-DF_c (at 3 rmsd) in purple (negative)
and green (positive)

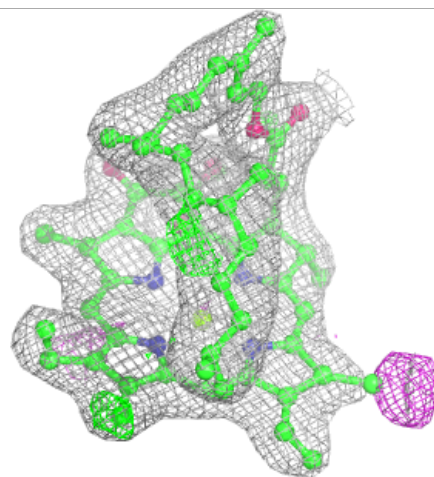
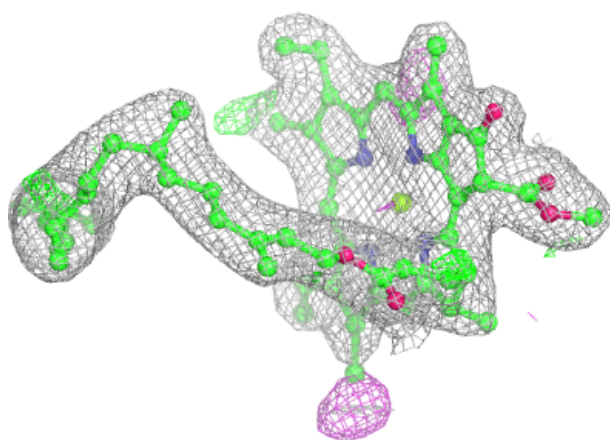
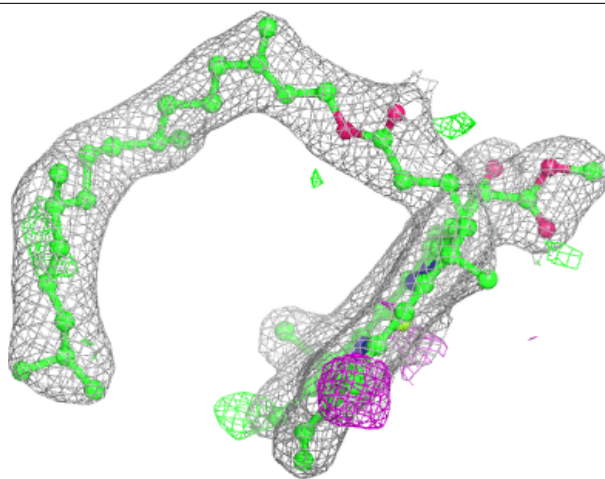

Electron density around CLA A 408:

$2mF_o-DF_c$ (at 0.7 rmsd) in gray
 mF_o-DF_c (at 3 rmsd) in purple (negative)
and green (positive)

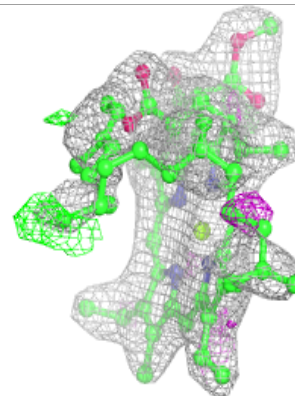
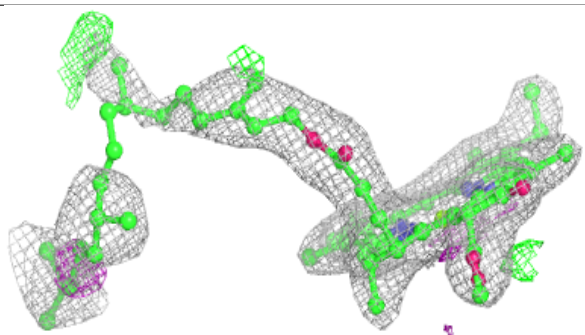
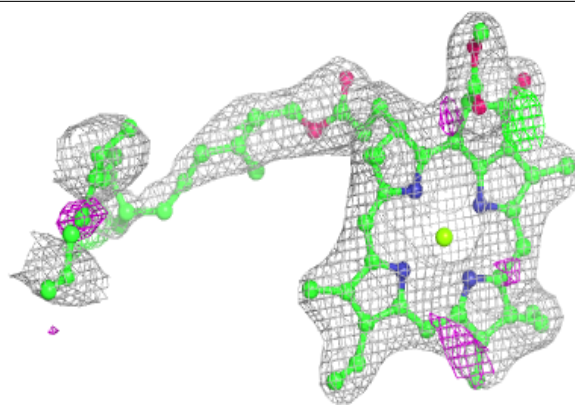
**Electron density around BCR c 516:**

$2mF_o-DF_c$ (at 0.7 rmsd) in gray
 mF_o-DF_c (at 3 rmsd) in purple (negative)
and green (positive)

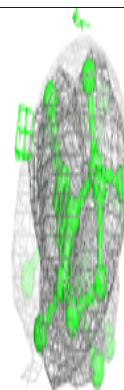
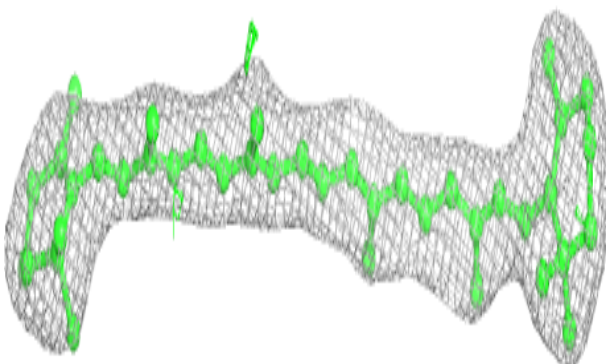
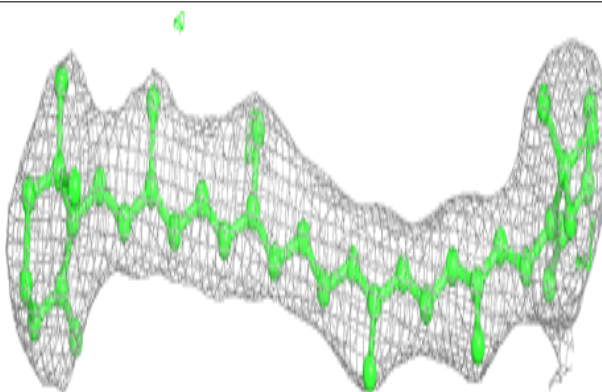

Electron density around CLA C 502:

$2mF_o-DF_c$ (at 0.7 rmsd) in gray
 mF_o-DF_c (at 3 rmsd) in purple (negative)
and green (positive)

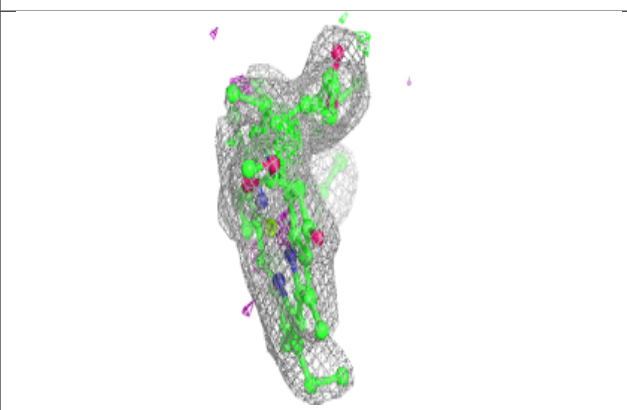
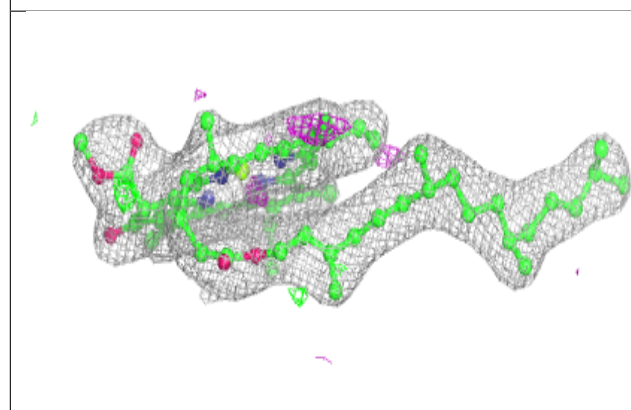
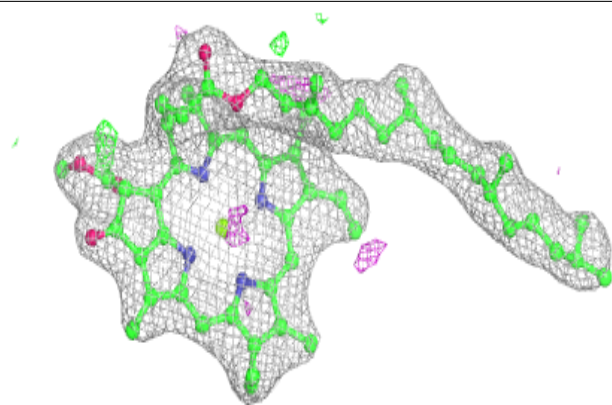
**Electron density around BCR T 101:**

$2mF_o-DF_c$ (at 0.7 rmsd) in gray
 mF_o-DF_c (at 3 rmsd) in purple (negative)
and green (positive)

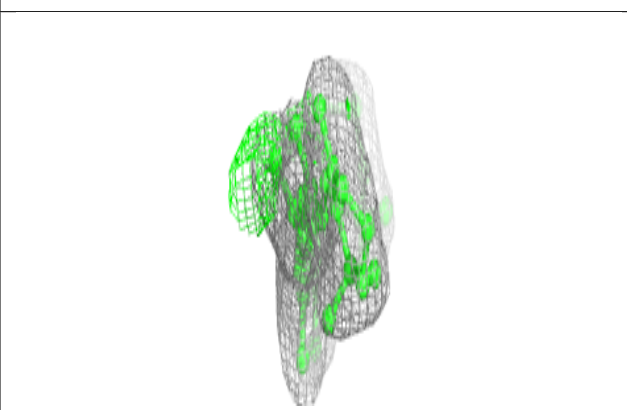
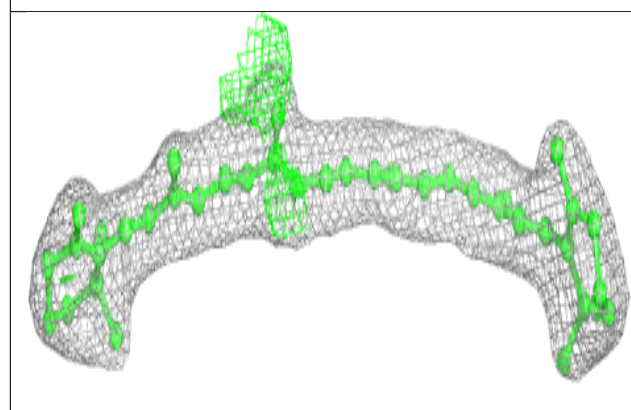
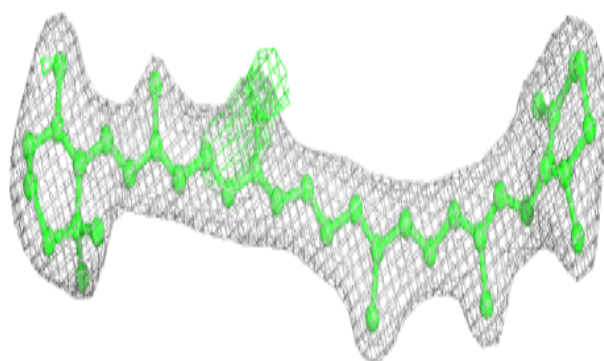

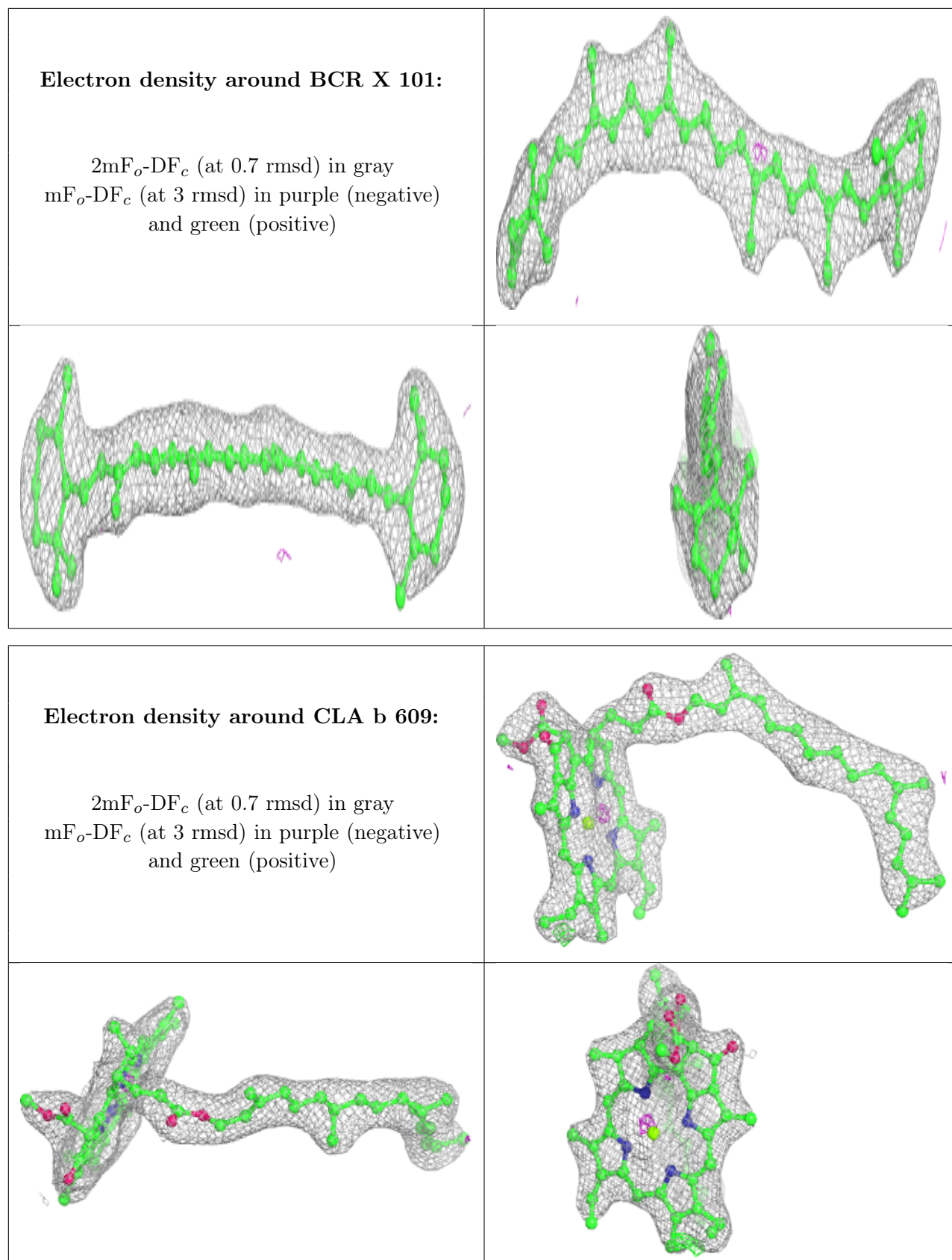

Electron density around CLA b 612:

$2mF_o-DF_c$ (at 0.7 rmsd) in gray
 mF_o-DF_c (at 3 rmsd) in purple (negative)
and green (positive)

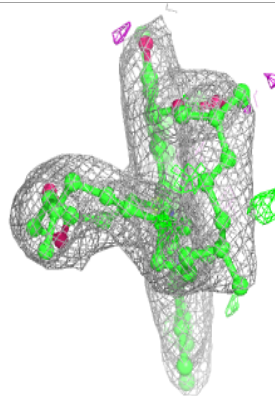
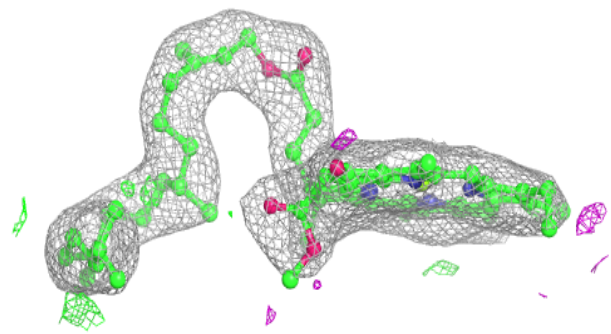
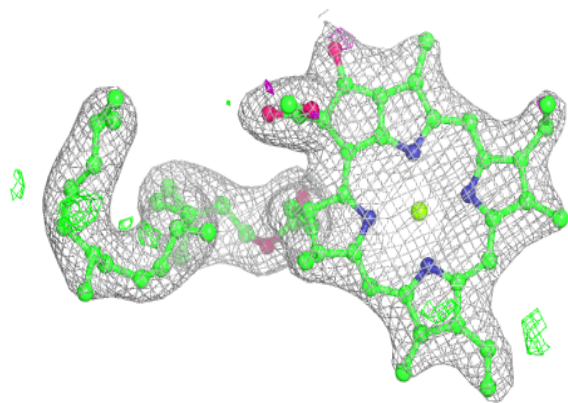

Electron density around SQD a 409 (A):

$2mF_o-DF_c$ (at 0.7 rmsd) in gray
 mF_o-DF_c (at 3 rmsd) in purple (negative)
and green (positive)

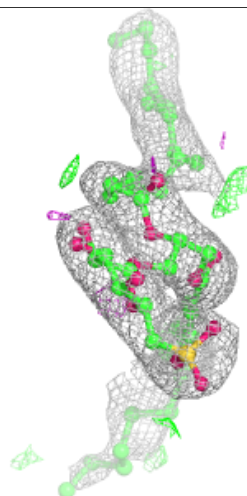
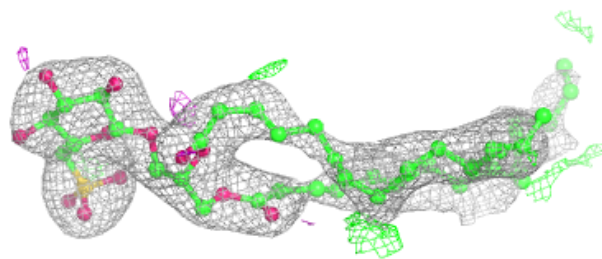
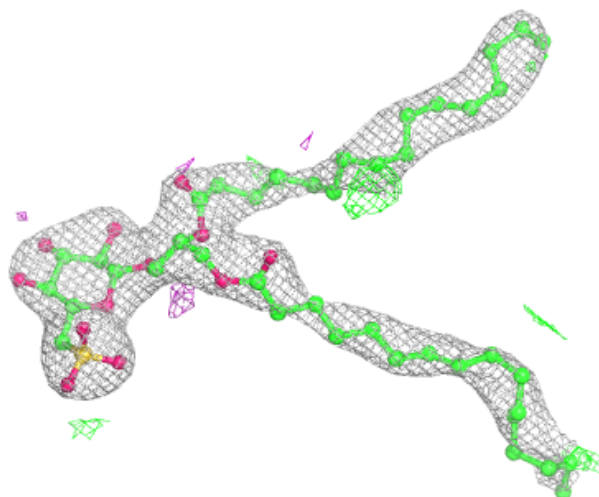

Electron density around SQD a 409 (B):

$2mF_o-DF_c$ (at 0.7 rmsd) in gray
 mF_o-DF_c (at 3 rmsd) in purple (negative)
and green (positive)

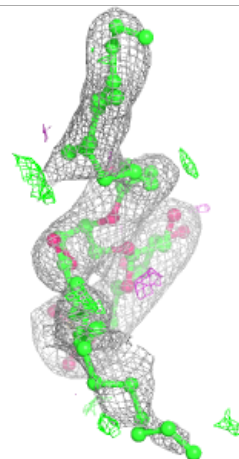
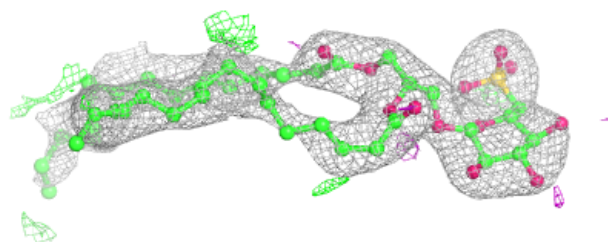
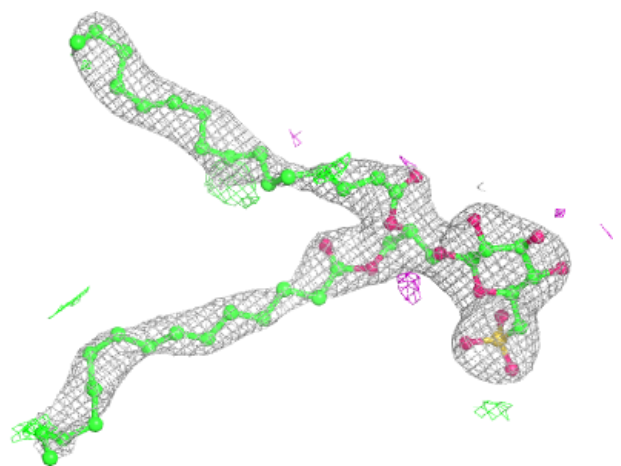

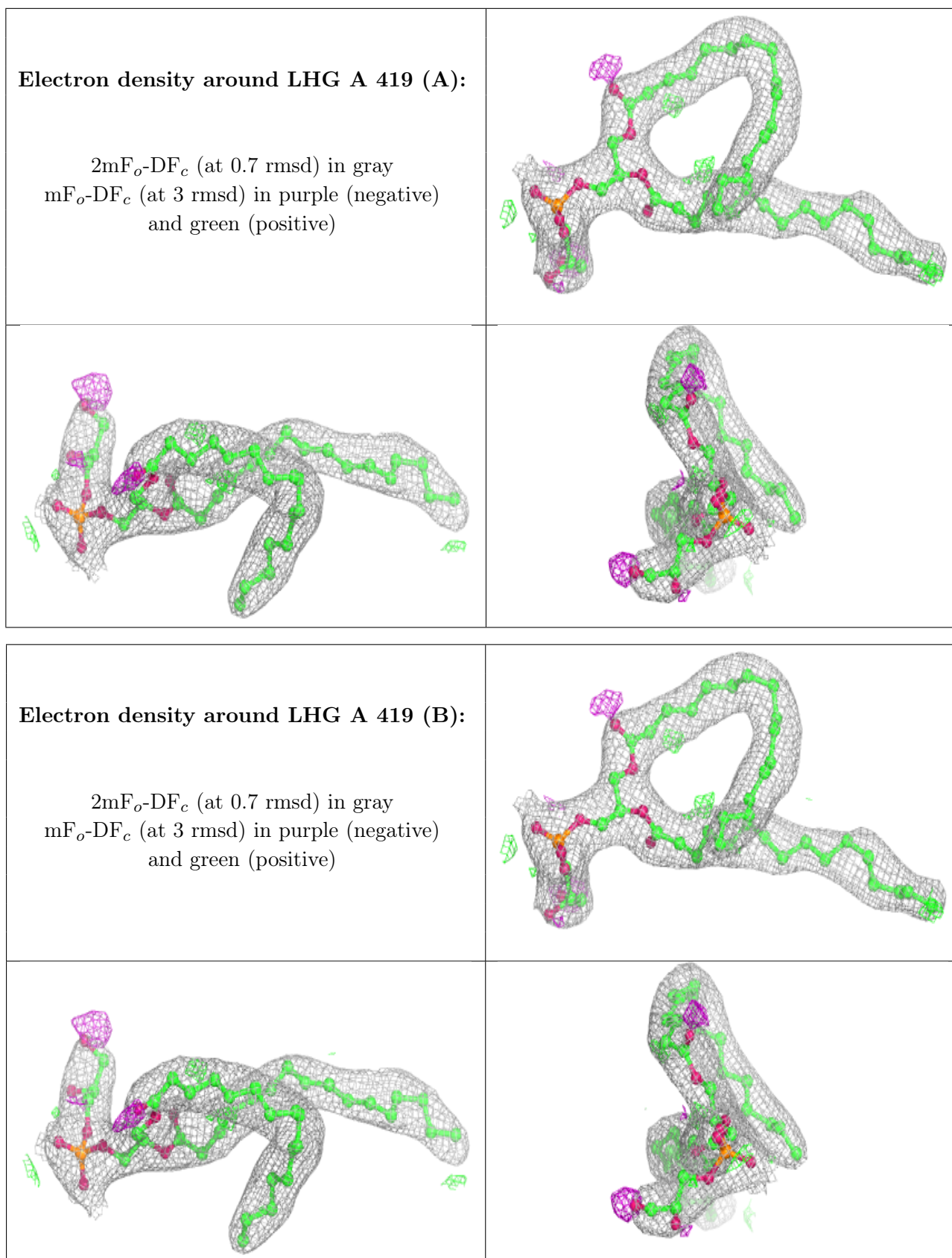

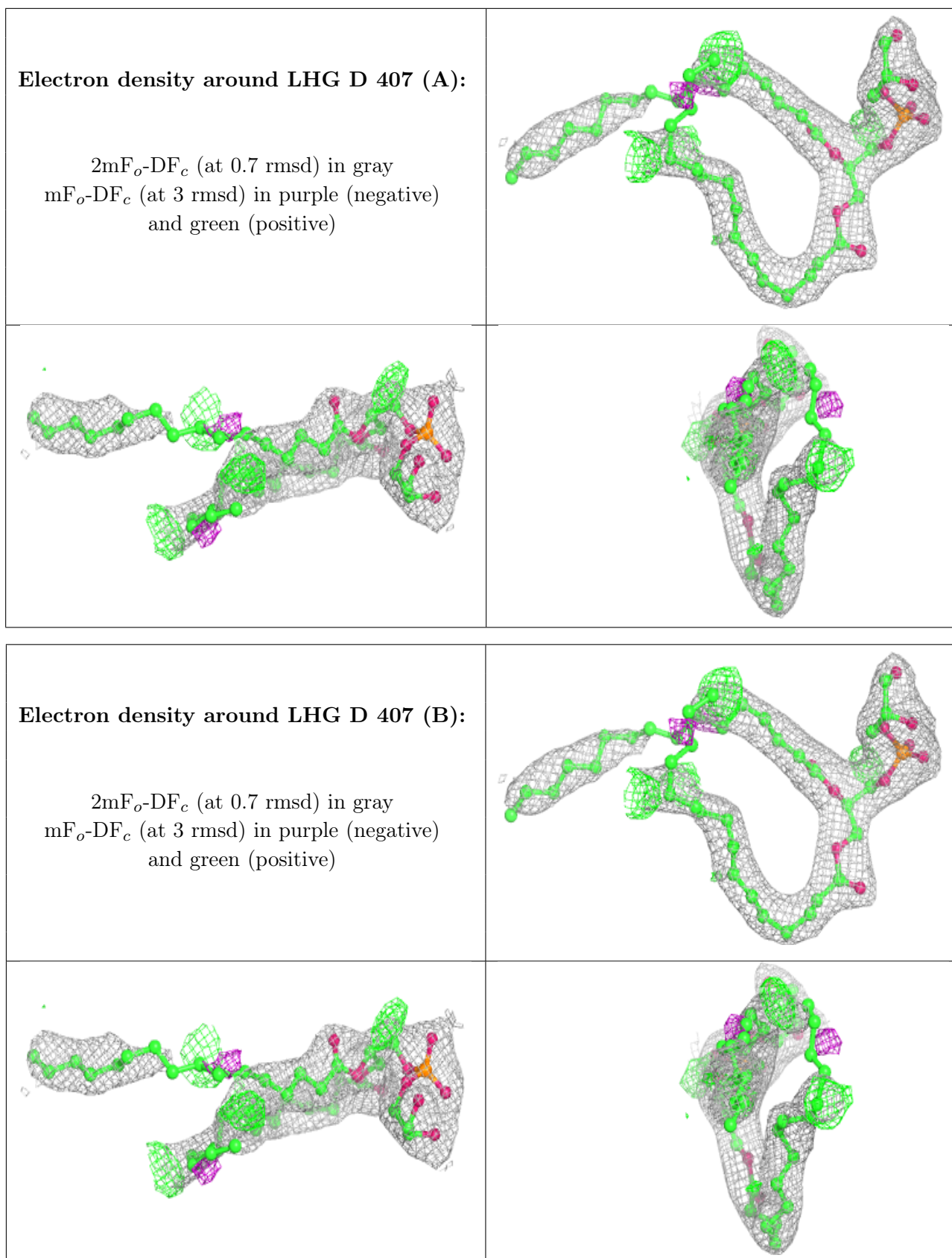

Electron density around CLA C 512:

$2mF_o-DF_c$ (at 0.7 rmsd) in gray
 mF_o-DF_c (at 3 rmsd) in purple (negative)
and green (positive)

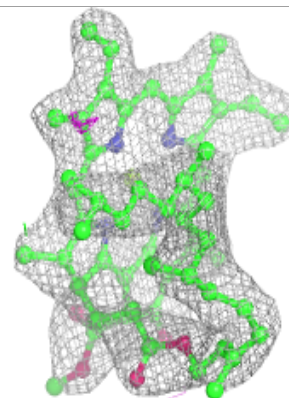
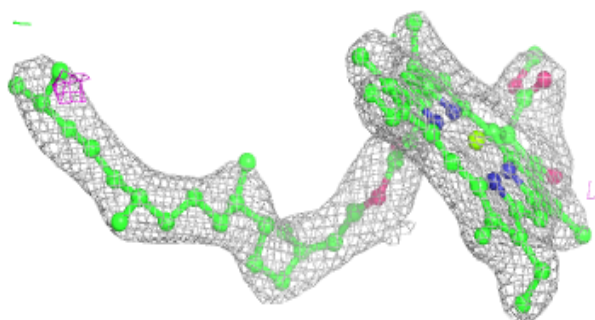
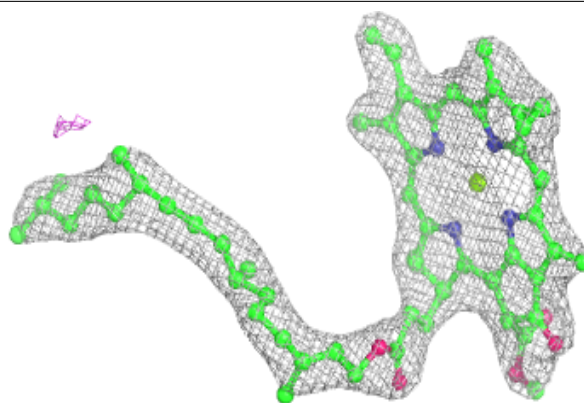
**Electron density around BCR c 517:**

$2mF_o-DF_c$ (at 0.7 rmsd) in gray
 mF_o-DF_c (at 3 rmsd) in purple (negative)
and green (positive)

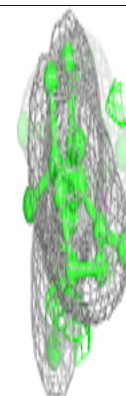
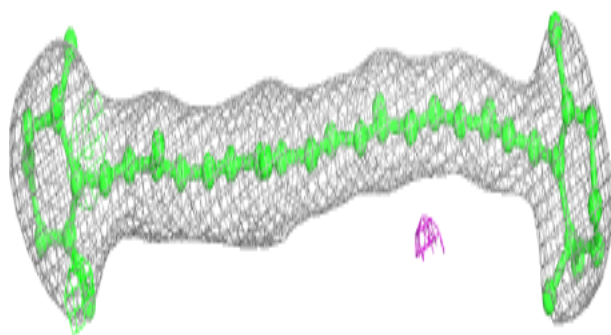
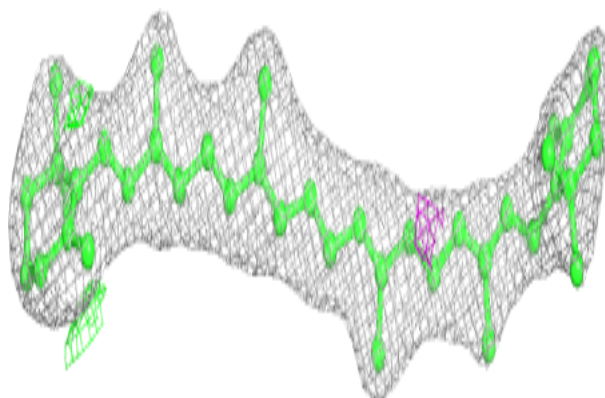

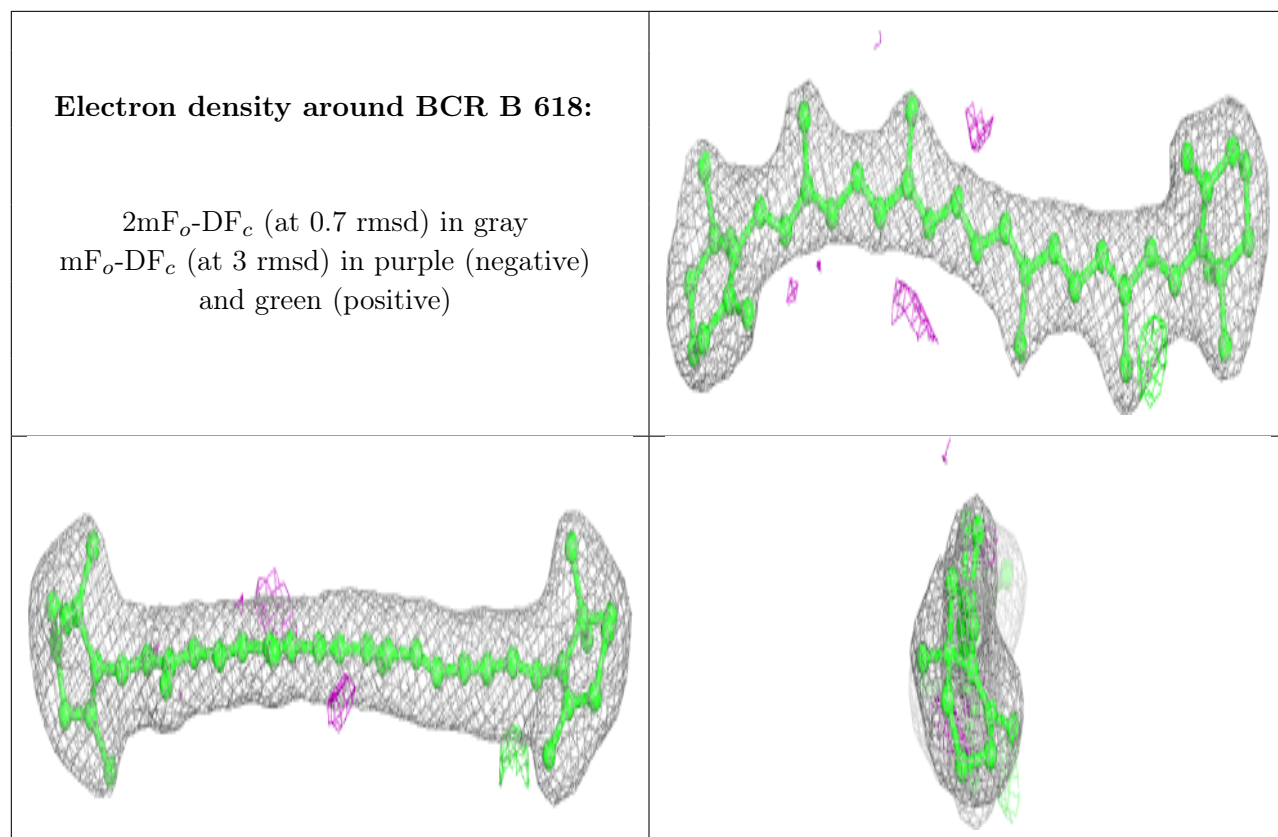

Electron density around LHG b 629 (A):

$2mF_o-DF_c$ (at 0.7 rmsd) in gray
 mF_o-DF_c (at 3 rmsd) in purple (negative)
and green (positive)

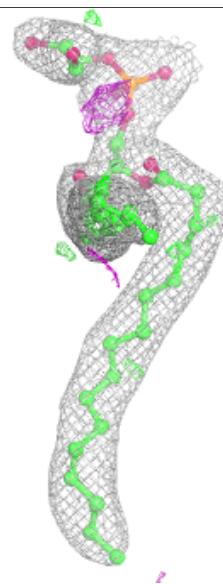
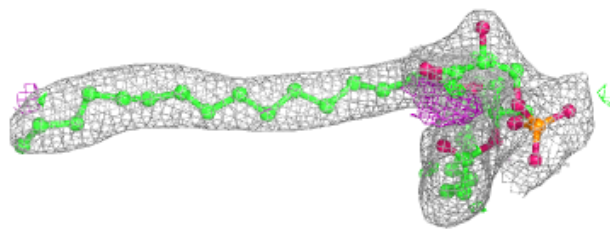
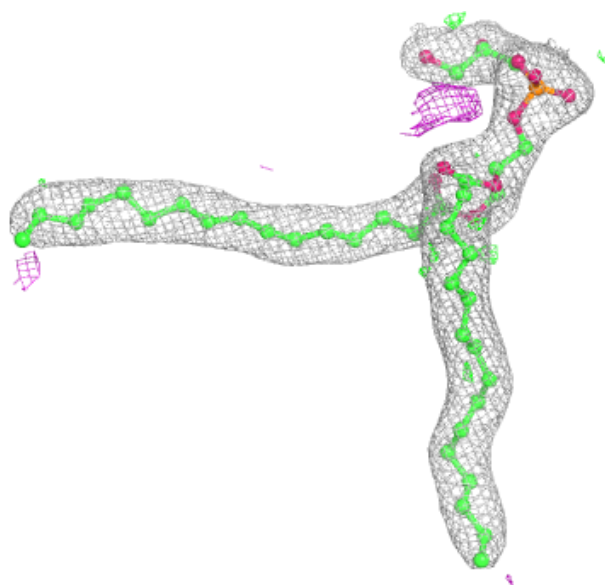

Electron density around LHG b 629 (B):

$2mF_o-DF_c$ (at 0.7 rmsd) in gray
 mF_o-DF_c (at 3 rmsd) in purple (negative)
and green (positive)

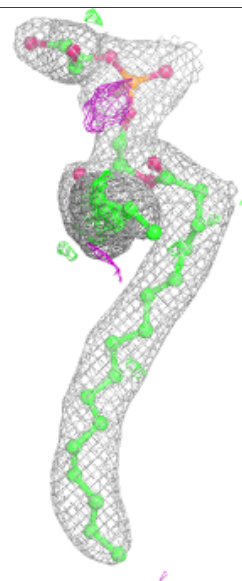
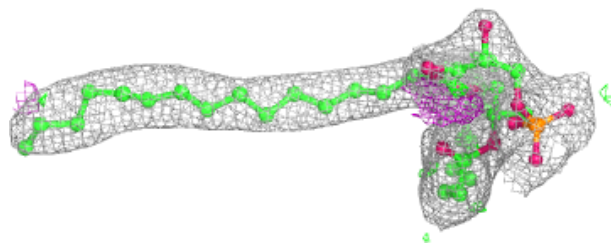
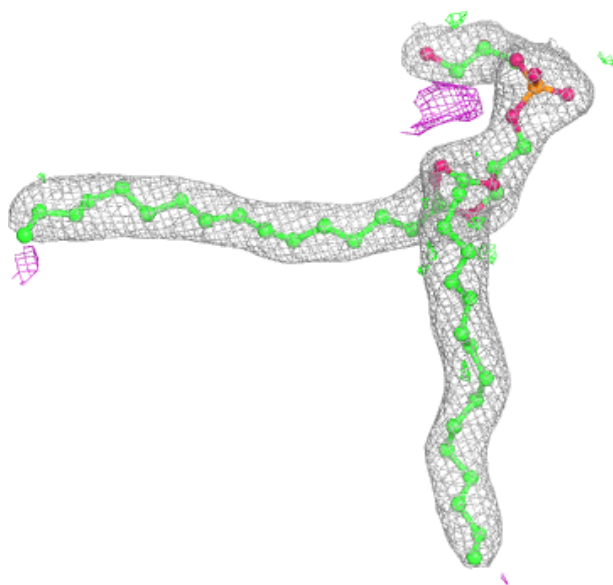

Electron density around LHG d 407 (A):

$2mF_o-DF_c$ (at 0.7 rmsd) in gray
 mF_o-DF_c (at 3 rmsd) in purple (negative)
and green (positive)

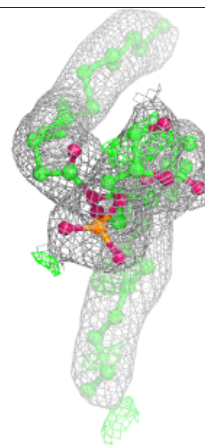
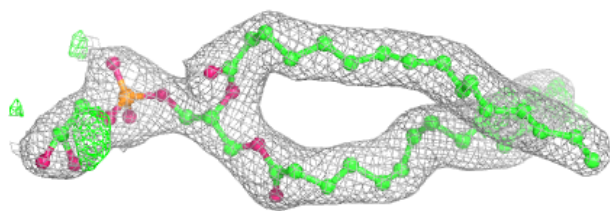
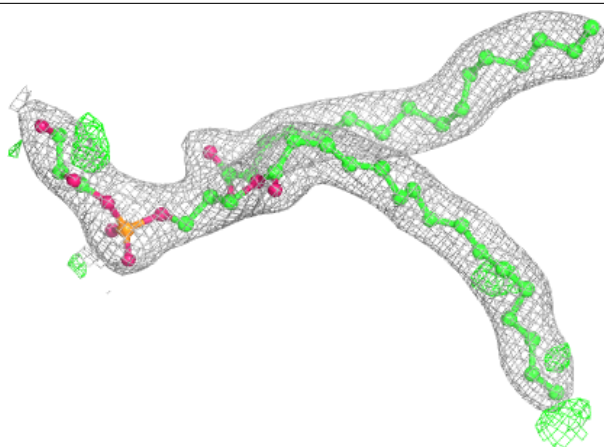

Electron density around LHG d 407 (B):

$2mF_o-DF_c$ (at 0.7 rmsd) in gray
 mF_o-DF_c (at 3 rmsd) in purple (negative)
and green (positive)

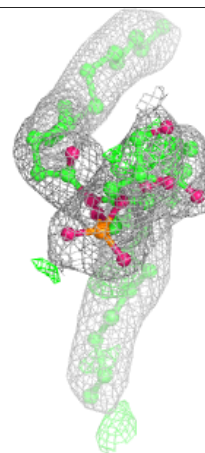
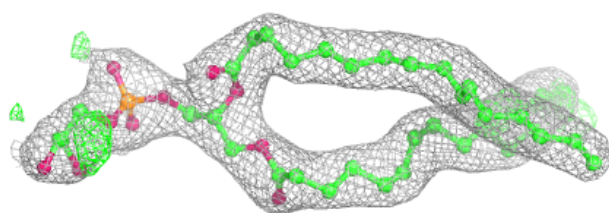
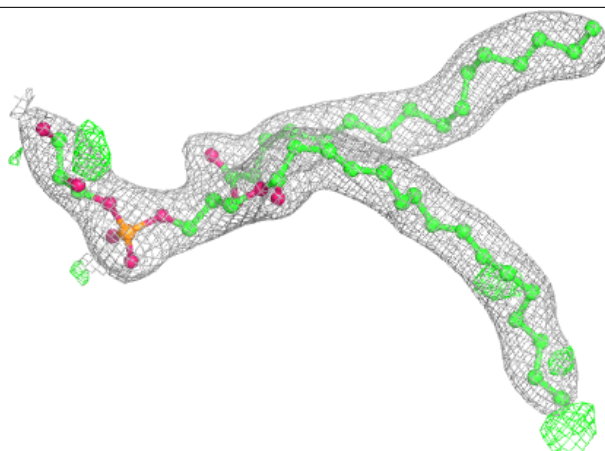
**Electron density around LHG d 408 (A):**

$2mF_o-DF_c$ (at 0.7 rmsd) in gray
 mF_o-DF_c (at 3 rmsd) in purple (negative)
and green (positive)

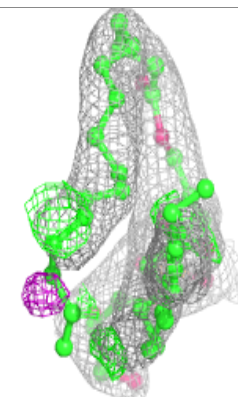
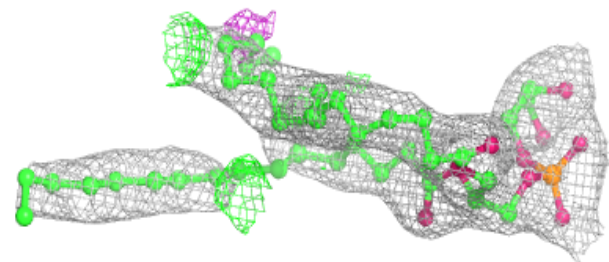
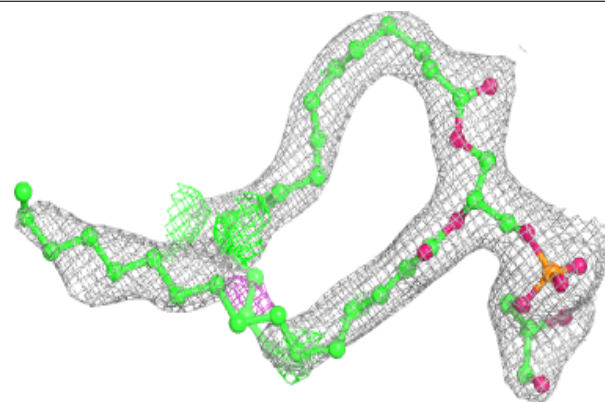

Electron density around LHG d 408 (B):

$2mF_o-DF_c$ (at 0.7 rmsd) in gray
 mF_o-DF_c (at 3 rmsd) in purple (negative)
and green (positive)

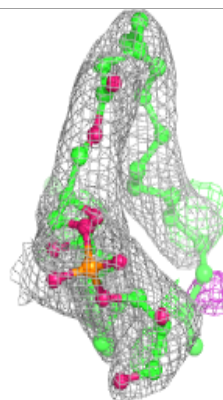
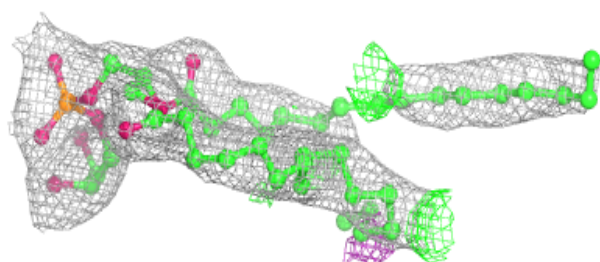
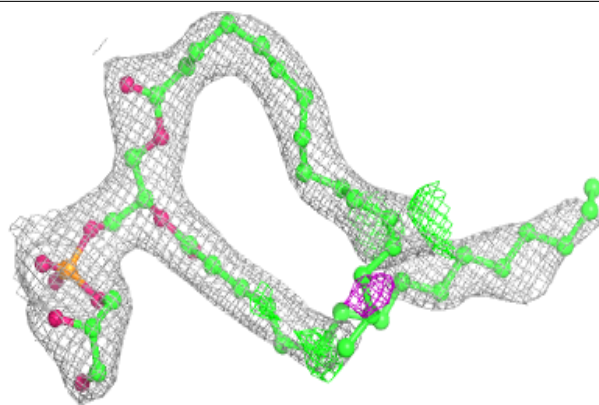
**Electron density around DGD c 518 (A):**

$2mF_o-DF_c$ (at 0.7 rmsd) in gray
 mF_o-DF_c (at 3 rmsd) in purple (negative)
and green (positive)

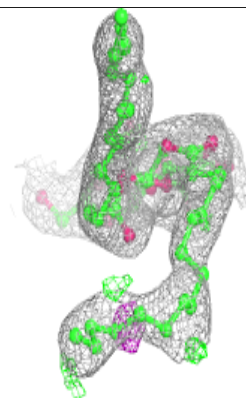
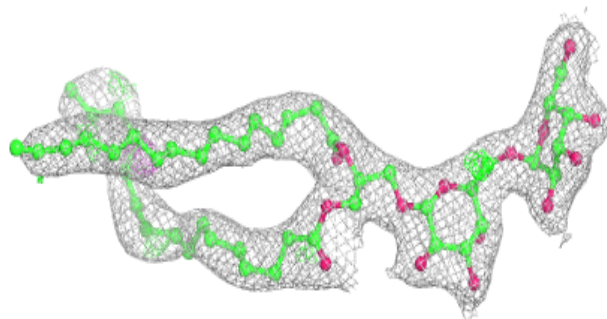
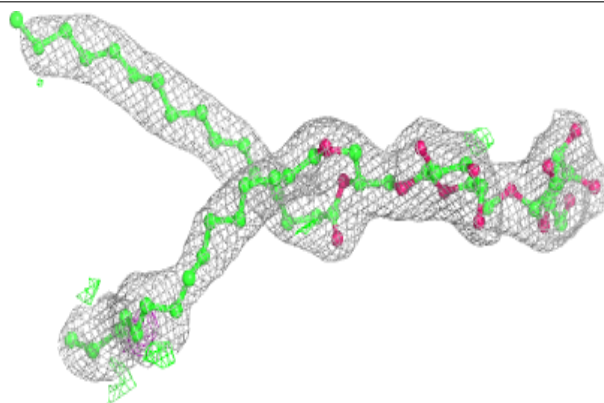

Electron density around DGD c 518 (B):

$2mF_o-DF_c$ (at 0.7 rmsd) in gray
 mF_o-DF_c (at 3 rmsd) in purple (negative)
and green (positive)

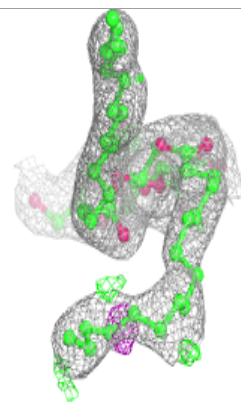
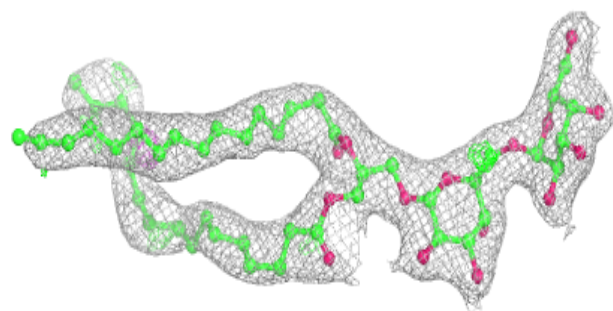
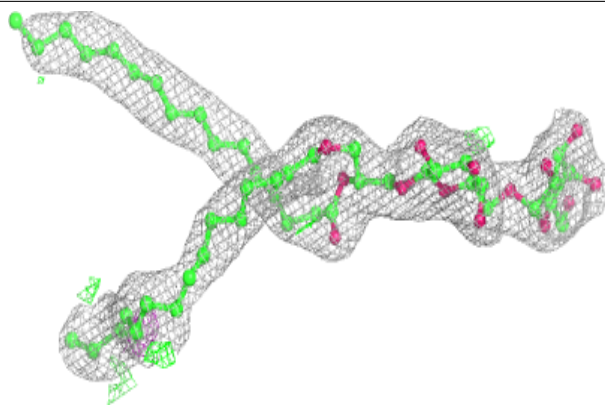
**Electron density around LHG d 414 (A):**

$2mF_o-DF_c$ (at 0.7 rmsd) in gray
 mF_o-DF_c (at 3 rmsd) in purple (negative)
and green (positive)

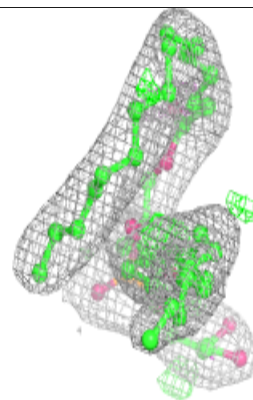
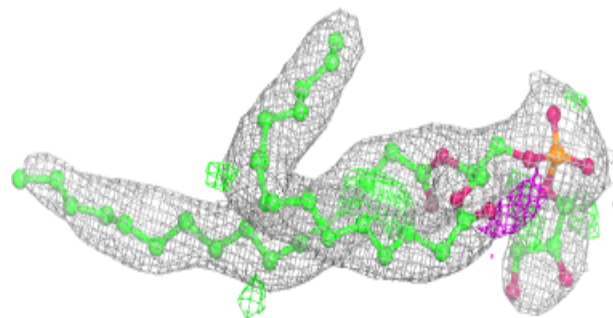
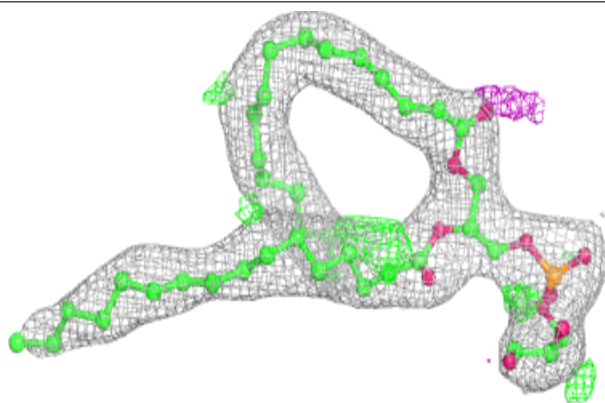

Electron density around LHG d 414 (B):

$2mF_o-DF_c$ (at 0.7 rmsd) in gray
 mF_o-DF_c (at 3 rmsd) in purple (negative)
and green (positive)

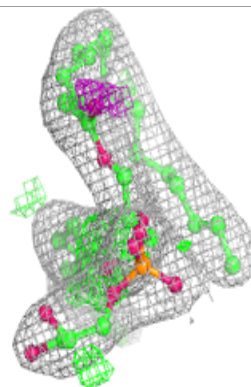
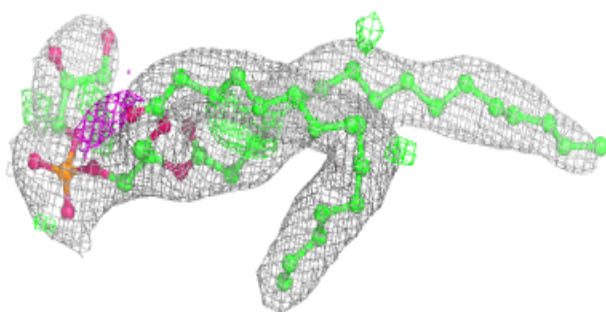
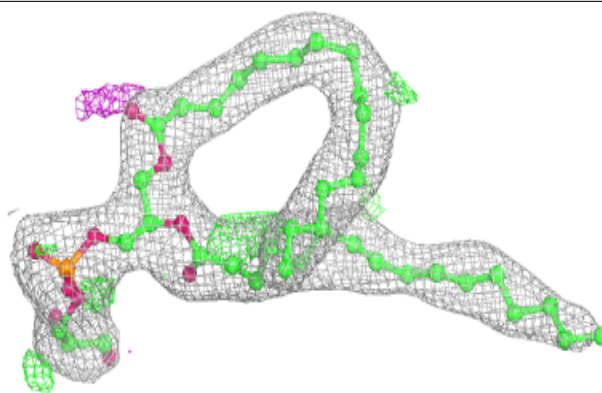
**Electron density around CLA c 506:**

$2mF_o-DF_c$ (at 0.7 rmsd) in gray
 mF_o-DF_c (at 3 rmsd) in purple (negative)
and green (positive)

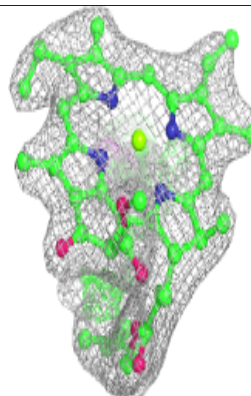
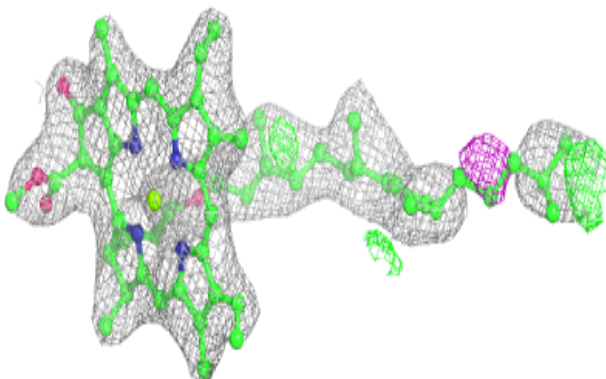
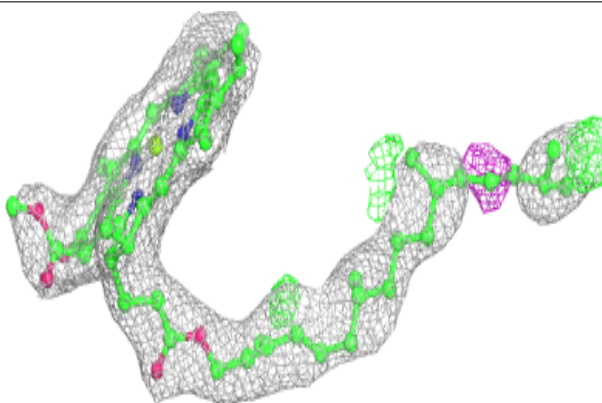

Electron density around CLA C 508:

$2mF_o-DF_c$ (at 0.7 rmsd) in gray
 mF_o-DF_c (at 3 rmsd) in purple (negative)
and green (positive)

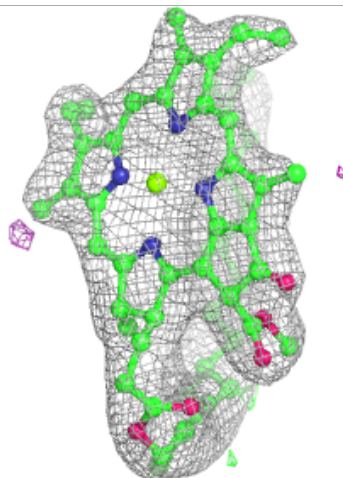
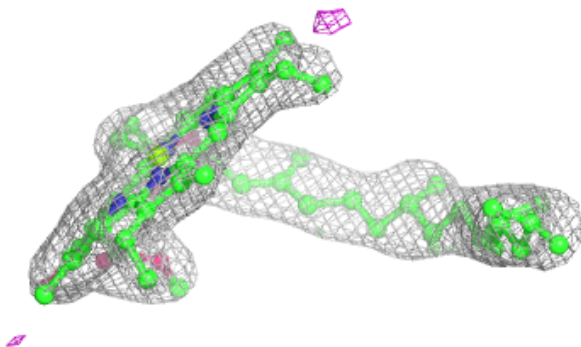
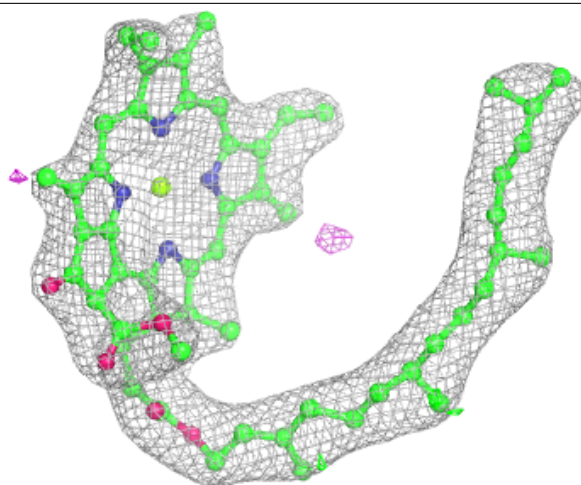

Electron density around BCR t 102:

$2mF_o-DF_c$ (at 0.7 rmsd) in gray
 mF_o-DF_c (at 3 rmsd) in purple (negative)
and green (positive)

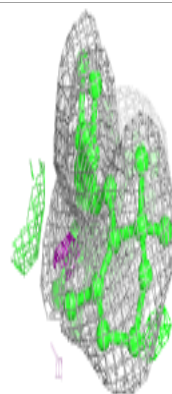
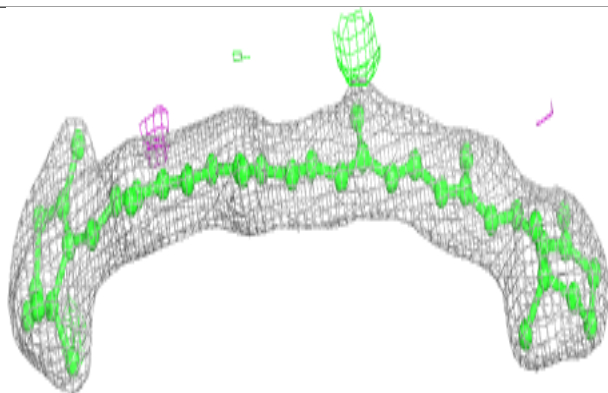
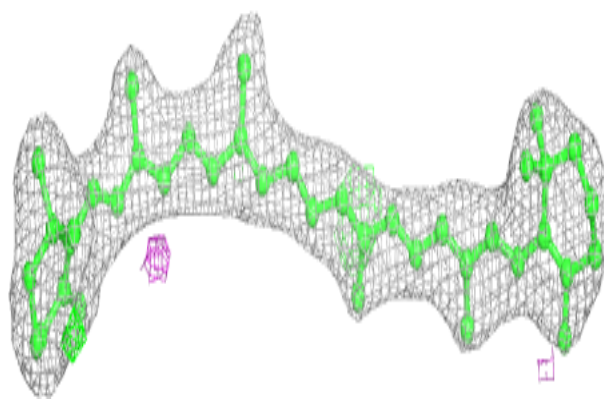
**Electron density around CLA c 510:**

$2mF_o-DF_c$ (at 0.7 rmsd) in gray
 mF_o-DF_c (at 3 rmsd) in purple (negative)
and green (positive)

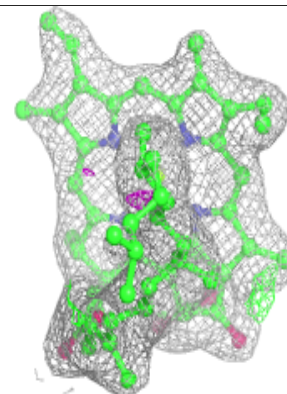
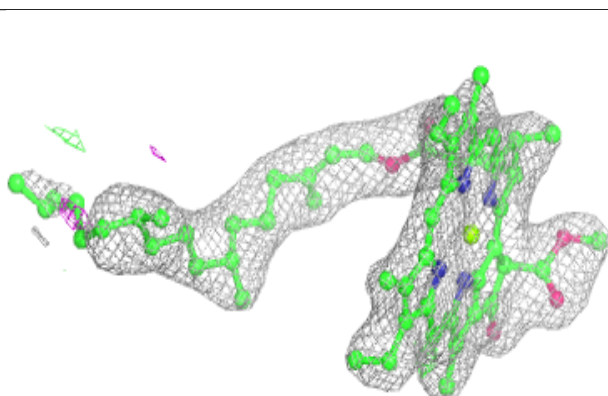
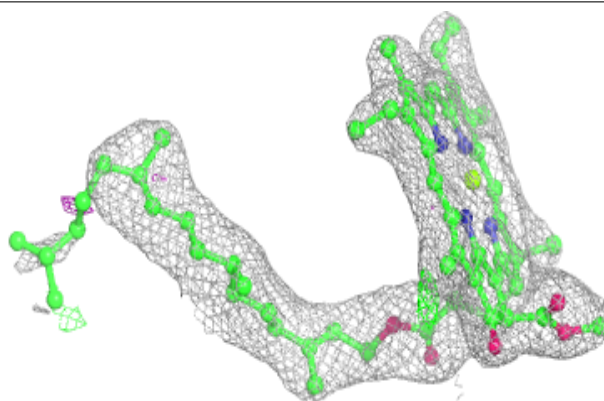

Electron density around HEM f 101:

$2mF_o-DF_c$ (at 0.7 rmsd) in gray
 mF_o-DF_c (at 3 rmsd) in purple (negative)
and green (positive)

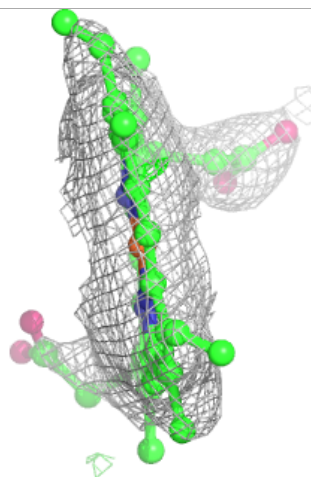
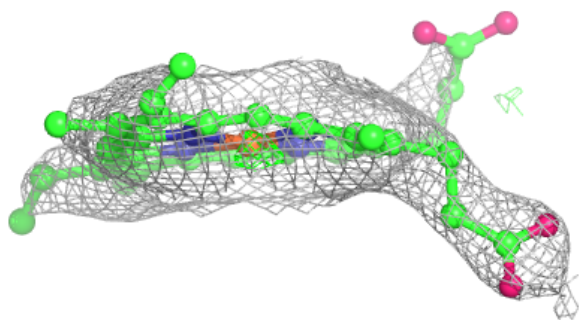
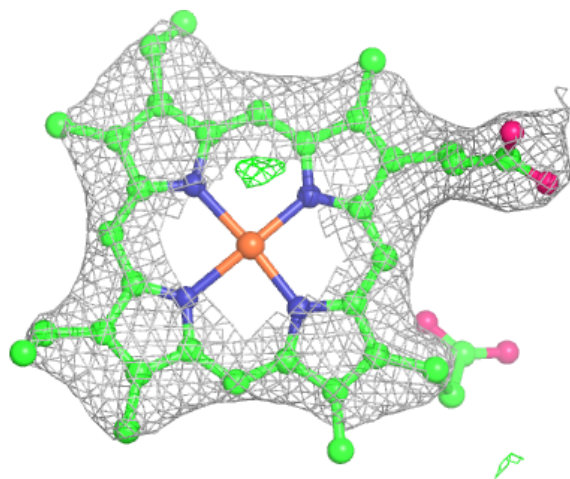

Electron density around BCR b 617:

$2mF_o-DF_c$ (at 0.7 rmsd) in gray
 mF_o-DF_c (at 3 rmsd) in purple (negative)
and green (positive)

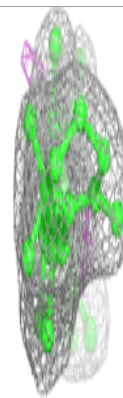
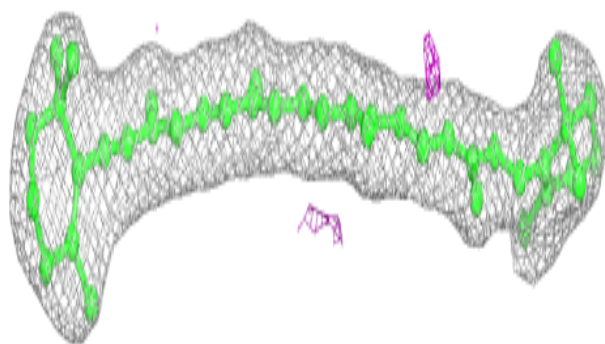
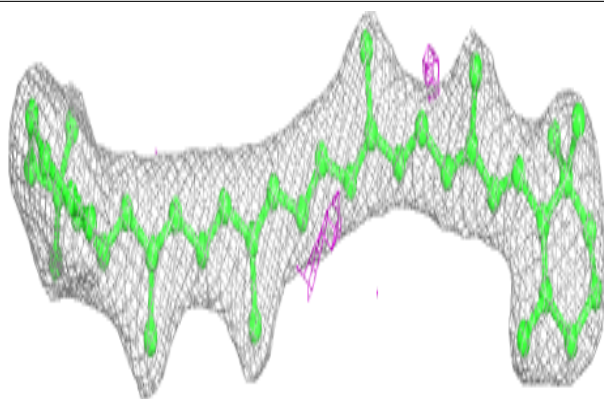

Electron density around CLA b 611:

$2mF_o-DF_c$ (at 0.7 rmsd) in gray
 mF_o-DF_c (at 3 rmsd) in purple (negative)
and green (positive)

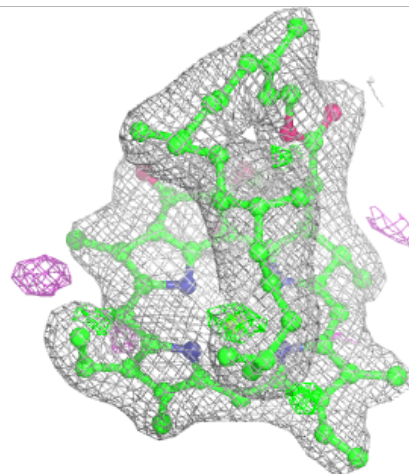
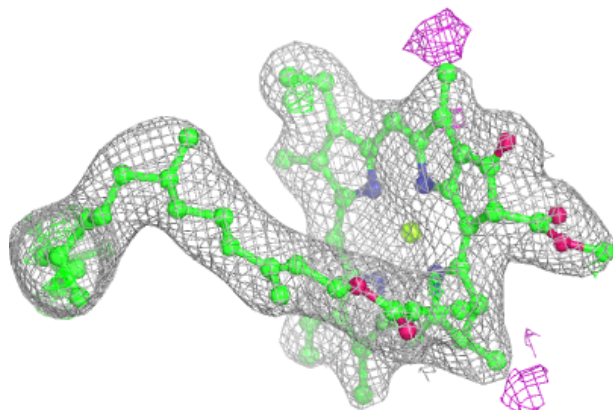
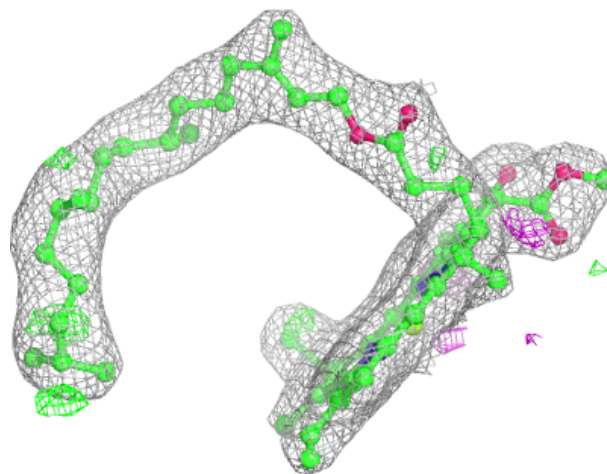

Electron density around BCR b 619:

$2mF_o-DF_c$ (at 0.7 rmsd) in gray
 mF_o-DF_c (at 3 rmsd) in purple (negative)
and green (positive)

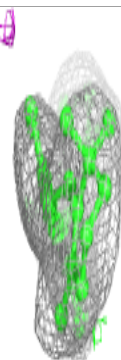
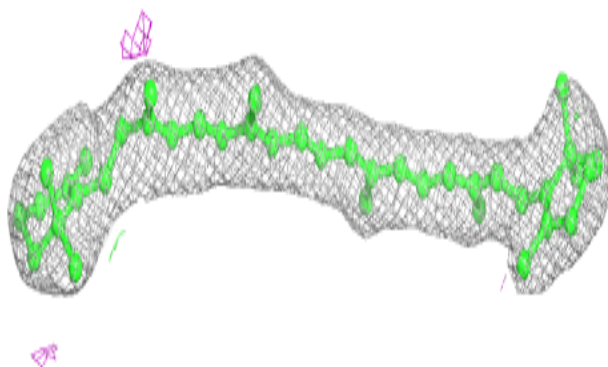
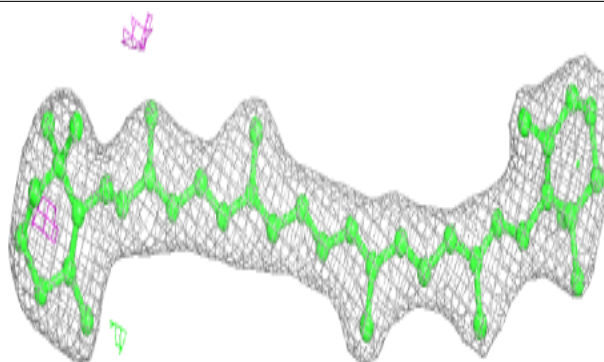
**Electron density around CLA C 510:**

$2mF_o-DF_c$ (at 0.7 rmsd) in gray
 mF_o-DF_c (at 3 rmsd) in purple (negative)
and green (positive)

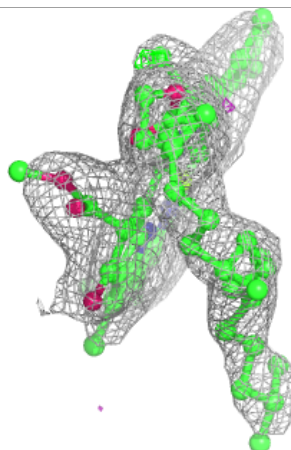
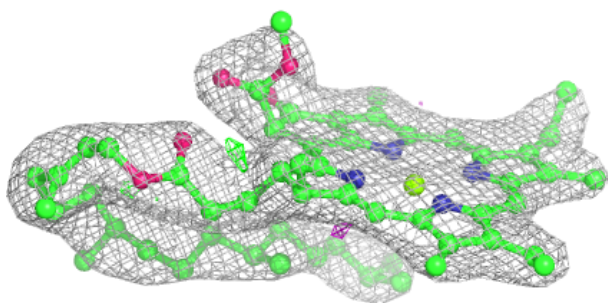
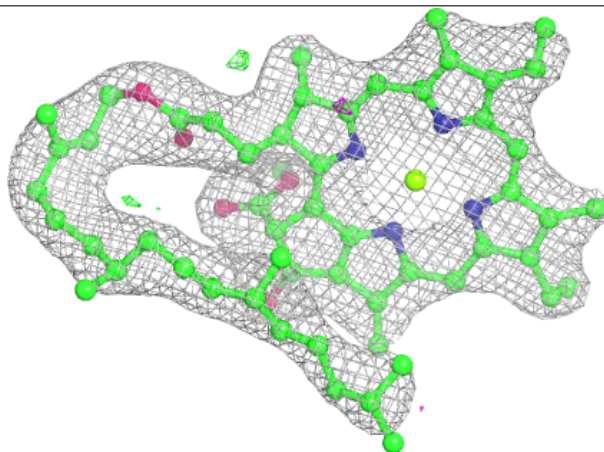

Electron density around CLA b 614:

$2mF_o-DF_c$ (at 0.7 rmsd) in gray
 mF_o-DF_c (at 3 rmsd) in purple (negative)
and green (positive)

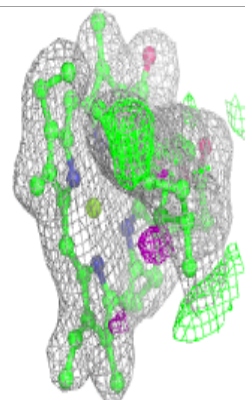
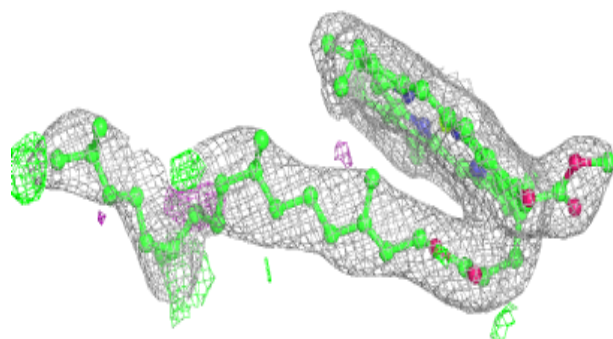
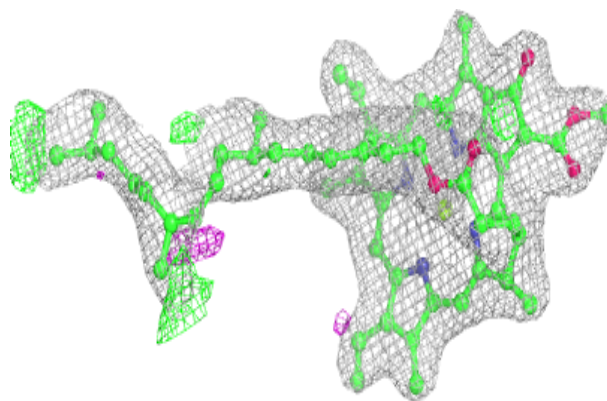
**Electron density around CLA b 615:**

$2mF_o-DF_c$ (at 0.7 rmsd) in gray
 mF_o-DF_c (at 3 rmsd) in purple (negative)
and green (positive)

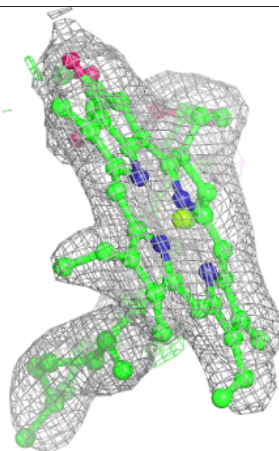
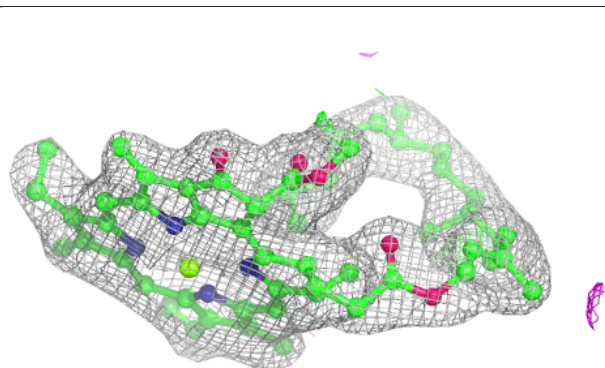
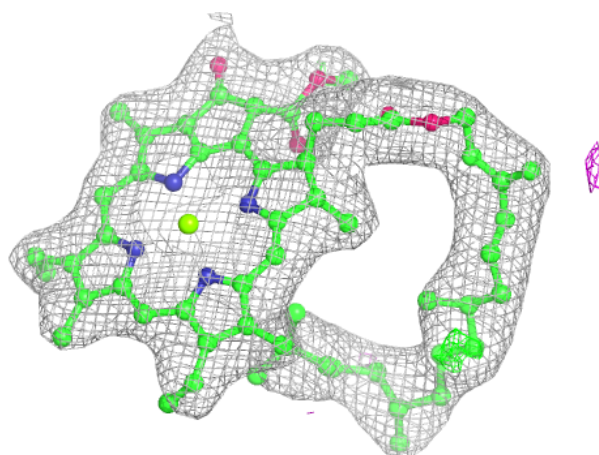

Electron density around CLA C 511:

$2mF_o-DF_c$ (at 0.7 rmsd) in gray
 mF_o-DF_c (at 3 rmsd) in purple (negative)
and green (positive)

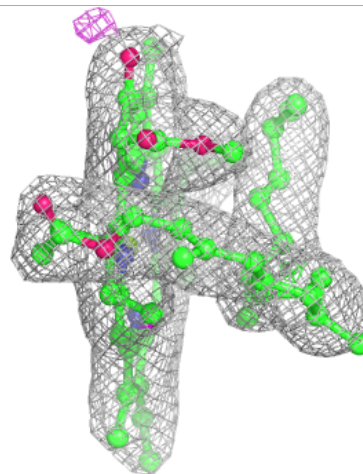
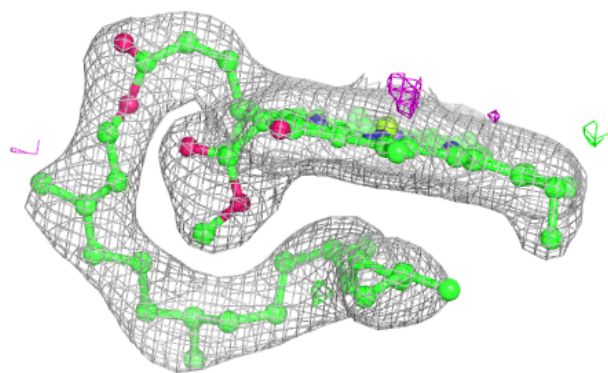
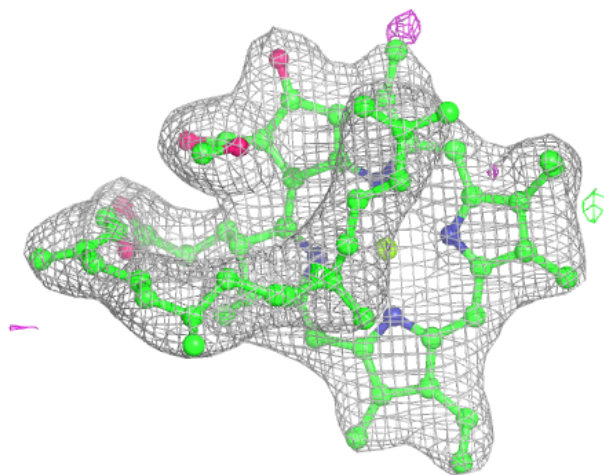

Electron density around CLA c 503:

$2mF_o-DF_c$ (at 0.7 rmsd) in gray
 mF_o-DF_c (at 3 rmsd) in purple (negative)
and green (positive)

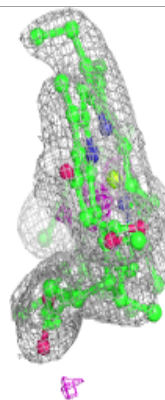
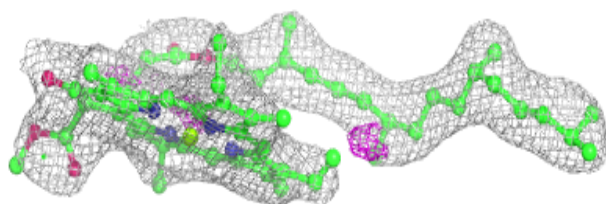
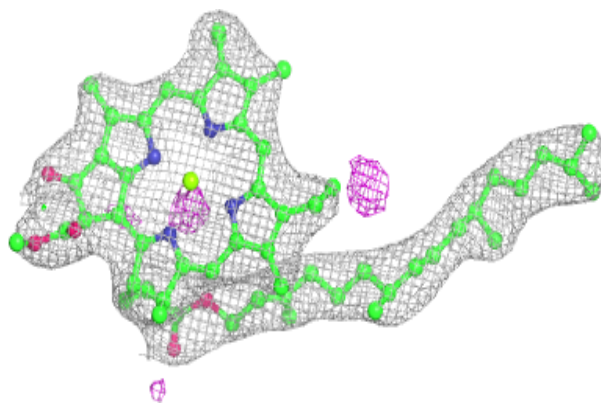

Electron density around CLA c 505:

$2mF_o-DF_c$ (at 0.7 rmsd) in gray
 mF_o-DF_c (at 3 rmsd) in purple (negative)
and green (positive)

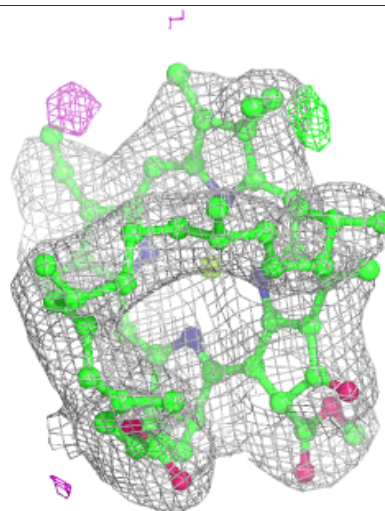
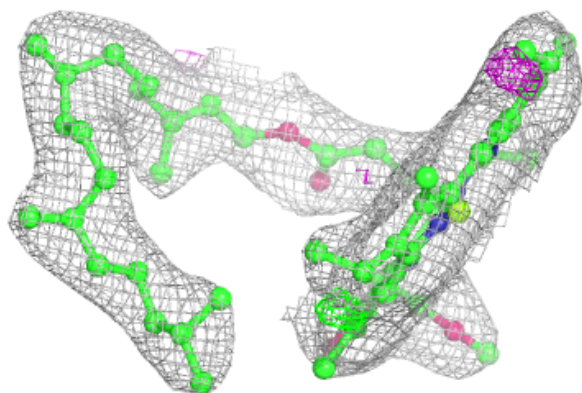
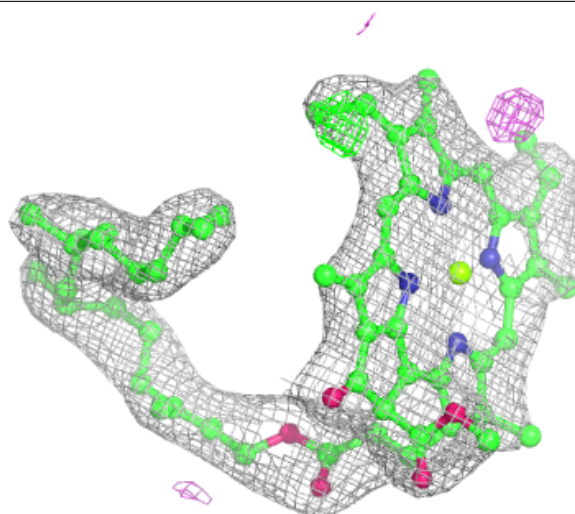

Electron density around CLA B 612:

$2mF_o-DF_c$ (at 0.7 rmsd) in gray
 mF_o-DF_c (at 3 rmsd) in purple (negative)
and green (positive)

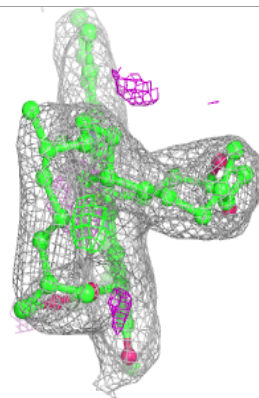
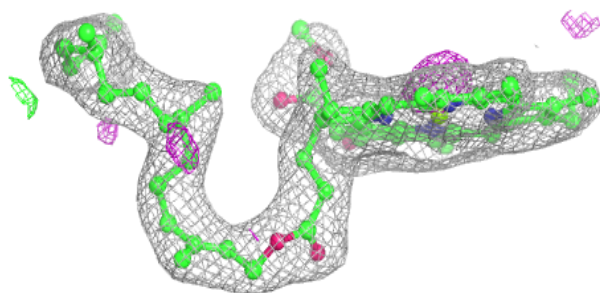
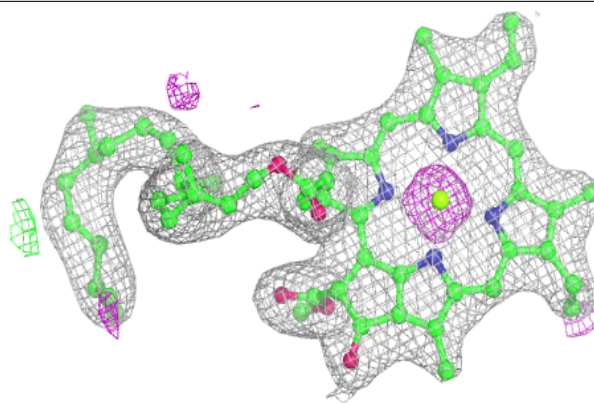
**Electron density around CLA c 507:**

$2mF_o-DF_c$ (at 0.7 rmsd) in gray
 mF_o-DF_c (at 3 rmsd) in purple (negative)
and green (positive)

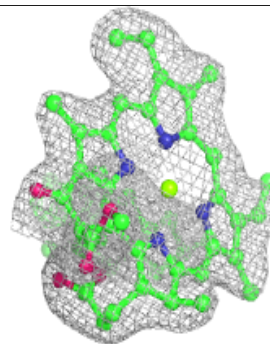
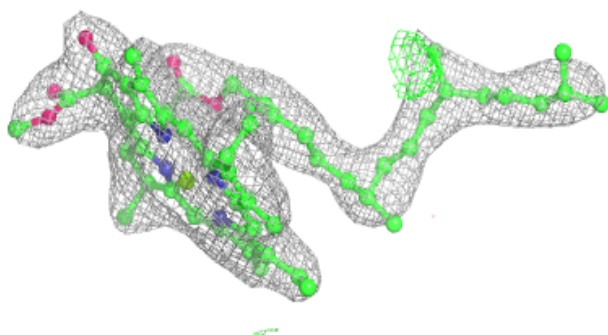
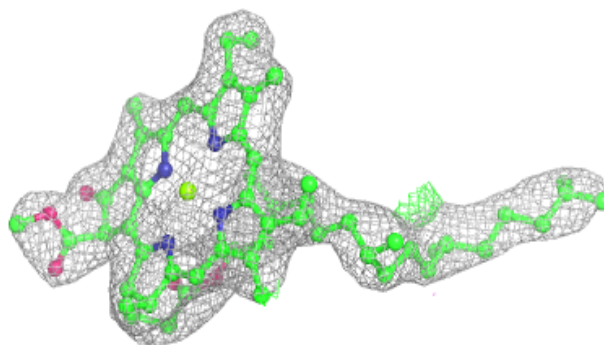

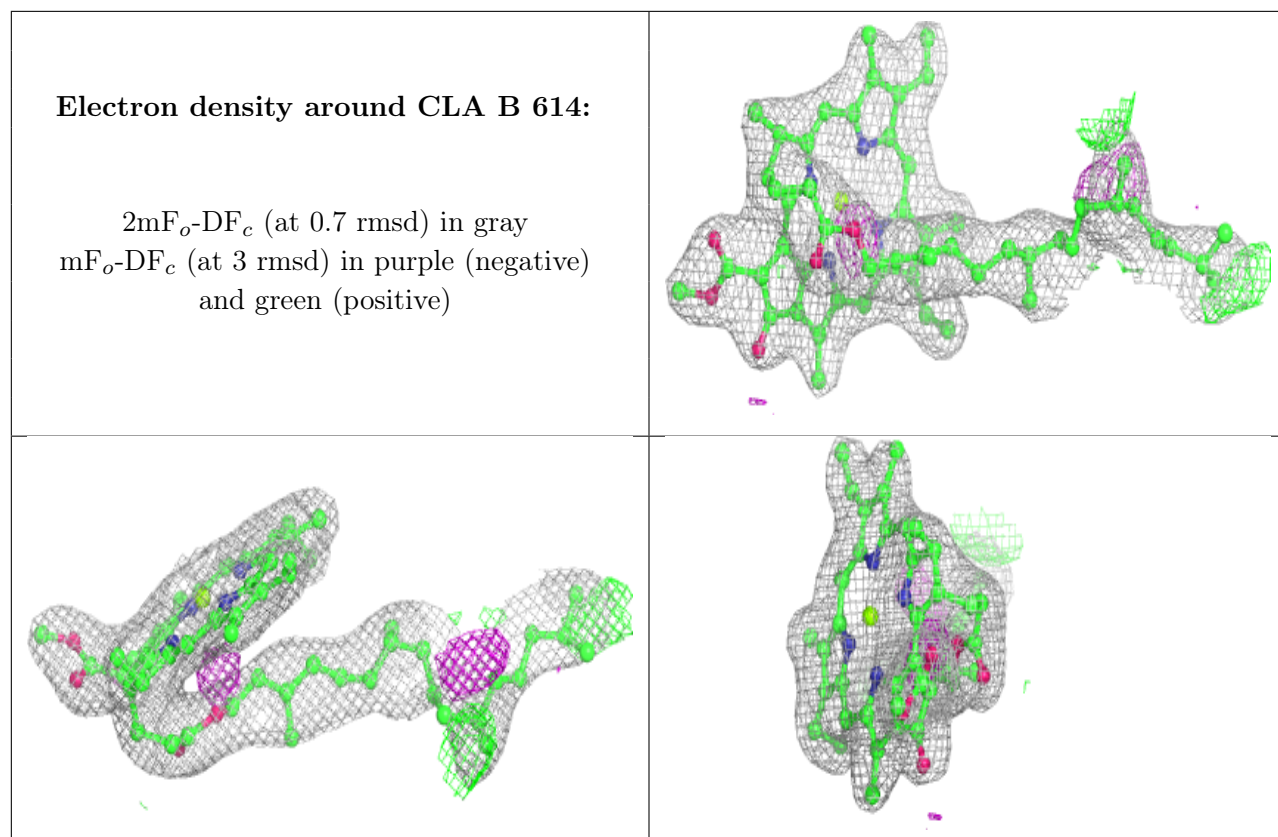

Electron density around CLA c 509:

$2mF_o-DF_c$ (at 0.7 rmsd) in gray
 mF_o-DF_c (at 3 rmsd) in purple (negative)
and green (positive)

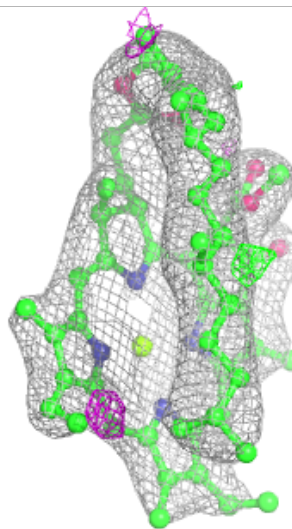
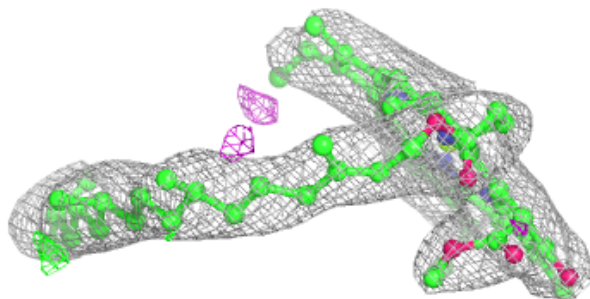
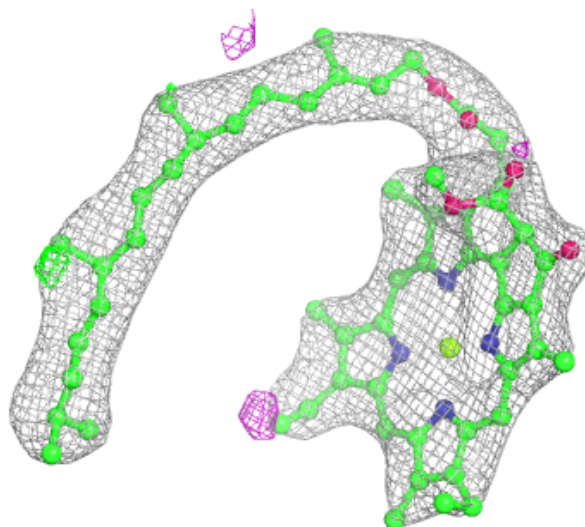

Electron density around CLA B 603:

$2mF_o-DF_c$ (at 0.7 rmsd) in gray
 mF_o-DF_c (at 3 rmsd) in purple (negative)
and green (positive)

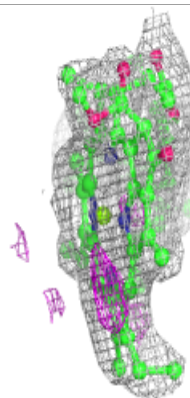
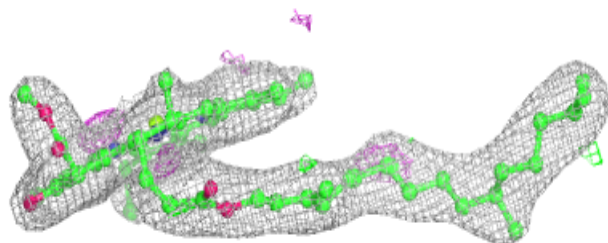
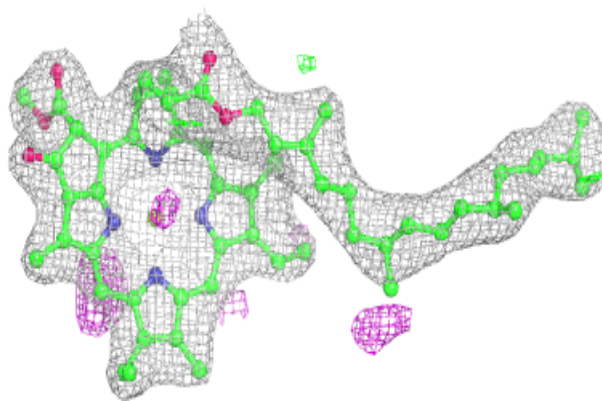
**Electron density around CLA c 511:**

$2mF_o-DF_c$ (at 0.7 rmsd) in gray
 mF_o-DF_c (at 3 rmsd) in purple (negative)
and green (positive)

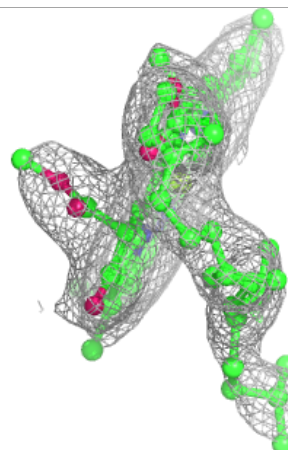
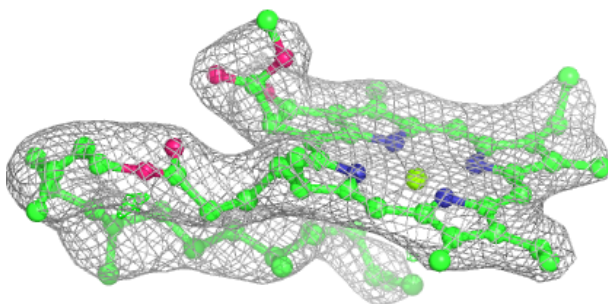
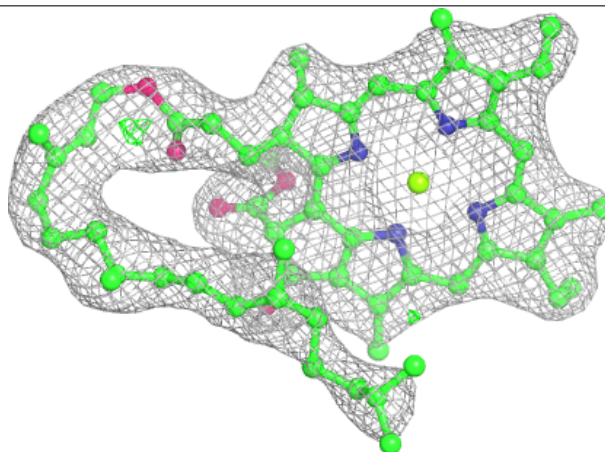

Electron density around PL9 D 405 (A):

$2mF_o-DF_c$ (at 0.7 rmsd) in gray
 mF_o-DF_c (at 3 rmsd) in purple (negative)
and green (positive)

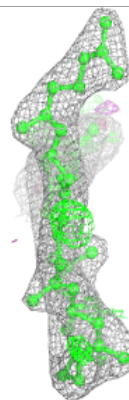
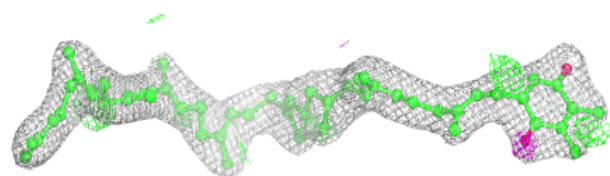
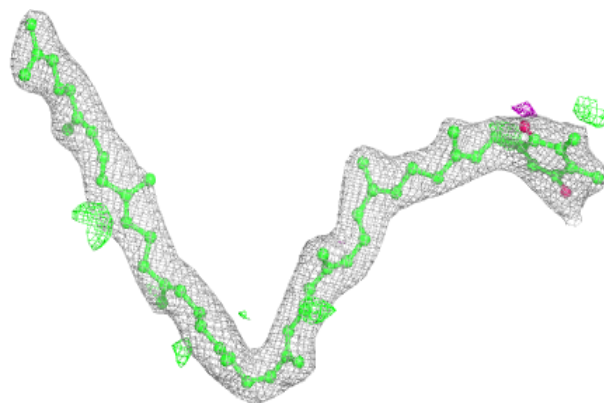
**Electron density around PL9 D 405 (B):**

$2mF_o-DF_c$ (at 0.7 rmsd) in gray
 mF_o-DF_c (at 3 rmsd) in purple (negative)
and green (positive)

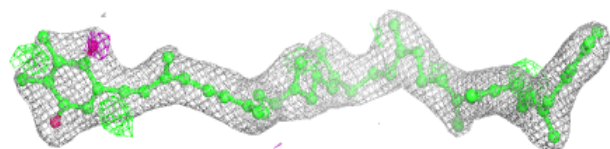
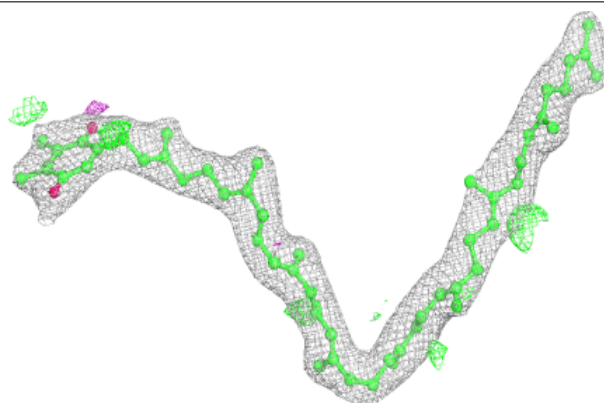

Electron density around CLA c 513:

$2mF_o-DF_c$ (at 0.7 rmsd) in gray
 mF_o-DF_c (at 3 rmsd) in purple (negative)
and green (positive)

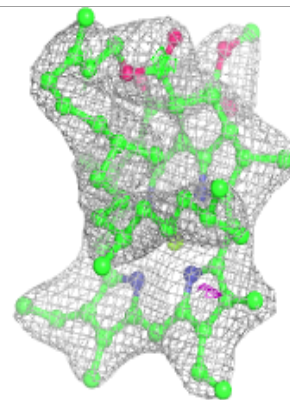
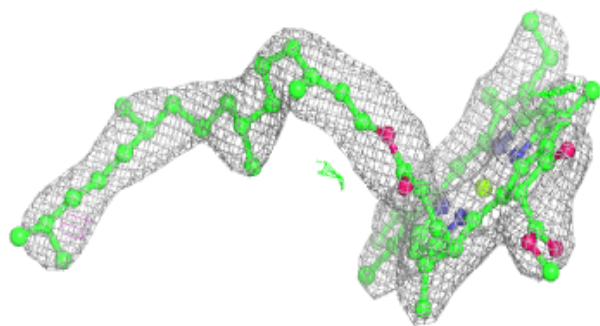
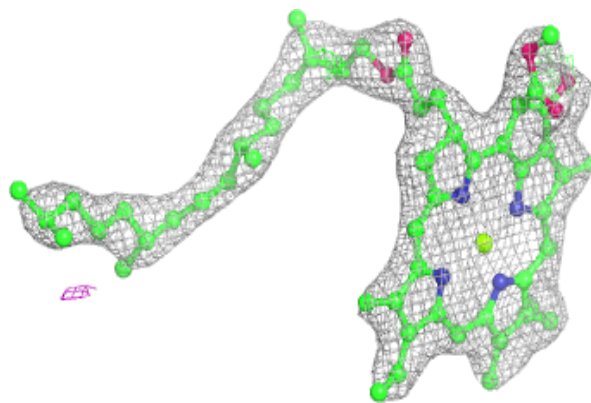
**Electron density around CLA A 406 (A):**

$2mF_o-DF_c$ (at 0.7 rmsd) in gray
 mF_o-DF_c (at 3 rmsd) in purple (negative)
and green (positive)

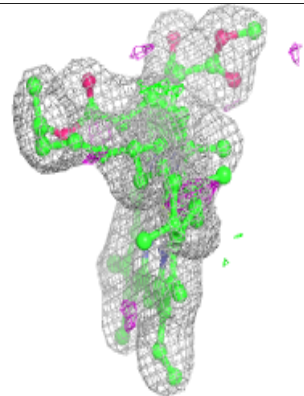
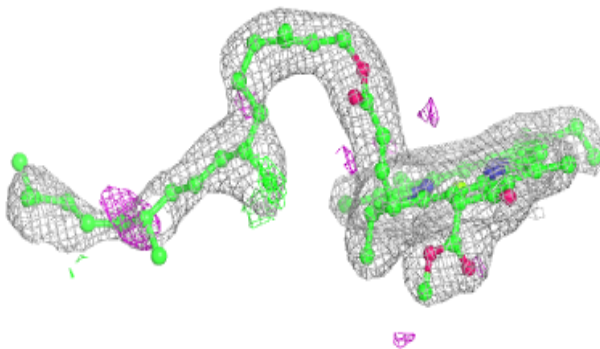
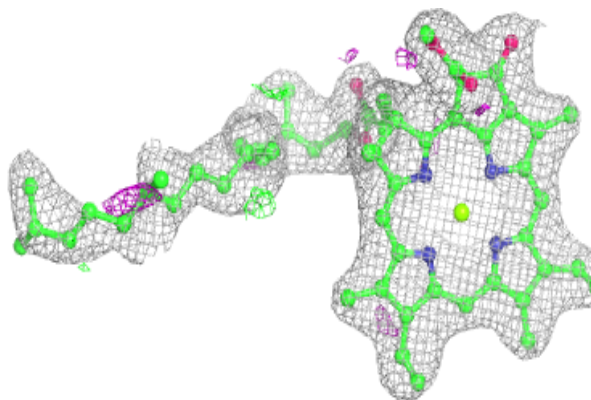

Electron density around PL9 d 406 (A):

$2mF_o-DF_c$ (at 0.7 rmsd) in gray
 mF_o-DF_c (at 3 rmsd) in purple (negative)
and green (positive)

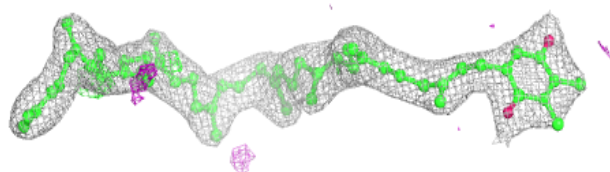
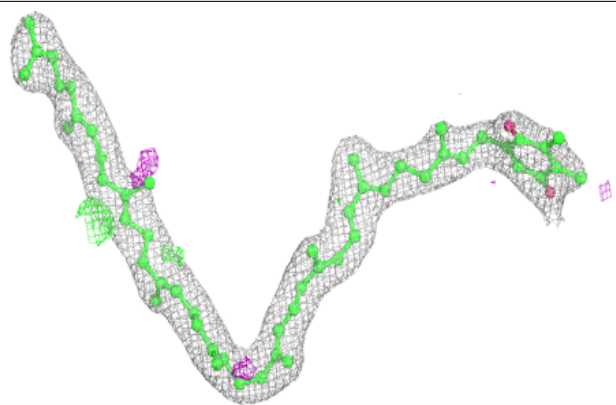
**Electron density around DGD C 517 (A):**

$2mF_o-DF_c$ (at 0.7 rmsd) in gray
 mF_o-DF_c (at 3 rmsd) in purple (negative)
and green (positive)

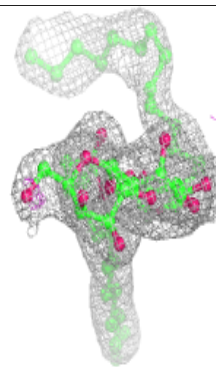
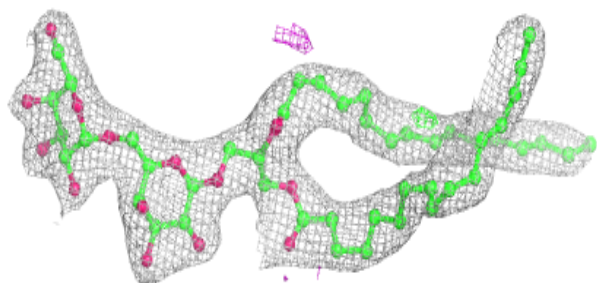
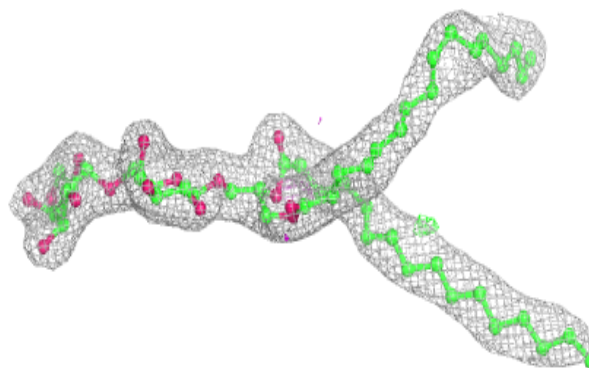

Electron density around DGD C 517 (B):

$2mF_o-DF_c$ (at 0.7 rmsd) in gray
 mF_o-DF_c (at 3 rmsd) in purple (negative)
and green (positive)

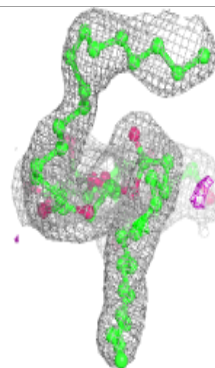
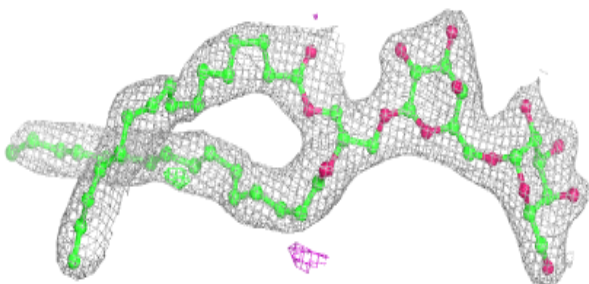
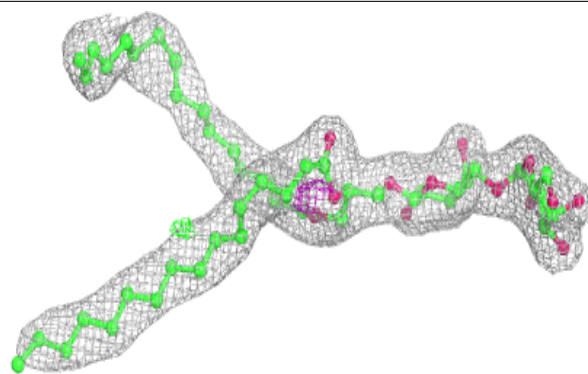
**Electron density around PL9 d 406 (B):**

$2mF_o-DF_c$ (at 0.7 rmsd) in gray
 mF_o-DF_c (at 3 rmsd) in purple (negative)
and green (positive)

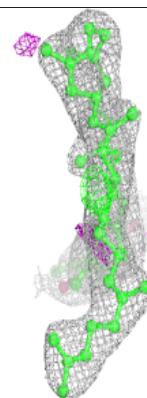
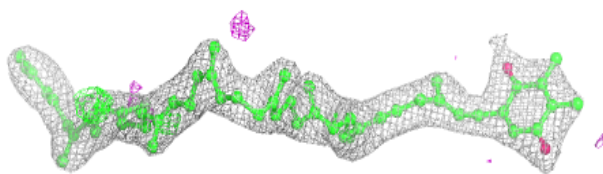
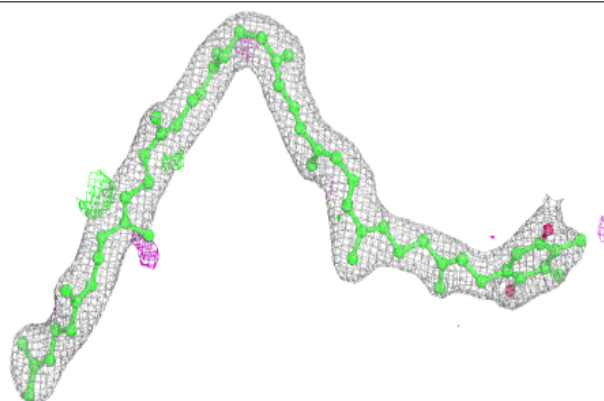

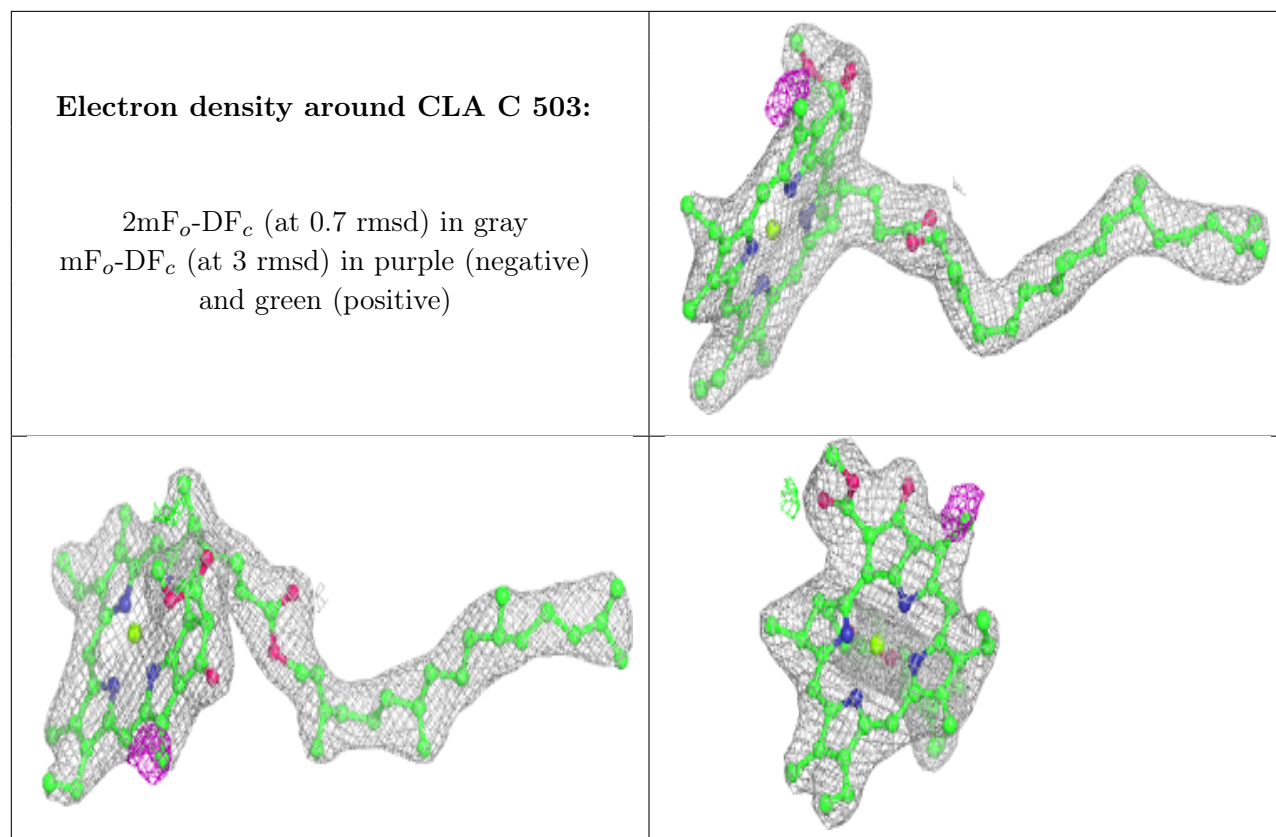

Electron density around CLA C 504:

$2mF_o-DF_c$ (at 0.7 rmsd) in gray
 mF_o-DF_c (at 3 rmsd) in purple (negative)
and green (positive)

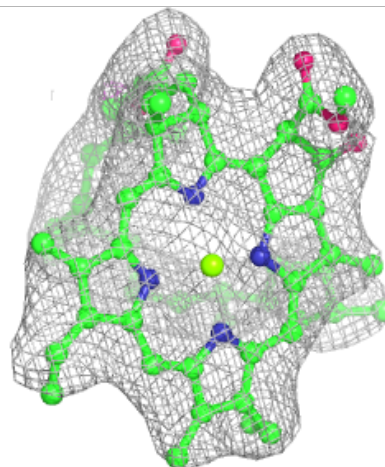
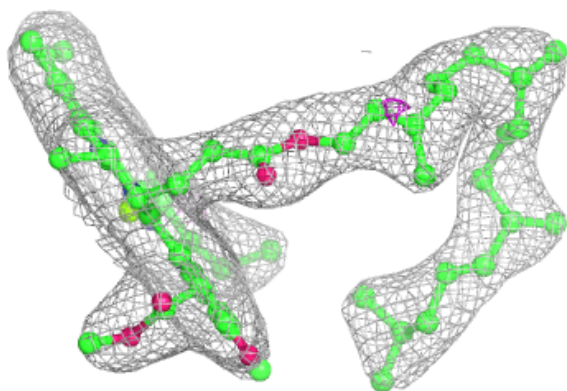
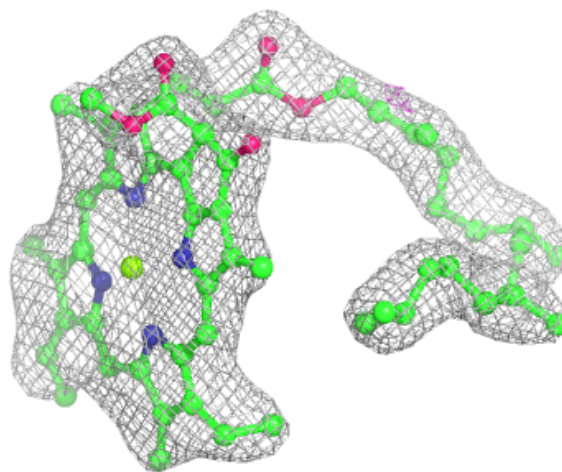

Electron density around PHO a 414 (A):

$2mF_o-DF_c$ (at 0.7 rmsd) in gray
 mF_o-DF_c (at 3 rmsd) in purple (negative)
and green (positive)

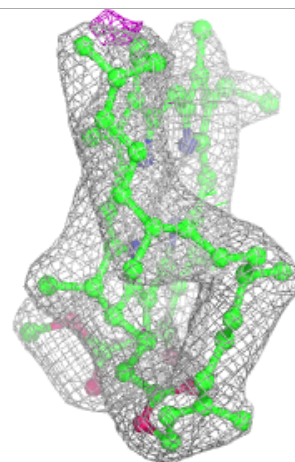
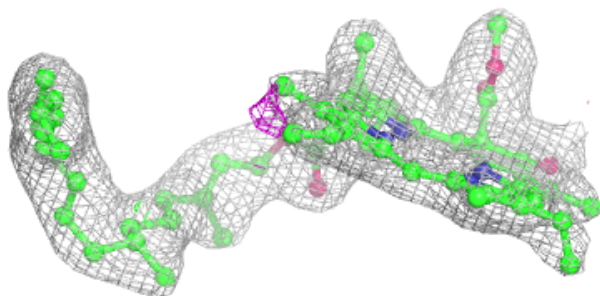
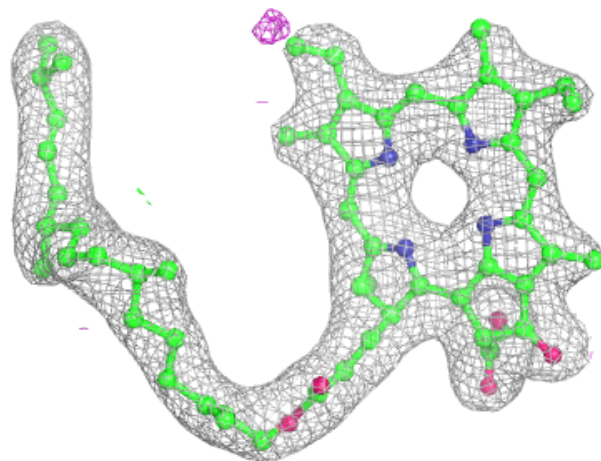

Electron density around PHO a 414 (B):

$2mF_o-DF_c$ (at 0.7 rmsd) in gray
 mF_o-DF_c (at 3 rmsd) in purple (negative)
and green (positive)

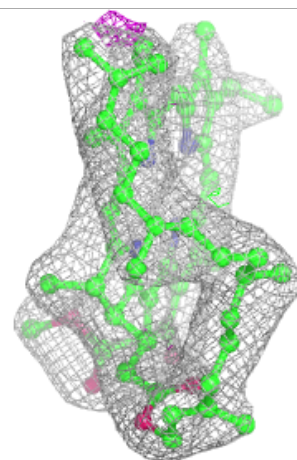
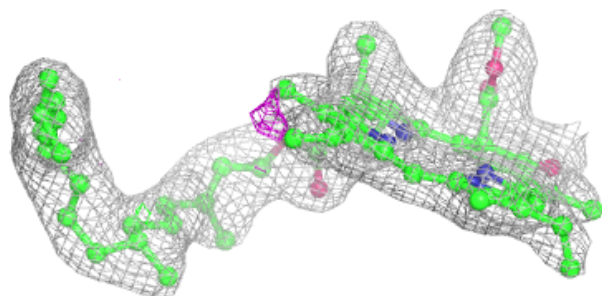
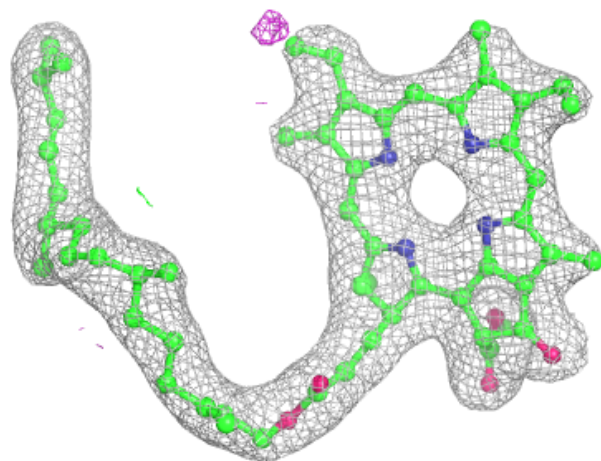

Electron density around CLA B 607:

$2mF_o-DF_c$ (at 0.7 rmsd) in gray
 mF_o-DF_c (at 3 rmsd) in purple (negative)
and green (positive)

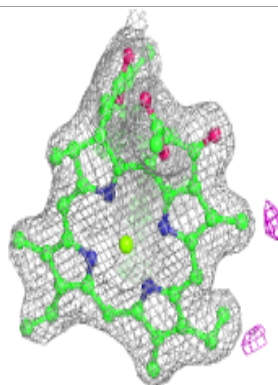
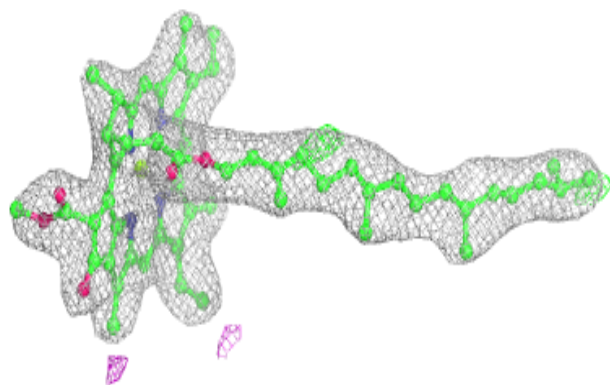
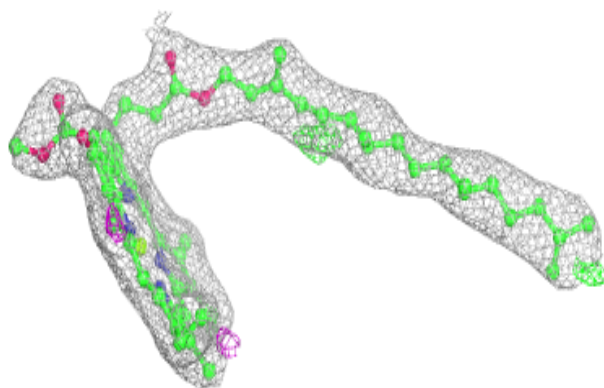
**Electron density around CLA A 406 (B):**

$2mF_o-DF_c$ (at 0.7 rmsd) in gray
 mF_o-DF_c (at 3 rmsd) in purple (negative)
and green (positive)

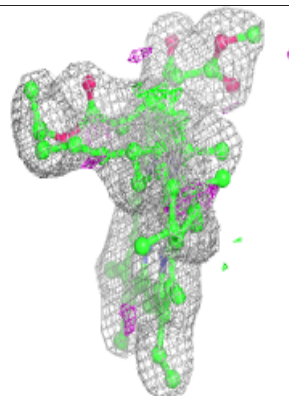
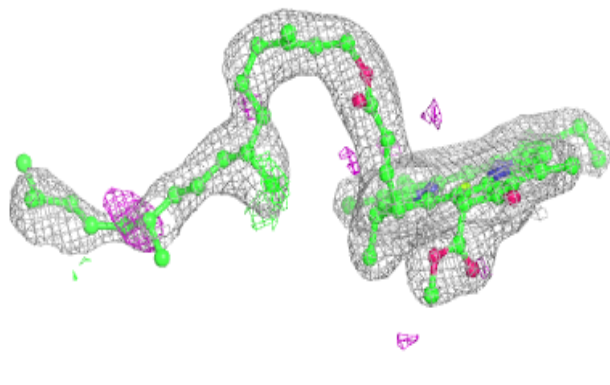
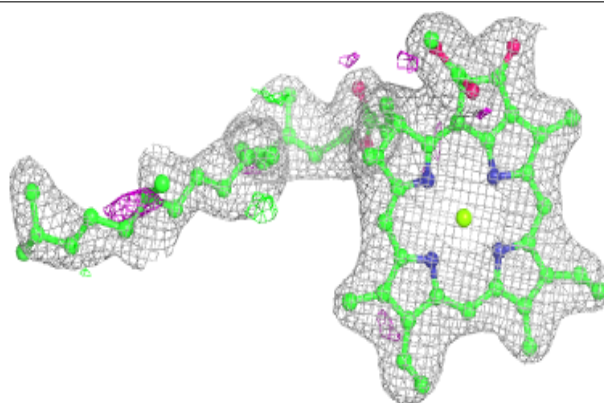

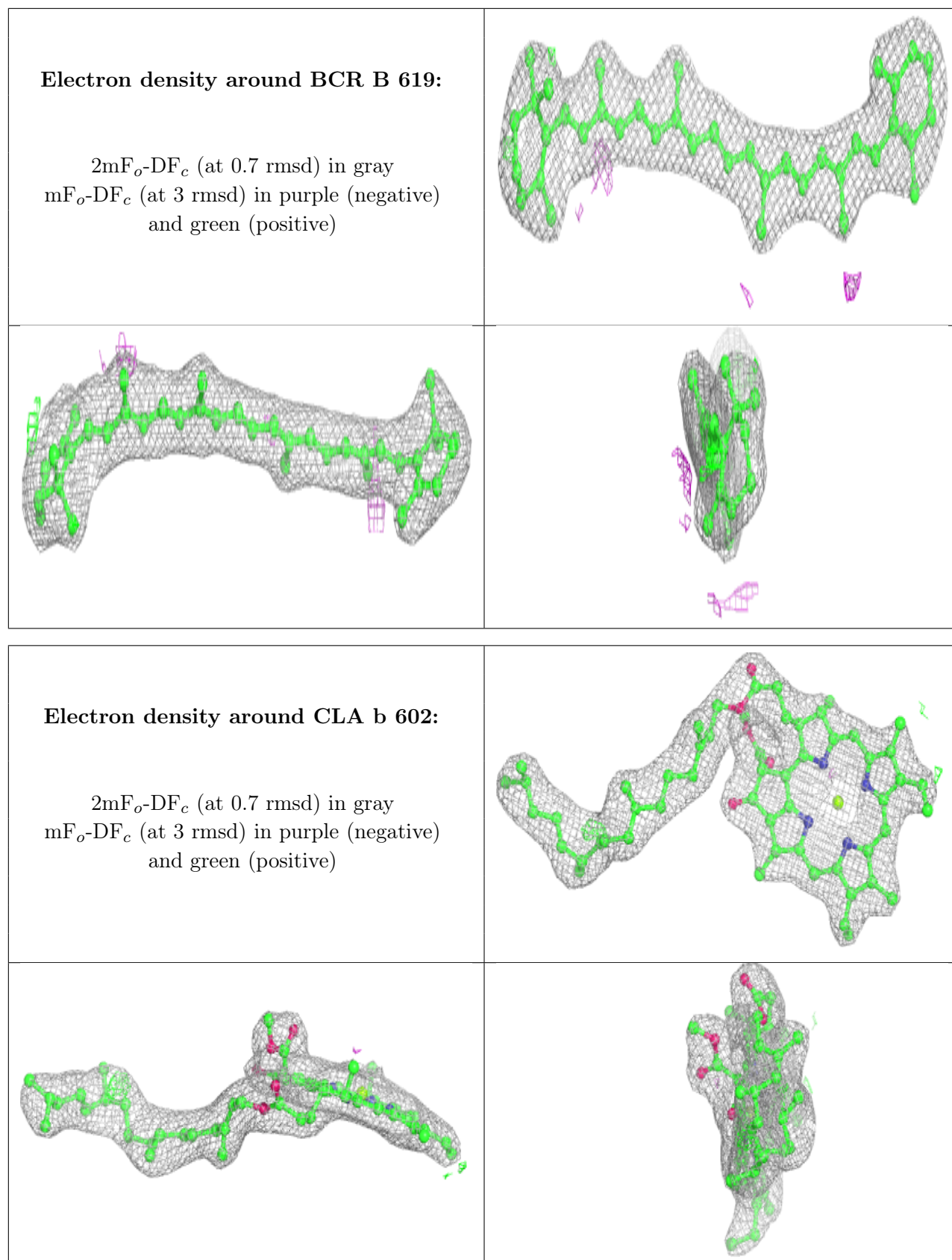

Electron density around CLA b 604:

$2mF_o-DF_c$ (at 0.7 rmsd) in gray
 mF_o-DF_c (at 3 rmsd) in purple (negative)
and green (positive)

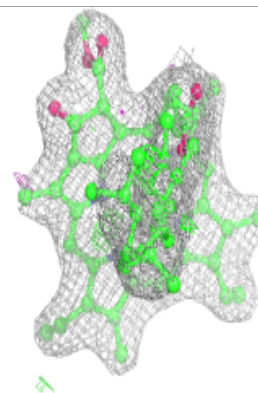
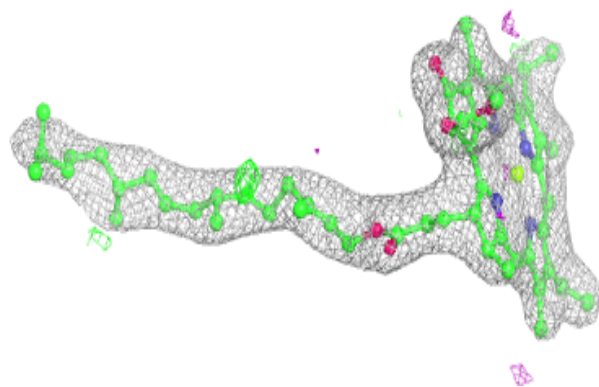
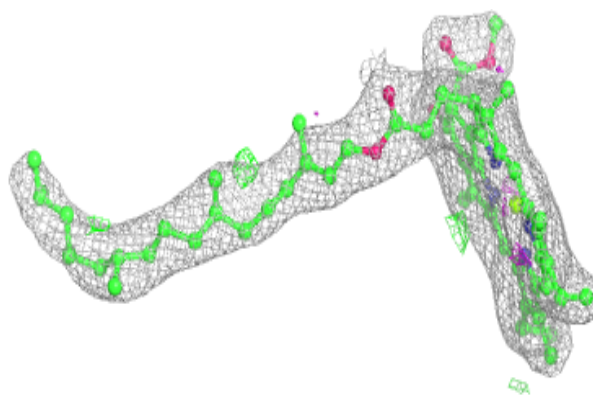
**Electron density around CLA b 605:**

$2mF_o-DF_c$ (at 0.7 rmsd) in gray
 mF_o-DF_c (at 3 rmsd) in purple (negative)
and green (positive)

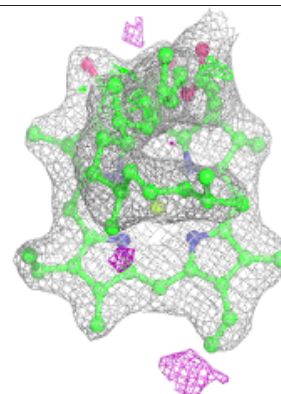
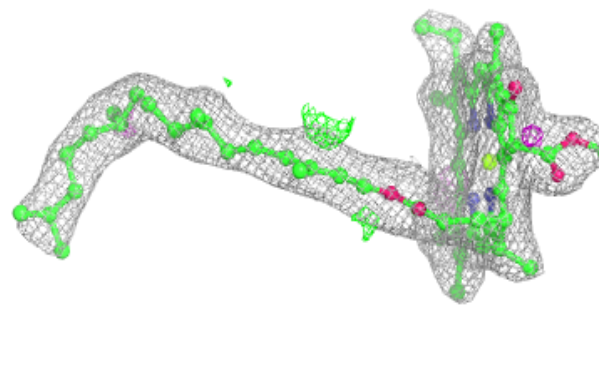
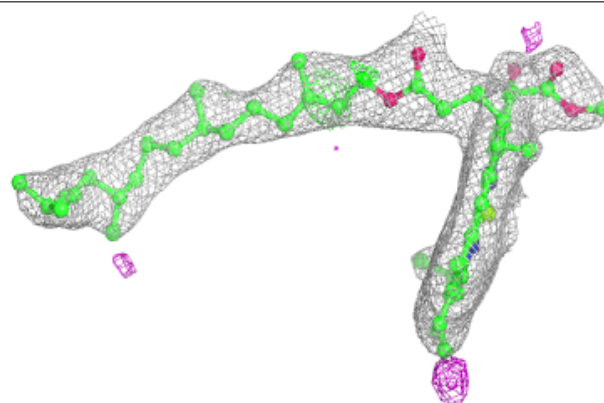

Electron density around CLA B 610:

$2mF_o-DF_c$ (at 0.7 rmsd) in gray
 mF_o-DF_c (at 3 rmsd) in purple (negative)
and green (positive)

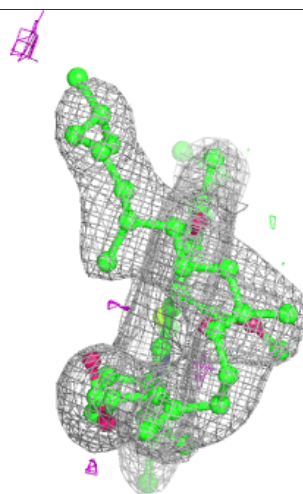
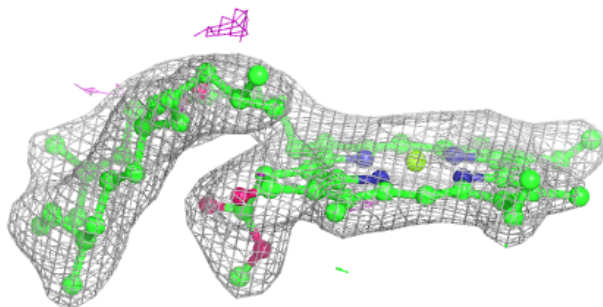
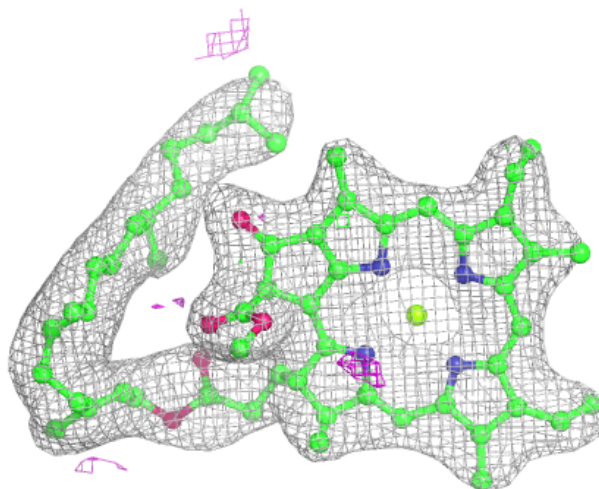

Electron density around CLA b 607:

$2mF_o-DF_c$ (at 0.7 rmsd) in gray
 mF_o-DF_c (at 3 rmsd) in purple (negative)
and green (positive)

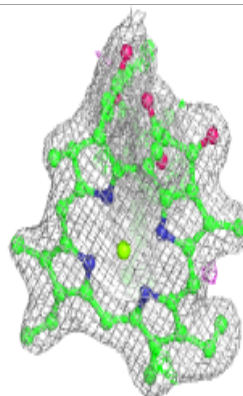
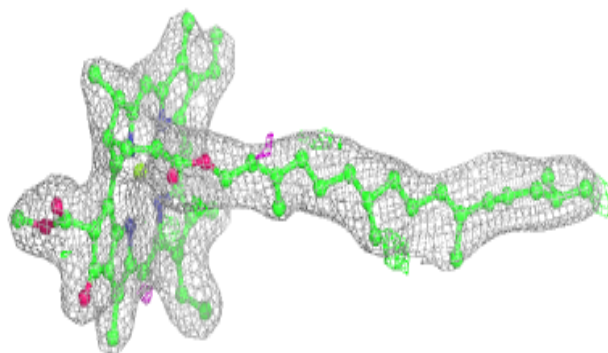
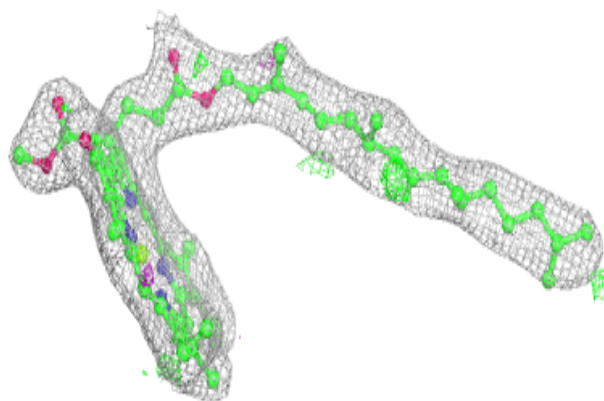
**Electron density around CLA B 602:**

$2mF_o-DF_c$ (at 0.7 rmsd) in gray
 mF_o-DF_c (at 3 rmsd) in purple (negative)
and green (positive)

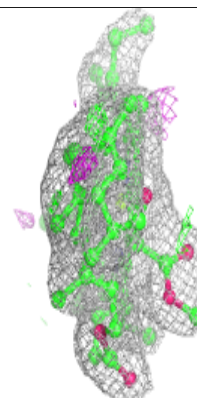
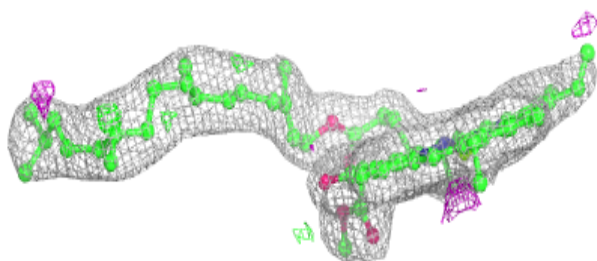
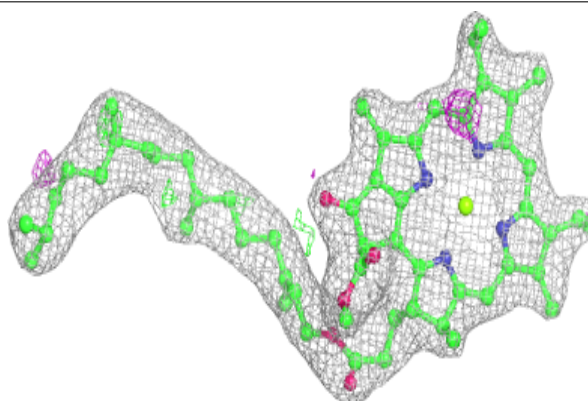

Electron density around CLA b 610:

$2mF_o-DF_c$ (at 0.7 rmsd) in gray
 mF_o-DF_c (at 3 rmsd) in purple (negative)
and green (positive)

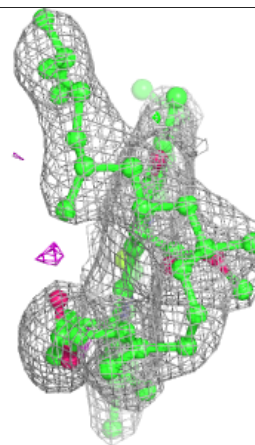
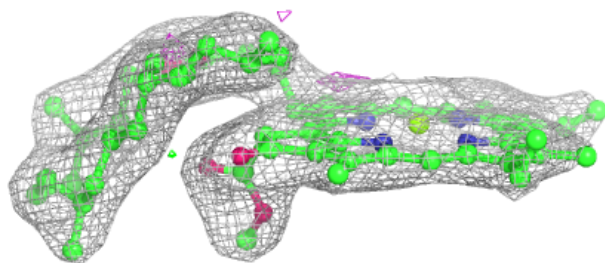
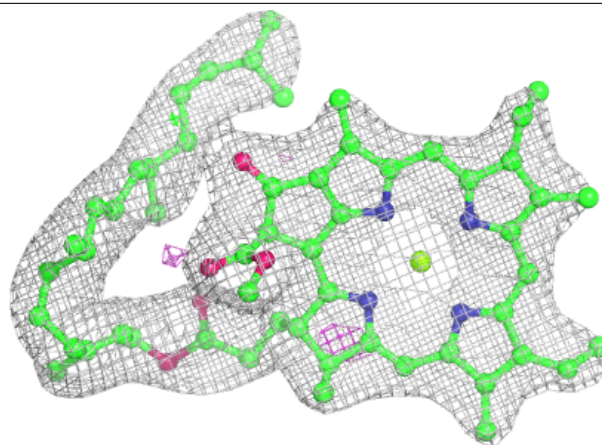
**Electron density around BCR a 408:**

$2mF_o-DF_c$ (at 0.7 rmsd) in gray
 mF_o-DF_c (at 3 rmsd) in purple (negative)
and green (positive)

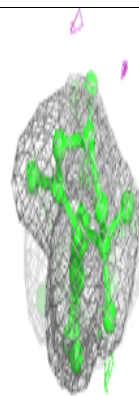
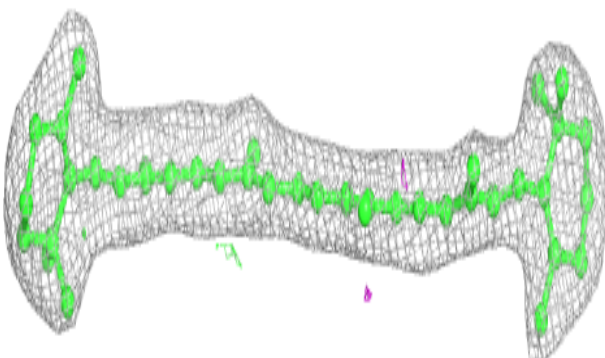
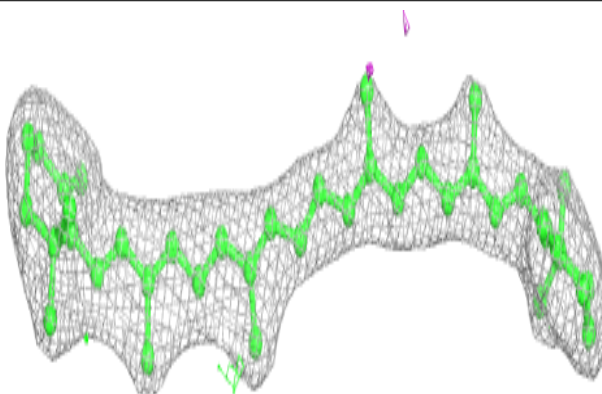

Electron density around HEC v 201:

$2mF_o-DF_c$ (at 0.7 rmsd) in gray
 mF_o-DF_c (at 3 rmsd) in purple (negative)
and green (positive)

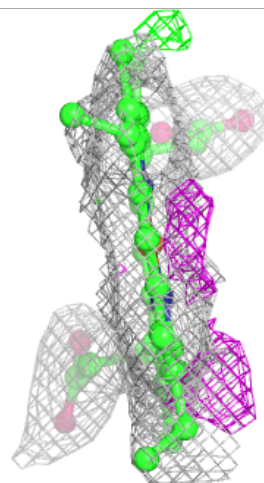
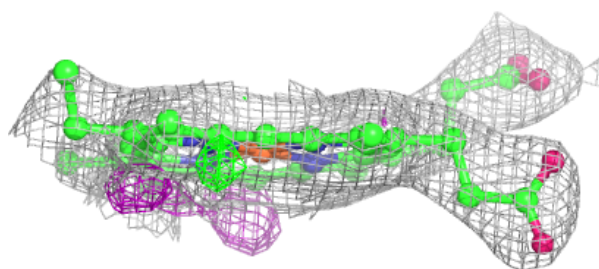
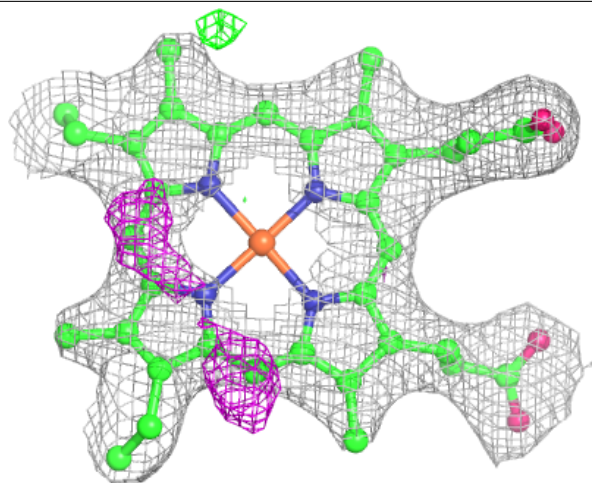

Electron density around CLA c 504:

$2mF_o-DF_c$ (at 0.7 rmsd) in gray
 mF_o-DF_c (at 3 rmsd) in purple (negative)
and green (positive)

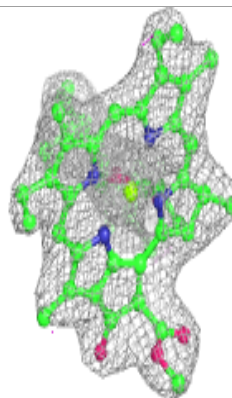
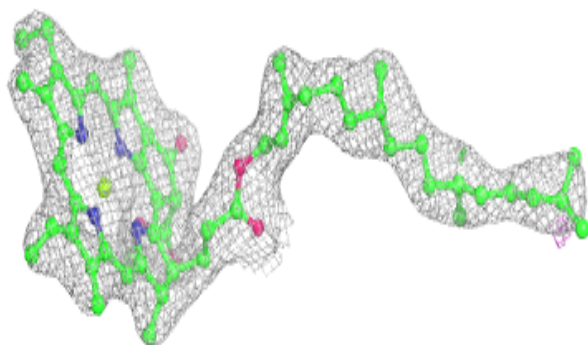
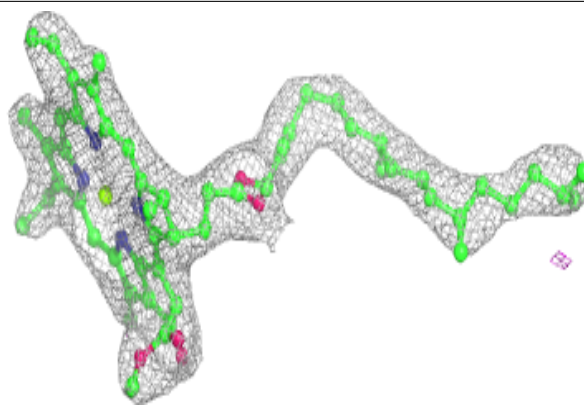
**Electron density around CLA A 405 (A):**

$2mF_o-DF_c$ (at 0.7 rmsd) in gray
 mF_o-DF_c (at 3 rmsd) in purple (negative)
and green (positive)

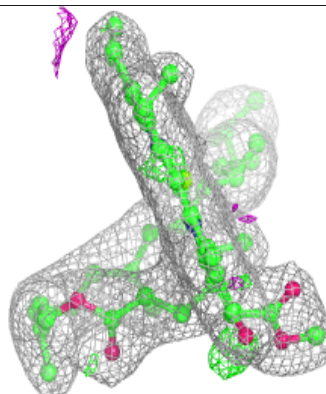
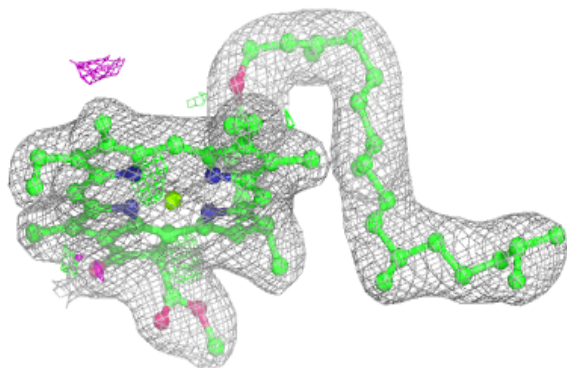
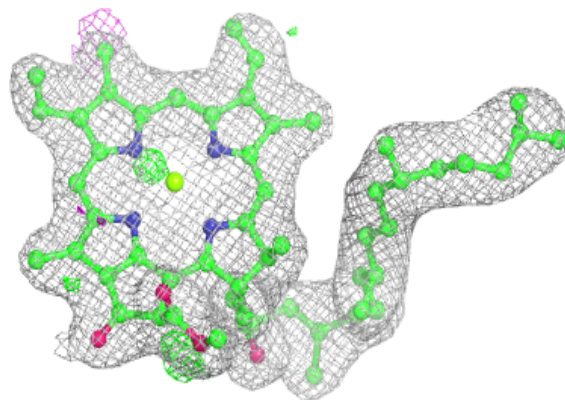

Electron density around CLA B 615:

$2mF_o-DF_c$ (at 0.7 rmsd) in gray
 mF_o-DF_c (at 3 rmsd) in purple (negative)
and green (positive)

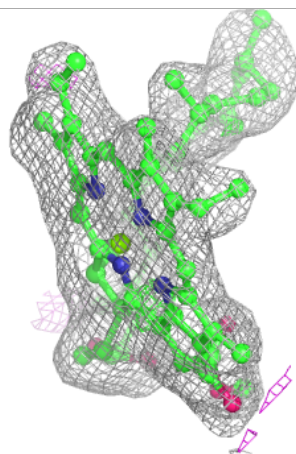
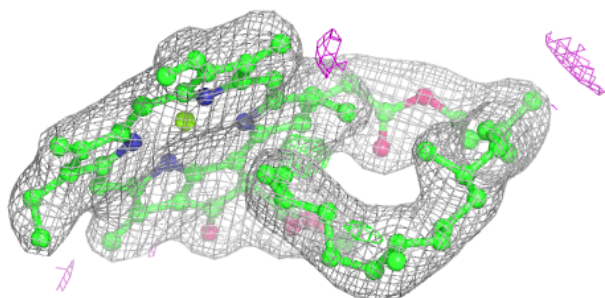
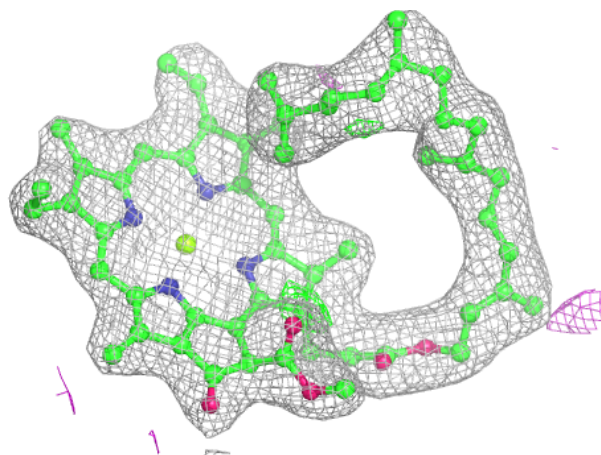

Electron density around CLA b 603:

$2mF_o-DF_c$ (at 0.7 rmsd) in gray
 mF_o-DF_c (at 3 rmsd) in purple (negative)
and green (positive)

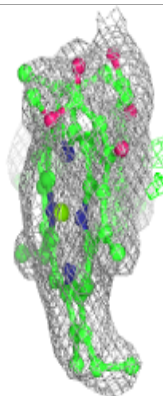
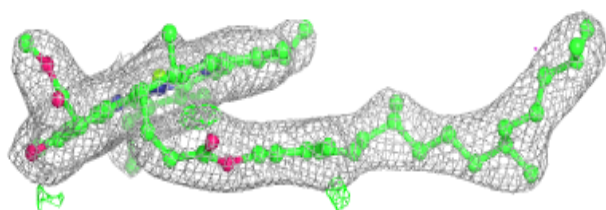
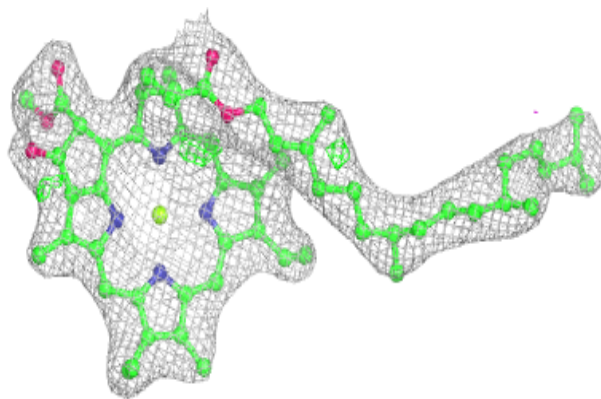
**Electron density around CLA A 405 (B):**

$2mF_o-DF_c$ (at 0.7 rmsd) in gray
 mF_o-DF_c (at 3 rmsd) in purple (negative)
and green (positive)

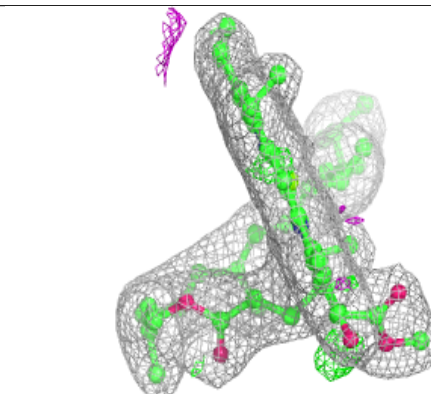
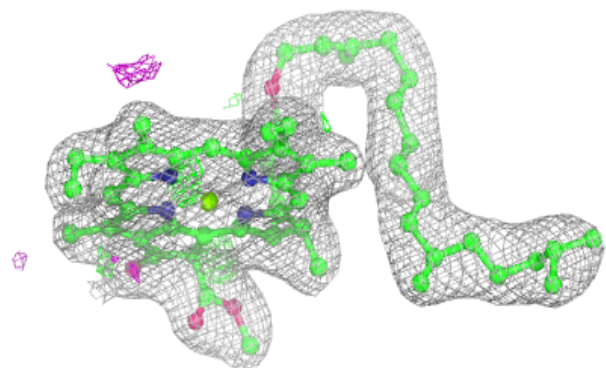
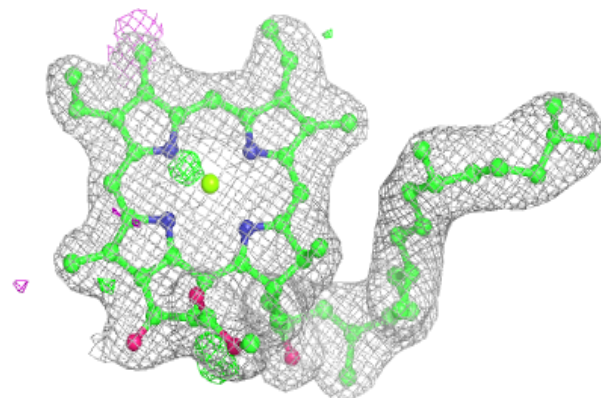

Electron density around CLA B 608:

$2mF_o-DF_c$ (at 0.7 rmsd) in gray
 mF_o-DF_c (at 3 rmsd) in purple (negative)
and green (positive)

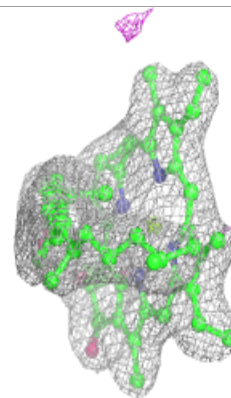
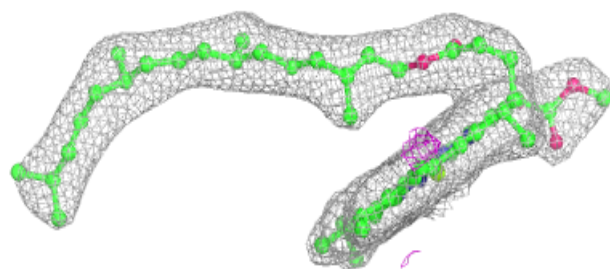
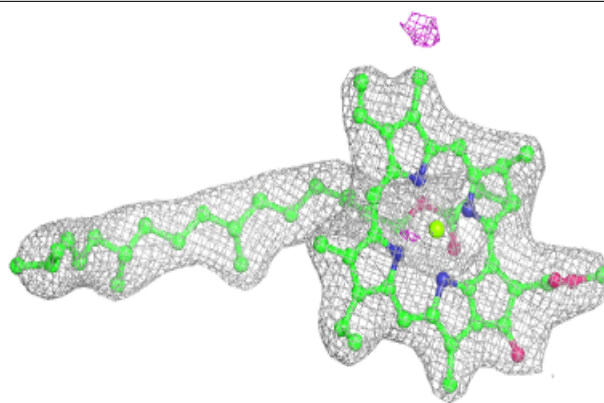
**Electron density around CLA A 404 (A):**

$2mF_o-DF_c$ (at 0.7 rmsd) in gray
 mF_o-DF_c (at 3 rmsd) in purple (negative)
and green (positive)

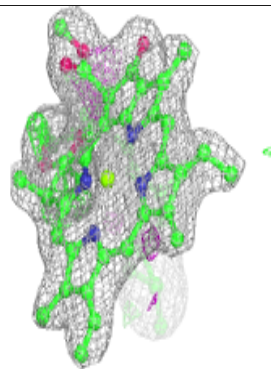
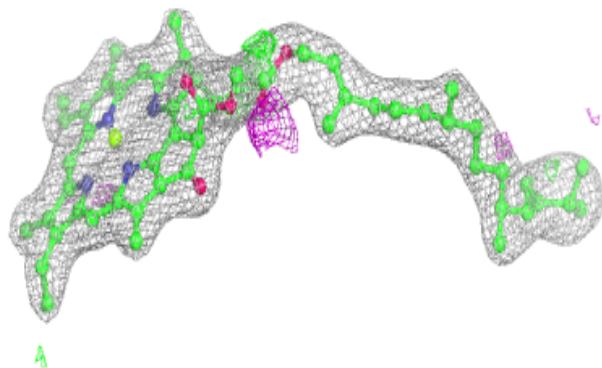
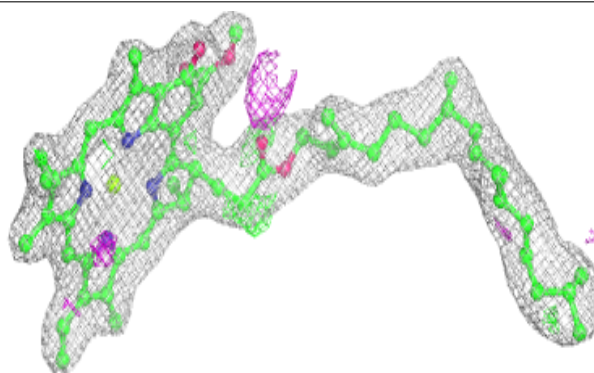

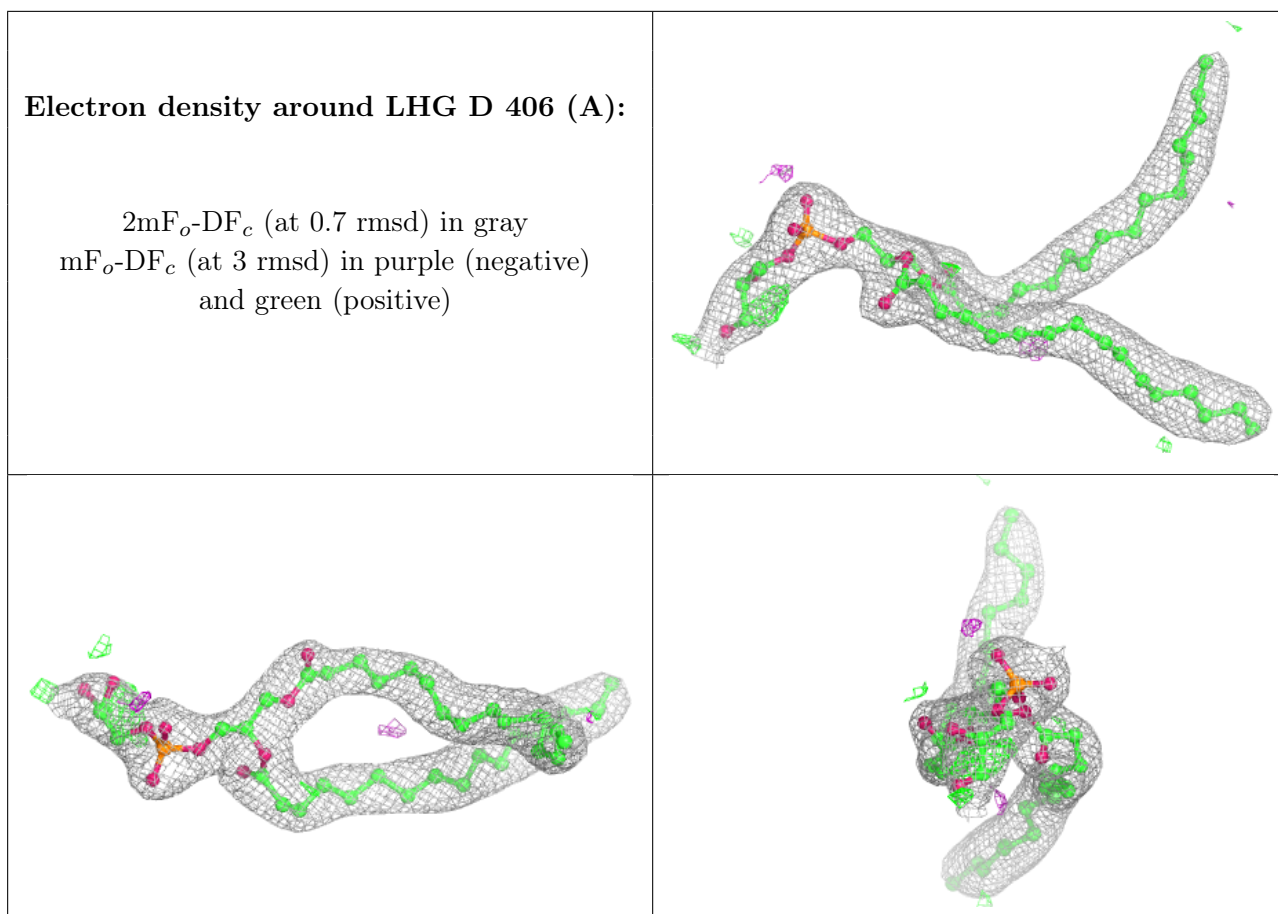

Electron density around LHG D 406 (B):

$2mF_o-DF_c$ (at 0.7 rmsd) in gray
 mF_o-DF_c (at 3 rmsd) in purple (negative)
and green (positive)

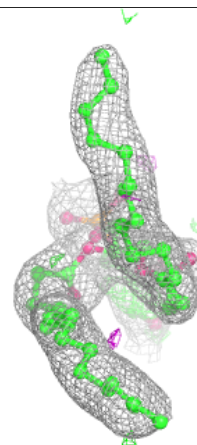
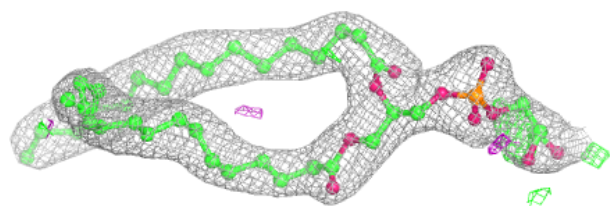
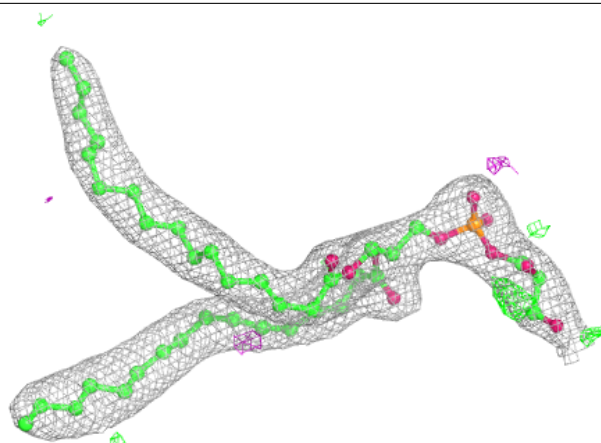
**Electron density around CLA A 404 (B):**

$2mF_o-DF_c$ (at 0.7 rmsd) in gray
 mF_o-DF_c (at 3 rmsd) in purple (negative)
and green (positive)

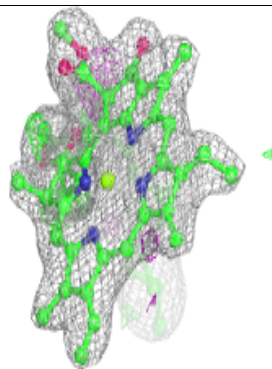
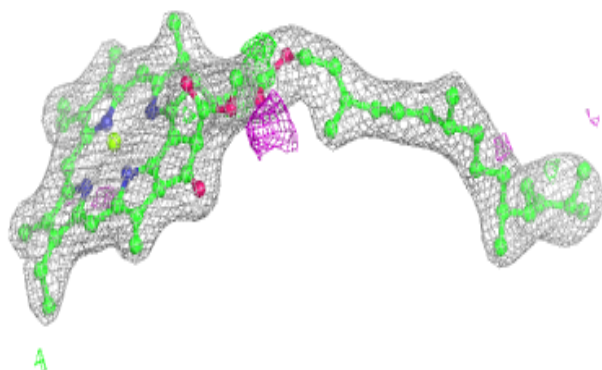
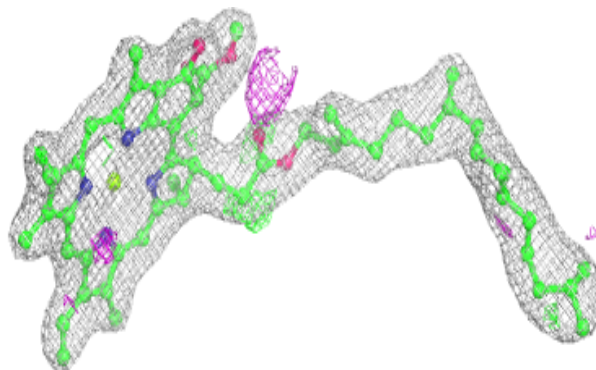

Electron density around CLA c 512:

$2mF_o-DF_c$ (at 0.7 rmsd) in gray
 mF_o-DF_c (at 3 rmsd) in purple (negative)
and green (positive)

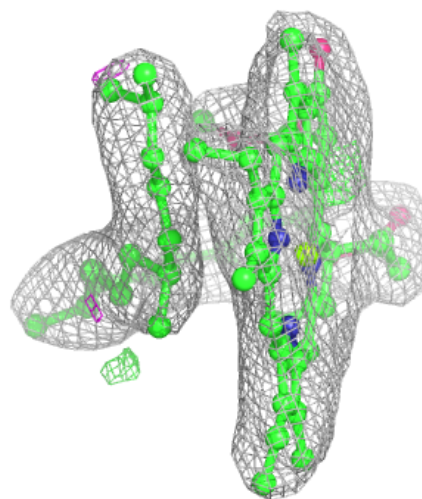
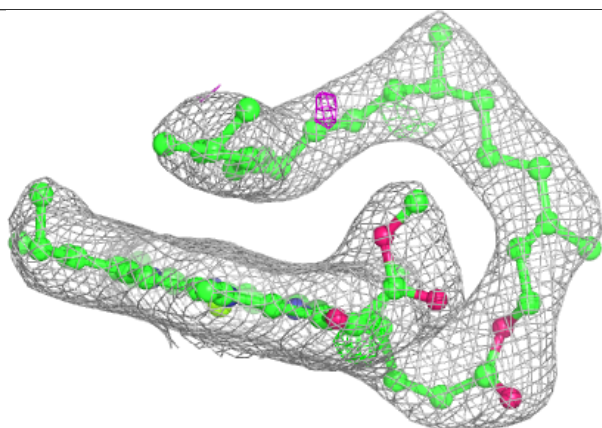
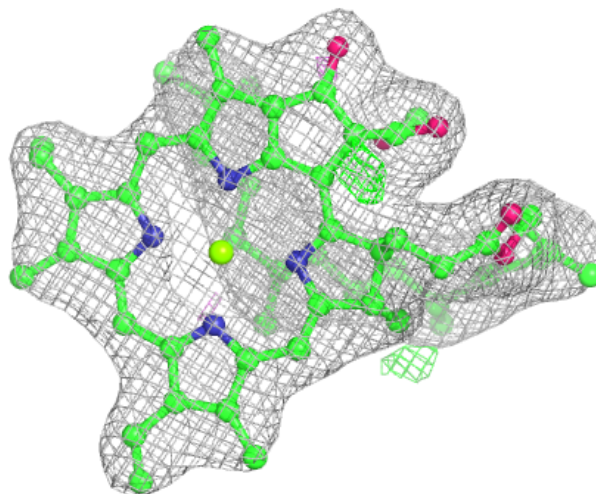

Electron density around CLA b 608:

$2mF_o-DF_c$ (at 0.7 rmsd) in gray
 mF_o-DF_c (at 3 rmsd) in purple (negative)
and green (positive)

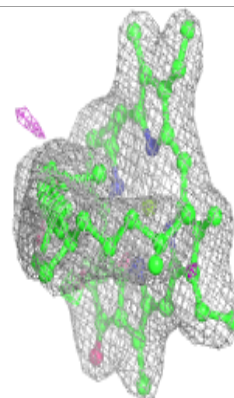
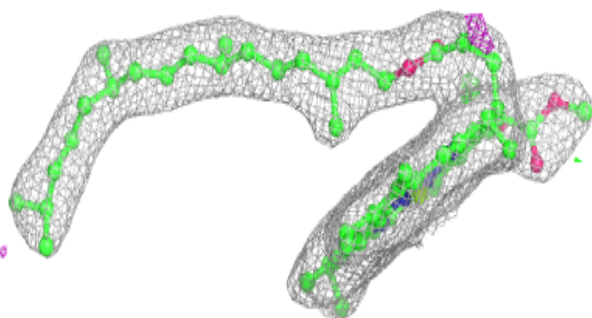
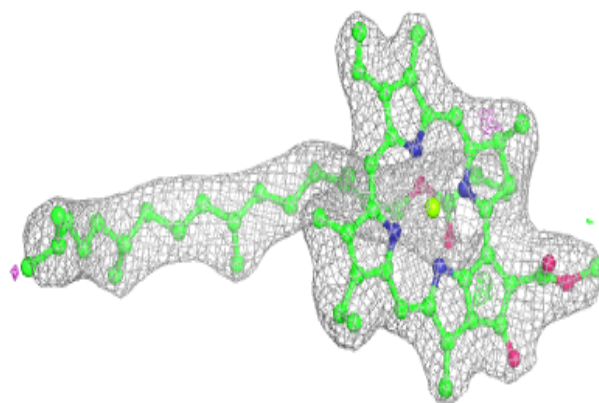
**Electron density around CLA D 402 (A):**

$2mF_o-DF_c$ (at 0.7 rmsd) in gray
 mF_o-DF_c (at 3 rmsd) in purple (negative)
and green (positive)

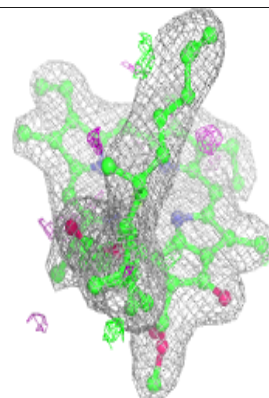
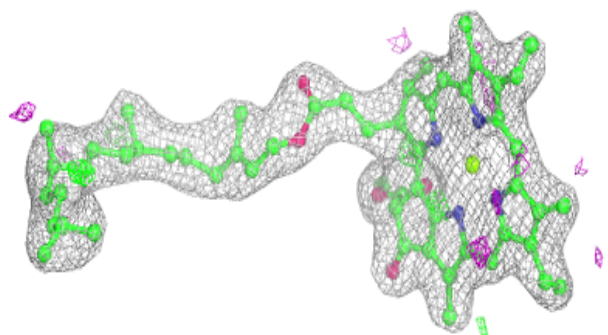
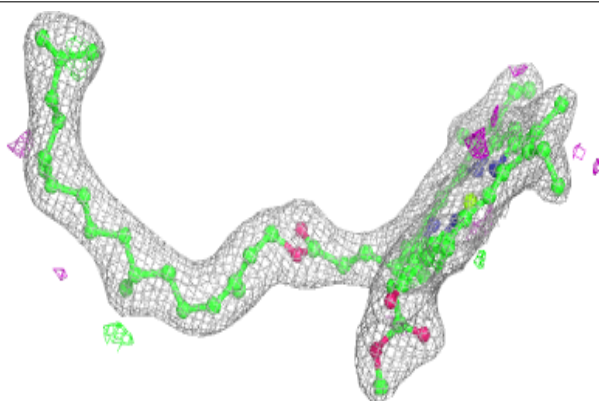

Electron density around LHG L 101 (A):

$2mF_o-DF_c$ (at 0.7 rmsd) in gray
 mF_o-DF_c (at 3 rmsd) in purple (negative)
and green (positive)

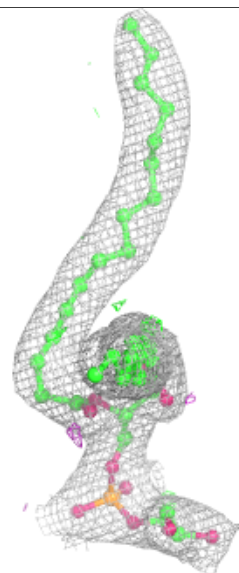
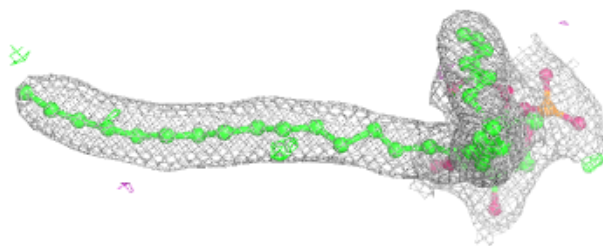
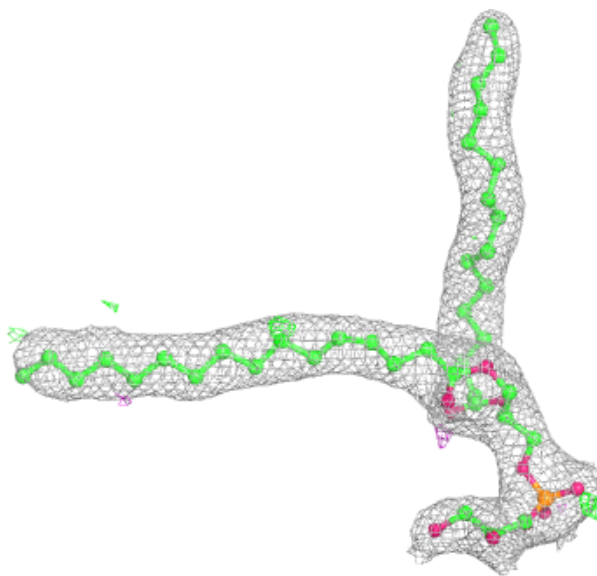

Electron density around LHG L 101 (B):

$2mF_o-DF_c$ (at 0.7 rmsd) in gray
 mF_o-DF_c (at 3 rmsd) in purple (negative)
and green (positive)

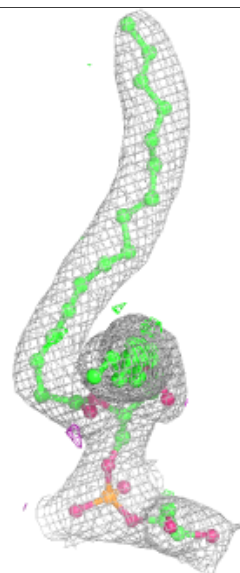
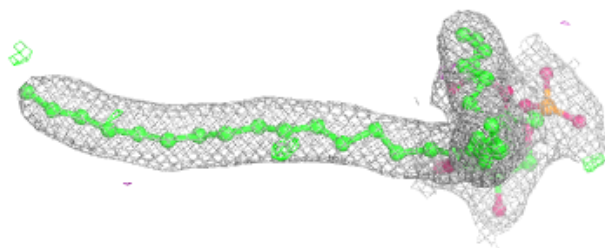
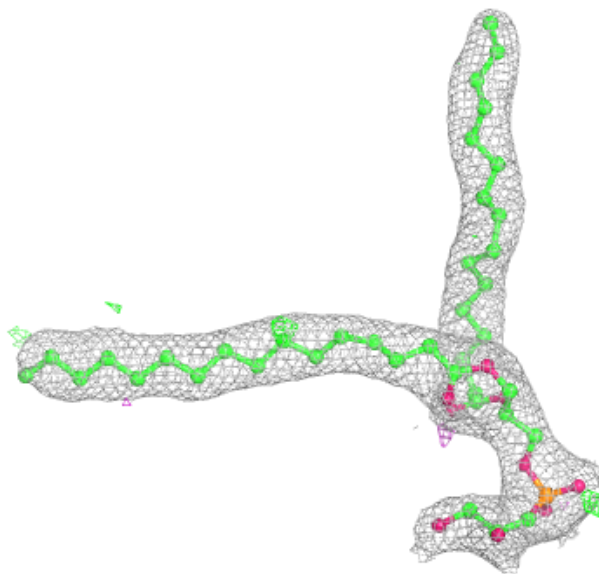

Electron density around CLA D 402 (B):

$2mF_o-DF_c$ (at 0.7 rmsd) in gray
 mF_o-DF_c (at 3 rmsd) in purple (negative)
and green (positive)

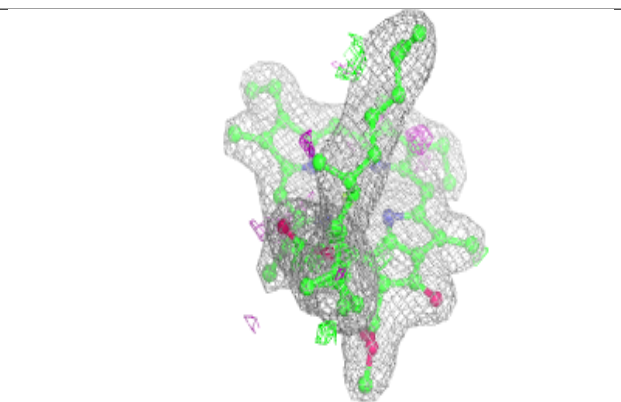
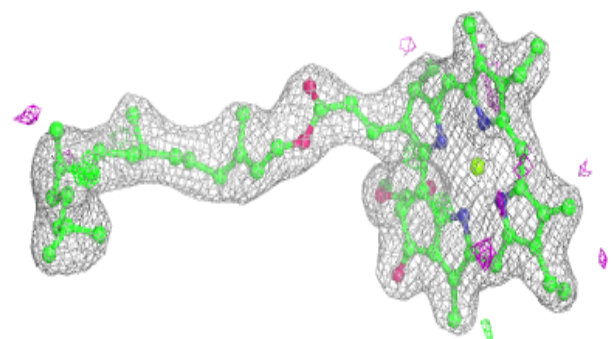
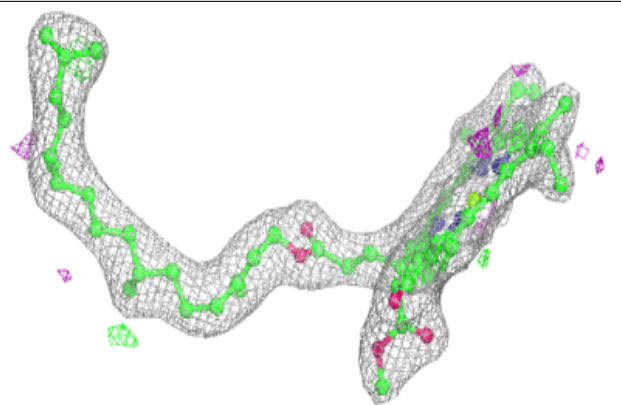
**Electron density around CLA d 402 (A):**

$2mF_o-DF_c$ (at 0.7 rmsd) in gray
 mF_o-DF_c (at 3 rmsd) in purple (negative)
and green (positive)

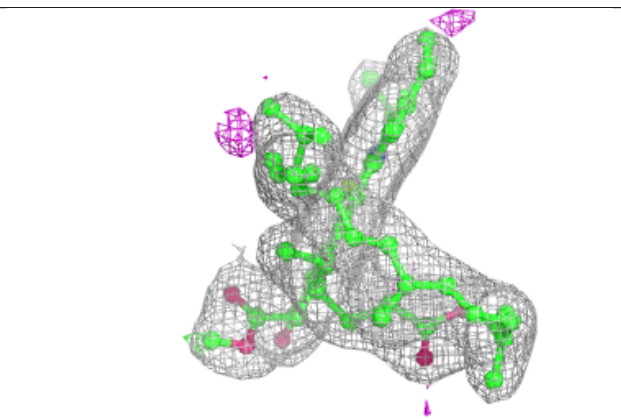
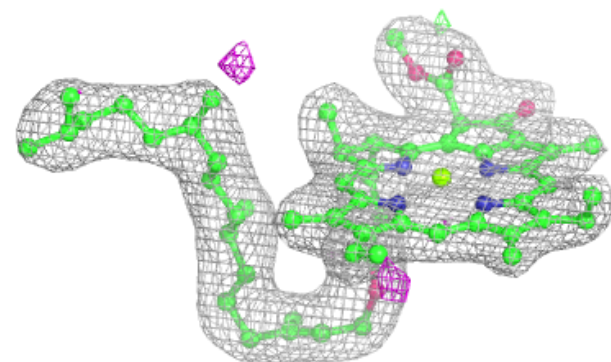
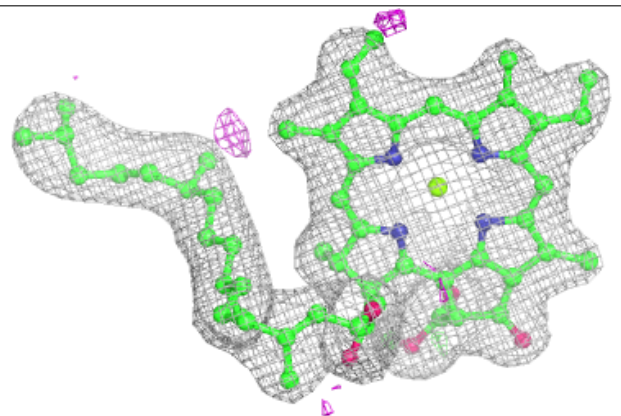

Electron density around CLA d 402 (B):

$2mF_o-DF_c$ (at 0.7 rmsd) in gray
 mF_o-DF_c (at 3 rmsd) in purple (negative)
and green (positive)

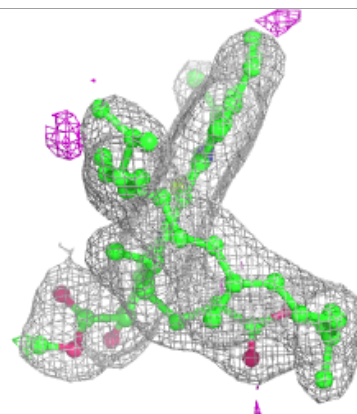
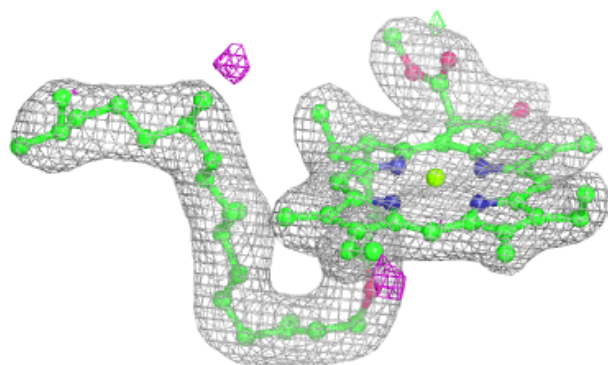
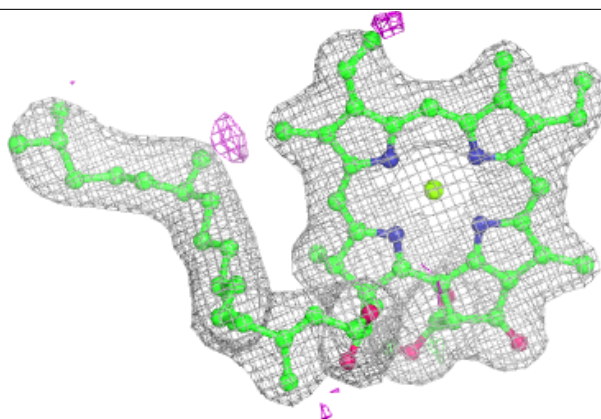
**Electron density around CLA d 403 (A):**

$2mF_o-DF_c$ (at 0.7 rmsd) in gray
 mF_o-DF_c (at 3 rmsd) in purple (negative)
and green (positive)

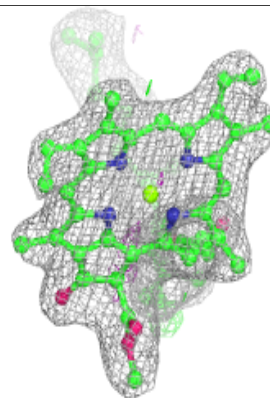
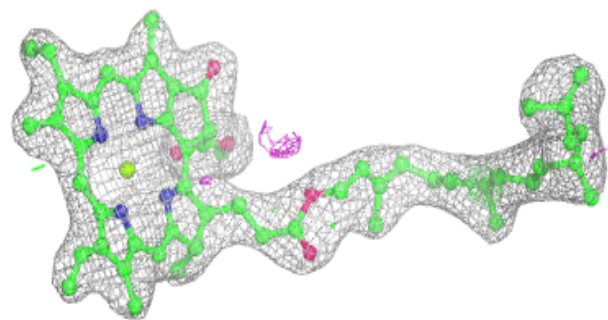
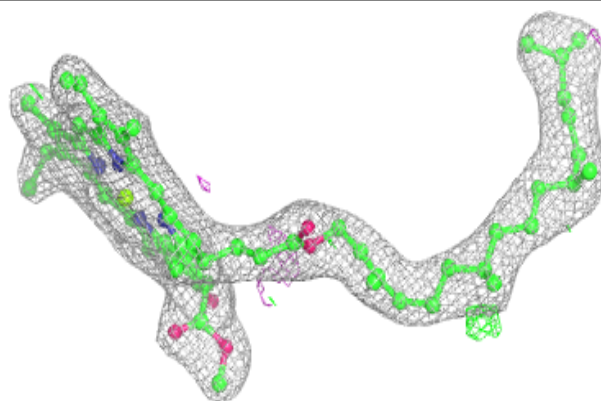

Electron density around CLA d 403 (B):

$2mF_o-DF_c$ (at 0.7 rmsd) in gray
 mF_o-DF_c (at 3 rmsd) in purple (negative)
and green (positive)

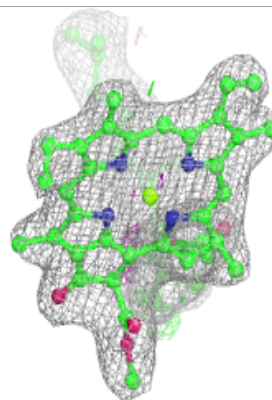
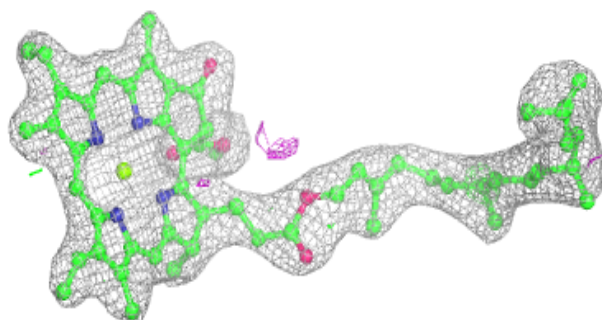
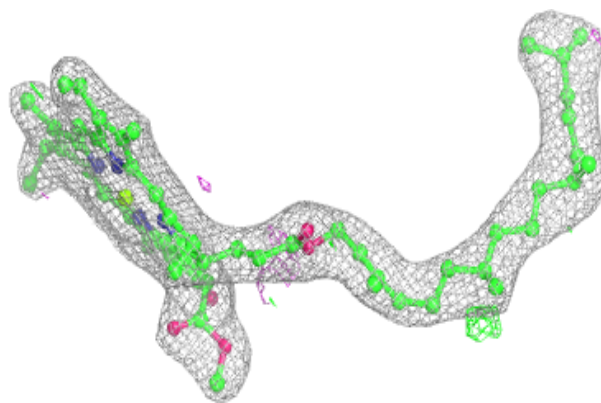
**Electron density around CLA B 604:**

$2mF_o-DF_c$ (at 0.7 rmsd) in gray
 mF_o-DF_c (at 3 rmsd) in purple (negative)
and green (positive)

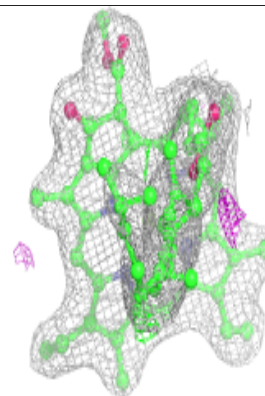
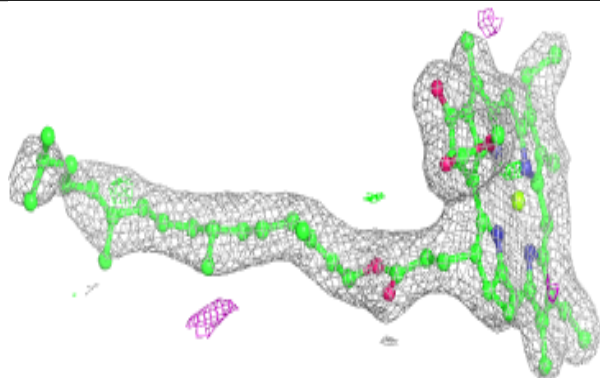
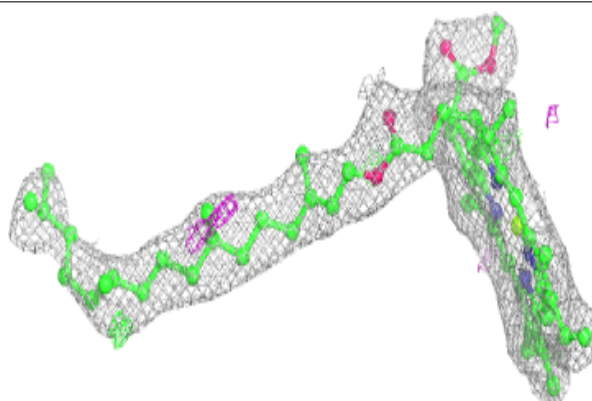

Electron density around PHO A 407 (A):

$2mF_o-DF_c$ (at 0.7 rmsd) in gray
 mF_o-DF_c (at 3 rmsd) in purple (negative)
and green (positive)

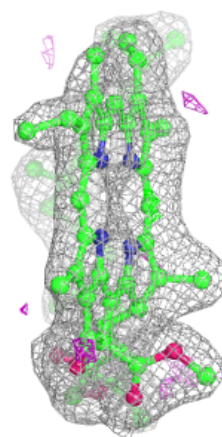
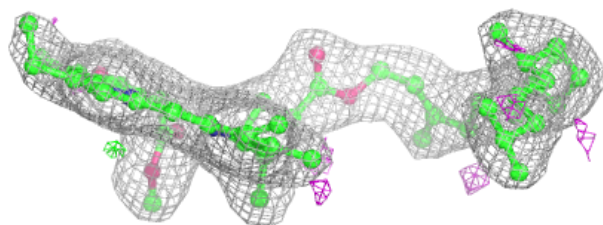
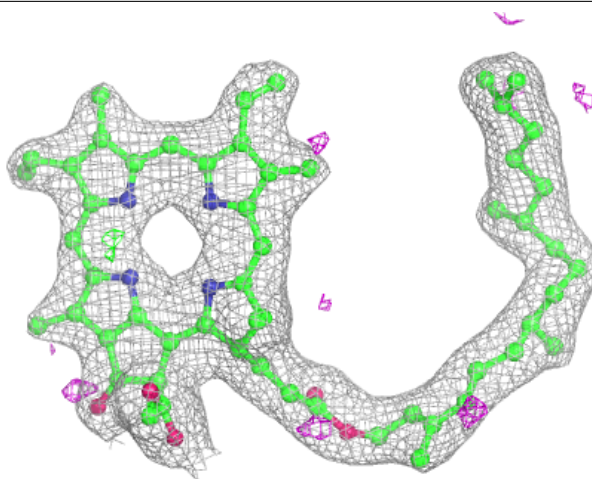

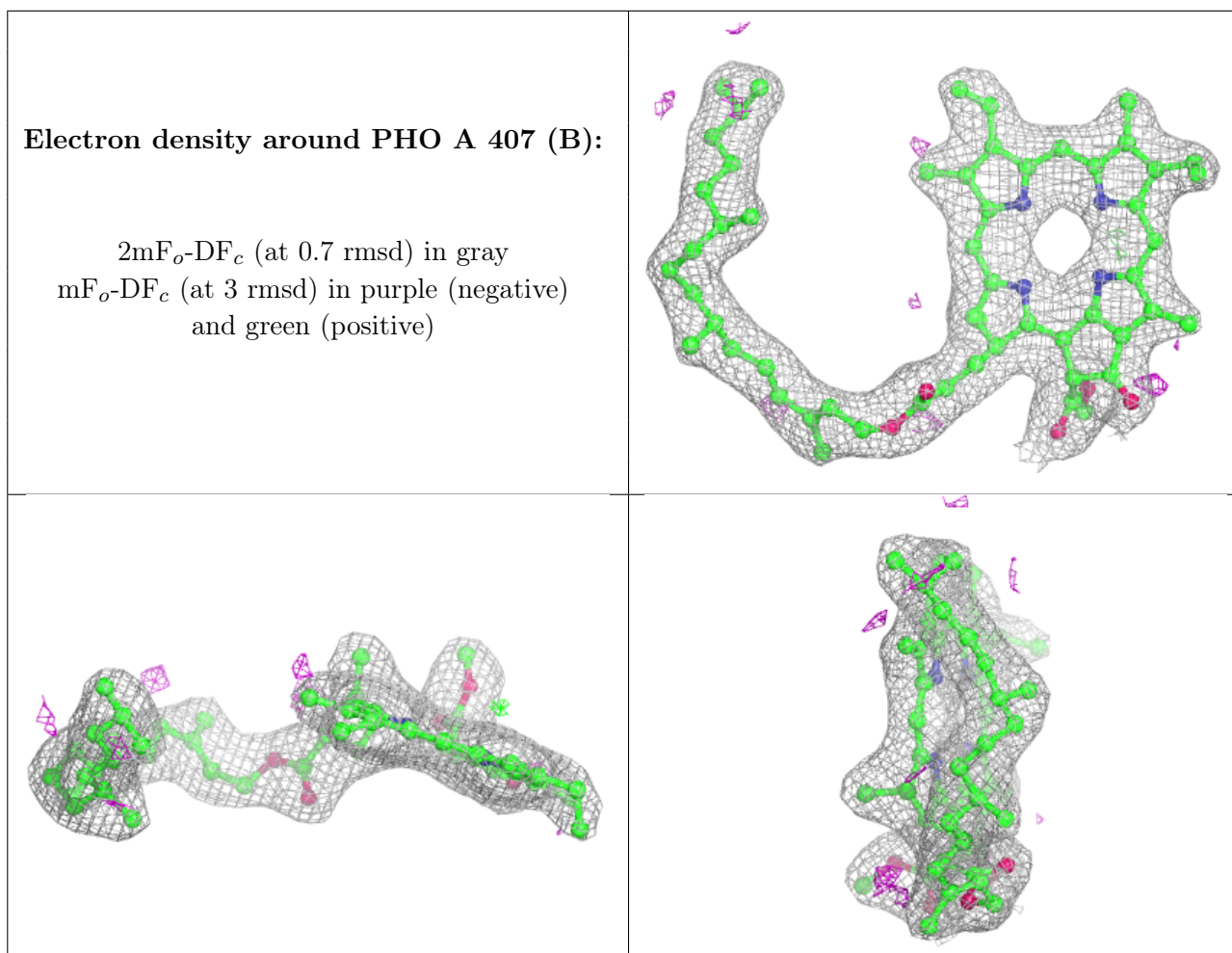

Electron density around PHO A 416 (A):

$2mF_o-DF_c$ (at 0.7 rmsd) in gray
 mF_o-DF_c (at 3 rmsd) in purple (negative)
and green (positive)

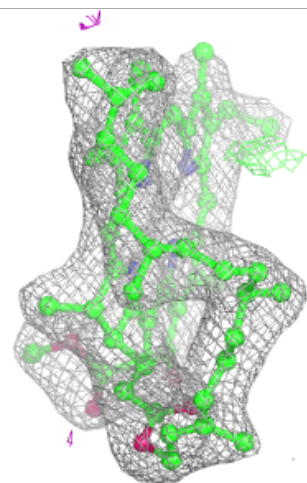
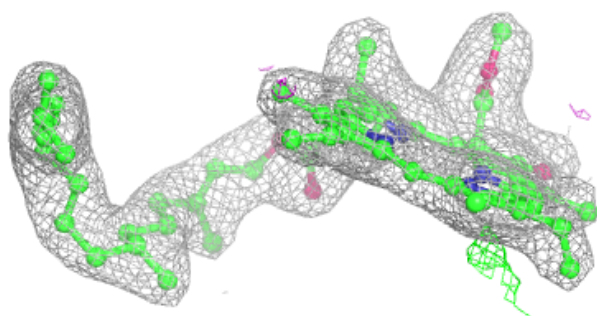
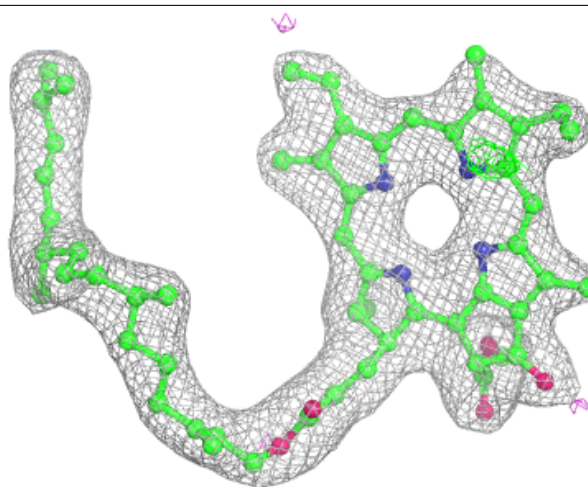

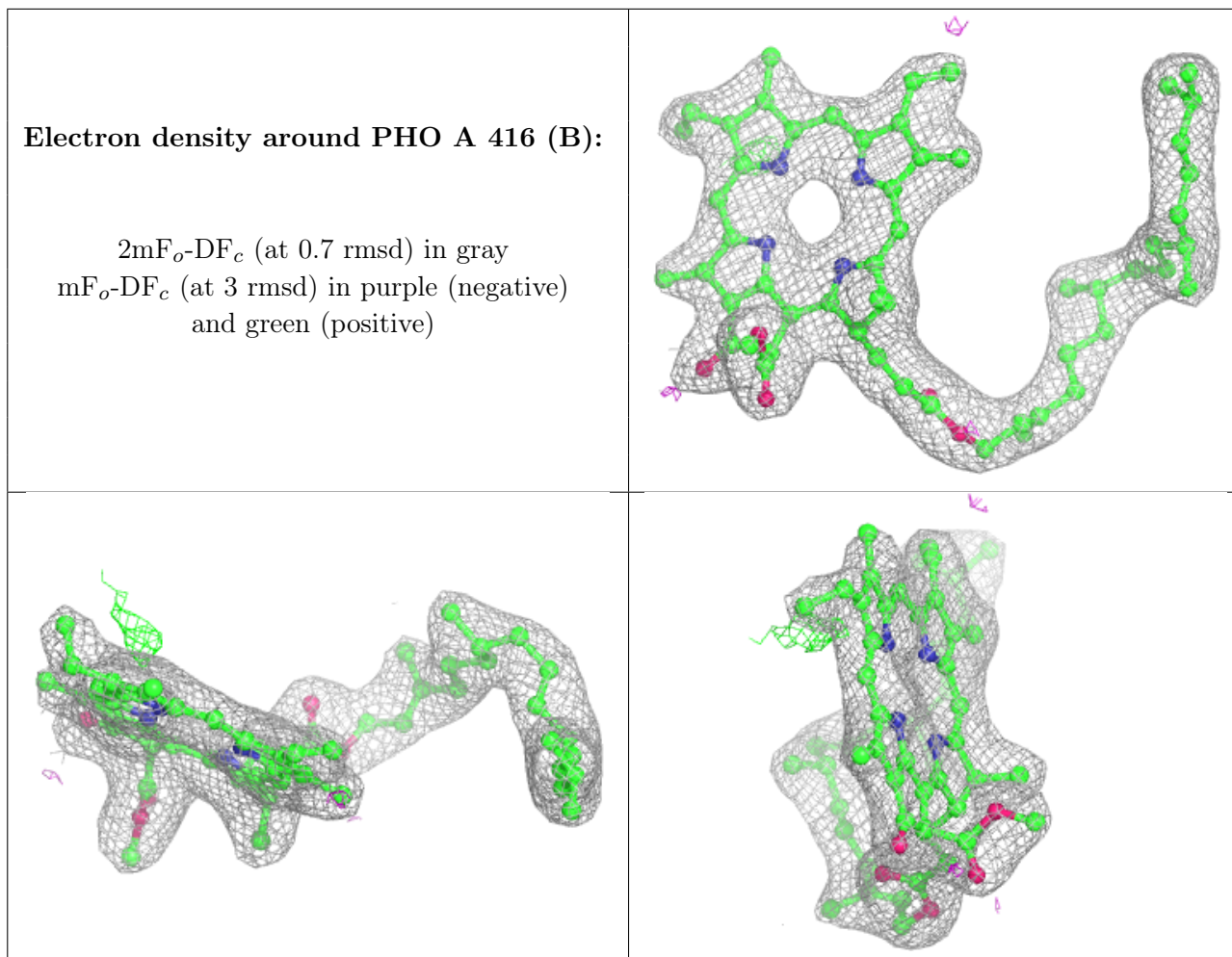

Electron density around PHO a 406 (A):

$2mF_o-DF_c$ (at 0.7 rmsd) in gray
 mF_o-DF_c (at 3 rmsd) in purple (negative)
and green (positive)

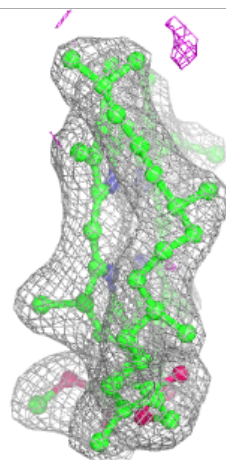
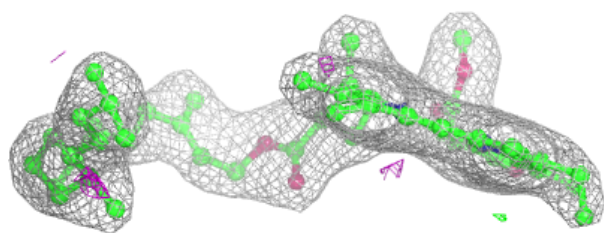
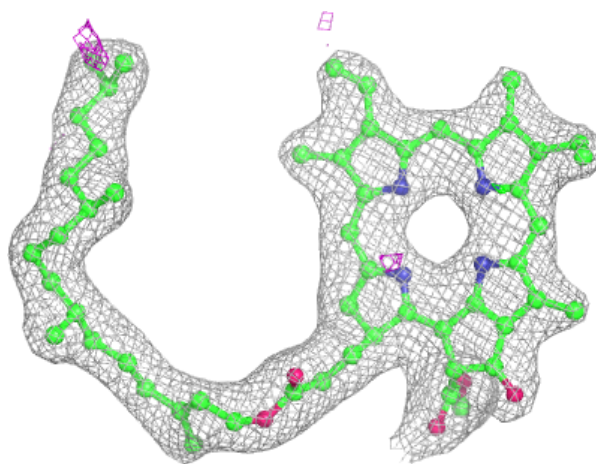

Electron density around PHO a 406 (B):

$2mF_o-DF_c$ (at 0.7 rmsd) in gray
 mF_o-DF_c (at 3 rmsd) in purple (negative)
and green (positive)

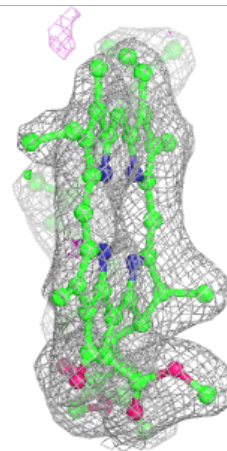
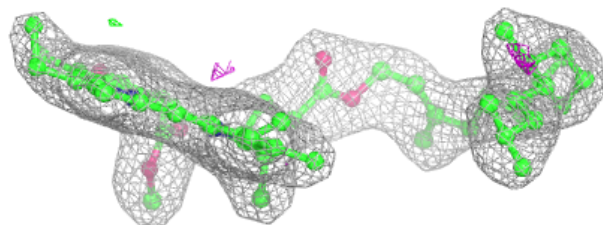
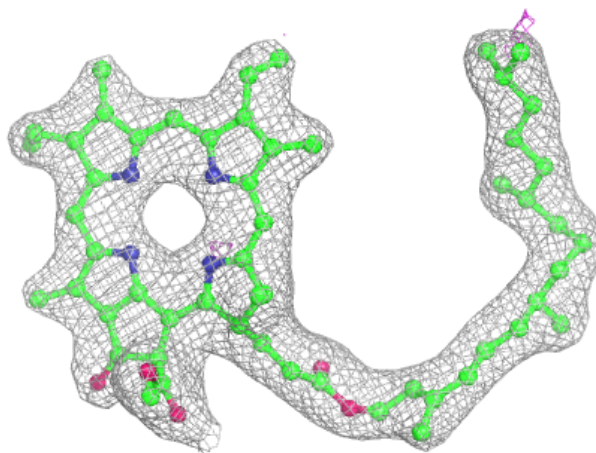

Electron density around CLA a 404 (A):

$2mF_o-DF_c$ (at 0.7 rmsd) in gray
 mF_o-DF_c (at 3 rmsd) in purple (negative)
and green (positive)

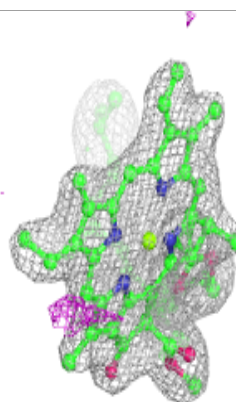
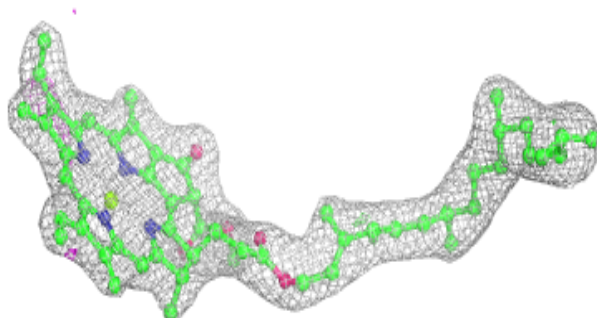
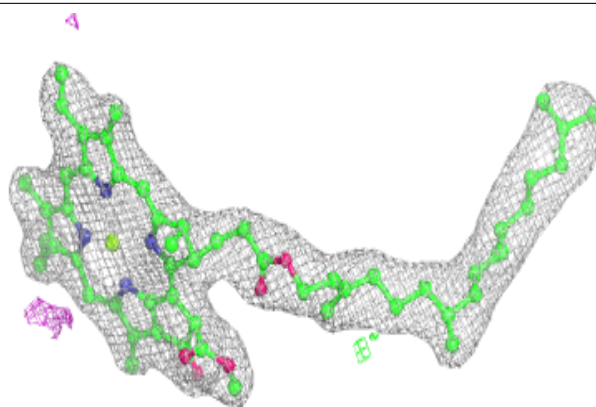

Electron density around CLA b 613:

$2mF_o-DF_c$ (at 0.7 rmsd) in gray
 mF_o-DF_c (at 3 rmsd) in purple (negative)
and green (positive)

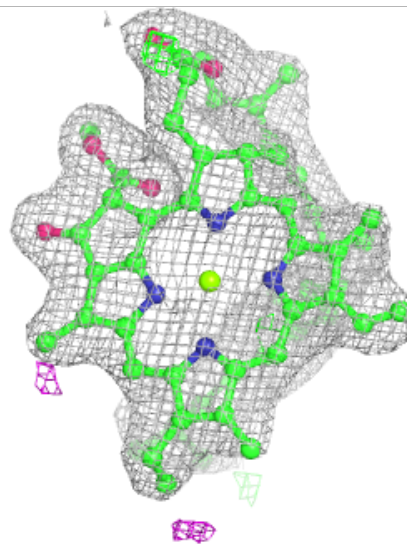
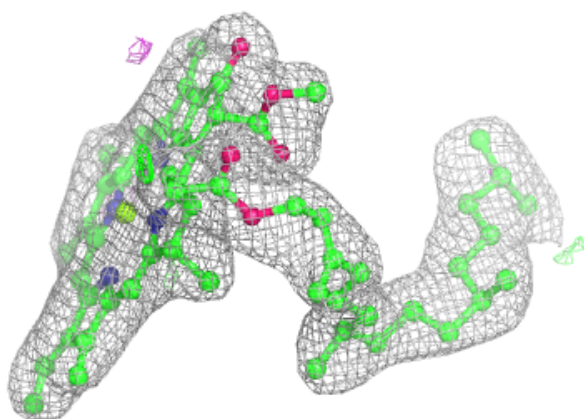
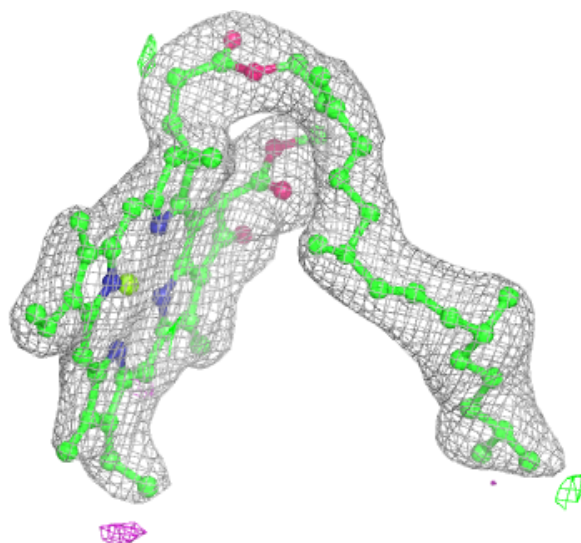

Electron density around CLA a 404 (B):

$2mF_o-DF_c$ (at 0.7 rmsd) in gray
 mF_o-DF_c (at 3 rmsd) in purple (negative)
and green (positive)

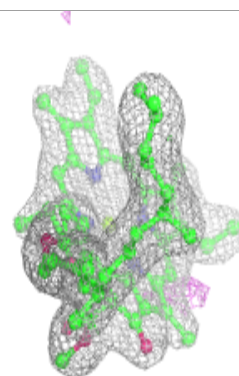
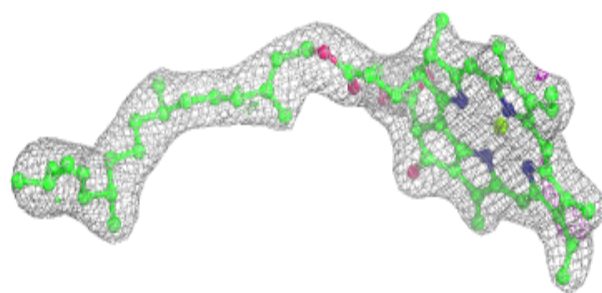
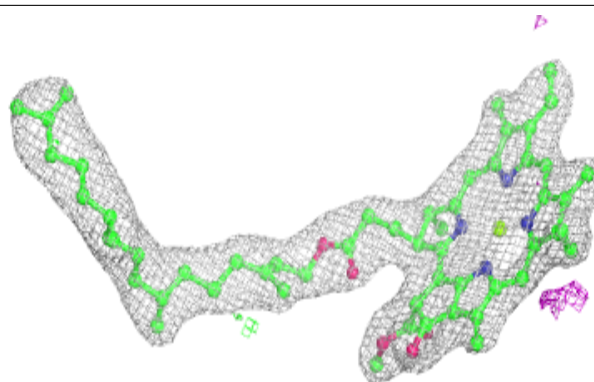
**Electron density around BCR B 617:**

$2mF_o-DF_c$ (at 0.7 rmsd) in gray
 mF_o-DF_c (at 3 rmsd) in purple (negative)
and green (positive)

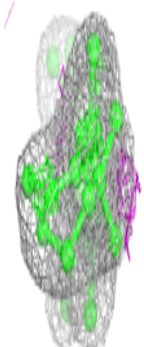
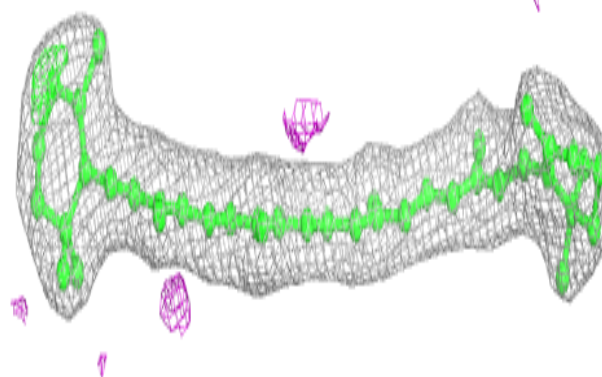
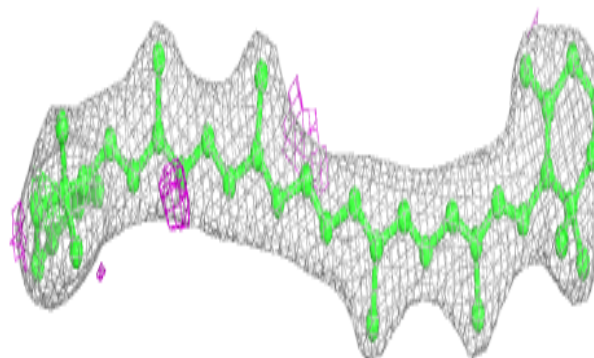

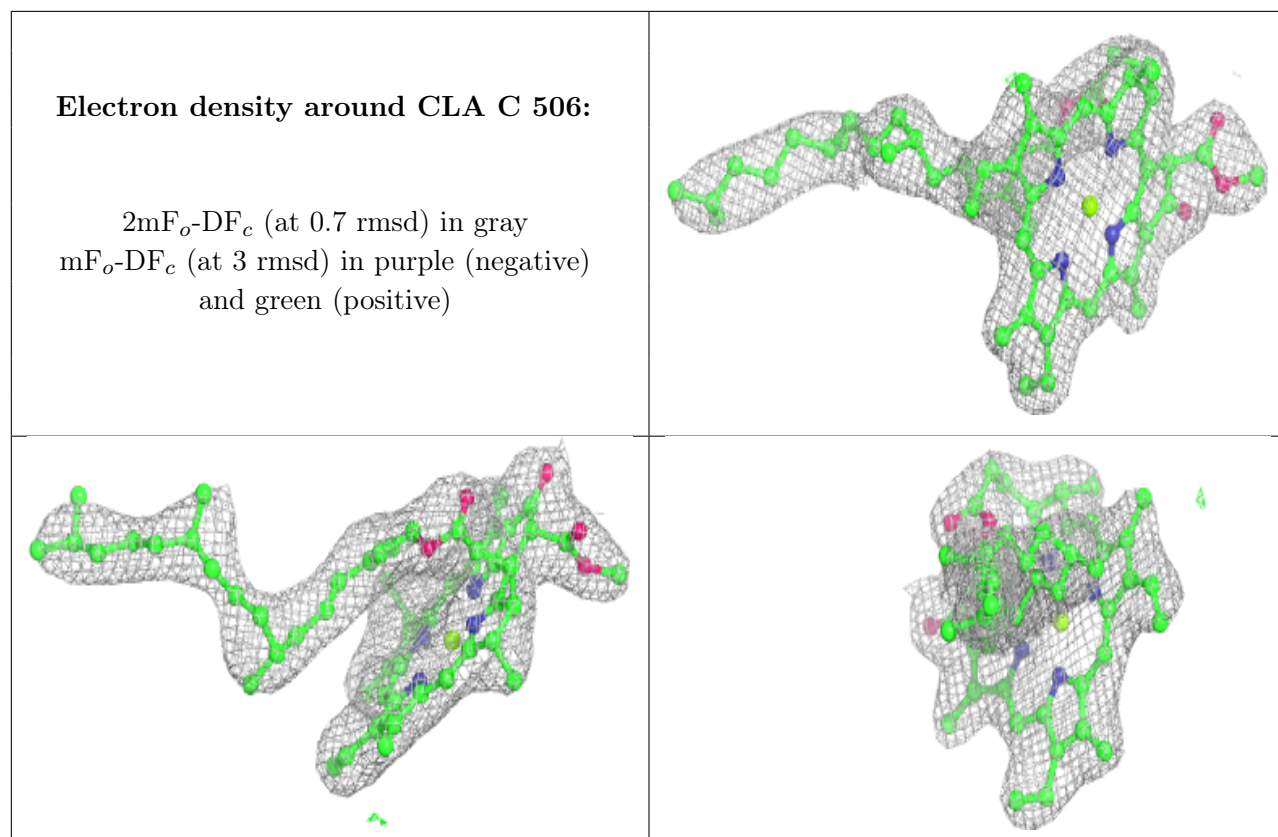

Electron density around BCT d 401 (A):

$2mF_o-DF_c$ (at 0.7 rmsd) in gray
 mF_o-DF_c (at 3 rmsd) in purple (negative)
and green (positive)

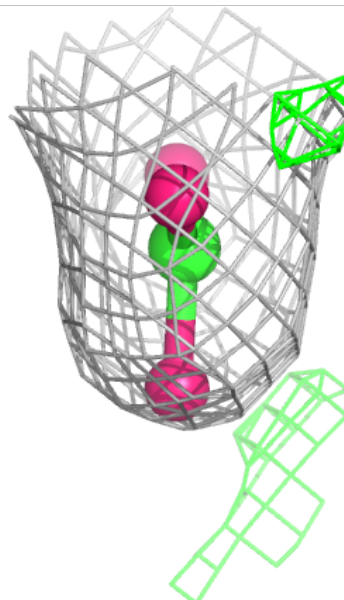
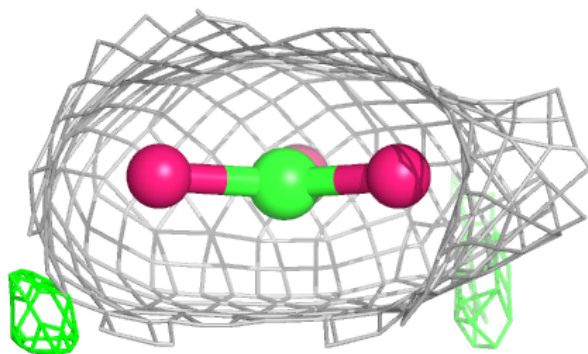
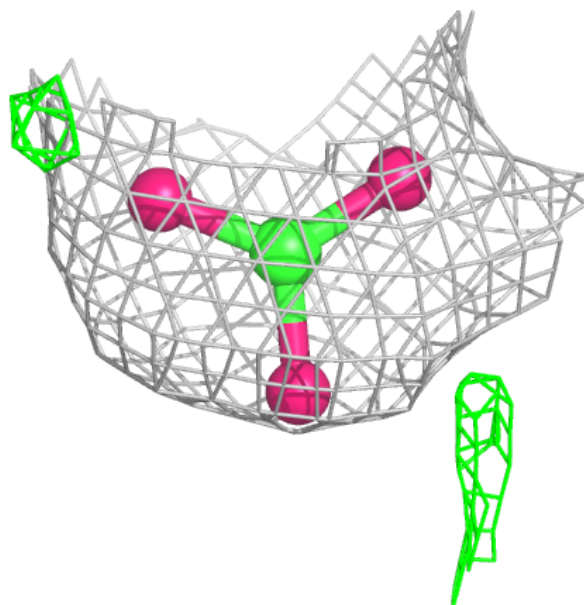

Electron density around BCT d 401 (B):

$2mF_o-DF_c$ (at 0.7 rmsd) in gray
 mF_o-DF_c (at 3 rmsd) in purple (negative)
and green (positive)

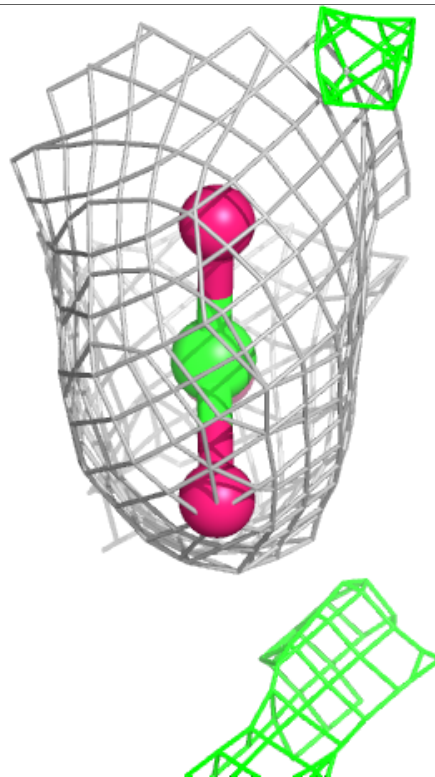
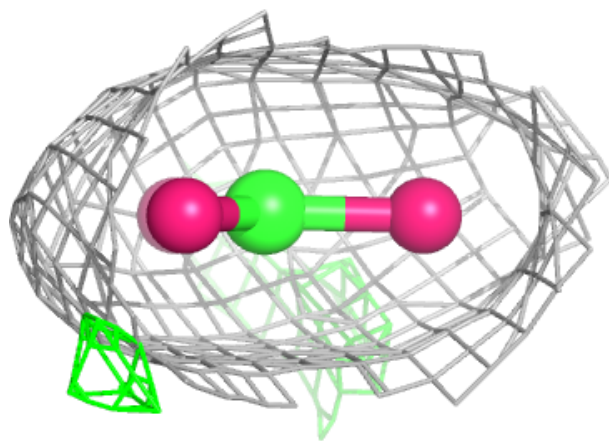
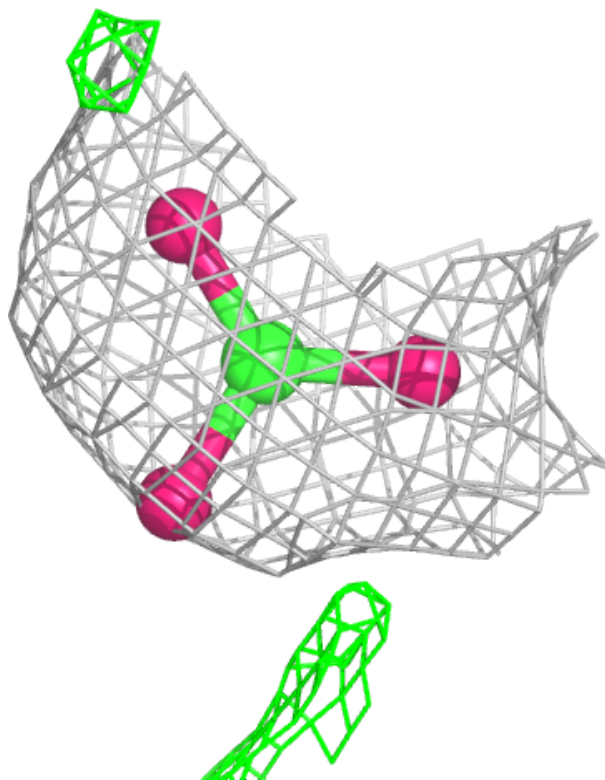

Electron density around HEM E 102:

$2mF_o-DF_c$ (at 0.7 rmsd) in gray
 mF_o-DF_c (at 3 rmsd) in purple (negative)
and green (positive)

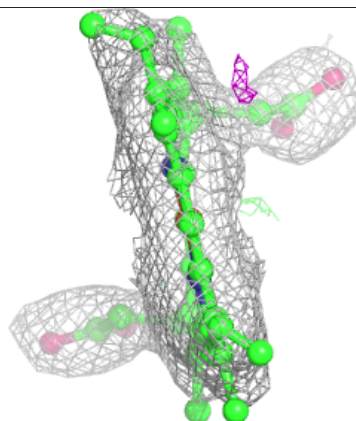
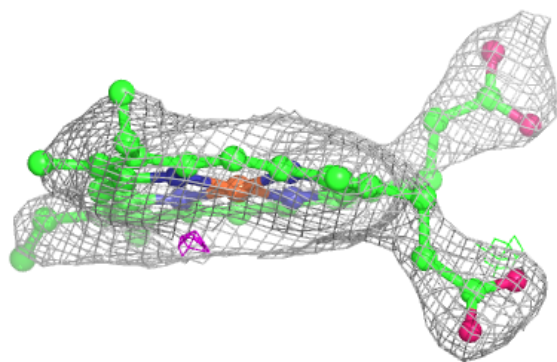
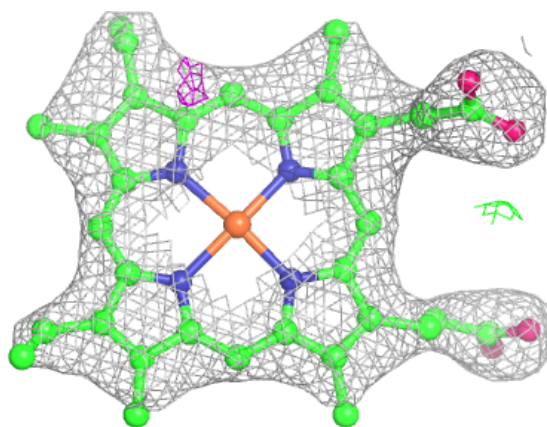
**Electron density around CLA B 605:**

$2mF_o-DF_c$ (at 0.7 rmsd) in gray
 mF_o-DF_c (at 3 rmsd) in purple (negative)
and green (positive)

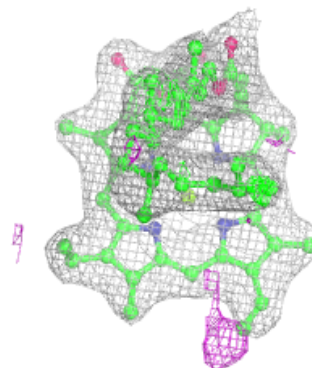
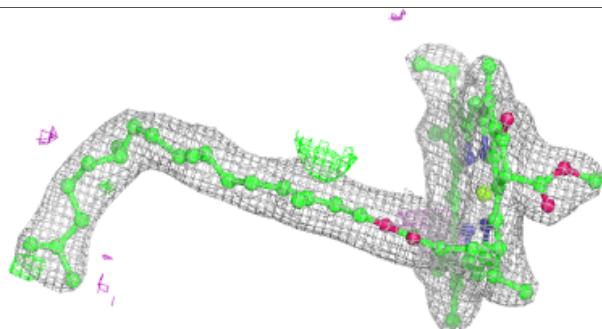
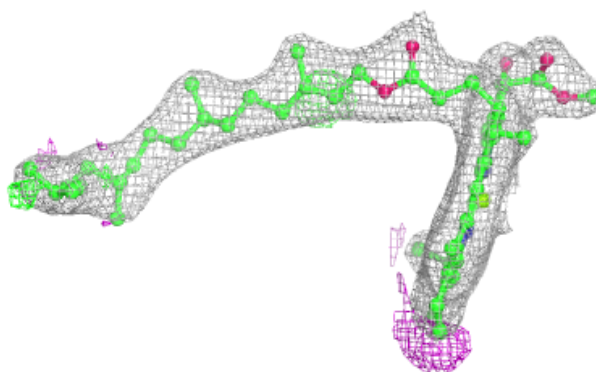

Electron density around HEC V 201:

$2mF_o-DF_c$ (at 0.7 rmsd) in gray
 mF_o-DF_c (at 3 rmsd) in purple (negative)
and green (positive)

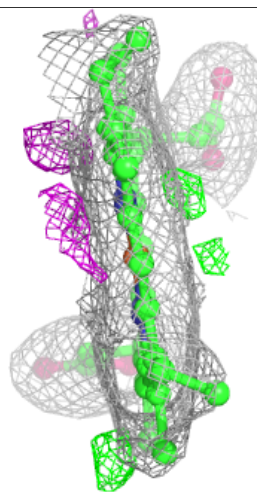
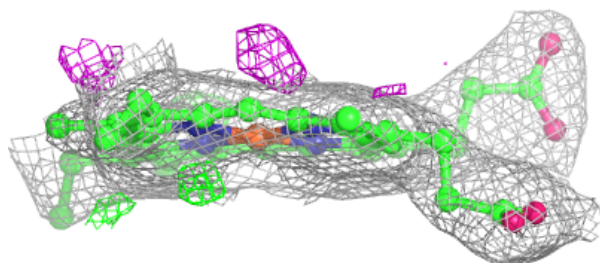
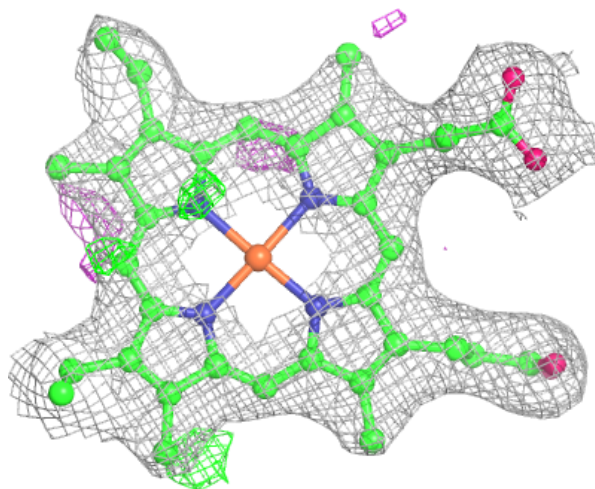

Electron density around CLA B 613:

$2mF_o-DF_c$ (at 0.7 rmsd) in gray
 mF_o-DF_c (at 3 rmsd) in purple (negative)
and green (positive)

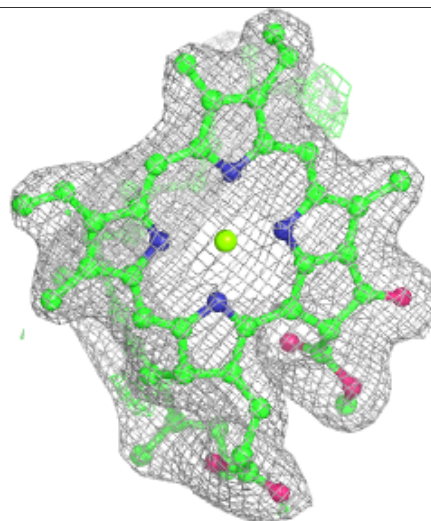
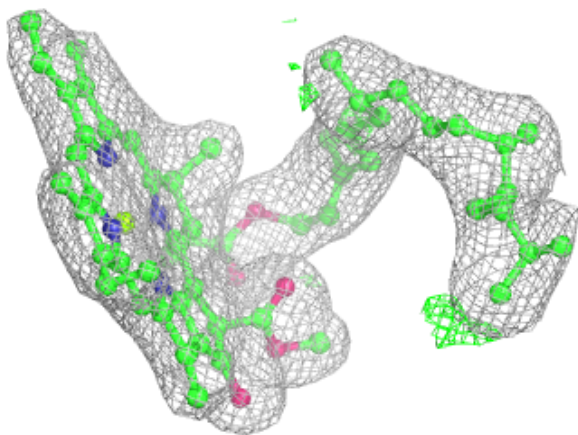
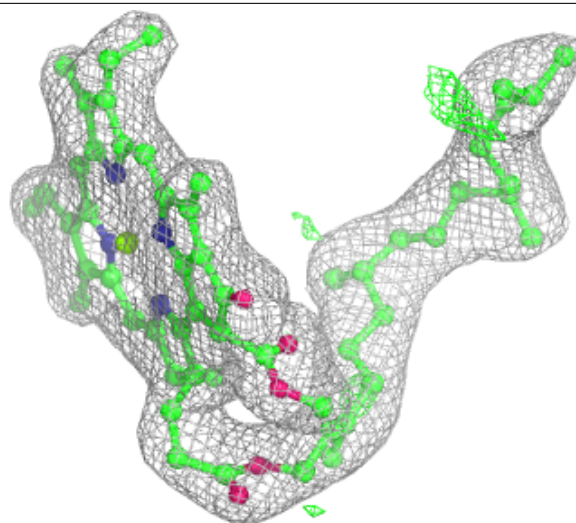

Electron density around BCT D 401 (A):

$2mF_o-DF_c$ (at 0.7 rmsd) in gray
 mF_o-DF_c (at 3 rmsd) in purple (negative)
and green (positive)

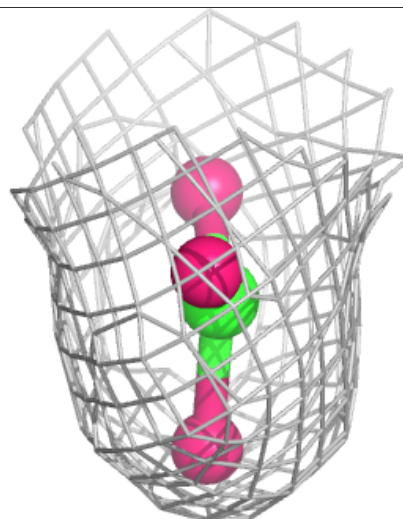
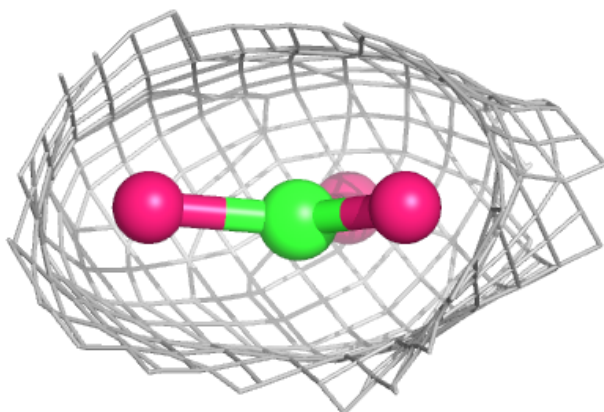
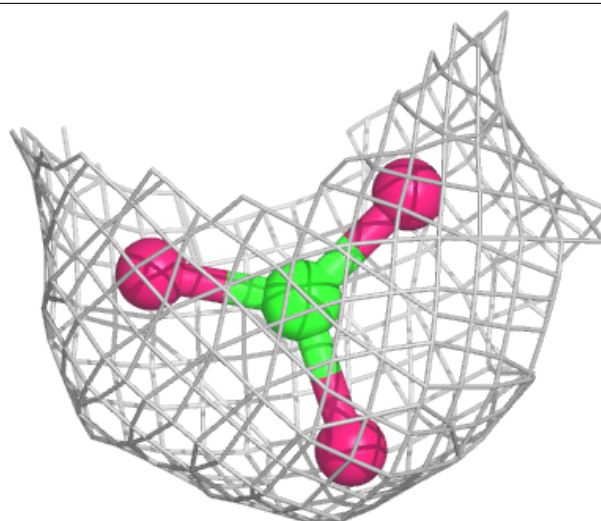

Electron density around BCT D 401 (B):

$2mF_o-DF_c$ (at 0.7 rmsd) in gray
 mF_o-DF_c (at 3 rmsd) in purple (negative)
and green (positive)

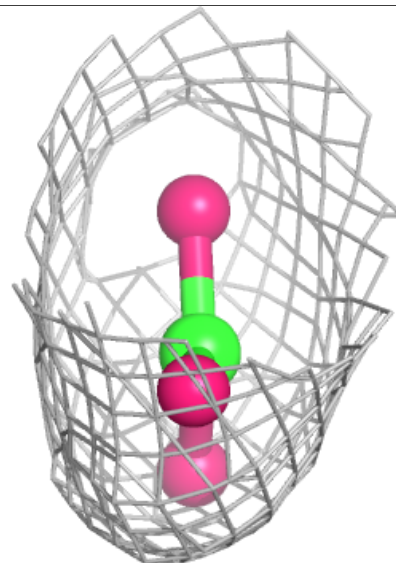
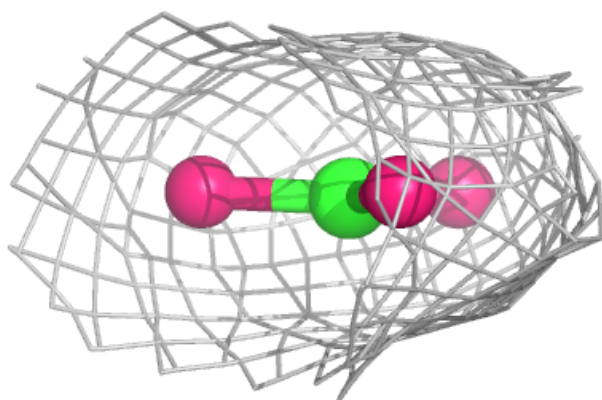
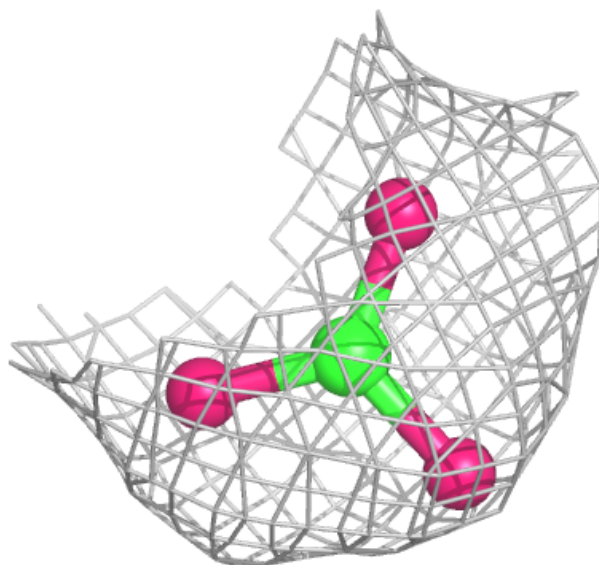

Electron density around CL a 402 (A):

$2mF_o-DF_c$ (at 0.7 rmsd) in gray
 mF_o-DF_c (at 3 rmsd) in purple (negative)
and green (positive)

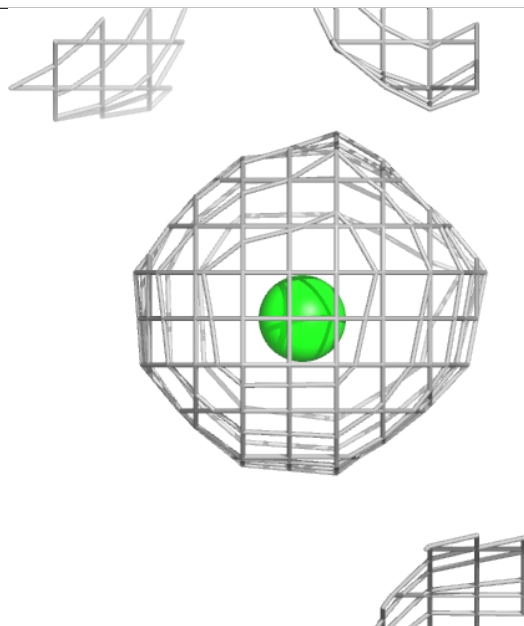
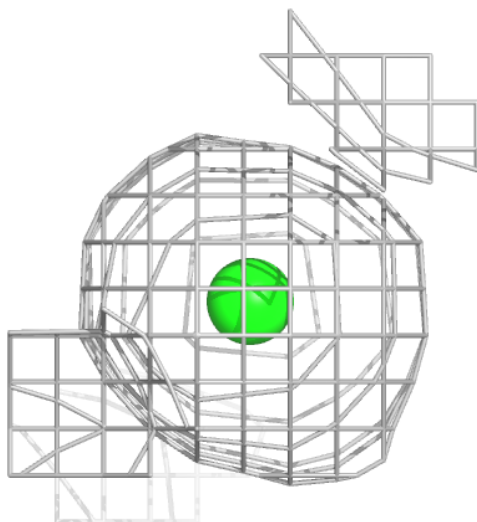
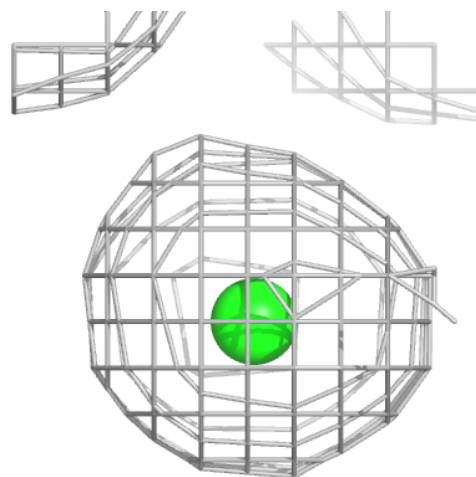

Electron density around CL a 402 (B):

$2mF_o-DF_c$ (at 0.7 rmsd) in gray
 mF_o-DF_c (at 3 rmsd) in purple (negative)
and green (positive)

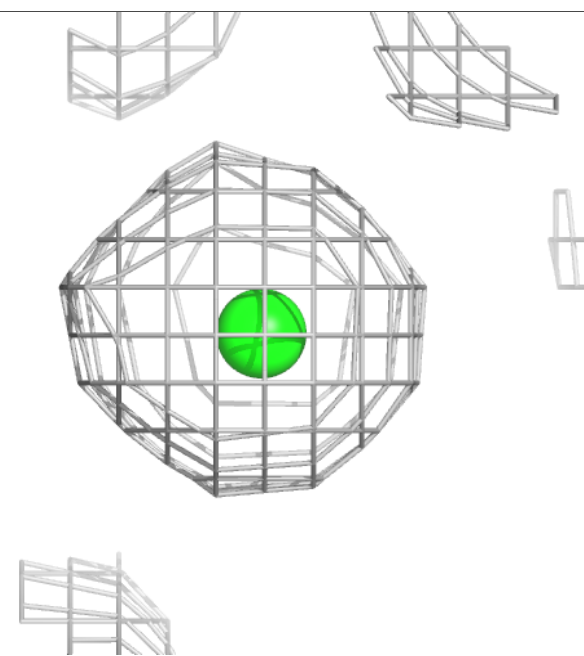
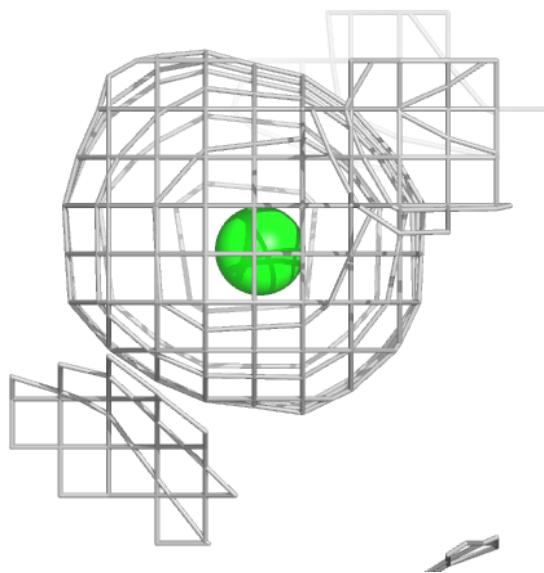
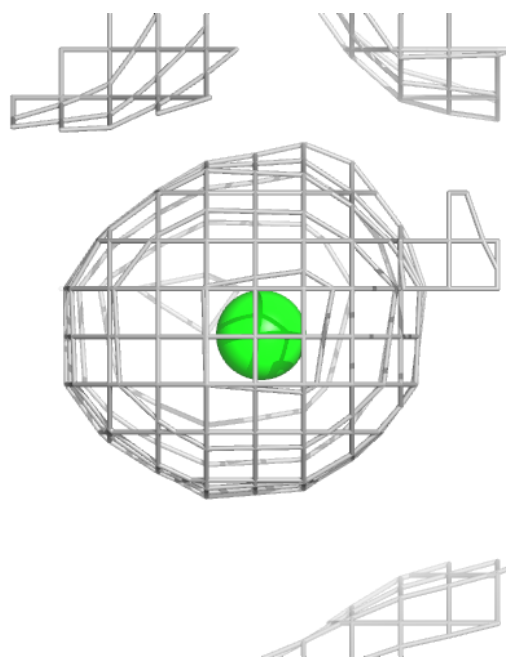

Electron density around OEX A 413 (A):

$2mF_o-DF_c$ (at 0.7 rmsd) in gray
 mF_o-DF_c (at 3 rmsd) in purple (negative)
and green (positive)

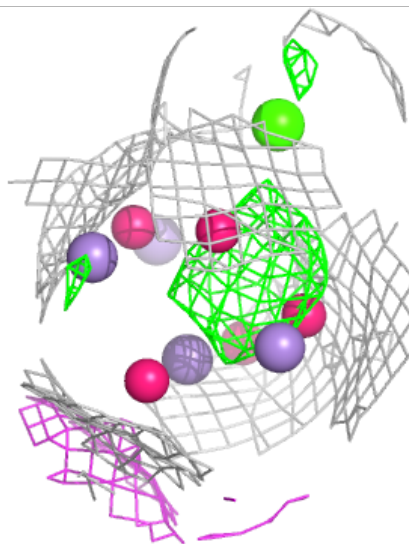
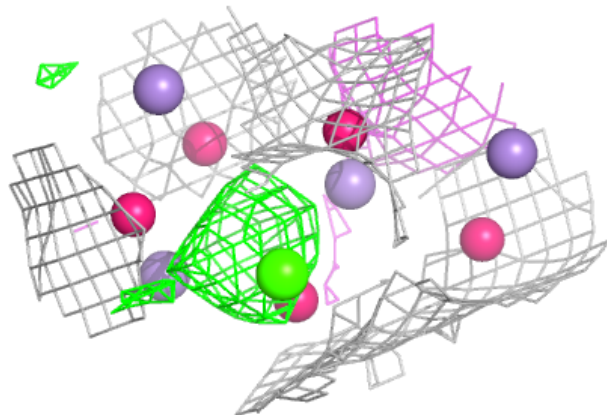
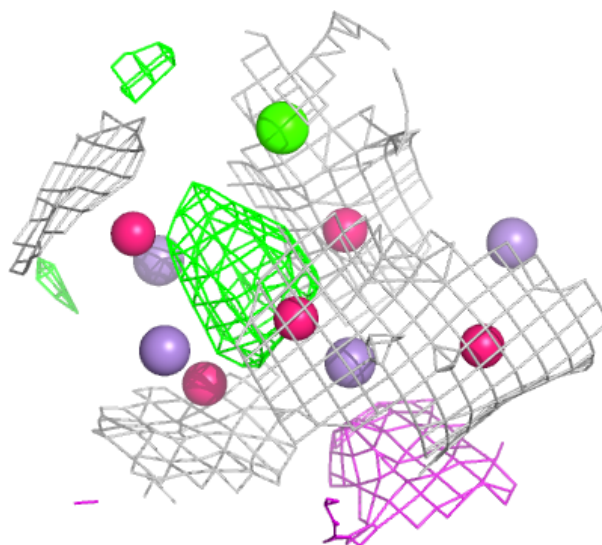

Electron density around OEX A 413 (B):

$2mF_o-DF_c$ (at 0.7 rmsd) in gray
 mF_o-DF_c (at 3 rmsd) in purple (negative)
and green (positive)

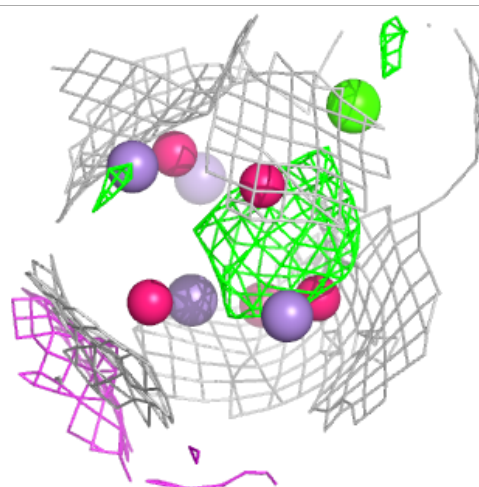
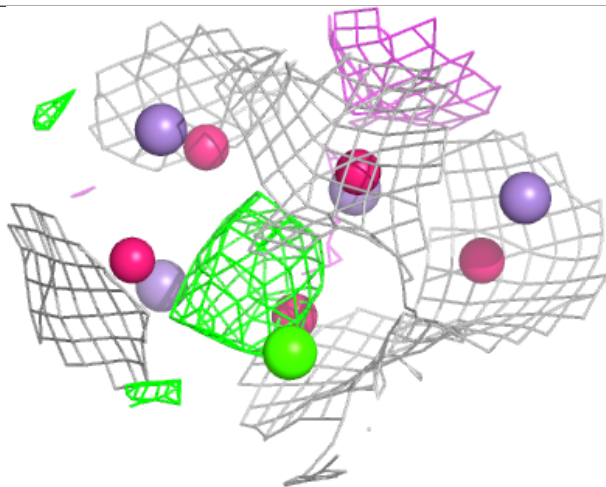
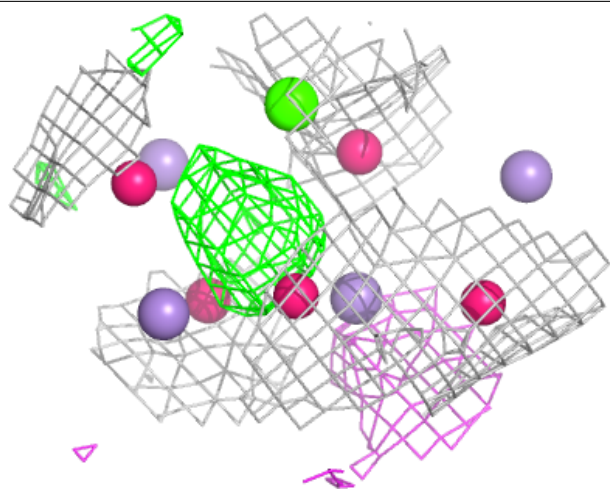

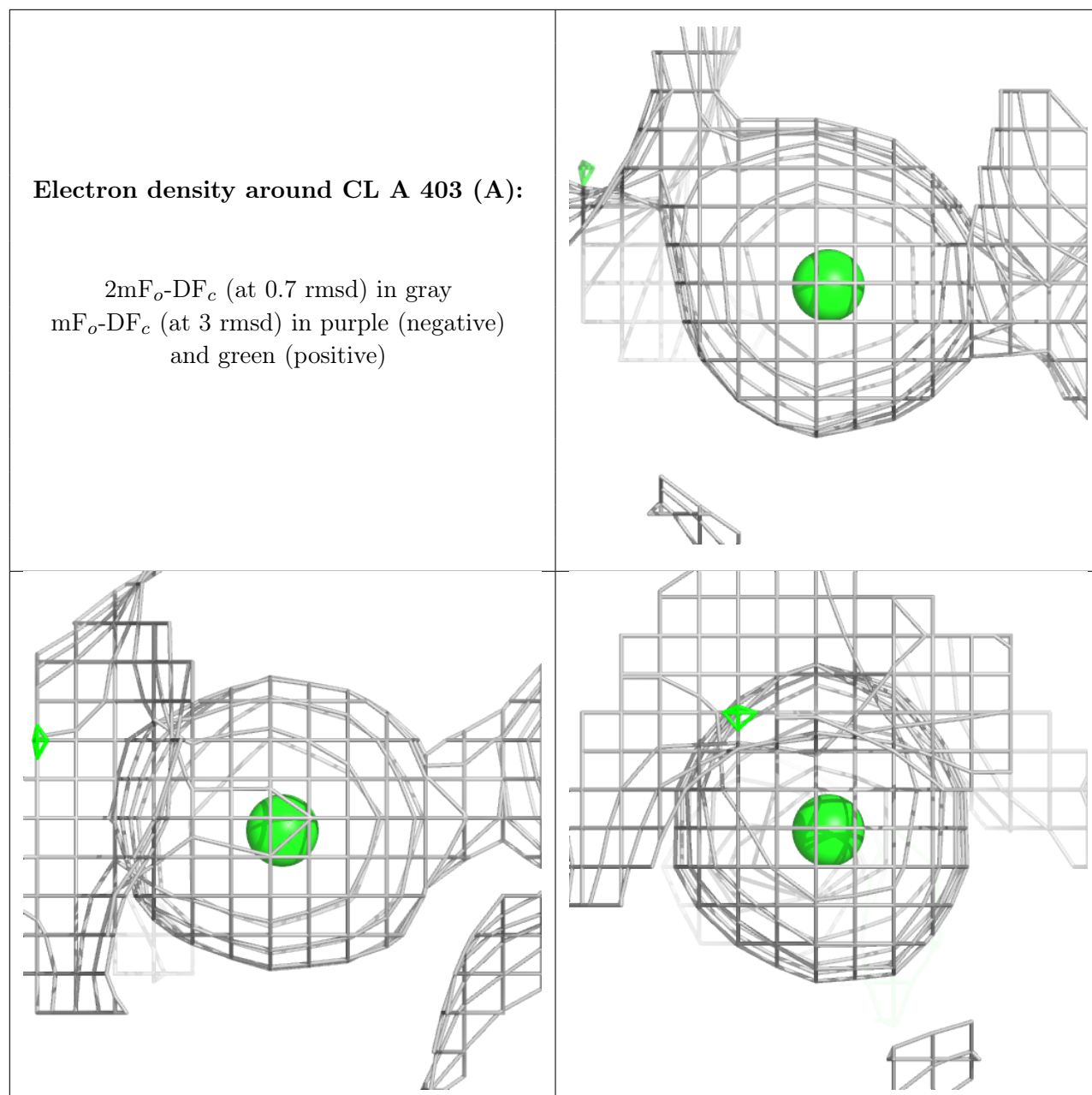

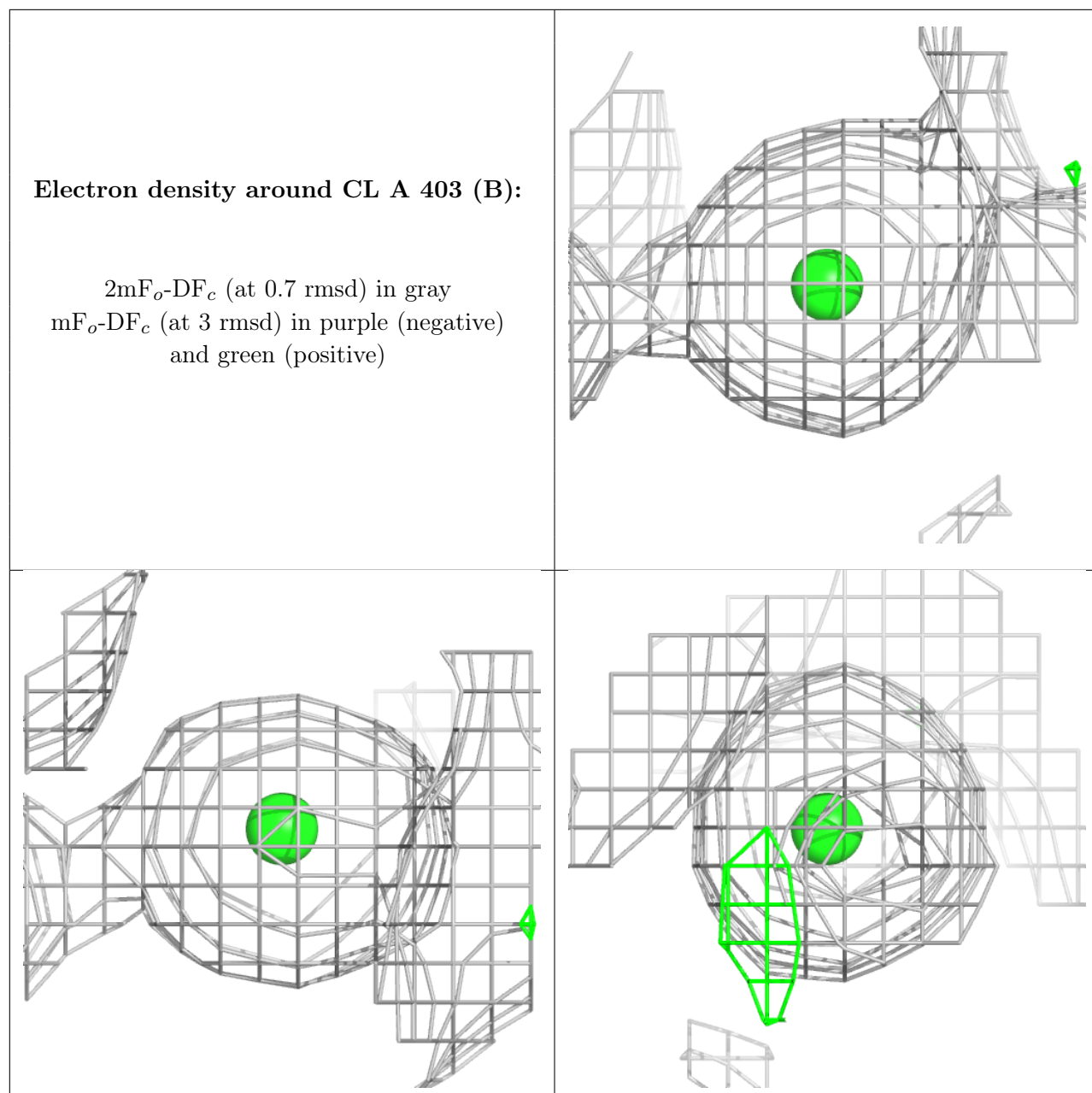

Electron density around CL a 403 (A):

$2mF_o-DF_c$ (at 0.7 rmsd) in gray
 mF_o-DF_c (at 3 rmsd) in purple (negative)
and green (positive)

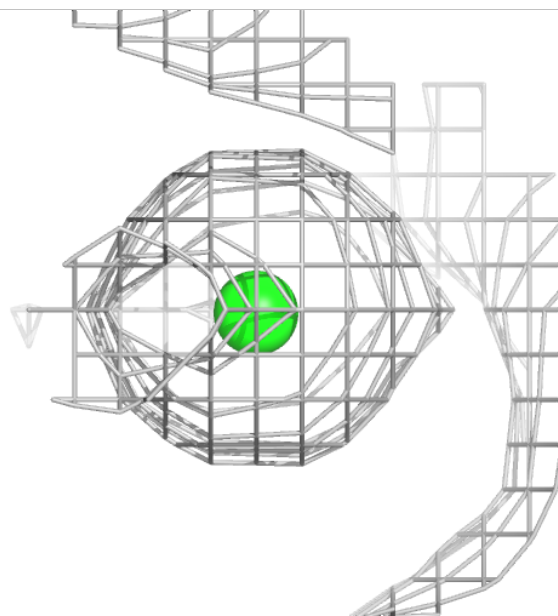
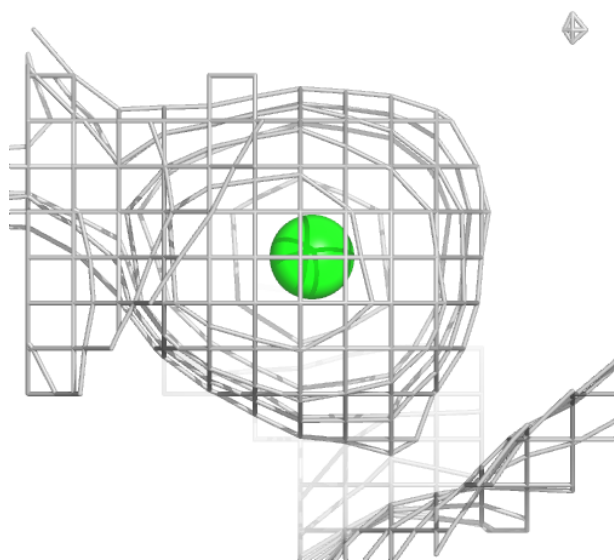
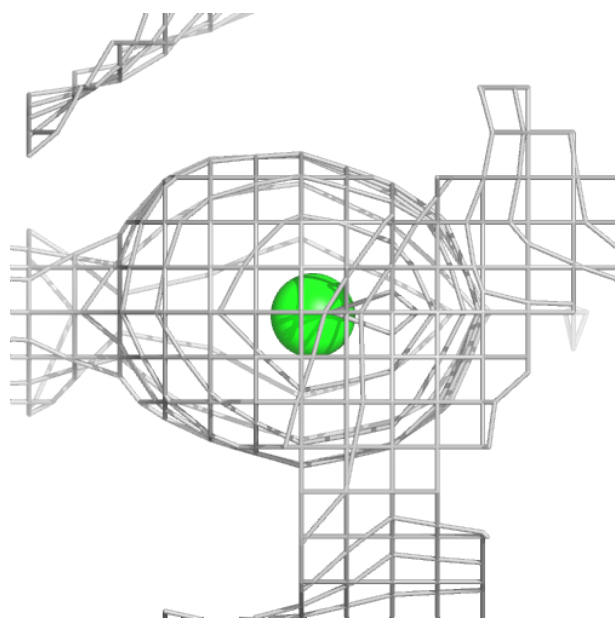

Electron density around CL a 403 (B):

$2mF_o-DF_c$ (at 0.7 rmsd) in gray
 mF_o-DF_c (at 3 rmsd) in purple (negative)
and green (positive)

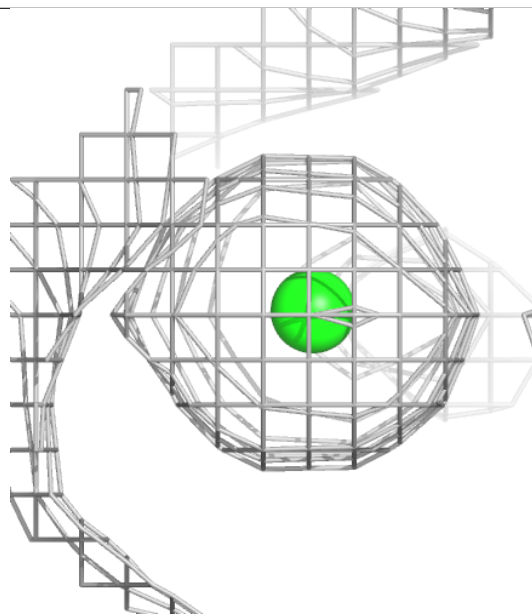
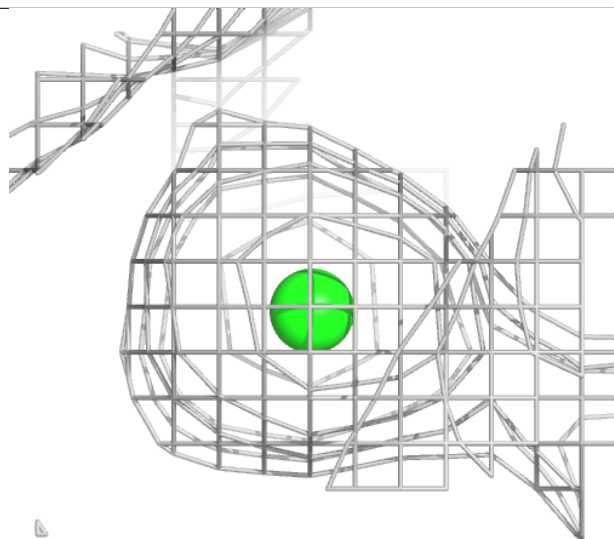
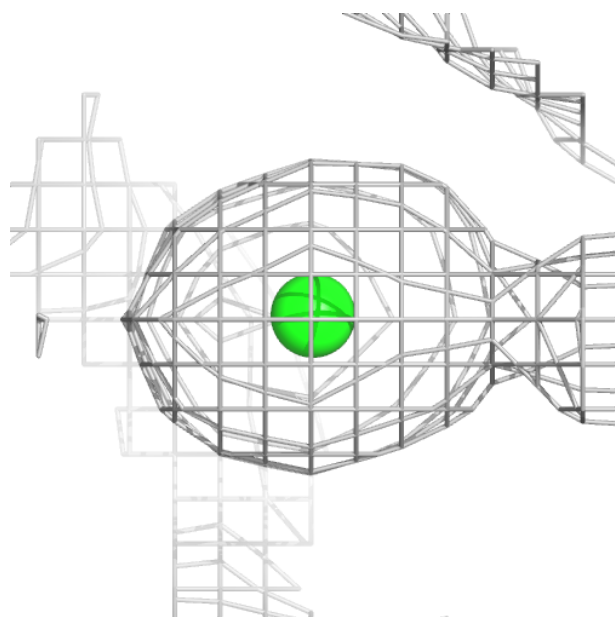

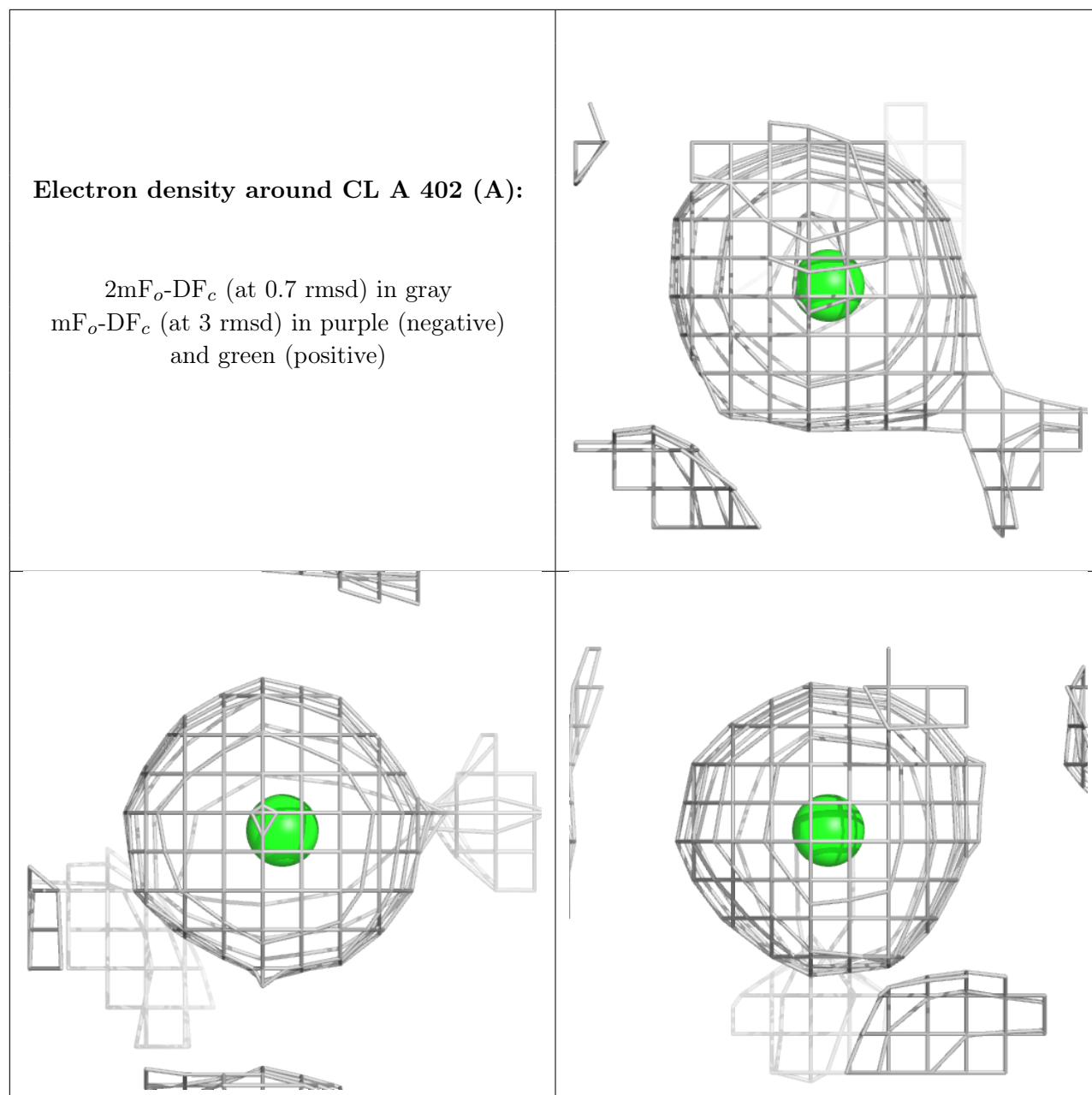

Electron density around CL A 402 (B):

$2mF_o-DF_c$ (at 0.7 rmsd) in gray
 mF_o-DF_c (at 3 rmsd) in purple (negative)
and green (positive)

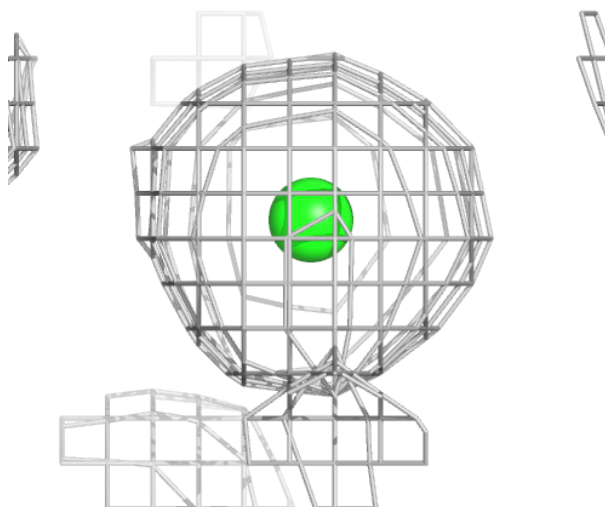
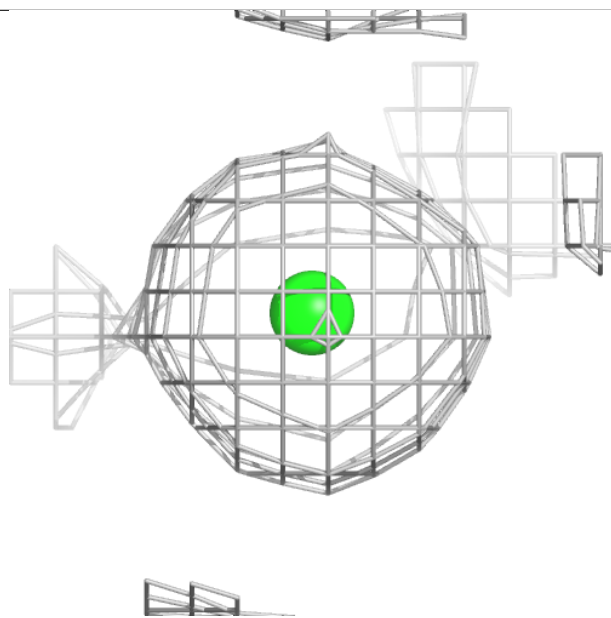
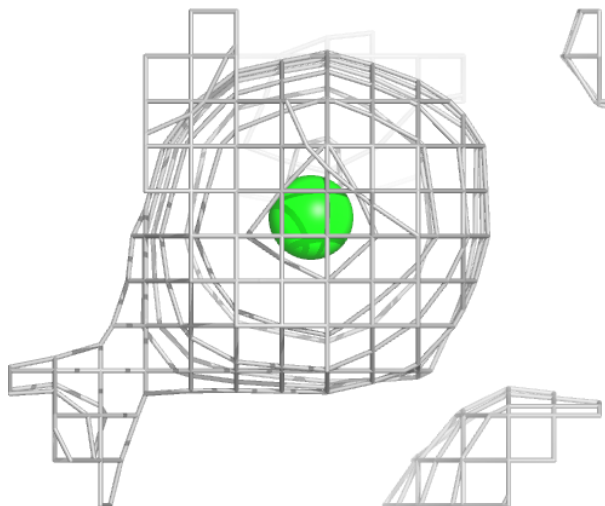

Electron density around OEX a 411 (A):

$2mF_o-DF_c$ (at 0.7 rmsd) in gray
 mF_o-DF_c (at 3 rmsd) in purple (negative)
and green (positive)

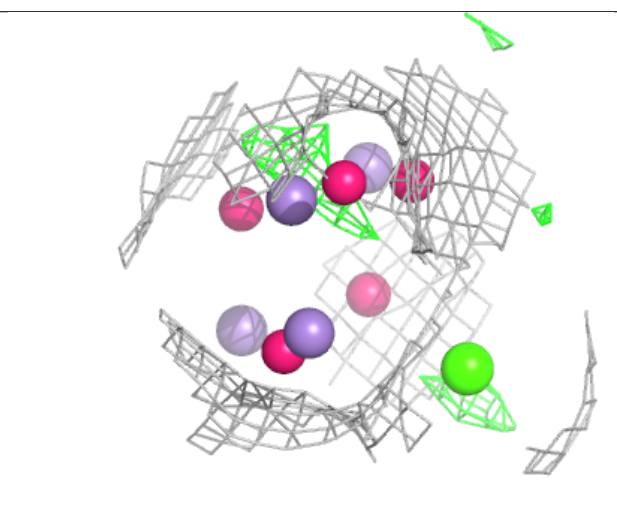
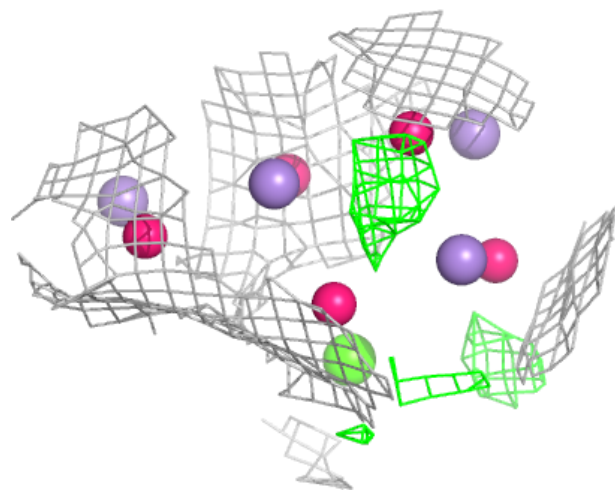
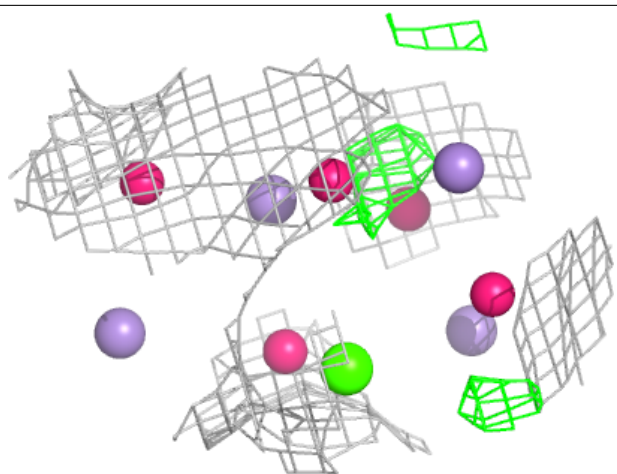

Electron density around OEX a 411 (B):

$2mF_o-DF_c$ (at 0.7 rmsd) in gray
 mF_o-DF_c (at 3 rmsd) in purple (negative)
and green (positive)

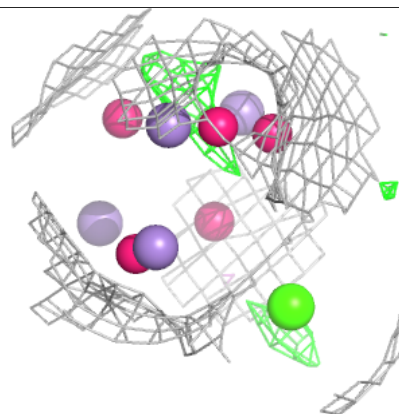
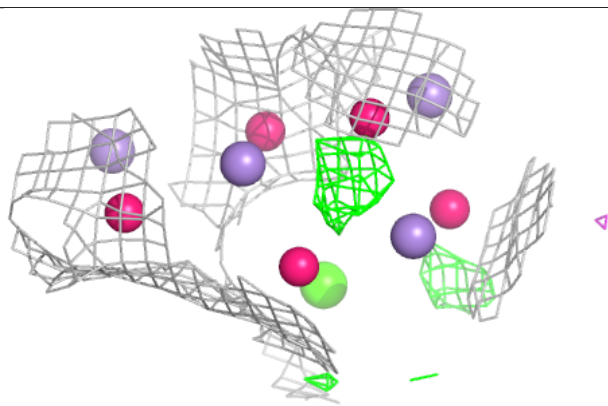
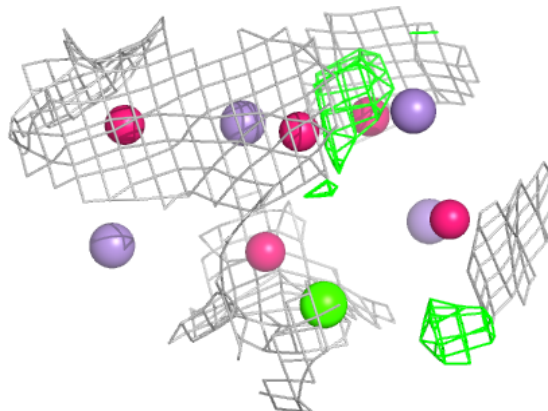

Electron density around FE2 A 401 (A):

$2mF_o-DF_c$ (at 0.7 rmsd) in gray
 mF_o-DF_c (at 3 rmsd) in purple (negative)
and green (positive)

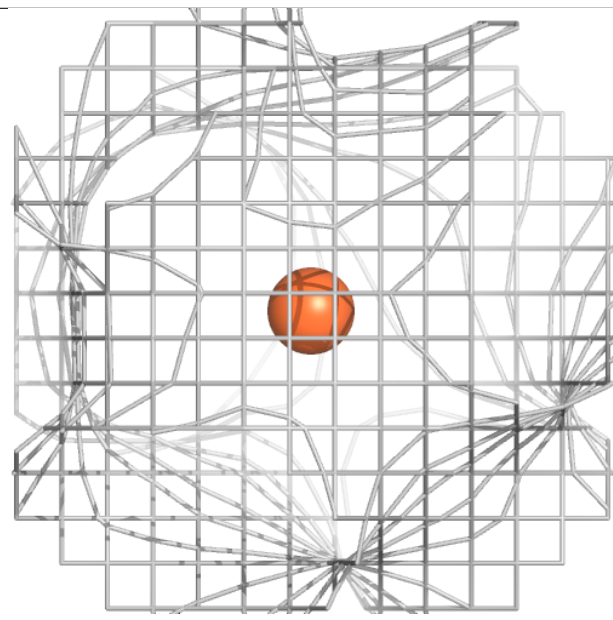
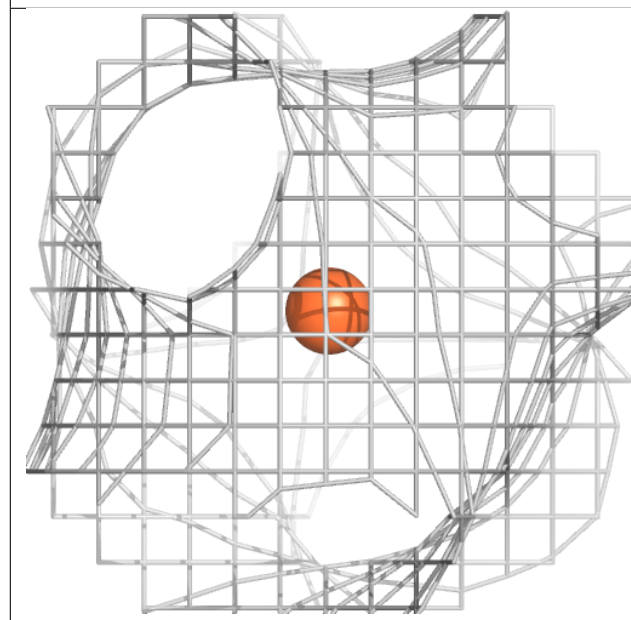
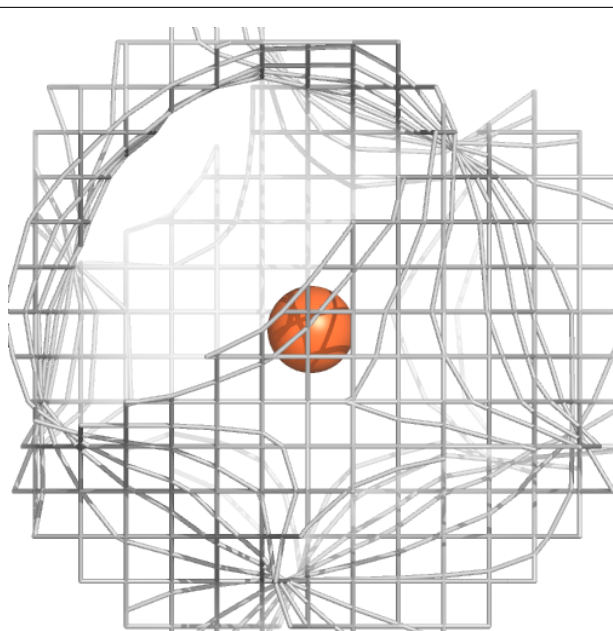

Electron density around FE2 A 401 (B):

$2mF_o-DF_c$ (at 0.7 rmsd) in gray
 mF_o-DF_c (at 3 rmsd) in purple (negative)
and green (positive)

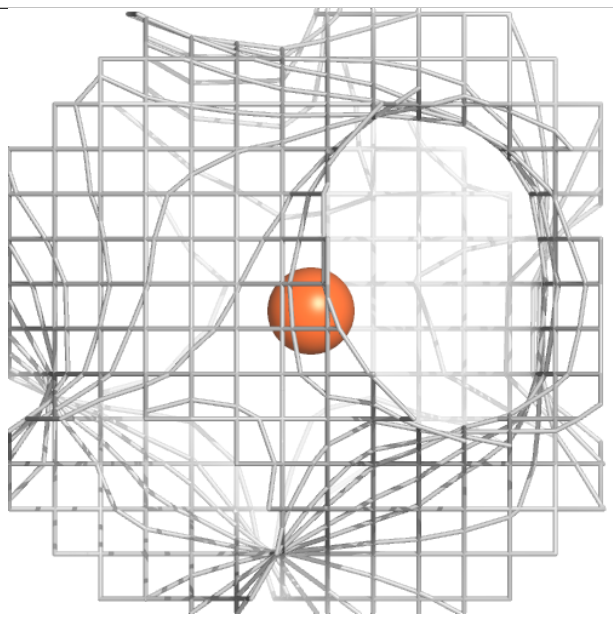
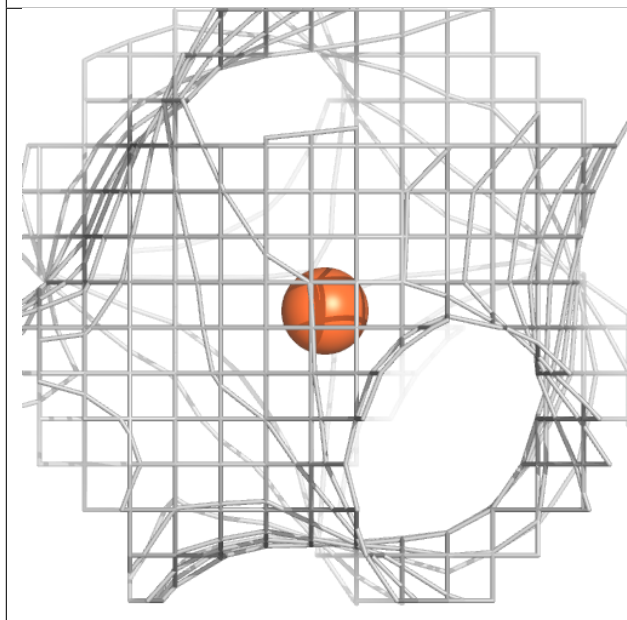
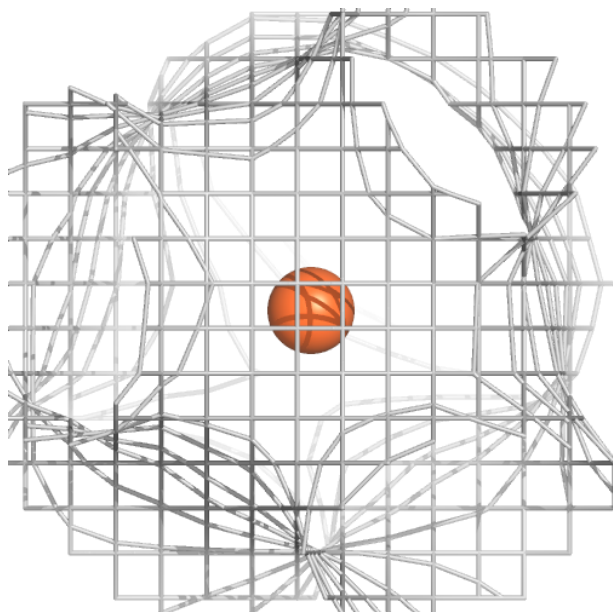

Electron density around FE2 a 401 (A):

$2mF_o-DF_c$ (at 0.7 rmsd) in gray
 mF_o-DF_c (at 3 rmsd) in purple (negative)
and green (positive)

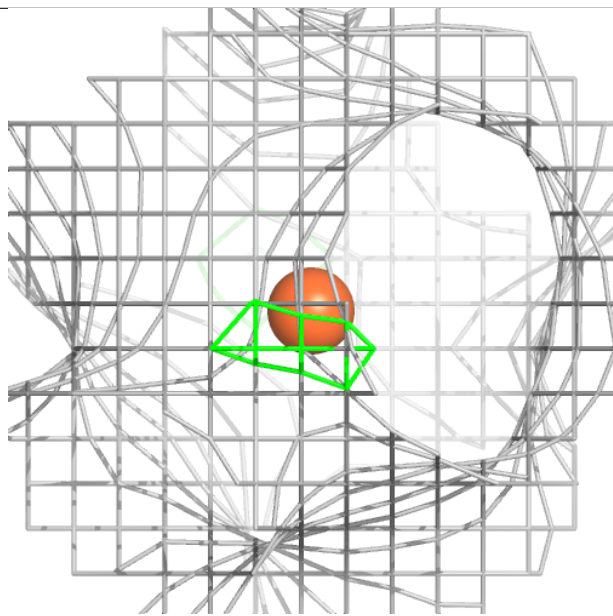
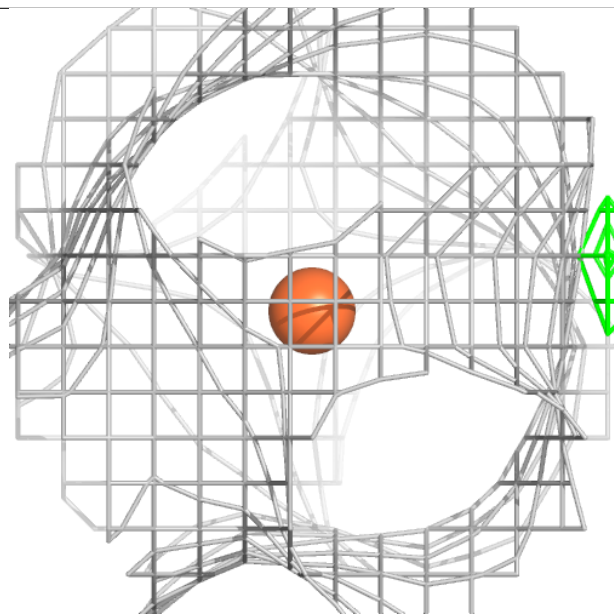
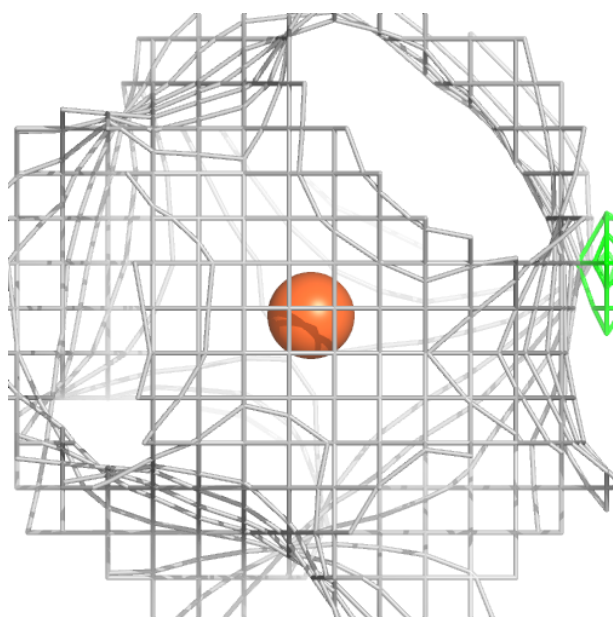

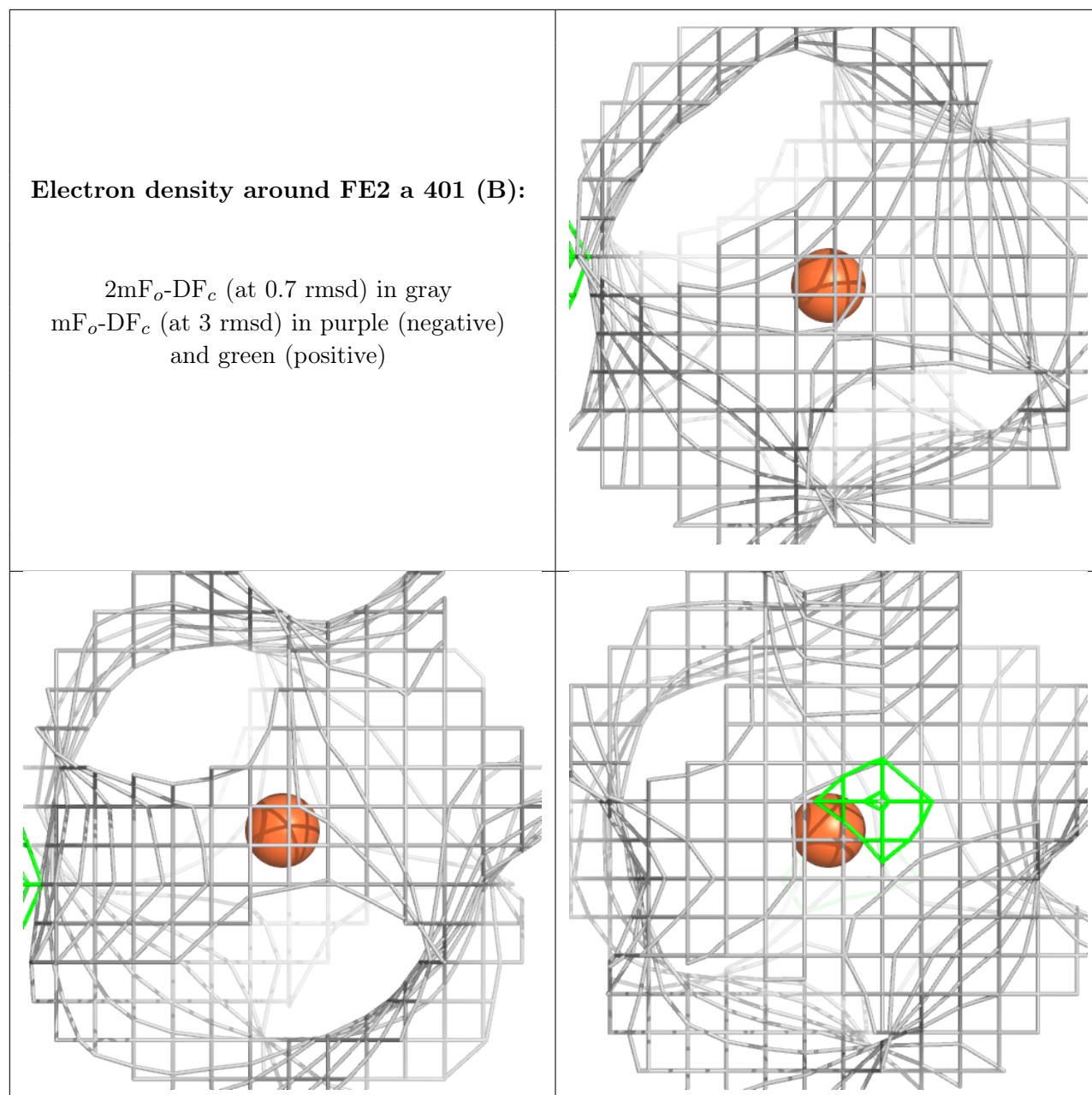

6.5 Other polymers [i](#)

There are no such residues in this entry.