



# Full wwPDB X-ray Structure Validation Report ⓘ

Oct 11, 2021 – 02:54 PM EDT

PDB ID : 2HT4  
Title : Structure of the Escherichia coli CIC chloride channel Y445W mutant and Fab complex  
Authors : Accardi, A.; Lobet, S.; Williams, C.; Miller, C.; Dutzler, R.  
Deposited on : 2006-07-25  
Resolution : 3.20 Å(reported)

This is a Full wwPDB X-ray Structure Validation Report for a publicly released PDB entry.

We welcome your comments at [validation@mail.wwpdb.org](mailto:validation@mail.wwpdb.org)

A user guide is available at

<https://www.wwpdb.org/validation/2017/XrayValidationReportHelp>

with specific help available everywhere you see the ⓘ symbol.

---

The following versions of software and data (see [references ⓘ](#)) were used in the production of this report:

MolProbity : 4.02b-467  
Xtriage (Phenix) : 1.13  
EDS : 2.23.2  
Percentile statistics : 20191225.v01 (using entries in the PDB archive December 25th 2019)  
Refmac : 5.8.0158  
CCP4 : 7.0.044 (Gargrove)  
Ideal geometry (proteins) : Engh & Huber (2001)  
Ideal geometry (DNA, RNA) : Parkinson et al. (1996)  
Validation Pipeline (wwPDB-VP) : 2.23.2

# 1 Overall quality at a glance

The following experimental techniques were used to determine the structure:

*X-RAY DIFFRACTION*

The reported resolution of this entry is 3.20 Å.

Percentile scores (ranging between 0-100) for global validation metrics of the entry are shown in the following graphic. The table shows the number of entries on which the scores are based.

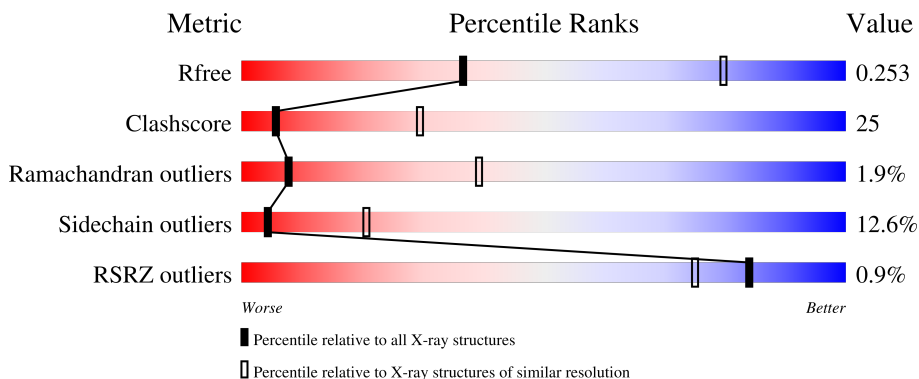

Metric	Whole archive (#Entries)	Similar resolution (#Entries, resolution range(Å))
$R_{free}$	130704	1133 (3.20-3.20)
Clashscore	141614	1253 (3.20-3.20)
Ramachandran outliers	138981	1234 (3.20-3.20)
Sidechain outliers	138945	1233 (3.20-3.20)
RSRZ outliers	127900	1095 (3.20-3.20)

The table below summarises the geometric issues observed across the polymeric chains and their fit to the electron density. The red, orange, yellow and green segments of the lower bar indicate the fraction of residues that contain outliers for  $\geq 3$ , 2, 1 and 0 types of geometric quality criteria respectively. A grey segment represents the fraction of residues that are not modelled. The numeric value for each fraction is indicated below the corresponding segment, with a dot representing fractions  $\leq 5\%$ . The upper red bar (where present) indicates the fraction of residues that have poor fit to the electron density. The numeric value is given above the bar.

Mol	Chain	Length	Quality of chain
1	A	473	
1	B	473	
2	C	221	
2	E	221	
3	D	211	

*Continued on next page...*

*Continued from previous page...*

Mol	Chain	Length	Quality of chain
3	F	211	 50% 44% 7%

The following table lists non-polymeric compounds, carbohydrate monomers and non-standard residues in protein, DNA, RNA chains that are outliers for geometric or electron-density-fit criteria:

Mol	Type	Chain	Res	Chirality	Geometry	Clashes	Electron density
4	BR	A	474	-	-	X	-
4	BR	B	474	-	-	X	-
4	BR	B	475	-	-	X	-

## 2 Entry composition [i](#)

There are 4 unique types of molecules in this entry. The entry contains 13231 atoms, of which 0 are hydrogens and 0 are deuteriums.

In the tables below, the ZeroOcc column contains the number of atoms modelled with zero occupancy, the AltConf column contains the number of residues with at least one atom in alternate conformation and the Trace column contains the number of residues modelled with at most 2 atoms.

- Molecule 1 is a protein called H(+)/Cl(-) exchange transporter clcA.

Mol	Chain	Residues	Atoms					ZeroOcc	AltConf	Trace
			Total	C	N	O	S			
1	A	444	Total	C	N	O	S	0	0	0
			3335	2192	561	562	20			
1	B	441	Total	C	N	O	S	0	0	0
			3306	2176	554	556	20			

There are 2 discrepancies between the modelled and reference sequences:

Chain	Residue	Modelled	Actual	Comment	Reference
A	445	TRP	TYR	engineered mutation	UNP P37019
B	445	TRP	TYR	engineered mutation	UNP P37019

- Molecule 2 is a protein called Fab fragment, Heavy chain.

Mol	Chain	Residues	Atoms					ZeroOcc	AltConf	Trace
			Total	C	N	O	S			
2	C	221	Total	C	N	O	S	0	0	0
			1672	1077	274	315	6			
2	E	221	Total	C	N	O	S	0	0	0
			1672	1077	274	315	6			

- Molecule 3 is a protein called Fab fragment, Light chain.

Mol	Chain	Residues	Atoms					ZeroOcc	AltConf	Trace
			Total	C	N	O	S			
3	D	211	Total	C	N	O	S	0	0	0
			1621	1008	271	334	8			
3	F	211	Total	C	N	O	S	0	0	0
			1621	1008	271	334	8			

- Molecule 4 is BROMIDE ION (three-letter code: BR) (formula: Br).

Mol	Chain	Residues	Atoms	ZeroOcc	AltConf
4	A	2	Total	0	0
			2		

*Continued on next page...*

*Continued from previous page...*

<b>Mol</b>	<b>Chain</b>	<b>Residues</b>	<b>Atoms</b>		<b>ZeroOcc</b>	<b>AltConf</b>
4	B	2	Total 2	Br 2	0	0

### 3 Residue-property plots i

These plots are drawn for all protein, RNA, DNA and oligosaccharide chains in the entry. The first graphic for a chain summarises the proportions of the various outlier classes displayed in the second graphic. The second graphic shows the sequence view annotated by issues in geometry and electron density. Residues are color-coded according to the number of geometric quality criteria for which they contain at least one outlier: green = 0, yellow = 1, orange = 2 and red = 3 or more. A red dot above a residue indicates a poor fit to the electron density ( $RSRZ > 2$ ). Stretches of 2 or more consecutive residues without any outlier are shown as a green connector. Residues present in the sample, but not in the model, are shown in grey.

- Molecule 1: H(+)/Cl(-) exchange transporter *clcA*

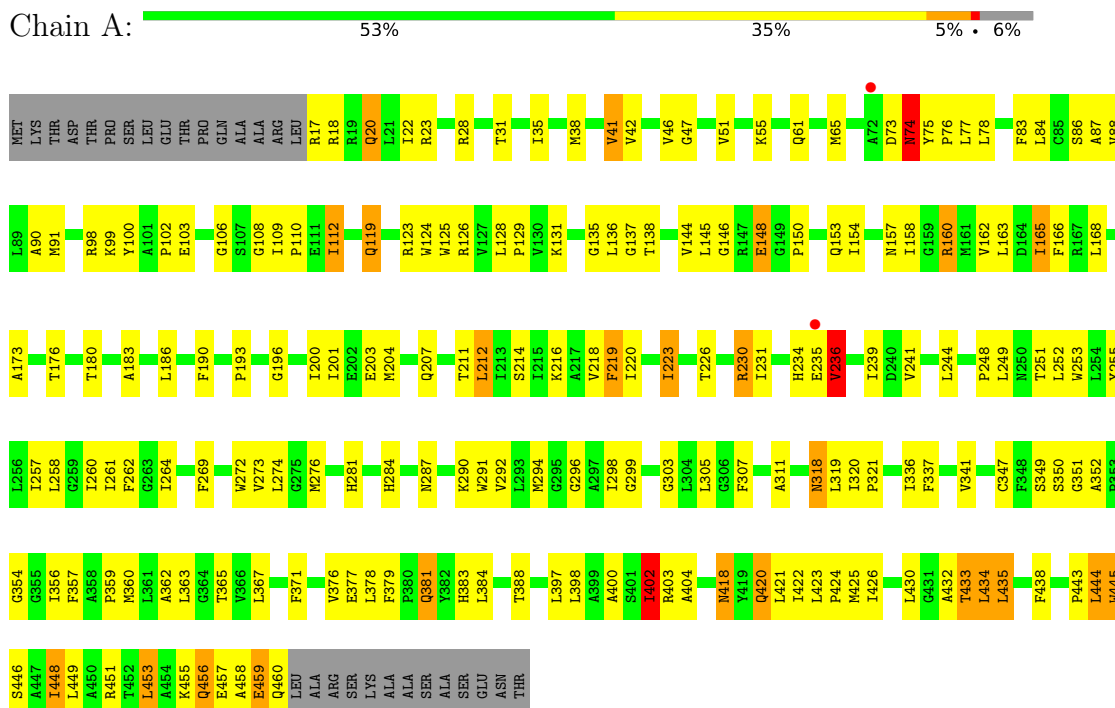

- Molecule 1: H(+)/Cl(-) exchange transporter *clcA*

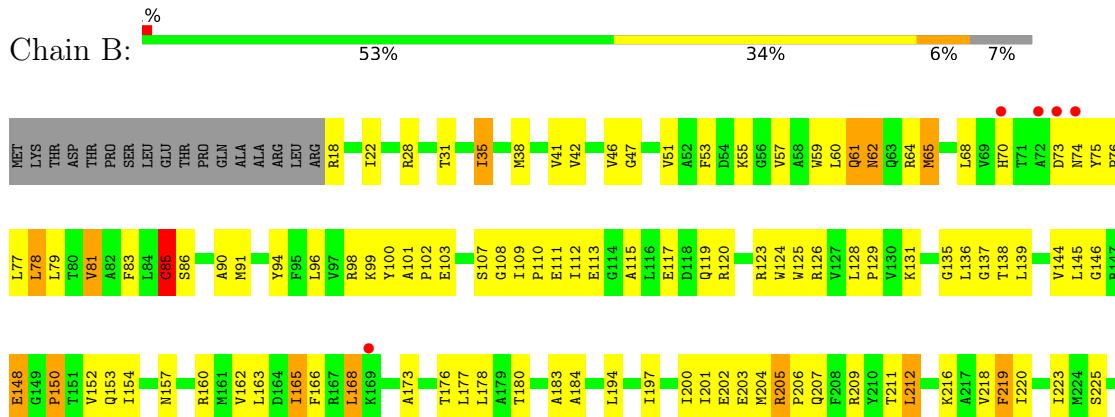

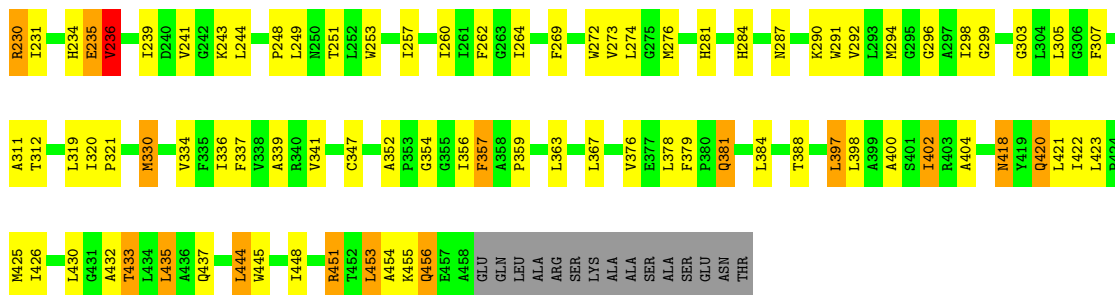

- Molecule 2: Fab fragment, Heavy chain

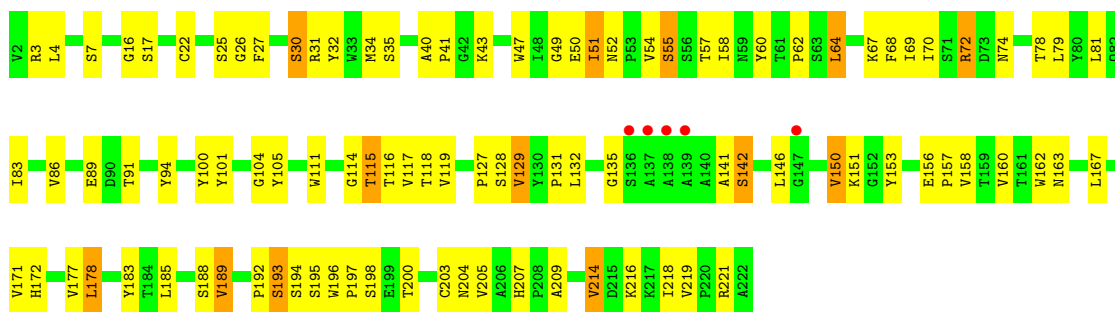

- Molecule 2: Fab fragment, Heavy chain

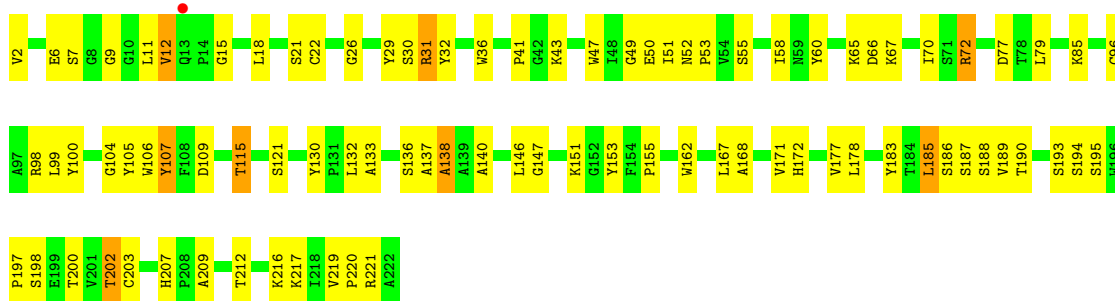

- Molecule 3: Fab fragment, Light chain

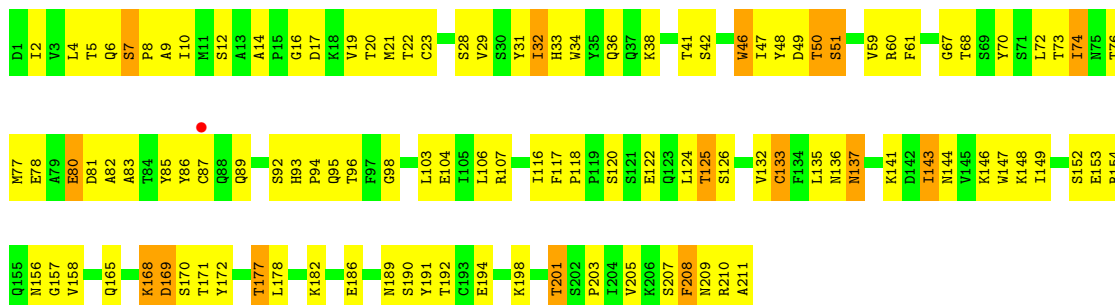

- Molecule 3: Fab fragment, Light chain

Chain F:  50% 44% 7%

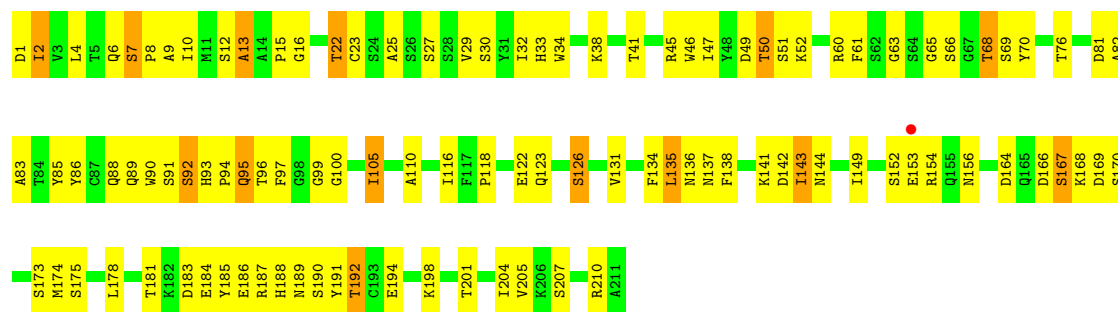



## 4 Data and refinement statistics i

Property	Value	Source
Space group	C 1 2 1	Depositor
Cell constants a, b, c, $\alpha$ , $\beta$ , $\gamma$	234.01Å 95.94Å 175.33Å 90.00° 133.20° 90.00°	Depositor
Resolution (Å)	40.00 – 3.20 19.87 – 3.20	Depositor EDS
% Data completeness (in resolution range)	97.0 (40.00-3.20) 97.0 (19.87-3.20)	Depositor EDS
$R_{merge}$	0.09	Depositor
$R_{sym}$	(Not available)	Depositor
$\langle I/\sigma(I) \rangle$ <sup>1</sup>	2.02 (at 3.22Å)	Xtrriage
Refinement program	REFMAC 5.2.0005	Depositor
R, $R_{free}$	0.239 , 0.261 0.231 , 0.253	Depositor DCC
$R_{free}$ test set	2315 reflections (4.95%)	wwPDB-VP
Wilson B-factor (Å <sup>2</sup> )	78.8	Xtrriage
Anisotropy	0.526	Xtrriage
Bulk solvent $k_{sol}$ (e/Å <sup>3</sup> ), $B_{sol}$ (Å <sup>2</sup> )	0.28 , 69.1	EDS
L-test for twinning <sup>2</sup>	$\langle  L  \rangle = 0.47$ , $\langle L^2 \rangle = 0.30$	Xtrriage
Estimated twinning fraction	0.016 for h,-k,-h-l	Xtrriage
$F_o, F_c$ correlation	0.92	EDS
Total number of atoms	13231	wwPDB-VP
Average B, all atoms (Å <sup>2</sup> )	82.0	wwPDB-VP

Xtrriage's analysis on translational NCS is as follows: *The largest off-origin peak in the Patterson function is 3.70% of the height of the origin peak. No significant pseudotranslation is detected.*

<sup>1</sup>Intensities estimated from amplitudes.

<sup>2</sup>Theoretical values of  $\langle |L| \rangle$ ,  $\langle L^2 \rangle$  for acentric reflections are 0.5, 0.333 respectively for untwinned datasets, and 0.375, 0.2 for perfectly twinned datasets.

## 5 Model quality [i](#)

### 5.1 Standard geometry [i](#)

Bond lengths and bond angles in the following residue types are not validated in this section: BR

The Z score for a bond length (or angle) is the number of standard deviations the observed value is removed from the expected value. A bond length (or angle) with  $|Z| > 5$  is considered an outlier worth inspection. RMSZ is the root-mean-square of all Z scores of the bond lengths (or angles).

Mol	Chain	Bond lengths		Bond angles	
		RMSZ	# Z  >5	RMSZ	# Z  >5
1	A	0.59	1/3408 (0.0%)	0.76	2/4626 (0.0%)
1	B	0.60	1/3379 (0.0%)	0.76	0/4588
2	C	0.68	0/1721	0.78	0/2355
2	E	0.62	0/1721	0.78	1/2355 (0.0%)
3	D	0.62	1/1660 (0.1%)	0.75	0/2257
3	F	0.58	0/1660	0.75	0/2257
All	All	0.61	3/13549 (0.0%)	0.76	3/18438 (0.0%)

Chiral center outliers are detected by calculating the chiral volume of a chiral center and verifying if the center is modelled as a planar moiety or with the opposite hand. A planarity outlier is detected by checking planarity of atoms in a peptide group, atoms in a mainchain group or atoms of a sidechain that are expected to be planar.

Mol	Chain	#Chirality outliers	#Planarity outliers
2	C	0	1

All (3) bond length outliers are listed below:

Mol	Chain	Res	Type	Atoms	Z	Observed(Å)	Ideal(Å)
3	D	148	LYS	CD-CE	7.41	1.69	1.51
1	B	85	CYS	CB-SG	-5.94	1.72	1.81
1	A	445	TRP	CG-CD1	-5.66	1.28	1.36

All (3) bond angle outliers are listed below:

Mol	Chain	Res	Type	Atoms	Z	Observed(°)	Ideal(°)
1	A	402	ILE	CG1-CB-CG2	-10.39	88.55	111.40
2	E	185	LEU	CA-CB-CG	6.83	131.01	115.30
1	A	223	ILE	CG1-CB-CG2	-5.39	99.53	111.40

There are no chirality outliers.

All (1) planarity outliers are listed below:

Mol	Chain	Res	Type	Group
2	C	196	TRP	Peptide

## 5.2 Too-close contacts [i](#)

In the following table, the Non-H and H(model) columns list the number of non-hydrogen atoms and hydrogen atoms in the chain respectively. The H(added) column lists the number of hydrogen atoms added and optimized by MolProbity. The Clashes column lists the number of clashes within the asymmetric unit, whereas Symm-Clashes lists symmetry-related clashes.

Mol	Chain	Non-H	H(model)	H(added)	Clashes	Symm-Clashes
1	A	3335	0	3485	185	0
1	B	3306	0	3458	198	0
2	C	1672	0	1654	80	0
2	E	1672	0	1654	61	0
3	D	1621	0	1546	99	0
3	F	1621	0	1546	105	0
4	A	2	0	0	5	0
4	B	2	0	0	7	0
All	All	13231	0	13343	677	0

The all-atom clashscore is defined as the number of clashes found per 1000 atoms (including hydrogen atoms). The all-atom clashscore for this structure is 25.

All (677) close contacts within the same asymmetric unit are listed below, sorted by their clash magnitude.

Atom-1	Atom-2	Interatomic distance (Å)	Clash overlap (Å)
1:B:402:ILE:HD13	1:B:445:TRP:CD1	1.64	1.33
1:B:402:ILE:HD13	1:B:445:TRP:NE1	1.52	1.21
1:B:445:TRP:HH2	4:B:474:BR:BR	1.81	1.18
1:A:109:ILE:HG21	1:A:445:TRP:CZ3	1.77	1.18
3:F:7:SER:HB3	3:F:8:PRO:HD3	1.16	1.15
3:F:7:SER:HB3	3:F:8:PRO:CD	1.74	1.14
1:B:445:TRP:CH2	4:B:474:BR:BR	2.62	1.07
1:B:109:ILE:HB	1:B:445:TRP:CZ3	1.89	1.06
3:F:7:SER:CB	3:F:8:PRO:HD3	1.87	1.04
3:F:2:ILE:HD11	3:F:92:SER:HB2	1.41	1.01
1:A:61:GLN:O	1:A:65:MET:HE2	1.61	1.01
1:B:402:ILE:CD1	1:B:445:TRP:CD1	2.45	0.99

*Continued on next page...*

*Continued from previous page...*

Atom-1	Atom-2	Interatomic distance (Å)	Clash overlap (Å)
3:F:194:GLU:CG	3:F:205:VAL:HG12	1.93	0.98
2:C:51:ILE:HD11	2:C:55:SER:HA	1.43	0.98
2:C:162:TRP:HZ3	2:C:218:ILE:HD11	1.27	0.97
3:F:194:GLU:HG3	3:F:205:VAL:HG12	1.46	0.97
2:C:127:PRO:HB3	2:C:153:TYR:HB3	1.47	0.95
1:A:320:ILE:HB	1:A:321:PRO:HD3	1.49	0.94
2:C:162:TRP:CZ3	2:C:218:ILE:HD11	2.02	0.94
3:F:6:GLN:NE2	3:F:100:GLY:H	1.65	0.93
3:F:82:ALA:HB2	3:F:105:ILE:HD11	1.51	0.93
1:A:453:LEU:HB3	1:B:22:ILE:HD11	1.48	0.93
1:B:381:GLN:H	1:B:381:GLN:NE2	1.65	0.92
1:B:18:ARG:O	1:B:22:ILE:HD13	1.68	0.92
1:B:402:ILE:HD12	1:B:402:ILE:O	1.70	0.91
1:B:381:GLN:HE21	1:B:381:GLN:N	1.68	0.91
1:A:381:GLN:H	1:A:381:GLN:NE2	1.68	0.91
1:A:381:GLN:HE21	1:A:381:GLN:N	1.69	0.90
1:B:18:ARG:O	1:B:22:ILE:CD1	2.19	0.90
1:B:402:ILE:HD13	1:B:445:TRP:HE1	1.36	0.90
1:B:381:GLN:H	1:B:381:GLN:HE21	0.92	0.90
1:A:109:ILE:HG21	1:A:445:TRP:CE3	2.09	0.88
1:A:38:MET:HG3	1:A:168:LEU:HD11	1.56	0.87
1:B:356:ILE:HG22	4:B:474:BR:BR	2.29	0.86
3:F:2:ILE:H	3:F:2:ILE:HD12	1.40	0.85
1:B:38:MET:HG3	1:B:168:LEU:HD11	1.60	0.84
2:C:51:ILE:HD12	2:C:52:ASN:N	1.93	0.84
1:B:402:ILE:CD1	1:B:445:TRP:NE1	2.40	0.83
3:F:6:GLN:HE21	3:F:100:GLY:H	1.26	0.83
1:A:200:ILE:HA	1:A:204:MET:HB2	1.60	0.83
3:F:95:GLN:H	3:F:95:GLN:CD	1.81	0.83
3:F:192:THR:HB	3:F:207:SER:HB3	1.61	0.82
1:A:381:GLN:H	1:A:381:GLN:HE21	0.85	0.81
2:C:40:ALA:O	2:C:43:LYS:HB2	1.81	0.81
2:E:30:SER:O	2:E:31:ARG:HB2	1.79	0.80
3:F:7:SER:HB2	3:F:22:THR:HB	1.64	0.80
1:A:150:PRO:HD3	1:A:354:GLY:HA2	1.65	0.78
2:C:158:VAL:HG12	2:C:207:HIS:HB2	1.66	0.78
1:A:119:GLN:HE21	1:A:119:GLN:HA	1.46	0.78
1:A:201:ILE:HD12	1:B:201:ILE:HD12	1.65	0.78
2:E:2:VAL:HG23	2:E:2:VAL:O	1.84	0.77
3:F:90:TRP:CG	3:F:95:GLN:HB3	2.18	0.77
1:A:42:VAL:HG22	1:A:162:VAL:HG21	1.67	0.76

*Continued on next page...*

*Continued from previous page...*

Atom-1	Atom-2	Interatomic distance (Å)	Clash overlap (Å)
1:B:109:ILE:HG13	1:B:445:TRP:CH2	2.19	0.76
1:A:98:ARG:NH2	1:A:102:PRO:HB3	2.00	0.76
1:B:98:ARG:NH2	1:B:102:PRO:HB3	2.00	0.76
3:D:6:GLN:HE22	3:D:86:TYR:HA	1.51	0.76
2:C:163:ASN:ND2	2:C:167:LEU:HD22	2.02	0.75
3:F:149:ILE:HD11	3:F:178:LEU:HD21	1.69	0.75
2:E:188:SER:HB3	3:F:134:PHE:CE2	2.22	0.75
1:A:294:MET:O	1:A:298:ILE:HD13	1.87	0.75
1:B:75:TYR:HB3	1:B:76:PRO:HD3	1.66	0.74
3:F:6:GLN:NE2	3:F:100:GLY:N	2.35	0.74
3:F:136:ASN:HD22	3:F:173:SER:HB3	1.52	0.74
1:B:200:ILE:HA	1:B:204:MET:HB2	1.69	0.74
1:B:274:LEU:HD21	1:B:448:ILE:HD13	1.69	0.74
1:B:402:ILE:CD1	1:B:445:TRP:HE1	1.99	0.74
3:F:194:GLU:HG2	3:F:205:VAL:HG12	1.69	0.74
3:D:31:TYR:HB3	3:D:49:ASP:HA	1.70	0.73
3:F:191:TYR:O	3:F:207:SER:HB2	1.88	0.73
1:B:42:VAL:HG22	1:B:162:VAL:HG21	1.69	0.73
3:F:184:GLU:HA	3:F:187:ARG:HH11	1.55	0.72
1:B:235:GLU:O	1:B:236:VAL:HG22	1.90	0.71
1:A:446:SER:OG	1:B:28:ARG:NH1	2.24	0.71
1:B:241:VAL:HG12	1:B:244:LEU:HD21	1.73	0.71
2:E:168:ALA:O	2:E:171:VAL:HG23	1.90	0.71
1:A:456:GLN:HG2	1:B:18:ARG:HH12	1.55	0.71
3:F:2:ILE:HD11	3:F:92:SER:CB	2.20	0.70
1:A:180:THR:HG22	1:A:218:VAL:HA	1.73	0.70
3:F:7:SER:HB2	3:F:22:THR:CB	2.21	0.70
3:F:186:GLU:HG2	3:F:210:ARG:HH12	1.56	0.70
1:A:112:ILE:HD11	1:A:153:GLN:HG3	1.73	0.70
1:B:91:MET:HG3	1:B:296:GLY:HA3	1.72	0.70
2:C:127:PRO:CB	2:C:153:TYR:HB3	2.21	0.70
2:C:129:VAL:HG21	2:C:214:VAL:HG11	1.73	0.70
1:A:42:VAL:O	1:A:46:VAL:HG23	1.92	0.69
1:B:402:ILE:HD12	1:B:402:ILE:C	2.12	0.69
3:D:143:ILE:HD13	3:D:144:ASN:N	2.07	0.69
1:B:109:ILE:N	1:B:110:PRO:HD2	2.07	0.69
2:C:64:LEU:HG	2:C:67:LYS:HB2	1.74	0.68
2:E:31:ARG:NH1	2:E:31:ARG:HG2	2.08	0.68
3:F:184:GLU:HA	3:F:187:ARG:NH1	2.09	0.68
3:F:4:LEU:HD23	3:F:25:ALA:HB2	1.75	0.68
3:D:125:THR:HG22	3:D:125:THR:O	1.93	0.68

*Continued on next page...*

*Continued from previous page...*

Atom-1	Atom-2	Interatomic distance (Å)	Clash overlap (Å)
3:D:192:THR:HB	3:D:207:SER:HB3	1.75	0.68
2:C:129:VAL:HG21	2:C:214:VAL:CG1	2.24	0.68
2:C:131:PRO:HD3	2:C:216:LYS:HG2	1.76	0.68
3:F:95:GLN:CD	3:F:95:GLN:N	2.47	0.68
2:E:52:ASN:HB2	2:E:53:PRO:CD	2.23	0.68
2:E:47:TRP:HZ2	2:E:50:GLU:HG2	1.59	0.68
1:A:274:LEU:HD21	1:A:448:ILE:HD12	1.73	0.68
1:A:219:PHE:O	1:A:223:ILE:HD13	1.94	0.67
1:B:110:PRO:HG3	4:B:475:BR:BR	2.49	0.67
1:A:109:ILE:CG2	1:A:445:TRP:CE3	2.76	0.67
3:D:32:ILE:HD13	3:D:50:THR:HA	1.75	0.67
3:F:116:ILE:HD13	3:F:207:SER:HA	1.74	0.67
1:B:18:ARG:O	1:B:22:ILE:HD12	1.95	0.67
3:F:194:GLU:HG3	3:F:205:VAL:CG1	2.22	0.67
1:B:402:ILE:CD1	1:B:445:TRP:HD1	2.07	0.67
1:B:444:LEU:O	1:B:448:ILE:HG12	1.94	0.67
2:C:34:MET:HB3	2:C:79:LEU:HD22	1.76	0.67
1:A:220:ILE:HG12	1:B:430:LEU:HD21	1.77	0.66
2:E:172:HIS:HE1	3:F:137:ASN:HD21	1.43	0.66
1:A:421:LEU:O	1:A:425:MET:HG3	1.95	0.66
1:A:38:MET:O	1:A:42:VAL:HG23	1.95	0.66
2:C:163:ASN:HD21	2:C:167:LEU:HD22	1.61	0.66
2:C:129:VAL:CG2	2:C:214:VAL:HG11	2.25	0.66
1:B:61:GLN:HG3	1:B:64:ARG:HH21	1.61	0.66
2:C:64:LEU:HD23	2:C:64:LEU:H	1.61	0.66
1:B:38:MET:O	1:B:42:VAL:HG23	1.96	0.66
1:B:109:ILE:CB	1:B:445:TRP:CZ3	2.75	0.66
1:B:180:THR:HG22	1:B:218:VAL:HA	1.77	0.66
1:A:219:PHE:HB3	1:B:430:LEU:HD13	1.77	0.65
1:B:176:THR:O	1:B:180:THR:HG23	1.96	0.65
1:B:234:HIS:C	1:B:235:GLU:HG2	2.17	0.65
2:C:51:ILE:HD12	2:C:52:ASN:H	1.59	0.65
3:D:192:THR:HA	3:D:207:SER:HB3	1.77	0.65
2:E:31:ARG:HG2	2:E:31:ARG:HH11	1.60	0.65
1:A:74:ASN:HB3	1:A:77:LEU:HB3	1.78	0.65
1:A:165:ILE:HG22	1:A:166:PHE:CD2	2.31	0.65
3:D:182:LYS:O	3:D:186:GLU:HG3	1.96	0.65
3:F:27:SER:O	3:F:68:THR:HG22	1.96	0.65
1:B:90:ALA:HB3	1:B:296:GLY:HA2	1.78	0.65
1:A:260:ILE:HD12	1:A:435:LEU:HG	1.77	0.65
3:D:192:THR:CB	3:D:207:SER:HB3	2.26	0.65

*Continued on next page...*

*Continued from previous page...*

Atom-1	Atom-2	Interatomic distance (Å)	Clash overlap (Å)
2:C:158:VAL:CG1	2:C:207:HIS:HB2	2.27	0.64
2:C:3:ARG:HB2	2:C:25:SER:OG	1.97	0.64
2:E:49:GLY:HA3	2:E:70:ILE:HD12	1.78	0.64
1:A:91:MET:HG3	1:A:296:GLY:HA3	1.80	0.64
1:B:243:LYS:HG2	2:E:31:ARG:HH21	1.63	0.64
3:F:82:ALA:HB2	3:F:105:ILE:CD1	2.26	0.64
3:D:107:ARG:HD2	3:D:169:ASP:O	1.98	0.64
1:B:294:MET:O	1:B:298:ILE:HD13	1.97	0.64
3:F:90:TRP:CZ2	3:F:95:GLN:NE2	2.66	0.64
3:D:189:ASN:HD21	3:D:211:ALA:H	1.44	0.63
3:F:38:LYS:O	3:F:41:THR:HG22	1.98	0.63
1:A:145:LEU:HD21	1:A:347:CYS:HB3	1.79	0.63
3:F:95:GLN:N	3:F:95:GLN:OE1	2.32	0.63
3:D:149:ILE:HD13	3:D:154:ARG:CB	2.29	0.63
2:E:107:TYR:HB3	3:F:33:HIS:CD2	2.34	0.63
1:B:107:SER:HG	1:B:445:TRP:HZ3	1.44	0.63
1:B:287:ASN:ND2	1:B:290:LYS:H	1.97	0.63
2:C:127:PRO:HB3	2:C:153:TYR:CB	2.25	0.63
3:F:16:GLY:HA2	3:F:76:THR:HG23	1.79	0.62
2:C:22:CYS:O	2:C:78:THR:HG23	1.99	0.62
2:E:136:SER:C	2:E:138:ALA:H	2.00	0.62
3:D:74:ILE:HG21	3:D:81:ASP:OD2	1.99	0.62
3:F:6:GLN:HE21	3:F:100:GLY:N	1.97	0.62
3:D:7:SER:HB3	3:D:8:PRO:CD	2.29	0.62
2:E:29:TYR:CD2	2:E:77:ASP:HA	2.34	0.62
3:D:2:ILE:HD12	3:D:92:SER:HB2	1.81	0.62
3:D:32:ILE:H	3:D:32:ILE:CD1	2.12	0.62
1:A:239:ILE:HD13	1:A:320:ILE:HG21	1.80	0.62
1:B:131:LYS:HB3	1:B:154:ILE:HD11	1.82	0.62
1:A:28:ARG:HD2	1:B:207:GLN:HG2	1.80	0.61
1:A:320:ILE:HB	1:A:321:PRO:CD	2.28	0.61
1:B:150:PRO:HD3	1:B:354:GLY:HA2	1.82	0.61
2:E:207:HIS:CE1	2:E:209:ALA:HB3	2.35	0.61
1:A:109:ILE:N	1:A:110:PRO:CD	2.64	0.61
1:A:75:TYR:HB3	1:A:76:PRO:HD3	1.83	0.61
3:D:149:ILE:HD13	3:D:154:ARG:HB3	1.82	0.61
1:A:193:PRO:HG3	1:A:226:THR:HG21	1.83	0.61
1:B:400:ALA:HB2	1:B:432:ALA:HB1	1.82	0.61
1:A:219:PHE:HB3	1:B:430:LEU:CD1	2.30	0.61
3:F:149:ILE:HD12	3:F:191:TYR:CE2	2.36	0.61
1:A:430:LEU:HD21	1:B:220:ILE:HG12	1.82	0.60

*Continued on next page...*

*Continued from previous page...*

Atom-1	Atom-2	Interatomic distance (Å)	Clash overlap (Å)
1:B:91:MET:HG2	1:B:292:VAL:O	2.01	0.60
2:C:51:ILE:HD13	2:C:57:THR:O	2.00	0.60
1:A:241:VAL:HG13	1:A:244:LEU:HD21	1.83	0.60
2:C:178:LEU:HB2	2:C:183:TYR:CE2	2.36	0.60
1:A:109:ILE:CG2	1:A:445:TRP:CZ3	2.70	0.60
2:E:172:HIS:HE1	3:F:137:ASN:ND2	1.99	0.60
1:A:445:TRP:CZ2	4:A:474:BR:BR	3.10	0.60
1:B:86:SER:HB3	1:B:299:GLY:O	2.01	0.60
1:B:241:VAL:CG1	1:B:244:LEU:HD21	2.30	0.60
2:C:60:TYR:HE2	2:C:70:ILE:HG13	1.67	0.60
3:D:14:ALA:O	3:D:17:ASP:HB2	2.00	0.60
1:A:223:ILE:HD11	1:B:426:ILE:CG2	2.31	0.60
1:B:235:GLU:C	1:B:236:VAL:HG22	2.22	0.60
1:A:281:HIS:HA	1:A:284:HIS:CE1	2.37	0.59
3:D:120:SER:HB2	3:D:122:GLU:OE1	2.01	0.59
1:A:207:GLN:HG2	1:B:28:ARG:NE	2.17	0.59
3:F:204:ILE:H	3:F:204:ILE:HD12	1.65	0.59
1:B:35:ILE:CD1	1:B:173:ALA:HB2	2.32	0.59
1:B:107:SER:HB3	4:B:475:BR:BR	2.58	0.59
1:B:248:PRO:O	1:B:251:THR:HB	2.02	0.59
1:B:47:GLY:O	1:B:51:VAL:HG23	2.03	0.59
2:C:47:TRP:CZ2	2:C:49:GLY:HA2	2.37	0.59
1:A:47:GLY:O	1:A:51:VAL:HG23	2.02	0.59
3:D:124:LEU:C	3:D:126:SER:H	2.06	0.59
3:F:143:ILE:HD13	3:F:144:ASN:N	2.17	0.59
1:B:38:MET:HG3	1:B:168:LEU:CD1	2.32	0.59
3:D:194:GLU:HG2	3:D:205:VAL:HG12	1.85	0.59
3:F:6:GLN:HG3	3:F:99:GLY:H	1.68	0.59
1:A:445:TRP:HZ2	4:A:474:BR:BR	2.41	0.58
2:C:30:SER:C	2:C:32:TYR:H	2.06	0.58
2:C:86:VAL:HG12	2:C:119:VAL:HG11	1.86	0.58
1:A:38:MET:HG3	1:A:168:LEU:CD1	2.30	0.58
1:A:274:LEU:HD21	1:A:448:ILE:CD1	2.33	0.58
2:E:167:LEU:HD23	2:E:189:VAL:HG21	1.85	0.58
1:A:86:SER:OG	1:A:303:GLY:HA3	2.04	0.58
1:B:239:ILE:HD12	1:B:320:ILE:HG21	1.85	0.58
3:F:45:ARG:HH11	3:F:45:ARG:HG2	1.70	0.57
1:A:287:ASN:ND2	1:A:290:LYS:H	2.02	0.57
1:A:430:LEU:CD1	1:B:219:PHE:HB3	2.35	0.57
1:B:356:ILE:N	4:B:474:BR:BR	2.83	0.57
3:D:7:SER:HB3	3:D:8:PRO:HD2	1.87	0.57

*Continued on next page...*



*Continued from previous page...*

Atom-1	Atom-2	Interatomic distance (Å)	Clash overlap (Å)
3:D:81:ASP:O	3:D:103:LEU:HD23	2.05	0.57
3:F:9:ALA:C	3:F:10:ILE:HD12	2.24	0.57
3:F:136:ASN:HB3	3:F:137:ASN:HD22	1.70	0.57
3:F:187:ARG:HG3	3:F:188:HIS:CD2	2.39	0.57
1:A:124:TRP:HA	1:A:157:ASN:HD22	1.69	0.57
1:B:241:VAL:HG12	1:B:244:LEU:CD2	2.35	0.57
3:D:118:PRO:HB3	3:D:208:PHE:CE1	2.40	0.57
1:B:109:ILE:N	1:B:110:PRO:CD	2.68	0.56
3:D:60:ARG:HD2	3:D:76:THR:O	2.05	0.56
3:D:149:ILE:N	3:D:149:ILE:HD12	2.20	0.56
2:C:52:ASN:ND2	2:C:57:THR:HB	2.20	0.56
3:D:192:THR:HA	3:D:207:SER:CB	2.34	0.56
3:D:32:ILE:CD1	3:D:50:THR:HA	2.36	0.56
1:B:146:GLY:HA3	1:B:148:GLU:OE2	2.05	0.56
1:B:356:ILE:O	1:B:356:ILE:HG13	2.05	0.56
3:D:19:VAL:HB	3:D:74:ILE:HD13	1.88	0.56
3:D:143:ILE:HD13	3:D:144:ASN:O	2.06	0.56
3:D:12:SER:HA	3:D:104:GLU:O	2.05	0.56
1:A:91:MET:CG	1:A:296:GLY:HA3	2.35	0.56
1:B:203:GLU:HG3	1:B:203:GLU:O	2.04	0.56
1:B:260:ILE:HD12	1:B:435:LEU:HG	1.87	0.56
1:A:457:GLU:HG3	1:B:18:ARG:HD3	1.88	0.56
3:F:7:SER:CB	3:F:22:THR:HB	2.35	0.56
1:A:28:ARG:NH2	1:B:203:GLU:OE1	2.37	0.55
1:A:400:ALA:HB2	1:A:432:ALA:HB1	1.88	0.55
3:F:15:PRO:HD3	3:F:105:ILE:CG2	2.36	0.55
1:A:176:THR:O	1:A:180:THR:HG23	2.07	0.55
1:A:260:ILE:HG23	1:A:435:LEU:HG	1.88	0.55
2:C:43:LYS:HB3	2:C:43:LYS:HZ2	1.72	0.55
2:C:51:ILE:HD13	2:C:58:ILE:CG1	2.36	0.55
3:F:149:ILE:HD11	3:F:178:LEU:CD2	2.35	0.55
2:C:26:GLY:O	2:C:27:PHE:HB3	2.05	0.55
1:B:398:LEU:HA	1:B:402:ILE:HG23	1.88	0.55
3:D:2:ILE:HD13	3:D:29:VAL:HG12	1.88	0.55
3:D:33:HIS:ND1	3:D:48:TYR:HB2	2.22	0.55
2:E:52:ASN:HB2	2:E:53:PRO:HD3	1.88	0.55
2:E:132:LEU:HB2	2:E:147:GLY:O	2.06	0.55
1:B:61:GLN:O	1:B:65:MET:HE2	2.06	0.55
2:C:162:TRP:HZ3	2:C:218:ILE:CD1	2.12	0.55
3:D:95:GLN:O	3:D:96:THR:HG23	2.06	0.55
1:A:109:ILE:HG21	1:A:445:TRP:CH2	2.39	0.55

*Continued on next page...*

*Continued from previous page...*

Atom-1	Atom-2	Interatomic distance (Å)	Clash overlap (Å)
3:D:143:ILE:HD13	3:D:144:ASN:H	1.70	0.55
1:A:422:ILE:HD11	1:B:194:LEU:HD11	1.87	0.55
1:B:243:LYS:CG	2:E:31:ARG:HH21	2.20	0.55
3:F:30:SER:HA	3:F:70:TYR:OH	2.07	0.55
1:B:111:GLU:OE2	1:B:120:ARG:NE	2.27	0.54
2:E:133:ALA:O	2:E:221:ARG:NH1	2.40	0.54
1:B:165:ILE:HG22	1:B:166:PHE:CD2	2.42	0.54
1:A:248:PRO:HB3	2:C:104:GLY:CA	2.37	0.54
1:A:320:ILE:HD12	1:A:365:THR:OG1	2.07	0.54
1:B:272:TRP:O	1:B:276:MET:HB2	2.08	0.54
1:B:124:TRP:HA	1:B:157:ASN:HD22	1.73	0.54
3:F:135:LEU:N	3:F:135:LEU:HD23	2.23	0.54
2:E:188:SER:HB3	3:F:134:PHE:CD2	2.43	0.54
3:F:204:ILE:HD12	3:F:204:ILE:N	2.23	0.54
1:B:274:LEU:HD21	1:B:448:ILE:CD1	2.38	0.54
1:A:244:LEU:HB2	1:A:418:ASN:OD1	2.06	0.54
3:D:12:SER:HB3	3:D:106:LEU:HB2	1.90	0.54
1:B:148:GLU:OE1	1:B:357:PHE:HB2	2.07	0.54
2:C:89:GLU:N	2:C:89:GLU:OE1	2.41	0.54
1:A:248:PRO:HB3	2:C:104:GLY:HA3	1.89	0.53
1:B:123:ARG:HE	1:B:126:ARG:HD2	1.73	0.53
1:B:262:PHE:CE2	1:B:367:LEU:HD23	2.43	0.53
1:A:154:ILE:O	1:A:158:ILE:HG13	2.08	0.53
1:A:430:LEU:HG	1:A:434:LEU:HD12	1.90	0.53
2:E:31:ARG:HH11	2:E:31:ARG:CG	2.21	0.53
2:E:221:ARG:NH2	3:F:118:PRO:O	2.41	0.53
1:A:35:ILE:HD13	1:A:173:ALA:HB2	1.90	0.53
1:A:42:VAL:CG2	1:A:162:VAL:HG21	2.35	0.53
1:A:98:ARG:HD2	1:A:291:TRP:CE3	2.44	0.53
3:D:95:GLN:OE1	3:D:95:GLN:N	2.32	0.53
3:D:192:THR:CA	3:D:207:SER:HB3	2.38	0.53
3:F:15:PRO:HD3	3:F:105:ILE:HG23	1.90	0.53
2:C:171:VAL:HG22	2:C:189:VAL:HG23	1.90	0.53
3:D:10:ILE:N	3:D:10:ILE:HD12	2.23	0.53
1:A:83:PHE:CD1	1:A:83:PHE:C	2.82	0.53
1:A:356:ILE:HG22	4:A:474:BR:BR	2.64	0.53
2:E:66:ASP:O	2:E:67:LYS:C	2.47	0.53
3:F:154:ARG:HE	3:F:156:ASN:HB2	1.73	0.53
1:A:253:TRP:O	1:A:257:ILE:HD13	2.09	0.53
2:C:51:ILE:CD1	2:C:55:SER:HA	2.28	0.53
1:B:42:VAL:O	1:B:46:VAL:HG23	2.09	0.53

*Continued on next page...*

*Continued from previous page...*

Atom-1	Atom-2	Interatomic distance (Å)	Clash overlap (Å)
3:D:146:LYS:HB3	3:D:194:GLU:HB2	1.90	0.53
1:B:98:ARG:HD2	1:B:291:TRP:CE3	2.44	0.53
2:C:86:VAL:HG12	2:C:119:VAL:CG1	2.39	0.53
3:D:7:SER:CB	3:D:8:PRO:CD	2.86	0.53
3:F:192:THR:HB	3:F:207:SER:CB	2.37	0.53
1:A:430:LEU:HD13	1:B:219:PHE:HB3	1.92	0.52
1:A:402:ILE:HG22	1:A:404:ALA:H	1.74	0.52
3:D:141:LYS:HD3	3:D:172:TYR:CZ	2.45	0.52
1:A:377:GLU:O	1:A:377:GLU:HG2	2.09	0.52
2:C:142:SER:O	2:C:193:SER:HB2	2.10	0.52
3:F:169:ASP:OD1	3:F:169:ASP:C	2.48	0.52
1:A:22:ILE:HD11	1:B:453:LEU:HB3	1.90	0.52
2:C:171:VAL:CG1	2:C:172:HIS:N	2.73	0.52
1:A:90:ALA:HB3	1:A:296:GLY:HA2	1.91	0.52
1:B:91:MET:CG	1:B:296:GLY:HA3	2.39	0.52
1:A:456:GLN:OE1	1:B:18:ARG:NH2	2.43	0.51
1:A:144:VAL:HG12	1:A:144:VAL:O	2.10	0.51
3:F:2:ILE:HD12	3:F:2:ILE:N	2.18	0.51
1:A:235:GLU:C	1:A:236:VAL:HG22	2.31	0.51
1:B:144:VAL:HG12	1:B:144:VAL:O	2.11	0.51
1:B:320:ILE:HB	1:B:321:PRO:HD3	1.93	0.51
1:A:160:ARG:HE	1:A:163:LEU:HD23	1.76	0.51
3:D:22:THR:HG22	3:D:23:CYS:N	2.25	0.51
1:A:109:ILE:N	1:A:110:PRO:HD2	2.26	0.51
1:A:235:GLU:O	1:A:236:VAL:HG22	2.10	0.51
1:B:305:LEU:C	1:B:307:PHE:H	2.13	0.51
1:B:454:ALA:C	1:B:456:GLN:H	2.14	0.51
1:B:281:HIS:HA	1:B:284:HIS:CE1	2.46	0.51
1:A:128:LEU:HB2	1:A:129:PRO:CD	2.40	0.51
1:B:249:LEU:C	1:B:251:THR:H	2.13	0.51
2:C:51:ILE:HD13	2:C:58:ILE:HG12	1.93	0.51
3:D:125:THR:O	3:D:125:THR:CG2	2.58	0.51
1:A:262:PHE:CE2	1:A:367:LEU:HD23	2.45	0.51
1:B:212:LEU:HD12	1:B:212:LEU:N	2.26	0.51
3:D:74:ILE:HD12	3:D:74:ILE:N	2.25	0.50
1:A:51:VAL:O	1:A:55:LYS:HG2	2.12	0.50
1:B:35:ILE:HD12	1:B:173:ALA:HB2	1.92	0.50
1:B:128:LEU:HB2	1:B:129:PRO:CD	2.41	0.50
3:D:22:THR:HG22	3:D:23:CYS:H	1.76	0.50
3:D:201:THR:O	3:D:203:PRO:HD3	2.11	0.50
1:A:91:MET:HG2	1:A:292:VAL:O	2.11	0.50

*Continued on next page...*

*Continued from previous page...*

Atom-1	Atom-2	Interatomic distance (Å)	Clash overlap (Å)
1:B:59:TRP:CE3	1:B:60:LEU:HD23	2.47	0.50
3:F:194:GLU:CG	3:F:205:VAL:CG1	2.80	0.50
1:A:86:SER:HB3	1:A:299:GLY:O	2.11	0.50
1:A:123:ARG:HE	1:A:126:ARG:HD2	1.76	0.50
3:F:143:ILE:HD13	3:F:144:ASN:H	1.76	0.50
1:A:311:ALA:HB1	1:A:336:ILE:HD13	1.93	0.50
3:D:192:THR:HG22	3:D:207:SER:CB	2.41	0.50
1:A:98:ARG:HA	1:A:98:ARG:NE	2.25	0.50
1:A:109:ILE:HD12	1:A:445:TRP:CH2	2.46	0.50
3:F:110:ALA:O	3:F:138:PHE:HA	2.12	0.50
2:C:51:ILE:HD11	2:C:55:SER:CA	2.30	0.50
3:F:4:LEU:HD22	3:F:23:CYS:SG	2.51	0.50
3:F:6:GLN:HE21	3:F:99:GLY:N	2.10	0.50
3:F:12:SER:O	3:F:13:ALA:HB2	2.12	0.50
1:A:214:SER:O	1:A:218:VAL:HG23	2.12	0.49
3:F:174:MET:HG2	3:F:175:SER:N	2.27	0.49
1:A:41:VAL:HG12	1:A:42:VAL:N	2.27	0.49
1:A:423:LEU:HB3	1:A:424:PRO:HD3	1.94	0.49
1:A:456:GLN:HG2	1:B:18:ARG:NH1	2.23	0.49
1:B:78:LEU:C	1:B:78:LEU:HD12	2.33	0.49
2:C:68:PHE:C	2:C:69:ILE:HD12	2.33	0.49
2:E:9:GLY:H	2:E:115:THR:HG21	1.75	0.49
3:F:7:SER:HB2	3:F:22:THR:H	1.76	0.49
1:A:264:ILE:C	1:A:264:ILE:HD12	2.33	0.49
1:A:320:ILE:CB	1:A:321:PRO:HD3	2.32	0.49
2:C:171:VAL:HG12	2:C:172:HIS:N	2.27	0.49
3:D:32:ILE:HD13	3:D:32:ILE:H	1.77	0.49
1:A:73:ASP:O	1:A:75:TYR:N	2.44	0.49
1:B:112:ILE:HD11	1:B:153:GLN:HG3	1.95	0.49
3:F:60:ARG:NH2	3:F:81:ASP:OD2	2.46	0.49
1:B:260:ILE:HG23	1:B:435:LEU:HG	1.93	0.49
3:D:21:MET:SD	3:D:85:TYR:HB2	2.53	0.49
3:F:2:ILE:HG21	3:F:29:VAL:CG1	2.42	0.49
1:B:59:TRP:HE3	1:B:60:LEU:HD23	1.77	0.49
1:B:241:VAL:HG12	1:B:241:VAL:O	2.11	0.49
3:D:6:GLN:HE21	3:D:98:GLY:HA3	1.78	0.49
3:F:7:SER:OG	3:F:8:PRO:HD3	2.12	0.49
1:B:202:GLU:OE1	1:B:404:ALA:HB1	2.13	0.49
1:B:145:LEU:HD21	1:B:347:CYS:HB3	1.95	0.49
1:B:420:GLN:H	1:B:420:GLN:HG3	1.37	0.49
2:E:15:GLY:O	2:E:85:LYS:HA	2.12	0.49

*Continued on next page...*

*Continued from previous page...*

Atom-1	Atom-2	Interatomic distance (Å)	Clash overlap (Å)
2:E:153:TYR:CE1	2:E:183:TYR:HB2	2.48	0.49
3:F:51:SER:HB3	3:F:63:GLY:O	2.12	0.49
1:A:212:LEU:HD12	1:A:212:LEU:H	1.77	0.48
1:B:53:PHE:CD1	1:B:136:LEU:HD12	2.48	0.48
1:B:212:LEU:HD12	1:B:212:LEU:H	1.78	0.48
3:F:65:GLY:HA3	3:F:70:TYR:HA	1.95	0.48
1:B:454:ALA:C	1:B:456:GLN:N	2.66	0.48
2:E:2:VAL:HA	2:E:26:GLY:HA3	1.95	0.48
1:A:356:ILE:HG23	1:A:360:MET:HE3	1.94	0.48
2:C:192:PRO:O	2:C:195:SER:HB3	2.13	0.48
2:C:94:TYR:O	2:C:114:GLY:HA2	2.14	0.48
2:E:49:GLY:HA3	2:E:70:ILE:CD1	2.44	0.48
1:B:109:ILE:HB	1:B:445:TRP:CE3	2.44	0.48
3:D:19:VAL:HB	3:D:74:ILE:CD1	2.44	0.48
3:D:210:ARG:HG2	3:D:210:ARG:HH11	1.79	0.48
1:A:18:ARG:HG3	1:B:119:GLN:OE1	2.13	0.48
1:A:255:TYR:CD2	1:A:424:PRO:HB3	2.48	0.48
1:A:388:THR:HG22	1:A:421:LEU:HD11	1.96	0.48
3:D:16:GLY:HA2	3:D:76:THR:HG23	1.96	0.48
3:F:83:ALA:HB3	3:F:85:TYR:CE1	2.49	0.48
2:E:32:TYR:CE2	2:E:98:ARG:HD3	2.49	0.48
1:A:146:GLY:HA3	1:A:148:GLU:OE2	2.13	0.48
1:A:216:LYS:HE2	1:B:433:THR:HG22	1.95	0.47
1:B:94:TYR:CZ	1:B:352:ALA:HB2	2.49	0.47
1:B:235:GLU:C	1:B:236:VAL:CG2	2.82	0.47
1:B:83:PHE:CD1	1:B:83:PHE:C	2.88	0.47
1:B:100:TYR:O	1:B:101:ALA:HB2	2.14	0.47
2:E:12:VAL:HG11	2:E:18:LEU:HD22	1.94	0.47
2:E:105:TYR:HD2	3:F:91:SER:HA	1.77	0.47
3:F:45:ARG:HG2	3:F:45:ARG:NH1	2.28	0.47
1:A:108:GLY:HA3	1:A:153:GLN:NE2	2.30	0.47
1:A:138:THR:HG21	1:A:352:ALA:HB1	1.96	0.47
1:A:186:LEU:HD23	1:A:196:GLY:HA2	1.96	0.47
1:A:135:GLY:C	1:A:137:GLY:N	2.67	0.47
1:A:337:PHE:O	1:A:341:VAL:HG23	2.14	0.47
1:B:253:TRP:O	1:B:257:ILE:HD13	2.13	0.47
2:C:7:SER:HA	2:C:115:THR:HG21	1.95	0.47
2:C:69:ILE:HD12	2:C:69:ILE:N	2.29	0.47
2:E:6:GLU:HA	2:E:22:CYS:HA	1.96	0.47
2:C:51:ILE:HD13	2:C:58:ILE:HG13	1.97	0.47
2:C:132:LEU:O	3:D:117:PHE:CE2	2.67	0.47

*Continued on next page...*

*Continued from previous page...*

Atom-1	Atom-2	Interatomic distance (Å)	Clash overlap (Å)
3:D:95:GLN:H	3:D:95:GLN:CD	2.17	0.47
2:E:41:PRO:O	2:E:43:LYS:HG3	2.14	0.47
1:B:110:PRO:CG	4:B:475:BR:BR	3.17	0.47
1:B:230:ARG:O	1:B:234:HIS:HB3	2.14	0.47
2:C:131:PRO:HD3	2:C:216:LYS:CG	2.44	0.47
2:C:135:GLY:HA2	2:C:221:ARG:HD3	1.96	0.47
3:F:166:ASP:OD1	3:F:167:SER:N	2.47	0.47
1:B:264:ILE:HD12	1:B:264:ILE:C	2.35	0.47
3:D:93:HIS:CG	3:D:94:PRO:HA	2.50	0.47
1:A:106:GLY:HA3	4:A:475:BR:BR	2.70	0.47
1:B:388:THR:HG22	1:B:421:LEU:HD11	1.97	0.47
2:E:104:GLY:O	2:E:106:TRP:CD1	2.68	0.47
1:B:269:PHE:O	1:B:273:VAL:HG12	2.15	0.47
2:E:51:ILE:HD12	2:E:70:ILE:O	2.14	0.47
1:B:359:PRO:O	1:B:363:LEU:HG	2.15	0.46
1:A:145:LEU:CD2	1:A:347:CYS:HB3	2.44	0.46
1:A:180:THR:HG22	1:A:218:VAL:CA	2.44	0.46
1:A:318:ASN:OD1	1:A:318:ASN:N	2.48	0.46
1:B:109:ILE:HD13	1:B:152:VAL:HG11	1.96	0.46
1:B:115:ALA:HB1	1:B:178:LEU:HD21	1.96	0.46
2:C:162:TRP:CZ3	2:C:203:CYS:HB3	2.51	0.46
3:D:117:PHE:HA	3:D:118:PRO:HD3	1.82	0.46
1:A:249:LEU:C	1:A:251:THR:H	2.19	0.46
1:A:398:LEU:O	1:A:402:ILE:HB	2.15	0.46
1:B:243:LYS:HD2	1:B:420:GLN:OE1	2.15	0.46
3:F:88:GLN:HB2	3:F:97:PHE:CD1	2.51	0.46
1:A:150:PRO:O	1:A:154:ILE:HG12	2.16	0.46
1:B:99:LYS:HG2	1:B:100:TYR:CE1	2.51	0.46
1:A:269:PHE:O	1:A:273:VAL:HG12	2.15	0.46
1:A:73:ASP:O	1:A:74:ASN:C	2.54	0.46
1:A:98:ARG:HA	1:A:98:ARG:HE	1.80	0.46
2:C:4:LEU:HD23	2:C:4:LEU:HA	1.59	0.46
3:F:46:TRP:C	3:F:47:ILE:HD12	2.36	0.46
1:A:359:PRO:O	1:A:363:LEU:HG	2.14	0.46
1:B:107:SER:OG	1:B:445:TRP:HZ3	1.98	0.46
1:B:243:LYS:HB3	2:E:31:ARG:NH2	2.31	0.46
1:B:421:LEU:O	1:B:425:MET:HG3	2.16	0.46
2:C:192:PRO:HD2	2:C:195:SER:HB2	1.97	0.46
3:F:7:SER:CB	3:F:8:PRO:CD	2.52	0.46
1:A:376:VAL:HG22	1:A:384:LEU:HB2	1.98	0.45
1:A:426:ILE:CG2	1:B:223:ILE:HD11	2.46	0.45

*Continued on next page...*

*Continued from previous page...*

Atom-1	Atom-2	Interatomic distance (Å)	Clash overlap (Å)
1:B:398:LEU:HD23	1:B:402:ILE:HG21	1.98	0.45
2:C:91:THR:HA	2:C:117:VAL:O	2.15	0.45
2:C:171:VAL:CG1	2:C:172:HIS:H	2.30	0.45
3:D:2:ILE:O	3:D:96:THR:HG21	2.16	0.45
3:D:77:MET:SD	3:D:103:LEU:HD21	2.56	0.45
2:E:51:ILE:HD13	2:E:72:ARG:HG2	1.98	0.45
1:A:252:LEU:HD11	1:A:423:LEU:HD23	1.99	0.45
1:A:402:ILE:HG22	1:A:404:ALA:N	2.31	0.45
1:B:77:LEU:O	1:B:81:VAL:HG22	2.16	0.45
3:D:192:THR:HG22	3:D:207:SER:HB2	1.98	0.45
3:F:7:SER:HB2	3:F:22:THR:N	2.31	0.45
1:A:434:LEU:HD23	1:A:438:PHE:CE2	2.52	0.45
1:B:284:HIS:O	1:B:287:ASN:HB3	2.17	0.45
2:C:163:ASN:ND2	2:C:167:LEU:CD2	2.77	0.45
3:D:32:ILE:HD12	3:D:70:TYR:CD2	2.51	0.45
3:D:82:ALA:O	3:D:83:ALA:HB2	2.16	0.45
2:E:43:LYS:HB3	2:E:43:LYS:NZ	2.32	0.45
1:B:51:VAL:O	1:B:55:LYS:HG2	2.16	0.45
1:B:113:GLU:HG3	1:B:204:MET:SD	2.57	0.45
2:C:111:TRP:N	2:C:111:TRP:CD1	2.85	0.45
3:D:49:ASP:O	3:D:51:SER:N	2.47	0.45
3:D:80:GLU:H	3:D:80:GLU:HG3	1.53	0.45
3:F:6:GLN:HE22	3:F:86:TYR:HA	1.81	0.45
1:B:311:ALA:HB3	1:B:336:ILE:CD1	2.47	0.45
3:D:89:GLN:NE2	3:D:95:GLN:HA	2.32	0.45
3:D:143:ILE:CD1	3:D:144:ASN:O	2.65	0.45
2:E:52:ASN:CB	2:E:53:PRO:CD	2.91	0.45
1:A:261:ILE:H	1:A:261:ILE:HG12	1.64	0.45
1:A:378:LEU:HB2	1:A:379:PHE:CD1	2.50	0.45
1:B:451:ARG:O	1:B:455:LYS:HB2	2.16	0.45
2:C:146:LEU:HB3	2:C:218:ILE:HD13	1.99	0.45
2:C:160:VAL:HG13	2:C:205:VAL:HG22	1.98	0.45
2:E:51:ILE:HG13	2:E:58:ILE:HG12	1.99	0.45
2:E:98:ARG:NH1	2:E:109:ASP:OD2	2.50	0.45
1:B:183:ALA:HB2	1:B:200:ILE:HD13	1.99	0.45
1:B:378:LEU:HB2	1:B:379:PHE:CD1	2.51	0.45
3:D:149:ILE:HD13	3:D:154:ARG:HB2	1.98	0.45
3:F:1:ASP:OD2	3:F:1:ASP:N	2.44	0.45
2:E:105:TYR:CD2	3:F:91:SER:HA	2.52	0.44
1:A:241:VAL:HG13	1:A:244:LEU:CD2	2.47	0.44
1:B:180:THR:HG22	1:B:218:VAL:CA	2.45	0.44

*Continued on next page...*



*Continued from previous page...*

Atom-1	Atom-2	Interatomic distance (Å)	Clash overlap (Å)
1:B:312:THR:HG22	1:B:339:ALA:CB	2.47	0.44
1:A:31:THR:H	1:B:437:GLN:NE2	2.15	0.44
1:A:457:GLU:CG	1:B:18:ARG:HD3	2.47	0.44
1:B:205:ARG:O	1:B:206:PRO:C	2.55	0.44
2:C:17:SER:HB2	2:C:83:ILE:O	2.18	0.44
3:D:124:LEU:O	3:D:126:SER:N	2.49	0.44
1:A:31:THR:H	1:B:437:GLN:HE22	1.65	0.44
1:A:212:LEU:HD12	1:A:212:LEU:N	2.33	0.44
1:B:53:PHE:O	1:B:57:VAL:HG23	2.17	0.44
3:F:188:HIS:O	3:F:210:ARG:NE	2.50	0.44
1:B:78:LEU:HA	1:B:81:VAL:CG2	2.48	0.44
3:F:134:PHE:C	3:F:135:LEU:HD23	2.38	0.44
3:F:191:TYR:O	3:F:207:SER:CB	2.62	0.44
1:B:398:LEU:HA	1:B:402:ILE:CG2	2.47	0.44
2:E:202:THR:HG23	2:E:217:LYS:HB2	1.99	0.44
1:B:337:PHE:O	1:B:341:VAL:HG23	2.18	0.44
2:E:47:TRP:CZ2	2:E:50:GLU:HG2	2.44	0.43
2:E:58:ILE:HG22	2:E:60:TYR:CE1	2.53	0.43
3:F:2:ILE:HD13	3:F:89:GLN:NE2	2.33	0.43
1:A:292:VAL:O	1:A:292:VAL:HG12	2.18	0.43
2:C:16:GLY:O	2:C:17:SER:HB3	2.18	0.43
2:C:207:HIS:CE1	2:C:209:ALA:HB3	2.53	0.43
1:A:84:LEU:O	1:A:88:VAL:HG23	2.18	0.43
1:A:298:ILE:N	1:A:298:ILE:CD1	2.81	0.43
1:A:320:ILE:HD11	1:A:362:ALA:HA	2.01	0.43
1:A:443:PRO:O	1:A:445:TRP:N	2.51	0.43
1:A:457:GLU:O	1:A:459:GLU:N	2.52	0.43
3:D:4:LEU:O	3:D:98:GLY:HA2	2.19	0.43
3:F:32:ILE:C	3:F:32:ILE:HD12	2.39	0.43
3:F:93:HIS:HA	3:F:94:PRO:C	2.37	0.43
1:A:230:ARG:NH2	1:B:423:LEU:HB2	2.33	0.43
1:B:35:ILE:H	1:B:35:ILE:HG12	1.55	0.43
1:B:62:ASN:HD22	1:B:62:ASN:HA	1.64	0.43
3:D:9:ALA:C	3:D:10:ILE:HD12	2.39	0.43
3:D:38:LYS:O	3:D:41:THR:HG22	2.18	0.43
3:D:136:ASN:HB3	3:D:137:ASN:ND2	2.33	0.43
2:E:36:TRP:HE1	2:E:79:LEU:HG	1.82	0.43
1:B:244:LEU:HB2	1:B:418:ASN:OD1	2.18	0.43
1:B:330:MET:O	1:B:334:VAL:HG23	2.18	0.43
3:F:90:TRP:CD2	3:F:95:GLN:HB3	2.52	0.43
1:B:311:ALA:HB1	1:B:336:ILE:HD12	2.01	0.43

*Continued on next page...*



*Continued from previous page...*

Atom-1	Atom-2	Interatomic distance (Å)	Clash overlap (Å)
2:E:107:TYR:CD1	3:F:45:ARG:HD2	2.53	0.43
1:A:73:ASP:OD1	1:A:73:ASP:N	2.41	0.43
1:B:108:GLY:N	1:B:110:PRO:HD2	2.33	0.43
1:B:163:LEU:HD12	1:B:168:LEU:HB2	2.01	0.43
3:D:2:ILE:CD1	3:D:92:SER:HB2	2.49	0.43
3:D:29:VAL:O	3:D:70:TYR:OH	2.32	0.43
2:E:98:ARG:O	2:E:109:ASP:HB3	2.19	0.43
1:A:183:ALA:HB2	1:A:200:ILE:HD13	1.99	0.43
1:A:445:TRP:N	1:A:445:TRP:CD1	2.86	0.43
1:B:81:VAL:O	1:B:85:CYS:SG	2.75	0.43
3:F:136:ASN:ND2	3:F:173:SER:HB3	2.26	0.43
1:A:356:ILE:O	1:A:359:PRO:HD2	2.18	0.43
2:E:109:ASP:HA	3:F:45:ARG:HD3	2.00	0.43
1:A:378:LEU:HB2	1:A:379:PHE:CE1	2.54	0.43
1:A:422:ILE:CD1	1:B:194:LEU:HD11	2.49	0.43
1:B:94:TYR:OH	1:B:352:ALA:HB2	2.19	0.43
3:F:49:ASP:HB2	3:F:52:LYS:HE3	2.01	0.43
1:B:86:SER:OG	1:B:303:GLY:HA3	2.19	0.42
2:C:150:VAL:HG11	2:C:205:VAL:HG11	2.01	0.42
2:E:216:LYS:HA	2:E:216:LYS:HD3	1.72	0.42
1:A:74:ASN:HB3	1:A:77:LEU:HD23	2.00	0.42
1:A:203:GLU:O	1:A:203:GLU:HG3	2.19	0.42
1:A:207:GLN:HG2	1:B:28:ARG:HE	1.83	0.42
1:A:231:ILE:O	1:A:231:ILE:HG22	2.19	0.42
1:A:272:TRP:O	1:A:276:MET:HB2	2.18	0.42
1:A:402:ILE:HA	1:A:402:ILE:HD12	1.82	0.42
1:B:420:GLN:HE21	1:B:420:GLN:HB2	1.58	0.42
3:D:6:GLN:NE2	3:D:87:CYS:H	2.17	0.42
2:E:99:LEU:O	2:E:100:TYR:HB2	2.19	0.42
3:F:60:ARG:HH21	3:F:61:PHE:HE1	1.67	0.42
1:A:28:ARG:HH22	1:B:203:GLU:CD	2.23	0.42
1:A:131:LYS:HB3	1:A:154:ILE:HD11	2.01	0.42
1:A:420:GLN:HE21	1:A:420:GLN:HB2	1.60	0.42
1:B:422:ILE:HG23	1:B:423:LEU:N	2.33	0.42
2:C:72:ARG:HD2	2:C:74:ASN:OD1	2.19	0.42
3:D:146:LYS:HE3	3:D:153:GLU:OE1	2.20	0.42
3:D:149:ILE:HG13	3:D:191:TYR:CD2	2.54	0.42
1:A:74:ASN:C	1:A:74:ASN:HD22	2.23	0.42
1:A:294:MET:HE2	1:A:294:MET:HB3	2.00	0.42
2:C:17:SER:HA	2:C:86:VAL:CG2	2.49	0.42
3:D:137:ASN:HB3	3:D:171:THR:HG21	2.02	0.42

*Continued on next page...*

*Continued from previous page...*

Atom-1	Atom-2	Interatomic distance (Å)	Clash overlap (Å)
3:F:50:THR:CG2	3:F:70:TYR:HD2	2.33	0.42
1:A:402:ILE:O	1:A:403:ARG:HB2	2.19	0.42
1:B:135:GLY:C	1:B:137:GLY:N	2.73	0.42
1:B:184:ALA:HB1	1:B:225:SER:HB3	2.01	0.42
2:C:192:PRO:HD2	2:C:195:SER:CB	2.50	0.42
3:D:32:ILE:CD1	3:D:32:ILE:N	2.80	0.42
3:F:149:ILE:HD12	3:F:191:TYR:CD2	2.55	0.42
1:A:109:ILE:HD12	4:A:474:BR:BR	2.75	0.42
1:A:433:THR:HG22	1:B:216:LYS:HE2	2.01	0.42
2:C:127:PRO:HB2	2:C:150:VAL:HG12	2.02	0.42
3:D:149:ILE:N	3:D:149:ILE:CD1	2.81	0.42
2:E:155:PRO:HD2	2:E:209:ALA:CB	2.50	0.42
1:B:100:TYR:O	1:B:126:ARG:NH1	2.51	0.42
3:D:61:PHE:HD2	3:D:72:LEU:HD21	1.85	0.42
3:D:137:ASN:HA	3:D:171:THR:HB	2.01	0.42
2:E:162:TRP:CZ3	2:E:203:CYS:HB3	2.55	0.42
1:B:125:TRP:CD1	1:B:126:ARG:HG3	2.54	0.42
1:B:138:THR:HG21	1:B:352:ALA:HB1	2.02	0.42
2:C:17:SER:HA	2:C:86:VAL:HG21	2.02	0.42
3:D:77:MET:HE3	3:D:78:GLU:O	2.19	0.42
2:E:130:TYR:CE2	3:F:123:GLN:HG3	2.55	0.42
2:E:172:HIS:CE1	3:F:137:ASN:HD21	2.29	0.42
2:E:197:PRO:HB3	2:E:220:PRO:HG3	2.02	0.42
1:A:241:VAL:CG1	1:A:244:LEU:CD2	2.98	0.41
2:C:156:GLU:OE1	2:C:157:PRO:HA	2.20	0.41
3:D:74:ILE:HD12	3:D:74:ILE:H	1.85	0.41
1:A:148:GLU:HG2	1:A:190:PHE:CZ	2.55	0.41
1:A:258:LEU:HD13	1:A:371:PHE:CG	2.55	0.41
3:D:61:PHE:HA	3:D:73:THR:O	2.20	0.41
3:D:157:GLY:O	3:D:178:LEU:HA	2.20	0.41
1:A:99:LYS:HG2	1:A:100:TYR:CE1	2.56	0.41
1:A:305:LEU:C	1:A:307:PHE:H	2.23	0.41
1:B:305:LEU:C	1:B:307:PHE:N	2.73	0.41
1:A:42:VAL:HG22	1:A:162:VAL:CG2	2.45	0.41
1:A:216:LYS:O	1:A:219:PHE:HB2	2.20	0.41
1:A:349:SER:C	1:A:351:GLY:H	2.24	0.41
1:B:75:TYR:HB3	1:B:76:PRO:CD	2.46	0.41
1:B:117:GLU:HA	1:B:209:ARG:HH22	1.85	0.41
2:C:127:PRO:CA	2:C:153:TYR:HB3	2.49	0.41
3:D:34:TRP:N	3:D:47:ILE:O	2.52	0.41
3:F:34:TRP:HB2	3:F:47:ILE:HB	2.01	0.41

*Continued on next page...*

*Continued from previous page...*

Atom-1	Atom-2	Interatomic distance (Å)	Clash overlap (Å)
1:B:65:MET:HE2	1:B:65:MET:HB2	2.00	0.41
1:B:98:ARG:HA	1:B:98:ARG:NE	2.35	0.41
1:B:376:VAL:HG22	1:B:384:LEU:HB2	2.02	0.41
3:D:158:VAL:HA	3:D:177:THR:O	2.21	0.41
1:A:108:GLY:N	1:A:110:PRO:HD2	2.36	0.41
1:B:78:LEU:HD12	1:B:79:LEU:N	2.36	0.41
1:B:165:ILE:O	1:B:165:ILE:CG2	2.69	0.41
1:B:219:PHE:O	1:B:223:ILE:HD12	2.21	0.41
3:D:190:SER:HB2	3:D:209:ASN:OD1	2.20	0.41
1:A:61:GLN:O	1:A:65:MET:CE	2.50	0.41
1:A:298:ILE:N	1:A:298:ILE:HD12	2.36	0.41
1:A:449:LEU:HG	1:A:453:LEU:HD22	2.02	0.41
2:C:51:ILE:CD1	2:C:57:THR:O	2.69	0.41
3:D:46:TRP:CE3	3:D:46:TRP:HA	2.56	0.41
1:A:20:GLN:O	1:A:23:ARG:HB3	2.20	0.41
2:E:172:HIS:O	2:E:187:SER:HA	2.21	0.41
2:E:178:LEU:HD13	2:E:183:TYR:CZ	2.56	0.41
1:A:154:ILE:HD13	1:A:154:ILE:HA	1.93	0.41
1:A:248:PRO:HG3	2:C:101:TYR:CE1	2.56	0.41
1:A:383:HIS:NE2	2:C:50:GLU:OE1	2.54	0.41
1:A:403:ARG:HD2	1:A:433:THR:HG23	2.02	0.41
1:B:109:ILE:CG1	1:B:445:TRP:CH2	2.98	0.41
1:B:231:ILE:O	1:B:231:ILE:HG22	2.20	0.41
2:C:153:TYR:O	2:C:183:TYR:HB2	2.21	0.41
2:C:185:LEU:HD12	2:C:185:LEU:C	2.41	0.41
3:D:117:PHE:HB2	3:D:132:VAL:HB	2.03	0.41
3:D:124:LEU:C	3:D:126:SER:N	2.72	0.41
2:E:136:SER:C	2:E:138:ALA:N	2.70	0.41
3:F:7:SER:HB2	3:F:22:THR:CA	2.51	0.41
1:A:87:ALA:O	1:A:91:MET:HG3	2.20	0.40
1:A:219:PHE:O	1:A:223:ILE:CD1	2.67	0.40
1:A:241:VAL:CG1	1:A:244:LEU:HD21	2.49	0.40
1:B:61:GLN:CG	1:B:64:ARG:HH21	2.30	0.40
1:B:108:GLY:HA3	1:B:153:GLN:NE2	2.36	0.40
3:D:36:GLN:HG3	3:D:85:TYR:CE2	2.56	0.40
3:D:165:GLN:HG2	3:D:170:SER:HA	2.02	0.40
1:B:148:GLU:CD	1:B:357:PHE:HB2	2.42	0.40
3:D:116:ILE:HD13	3:D:207:SER:HA	2.03	0.40
1:A:125:TRP:CD1	1:A:126:ARG:HG3	2.56	0.40
1:B:73:ASP:OD1	1:B:73:ASP:N	2.48	0.40
2:C:68:PHE:HB3	2:C:81:LEU:HD11	2.03	0.40

*Continued on next page...*

Continued from previous page...

Atom-1	Atom-2	Interatomic distance (Å)	Clash overlap (Å)
3:F:2:ILE:H	3:F:2:ILE:CD1	2.11	0.40
3:F:60:ARG:NH2	3:F:61:PHE:HE1	2.19	0.40
3:F:90:TRP:CE2	3:F:95:GLN:NE2	2.89	0.40
1:B:397:LEU:HD23	1:B:397:LEU:HA	1.89	0.40
1:B:90:ALA:HB2	1:B:299:GLY:HA3	2.03	0.40
1:B:422:ILE:CG2	1:B:423:LEU:N	2.85	0.40
2:C:105:TYR:CD1	3:D:31:TYR:CD1	3.09	0.40
3:D:7:SER:O	3:D:8:PRO:C	2.59	0.40
3:D:133:CYS:HB2	3:D:147:TRP:CZ2	2.56	0.40

There are no symmetry-related clashes.

## 5.3 Torsion angles [i](#)

### 5.3.1 Protein backbone [i](#)

In the following table, the Percentiles column shows the percent Ramachandran outliers of the chain as a percentile score with respect to all X-ray entries followed by that with respect to entries of similar resolution.

The Analysed column shows the number of residues for which the backbone conformation was analysed, and the total number of residues.

Mol	Chain	Analysed	Favoured	Allowed	Outliers	Percentiles	
1	A	442/473 (93%)	400 (90%)	37 (8%)	5 (1%)	14	51
1	B	439/473 (93%)	399 (91%)	38 (9%)	2 (0%)	29	67
2	C	219/221 (99%)	189 (86%)	25 (11%)	5 (2%)	6	34
2	E	219/221 (99%)	190 (87%)	23 (10%)	6 (3%)	5	30
3	D	209/211 (99%)	169 (81%)	32 (15%)	8 (4%)	3	22
3	F	209/211 (99%)	180 (86%)	22 (10%)	7 (3%)	4	25
All	All	1737/1810 (96%)	1527 (88%)	177 (10%)	33 (2%)	8	39

All (33) Ramachandran outliers are listed below:

Mol	Chain	Res	Type
1	A	236	VAL
2	C	41	PRO
2	C	141	ALA

Continued on next page...

*Continued from previous page...*

Mol	Chain	Res	Type
3	D	7	SER
3	D	50	THR
3	D	125	THR
2	E	65	LYS
2	E	138	ALA
2	E	140	ALA
3	F	7	SER
1	A	74	ASN
1	A	444	LEU
1	B	236	VAL
3	D	67	GLY
3	D	168	LYS
3	D	169	ASP
2	E	137	ALA
3	F	13	ALA
3	F	198	LYS
1	A	458	ALA
2	C	62	PRO
2	E	195	SER
3	F	50	THR
1	B	96	LEU
2	C	55	SER
2	C	197	PRO
3	D	51	SER
3	D	198	LYS
2	E	194	SER
1	A	350	SER
3	F	66	SER
3	F	126	SER
3	F	2	ILE

### 5.3.2 Protein sidechains [i](#)

In the following table, the Percentiles column shows the percent sidechain outliers of the chain as a percentile score with respect to all X-ray entries followed by that with respect to entries of similar resolution.

The Analysed column shows the number of residues for which the sidechain conformation was analysed, and the total number of residues.

Mol	Chain	Analysed	Rotameric	Outliers	Percentiles
1	A	335/358 (94%)	298 (89%)	37 (11%)	<b>6</b> <b>26</b>

*Continued on next page...*

*Continued from previous page...*

Mol	Chain	Analysed	Rotameric	Outliers	Percentiles	
1	B	332/358 (93%)	290 (87%)	42 (13%)	4	20
2	C	181/181 (100%)	154 (85%)	27 (15%)	3	14
2	E	181/181 (100%)	158 (87%)	23 (13%)	4	20
3	D	185/185 (100%)	165 (89%)	20 (11%)	6	27
3	F	185/185 (100%)	158 (85%)	27 (15%)	3	15
All	All	1399/1448 (97%)	1223 (87%)	176 (13%)	4	21

All (176) residues with a non-rotameric sidechain are listed below:

Mol	Chain	Res	Type
1	A	17	ARG
1	A	20	GLN
1	A	41	VAL
1	A	74	ASN
1	A	78	LEU
1	A	103	GLU
1	A	112	ILE
1	A	119	GLN
1	A	136	LEU
1	A	148	GLU
1	A	160	ARG
1	A	165	ILE
1	A	211	THR
1	A	212	LEU
1	A	219	PHE
1	A	230	ARG
1	A	234	HIS
1	A	236	VAL
1	A	318	ASN
1	A	319	LEU
1	A	357	PHE
1	A	381	GLN
1	A	397	LEU
1	A	402	ILE
1	A	418	ASN
1	A	420	GLN
1	A	433	THR
1	A	434	LEU
1	A	435	LEU
1	A	444	LEU

*Continued on next page...*

*Continued from previous page...*

<b>Mol</b>	<b>Chain</b>	<b>Res</b>	<b>Type</b>
1	A	448	ILE
1	A	451	ARG
1	A	453	LEU
1	A	455	LYS
1	A	456	GLN
1	A	459	GLU
1	A	460	GLN
1	B	31	THR
1	B	35	ILE
1	B	41	VAL
1	B	61	GLN
1	B	62	ASN
1	B	65	MET
1	B	68	LEU
1	B	70	HIS
1	B	74	ASN
1	B	78	LEU
1	B	81	VAL
1	B	85	CYS
1	B	103	GLU
1	B	139	LEU
1	B	148	GLU
1	B	150	PRO
1	B	160	ARG
1	B	165	ILE
1	B	168	LEU
1	B	177	LEU
1	B	197	ILE
1	B	205	ARG
1	B	211	THR
1	B	212	LEU
1	B	219	PHE
1	B	230	ARG
1	B	235	GLU
1	B	236	VAL
1	B	319	LEU
1	B	330	MET
1	B	357	PHE
1	B	381	GLN
1	B	397	LEU
1	B	402	ILE
1	B	418	ASN

*Continued on next page...*

*Continued from previous page...*

<b>Mol</b>	<b>Chain</b>	<b>Res</b>	<b>Type</b>
1	B	420	GLN
1	B	433	THR
1	B	435	LEU
1	B	444	LEU
1	B	451	ARG
1	B	453	LEU
1	B	456	GLN
2	C	30	SER
2	C	31	ARG
2	C	35	SER
2	C	51	ILE
2	C	54	VAL
2	C	64	LEU
2	C	72	ARG
2	C	100	TYR
2	C	115	THR
2	C	116	THR
2	C	118	THR
2	C	128	SER
2	C	129	VAL
2	C	142	SER
2	C	150	VAL
2	C	151	LYS
2	C	177	VAL
2	C	178	LEU
2	C	188	SER
2	C	189	VAL
2	C	193	SER
2	C	194	SER
2	C	198	SER
2	C	200	THR
2	C	204	ASN
2	C	214	VAL
2	C	219	VAL
3	D	5	THR
3	D	20	THR
3	D	28	SER
3	D	32	ILE
3	D	42	SER
3	D	46	TRP
3	D	59	VAL
3	D	68	THR

*Continued on next page...*



*Continued from previous page...*

<b>Mol</b>	<b>Chain</b>	<b>Res</b>	<b>Type</b>
3	D	74	ILE
3	D	80	GLU
3	D	133	CYS
3	D	135	LEU
3	D	137	ASN
3	D	143	ILE
3	D	152	SER
3	D	156	ASN
3	D	168	LYS
3	D	177	THR
3	D	201	THR
3	D	208	PHE
2	E	7	SER
2	E	11	LEU
2	E	12	VAL
2	E	21	SER
2	E	31	ARG
2	E	55	SER
2	E	72	ARG
2	E	96	CYS
2	E	107	TYR
2	E	115	THR
2	E	121	SER
2	E	146	LEU
2	E	151	LYS
2	E	177	VAL
2	E	185	LEU
2	E	186	SER
2	E	190	THR
2	E	193	SER
2	E	198	SER
2	E	200	THR
2	E	202	THR
2	E	212	THR
2	E	219	VAL
3	F	22	THR
3	F	68	THR
3	F	69	SER
3	F	92	SER
3	F	95	GLN
3	F	96	THR
3	F	105	ILE

*Continued on next page...*

*Continued from previous page...*

Mol	Chain	Res	Type
3	F	122	GLU
3	F	126	SER
3	F	131	VAL
3	F	135	LEU
3	F	141	LYS
3	F	142	ASP
3	F	143	ILE
3	F	152	SER
3	F	153	GLU
3	F	164	ASP
3	F	167	SER
3	F	168	LYS
3	F	170	SER
3	F	181	THR
3	F	183	ASP
3	F	185	TYR
3	F	189	ASN
3	F	190	SER
3	F	192	THR
3	F	201	THR

Sometimes sidechains can be flipped to improve hydrogen bonding and reduce clashes. All (37) such sidechains are listed below:

Mol	Chain	Res	Type
1	A	20	GLN
1	A	74	ASN
1	A	119	GLN
1	A	153	GLN
1	A	157	ASN
1	A	207	GLN
1	A	270	ASN
1	A	277	GLN
1	A	287	ASN
1	A	327	ASN
1	A	381	GLN
1	A	437	GLN
1	B	62	ASN
1	B	74	ASN
1	B	153	GLN
1	B	157	ASN
1	B	207	GLN
1	B	270	ASN

*Continued on next page...*

*Continued from previous page...*

Mol	Chain	Res	Type
1	B	277	GLN
1	B	287	ASN
1	B	327	ASN
1	B	381	GLN
1	B	437	GLN
2	C	163	ASN
3	D	6	GLN
3	D	36	GLN
3	D	136	ASN
3	D	137	ASN
3	D	189	ASN
2	E	172	HIS
2	E	179	GLN
3	F	6	GLN
3	F	36	GLN
3	F	136	ASN
3	F	137	ASN
3	F	188	HIS
3	F	189	ASN

### 5.3.3 RNA [i](#)

There are no RNA molecules in this entry.

### 5.4 Non-standard residues in protein, DNA, RNA chains [i](#)

There are no non-standard protein/DNA/RNA residues in this entry.

### 5.5 Carbohydrates [i](#)

There are no monosaccharides in this entry.

### 5.6 Ligand geometry [i](#)

Of 4 ligands modelled in this entry, 4 are monoatomic - leaving 0 for Mogul analysis.

There are no bond length outliers.

There are no bond angle outliers.

There are no chirality outliers.

There are no torsion outliers.

There are no ring outliers.

No monomer is involved in short contacts.

## 5.7 Other polymers [i](#)

There are no such residues in this entry.

## 5.8 Polymer linkage issues [i](#)

There are no chain breaks in this entry.

## 6 Fit of model and data

### 6.1 Protein, DNA and RNA chains

In the following table, the column labelled ‘#RSRZ > 2’ contains the number (and percentage) of RSRZ outliers, followed by percent RSRZ outliers for the chain as percentile scores relative to all X-ray entries and entries of similar resolution. The OWAB column contains the minimum, median, 95<sup>th</sup> percentile and maximum values of the occupancy-weighted average B-factor per residue. The column labelled ‘Q < 0.9’ lists the number of (and percentage) of residues with an average occupancy less than 0.9.

Mol	Chain	Analysed	<RSRZ>	#RSRZ>2	OWAB(Å <sup>2</sup> )	Q<0.9
1	A	444/473 (93%)	-0.51	2 (0%) 91 86	41, 79, 124, 162	0
1	B	441/473 (93%)	-0.45	5 (1%) 80 69	36, 79, 124, 173	0
2	C	221/221 (100%)	-0.28	5 (2%) 60 47	37, 75, 127, 168	0
2	E	221/221 (100%)	-0.32	1 (0%) 91 86	29, 77, 122, 172	0
3	D	211/211 (100%)	-0.24	1 (0%) 91 86	50, 88, 118, 141	0
3	F	211/211 (100%)	-0.32	1 (0%) 91 86	32, 73, 121, 155	0
All	All	1749/1810 (96%)	-0.39	15 (0%) 84 75	29, 79, 124, 173	0

All (15) RSRZ outliers are listed below:

Mol	Chain	Res	Type	RSRZ
1	B	73	ASP	5.5
2	C	139	ALA	4.0
2	C	137	ALA	3.9
1	A	72	ALA	3.2
1	A	235	GLU	3.1
1	B	72	ALA	2.9
2	C	136	SER	2.8
2	C	138	ALA	2.8
3	F	153	GLU	2.6
1	B	74	ASN	2.5
1	B	169	LYS	2.4
3	D	87	CYS	2.2
2	C	147	GLY	2.1
1	B	70	HIS	2.1
2	E	13	GLN	2.0

## 6.2 Non-standard residues in protein, DNA, RNA chains [i](#)

There are no non-standard protein/DNA/RNA residues in this entry.

## 6.3 Carbohydrates [i](#)

There are no monosaccharides in this entry.

## 6.4 Ligands [i](#)

In the following table, the Atoms column lists the number of modelled atoms in the group and the number defined in the chemical component dictionary. The B-factors column lists the minimum, median, 95<sup>th</sup> percentile and maximum values of B factors of atoms in the group. The column labelled 'Q< 0.9' lists the number of atoms with occupancy less than 0.9.

Mol	Type	Chain	Res	Atoms	RSCC	RSR	B-factors(Å <sup>2</sup> )	Q<0.9
4	BR	B	474	1/1	0.93	0.28	51,51,51,51	0
4	BR	A	474	1/1	0.94	0.24	51,51,51,51	0
4	BR	A	475	1/1	0.98	0.38	51,51,51,51	0
4	BR	B	475	1/1	0.98	0.32	51,51,51,51	0

## 6.5 Other polymers [i](#)

There are no such residues in this entry.