



# Full wwPDB X-ray Structure Validation Report ⓘ

Nov 1, 2023 – 12:29 PM JST

PDB ID : 5HC8  
Title : Crystal structure of lavandulyl diphosphate synthase from *Lavandula x* intermedia in complex with dimethylallyl diphosphate  
Authors : Liu, M.X.; Liu, W.D.; Gao, J.; Zheng, Y.Y.; Chen, C.C.; Guo, R.T.  
Deposited on : 2016-01-04  
Resolution : 1.87 Å (reported)

This is a Full wwPDB X-ray Structure Validation Report for a publicly released PDB entry.

We welcome your comments at [validation@mail.wwpdb.org](mailto:validation@mail.wwpdb.org)

A user guide is available at

<https://www.wwpdb.org/validation/2017/XrayValidationReportHelp>

with specific help available everywhere you see the ⓘ symbol.

The types of validation reports are described at

<http://www.wwpdb.org/validation/2017/FAQs#types>.

---

The following versions of software and data (see [references ⓘ](#)) were used in the production of this report:

MolProbity : 4.02b-467  
Mogul : 1.8.5 (274361), CSD as541be (2020)  
Xtriage (Phenix) : 1.13  
EDS : 2.36  
buster-report : 1.1.7 (2018)  
Percentile statistics : 20191225.v01 (using entries in the PDB archive December 25th 2019)  
Refmac : 5.8.0158  
CCP4 : 7.0.044 (Gargrove)  
Ideal geometry (proteins) : Engh & Huber (2001)  
Ideal geometry (DNA, RNA) : Parkinson et al. (1996)  
Validation Pipeline (wwPDB-VP) : 2.36

# 1 Overall quality at a glance

The following experimental techniques were used to determine the structure:

*X-RAY DIFFRACTION*

The reported resolution of this entry is 1.87 Å.

Percentile scores (ranging between 0-100) for global validation metrics of the entry are shown in the following graphic. The table shows the number of entries on which the scores are based.

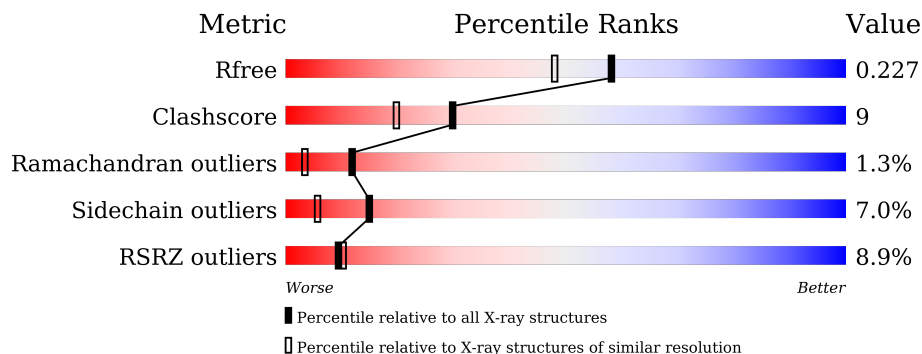

Metric	Whole archive (#Entries)	Similar resolution (#Entries, resolution range(Å))
$R_{free}$	130704	9470 (1.90-1.86)
Clashscore	141614	10282 (1.90-1.86)
Ramachandran outliers	138981	10152 (1.90-1.86)
Sidechain outliers	138945	10152 (1.90-1.86)
RSRZ outliers	127900	9303 (1.90-1.86)

The table below summarises the geometric issues observed across the polymeric chains and their fit to the electron density. The red, orange, yellow and green segments of the lower bar indicate the fraction of residues that contain outliers for  $\geq 3$ , 2, 1 and 0 types of geometric quality criteria respectively. A grey segment represents the fraction of residues that are not modelled. The numeric value for each fraction is indicated below the corresponding segment, with a dot representing fractions  $\leq 5\%$ . The upper red bar (where present) indicates the fraction of residues that have poor fit to the electron density. The numeric value is given above the bar.

Mol	Chain	Length	Quality of chain
1	A	261	

The following table lists non-polymeric compounds, carbohydrate monomers and non-standard residues in protein, DNA, RNA chains that are outliers for geometric or electron-density-fit criteria:

Mol	Type	Chain	Res	Chirality	Geometry	Clashes	Electron density
4	61G	A	403	-	-	X	-
5	SO4	A	404	-	-	X	-

## 2 Entry composition [i](#)

There are 7 unique types of molecules in this entry. The entry contains 2074 atoms, of which 0 are hydrogens and 0 are deuteriums.

In the tables below, the ZeroOcc column contains the number of atoms modelled with zero occupancy, the AltConf column contains the number of residues with at least one atom in alternate conformation and the Trace column contains the number of residues modelled with at most 2 atoms.

- Molecule 1 is a protein called prenyltransferase for protein.

Mol	Chain	Residues	Atoms					ZeroOcc	AltConf	Trace
			Total	C	N	O	S			
1	A	236	1904	1217	331	351	5	0	0	0

- Molecule 2 is MAGNESIUM ION (three-letter code: MG) (formula: Mg).

Mol	Chain	Residues	Atoms		ZeroOcc	AltConf
			Total	Mg		
2	A	1	1	1	0	0

- Molecule 3 is TRIHYDROGEN THIODIPHOSPHATE (three-letter code: PIS) (formula: H<sub>3</sub>O<sub>6</sub>P<sub>2</sub>S).

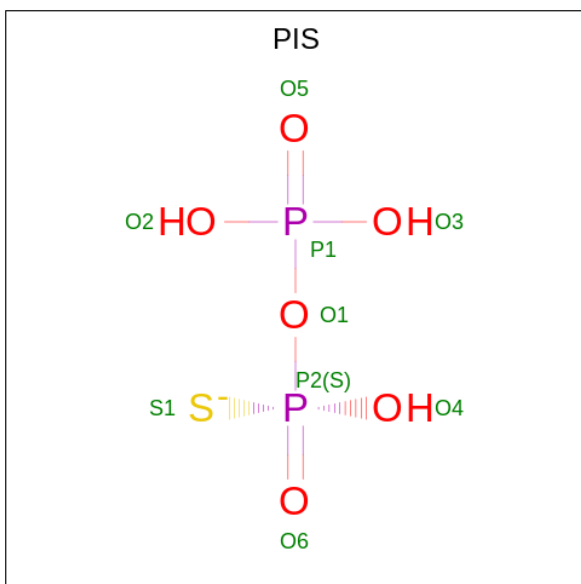

Mol	Chain	Residues	Atoms				ZeroOcc	AltConf
			Total	O	P	S		
3	A	1	9	6	2	1	0	0

- Molecule 4 is 2-methylbuta-1,3-diene (three-letter code: 61G) (formula: C<sub>5</sub>H<sub>8</sub>).

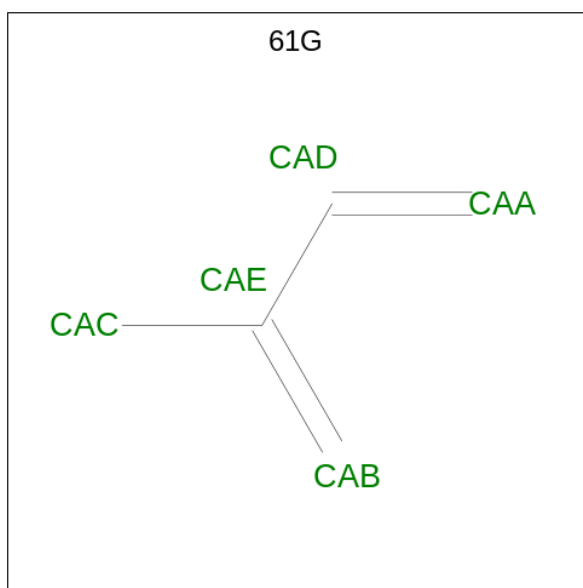

Mol	Chain	Residues	Atoms	ZeroOcc	AltConf
4	A	1	Total C 5 5	0	0

- Molecule 5 is SULFATE ION (three-letter code: SO4) (formula: O<sub>4</sub>S).

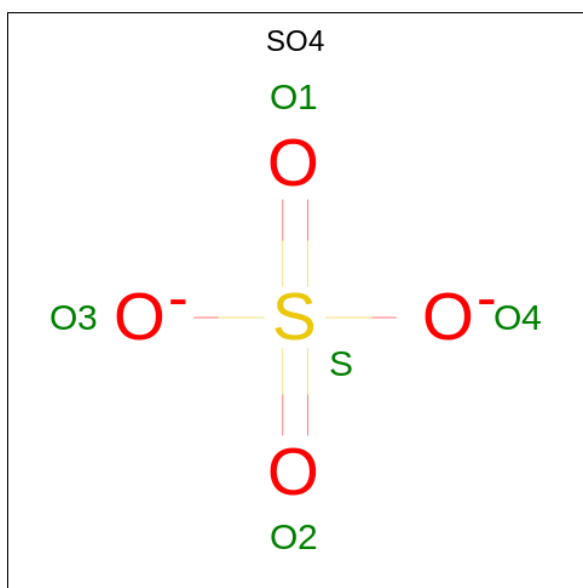

Mol	Chain	Residues	Atoms	ZeroOcc	AltConf
5	A	1	Total O S 5 4 1	0	0

- Molecule 6 is 3-methylbut-3-enylsulfanyl(phosphonoxy)phosphinic acid (three-letter code:

ISY) (formula: C<sub>5</sub>H<sub>12</sub>O<sub>6</sub>P<sub>2</sub>S).

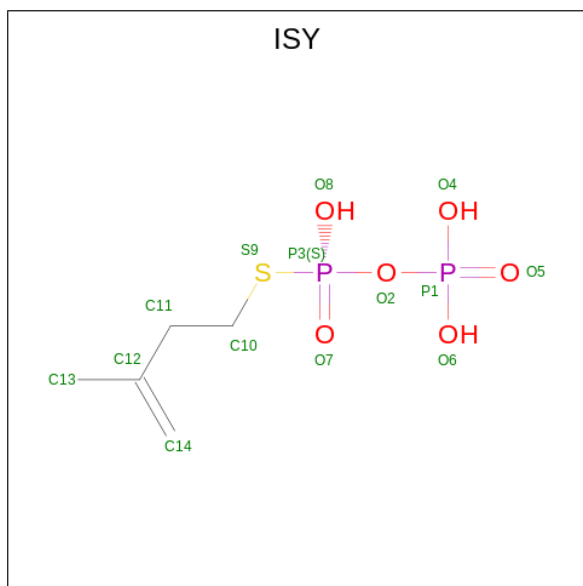

Mol	Chain	Residues	Atoms					ZeroOcc	AltConf
			Total	C	O	P	S		
6	A	1	14	5	6	2	1	0	0

- Molecule 7 is water.

Mol	Chain	Residues	Atoms		ZeroOcc	AltConf
			Total	O		
7	A	136	136	136	0	0

### 3 Residue-property plots [i](#)

These plots are drawn for all protein, RNA, DNA and oligosaccharide chains in the entry. The first graphic for a chain summarises the proportions of the various outlier classes displayed in the second graphic. The second graphic shows the sequence view annotated by issues in geometry and electron density. Residues are color-coded according to the number of geometric quality criteria for which they contain at least one outlier: green = 0, yellow = 1, orange = 2 and red = 3 or more. A red dot above a residue indicates a poor fit to the electron density ( $RSRZ > 2$ ). Stretches of 2 or more consecutive residues without any outlier are shown as a green connector. Residues present in the sample, but not in the model, are shown in grey.

- Molecule 1: prenyltransferase for protein

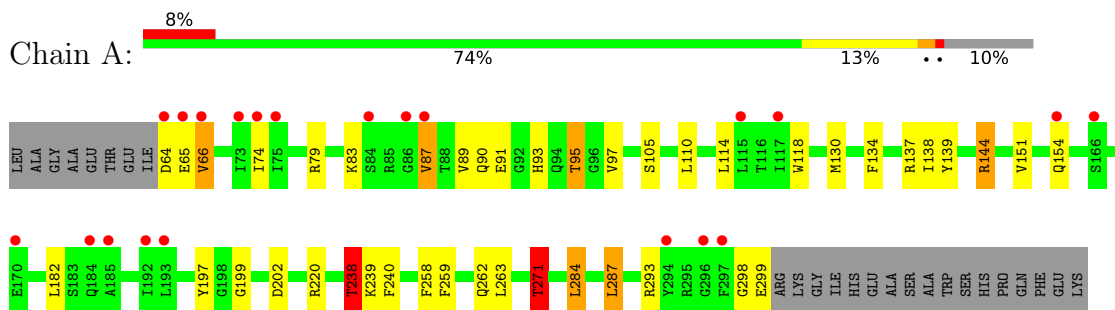

## 4 Data and refinement statistics

Property	Value	Source
Space group	C 2 2 21	Depositor
Cell constants a, b, c, $\alpha$ , $\beta$ , $\gamma$	54.21Å 140.24Å 78.70Å 90.00° 90.00° 90.00°	Depositor
Resolution (Å)	25.00 – 1.87 26.32 – 1.87	Depositor EDS
% Data completeness (in resolution range)	99.2 (25.00-1.87) 99.2 (26.32-1.87)	Depositor EDS
$R_{merge}$	0.04	Depositor
$R_{sym}$	(Not available)	Depositor
$\langle I/\sigma(I) \rangle$ <sup>1</sup>	2.42 (at 1.87Å)	Xtrriage
Refinement program	REFMAC 5.8.0073	Depositor
R, $R_{free}$	0.171 , 0.214 0.183 , 0.227	Depositor DCC
$R_{free}$ test set	1277 reflections (5.10%)	wwPDB-VP
Wilson B-factor (Å <sup>2</sup> )	28.7	Xtrriage
Anisotropy	0.639	Xtrriage
Bulk solvent $k_{sol}$ (e/Å <sup>3</sup> ), $B_{sol}$ (Å <sup>2</sup> )	0.39 , 52.2	EDS
L-test for twinning <sup>2</sup>	$\langle  L  \rangle = 0.49$ , $\langle L^2 \rangle = 0.32$	Xtrriage
Estimated twinning fraction	No twinning to report.	Xtrriage
$F_o, F_c$ correlation	0.97	EDS
Total number of atoms	2074	wwPDB-VP
Average B, all atoms (Å <sup>2</sup> )	38.0	wwPDB-VP

Xtrriage's analysis on translational NCS is as follows: *The largest off-origin peak in the Patterson function is 5.88% of the height of the origin peak. No significant pseudotranslation is detected.*

<sup>1</sup>Intensities estimated from amplitudes.

<sup>2</sup>Theoretical values of  $\langle |L| \rangle$ ,  $\langle L^2 \rangle$  for acentric reflections are 0.5, 0.333 respectively for untwinned datasets, and 0.375, 0.2 for perfectly twinned datasets.

## 5 Model quality [i](#)

### 5.1 Standard geometry [i](#)

Bond lengths and bond angles in the following residue types are not validated in this section: ISY, 61G, MG, SO4, PIS

The Z score for a bond length (or angle) is the number of standard deviations the observed value is removed from the expected value. A bond length (or angle) with  $|Z| > 5$  is considered an outlier worth inspection. RMSZ is the root-mean-square of all Z scores of the bond lengths (or angles).

Mol	Chain	Bond lengths		Bond angles	
		RMSZ	# $ Z  > 5$	RMSZ	# $ Z  > 5$
1	A	0.93	2/1949 (0.1%)	1.02	6/2635 (0.2%)

All (2) bond length outliers are listed below:

Mol	Chain	Res	Type	Atoms	Z	Observed(Å)	Ideal(Å)
1	A	298	GLY	N-CA	5.87	1.54	1.46
1	A	105	SER	CB-OG	-5.06	1.35	1.42

All (6) bond angle outliers are listed below:

Mol	Chain	Res	Type	Atoms	Z	Observed( $^{\circ}$ )	Ideal( $^{\circ}$ )
1	A	271	THR	CB-CA-C	-7.89	90.30	111.60
1	A	238	THR	CB-CA-C	-7.65	90.95	111.60
1	A	293	ARG	NE-CZ-NH1	7.12	123.86	120.30
1	A	284	LEU	CB-CG-CD1	6.52	122.09	111.00
1	A	293	ARG	NE-CZ-NH2	-5.63	117.48	120.30
1	A	202	ASP	CB-CG-OD2	-5.58	113.28	118.30

There are no chirality outliers.

There are no planarity outliers.

### 5.2 Too-close contacts [i](#)

In the following table, the Non-H and H(model) columns list the number of non-hydrogen atoms and hydrogen atoms in the chain respectively. The H(added) column lists the number of hydrogen atoms added and optimized by MolProbity. The Clashes column lists the number of clashes within the asymmetric unit, whereas Symm-Clashes lists symmetry-related clashes.



Mol	Chain	Non-H	H(model)	H(added)	Clashes	Symm-Clashes
1	A	1904	0	1869	32	0
2	A	1	0	0	0	0
3	A	9	0	0	3	0
4	A	5	0	0	5	0
5	A	5	0	0	2	0
6	A	14	0	9	1	0
7	A	136	0	0	7	1
All	All	2074	0	1878	36	1

The all-atom clashscore is defined as the number of clashes found per 1000 atoms (including hydrogen atoms). The all-atom clashscore for this structure is 9.

All (36) close contacts within the same asymmetric unit are listed below, sorted by their clash magnitude.

Atom-1	Atom-2	Interatomic distance (Å)	Clash overlap (Å)
3:A:402:PIS:P2	4:A:403:61G:CAA	2.63	0.86
1:A:134:PHE:CE2	1:A:138:ILE:HD11	2.14	0.83
1:A:91:GLU:O	1:A:95:THR:HG23	1.78	0.81
3:A:402:PIS:O6	4:A:403:61G:CAA	2.38	0.72
1:A:299:GLU:C	7:A:559:HOH:O	2.30	0.70
4:A:403:61G:CAA	7:A:562:HOH:O	2.40	0.69
1:A:91:GLU:O	1:A:95:THR:CG2	2.43	0.67
1:A:271:THR:HG23	7:A:621:HOH:O	1.95	0.65
3:A:402:PIS:S1	4:A:403:61G:CAA	2.86	0.64
1:A:238:THR:HG23	5:A:404:SO4:O1	1.98	0.64
1:A:271:THR:CG2	7:A:621:HOH:O	2.46	0.63
1:A:144:ARG:HD3	7:A:619:HOH:O	1.97	0.62
1:A:64:ASP:O	1:A:66:VAL:N	2.31	0.62
1:A:144:ARG:NH2	7:A:504:HOH:O	2.35	0.58
1:A:114:LEU:HD22	1:A:238:THR:HG21	1.86	0.58
1:A:87:VAL:CG2	1:A:91:GLU:OE1	2.55	0.55
1:A:139:TYR:OH	4:A:403:61G:CAB	2.57	0.53
1:A:238:THR:HG22	1:A:240:PHE:H	1.73	0.52
1:A:74:ILE:HG23	6:A:405:ISY:H11	1.94	0.50
1:A:87:VAL:HG22	1:A:91:GLU:OE1	2.12	0.49
1:A:64:ASP:O	1:A:64:ASP:CG	2.51	0.49
1:A:154:GLN:OE1	7:A:502:HOH:O	2.20	0.47
1:A:259:PHE:HB3	1:A:262:GLN:HB2	1.95	0.47
1:A:110:LEU:HD13	1:A:287:LEU:HD23	1.97	0.47
1:A:134:PHE:HE2	1:A:138:ILE:HD11	1.72	0.47
1:A:238:THR:CG2	1:A:240:PHE:H	2.27	0.47
1:A:238:THR:CG2	5:A:404:SO4:O1	2.62	0.45

*Continued on next page...*

Continued from previous page...

Atom-1	Atom-2	Interatomic distance (Å)	Clash overlap (Å)
1:A:151:VAL:CG2	1:A:182:LEU:HD23	2.47	0.44
1:A:87:VAL:HG21	1:A:91:GLU:OE1	2.17	0.43
1:A:110:LEU:HD13	1:A:287:LEU:CD2	2.49	0.43
1:A:90:GLN:HG3	1:A:134:PHE:CD2	2.54	0.42
1:A:93:HIS:O	1:A:97:VAL:HG23	2.20	0.41
1:A:134:PHE:CE2	1:A:138:ILE:CD1	2.96	0.41
1:A:199:GLY:HA3	1:A:258:PHE:O	2.21	0.40
1:A:197:TYR:CD2	1:A:197:TYR:C	2.95	0.40
1:A:118:TRP:CZ3	1:A:258:PHE:HB2	2.56	0.40

All (1) symmetry-related close contacts are listed below. The label for Atom-2 includes the symmetry operator and encoded unit-cell translations to be applied.

Atom-1	Atom-2	Interatomic distance (Å)	Clash overlap (Å)
7:A:637:HOH:O	7:A:637:HOH:O[3_554]	2.16	0.04

## 5.3 Torsion angles [i](#)

### 5.3.1 Protein backbone [i](#)

In the following table, the Percentiles column shows the percent Ramachandran outliers of the chain as a percentile score with respect to all X-ray entries followed by that with respect to entries of similar resolution.

The Analysed column shows the number of residues for which the backbone conformation was analysed, and the total number of residues.

Mol	Chain	Analysed	Favoured	Allowed	Outliers	Percentiles
1	A	234/261 (90%)	225 (96%)	6 (3%)	3 (1%)	<b>12</b>   <b>3</b>

All (3) Ramachandran outliers are listed below:

Mol	Chain	Res	Type
1	A	65	GLU
1	A	263	LEU
1	A	66	VAL

### 5.3.2 Protein sidechains [i](#)

In the following table, the Percentiles column shows the percent sidechain outliers of the chain as a percentile score with respect to all X-ray entries followed by that with respect to entries of similar resolution.

The Analysed column shows the number of residues for which the sidechain conformation was analysed, and the total number of residues.

Mol	Chain	Analysed	Rotameric	Outliers	Percentiles
1	A	201/220 (91%)	187 (93%)	14 (7%)	15 6

All (14) residues with a non-rotameric sidechain are listed below:

Mol	Chain	Res	Type
1	A	79	ARG
1	A	83	LYS
1	A	87	VAL
1	A	89	VAL
1	A	95	THR
1	A	130	MET
1	A	137	ARG
1	A	144	ARG
1	A	220	ARG
1	A	238	THR
1	A	239	LYS
1	A	271	THR
1	A	284	LEU
1	A	287	LEU

Sometimes sidechains can be flipped to improve hydrogen bonding and reduce clashes. All (2) such sidechains are listed below:

Mol	Chain	Res	Type
1	A	90	GLN
1	A	99	ASN

### 5.3.3 RNA [i](#)

There are no RNA molecules in this entry.

## 5.4 Non-standard residues in protein, DNA, RNA chains [i](#)

There are no non-standard protein/DNA/RNA residues in this entry.

## 5.5 Carbohydrates [i](#)

There are no monosaccharides in this entry.

## 5.6 Ligand geometry [i](#)

Of 5 ligands modelled in this entry, 1 is monoatomic - leaving 4 for Mogul analysis.

In the following table, the Counts columns list the number of bonds (or angles) for which Mogul statistics could be retrieved, the number of bonds (or angles) that are observed in the model and the number of bonds (or angles) that are defined in the Chemical Component Dictionary. The Link column lists molecule types, if any, to which the group is linked. The Z score for a bond length (or angle) is the number of standard deviations the observed value is removed from the expected value. A bond length (or angle) with  $|Z| > 2$  is considered an outlier worth inspection. RMSZ is the root-mean-square of all Z scores of the bond lengths (or angles).

Mol	Type	Chain	Res	Link	Bond lengths			Bond angles		
					Counts	RMSZ	# $ Z  > 2$	Counts	RMSZ	# $ Z  > 2$
4	61G	A	403	-	3,4,4	4.23	2 (66%)	4,4,4	4.27	1 (25%)
5	SO4	A	404	-	4,4,4	0.93	0	6,6,6	0.78	0
3	PIS	A	402	2	4,8,8	1.74	1 (25%)	8,13,13	1.76	2 (25%)
6	ISY	A	405	2	9,13,13	2.09	1 (11%)	11,19,19	1.88	2 (18%)

In the following table, the Chirals column lists the number of chiral outliers, the number of chiral centers analysed, the number of these observed in the model and the number defined in the Chemical Component Dictionary. Similar counts are reported in the Torsion and Rings columns. '-' means no outliers of that kind were identified.

Mol	Type	Chain	Res	Link	Chirals	Torsions	Rings
4	61G	A	403	-	-	0/2/2/2	-
3	PIS	A	402	2	-	3/4/6/6	-
6	ISY	A	405	2	-	1/9/13/13	-

All (4) bond length outliers are listed below:

Mol	Chain	Res	Type	Atoms	Z	Observed(Å)	Ideal(Å)
4	A	403	61G	CAB-CAE	6.88	1.51	1.33
6	A	405	ISY	C14-C12	5.54	1.48	1.33
3	A	402	PIS	P2-O4	-2.89	1.49	1.56
4	A	403	61G	CAA-CAD	2.46	1.42	1.30

All (5) bond angle outliers are listed below:

Mol	Chain	Res	Type	Atoms	Z	Observed(°)	Ideal(°)
4	A	403	61G	CAA-CAD-CAE	-8.16	113.30	126.58
6	A	405	ISY	C11-C10-S9	-4.52	101.33	112.16
3	A	402	PIS	O4-P2-O6	3.42	117.23	109.91
6	A	405	ISY	O8-P3-O7	3.23	117.64	109.82
3	A	402	PIS	O2-P1-O1	2.62	113.42	104.64

There are no chirality outliers.

All (4) torsion outliers are listed below:

Mol	Chain	Res	Type	Atoms
3	A	402	PIS	P2-O1-P1-O2
6	A	405	ISY	S9-C10-C11-C12
3	A	402	PIS	P2-O1-P1-O5
3	A	402	PIS	P2-O1-P1-O3

There are no ring outliers.

4 monomers are involved in 8 short contacts:

Mol	Chain	Res	Type	Clashes	Symm-Clashes
4	A	403	61G	5	0
5	A	404	SO4	2	0
3	A	402	PIS	3	0
6	A	405	ISY	1	0

The following is a two-dimensional graphical depiction of Mogul quality analysis of bond lengths, bond angles, torsion angles, and ring geometry for all instances of the Ligand of Interest. In addition, ligands with molecular weight > 250 and outliers as shown on the validation Tables will also be included. For torsion angles, if less than 5% of the Mogul distribution of torsion angles is within 10 degrees of the torsion angle in question, then that torsion angle is considered an outlier. Any bond that is central to one or more torsion angles identified as an outlier by Mogul will be highlighted in the graph. For rings, the root-mean-square deviation (RMSD) between the ring in question and similar rings identified by Mogul is calculated over all ring torsion angles. If the average RMSD is greater than 60 degrees and the minimal RMSD between the ring in question and any Mogul-identified rings is also greater than 60 degrees, then that ring is considered an outlier. The outliers are highlighted in purple. The color gray indicates Mogul did not find sufficient equivalents in the CSD to analyse the geometry.

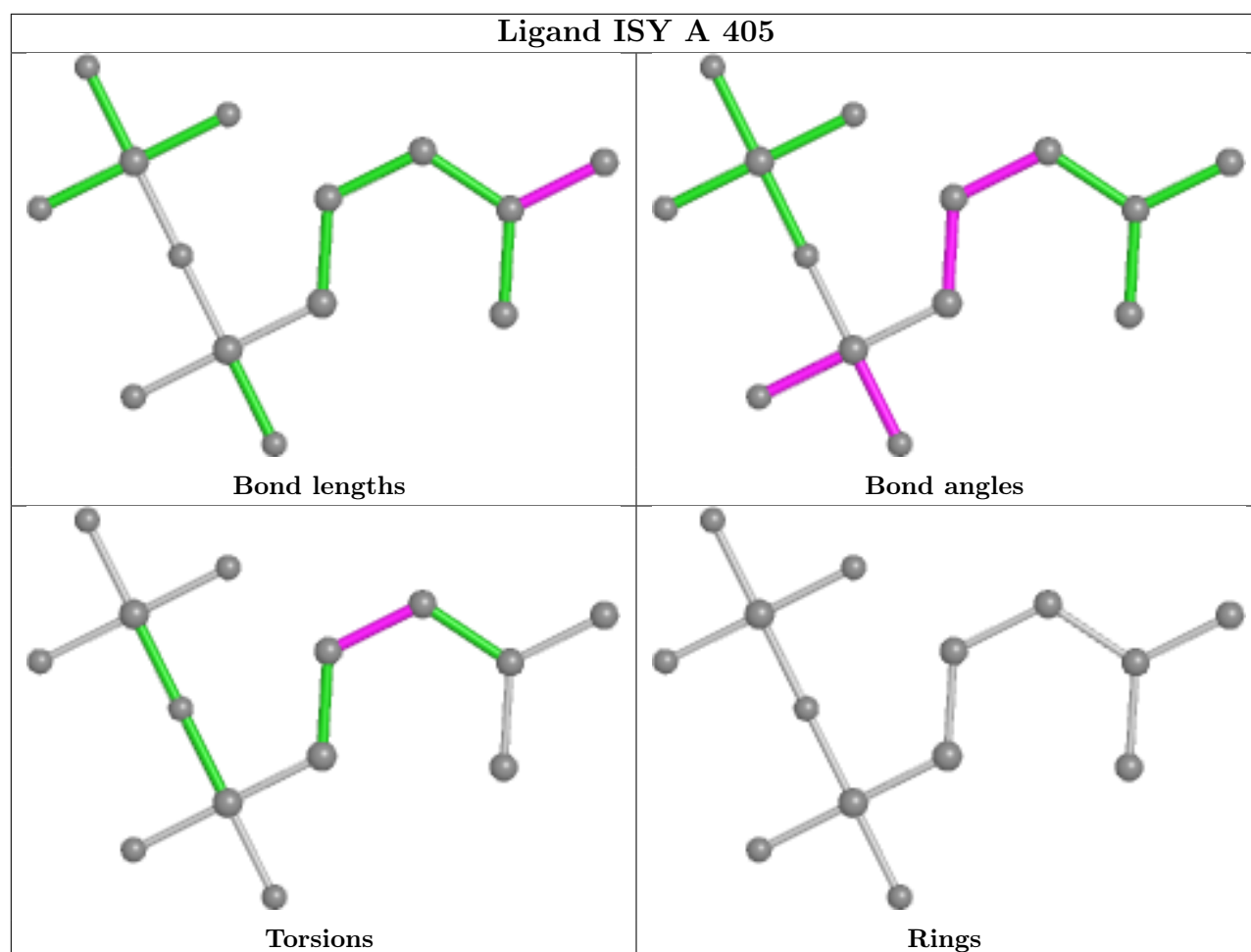

## 5.7 Other polymers [i](#)

There are no such residues in this entry.

## 5.8 Polymer linkage issues [i](#)

There are no chain breaks in this entry.

## 6 Fit of model and data [i](#)

### 6.1 Protein, DNA and RNA chains [i](#)

In the following table, the column labelled ‘#RSRZ> 2’ contains the number (and percentage) of RSRZ outliers, followed by percent RSRZ outliers for the chain as percentile scores relative to all X-ray entries and entries of similar resolution. The OWAB column contains the minimum, median, 95<sup>th</sup> percentile and maximum values of the occupancy-weighted average B-factor per residue. The column labelled ‘Q< 0.9’ lists the number of (and percentage) of residues with an average occupancy less than 0.9.

Mol	Chain	Analysed	<RSRZ>	#RSRZ>2	OWAB(Å <sup>2</sup> )	Q<0.9
1	A	236/261 (90%)	0.28	21 (8%) <b>9</b> <b>10</b>	21, 35, 62, 101	0

All (21) RSRZ outliers are listed below:

Mol	Chain	Res	Type	RSRZ
1	A	64	ASP	6.5
1	A	65	GLU	6.5
1	A	294	TYR	4.4
1	A	117	ILE	3.8
1	A	185	ALA	3.7
1	A	73	ILE	3.6
1	A	154	GLN	3.2
1	A	86	GLY	3.2
1	A	296	GLY	3.1
1	A	297	PHE	3.1
1	A	170	GLU	2.8
1	A	115	LEU	2.7
1	A	184	GLN	2.7
1	A	66	VAL	2.7
1	A	75	ILE	2.4
1	A	166	SER	2.4
1	A	74	ILE	2.4
1	A	84	SER	2.3
1	A	193	LEU	2.3
1	A	192	ILE	2.3
1	A	87	VAL	2.2

### 6.2 Non-standard residues in protein, DNA, RNA chains [i](#)

There are no non-standard protein/DNA/RNA residues in this entry.

### 6.3 Carbohydrates [i](#)

There are no monosaccharides in this entry.

### 6.4 Ligands [i](#)

In the following table, the Atoms column lists the number of modelled atoms in the group and the number defined in the chemical component dictionary. The B-factors column lists the minimum, median, 95<sup>th</sup> percentile and maximum values of B factors of atoms in the group. The column labelled 'Q< 0.9' lists the number of atoms with occupancy less than 0.9.

Mol	Type	Chain	Res	Atoms	RSCC	RSR	B-factors(Å <sup>2</sup> )	Q<0.9
4	61G	A	403	5/5	0.84	0.36	28,35,38,44	0
5	SO4	A	404	5/5	0.95	0.19	34,37,66,68	0
2	MG	A	401	1/1	0.98	0.04	31,31,31,31	0
6	ISY	A	405	14/14	0.98	0.09	31,34,37,40	0
3	PIS	A	402	9/9	0.99	0.06	29,31,33,45	0

The following is a graphical depiction of the model fit to experimental electron density of all instances of the Ligand of Interest. In addition, ligands with molecular weight > 250 and outliers as shown on the geometry validation Tables will also be included. Each fit is shown from different orientation to approximate a three-dimensional view.

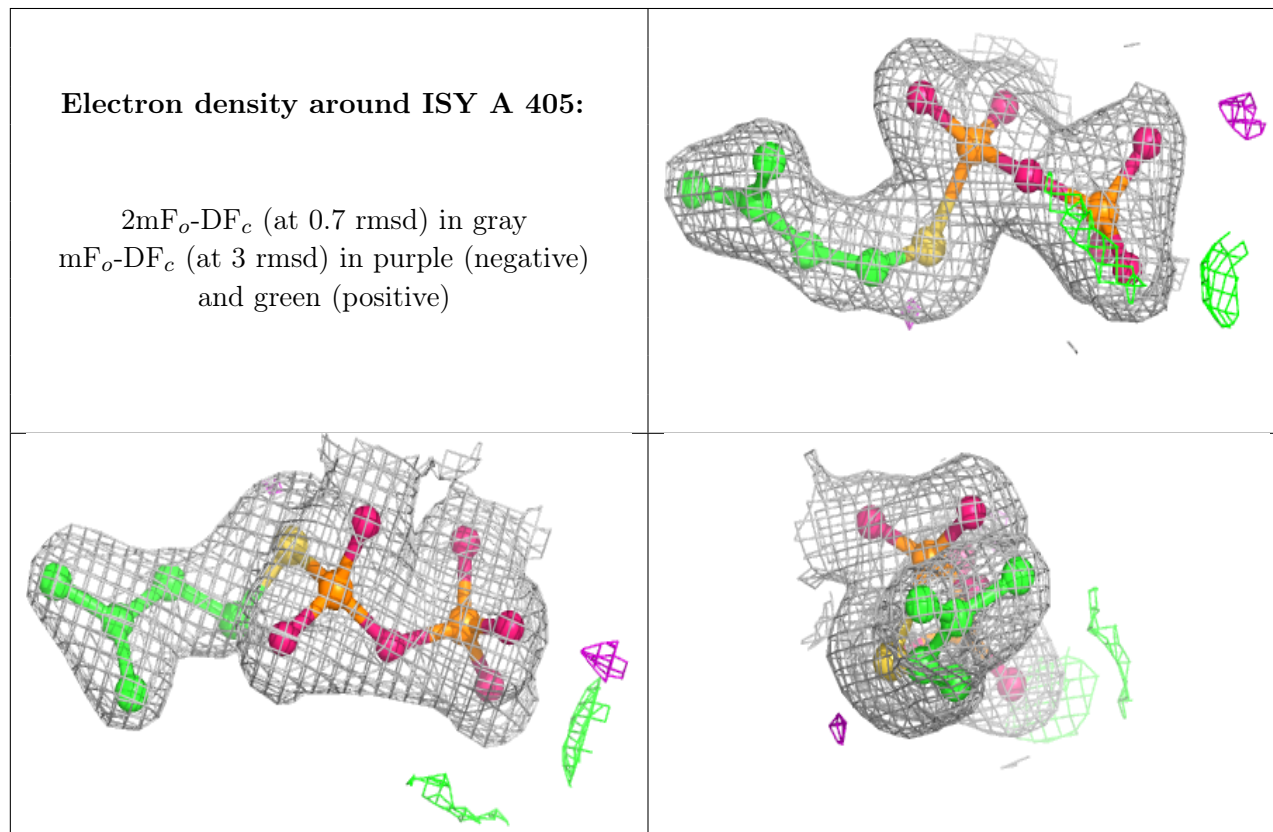



## 6.5 Other polymers [i](#)

There are no such residues in this entry.