



Full wwPDB X-ray Structure Validation Report ⓘ

Aug 21, 2020 – 06:58 AM BST

PDB ID : 4GAV
Title : Structure of the Ndi1 protein from *Saccharomyces cerevisiae* in complex with quinone
Authors : Iwata, M.; Lee, Y.; Yamashita, T.; Yagi, T.; Iwata, S.; Cameron, A.D.; Maher, M.J.
Deposited on : 2012-07-25
Resolution : 3.00 Å(reported)

This is a Full wwPDB X-ray Structure Validation Report for a publicly released PDB entry.

We welcome your comments at validation@mail.wwpdb.org

A user guide is available at

<https://www.wwpdb.org/validation/2017/XrayValidationReportHelp>

with specific help available everywhere you see the ⓘ symbol.

The following versions of software and data (see [references ⓘ](#)) were used in the production of this report:

MolProbity : 4.02b-467
Mogul : 1.8.5 (274361), CSD as541be (2020)
Xtriage (Phenix) : 1.13
EDS : 2.13.1
buster-report : 1.1.7 (2018)
Percentile statistics : 20191225.v01 (using entries in the PDB archive December 25th 2019)
Refmac : 5.8.0158
CCP4 : 7.0.044 (Gargrove)
Ideal geometry (proteins) : Engh & Huber (2001)
Ideal geometry (DNA, RNA) : Parkinson et al. (1996)
Validation Pipeline (wwPDB-VP) : 2.13.1

1 Overall quality at a glance

The following experimental techniques were used to determine the structure:

X-RAY DIFFRACTION

The reported resolution of this entry is 3.00 Å.

Percentile scores (ranging between 0-100) for global validation metrics of the entry are shown in the following graphic. The table shows the number of entries on which the scores are based.

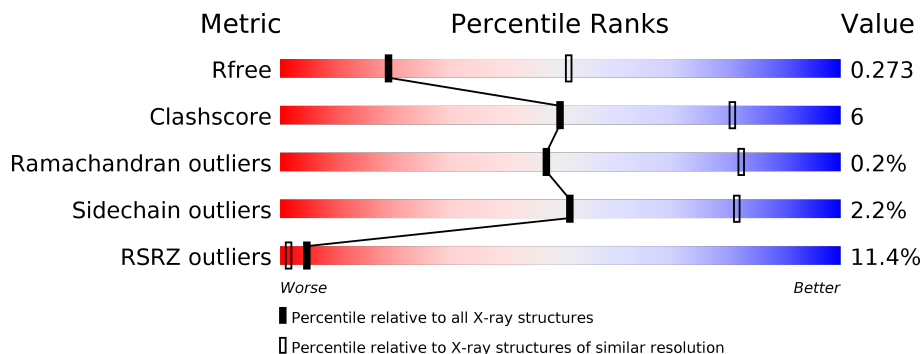

Metric	Whole archive (#Entries)	Similar resolution (#Entries, resolution range(Å))
R_{free}	130704	2092 (3.00-3.00)
Clashscore	141614	2416 (3.00-3.00)
Ramachandran outliers	138981	2333 (3.00-3.00)
Sidechain outliers	138945	2336 (3.00-3.00)
RSRZ outliers	127900	1990 (3.00-3.00)

The table below summarises the geometric issues observed across the polymeric chains and their fit to the electron density. The red, orange, yellow and green segments on the lower bar indicate the fraction of residues that contain outliers for ≥ 3 , 2, 1 and 0 types of geometric quality criteria respectively. A grey segment represents the fraction of residues that are not modelled. The numeric value for each fraction is indicated below the corresponding segment, with a dot representing fractions $\leq 5\%$. The upper red bar (where present) indicates the fraction of residues that have poor fit to the electron density. The numeric value is given above the bar.

Mol	Chain	Length	Quality of chain
1	A	471	 9% 85% 13% ..
1	B	471	 14% 84% 14% ..

The following table lists non-polymeric compounds, carbohydrate monomers and non-standard residues in protein, DNA, RNA chains that are outliers for geometric or electron-density-fit criteria:

Mol	Type	Chain	Res	Chirality	Geometry	Clashes	Electron density
3	UQ2	A	602	-	-	-	X
3	UQ2	B	602	-	-	X	X

2 Entry composition [i](#)

There are 3 unique types of molecules in this entry. The entry contains 7498 atoms, of which 0 are hydrogens and 0 are deuteriums.

In the tables below, the ZeroOcc column contains the number of atoms modelled with zero occupancy, the AltConf column contains the number of residues with at least one atom in alternate conformation and the Trace column contains the number of residues modelled with at most 2 atoms.

- Molecule 1 is a protein called Rotenone-insensitive NADH-ubiquinone oxidoreductase.

Mol	Chain	Residues	Atoms					ZeroOcc	AltConf	Trace
			Total	C	N	O	S			
1	A	463	Total 3673	2377	620	671	5	0	1	0
1	B	463	Total 3673	2377	620	671	5	0	1	0

- Molecule 2 is FLAVIN-ADENINE DINUCLEOTIDE (three-letter code: FAD) (formula: $C_{27}H_{33}N_9O_{15}P_2$).

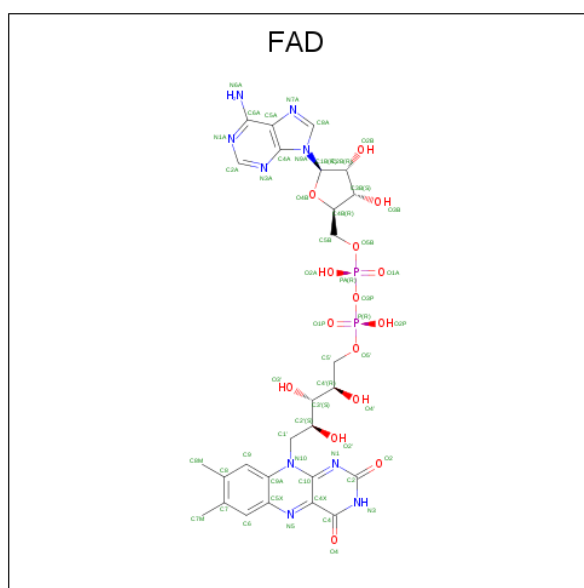

Mol	Chain	Residues	Atoms					ZeroOcc	AltConf
			Total	C	N	O	P		
2	A	1	Total 53	27	9	15	2	0	0
2	B	1	Total 53	27	9	15	2	0	0

- Molecule 3 is UBIQUINONE-2 (three-letter code: UQ2) (formula: $C_{19}H_{26}O_4$).

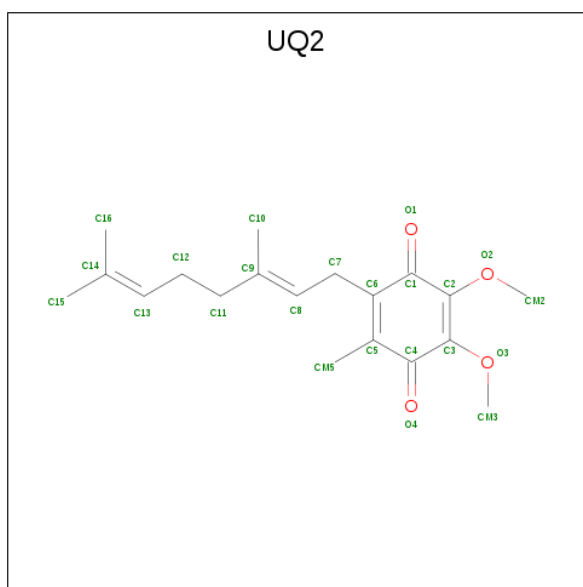

Mol	Chain	Residues	Atoms		ZeroOcc	AltConf
3	A	1	Total	C O	0	0
			23	19 4		
3	B	1	Total	C O	0	0
			23	19 4		

3 Residue-property plots [i](#)

These plots are drawn for all protein, RNA, DNA and oligosaccharide chains in the entry. The first graphic for a chain summarises the proportions of the various outlier classes displayed in the second graphic. The second graphic shows the sequence view annotated by issues in geometry and electron density. Residues are color-coded according to the number of geometric quality criteria for which they contain at least one outlier: green = 0, yellow = 1, orange = 2 and red = 3 or more. A red dot above a residue indicates a poor fit to the electron density ($RSRZ > 2$). Stretches of 2 or more consecutive residues without any outlier are shown as a green connector. Residues present in the sample, but not in the model, are shown in grey.

- Molecule 1: Rotenone-insensitive NADH-ubiquinone oxidoreductase

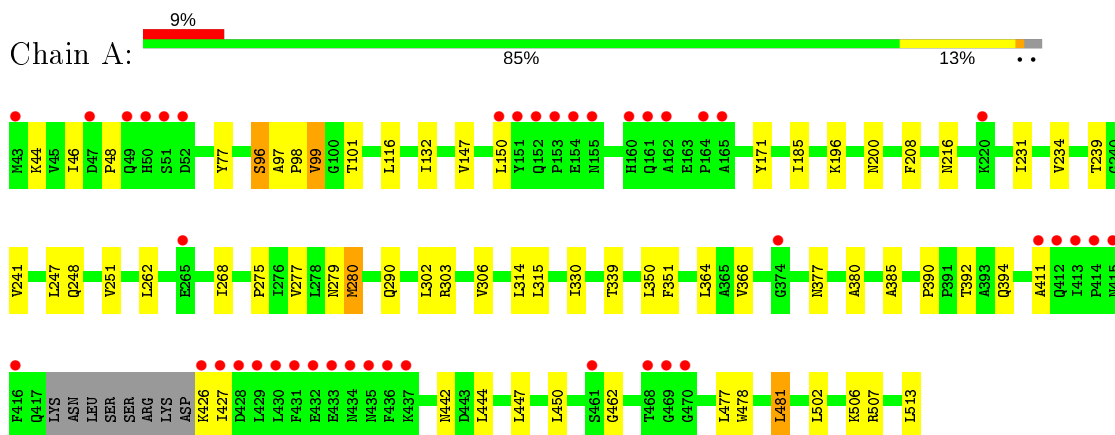

- Molecule 1: Rotenone-insensitive NADH-ubiquinone oxidoreductase

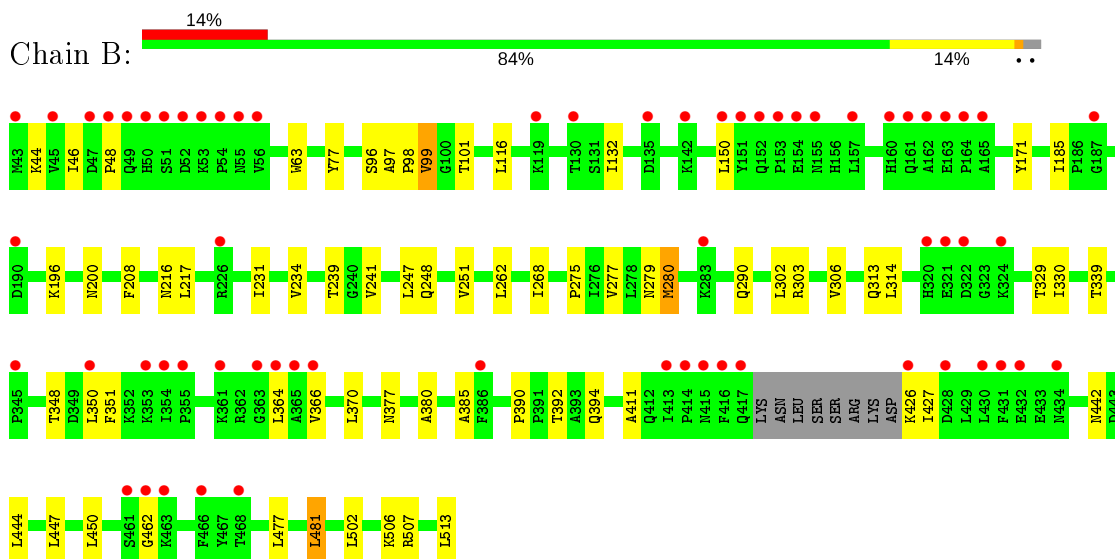

4 Data and refinement statistics

Property	Value	Source
Space group	P 21 21 21	Depositor
Cell constants a, b, c, α , β , γ	65.59Å 111.93Å 165.53Å 90.00° 90.00° 90.00°	Depositor
Resolution (Å)	39.50 – 3.00 39.50 – 3.00	Depositor EDS
% Data completeness (in resolution range)	98.6 (39.50-3.00) 98.6 (39.50-3.00)	Depositor EDS
R_{merge}	(Not available)	Depositor
R_{sym}	(Not available)	Depositor
$\langle I/\sigma(I) \rangle$ ¹	1.87 (at 3.01Å)	Xtrriage
Refinement program	REFMAC 5.6.0117	Depositor
R, R_{free}	0.240 , 0.268 0.242 , 0.273	Depositor DCC
R_{free} test set	1268 reflections (5.11%)	wwPDB-VP
Wilson B-factor (Å ²)	94.3	Xtrriage
Anisotropy	0.017	Xtrriage
Bulk solvent k_{sol} (e/Å ³), B_{sol} (Å ²)	0.37 , 78.8	EDS
L-test for twinning ²	$\langle L \rangle = 0.51$, $\langle L^2 \rangle = 0.34$	Xtrriage
Estimated twinning fraction	No twinning to report.	Xtrriage
F_o, F_c correlation	0.92	EDS
Total number of atoms	7498	wwPDB-VP
Average B, all atoms (Å ²)	102.0	wwPDB-VP

Xtrriage's analysis on translational NCS is as follows: *The analyses of the Patterson function reveals a significant off-origin peak that is 35.39 % of the origin peak, indicating pseudo-translational symmetry. The chance of finding a peak of this or larger height randomly in a structure without pseudo-translational symmetry is equal to 5.8738e-04. The detected translational NCS is most likely also responsible for the elevated intensity ratio.*

¹ Intensities estimated from amplitudes.

² Theoretical values of $\langle |L| \rangle$, $\langle L^2 \rangle$ for acentric reflections are 0.5, 0.333 respectively for untwinned datasets, and 0.375, 0.2 for perfectly twinned datasets.

5 Model quality [i](#)

5.1 Standard geometry [i](#)

Bond lengths and bond angles in the following residue types are not validated in this section: UQ2, FAD

The Z score for a bond length (or angle) is the number of standard deviations the observed value is removed from the expected value. A bond length (or angle) with $|Z| > 5$ is considered an outlier worth inspection. RMSZ is the root-mean-square of all Z scores of the bond lengths (or angles).

Mol	Chain	Bond lengths		Bond angles	
		RMSZ	# Z >5	RMSZ	# Z >5
1	A	0.42	1/3761 (0.0%)	0.50	0/5091
1	B	0.42	0/3761	0.49	0/5091
All	All	0.42	1/7522 (0.0%)	0.50	0/10182

All (1) bond length outliers are listed below:

Mol	Chain	Res	Type	Atoms	Z	Observed(Å)	Ideal(Å)
1	A	478	TRP	CD2-CE2	5.18	1.47	1.41

There are no bond angle outliers.

There are no chirality outliers.

There are no planarity outliers.

5.2 Too-close contacts [i](#)

In the following table, the Non-H and H(model) columns list the number of non-hydrogen atoms and hydrogen atoms in the chain respectively. The H(added) column lists the number of hydrogen atoms added and optimized by MolProbity. The Clashes column lists the number of clashes within the asymmetric unit, whereas Symm-Clashes lists symmetry related clashes.

Mol	Chain	Non-H	H(model)	H(added)	Clashes	Symm-Clashes
1	A	3673	0	3731	36	0
1	B	3673	0	3731	41	0
2	A	53	0	31	3	0
2	B	53	0	31	2	0
3	A	23	0	26	6	0
3	B	23	0	26	12	0
All	All	7498	0	7576	88	0

The all-atom clashscore is defined as the number of clashes found per 1000 atoms (including hydrogen atoms). The all-atom clashscore for this structure is 6.

All (88) close contacts within the same asymmetric unit are listed below, sorted by their clash magnitude.

Atom-1	Atom-2	Interatomic distance (Å)	Clash overlap (Å)
1:A:116:LEU:HD13	1:A:150:LEU:HD13	1.58	0.85
1:B:116:LEU:HD13	1:B:150:LEU:HD13	1.59	0.85
1:B:280:MET:HE3	1:B:280:MET:H	1.48	0.78
1:A:280:MET:H	1:A:280:MET:HE3	1.48	0.78
1:B:277:VAL:HG23	1:B:302:LEU:HD21	1.68	0.75
1:A:277:VAL:HG23	1:A:302:LEU:HD21	1.69	0.74
1:B:447:LEU:O	3:B:602:UQ2:H5M2	1.93	0.69
1:A:248:GLN:HE21	1:A:268:ILE:HD12	1.56	0.69
3:B:602:UQ2:H8	3:B:602:UQ2:H5M1	1.76	0.68
1:A:239:THR:HG23	2:A:601:FAD:HM73	1.78	0.66
3:A:602:UQ2:C8	3:A:602:UQ2:H5M1	2.26	0.66
1:A:196:LYS:H	1:A:200:ASN:HD22	1.46	0.64
1:B:248:GLN:HE21	1:B:268:ILE:HD12	1.61	0.64
3:B:602:UQ2:H5M1	3:B:602:UQ2:C8	2.27	0.63
1:A:380:ALA:HB1	1:A:385:ALA:HB2	1.81	0.62
1:B:196:LYS:H	1:B:200:ASN:HD22	1.48	0.62
2:A:601:FAD:O4'	2:A:601:FAD:O1A	2.14	0.61
3:A:602:UQ2:H8	3:A:602:UQ2:H5M1	1.84	0.60
1:B:380:ALA:HB1	1:B:385:ALA:HB2	1.85	0.59
1:A:248:GLN:NE2	1:A:268:ILE:HD12	2.17	0.58
1:B:99:VAL:HG13	1:B:507:ARG:HD3	1.86	0.57
2:A:601:FAD:O4	3:A:602:UQ2:H5M3	2.05	0.56
1:A:99:VAL:HG13	1:A:507:ARG:HD3	1.87	0.56
1:A:447:LEU:O	3:A:602:UQ2:H5M2	2.05	0.55
1:B:239:THR:HG23	2:B:601:FAD:HM73	1.89	0.55
1:B:248:GLN:NE2	1:B:268:ILE:HD12	2.20	0.55
1:A:208:PHE:CE1	1:A:231:ILE:HD11	2.42	0.55
1:A:132:ILE:HB	1:A:350:LEU:HD13	1.88	0.54
1:B:234:VAL:HG12	1:B:339:THR:CG2	2.38	0.54
1:B:132:ILE:HB	1:B:350:LEU:HD13	1.89	0.53
1:B:63:TRP:CZ3	3:B:602:UQ2:H162	2.45	0.51
1:B:208:PHE:CE1	1:B:231:ILE:HD11	2.46	0.51
1:A:116:LEU:CD1	1:A:150:LEU:HD13	2.37	0.50
1:A:234:VAL:HG12	1:A:339:THR:CG2	2.41	0.50
1:B:171:TYR:CE2	1:B:427:ILE:HD13	2.47	0.50
1:B:502:LEU:HD12	1:B:506:LYS:HA	1.93	0.49
1:B:63:TRP:CH2	3:B:602:UQ2:H162	2.46	0.49

Continued on next page...

Continued from previous page...

Atom-1	Atom-2	Interatomic distance (Å)	Clash overlap (Å)
1:B:46:ILE:HG22	1:B:48:PRO:HD3	1.94	0.48
1:A:171:TYR:CE2	1:A:427:ILE:HD13	2.49	0.48
1:A:46:ILE:HG22	1:A:48:PRO:HD3	1.94	0.48
1:A:502:LEU:HD12	1:A:506:LYS:HA	1.94	0.48
1:A:101:THR:HG23	1:A:502:LEU:CD2	2.45	0.47
1:A:390:PRO:HB2	1:A:392:THR:HG23	1.96	0.47
3:A:602:UQ2:C8	3:A:602:UQ2:CM5	2.92	0.47
1:B:63:TRP:CZ3	3:B:602:UQ2:C16	2.98	0.47
1:A:185:ILE:HD13	1:A:306:VAL:O	2.15	0.46
1:B:313:GLN:OE1	1:B:329:THR:HG21	2.15	0.46
1:A:147:VAL:HG23	1:B:217:LEU:HD21	1.98	0.46
1:A:216:ASN:HB2	1:A:262:LEU:HD11	1.97	0.46
1:A:241:VAL:HG11	1:A:450:LEU:HD22	1.98	0.45
1:B:101:THR:HG23	1:B:502:LEU:CD2	2.46	0.45
1:A:241:VAL:HG11	1:A:450:LEU:CD2	2.46	0.45
1:A:315:LEU:N	1:A:315:LEU:HD12	2.31	0.45
1:B:216:ASN:HB2	1:B:262:LEU:HD11	1.98	0.45
1:B:241:VAL:HG11	1:B:450:LEU:HD22	1.99	0.45
1:B:290:GLN:NE2	1:B:302:LEU:HD11	2.32	0.44
3:B:602:UQ2:O3	3:B:602:UQ2:H2M2	2.17	0.44
1:B:394:GLN:HB2	3:B:602:UQ2:C10	2.48	0.44
2:B:601:FAD:O2	3:B:602:UQ2:H102	2.17	0.44
1:B:394:GLN:NE2	1:B:444:LEU:HD12	2.32	0.44
1:B:241:VAL:HG11	1:B:450:LEU:CD2	2.48	0.44
1:B:275:PRO:HB3	1:B:303:ARG:HE	1.83	0.44
1:A:290:GLN:NE2	1:A:302:LEU:HD11	2.33	0.44
1:B:185:ILE:HD13	1:B:306:VAL:O	2.18	0.43
3:A:602:UQ2:H122	3:A:602:UQ2:H101	1.54	0.43
1:A:314:LEU:HD23	1:A:330:ILE:O	2.18	0.43
1:A:247:LEU:O	1:A:251:VAL:HG23	2.18	0.43
1:A:394:GLN:NE2	1:A:444:LEU:HD12	2.34	0.43
1:B:314:LEU:HD23	1:B:330:ILE:O	2.20	0.42
1:B:390:PRO:HB2	1:B:392:THR:HG23	2.01	0.42
1:B:477:LEU:HG	1:B:481:LEU:HD22	2.02	0.42
3:B:602:UQ2:CM5	3:B:602:UQ2:C8	2.94	0.42
1:A:477:LEU:HG	1:A:481:LEU:HD22	2.02	0.42
1:B:351:PHE:HE2	1:B:364:LEU:HD23	1.84	0.42
3:B:602:UQ2:H122	3:B:602:UQ2:H101	1.74	0.41
1:A:275:PRO:HB3	1:A:303:ARG:HE	1.85	0.41
1:B:247:LEU:O	1:B:251:VAL:HG23	2.20	0.41
1:A:77:TYR:OH	1:A:411:ALA:HB2	2.20	0.41

Continued on next page...

Continued from previous page...

Atom-1	Atom-2	Interatomic distance (Å)	Clash overlap (Å)
1:B:348:THR:HA	1:B:351:PHE:CD1	2.56	0.41
1:B:97:ALA:N	1:B:98:PRO:CD	2.83	0.41
1:A:351:PHE:HE2	1:A:364:LEU:HD23	1.84	0.41
1:B:394:GLN:OE1	3:B:602:UQ2:H101	2.21	0.41
1:B:442:ASN:HD21	1:B:462:GLY:N	2.19	0.41
1:B:366:VAL:HG22	1:B:370:LEU:HA	2.02	0.40
1:B:77:TYR:OH	1:B:411:ALA:HB2	2.21	0.40
1:A:442:ASN:HD21	1:A:462:GLY:N	2.19	0.40
1:A:96:SER:HB3	1:A:101:THR:HB	2.02	0.40
1:A:97:ALA:N	1:A:98:PRO:CD	2.84	0.40

There are no symmetry-related clashes.

5.3 Torsion angles [i](#)

5.3.1 Protein backbone [i](#)

In the following table, the Percentiles column shows the percent Ramachandran outliers of the chain as a percentile score with respect to all X-ray entries followed by that with respect to entries of similar resolution.

The Analysed column shows the number of residues for which the backbone conformation was analysed, and the total number of residues.

Mol	Chain	Analysed	Favoured	Allowed	Outliers	Percentiles	
1	A	460/471 (98%)	430 (94%)	29 (6%)	1 (0%)	47	82
1	B	460/471 (98%)	430 (94%)	29 (6%)	1 (0%)	47	82
All	All	920/942 (98%)	860 (94%)	58 (6%)	2 (0%)	47	82

All (2) Ramachandran outliers are listed below:

Mol	Chain	Res	Type
1	A	44	LYS
1	B	44	LYS

5.3.2 Protein sidechains [i](#)

In the following table, the Percentiles column shows the percent sidechain outliers of the chain as a percentile score with respect to all X-ray entries followed by that with respect to entries of similar resolution.

The Analysed column shows the number of residues for which the sidechain conformation was analysed, and the total number of residues.

Mol	Chain	Analysed	Rotameric	Outliers	Percentiles	
1	A	395/402 (98%)	386 (98%)	9 (2%)	50	80
1	B	395/402 (98%)	387 (98%)	8 (2%)	55	83
All	All	790/804 (98%)	773 (98%)	17 (2%)	52	81

All (17) residues with a non-rotameric sidechain are listed below:

Mol	Chain	Res	Type
1	A	96	SER
1	A	99	VAL
1	A	279	ASN
1	A	280	MET
1	A	366	VAL
1	A	377	ASN
1	A	426	LYS
1	A	481	LEU
1	A	513	LEU
1	B	96	SER
1	B	99	VAL
1	B	279	ASN
1	B	280	MET
1	B	377	ASN
1	B	426	LYS
1	B	481	LEU
1	B	513	LEU

Some sidechains can be flipped to improve hydrogen bonding and reduce clashes. All (15) such sidechains are listed below:

Mol	Chain	Res	Type
1	A	137	ASN
1	A	200	ASN
1	A	248	GLN
1	A	279	ASN
1	A	377	ASN
1	A	384	ASN
1	A	442	ASN
1	B	137	ASN
1	B	200	ASN
1	B	216	ASN

Continued on next page...

Continued from previous page...

Mol	Chain	Res	Type
1	B	248	GLN
1	B	279	ASN
1	B	377	ASN
1	B	384	ASN
1	B	442	ASN

5.3.3 RNA [i](#)

There are no RNA molecules in this entry.

5.4 Non-standard residues in protein, DNA, RNA chains [i](#)

There are no non-standard protein/DNA/RNA residues in this entry.

5.5 Carbohydrates [i](#)

There are no monosaccharides in this entry.

5.6 Ligand geometry [i](#)

4 ligands are modelled in this entry.

In the following table, the Counts columns list the number of bonds (or angles) for which Mogul statistics could be retrieved, the number of bonds (or angles) that are observed in the model and the number of bonds (or angles) that are defined in the Chemical Component Dictionary. The Link column lists molecule types, if any, to which the group is linked. The Z score for a bond length (or angle) is the number of standard deviations the observed value is removed from the expected value. A bond length (or angle) with $|Z| > 2$ is considered an outlier worth inspection. RMSZ is the root-mean-square of all Z scores of the bond lengths (or angles).

Mol	Type	Chain	Res	Link	Bond lengths			Bond angles		
					Counts	RMSZ	# Z > 2	Counts	RMSZ	# Z > 2
2	FAD	B	601	-	51,58,58	1.95	7 (13%)	60,89,89	1.98	10 (16%)
3	UQ2	A	602	-	23,23,23	1.72	2 (8%)	28,31,31	1.64	5 (17%)
2	FAD	A	601	-	51,58,58	1.84	7 (13%)	60,89,89	2.07	11 (18%)
3	UQ2	B	602	-	23,23,23	1.77	2 (8%)	28,31,31	1.49	5 (17%)

In the following table, the Chirals column lists the number of chiral outliers, the number of chiral centers analysed, the number of these observed in the model and the number defined in the Chemical Component Dictionary. Similar counts are reported in the Torsion and Rings columns.

'-' means no outliers of that kind were identified.

Mol	Type	Chain	Res	Link	Chirals	Torsions	Rings
2	FAD	B	601	-	-	1/30/50/50	0/6/6/6
3	UQ2	A	602	-	-	8/15/39/39	0/1/1/1
2	FAD	A	601	-	-	1/30/50/50	0/6/6/6
3	UQ2	B	602	-	-	7/15/39/39	0/1/1/1

All (18) bond length outliers are listed below:

Mol	Chain	Res	Type	Atoms	Z	Observed(Å)	Ideal(Å)
2	B	601	FAD	C4X-C10	10.41	1.49	1.38
2	A	601	FAD	C4X-C10	9.38	1.48	1.38
3	B	602	UQ2	C6-C5	7.46	1.48	1.35
3	A	602	UQ2	C6-C5	7.30	1.48	1.35
2	B	601	FAD	C4-C4X	3.94	1.48	1.41
2	A	601	FAD	C4-C4X	3.62	1.47	1.41
2	B	601	FAD	C9A-N10	3.62	1.43	1.38
2	A	601	FAD	C9A-C5X	3.59	1.49	1.42
2	B	601	FAD	C9A-C5X	3.59	1.49	1.42
2	A	601	FAD	C9A-N10	3.47	1.43	1.38
3	B	602	UQ2	C3-C2	3.11	1.49	1.36
3	A	602	UQ2	C3-C2	3.07	1.48	1.36
2	A	601	FAD	C8-C7	2.95	1.48	1.40
2	B	601	FAD	C8-C7	2.93	1.48	1.40
2	B	601	FAD	C10-N1	2.25	1.36	1.33
2	A	601	FAD	C5A-C4A	2.24	1.46	1.40
2	A	601	FAD	C10-N1	2.11	1.36	1.33
2	B	601	FAD	C5A-C4A	2.08	1.46	1.40

All (31) bond angle outliers are listed below:

Mol	Chain	Res	Type	Atoms	Z	Observed(°)	Ideal(°)
2	A	601	FAD	C4-N3-C2	8.36	122.20	115.14
2	B	601	FAD	C4-N3-C2	8.14	122.01	115.14
2	A	601	FAD	C1'-N10-C9A	7.19	123.95	118.29
2	B	601	FAD	C1'-N10-C9A	6.20	123.17	118.29
2	A	601	FAD	C4-C4X-C10	-4.90	116.71	119.95
3	A	602	UQ2	C7-C8-C9	-4.37	119.52	126.79
2	A	601	FAD	C4X-N5-C5X	4.25	121.02	116.77
2	B	601	FAD	C4X-N5-C5X	4.03	120.80	116.77
2	A	601	FAD	N3A-C2A-N1A	-3.88	122.61	128.68
2	B	601	FAD	C4-C4X-C10	-3.81	117.43	119.95
2	B	601	FAD	N3A-C2A-N1A	-3.78	122.78	128.68

Continued on next page...

Continued from previous page...

Mol	Chain	Res	Type	Atoms	Z	Observed(°)	Ideal(°)
3	B	602	UQ2	C7-C8-C9	-3.74	120.57	126.79
2	B	601	FAD	C4X-C4-N3	-3.57	118.55	123.43
3	B	602	UQ2	C10-C9-C11	3.38	120.96	115.27
3	A	602	UQ2	CM5-C5-C6	-3.31	118.99	124.40
3	A	602	UQ2	C10-C9-C11	3.22	120.69	115.27
2	A	601	FAD	C4X-C4-N3	-3.21	119.04	123.43
2	B	601	FAD	C9A-N10-C10	-3.13	117.81	121.91
2	B	601	FAD	C4A-C5A-N7A	-3.01	106.26	109.40
2	A	601	FAD	C4A-C5A-N7A	-2.87	106.41	109.40
3	B	602	UQ2	CM5-C5-C6	-2.73	119.94	124.40
2	A	601	FAD	C9A-N10-C10	-2.61	118.49	121.91
2	B	601	FAD	C5X-C9A-N10	2.43	119.48	117.72
2	A	601	FAD	C4-C4X-N5	2.35	121.28	118.60
2	A	601	FAD	P-O3P-PA	-2.34	124.79	132.83
2	B	601	FAD	P-O3P-PA	-2.28	125.02	132.83
3	A	602	UQ2	C16-C14-C15	2.24	119.55	114.60
3	A	602	UQ2	C10-C9-C8	-2.12	118.25	123.68
3	B	602	UQ2	C16-C14-C15	2.09	119.21	114.60
3	B	602	UQ2	C10-C9-C8	-2.05	118.41	123.68
2	A	601	FAD	O2P-P-O1P	2.05	122.38	112.24

There are no chirality outliers.

All (17) torsion outliers are listed below:

Mol	Chain	Res	Type	Atoms
3	A	602	UQ2	C9-C11-C12-C13
3	A	602	UQ2	C12-C11-C9-C10
3	B	602	UQ2	C12-C11-C9-C10
3	A	602	UQ2	C12-C11-C9-C8
3	B	602	UQ2	C12-C11-C9-C8
3	A	602	UQ2	C1-C6-C7-C8
3	B	602	UQ2	C1-C6-C7-C8
3	B	602	UQ2	C9-C11-C12-C13
3	B	602	UQ2	C6-C7-C8-C9
3	A	602	UQ2	C5-C6-C7-C8
3	B	602	UQ2	C5-C6-C7-C8
3	A	602	UQ2	C1-C2-O2-CM2
3	A	602	UQ2	C3-C2-O2-CM2
3	B	602	UQ2	C1-C2-O2-CM2
2	A	601	FAD	O4B-C4B-C5B-O5B
3	A	602	UQ2	C11-C12-C13-C14
2	B	601	FAD	O4B-C4B-C5B-O5B

There are no ring outliers.

4 monomers are involved in 21 short contacts:

Mol	Chain	Res	Type	Clashes	Symm-Clashes
2	B	601	FAD	2	0
3	A	602	UQ2	6	0
2	A	601	FAD	3	0
3	B	602	UQ2	12	0

The following is a two-dimensional graphical depiction of Mogul quality analysis of bond lengths, bond angles, torsion angles, and ring geometry for all instances of the Ligand of Interest. In addition, ligands with molecular weight > 250 and outliers as shown on the validation Tables will also be included. For torsion angles, if less than 5% of the Mogul distribution of torsion angles is within 10 degrees of the torsion angle in question, then that torsion angle is considered an outlier. Any bond that is central to one or more torsion angles identified as an outlier by Mogul will be highlighted in the graph. For rings, the root-mean-square deviation (RMSD) between the ring in question and similar rings identified by Mogul is calculated over all ring torsion angles. If the average RMSD is greater than 60 degrees and the minimal RMSD between the ring in question and any Mogul-identified rings is also greater than 60 degrees, then that ring is considered an outlier. The outliers are highlighted in purple. The color gray indicates Mogul did not find sufficient equivalents in the CSD to analyse the geometry.

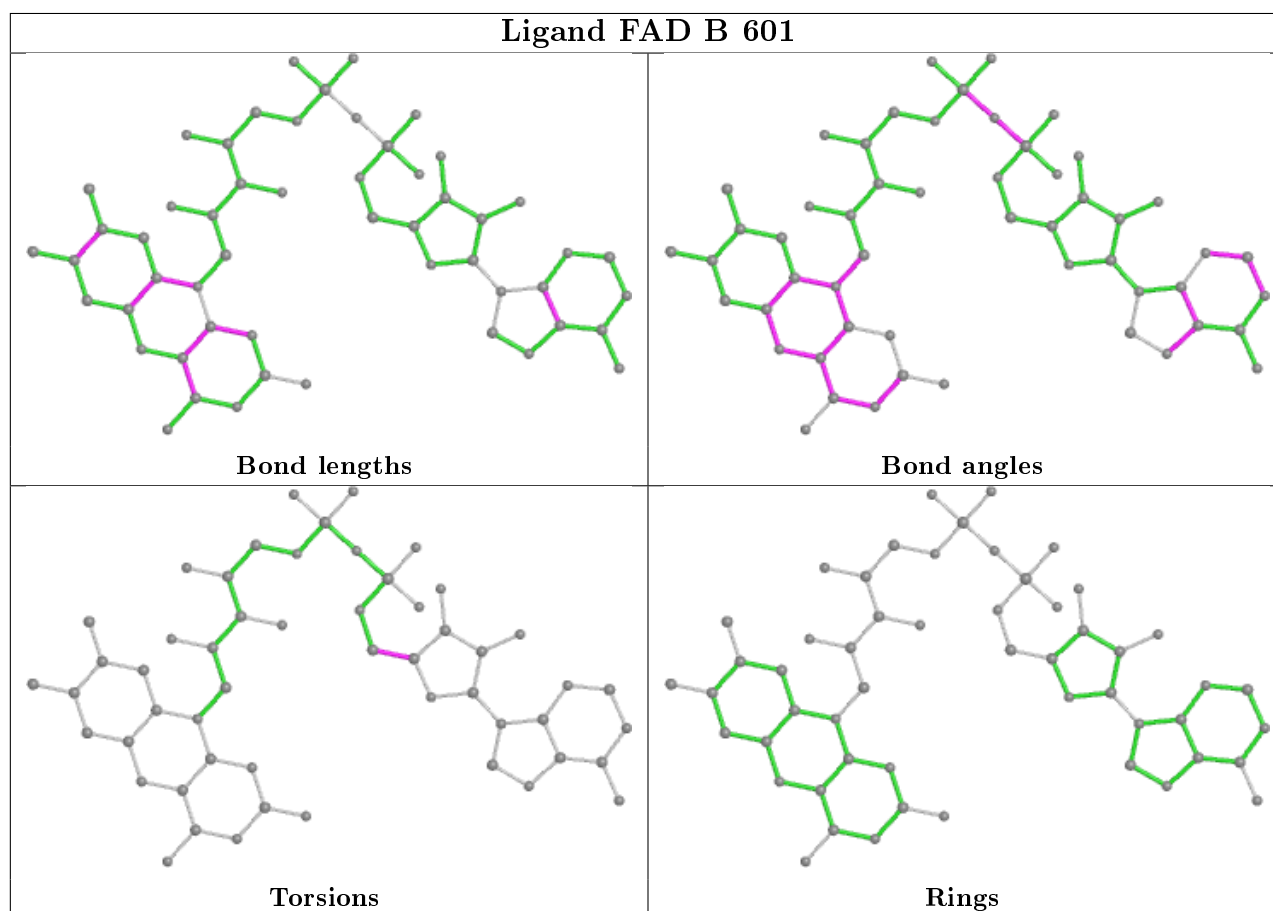

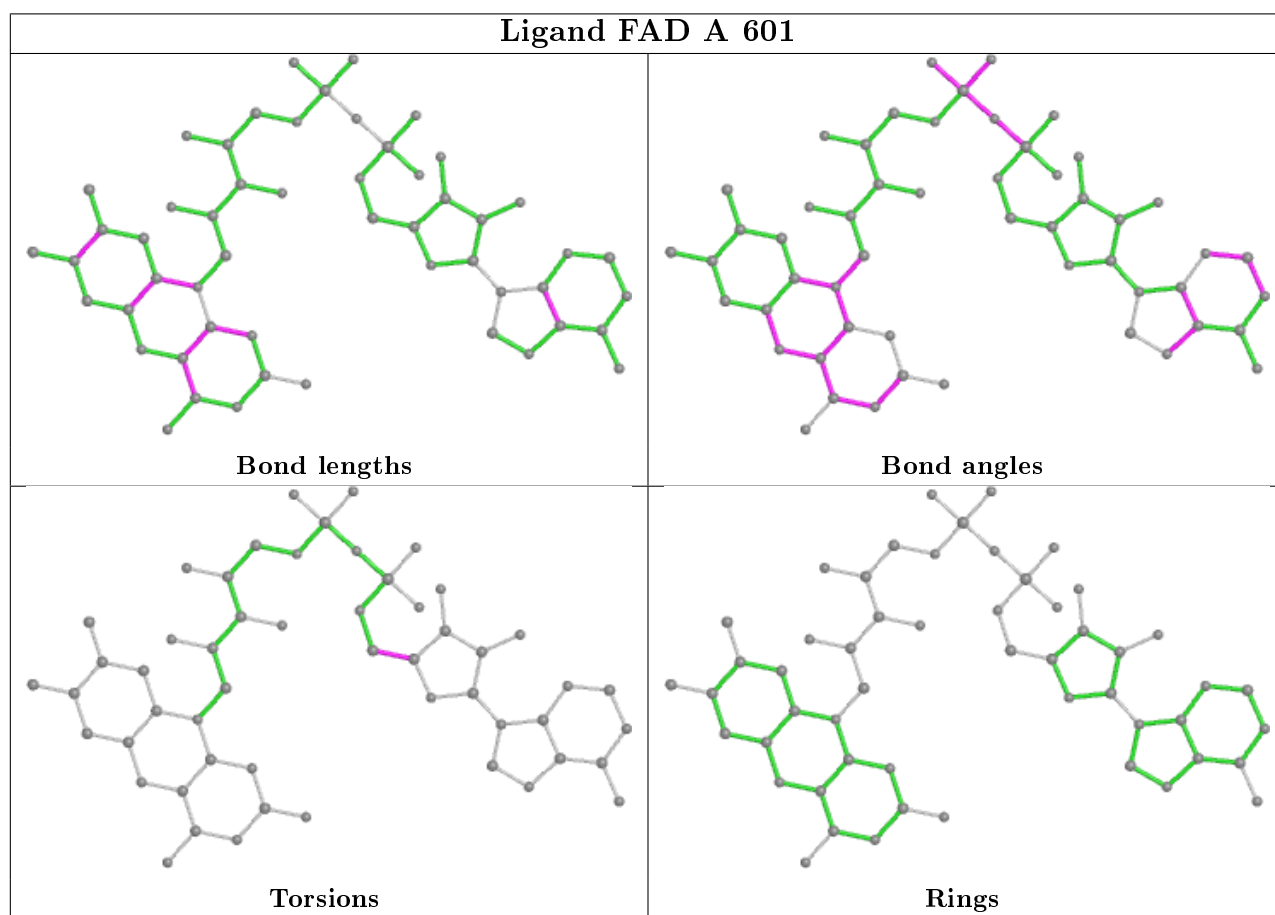
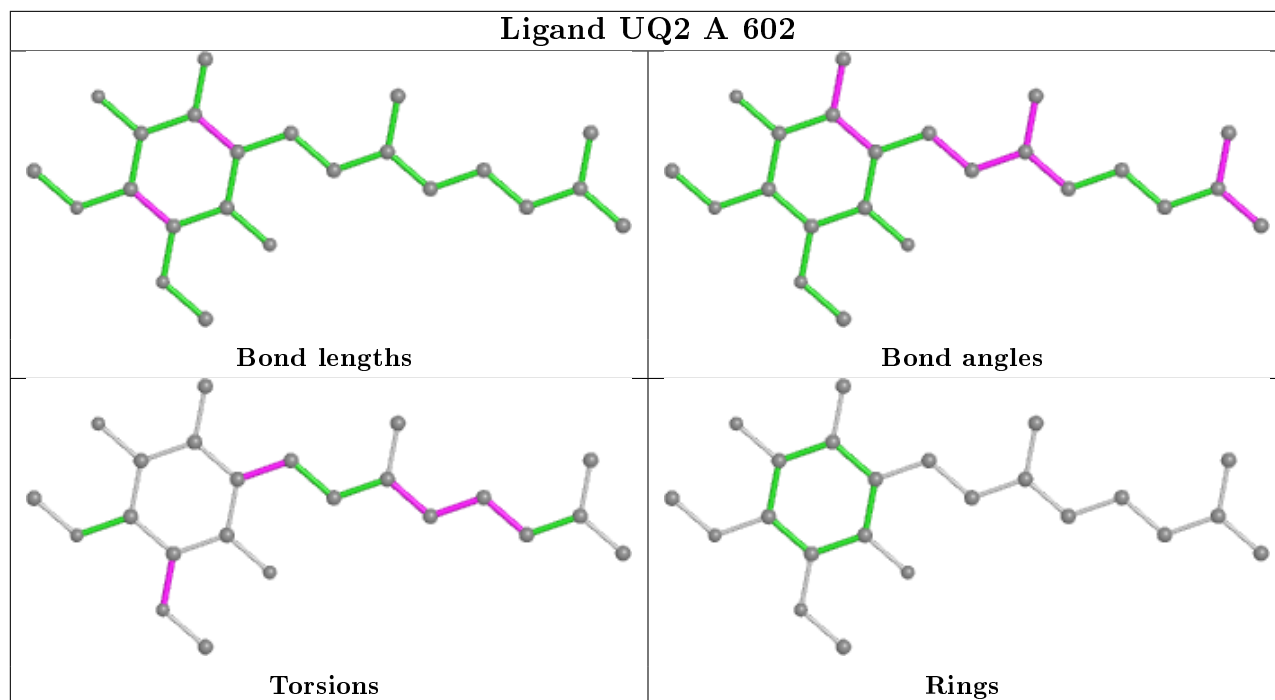

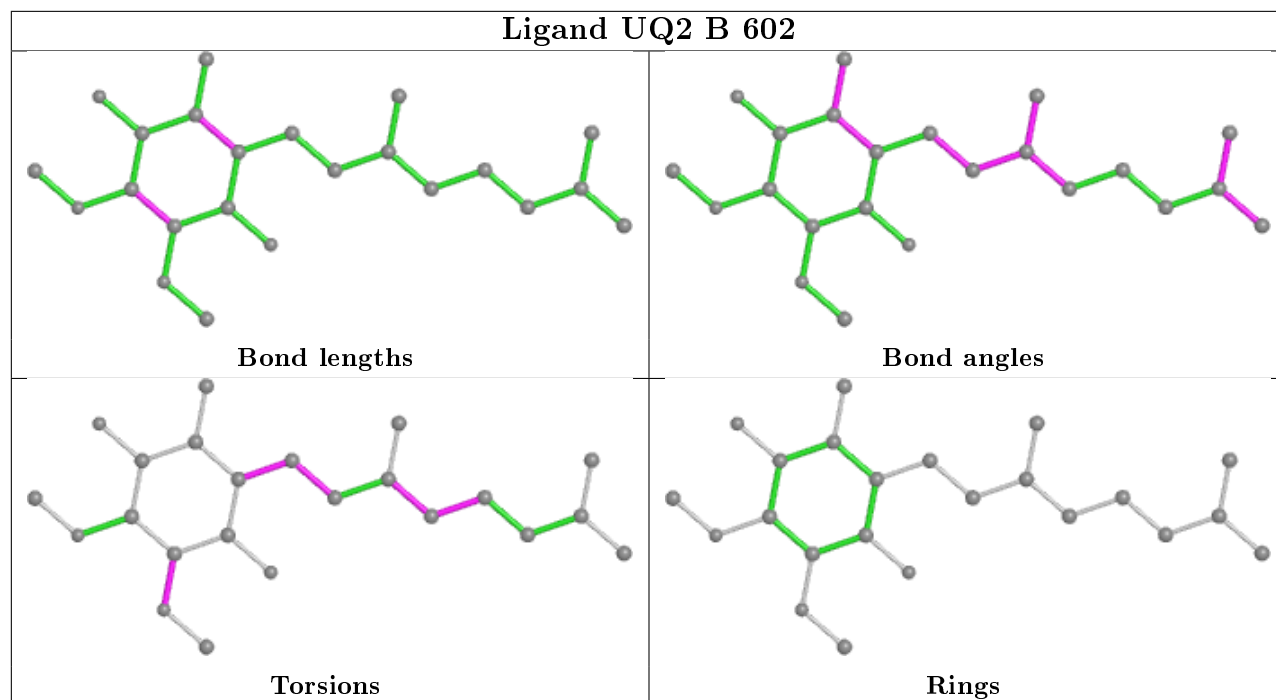

5.7 Other polymers [i](#)

There are no such residues in this entry.

5.8 Polymer linkage issues [i](#)

There are no chain breaks in this entry.

6 Fit of model and data

6.1 Protein, DNA and RNA chains

In the following table, the column labelled ‘#RSRZ> 2’ contains the number (and percentage) of RSRZ outliers, followed by percent RSRZ outliers for the chain as percentile scores relative to all X-ray entries and entries of similar resolution. The OWAB column contains the minimum, median, 95th percentile and maximum values of the occupancy-weighted average B-factor per residue. The column labelled ‘Q< 0.9’ lists the number of (and percentage) of residues with an average occupancy less than 0.9.

Mol	Chain	Analysed	<RSRZ>	#RSRZ>2	OWAB(Å ²)	Q<0.9
1	A	463/471 (98%)	0.28	42 (9%) 9 3	49, 85, 171, 241	0
1	B	463/471 (98%)	0.54	64 (13%) 2 1	54, 96, 180, 257	0
All	All	926/942 (98%)	0.41	106 (11%) 5 1	49, 90, 178, 257	0

All (106) RSRZ outliers are listed below:

Mol	Chain	Res	Type	RSRZ
1	A	154	GLU	18.3
1	B	154	GLU	13.9
1	B	43	MET	8.8
1	A	162	ALA	7.8
1	B	155	ASN	7.8
1	B	153	PRO	7.8
1	A	416	PHE	7.4
1	B	49	GLN	6.5
1	A	153	PRO	6.4
1	B	50	HIS	6.3
1	B	162	ALA	6.3
1	B	152	GLN	5.8
1	B	321	GLU	5.6
1	A	164	PRO	5.6
1	A	165	ALA	5.5
1	A	431	PHE	5.2
1	A	52	ASP	5.2
1	B	415	ASN	5.2
1	B	164	PRO	5.1
1	A	413	ILE	5.0
1	B	165	ALA	5.0
1	A	430	LEU	4.8
1	A	152	GLN	4.8
1	A	415	ASN	4.8

Continued on next page...

Continued from previous page...

Mol	Chain	Res	Type	RSRZ
1	B	51	SER	4.5
1	B	432	GLU	4.5
1	B	414	PRO	4.5
1	A	434	ASN	4.4
1	B	361	LYS	4.3
1	B	416	PHE	4.3
1	A	155	ASN	4.3
1	A	51	SER	4.3
1	B	355	PRO	4.1
1	B	363	GLY	4.1
1	B	428	ASP	4.0
1	B	365	ALA	4.0
1	B	130	THR	3.8
1	B	142	LYS	3.8
1	A	50	HIS	3.8
1	B	48	PRO	3.6
1	A	49	GLN	3.5
1	A	468	THR	3.5
1	A	427	ILE	3.4
1	A	429	LEU	3.4
1	A	161	GLN	3.3
1	B	187	GLY	3.3
1	B	163	GLU	3.3
1	B	160	HIS	3.2
1	A	414	PRO	3.1
1	B	461	SER	3.1
1	A	432	GLU	3.1
1	B	320	HIS	3.1
1	B	150	LEU	3.0
1	A	436	PHE	3.0
1	B	45	VAL	3.0
1	B	468	THR	3.0
1	B	434	ASN	3.0
1	A	151	TYR	3.0
1	B	431	PHE	3.0
1	B	386	PHE	2.9
1	A	411	ALA	2.9
1	B	53	LYS	2.9
1	B	417	GLN	2.9
1	B	47	ASP	2.9
1	B	161	GLN	2.8
1	B	350	LEU	2.8

Continued on next page...

Continued from previous page...

Mol	Chain	Res	Type	RSRZ
1	B	322	ASP	2.8
1	A	150	LEU	2.7
1	B	52	ASP	2.7
1	B	135	ASP	2.7
1	B	353	LYS	2.7
1	A	160	HIS	2.7
1	A	437	LYS	2.7
1	A	428	ASP	2.6
1	B	55	ASN	2.6
1	B	430	LEU	2.6
1	B	119	LYS	2.6
1	B	157	LEU	2.6
1	B	426	LYS	2.6
1	B	151	TYR	2.6
1	A	374	GLY	2.6
1	B	354	ILE	2.5
1	A	469	GLY	2.5
1	A	220	LYS	2.5
1	B	324	LYS	2.4
1	B	283	LYS	2.4
1	A	433	GLU	2.4
1	A	470	GLY	2.3
1	A	265	GLU	2.3
1	B	345	PRO	2.3
1	A	435	ASN	2.3
1	B	364	LEU	2.3
1	A	412	GLN	2.3
1	A	47	ASP	2.2
1	B	466	PHE	2.2
1	B	463	LYS	2.2
1	B	366	VAL	2.2
1	A	426	LYS	2.2
1	A	43	MET	2.1
1	B	462	GLY	2.1
1	A	461	SER	2.1
1	B	190	ASP	2.1
1	B	226	ARG	2.0
1	B	54	PRO	2.0
1	B	413	ILE	2.0
1	B	56	VAL	2.0

6.2 Non-standard residues in protein, DNA, RNA chains [i](#)

There are no non-standard protein/DNA/RNA residues in this entry.

6.3 Carbohydrates [i](#)

There are no monosaccharides in this entry.

6.4 Ligands [i](#)

In the following table, the Atoms column lists the number of modelled atoms in the group and the number defined in the chemical component dictionary. The B-factors column lists the minimum, median, 95th percentile and maximum values of B factors of atoms in the group. The column labelled 'Q< 0.9' lists the number of atoms with occupancy less than 0.9.

Mol	Type	Chain	Res	Atoms	RSCC	RSR	B-factors(Å ²)	Q<0.9
3	UQ2	B	602	23/23	0.48	0.66	62,75,79,84	23
3	UQ2	A	602	23/23	0.70	0.51	57,76,83,87	23
2	FAD	B	601	53/53	0.92	0.26	62,67,87,93	0
2	FAD	A	601	53/53	0.95	0.20	52,60,85,90	0

The following is a graphical depiction of the model fit to experimental electron density of all instances of the Ligand of Interest. In addition, ligands with molecular weight > 250 and outliers as shown on the geometry validation Tables will also be included. Each fit is shown from different orientation to approximate a three-dimensional view.

Electron density around UQ2 B 602:

$2mF_o-DF_c$ (at 0.7 rmsd) in gray
 mF_o-DF_c (at 3 rmsd) in purple (negative)
and green (positive)

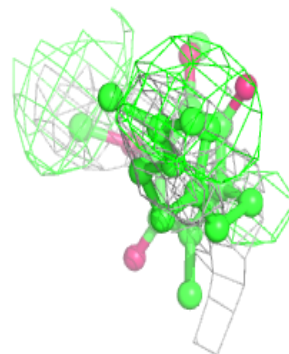
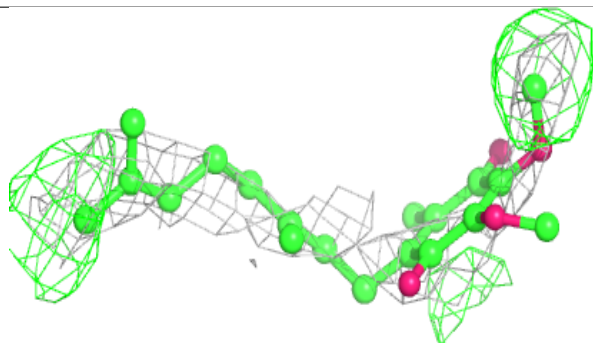
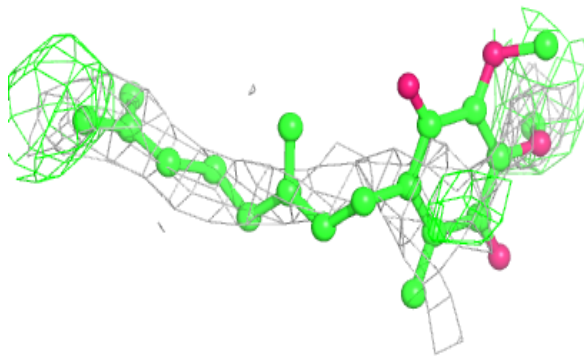
**Electron density around UQ2 A 602:**

$2mF_o-DF_c$ (at 0.7 rmsd) in gray
 mF_o-DF_c (at 3 rmsd) in purple (negative)
and green (positive)

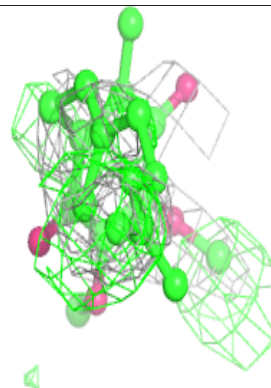
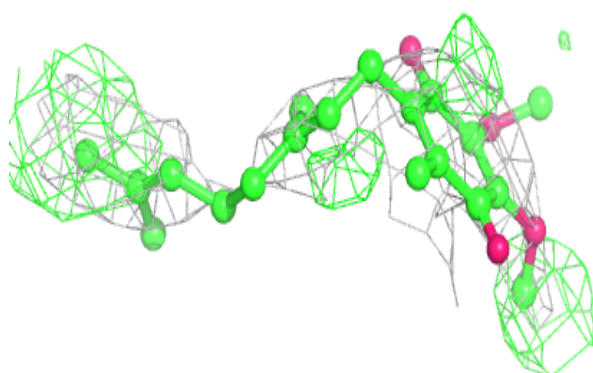
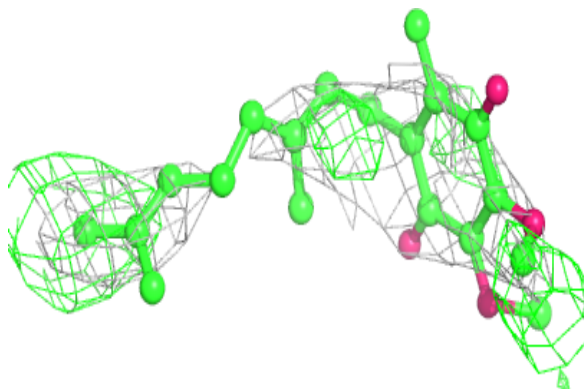

Electron density around FAD B 601:

$2mF_o-DF_c$ (at 0.7 rmsd) in gray
 mF_o-DF_c (at 3 rmsd) in purple (negative)
and green (positive)

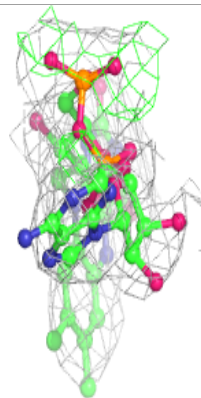
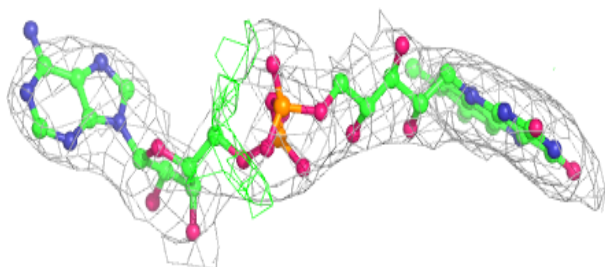
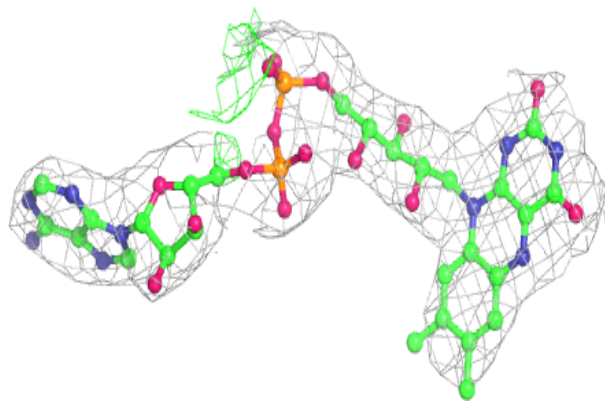
**Electron density around FAD A 601:**

$2mF_o-DF_c$ (at 0.7 rmsd) in gray
 mF_o-DF_c (at 3 rmsd) in purple (negative)
and green (positive)

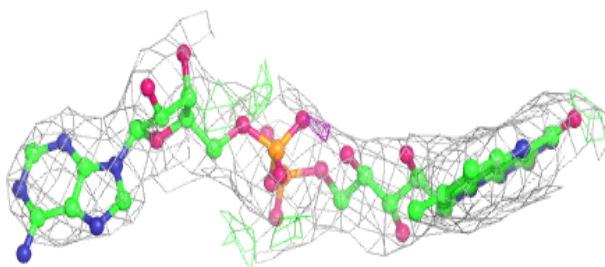
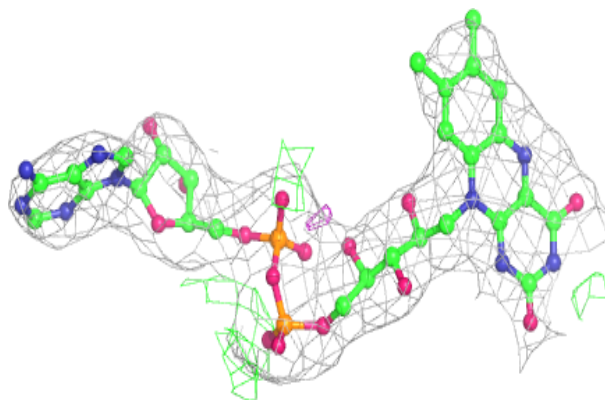

6.5 Other polymers

There are no such residues in this entry.