



Full wwPDB X-ray Structure Validation Report ⓘ

Mar 27, 2023 – 03:07 PM EDT

PDB ID : 8FM0
Title : HIV-1 gp120 complex with CJF-III-214
Authors : Gong, Z.; Hendrickson, W.A.
Deposited on : 2022-12-22
Resolution : 2.08 Å(reported)

This is a Full wwPDB X-ray Structure Validation Report for a publicly released PDB entry.

We welcome your comments at validation@mail.wwpdb.org

A user guide is available at

<https://www.wwpdb.org/validation/2017/XrayValidationReportHelp>

with specific help available everywhere you see the ⓘ symbol.

The types of validation reports are described at

<http://www.wwpdb.org/validation/2017/FAQs#types>.

The following versions of software and data (see [references ⓘ](#)) were used in the production of this report:

MolProbity : 4.02b-467
Mogul : 1.8.5 (274361), CSD as541be (2020)
Xtriage (Phenix) : 1.13
EDS : 2.32.2
buster-report : 1.1.7 (2018)
Percentile statistics : 20191225.v01 (using entries in the PDB archive December 25th 2019)
Refmac : 5.8.0158
CCP4 : 7.0.044 (Gargrove)
Ideal geometry (proteins) : Engh & Huber (2001)
Ideal geometry (DNA, RNA) : Parkinson et al. (1996)
Validation Pipeline (wwPDB-VP) : 2.32.2

1 Overall quality at a glance

The following experimental techniques were used to determine the structure:

X-RAY DIFFRACTION

The reported resolution of this entry is 2.08 Å.

Percentile scores (ranging between 0-100) for global validation metrics of the entry are shown in the following graphic. The table shows the number of entries on which the scores are based.

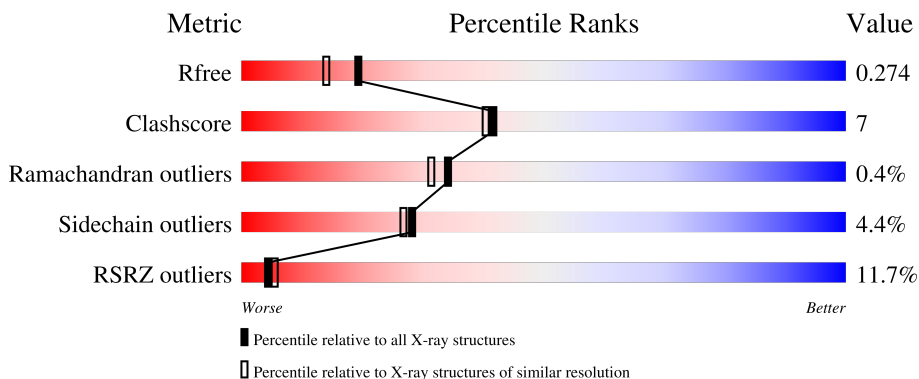

Metric	Whole archive (#Entries)	Similar resolution (#Entries, resolution range(Å))
R_{free}	130704	6189 (2.10-2.06)
Clashscore	141614	6738 (2.10-2.06)
Ramachandran outliers	138981	6663 (2.10-2.06)
Sidechain outliers	138945	6664 (2.10-2.06)
RSRZ outliers	127900	6057 (2.10-2.06)

The table below summarises the geometric issues observed across the polymeric chains and their fit to the electron density. The red, orange, yellow and green segments of the lower bar indicate the fraction of residues that contain outliers for ≥ 3 , 2, 1 and 0 types of geometric quality criteria respectively. A grey segment represents the fraction of residues that are not modelled. The numeric value for each fraction is indicated below the corresponding segment, with a dot representing fractions $\leq 5\%$. The upper red bar (where present) indicates the fraction of residues that have poor fit to the electron density. The numeric value is given above the bar.

Mol	Chain	Length	Quality of chain
1	A	358	
1	B	358	
1	C	358	
1	D	358	

The following table lists non-polymeric compounds, carbohydrate monomers and non-standard

residues in protein, DNA, RNA chains that are outliers for geometric or electron-density-fit criteria:

Mol	Type	Chain	Res	Chirality	Geometry	Clashes	Electron density
2	NAG	A	506	-	-	-	X
2	NAG	D	506	-	-	-	X

2 Entry composition [i](#)

There are 4 unique types of molecules in this entry. The entry contains 11208 atoms, of which 0 are hydrogens and 0 are deuteriums.

In the tables below, the ZeroOcc column contains the number of atoms modelled with zero occupancy, the AltConf column contains the number of residues with at least one atom in alternate conformation and the Trace column contains the number of residues modelled with at most 2 atoms.

- Molecule 1 is a protein called Envelope glycoprotein gp120.

Mol	Chain	Residues	Atoms					ZeroOcc	AltConf	Trace
			Total	C	N	O	S			
1	B	335	Total 2627	C 1642	N 459	O 506	S 20	0	0	0
1	A	335	Total 2627	C 1642	N 459	O 506	S 20	0	0	0
1	C	335	Total 2627	C 1642	N 459	O 506	S 20	0	0	0
1	D	335	Total 2627	C 1642	N 459	O 506	S 20	0	0	0

- Molecule 2 is 2-acetamido-2-deoxy-beta-D-glucopyranose (three-letter code: NAG) (formula: C₈H₁₅NO₆).

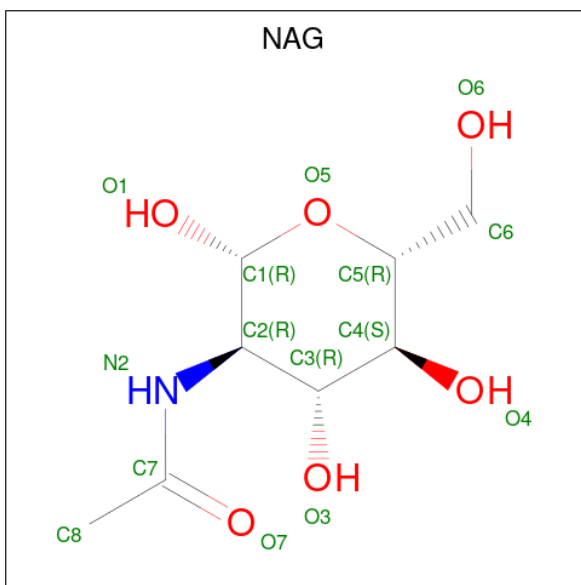

Mol	Chain	Residues	Atoms				ZeroOcc	AltConf
			Total	C	N	O		
2	B	1	Total 14	C 8	N 1	O 5	0	0
2	B	1	Total 14	C 8	N 1	O 5	0	0

Continued on next page...

Continued from previous page...

Mol	Chain	Residues	Atoms				ZeroOcc	AltConf
2	B	1	Total	C	N	O	0	0
			14	8	1	5		
2	B	1	Total	C	N	O	0	0
			14	8	1	5		
2	B	1	Total	C	N	O	0	0
			14	8	1	5		
2	B	1	Total	C	N	O	0	0
			14	8	1	5		
2	A	1	Total	C	N	O	0	0
			14	8	1	5		
2	A	1	Total	C	N	O	0	0
			14	8	1	5		
2	A	1	Total	C	N	O	0	0
			14	8	1	5		
2	A	1	Total	C	N	O	0	0
			14	8	1	5		
2	A	1	Total	C	N	O	0	0
			14	8	1	5		
2	A	1	Total	C	N	O	0	0
			14	8	1	5		
2	A	1	Total	C	N	O	0	0
			14	8	1	5		
2	C	1	Total	C	N	O	0	0
			14	8	1	5		
2	C	1	Total	C	N	O	0	0
			14	8	1	5		
2	C	1	Total	C	N	O	0	0
			14	8	1	5		
2	C	1	Total	C	N	O	0	0
			14	8	1	5		
2	C	1	Total	C	N	O	0	0
			14	8	1	5		
2	C	1	Total	C	N	O	0	0
			14	8	1	5		
2	D	1	Total	C	N	O	0	0
			14	8	1	5		
2	D	1	Total	C	N	O	0	0
			14	8	1	5		
2	D	1	Total	C	N	O	0	0
			14	8	1	5		

Continued on next page...

Continued from previous page...

Mol	Chain	Residues	Atoms				ZeroOcc	AltConf
2	D	1	Total	C	N	O	0	0
			14	8	1	5		
2	D	1	Total	C	N	O	0	0
			14	8	1	5		
2	D	1	Total	C	N	O	0	0
			14	8	1	5		

- Molecule 3 is methyl (2R,3S)-2-(carbamimidamidomethyl)-3-[2-(4-chloro-3-fluoroanilino)(oxo)acetamido]-6-[(methylamino)methyl]-2,3-dihydro-1H-indole-1-carboxylate (three-letter code: Y1O) (formula: C₂₂H₂₅ClFN₇O₄) (labeled as "Ligand of Interest" by depositor).

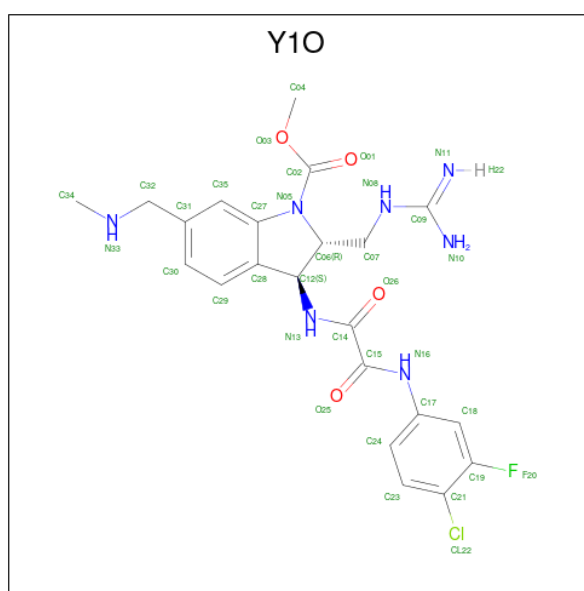

Mol	Chain	Residues	Atoms					ZeroOcc	AltConf	
3	B	1	Total	C	Cl	F	N	O	0	0
			35	22	1	1	7	4		
3	A	1	Total	C	Cl	F	N	O	0	0
			35	22	1	1	7	4		
3	C	1	Total	C	Cl	F	N	O	0	0
			35	22	1	1	7	4		
3	D	1	Total	C	Cl	F	N	O	0	0
			35	22	1	1	7	4		

- Molecule 4 is water.

Mol	Chain	Residues	Atoms		ZeroOcc	AltConf
4	B	43	Total	O	0	0
			43	43		

Continued on next page...

Continued from previous page...

Mol	Chain	Residues	Atoms		ZeroOcc	AltConf
4	A	40	Total 40	O 40	0	0
4	C	55	Total 55	O 55	0	0
4	D	58	Total 58	O 58	0	0

3 Residue-property plots [i](#)

These plots are drawn for all protein, RNA, DNA and oligosaccharide chains in the entry. The first graphic for a chain summarises the proportions of the various outlier classes displayed in the second graphic. The second graphic shows the sequence view annotated by issues in geometry and electron density. Residues are color-coded according to the number of geometric quality criteria for which they contain at least one outlier: green = 0, yellow = 1, orange = 2 and red = 3 or more. A red dot above a residue indicates a poor fit to the electron density ($RSRZ > 2$). Stretches of 2 or more consecutive residues without any outlier are shown as a green connector. Residues present in the sample, but not in the model, are shown in grey.

- Molecule 1: Envelope glycoprotein gp120

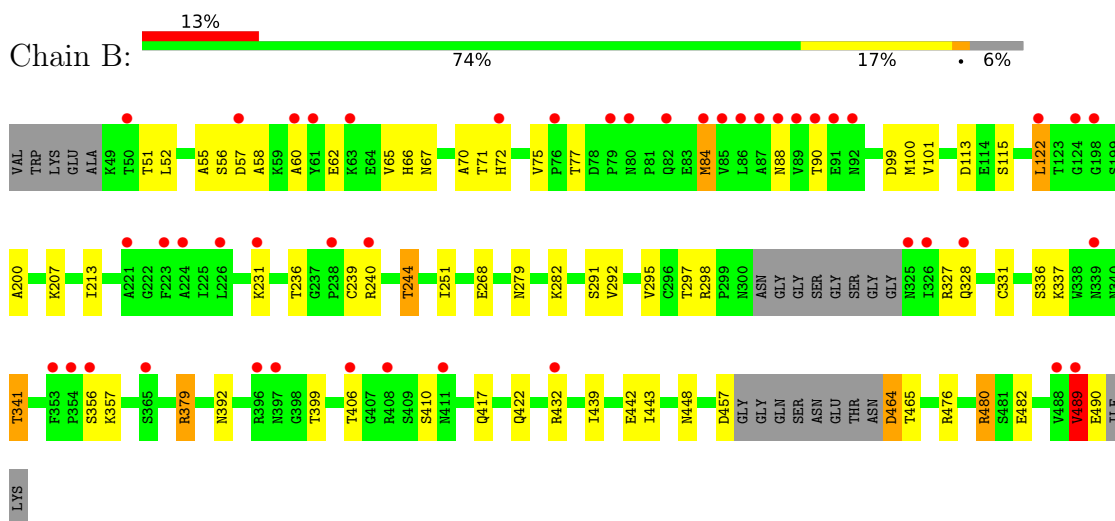

- Molecule 1: Envelope glycoprotein gp120

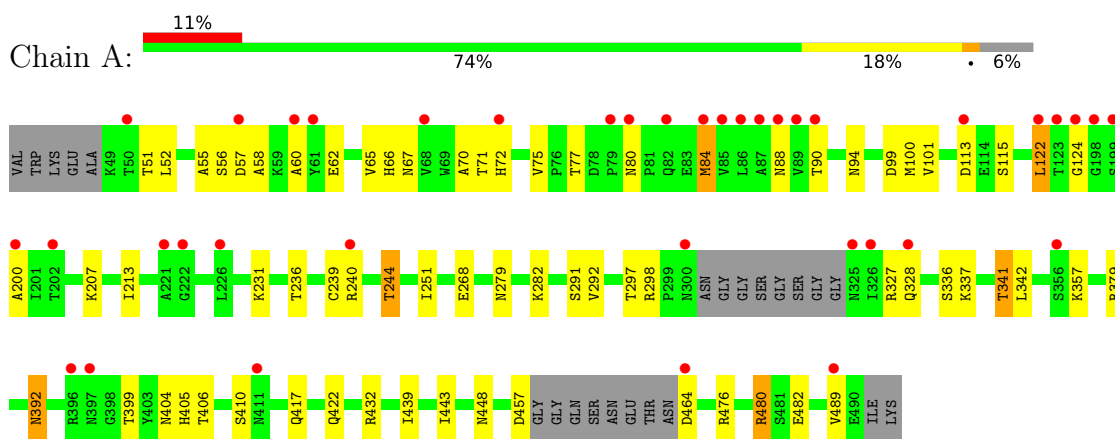

- Molecule 1: Envelope glycoprotein gp120

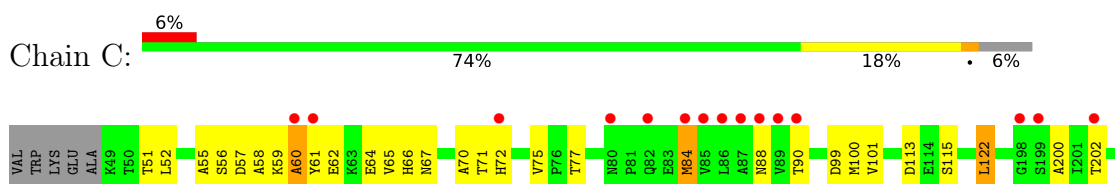

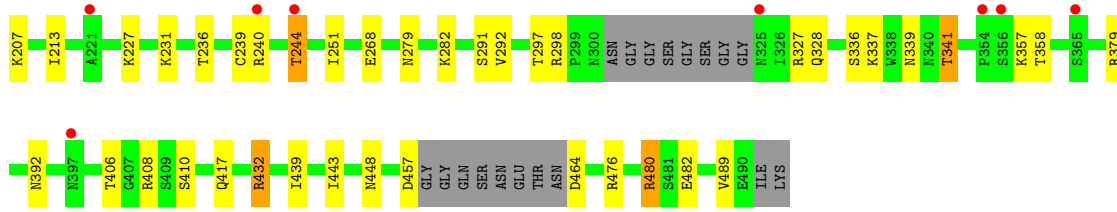

● Molecule 1: Envelope glycoprotein gp120

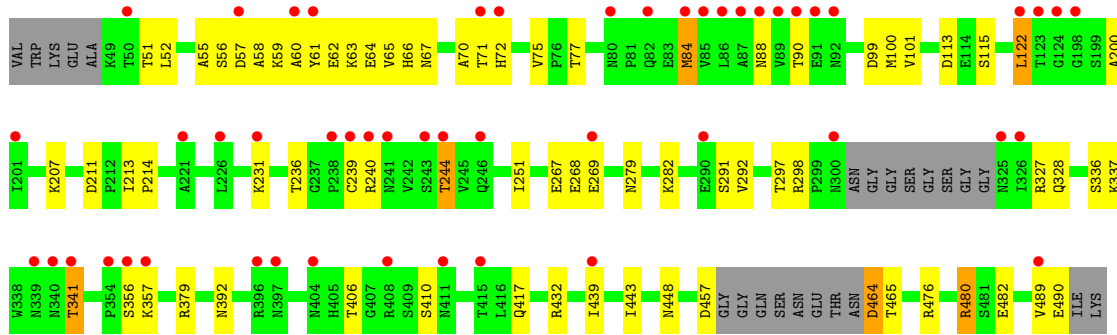
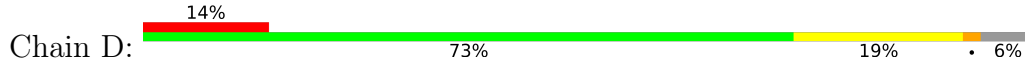

4 Data and refinement statistics

Property	Value	Source
Space group	P 21 21 21	Depositor
Cell constants a, b, c, α , β , γ	71.80Å 120.89Å 195.16Å 90.00° 90.00° 90.00°	Depositor
Resolution (Å)	48.79 – 2.08 48.79 – 2.08	Depositor EDS
% Data completeness (in resolution range)	70.8 (48.79-2.08) 70.8 (48.79-2.08)	Depositor EDS
R_{merge}	0.14	Depositor
R_{sym}	(Not available)	Depositor
$\langle I/\sigma(I) \rangle$ ¹	1.54 (at 2.08Å)	Xtrriage
Refinement program	PHENIX 1.20rc3_4406	Depositor
R, R_{free}	0.253 , 0.273 0.251 , 0.274	Depositor DCC
R_{free} test set	2000 reflections (2.75%)	wwPDB-VP
Wilson B-factor (Å ²)	35.9	Xtrriage
Anisotropy	0.054	Xtrriage
Bulk solvent k_{sol} (e/Å ³), B_{sol} (Å ²)	0.36 , 39.5	EDS
L-test for twinning ²	$\langle L \rangle = 0.50$, $\langle L^2 \rangle = 0.34$	Xtrriage
Estimated twinning fraction	No twinning to report.	Xtrriage
F_o, F_c correlation	0.92	EDS
Total number of atoms	11208	wwPDB-VP
Average B, all atoms (Å ²)	44.0	wwPDB-VP

Xtrriage's analysis on translational NCS is as follows: *The largest off-origin peak in the Patterson function is 16.49% of the height of the origin peak. No significant pseudotranslation is detected.*

¹Intensities estimated from amplitudes.

²Theoretical values of $\langle |L| \rangle$, $\langle L^2 \rangle$ for acentric reflections are 0.5, 0.333 respectively for untwinned datasets, and 0.375, 0.2 for perfectly twinned datasets.

5 Model quality [i](#)

5.1 Standard geometry [i](#)

Bond lengths and bond angles in the following residue types are not validated in this section: Y1O, NAG

The Z score for a bond length (or angle) is the number of standard deviations the observed value is removed from the expected value. A bond length (or angle) with $|Z| > 5$ is considered an outlier worth inspection. RMSZ is the root-mean-square of all Z scores of the bond lengths (or angles).

Mol	Chain	Bond lengths		Bond angles	
		RMSZ	# Z >5	RMSZ	# Z >5
1	A	0.49	1/2682 (0.0%)	0.83	6/3640 (0.2%)
1	B	0.49	1/2682 (0.0%)	0.83	6/3640 (0.2%)
1	C	0.49	1/2682 (0.0%)	0.83	6/3640 (0.2%)
1	D	0.49	1/2682 (0.0%)	0.83	6/3640 (0.2%)
All	All	0.49	4/10728 (0.0%)	0.83	24/14560 (0.2%)

Chiral center outliers are detected by calculating the chiral volume of a chiral center and verifying if the center is modelled as a planar moiety or with the opposite hand. A planarity outlier is detected by checking planarity of atoms in a peptide group, atoms in a mainchain group or atoms of a sidechain that are expected to be planar.

Mol	Chain	#Chirality outliers	#Planarity outliers
1	A	0	5
1	B	0	5
1	C	0	5
1	D	0	5
All	All	0	20

All (4) bond length outliers are listed below:

Mol	Chain	Res	Type	Atoms	Z	Observed(Å)	Ideal(Å)
1	C	244	THR	CB-CG2	-6.41	1.31	1.52
1	A	244	THR	CB-CG2	-6.40	1.31	1.52
1	D	244	THR	CB-CG2	-6.38	1.31	1.52
1	B	244	THR	CB-CG2	-6.36	1.31	1.52

All (24) bond angle outliers are listed below:

Mol	Chain	Res	Type	Atoms	Z	Observed(°)	Ideal(°)
1	B	122	LEU	CB-CG-CD2	-12.91	89.06	111.00

Continued on next page...

Continued from previous page...

Mol	Chain	Res	Type	Atoms	Z	Observed(°)	Ideal(°)
1	D	122	LEU	CB-CG-CD2	-12.90	89.07	111.00
1	C	122	LEU	CB-CG-CD2	-12.89	89.08	111.00
1	A	122	LEU	CB-CG-CD2	-12.89	89.09	111.00
1	D	122	LEU	CB-CG-CD1	8.92	126.16	111.00
1	C	122	LEU	CB-CG-CD1	8.91	126.15	111.00
1	A	122	LEU	CB-CG-CD1	8.91	126.14	111.00
1	B	122	LEU	CB-CG-CD1	8.89	126.12	111.00
1	D	84	MET	CB-CG-SD	-8.39	87.22	112.40
1	A	84	MET	CB-CG-SD	-8.39	87.23	112.40
1	B	84	MET	CB-CG-SD	-8.38	87.27	112.40
1	C	84	MET	CB-CG-SD	-8.37	87.28	112.40
1	D	489	VAL	CG1-CB-CG2	5.86	120.27	110.90
1	A	489	VAL	CG1-CB-CG2	5.84	120.24	110.90
1	C	489	VAL	CG1-CB-CG2	5.83	120.24	110.90
1	B	489	VAL	CG1-CB-CG2	5.79	120.17	110.90
1	C	84	MET	CA-CB-CG	5.35	122.40	113.30
1	B	84	MET	CA-CB-CG	5.34	122.38	113.30
1	A	84	MET	CA-CB-CG	5.33	122.36	113.30
1	D	84	MET	CA-CB-CG	5.31	122.33	113.30
1	C	99	ASP	CB-CG-OD1	5.29	123.06	118.30
1	A	99	ASP	CB-CG-OD1	5.28	123.05	118.30
1	B	99	ASP	CB-CG-OD1	5.27	123.04	118.30
1	D	99	ASP	CB-CG-OD1	5.26	123.04	118.30

There are no chirality outliers.

All (20) planarity outliers are listed below:

Mol	Chain	Res	Type	Group
1	A	327	ARG	Sidechain
1	A	379	ARG	Sidechain
1	A	432	ARG	Sidechain
1	A	480	ARG	Sidechain
1	A	88	ASN	Peptide
1	B	327	ARG	Sidechain
1	B	379	ARG	Sidechain
1	B	432	ARG	Sidechain
1	B	480	ARG	Sidechain
1	B	88	ASN	Peptide
1	C	327	ARG	Sidechain
1	C	379	ARG	Sidechain
1	C	432	ARG	Sidechain
1	C	480	ARG	Sidechain

Continued on next page...

Continued from previous page...

Mol	Chain	Res	Type	Group
1	C	88	ASN	Peptide
1	D	327	ARG	Sidechain
1	D	379	ARG	Sidechain
1	D	432	ARG	Sidechain
1	D	480	ARG	Sidechain
1	D	88	ASN	Peptide

5.2 Too-close contacts [i](#)

In the following table, the Non-H and H(model) columns list the number of non-hydrogen atoms and hydrogen atoms in the chain respectively. The H(added) column lists the number of hydrogen atoms added and optimized by MolProbity. The Clashes column lists the number of clashes within the asymmetric unit, whereas Symm-Clashes lists symmetry-related clashes.

Mol	Chain	Non-H	H(model)	H(added)	Clashes	Symm-Clashes
1	A	2627	0	2540	34	2
1	B	2627	0	2542	33	2
1	C	2627	0	2540	44	0
1	D	2627	0	2542	43	1
2	A	98	0	91	3	0
2	B	84	0	78	2	0
2	C	98	0	91	5	0
2	D	84	0	78	3	1
3	A	35	0	0	0	0
3	B	35	0	0	0	0
3	C	35	0	0	0	0
3	D	35	0	0	0	0
4	A	40	0	0	3	0
4	B	43	0	0	1	0
4	C	55	0	0	1	0
4	D	58	0	0	3	0
All	All	11208	0	10502	151	3

The all-atom clashscore is defined as the number of clashes found per 1000 atoms (including hydrogen atoms). The all-atom clashscore for this structure is 7.

All (151) close contacts within the same asymmetric unit are listed below, sorted by their clash magnitude.

Atom-1	Atom-2	Interatomic distance (Å)	Clash overlap (Å)
1:C:60:ALA:O	1:D:59:LYS:HE3	1.60	1.02

Continued on next page...

Continued from previous page...

Atom-1	Atom-2	Interatomic distance (Å)	Clash overlap (Å)
1:C:59:LYS:NZ	1:D:211:ASP:OD2	2.03	0.92
1:A:124:GLY:O	4:A:601:HOH:O	1.88	0.90
1:C:60:ALA:C	1:D:59:LYS:HE3	1.90	0.90
1:D:267:GLU:O	4:D:601:HOH:O	1.89	0.89
1:D:448:ASN:ND2	4:D:602:HOH:O	1.97	0.86
1:A:422:GLN:NE2	4:A:602:HOH:O	2.08	0.85
1:A:404:ASN:ND2	1:C:408:ARG:HA	1.93	0.83
1:B:489:VAL:HG22	1:B:490:GLU:HB2	1.67	0.74
1:D:84:MET:SD	1:D:244:THR:CG2	2.78	0.72
1:A:84:MET:SD	1:A:244:THR:CG2	2.78	0.72
1:C:84:MET:SD	1:C:244:THR:CG2	2.78	0.72
1:B:84:MET:SD	1:B:244:THR:CG2	2.78	0.71
1:C:60:ALA:HB2	1:D:61:TYR:CZ	2.26	0.71
1:C:60:ALA:HB2	1:D:61:TYR:OH	1.91	0.69
1:C:337:LYS:O	1:C:341:THR:HG23	1.96	0.66
1:A:337:LYS:O	1:A:341:THR:HG23	1.96	0.65
1:D:337:LYS:O	1:D:341:THR:HG23	1.96	0.65
1:B:337:LYS:O	1:B:341:THR:HG23	1.96	0.65
1:A:231:LYS:HG3	1:A:268:GLU:OE2	1.97	0.65
2:C:503:NAG:H3	2:C:503:NAG:H83	1.79	0.65
1:B:231:LYS:HG3	1:B:268:GLU:OE2	1.97	0.64
2:D:503:NAG:H83	2:D:503:NAG:H3	1.79	0.64
1:D:231:LYS:HG3	1:D:268:GLU:OE2	1.97	0.64
1:D:67:ASN:O	1:D:71:THR:OG1	2.16	0.63
2:A:503:NAG:H83	2:A:503:NAG:H3	1.79	0.63
1:C:67:ASN:O	1:C:71:THR:OG1	2.16	0.63
2:B:503:NAG:H83	2:B:503:NAG:H3	1.79	0.63
1:C:231:LYS:HG3	1:C:268:GLU:OE2	1.97	0.63
1:A:67:ASN:O	1:A:71:THR:OG1	2.16	0.62
1:B:67:ASN:O	1:B:71:THR:OG1	2.16	0.61
1:C:339:ASN:ND2	2:C:508:NAG:H83	2.16	0.61
1:A:251:ILE:HG23	1:A:482:GLU:HG3	1.88	0.56
1:B:251:ILE:HG23	1:B:482:GLU:HG3	1.88	0.56
1:D:490:GLU:O	4:D:603:HOH:O	2.18	0.56
1:D:251:ILE:HG23	1:D:482:GLU:HG3	1.88	0.55
1:A:480:ARG:NH1	4:A:605:HOH:O	2.39	0.55
1:C:251:ILE:HG23	1:C:482:GLU:HG3	1.88	0.54
1:B:90:THR:HA	1:B:239:CYS:O	2.07	0.54
1:D:90:THR:HA	1:D:239:CYS:O	2.07	0.54
1:D:392:ASN:OD1	1:D:406:THR:HB	2.08	0.54
1:A:84:MET:SD	1:A:244:THR:HG22	2.48	0.54

Continued on next page...

Continued from previous page...

Atom-1	Atom-2	Interatomic distance (Å)	Clash overlap (Å)
1:A:90:THR:HA	1:A:239:CYS:O	2.07	0.54
1:A:404:ASN:HD22	1:C:408:ARG:HA	1.73	0.54
1:B:84:MET:SD	1:B:244:THR:HG22	2.48	0.54
1:A:392:ASN:OD1	1:A:406:THR:HB	2.08	0.54
1:C:84:MET:SD	1:C:244:THR:HG22	2.48	0.53
1:C:90:THR:HA	1:C:239:CYS:O	2.07	0.53
1:B:392:ASN:OD1	1:B:406:THR:HB	2.08	0.53
2:B:503:NAG:H3	2:B:503:NAG:C8	2.39	0.53
1:C:417:GLN:HA	1:C:417:GLN:OE1	2.09	0.53
2:C:503:NAG:H3	2:C:503:NAG:C8	2.39	0.53
1:D:84:MET:SD	1:D:244:THR:HG22	2.48	0.53
1:B:417:GLN:HA	1:B:417:GLN:OE1	2.09	0.53
1:B:422:GLN:HG2	1:C:432:ARG:NH2	2.24	0.53
1:C:392:ASN:OD1	1:C:406:THR:HB	2.08	0.53
1:D:417:GLN:HA	1:D:417:GLN:OE1	2.09	0.53
1:B:476:ARG:O	1:B:480:ARG:HG3	2.09	0.52
1:C:476:ARG:O	1:C:480:ARG:HG3	2.09	0.52
1:D:84:MET:SD	1:D:244:THR:HG21	2.49	0.52
1:D:476:ARG:O	1:D:480:ARG:HG3	2.09	0.52
2:D:503:NAG:H3	2:D:503:NAG:C8	2.39	0.52
2:A:503:NAG:H3	2:A:503:NAG:C8	2.39	0.52
1:A:476:ARG:O	1:A:480:ARG:HG3	2.09	0.52
1:B:84:MET:SD	1:B:244:THR:HG21	2.49	0.52
1:A:84:MET:SD	1:A:244:THR:HG21	2.49	0.52
1:B:101:VAL:HG12	1:B:476:ARG:HG2	1.93	0.51
1:A:101:VAL:HG12	1:A:476:ARG:HG2	1.92	0.51
1:C:60:ALA:CB	1:D:61:TYR:OH	2.58	0.51
1:C:84:MET:SD	1:C:244:THR:HG21	2.49	0.51
1:A:417:GLN:HA	1:A:417:GLN:OE1	2.09	0.51
1:C:101:VAL:HG12	1:C:476:ARG:HG2	1.92	0.51
1:A:292:VAL:CG2	1:A:341:THR:HG21	2.41	0.50
1:D:101:VAL:HG12	1:D:476:ARG:HG2	1.92	0.50
1:D:292:VAL:CG2	1:D:341:THR:HG21	2.42	0.50
1:B:122:LEU:HD12	1:B:200:ALA:HB2	1.93	0.50
1:C:292:VAL:CG2	1:C:341:THR:HG21	2.41	0.50
1:D:122:LEU:HD12	1:D:200:ALA:HB2	1.93	0.50
1:C:122:LEU:HD12	1:C:200:ALA:HB2	1.94	0.50
1:A:122:LEU:HD12	1:A:200:ALA:HB2	1.93	0.50
1:B:298:ARG:HG2	1:B:328:GLN:O	2.13	0.49
1:B:292:VAL:CG2	1:B:341:THR:HG21	2.41	0.49
1:D:207:LYS:HD2	1:D:439:ILE:HG23	1.94	0.49

Continued on next page...

Continued from previous page...

Atom-1	Atom-2	Interatomic distance (Å)	Clash overlap (Å)
1:D:298:ARG:HG2	1:D:328:GLN:O	2.13	0.49
1:B:207:LYS:HD2	1:B:439:ILE:HG23	1.94	0.49
1:A:207:LYS:HD2	1:A:439:ILE:HG23	1.94	0.49
1:A:298:ARG:HG2	1:A:328:GLN:O	2.13	0.49
1:B:422:GLN:HG2	1:C:432:ARG:HH22	1.78	0.48
1:C:298:ARG:HG2	1:C:328:GLN:O	2.13	0.48
1:C:207:LYS:HD2	1:C:439:ILE:HG23	1.94	0.48
1:B:279:ASN:OD1	1:B:282:LYS:HG2	2.14	0.47
1:C:227:LYS:HE2	4:C:649:HOH:O	2.14	0.47
1:B:58:ALA:HB2	1:B:70:ALA:HB3	1.97	0.47
1:A:279:ASN:OD1	1:A:282:LYS:HG2	2.15	0.47
1:D:279:ASN:OD1	1:D:282:LYS:HG2	2.14	0.47
1:D:58:ALA:HB2	1:D:70:ALA:HB3	1.97	0.47
1:C:60:ALA:CA	1:D:61:TYR:OH	2.63	0.47
1:C:279:ASN:OD1	1:C:282:LYS:HG2	2.14	0.46
1:B:291:SER:HB2	1:B:448:ASN:HB3	1.98	0.46
1:D:291:SER:HB2	1:D:448:ASN:HB3	1.98	0.46
1:A:55:ALA:HA	1:A:75:VAL:O	2.16	0.46
1:C:60:ALA:O	1:D:59:LYS:CE	2.49	0.46
1:C:291:SER:HB2	1:C:448:ASN:HB3	1.97	0.46
1:D:55:ALA:HA	1:D:75:VAL:O	2.16	0.46
1:A:58:ALA:HB2	1:A:70:ALA:HB3	1.97	0.45
1:C:58:ALA:HB2	1:C:70:ALA:HB3	1.97	0.45
1:B:55:ALA:HA	1:B:75:VAL:O	2.16	0.45
1:A:56:SER:C	1:A:77:THR:HG23	2.37	0.45
1:C:56:SER:C	1:C:77:THR:HG23	2.37	0.45
1:A:52:LEU:HD11	1:A:100:MET:HG2	1.99	0.45
1:A:291:SER:HB2	1:A:448:ASN:HB3	1.98	0.45
1:D:292:VAL:HG21	1:D:341:THR:HG21	1.99	0.45
1:C:292:VAL:HG21	1:C:341:THR:HG21	1.99	0.45
1:C:52:LEU:HD11	1:C:100:MET:HG2	1.99	0.45
1:D:56:SER:C	1:D:77:THR:HG23	2.37	0.45
1:B:292:VAL:HG21	1:B:341:THR:HG21	1.99	0.44
1:C:55:ALA:HA	1:C:75:VAL:O	2.16	0.44
1:B:56:SER:C	1:B:77:THR:HG23	2.37	0.44
1:D:52:LEU:HD11	1:D:100:MET:HG2	1.99	0.44
1:A:292:VAL:HG21	1:A:341:THR:HG21	1.99	0.43
1:D:62:GLU:OE2	1:D:64:GLU:HB2	2.18	0.43
1:A:90:THR:HA	1:A:240:ARG:HA	2.01	0.43
1:D:90:THR:HA	1:D:240:ARG:HA	2.01	0.43
1:B:52:LEU:HD11	1:B:100:MET:HG2	1.99	0.43

Continued on next page...

Continued from previous page...

Atom-1	Atom-2	Interatomic distance (Å)	Clash overlap (Å)
1:C:62:GLU:OE2	1:C:64:GLU:HB2	2.18	0.43
2:D:503:NAG:H83	2:D:503:NAG:C3	2.48	0.43
1:C:60:ALA:CB	1:D:61:TYR:CZ	2.98	0.42
1:D:269:GLU:H	1:D:269:GLU:HG2	1.52	0.42
1:C:90:THR:HA	1:C:240:ARG:HA	2.01	0.42
1:B:90:THR:HA	1:B:240:ARG:HA	2.01	0.42
1:B:65:VAL:HB	1:B:115:SER:HB3	2.02	0.42
1:D:464:ASP:HB3	1:D:465:THR:H	1.26	0.42
1:A:405:HIS:H	2:A:508:NAG:H81	1.84	0.42
1:C:297:THR:HA	1:C:443:ILE:O	2.20	0.42
1:C:65:VAL:HB	1:C:115:SER:HB3	2.02	0.41
1:D:297:THR:HA	1:D:443:ILE:O	2.20	0.41
1:A:65:VAL:HB	1:A:115:SER:HB3	2.02	0.41
1:A:297:THR:HA	1:A:443:ILE:O	2.20	0.41
1:B:464:ASP:HB3	1:B:465:THR:H	1.26	0.41
2:C:503:NAG:H83	2:C:503:NAG:C3	2.48	0.41
1:B:379:ARG:NH2	4:B:603:HOH:O	2.53	0.41
1:A:66:HIS:HB3	1:A:213:ILE:HG12	2.03	0.41
1:D:65:VAL:HB	1:D:115:SER:HB3	2.02	0.41
1:C:61:TYR:CE2	1:D:214:PRO:CD	3.04	0.41
1:C:66:HIS:HB3	1:C:213:ILE:HG12	2.03	0.41
1:A:342:LEU:HD23	1:A:342:LEU:HA	1.78	0.41
2:C:503:NAG:C8	2:C:503:NAG:C3	2.99	0.41
1:B:297:THR:HA	1:B:443:ILE:O	2.20	0.40
1:D:66:HIS:HB3	1:D:213:ILE:HG12	2.03	0.40
1:B:66:HIS:HB3	1:B:213:ILE:HG12	2.02	0.40
1:B:295:VAL:O	1:B:331:CYS:HA	2.22	0.40

All (3) symmetry-related close contacts are listed below. The label for Atom-2 includes the symmetry operator and encoded unit-cell translations to be applied.

Atom-1	Atom-2	Interatomic distance (Å)	Clash overlap (Å)
1:B:442:GLU:OE1	1:A:80:ASN:ND2[3_444]	1.58	0.62
1:A:94:ASN:ND2	2:D:506:NAG:O3[3_444]	2.10	0.10
1:B:356:SER:OG	1:D:356:SER:OG[3_444]	2.13	0.07

5.3 Torsion angles [i](#)

5.3.1 Protein backbone [i](#)

In the following table, the Percentiles column shows the percent Ramachandran outliers of the chain as a percentile score with respect to all X-ray entries followed by that with respect to entries of similar resolution.

The Analysed column shows the number of residues for which the backbone conformation was analysed, and the total number of residues.

Mol	Chain	Analysed	Favoured	Allowed	Outliers	Percentiles	
1	A	329/358 (92%)	308 (94%)	19 (6%)	2 (1%)	25	20
1	B	329/358 (92%)	308 (94%)	20 (6%)	1 (0%)	41	39
1	C	329/358 (92%)	308 (94%)	20 (6%)	1 (0%)	41	39
1	D	329/358 (92%)	308 (94%)	20 (6%)	1 (0%)	41	39
All	All	1316/1432 (92%)	1232 (94%)	79 (6%)	5 (0%)	34	31

All (5) Ramachandran outliers are listed below:

Mol	Chain	Res	Type
1	B	60	ALA
1	A	60	ALA
1	C	60	ALA
1	D	60	ALA
1	A	392	ASN

5.3.2 Protein sidechains [i](#)

In the following table, the Percentiles column shows the percent sidechain outliers of the chain as a percentile score with respect to all X-ray entries followed by that with respect to entries of similar resolution.

The Analysed column shows the number of residues for which the sidechain conformation was analysed, and the total number of residues.

Mol	Chain	Analysed	Rotameric	Outliers	Percentiles	
1	A	297/312 (95%)	284 (96%)	13 (4%)	28	27
1	B	297/312 (95%)	283 (95%)	14 (5%)	26	24
1	C	297/312 (95%)	284 (96%)	13 (4%)	28	27
1	D	297/312 (95%)	285 (96%)	12 (4%)	31	31
All	All	1188/1248 (95%)	1136 (96%)	52 (4%)	28	27

All (52) residues with a non-rotameric sidechain are listed below:

Mol	Chain	Res	Type
1	B	51	THR
1	B	57	ASP
1	B	62	GLU
1	B	72	HIS
1	B	113	ASP
1	B	236	THR
1	B	336	SER
1	B	341	THR
1	B	357	LYS
1	B	399	THR
1	B	410	SER
1	B	457	ASP
1	B	464	ASP
1	B	489	VAL
1	A	51	THR
1	A	57	ASP
1	A	62	GLU
1	A	72	HIS
1	A	113	ASP
1	A	236	THR
1	A	336	SER
1	A	341	THR
1	A	357	LYS
1	A	399	THR
1	A	410	SER
1	A	457	ASP
1	A	464	ASP
1	C	51	THR
1	C	57	ASP
1	C	72	HIS
1	C	113	ASP
1	C	202	THR
1	C	236	THR
1	C	336	SER
1	C	341	THR
1	C	357	LYS
1	C	358	THR
1	C	410	SER
1	C	457	ASP
1	C	464	ASP
1	D	51	THR
1	D	57	ASP

Continued on next page...

Continued from previous page...

Mol	Chain	Res	Type
1	D	63	LYS
1	D	72	HIS
1	D	113	ASP
1	D	236	THR
1	D	336	SER
1	D	341	THR
1	D	357	LYS
1	D	410	SER
1	D	457	ASP
1	D	464	ASP

Sometimes sidechains can be flipped to improve hydrogen bonding and reduce clashes. All (5) such sidechains are listed below:

Mol	Chain	Res	Type
1	B	203	GLN
1	A	203	GLN
1	A	404	ASN
1	C	203	GLN
1	D	203	GLN

5.3.3 RNA [i](#)

There are no RNA molecules in this entry.

5.4 Non-standard residues in protein, DNA, RNA chains [i](#)

There are no non-standard protein/DNA/RNA residues in this entry.

5.5 Carbohydrates [i](#)

There are no monosaccharides in this entry.

5.6 Ligand geometry [i](#)

30 ligands are modelled in this entry.

In the following table, the Counts columns list the number of bonds (or angles) for which Mogul statistics could be retrieved, the number of bonds (or angles) that are observed in the model and the number of bonds (or angles) that are defined in the Chemical Component Dictionary. The

Link column lists molecule types, if any, to which the group is linked. The Z score for a bond length (or angle) is the number of standard deviations the observed value is removed from the expected value. A bond length (or angle) with $|Z| > 2$ is considered an outlier worth inspection. RMSZ is the root-mean-square of all Z scores of the bond lengths (or angles).

Mol	Type	Chain	Res	Link	Bond lengths			Bond angles		
					Counts	RMSZ	# Z > 2	Counts	RMSZ	# Z > 2
2	NAG	C	504	1	14,14,15	0.53	0	17,19,21	0.43	0
2	NAG	A	505	1	14,14,15	0.29	0	17,19,21	0.48	0
2	NAG	A	504	1	14,14,15	0.53	0	17,19,21	0.43	0
2	NAG	B	501	1	14,14,15	0.29	0	17,19,21	0.43	0
2	NAG	B	506	1	14,14,15	0.64	0	17,19,21	1.80	2 (11%)
2	NAG	D	505	1	14,14,15	0.29	0	17,19,21	0.48	0
3	Y1O	B	507	-	36,37,37	2.76	12 (33%)	46,52,52	2.23	15 (32%)
3	Y1O	D	507	-	36,37,37	2.76	12 (33%)	46,52,52	2.23	15 (32%)
2	NAG	B	502	1	14,14,15	0.54	0	17,19,21	0.82	1 (5%)
3	Y1O	A	507	-	36,37,37	2.76	12 (33%)	46,52,52	2.23	15 (32%)
2	NAG	A	508	1	14,14,15	0.35	0	17,19,21	0.87	1 (5%)
2	NAG	C	503	1	14,14,15	0.48	0	17,19,21	1.32	1 (5%)
2	NAG	C	501	1	14,14,15	0.29	0	17,19,21	0.43	0
2	NAG	C	505	1	14,14,15	0.29	0	17,19,21	0.48	0
2	NAG	C	506	1	14,14,15	0.64	0	17,19,21	1.80	2 (11%)
2	NAG	D	504	1	14,14,15	0.53	0	17,19,21	0.43	0
3	Y1O	C	507	-	36,37,37	2.76	12 (33%)	46,52,52	2.23	15 (32%)
2	NAG	D	503	1	14,14,15	0.48	0	17,19,21	1.32	1 (5%)
2	NAG	A	501	1	14,14,15	0.29	0	17,19,21	0.43	0
2	NAG	A	506	1	14,14,15	0.64	0	17,19,21	1.80	2 (11%)
2	NAG	D	502	1	14,14,15	0.54	0	17,19,21	0.83	1 (5%)
2	NAG	A	502	1	14,14,15	0.55	0	17,19,21	0.82	1 (5%)
2	NAG	C	502	1	14,14,15	0.54	0	17,19,21	0.82	1 (5%)
2	NAG	D	501	1	14,14,15	0.29	0	17,19,21	0.43	0
2	NAG	B	503	1	14,14,15	0.48	0	17,19,21	1.32	1 (5%)
2	NAG	B	505	1	14,14,15	0.29	0	17,19,21	0.48	0
2	NAG	D	506	1	14,14,15	0.64	0	17,19,21	1.80	2 (11%)
2	NAG	B	504	1	14,14,15	0.53	0	17,19,21	0.43	0
2	NAG	A	503	1	14,14,15	0.48	0	17,19,21	1.32	1 (5%)
2	NAG	C	508	1	14,14,15	0.94	1 (7%)	17,19,21	0.68	1 (5%)

In the following table, the Chirals column lists the number of chiral outliers, the number of chiral centers analysed, the number of these observed in the model and the number defined in the Chemical Component Dictionary. Similar counts are reported in the Torsion and Rings columns.

'-' means no outliers of that kind were identified.

Mol	Type	Chain	Res	Link	Chirals	Torsions	Rings
2	NAG	C	504	1	-	2/6/23/26	0/1/1/1
2	NAG	A	505	1	-	0/6/23/26	0/1/1/1
2	NAG	A	504	1	-	2/6/23/26	0/1/1/1
2	NAG	B	501	1	-	0/6/23/26	0/1/1/1
2	NAG	B	506	1	-	2/6/23/26	0/1/1/1
2	NAG	D	505	1	-	0/6/23/26	0/1/1/1
3	Y1O	B	507	-	-	1/25/42/42	0/3/3/3
3	Y1O	D	507	-	-	1/25/42/42	0/3/3/3
2	NAG	B	502	1	-	0/6/23/26	0/1/1/1
3	Y1O	A	507	-	-	1/25/42/42	0/3/3/3
2	NAG	A	508	1	-	2/6/23/26	0/1/1/1
2	NAG	C	503	1	-	5/6/23/26	0/1/1/1
2	NAG	C	501	1	-	0/6/23/26	0/1/1/1
2	NAG	C	505	1	-	0/6/23/26	0/1/1/1
2	NAG	C	506	1	-	2/6/23/26	0/1/1/1
2	NAG	D	504	1	-	2/6/23/26	0/1/1/1
3	Y1O	C	507	-	-	1/25/42/42	0/3/3/3
2	NAG	D	503	1	-	5/6/23/26	0/1/1/1
2	NAG	A	501	1	-	0/6/23/26	0/1/1/1
2	NAG	A	506	1	-	2/6/23/26	0/1/1/1
2	NAG	D	502	1	-	0/6/23/26	0/1/1/1
2	NAG	A	502	1	-	0/6/23/26	0/1/1/1
2	NAG	C	502	1	-	0/6/23/26	0/1/1/1
2	NAG	D	501	1	-	0/6/23/26	0/1/1/1
2	NAG	B	503	1	-	5/6/23/26	0/1/1/1
2	NAG	B	505	1	-	0/6/23/26	0/1/1/1
2	NAG	D	506	1	-	2/6/23/26	0/1/1/1
2	NAG	B	504	1	-	2/6/23/26	0/1/1/1
2	NAG	A	503	1	-	5/6/23/26	0/1/1/1
2	NAG	C	508	1	-	4/6/23/26	0/1/1/1

All (49) bond length outliers are listed below:

Mol	Chain	Res	Type	Atoms	Z	Observed(Å)	Ideal(Å)
3	D	507	Y1O	C28-C12	7.74	1.59	1.51
3	B	507	Y1O	C28-C12	7.74	1.59	1.51
3	A	507	Y1O	C28-C12	7.74	1.59	1.51
3	C	507	Y1O	C28-C12	7.74	1.59	1.51

Continued on next page...

Continued from previous page...

Mol	Chain	Res	Type	Atoms	Z	Observed(Å)	Ideal(Å)
3	C	507	Y1O	C09-N08	6.11	1.45	1.33
3	B	507	Y1O	C09-N08	6.11	1.45	1.33
3	A	507	Y1O	C09-N08	6.11	1.45	1.33
3	D	507	Y1O	C09-N08	6.11	1.45	1.33
3	D	507	Y1O	C02-N05	5.49	1.45	1.37
3	B	507	Y1O	C02-N05	5.49	1.45	1.37
3	A	507	Y1O	C02-N05	5.49	1.45	1.37
3	C	507	Y1O	C02-N05	5.49	1.45	1.37
3	D	507	Y1O	C14-N13	4.97	1.44	1.34
3	B	507	Y1O	C14-N13	4.97	1.44	1.34
3	C	507	Y1O	C14-N13	4.97	1.44	1.34
3	A	507	Y1O	C14-N13	4.97	1.44	1.34
3	A	507	Y1O	C06-N05	-4.94	1.42	1.48
3	D	507	Y1O	C06-N05	-4.94	1.42	1.48
3	C	507	Y1O	C06-N05	-4.94	1.42	1.48
3	B	507	Y1O	C06-N05	-4.94	1.42	1.48
3	A	507	Y1O	C15-N16	4.32	1.45	1.35
3	C	507	Y1O	C15-N16	4.32	1.45	1.35
3	D	507	Y1O	C15-N16	4.32	1.45	1.35
3	B	507	Y1O	C15-N16	4.32	1.45	1.35
3	C	507	Y1O	C12-N13	-4.16	1.38	1.46
3	A	507	Y1O	C12-N13	-4.16	1.38	1.46
3	D	507	Y1O	C12-N13	-4.16	1.38	1.46
3	B	507	Y1O	C12-N13	-4.16	1.38	1.46
3	B	507	Y1O	C12-C06	-3.62	1.51	1.55
3	C	507	Y1O	C12-C06	-3.61	1.51	1.55
3	D	507	Y1O	C12-C06	-3.61	1.51	1.55
3	A	507	Y1O	C12-C06	-3.61	1.51	1.55
2	C	508	NAG	O5-C1	3.09	1.48	1.43
3	A	507	Y1O	O03-C02	2.73	1.38	1.34
3	D	507	Y1O	O03-C02	2.73	1.38	1.34
3	C	507	Y1O	O03-C02	2.73	1.38	1.34
3	B	507	Y1O	O03-C02	2.73	1.38	1.34
3	A	507	Y1O	O26-C14	-2.72	1.18	1.23
3	D	507	Y1O	O26-C14	-2.71	1.18	1.23
3	B	507	Y1O	O26-C14	-2.71	1.18	1.23
3	C	507	Y1O	O26-C14	-2.71	1.18	1.23
3	A	507	Y1O	O25-C15	-2.44	1.18	1.23
3	D	507	Y1O	O25-C15	-2.44	1.19	1.23
3	B	507	Y1O	O25-C15	-2.44	1.19	1.23
3	C	507	Y1O	O25-C15	-2.43	1.19	1.23
3	D	507	Y1O	C09-N10	2.34	1.44	1.34

Continued on next page...

Continued from previous page...

Mol	Chain	Res	Type	Atoms	Z	Observed(Å)	Ideal(Å)
3	A	507	Y1O	C09-N10	2.34	1.44	1.34
3	B	507	Y1O	C09-N10	2.33	1.44	1.34
3	C	507	Y1O	C09-N10	2.33	1.44	1.34

All (78) bond angle outliers are listed below:

Mol	Chain	Res	Type	Atoms	Z	Observed(°)	Ideal(°)
3	B	507	Y1O	C06-C12-N13	-7.69	106.61	115.01
3	A	507	Y1O	C06-C12-N13	-7.69	106.61	115.01
3	D	507	Y1O	C06-C12-N13	-7.69	106.61	115.01
3	C	507	Y1O	C06-C12-N13	-7.68	106.61	115.01
2	A	506	NAG	C1-O5-C5	6.72	121.30	112.19
2	D	506	NAG	C1-O5-C5	6.72	121.30	112.19
2	B	506	NAG	C1-O5-C5	6.72	121.29	112.19
2	C	506	NAG	C1-O5-C5	6.72	121.29	112.19
3	A	507	Y1O	O03-C02-N05	5.56	119.26	111.04
3	C	507	Y1O	O03-C02-N05	5.56	119.26	111.04
3	B	507	Y1O	O03-C02-N05	5.56	119.26	111.04
3	D	507	Y1O	O03-C02-N05	5.56	119.26	111.04
2	A	503	NAG	C2-N2-C7	4.50	129.31	122.90
2	C	503	NAG	C2-N2-C7	4.50	129.31	122.90
2	B	503	NAG	C2-N2-C7	4.50	129.30	122.90
2	D	503	NAG	C2-N2-C7	4.49	129.30	122.90
3	B	507	Y1O	C28-C12-N13	-4.29	107.73	114.61
3	C	507	Y1O	C28-C12-N13	-4.28	107.73	114.61
3	D	507	Y1O	C28-C12-N13	-4.28	107.73	114.61
3	A	507	Y1O	C28-C12-N13	-4.28	107.74	114.61
3	C	507	Y1O	C14-C15-N16	3.64	118.07	112.31
3	B	507	Y1O	C14-C15-N16	3.64	118.06	112.31
3	D	507	Y1O	C14-C15-N16	3.64	118.06	112.31
3	A	507	Y1O	C14-C15-N16	3.64	118.06	112.31
3	A	507	Y1O	O03-C02-O01	-3.63	117.79	124.63
3	D	507	Y1O	O03-C02-O01	-3.63	117.80	124.63
3	C	507	Y1O	O03-C02-O01	-3.63	117.80	124.63
3	B	507	Y1O	O03-C02-O01	-3.63	117.80	124.63
3	C	507	Y1O	C04-O03-C02	-3.38	111.44	115.34
3	B	507	Y1O	C04-O03-C02	-3.37	111.44	115.34
3	D	507	Y1O	C04-O03-C02	-3.37	111.44	115.34
3	A	507	Y1O	C04-O03-C02	-3.37	111.44	115.34
3	A	507	Y1O	C17-N16-C15	-3.09	122.16	127.53
3	B	507	Y1O	C17-N16-C15	-3.09	122.17	127.53
3	C	507	Y1O	C17-N16-C15	-3.09	122.17	127.53

Continued on next page...

Continued from previous page...

Mol	Chain	Res	Type	Atoms	Z	Observed(°)	Ideal(°)
3	D	507	Y1O	C17-N16-C15	-3.09	122.17	127.53
2	A	508	NAG	C1-O5-C5	2.76	115.93	112.19
2	D	502	NAG	C1-O5-C5	2.70	115.85	112.19
2	A	502	NAG	C1-O5-C5	2.69	115.84	112.19
2	B	502	NAG	C1-O5-C5	2.69	115.84	112.19
2	C	502	NAG	C1-O5-C5	2.69	115.84	112.19
3	C	507	Y1O	C19-C21-CL22	-2.44	116.83	119.78
3	D	507	Y1O	C19-C21-CL22	-2.44	116.83	119.78
3	A	507	Y1O	C19-C21-CL22	-2.44	116.83	119.78
3	B	507	Y1O	C19-C21-CL22	-2.43	116.83	119.78
3	C	507	Y1O	C23-C21-C19	2.42	120.88	118.94
3	A	507	Y1O	C23-C21-C19	2.42	120.88	118.94
3	D	507	Y1O	C23-C21-C19	2.42	120.88	118.94
3	B	507	Y1O	C12-N13-C14	-2.41	118.43	122.32
3	B	507	Y1O	C23-C21-C19	2.41	120.88	118.94
3	D	507	Y1O	C12-N13-C14	-2.41	118.43	122.32
3	A	507	Y1O	C12-N13-C14	-2.41	118.43	122.32
3	C	507	Y1O	C12-N13-C14	-2.41	118.44	122.32
2	C	506	NAG	C3-C4-C5	2.32	114.39	110.24
2	D	506	NAG	C3-C4-C5	2.32	114.38	110.24
2	B	506	NAG	C3-C4-C5	2.32	114.38	110.24
2	A	506	NAG	C3-C4-C5	2.32	114.38	110.24
2	C	508	NAG	C1-O5-C5	2.23	115.22	112.19
3	A	507	Y1O	C35-C27-N05	2.16	132.20	128.50
3	A	507	Y1O	C28-C27-N05	-2.16	107.55	109.41
3	B	507	Y1O	C28-C27-N05	-2.16	107.55	109.41
3	C	507	Y1O	C28-C27-N05	-2.16	107.55	109.41
3	B	507	Y1O	C35-C27-N05	2.16	132.19	128.50
3	D	507	Y1O	C35-C27-N05	2.16	132.19	128.50
3	C	507	Y1O	C35-C27-N05	2.15	132.19	128.50
3	D	507	Y1O	C28-C27-N05	-2.15	107.55	109.41
3	D	507	Y1O	O25-C15-C14	-2.15	118.68	121.30
3	B	507	Y1O	O25-C15-C14	-2.15	118.68	121.30
3	A	507	Y1O	O25-C15-C14	-2.14	118.68	121.30
3	C	507	Y1O	O25-C15-C14	-2.14	118.68	121.30
3	B	507	Y1O	C31-C32-N33	-2.13	107.41	112.67
3	D	507	Y1O	C31-C32-N33	-2.13	107.41	112.67
3	C	507	Y1O	C31-C32-N33	-2.13	107.41	112.67
3	A	507	Y1O	C31-C32-N33	-2.13	107.41	112.67
3	C	507	Y1O	C15-C14-N13	2.07	118.69	113.73
3	D	507	Y1O	C15-C14-N13	2.07	118.69	113.73
3	B	507	Y1O	C15-C14-N13	2.07	118.69	113.73

Continued on next page...

Continued from previous page...

Mol	Chain	Res	Type	Atoms	Z	Observed(°)	Ideal(°)
3	A	507	Y1O	C15-C14-N13	2.07	118.69	113.73

There are no chirality outliers.

All (46) torsion outliers are listed below:

Mol	Chain	Res	Type	Atoms
2	B	503	NAG	O5-C5-C6-O6
2	A	503	NAG	O5-C5-C6-O6
2	C	503	NAG	O5-C5-C6-O6
2	D	503	NAG	O5-C5-C6-O6
2	B	503	NAG	C4-C5-C6-O6
2	A	503	NAG	C4-C5-C6-O6
2	C	503	NAG	C4-C5-C6-O6
2	D	503	NAG	C4-C5-C6-O6
2	B	504	NAG	O5-C5-C6-O6
2	A	504	NAG	O5-C5-C6-O6
2	C	504	NAG	O5-C5-C6-O6
2	D	504	NAG	O5-C5-C6-O6
2	B	504	NAG	C4-C5-C6-O6
2	A	504	NAG	C4-C5-C6-O6
2	C	504	NAG	C4-C5-C6-O6
2	D	504	NAG	C4-C5-C6-O6
2	B	503	NAG	C8-C7-N2-C2
2	B	503	NAG	O7-C7-N2-C2
2	A	503	NAG	C8-C7-N2-C2
2	A	503	NAG	O7-C7-N2-C2
2	A	508	NAG	C8-C7-N2-C2
2	A	508	NAG	O7-C7-N2-C2
2	C	503	NAG	C8-C7-N2-C2
2	C	503	NAG	O7-C7-N2-C2
2	C	508	NAG	C8-C7-N2-C2
2	C	508	NAG	O7-C7-N2-C2
2	D	503	NAG	C8-C7-N2-C2
2	D	503	NAG	O7-C7-N2-C2
2	B	506	NAG	C4-C5-C6-O6
2	A	506	NAG	C4-C5-C6-O6
2	C	506	NAG	C4-C5-C6-O6
2	D	506	NAG	C4-C5-C6-O6
2	C	508	NAG	C4-C5-C6-O6
2	B	503	NAG	C3-C2-N2-C7
2	A	503	NAG	C3-C2-N2-C7
2	C	503	NAG	C3-C2-N2-C7

Continued on next page...

Continued from previous page...

Mol	Chain	Res	Type	Atoms
2	D	503	NAG	C3-C2-N2-C7
3	B	507	Y1O	C06-C07-N08-C09
3	A	507	Y1O	C06-C07-N08-C09
3	C	507	Y1O	C06-C07-N08-C09
3	D	507	Y1O	C06-C07-N08-C09
2	B	506	NAG	O5-C5-C6-O6
2	A	506	NAG	O5-C5-C6-O6
2	C	506	NAG	O5-C5-C6-O6
2	C	508	NAG	O5-C5-C6-O6
2	D	506	NAG	O5-C5-C6-O6

There are no ring outliers.

7 monomers are involved in 14 short contacts:

Mol	Chain	Res	Type	Clashes	Symm-Clashes
2	A	508	NAG	1	0
2	C	503	NAG	4	0
2	D	503	NAG	3	0
2	B	503	NAG	2	0
2	D	506	NAG	0	1
2	A	503	NAG	2	0
2	C	508	NAG	1	0

The following is a two-dimensional graphical depiction of Mogul quality analysis of bond lengths, bond angles, torsion angles, and ring geometry for all instances of the Ligand of Interest. In addition, ligands with molecular weight > 250 and outliers as shown on the validation Tables will also be included. For torsion angles, if less than 5% of the Mogul distribution of torsion angles is within 10 degrees of the torsion angle in question, then that torsion angle is considered an outlier. Any bond that is central to one or more torsion angles identified as an outlier by Mogul will be highlighted in the graph. For rings, the root-mean-square deviation (RMSD) between the ring in question and similar rings identified by Mogul is calculated over all ring torsion angles. If the average RMSD is greater than 60 degrees and the minimal RMSD between the ring in question and any Mogul-identified rings is also greater than 60 degrees, then that ring is considered an outlier. The outliers are highlighted in purple. The color gray indicates Mogul did not find sufficient equivalents in the CSD to analyse the geometry.

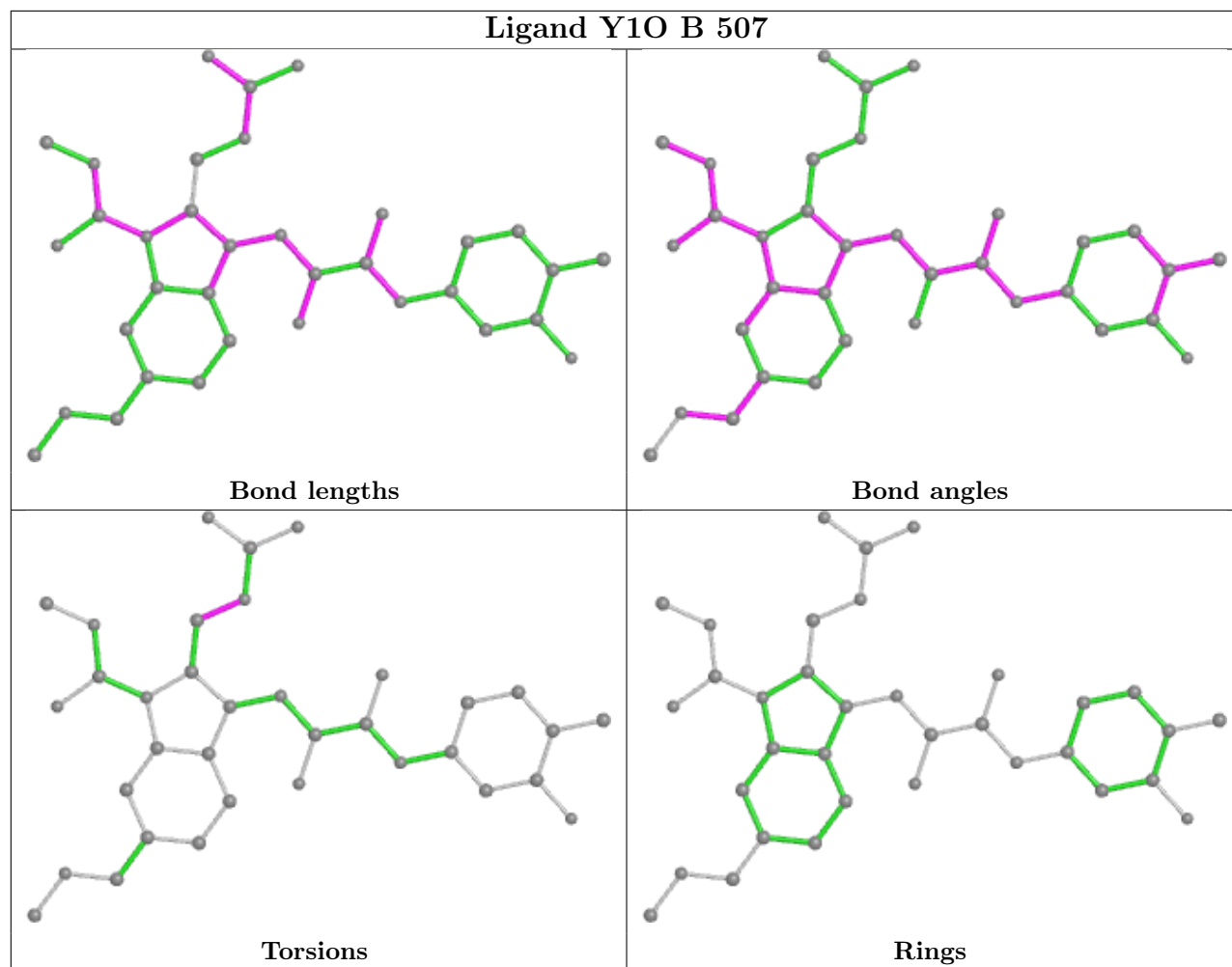

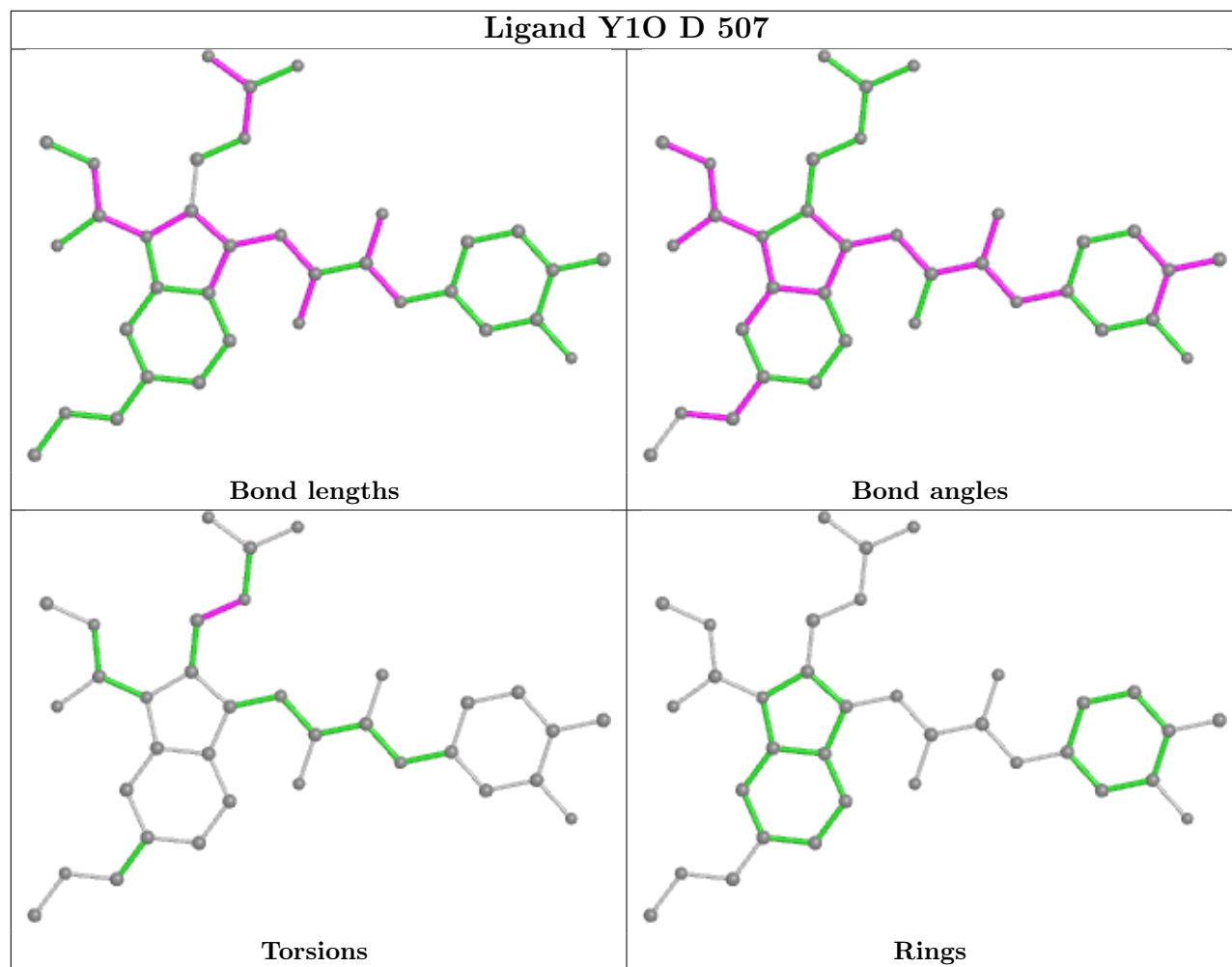

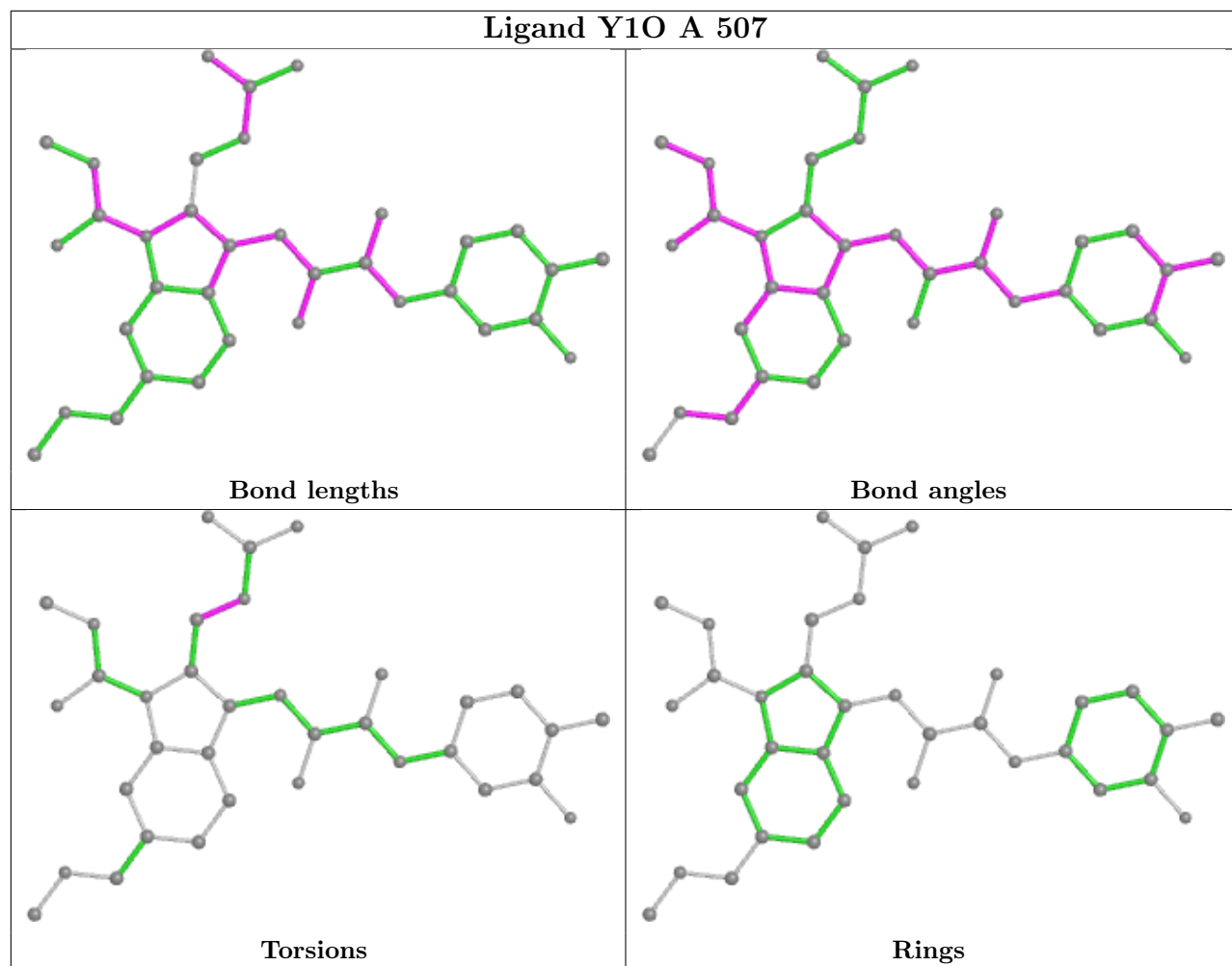

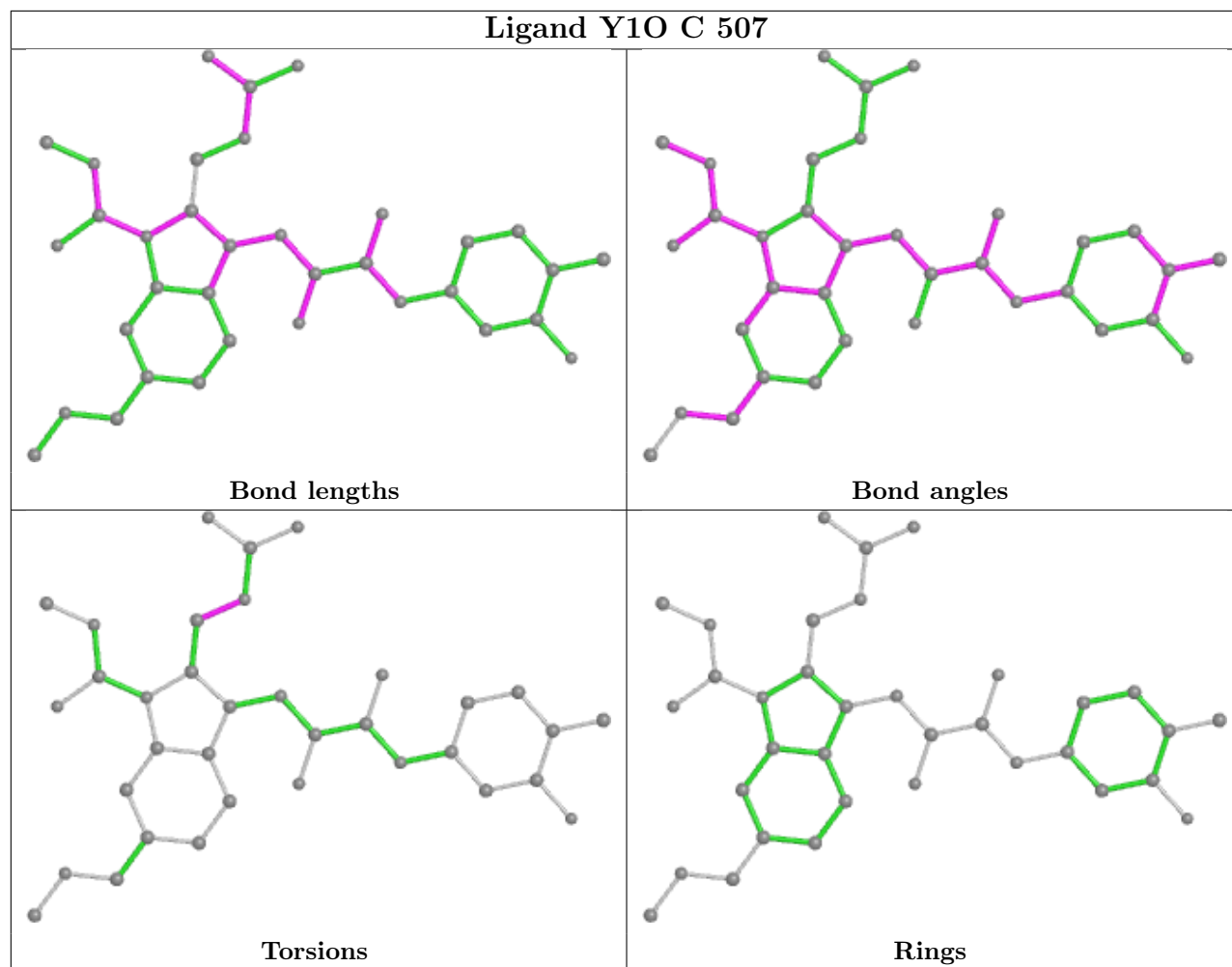

5.7 Other polymers [i](#)

There are no such residues in this entry.

5.8 Polymer linkage issues [i](#)

There are no chain breaks in this entry.

6 Fit of model and data

6.1 Protein, DNA and RNA chains

In the following table, the column labelled ‘#RSRZ > 2’ contains the number (and percentage) of RSRZ outliers, followed by percent RSRZ outliers for the chain as percentile scores relative to all X-ray entries and entries of similar resolution. The OWAB column contains the minimum, median, 95th percentile and maximum values of the occupancy-weighted average B-factor per residue. The column labelled ‘Q < 0.9’ lists the number of (and percentage) of residues with an average occupancy less than 0.9.

Mol	Chain	Analysed	<RSRZ>	#RSRZ>2	OWAB(Å ²)	Q<0.9
1	A	335/358 (93%)	0.92	38 (11%) 5 6	26, 41, 68, 129	0
1	B	335/358 (93%)	1.00	45 (13%) 3 4	25, 43, 78, 113	0
1	C	335/358 (93%)	0.71	23 (6%) 16 20	24, 39, 65, 90	0
1	D	335/358 (93%)	1.13	51 (15%) 2 2	27, 44, 76, 132	0
All	All	1340/1432 (93%)	0.94	157 (11%) 4 5	24, 41, 73, 132	0

All (157) RSRZ outliers are listed below:

Mol	Chain	Res	Type	RSRZ
1	D	124	GLY	16.0
1	A	61	TYR	12.9
1	A	198	GLY	12.9
1	D	87	ALA	11.1
1	D	198	GLY	10.5
1	A	87	ALA	9.1
1	A	80	ASN	8.7
1	D	61	TYR	8.6
1	B	87	ALA	7.4
1	A	124	GLY	7.2
1	A	89	VAL	6.5
1	C	85	VAL	6.4
1	B	88	ASN	6.0
1	A	60	ALA	6.0
1	D	240	ARG	6.0
1	B	72	HIS	6.0
1	A	88	ASN	6.0
1	D	57	ASP	5.9
1	D	60	ALA	5.9
1	D	85	VAL	5.9
1	C	84	MET	5.7

Continued on next page...

Continued from previous page...

Mol	Chain	Res	Type	RSRZ
1	C	89	VAL	5.6
1	B	84	MET	5.6
1	D	89	VAL	5.6
1	A	85	VAL	5.5
1	B	240	ARG	5.4
1	B	61	TYR	5.3
1	C	240	ARG	5.3
1	D	88	ASN	5.3
1	B	198	GLY	5.3
1	B	124	GLY	5.0
1	D	84	MET	5.0
1	B	489	VAL	4.9
1	B	85	VAL	4.9
1	B	89	VAL	4.9
1	C	86	LEU	4.8
1	A	72	HIS	4.7
1	B	122	LEU	4.6
1	B	57	ASP	4.6
1	C	87	ALA	4.6
1	D	90	THR	4.4
1	A	240	ARG	4.4
1	B	60	ALA	4.3
1	D	72	HIS	4.3
1	A	50	THR	4.2
1	D	325	ASN	4.2
1	C	88	ASN	4.1
1	A	199	SER	4.0
1	A	356	SER	4.0
1	C	60	ALA	4.0
1	D	231	LYS	4.0
1	B	325	ASN	3.9
1	D	122	LEU	3.9
1	B	224	ALA	3.9
1	D	86	LEU	3.9
1	A	202	THR	3.9
1	B	231	LYS	3.9
1	B	226	LEU	3.8
1	B	91	GLU	3.8
1	A	82	GLN	3.8
1	B	408	ARG	3.7
1	C	80	ASN	3.7
1	D	238	PRO	3.7

Continued on next page...

Continued from previous page...

Mol	Chain	Res	Type	RSRZ
1	D	408	ARG	3.7
1	A	86	LEU	3.6
1	D	326	ILE	3.5
1	B	50	THR	3.5
1	C	325	ASN	3.4
1	D	396	ARG	3.4
1	A	90	THR	3.4
1	A	326	ILE	3.4
1	B	365	SER	3.4
1	B	86	LEU	3.4
1	D	411	ASN	3.3
1	A	122	LEU	3.3
1	D	300	ASN	3.3
1	C	221	ALA	3.2
1	A	226	LEU	3.2
1	D	82	GLN	3.1
1	D	92	ASN	3.1
1	B	411	ASN	3.1
1	D	80	ASN	3.0
1	D	339	ASN	3.0
1	C	82	GLN	3.0
1	C	199	SER	3.0
1	D	356	SER	3.0
1	A	328	GLN	3.0
1	D	244	THR	2.9
1	C	244	THR	2.9
1	D	340	ASN	2.9
1	A	57	ASP	2.9
1	A	84	MET	2.9
1	B	90	THR	2.8
1	B	356	SER	2.8
1	D	269	GLU	2.8
1	B	432	ARG	2.7
1	A	221	ALA	2.7
1	A	300	ASN	2.7
1	D	239	CYS	2.6
1	A	222	GLY	2.6
1	C	356	SER	2.6
1	D	71	THR	2.6
1	B	92	ASN	2.6
1	B	326	ILE	2.5
1	D	50	THR	2.5

Continued on next page...

Continued from previous page...

Mol	Chain	Res	Type	RSRZ
1	C	61	TYR	2.5
1	D	397	ASN	2.5
1	C	90	THR	2.5
1	B	76	PRO	2.5
1	D	489	VAL	2.5
1	B	353	PHE	2.5
1	A	113	ASP	2.4
1	B	238	PRO	2.4
1	B	79	PRO	2.4
1	B	488	VAL	2.4
1	A	411	ASN	2.4
1	A	325	ASN	2.4
1	B	354	PRO	2.4
1	C	354	PRO	2.4
1	C	198	GLY	2.4
1	D	354	PRO	2.3
1	B	80	ASN	2.3
1	B	339	ASN	2.3
1	A	123	THR	2.3
1	C	72	HIS	2.3
1	B	63	LYS	2.3
1	D	201	ILE	2.3
1	D	243	SER	2.3
1	B	221	ALA	2.3
1	A	464	ASP	2.3
1	A	397	ASN	2.2
1	C	202	THR	2.2
1	A	200	ALA	2.2
1	D	91	GLU	2.2
1	D	123	THR	2.2
1	B	396	ARG	2.2
1	C	397	ASN	2.2
1	A	79	PRO	2.2
1	D	357	LYS	2.2
1	D	226	LEU	2.1
1	D	241	ASN	2.1
1	A	396	ARG	2.1
1	D	246	GLN	2.1
1	A	489	VAL	2.1
1	D	415	THR	2.1
1	B	82	GLN	2.1
1	D	221	ALA	2.1

Continued on next page...

Continued from previous page...

Mol	Chain	Res	Type	RSRZ
1	C	365	SER	2.0
1	B	223	PHE	2.0
1	B	397	ASN	2.0
1	D	404	ASN	2.0
1	D	290	GLU	2.0
1	B	406	THR	2.0
1	D	341	THR	2.0
1	D	439	ILE	2.0
1	B	328	GLN	2.0
1	A	68	VAL	2.0

6.2 Non-standard residues in protein, DNA, RNA chains [i](#)

There are no non-standard protein/DNA/RNA residues in this entry.

6.3 Carbohydrates [i](#)

There are no monosaccharides in this entry.

6.4 Ligands [i](#)

In the following table, the Atoms column lists the number of modelled atoms in the group and the number defined in the chemical component dictionary. The B-factors column lists the minimum, median, 95th percentile and maximum values of B factors of atoms in the group. The column labelled 'Q< 0.9' lists the number of atoms with occupancy less than 0.9.

Mol	Type	Chain	Res	Atoms	RSCC	RSR	B-factors(Å ²)	Q<0.9
2	NAG	D	506	14/15	0.27	0.40	64,66,75,81	0
2	NAG	A	506	14/15	0.62	0.41	72,87,96,106	0
2	NAG	D	503	14/15	0.76	0.24	56,66,73,76	0
2	NAG	C	506	14/15	0.76	0.26	50,61,67,72	0
2	NAG	B	506	14/15	0.77	0.29	46,52,60,63	0
2	NAG	B	503	14/15	0.78	0.25	57,61,71,74	0
2	NAG	D	501	14/15	0.79	0.23	39,52,60,61	0
2	NAG	D	505	14/15	0.81	0.22	54,56,60,61	0
2	NAG	B	504	14/15	0.81	0.22	43,50,55,57	0
2	NAG	B	501	14/15	0.82	0.19	41,53,58,60	0
2	NAG	C	508	14/15	0.82	0.18	49,54,57,58	0
2	NAG	B	505	14/15	0.86	0.16	50,53,55,61	0
2	NAG	A	508	14/15	0.86	0.18	50,55,57,59	0

Continued on next page...

Continued from previous page...

Mol	Type	Chain	Res	Atoms	RSCC	RSR	B-factors(\AA^2)	Q<0.9
2	NAG	C	503	14/15	0.87	0.17	49,53,55,57	0
2	NAG	C	504	14/15	0.87	0.16	28,43,50,50	0
2	NAG	C	505	14/15	0.88	0.15	35,42,45,49	0
2	NAG	D	504	14/15	0.88	0.17	48,50,55,56	0
2	NAG	A	501	14/15	0.90	0.18	43,52,57,66	0
2	NAG	A	503	14/15	0.91	0.19	47,52,56,57	0
2	NAG	A	504	14/15	0.92	0.19	42,47,53,58	0
2	NAG	A	505	14/15	0.92	0.15	37,42,47,48	0
2	NAG	C	501	14/15	0.92	0.13	37,43,49,54	0
2	NAG	D	502	14/15	0.92	0.20	32,39,45,46	0
3	Y1O	D	507	35/35	0.92	0.15	25,33,48,48	0
3	Y1O	A	507	35/35	0.93	0.16	27,31,39,51	0
2	NAG	C	502	14/15	0.93	0.16	28,33,36,40	0
2	NAG	B	502	14/15	0.94	0.14	30,40,43,45	0
3	Y1O	C	507	35/35	0.94	0.16	23,29,39,49	0
2	NAG	A	502	14/15	0.94	0.17	26,37,42,44	0
3	Y1O	B	507	35/35	0.95	0.15	25,32,37,43	0

The following is a graphical depiction of the model fit to experimental electron density of all instances of the Ligand of Interest. In addition, ligands with molecular weight > 250 and outliers as shown on the geometry validation Tables will also be included. Each fit is shown from different orientation to approximate a three-dimensional view.

Electron density around Y10 D 507:

$2mF_o-DF_c$ (at 0.7 rmsd) in gray
 mF_o-DF_c (at 3 rmsd) in purple (negative)
and green (positive)

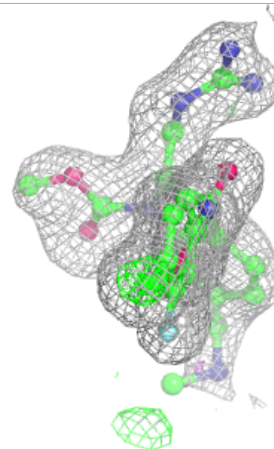
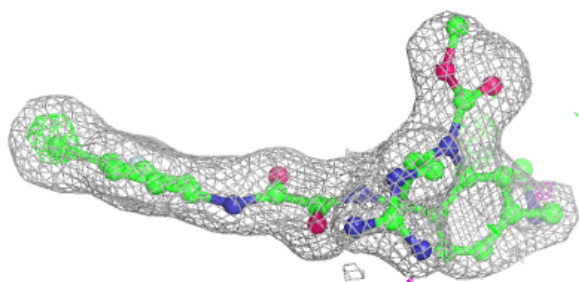
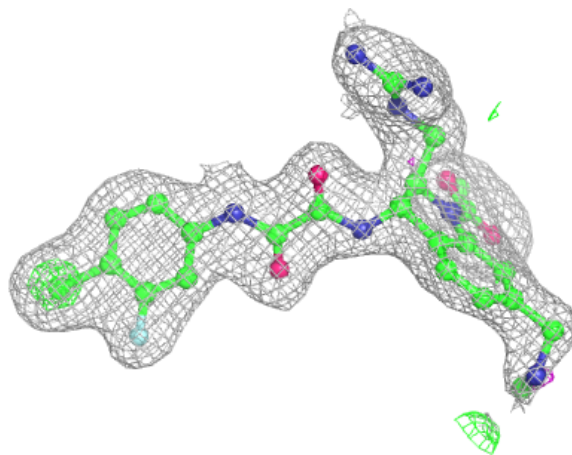

Electron density around Y1O A 507:

$2mF_o-DF_c$ (at 0.7 rmsd) in gray
 mF_o-DF_c (at 3 rmsd) in purple (negative)
and green (positive)

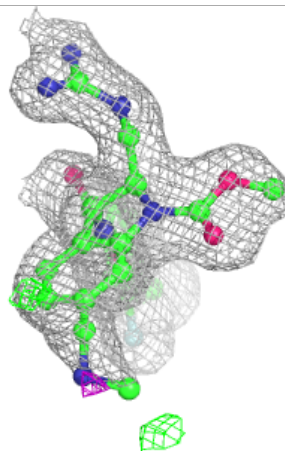
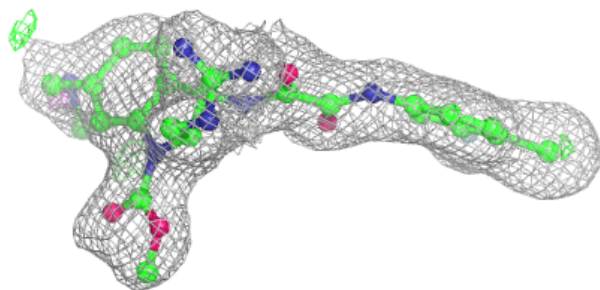
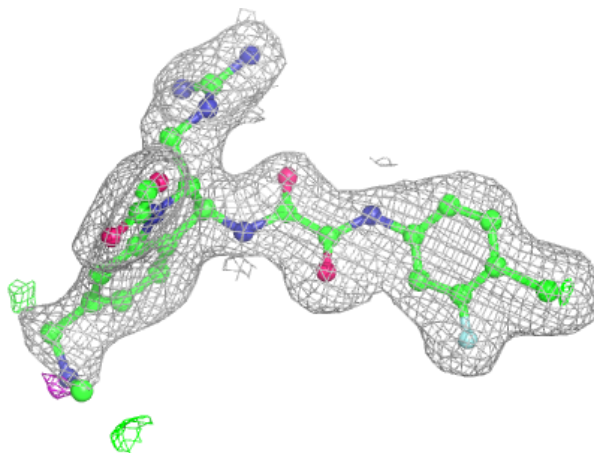

Electron density around Y10 C 507:

$2mF_o-DF_c$ (at 0.7 rmsd) in gray
 mF_o-DF_c (at 3 rmsd) in purple (negative)
and green (positive)

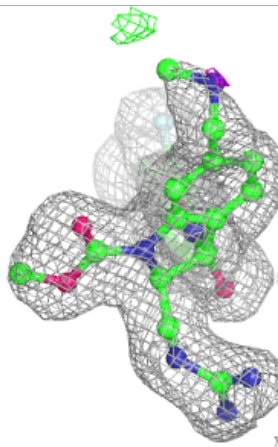
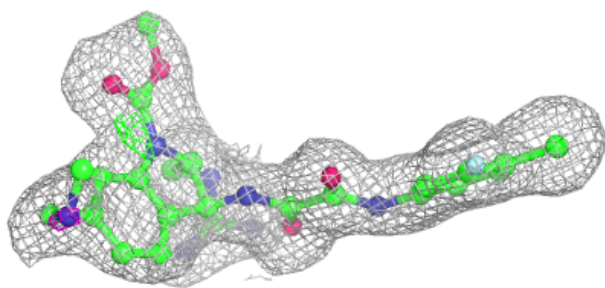
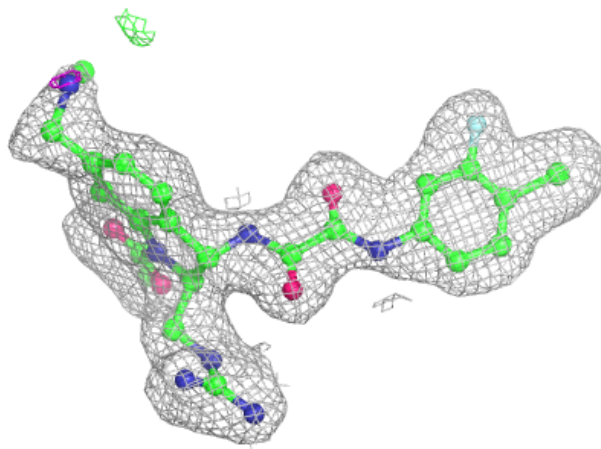

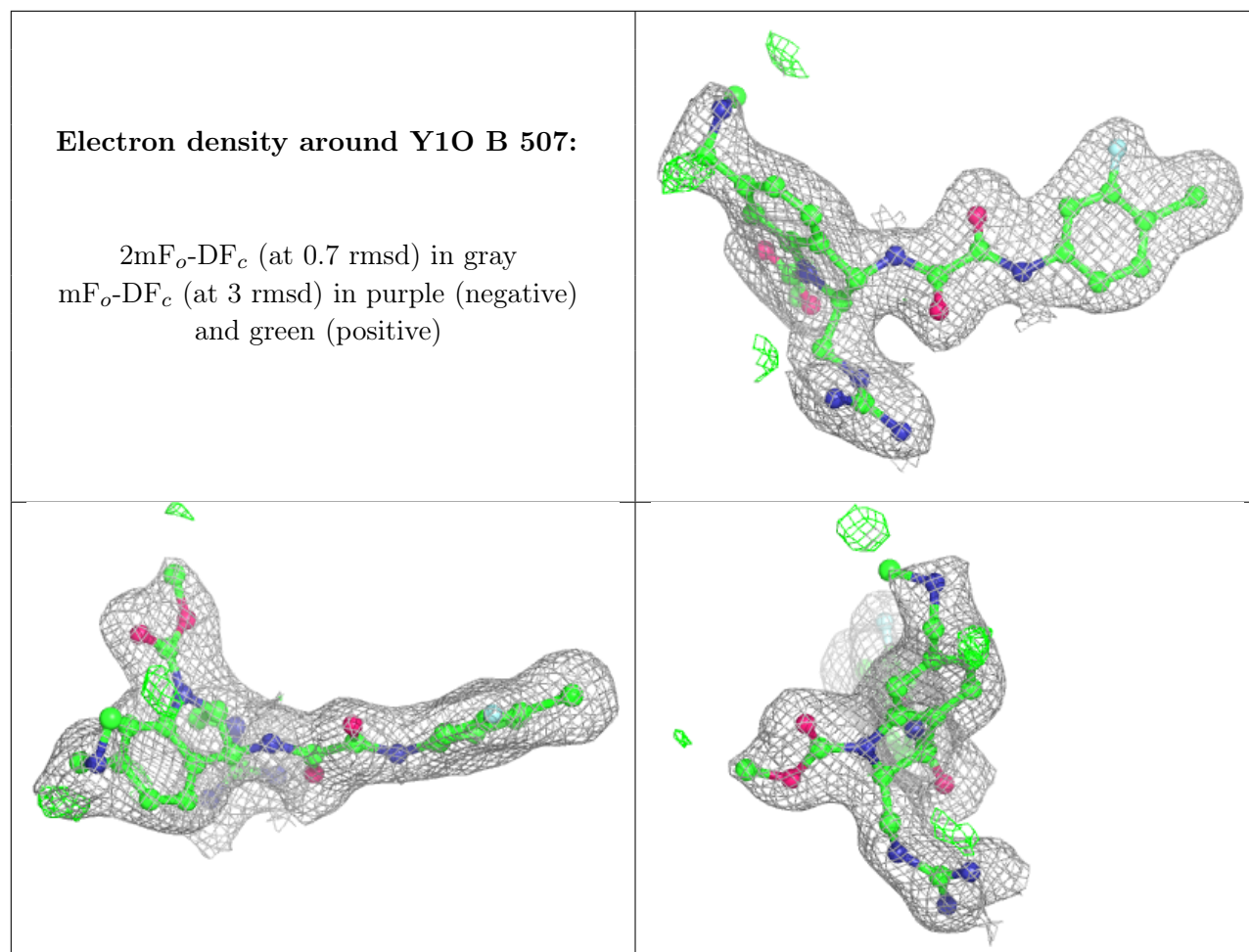

6.5 Other polymers [i](#)

There are no such residues in this entry.