



## Full wwPDB EM Validation Report ⓘ

Nov 29, 2022 – 06:13 PM EST

PDB ID : 8DLP  
EMDB ID : EMD-27509  
Title : Cryo-EM structure of SARS-CoV-2 Gamma (P.1) spike protein in complex with human ACE2  
Authors : Zhu, X.; Mannar, D.; Saville, J.W.; Srivastava, S.S.; Berezuk, A.M.; Zhou, S.; Tuttle, K.S.; Subramaniam, S.  
Deposited on : 2022-07-08  
Resolution : 2.64 Å(reported)

This is a Full wwPDB EM Validation Report for a publicly released PDB entry.

We welcome your comments at [validation@mail.wwpdb.org](mailto:validation@mail.wwpdb.org)

A user guide is available at

<https://www.wwpdb.org/validation/2017/EMValidationReportHelp>

with specific help available everywhere you see the ⓘ symbol.

The types of validation reports are described at

<http://www.wwpdb.org/validation/2017/FAQs#types>.

---

The following versions of software and data (see [references ⓘ](#)) were used in the production of this report:

EMDB validation analysis : 0.0.1.dev43  
Mogul : 1.8.5 (274361), CSD as541be (2020)  
MolProbity : 4.02b-467  
Percentile statistics : 20191225.v01 (using entries in the PDB archive December 25th 2019)  
MapQ : 1.9.9  
Ideal geometry (proteins) : Engh & Huber (2001)  
Ideal geometry (DNA, RNA) : Parkinson et al. (1996)  
Validation Pipeline (wwPDB-VP) : 2.31.2

# 1 Overall quality at a glance i

The following experimental techniques were used to determine the structure:

*ELECTRON MICROSCOPY*

The reported resolution of this entry is 2.64 Å.

Percentile scores (ranging between 0-100) for global validation metrics of the entry are shown in the following graphic. The table shows the number of entries on which the scores are based.

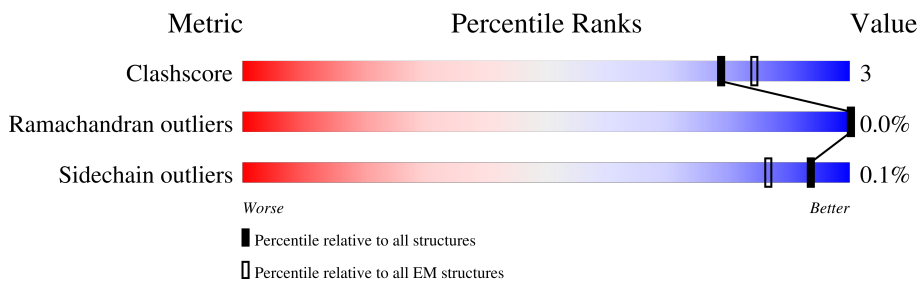









Metric	Whole archive (#Entries)	EM structures (#Entries)
Clashscore	158937	4297
Ramachandran outliers	154571	4023
Sidechain outliers	154315	3826

The table below summarises the geometric issues observed across the polymeric chains and their fit to the map. The red, orange, yellow and green segments of the bar indicate the fraction of residues that contain outliers for  $\geq 3$ , 2, 1 and 0 types of geometric quality criteria respectively. A grey segment represents the fraction of residues that are not modelled. The numeric value for each fraction is indicated below the corresponding segment, with a dot representing fractions  $\leq 5\%$ . The upper red bar (where present) indicates the fraction of residues that have poor fit to the EM map (all-atom inclusion  $< 40\%$ ). The numeric value is given above the bar.

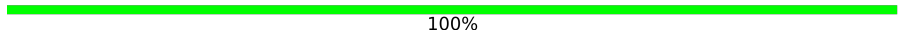
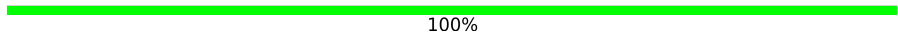
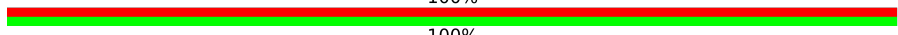
Mol	Chain	Length	Quality of chain
1	A	1288	11% (Poor fit) 74% (0 outliers) 7% (1 outlier) 19% (2+ outliers)
1	B	1288	74% (0 outliers) 7% (1 outlier) 19% (2+ outliers)
1	C	1288	13% (Poor fit) 74% (0 outliers) 7% (1 outlier) 19% (2+ outliers)
2	D	606	97% (Poor fit) 90% (0 outliers) 8% (1 outlier)
2	E	606	17% (Poor fit) 91% (0 outliers) 7% (1 outlier)
2	F	606	98% (Poor fit) 92% (0 outliers) 7% (1 outlier)
3	G	2	50% (Poor fit) 100% (0 outliers)
3	H	2	50% (0 outliers) 50% (1 outlier)

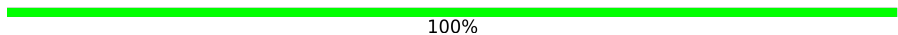
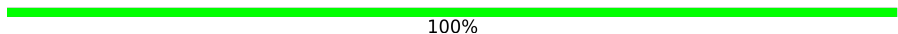
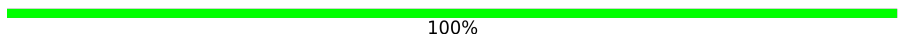
Continued on next page...

*Continued from previous page...*

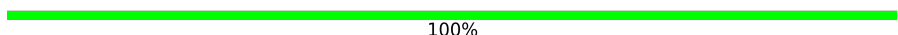
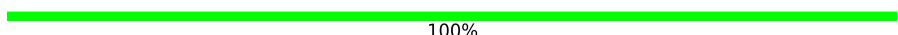
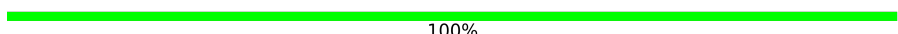
Mol	Chain	Length	Quality of chain
3	I	2	 50% 50%
3	J	2	 50% 100%
3	K	2	 100%
3	L	2	 100%
3	M	2	 100%
3	N	2	 50% 50%
3	O	2	 50% 50%
3	P	2	 100%
3	Q	2	 100%
3	R	2	 100%
3	S	2	 100%
3	T	2	 50% 50%
3	U	2	 50% 50%
3	V	2	 100%
3	W	2	 100%
3	X	2	 100%

## 2 Entry composition [i](#)

There are 4 unique types of molecules in this entry. The entry contains 40095 atoms, of which 0 are hydrogens and 0 are deuteriums.

In the tables below, the AltConf column contains the number of residues with at least one atom in alternate conformation and the Trace column contains the number of residues modelled with at most 2 atoms.

- Molecule 1 is a protein called Spike glycoprotein.

Mol	Chain	Residues	Atoms					AltConf	Trace
			Total	C	N	O	S		
1	A	1040	8139	5205	1351	1546	37	0	0
1	B	1040	8139	5205	1351	1546	37	0	0
1	C	1040	8139	5205	1351	1546	37	0	0

There are 303 discrepancies between the modelled and reference sequences:

Chain	Residue	Modelled	Actual	Comment	Reference
A	18	PHE	LEU	conflict	UNP P0DTC2
A	20	ASN	THR	conflict	UNP P0DTC2
A	26	SER	PRO	conflict	UNP P0DTC2
A	138	TYR	ASP	conflict	UNP P0DTC2
A	190	SER	ARG	conflict	UNP P0DTC2
A	417	THR	LYS	conflict	UNP P0DTC2
A	484	LYS	GLU	conflict	UNP P0DTC2
A	501	TYR	ASN	conflict	UNP P0DTC2
A	614	GLY	ASP	conflict	UNP P0DTC2
A	655	TYR	HIS	conflict	UNP P0DTC2
A	682	GLY	ARG	conflict	UNP P0DTC2
A	683	SER	ARG	conflict	UNP P0DTC2
A	685	SER	ARG	conflict	UNP P0DTC2
A	817	PRO	PHE	conflict	UNP P0DTC2
A	892	PRO	ALA	conflict	UNP P0DTC2
A	899	PRO	ALA	conflict	UNP P0DTC2
A	942	PRO	ALA	conflict	UNP P0DTC2
A	986	PRO	LYS	conflict	UNP P0DTC2
A	987	PRO	VAL	conflict	UNP P0DTC2
A	1027	ILE	THR	conflict	UNP P0DTC2
A	1176	PHE	VAL	conflict	UNP P0DTC2
A	1209	GLY	-	expression tag	UNP P0DTC2
A	1210	SER	-	expression tag	UNP P0DTC2
A	1211	GLY	-	expression tag	UNP P0DTC2

*Continued on next page...*

*Continued from previous page...*

Chain	Residue	Modelled	Actual	Comment	Reference
A	1212	TYR	-	expression tag	UNP P0DTC2
A	1213	ILE	-	expression tag	UNP P0DTC2
A	1214	PRO	-	expression tag	UNP P0DTC2
A	1215	GLU	-	expression tag	UNP P0DTC2
A	1216	ALA	-	expression tag	UNP P0DTC2
A	1217	PRO	-	expression tag	UNP P0DTC2
A	1218	ARG	-	expression tag	UNP P0DTC2
A	1219	ASP	-	expression tag	UNP P0DTC2
A	1220	GLY	-	expression tag	UNP P0DTC2
A	1221	GLN	-	expression tag	UNP P0DTC2
A	1222	ALA	-	expression tag	UNP P0DTC2
A	1223	TYR	-	expression tag	UNP P0DTC2
A	1224	VAL	-	expression tag	UNP P0DTC2
A	1225	ARG	-	expression tag	UNP P0DTC2
A	1226	LYS	-	expression tag	UNP P0DTC2
A	1227	ASP	-	expression tag	UNP P0DTC2
A	1228	GLY	-	expression tag	UNP P0DTC2
A	1229	GLU	-	expression tag	UNP P0DTC2
A	1230	TRP	-	expression tag	UNP P0DTC2
A	1231	VAL	-	expression tag	UNP P0DTC2
A	1232	LEU	-	expression tag	UNP P0DTC2
A	1233	LEU	-	expression tag	UNP P0DTC2
A	1234	SER	-	expression tag	UNP P0DTC2
A	1235	THR	-	expression tag	UNP P0DTC2
A	1236	PHE	-	expression tag	UNP P0DTC2
A	1237	LEU	-	expression tag	UNP P0DTC2
A	1238	GLY	-	expression tag	UNP P0DTC2
A	1239	ARG	-	expression tag	UNP P0DTC2
A	1240	SER	-	expression tag	UNP P0DTC2
A	1241	LEU	-	expression tag	UNP P0DTC2
A	1242	GLU	-	expression tag	UNP P0DTC2
A	1243	VAL	-	expression tag	UNP P0DTC2
A	1244	LEU	-	expression tag	UNP P0DTC2
A	1245	PHE	-	expression tag	UNP P0DTC2
A	1246	GLN	-	expression tag	UNP P0DTC2
A	1247	GLY	-	expression tag	UNP P0DTC2
A	1248	PRO	-	expression tag	UNP P0DTC2
A	1249	GLY	-	expression tag	UNP P0DTC2
A	1250	HIS	-	expression tag	UNP P0DTC2
A	1251	HIS	-	expression tag	UNP P0DTC2
A	1252	HIS	-	expression tag	UNP P0DTC2
A	1253	HIS	-	expression tag	UNP P0DTC2

*Continued on next page...*

*Continued from previous page...*

Chain	Residue	Modelled	Actual	Comment	Reference
A	1254	HIS	-	expression tag	UNP P0DTC2
A	1255	HIS	-	expression tag	UNP P0DTC2
A	1256	HIS	-	expression tag	UNP P0DTC2
A	1257	HIS	-	expression tag	UNP P0DTC2
A	1258	SER	-	expression tag	UNP P0DTC2
A	1259	ALA	-	expression tag	UNP P0DTC2
A	1260	TRP	-	expression tag	UNP P0DTC2
A	1261	SER	-	expression tag	UNP P0DTC2
A	1262	HIS	-	expression tag	UNP P0DTC2
A	1263	PRO	-	expression tag	UNP P0DTC2
A	1264	GLN	-	expression tag	UNP P0DTC2
A	1265	PHE	-	expression tag	UNP P0DTC2
A	1266	GLU	-	expression tag	UNP P0DTC2
A	1267	LYS	-	expression tag	UNP P0DTC2
A	1268	GLY	-	expression tag	UNP P0DTC2
A	1269	GLY	-	expression tag	UNP P0DTC2
A	1270	GLY	-	expression tag	UNP P0DTC2
A	1271	SER	-	expression tag	UNP P0DTC2
A	1272	GLY	-	expression tag	UNP P0DTC2
A	1273	GLY	-	expression tag	UNP P0DTC2
A	1274	GLY	-	expression tag	UNP P0DTC2
A	1275	GLY	-	expression tag	UNP P0DTC2
A	1276	SER	-	expression tag	UNP P0DTC2
A	1277	GLY	-	expression tag	UNP P0DTC2
A	1278	GLY	-	expression tag	UNP P0DTC2
A	1279	SER	-	expression tag	UNP P0DTC2
A	1280	ALA	-	expression tag	UNP P0DTC2
A	1281	TRP	-	expression tag	UNP P0DTC2
A	1282	SER	-	expression tag	UNP P0DTC2
A	1283	HIS	-	expression tag	UNP P0DTC2
A	1284	PRO	-	expression tag	UNP P0DTC2
A	1285	GLN	-	expression tag	UNP P0DTC2
A	1286	PHE	-	expression tag	UNP P0DTC2
A	1287	GLU	-	expression tag	UNP P0DTC2
A	1288	LYS	-	expression tag	UNP P0DTC2
B	18	PHE	LEU	conflict	UNP P0DTC2
B	20	ASN	THR	conflict	UNP P0DTC2
B	26	SER	PRO	conflict	UNP P0DTC2
B	138	TYR	ASP	conflict	UNP P0DTC2
B	190	SER	ARG	conflict	UNP P0DTC2
B	417	THR	LYS	conflict	UNP P0DTC2
B	484	LYS	GLU	conflict	UNP P0DTC2

*Continued on next page...*

*Continued from previous page...*

Chain	Residue	Modelled	Actual	Comment	Reference
B	501	TYR	ASN	conflict	UNP P0DTC2
B	614	GLY	ASP	conflict	UNP P0DTC2
B	655	TYR	HIS	conflict	UNP P0DTC2
B	682	GLY	ARG	conflict	UNP P0DTC2
B	683	SER	ARG	conflict	UNP P0DTC2
B	685	SER	ARG	conflict	UNP P0DTC2
B	817	PRO	PHE	conflict	UNP P0DTC2
B	892	PRO	ALA	conflict	UNP P0DTC2
B	899	PRO	ALA	conflict	UNP P0DTC2
B	942	PRO	ALA	conflict	UNP P0DTC2
B	986	PRO	LYS	conflict	UNP P0DTC2
B	987	PRO	VAL	conflict	UNP P0DTC2
B	1027	ILE	THR	conflict	UNP P0DTC2
B	1176	PHE	VAL	conflict	UNP P0DTC2
B	1209	GLY	-	expression tag	UNP P0DTC2
B	1210	SER	-	expression tag	UNP P0DTC2
B	1211	GLY	-	expression tag	UNP P0DTC2
B	1212	TYR	-	expression tag	UNP P0DTC2
B	1213	ILE	-	expression tag	UNP P0DTC2
B	1214	PRO	-	expression tag	UNP P0DTC2
B	1215	GLU	-	expression tag	UNP P0DTC2
B	1216	ALA	-	expression tag	UNP P0DTC2
B	1217	PRO	-	expression tag	UNP P0DTC2
B	1218	ARG	-	expression tag	UNP P0DTC2
B	1219	ASP	-	expression tag	UNP P0DTC2
B	1220	GLY	-	expression tag	UNP P0DTC2
B	1221	GLN	-	expression tag	UNP P0DTC2
B	1222	ALA	-	expression tag	UNP P0DTC2
B	1223	TYR	-	expression tag	UNP P0DTC2
B	1224	VAL	-	expression tag	UNP P0DTC2
B	1225	ARG	-	expression tag	UNP P0DTC2
B	1226	LYS	-	expression tag	UNP P0DTC2
B	1227	ASP	-	expression tag	UNP P0DTC2
B	1228	GLY	-	expression tag	UNP P0DTC2
B	1229	GLU	-	expression tag	UNP P0DTC2
B	1230	TRP	-	expression tag	UNP P0DTC2
B	1231	VAL	-	expression tag	UNP P0DTC2
B	1232	LEU	-	expression tag	UNP P0DTC2
B	1233	LEU	-	expression tag	UNP P0DTC2
B	1234	SER	-	expression tag	UNP P0DTC2
B	1235	THR	-	expression tag	UNP P0DTC2
B	1236	PHE	-	expression tag	UNP P0DTC2

*Continued on next page...*

*Continued from previous page...*

Chain	Residue	Modelled	Actual	Comment	Reference
B	1237	LEU	-	expression tag	UNP P0DTC2
B	1238	GLY	-	expression tag	UNP P0DTC2
B	1239	ARG	-	expression tag	UNP P0DTC2
B	1240	SER	-	expression tag	UNP P0DTC2
B	1241	LEU	-	expression tag	UNP P0DTC2
B	1242	GLU	-	expression tag	UNP P0DTC2
B	1243	VAL	-	expression tag	UNP P0DTC2
B	1244	LEU	-	expression tag	UNP P0DTC2
B	1245	PHE	-	expression tag	UNP P0DTC2
B	1246	GLN	-	expression tag	UNP P0DTC2
B	1247	GLY	-	expression tag	UNP P0DTC2
B	1248	PRO	-	expression tag	UNP P0DTC2
B	1249	GLY	-	expression tag	UNP P0DTC2
B	1250	HIS	-	expression tag	UNP P0DTC2
B	1251	HIS	-	expression tag	UNP P0DTC2
B	1252	HIS	-	expression tag	UNP P0DTC2
B	1253	HIS	-	expression tag	UNP P0DTC2
B	1254	HIS	-	expression tag	UNP P0DTC2
B	1255	HIS	-	expression tag	UNP P0DTC2
B	1256	HIS	-	expression tag	UNP P0DTC2
B	1257	HIS	-	expression tag	UNP P0DTC2
B	1258	SER	-	expression tag	UNP P0DTC2
B	1259	ALA	-	expression tag	UNP P0DTC2
B	1260	TRP	-	expression tag	UNP P0DTC2
B	1261	SER	-	expression tag	UNP P0DTC2
B	1262	HIS	-	expression tag	UNP P0DTC2
B	1263	PRO	-	expression tag	UNP P0DTC2
B	1264	GLN	-	expression tag	UNP P0DTC2
B	1265	PHE	-	expression tag	UNP P0DTC2
B	1266	GLU	-	expression tag	UNP P0DTC2
B	1267	LYS	-	expression tag	UNP P0DTC2
B	1268	GLY	-	expression tag	UNP P0DTC2
B	1269	GLY	-	expression tag	UNP P0DTC2
B	1270	GLY	-	expression tag	UNP P0DTC2
B	1271	SER	-	expression tag	UNP P0DTC2
B	1272	GLY	-	expression tag	UNP P0DTC2
B	1273	GLY	-	expression tag	UNP P0DTC2
B	1274	GLY	-	expression tag	UNP P0DTC2
B	1275	GLY	-	expression tag	UNP P0DTC2
B	1276	SER	-	expression tag	UNP P0DTC2
B	1277	GLY	-	expression tag	UNP P0DTC2
B	1278	GLY	-	expression tag	UNP P0DTC2

*Continued on next page...*



*Continued from previous page...*

Chain	Residue	Modelled	Actual	Comment	Reference
B	1279	SER	-	expression tag	UNP P0DTC2
B	1280	ALA	-	expression tag	UNP P0DTC2
B	1281	TRP	-	expression tag	UNP P0DTC2
B	1282	SER	-	expression tag	UNP P0DTC2
B	1283	HIS	-	expression tag	UNP P0DTC2
B	1284	PRO	-	expression tag	UNP P0DTC2
B	1285	GLN	-	expression tag	UNP P0DTC2
B	1286	PHE	-	expression tag	UNP P0DTC2
B	1287	GLU	-	expression tag	UNP P0DTC2
B	1288	LYS	-	expression tag	UNP P0DTC2
C	18	PHE	LEU	conflict	UNP P0DTC2
C	20	ASN	THR	conflict	UNP P0DTC2
C	26	SER	PRO	conflict	UNP P0DTC2
C	138	TYR	ASP	conflict	UNP P0DTC2
C	190	SER	ARG	conflict	UNP P0DTC2
C	417	THR	LYS	conflict	UNP P0DTC2
C	484	LYS	GLU	conflict	UNP P0DTC2
C	501	TYR	ASN	conflict	UNP P0DTC2
C	614	GLY	ASP	conflict	UNP P0DTC2
C	655	TYR	HIS	conflict	UNP P0DTC2
C	682	GLY	ARG	conflict	UNP P0DTC2
C	683	SER	ARG	conflict	UNP P0DTC2
C	685	SER	ARG	conflict	UNP P0DTC2
C	817	PRO	PHE	conflict	UNP P0DTC2
C	892	PRO	ALA	conflict	UNP P0DTC2
C	899	PRO	ALA	conflict	UNP P0DTC2
C	942	PRO	ALA	conflict	UNP P0DTC2
C	986	PRO	LYS	conflict	UNP P0DTC2
C	987	PRO	VAL	conflict	UNP P0DTC2
C	1027	ILE	THR	conflict	UNP P0DTC2
C	1176	PHE	VAL	conflict	UNP P0DTC2
C	1209	GLY	-	expression tag	UNP P0DTC2
C	1210	SER	-	expression tag	UNP P0DTC2
C	1211	GLY	-	expression tag	UNP P0DTC2
C	1212	TYR	-	expression tag	UNP P0DTC2
C	1213	ILE	-	expression tag	UNP P0DTC2
C	1214	PRO	-	expression tag	UNP P0DTC2
C	1215	GLU	-	expression tag	UNP P0DTC2
C	1216	ALA	-	expression tag	UNP P0DTC2
C	1217	PRO	-	expression tag	UNP P0DTC2
C	1218	ARG	-	expression tag	UNP P0DTC2
C	1219	ASP	-	expression tag	UNP P0DTC2

*Continued on next page...*

*Continued from previous page...*

Chain	Residue	Modelled	Actual	Comment	Reference
C	1220	GLY	-	expression tag	UNP P0DTC2
C	1221	GLN	-	expression tag	UNP P0DTC2
C	1222	ALA	-	expression tag	UNP P0DTC2
C	1223	TYR	-	expression tag	UNP P0DTC2
C	1224	VAL	-	expression tag	UNP P0DTC2
C	1225	ARG	-	expression tag	UNP P0DTC2
C	1226	LYS	-	expression tag	UNP P0DTC2
C	1227	ASP	-	expression tag	UNP P0DTC2
C	1228	GLY	-	expression tag	UNP P0DTC2
C	1229	GLU	-	expression tag	UNP P0DTC2
C	1230	TRP	-	expression tag	UNP P0DTC2
C	1231	VAL	-	expression tag	UNP P0DTC2
C	1232	LEU	-	expression tag	UNP P0DTC2
C	1233	LEU	-	expression tag	UNP P0DTC2
C	1234	SER	-	expression tag	UNP P0DTC2
C	1235	THR	-	expression tag	UNP P0DTC2
C	1236	PHE	-	expression tag	UNP P0DTC2
C	1237	LEU	-	expression tag	UNP P0DTC2
C	1238	GLY	-	expression tag	UNP P0DTC2
C	1239	ARG	-	expression tag	UNP P0DTC2
C	1240	SER	-	expression tag	UNP P0DTC2
C	1241	LEU	-	expression tag	UNP P0DTC2
C	1242	GLU	-	expression tag	UNP P0DTC2
C	1243	VAL	-	expression tag	UNP P0DTC2
C	1244	LEU	-	expression tag	UNP P0DTC2
C	1245	PHE	-	expression tag	UNP P0DTC2
C	1246	GLN	-	expression tag	UNP P0DTC2
C	1247	GLY	-	expression tag	UNP P0DTC2
C	1248	PRO	-	expression tag	UNP P0DTC2
C	1249	GLY	-	expression tag	UNP P0DTC2
C	1250	HIS	-	expression tag	UNP P0DTC2
C	1251	HIS	-	expression tag	UNP P0DTC2
C	1252	HIS	-	expression tag	UNP P0DTC2
C	1253	HIS	-	expression tag	UNP P0DTC2
C	1254	HIS	-	expression tag	UNP P0DTC2
C	1255	HIS	-	expression tag	UNP P0DTC2
C	1256	HIS	-	expression tag	UNP P0DTC2
C	1257	HIS	-	expression tag	UNP P0DTC2
C	1258	SER	-	expression tag	UNP P0DTC2
C	1259	ALA	-	expression tag	UNP P0DTC2
C	1260	TRP	-	expression tag	UNP P0DTC2
C	1261	SER	-	expression tag	UNP P0DTC2

*Continued on next page...*

*Continued from previous page...*

Chain	Residue	Modelled	Actual	Comment	Reference
C	1262	HIS	-	expression tag	UNP P0DTC2
C	1263	PRO	-	expression tag	UNP P0DTC2
C	1264	GLN	-	expression tag	UNP P0DTC2
C	1265	PHE	-	expression tag	UNP P0DTC2
C	1266	GLU	-	expression tag	UNP P0DTC2
C	1267	LYS	-	expression tag	UNP P0DTC2
C	1268	GLY	-	expression tag	UNP P0DTC2
C	1269	GLY	-	expression tag	UNP P0DTC2
C	1270	GLY	-	expression tag	UNP P0DTC2
C	1271	SER	-	expression tag	UNP P0DTC2
C	1272	GLY	-	expression tag	UNP P0DTC2
C	1273	GLY	-	expression tag	UNP P0DTC2
C	1274	GLY	-	expression tag	UNP P0DTC2
C	1275	GLY	-	expression tag	UNP P0DTC2
C	1276	SER	-	expression tag	UNP P0DTC2
C	1277	GLY	-	expression tag	UNP P0DTC2
C	1278	GLY	-	expression tag	UNP P0DTC2
C	1279	SER	-	expression tag	UNP P0DTC2
C	1280	ALA	-	expression tag	UNP P0DTC2
C	1281	TRP	-	expression tag	UNP P0DTC2
C	1282	SER	-	expression tag	UNP P0DTC2
C	1283	HIS	-	expression tag	UNP P0DTC2
C	1284	PRO	-	expression tag	UNP P0DTC2
C	1285	GLN	-	expression tag	UNP P0DTC2
C	1286	PHE	-	expression tag	UNP P0DTC2
C	1287	GLU	-	expression tag	UNP P0DTC2
C	1288	LYS	-	expression tag	UNP P0DTC2

- Molecule 2 is a protein called Processed angiotensin-converting enzyme 2.

Mol	Chain	Residues	Atoms					AltConf	Trace
2	D	596	Total	C	N	O	S	0	0
			4862	3111	805	917	29		
2	E	596	Total	C	N	O	S	0	0
			4862	3111	805	917	29		
2	F	596	Total	C	N	O	S	0	0
			4862	3111	805	917	29		

There are 24 discrepancies between the modelled and reference sequences:

Chain	Residue	Modelled	Actual	Comment	Reference
D	616	HIS	-	expression tag	UNP Q9BYF1

*Continued on next page...*

Continued from previous page...

Chain	Residue	Modelled	Actual	Comment	Reference
D	617	HIS	-	expression tag	UNP Q9BYF1
D	618	HIS	-	expression tag	UNP Q9BYF1
D	619	HIS	-	expression tag	UNP Q9BYF1
D	620	HIS	-	expression tag	UNP Q9BYF1
D	621	HIS	-	expression tag	UNP Q9BYF1
D	622	HIS	-	expression tag	UNP Q9BYF1
D	623	HIS	-	expression tag	UNP Q9BYF1
E	616	HIS	-	expression tag	UNP Q9BYF1
E	617	HIS	-	expression tag	UNP Q9BYF1
E	618	HIS	-	expression tag	UNP Q9BYF1
E	619	HIS	-	expression tag	UNP Q9BYF1
E	620	HIS	-	expression tag	UNP Q9BYF1
E	621	HIS	-	expression tag	UNP Q9BYF1
E	622	HIS	-	expression tag	UNP Q9BYF1
E	623	HIS	-	expression tag	UNP Q9BYF1
F	616	HIS	-	expression tag	UNP Q9BYF1
F	617	HIS	-	expression tag	UNP Q9BYF1
F	618	HIS	-	expression tag	UNP Q9BYF1
F	619	HIS	-	expression tag	UNP Q9BYF1
F	620	HIS	-	expression tag	UNP Q9BYF1
F	621	HIS	-	expression tag	UNP Q9BYF1
F	622	HIS	-	expression tag	UNP Q9BYF1
F	623	HIS	-	expression tag	UNP Q9BYF1

- Molecule 3 is an oligosaccharide called 2-acetamido-2-deoxy-beta-D-glucopyranose-(1-4)-2-acetamido-2-deoxy-beta-D-glucopyranose.



Mol	Chain	Residues	Atoms				AltConf	Trace
			Total	C	N	O		
3	G	2	28	16	2	10	0	0
3	H	2	28	16	2	10	0	0
3	I	2	28	16	2	10	0	0
3	J	2	28	16	2	10	0	0
3	K	2	28	16	2	10	0	0

Continued on next page...

*Continued from previous page...*

Mol	Chain	Residues	Atoms				AltConf	Trace
3	L	2	Total	C	N	O	0	0
			28	16	2	10		
3	M	2	Total	C	N	O	0	0
			28	16	2	10		
3	N	2	Total	C	N	O	0	0
			28	16	2	10		
3	O	2	Total	C	N	O	0	0
			28	16	2	10		
3	P	2	Total	C	N	O	0	0
			28	16	2	10		
3	Q	2	Total	C	N	O	0	0
			28	16	2	10		
3	R	2	Total	C	N	O	0	0
			28	16	2	10		
3	S	2	Total	C	N	O	0	0
			28	16	2	10		
3	T	2	Total	C	N	O	0	0
			28	16	2	10		
3	U	2	Total	C	N	O	0	0
			28	16	2	10		
3	V	2	Total	C	N	O	0	0
			28	16	2	10		
3	W	2	Total	C	N	O	0	0
			28	16	2	10		
3	X	2	Total	C	N	O	0	0
			28	16	2	10		

- Molecule 4 is 2-acetamido-2-deoxy-beta-D-glucopyranose (three-letter code: NAG) (formula:  $C_8H_{15}NO_6$ ).



Mol	Chain	Residues	Atoms				AltConf
			Total	C	N	O	
4	A	1	112	64	8	40	0
4	A	1	112	64	8	40	0
4	A	1	112	64	8	40	0
4	A	1	112	64	8	40	0
4	A	1	112	64	8	40	0
4	A	1	112	64	8	40	0
4	A	1	112	64	8	40	0
4	A	1	112	64	8	40	0
4	A	1	112	64	8	40	0
4	B	1	112	64	8	40	0
4	B	1	112	64	8	40	0
4	B	1	112	64	8	40	0
4	B	1	112	64	8	40	0
4	B	1	112	64	8	40	0
4	B	1	112	64	8	40	0

*Continued on next page...*

*Continued from previous page...*

Mol	Chain	Residues	Atoms				AltConf
			Total	C	N	O	
4	B	1	112	64	8	40	0
4	B	1	112	64	8	40	0
4	C	1	112	64	8	40	0
4	C	1	112	64	8	40	0
4	C	1	112	64	8	40	0
4	C	1	112	64	8	40	0
4	C	1	112	64	8	40	0
4	C	1	112	64	8	40	0
4	C	1	112	64	8	40	0
4	C	1	112	64	8	40	0
4	D	1	84	48	6	30	0
4	D	1	84	48	6	30	0
4	D	1	84	48	6	30	0
4	D	1	84	48	6	30	0
4	D	1	84	48	6	30	0
4	D	1	84	48	6	30	0
4	E	1	84	48	6	30	0
4	E	1	84	48	6	30	0
4	E	1	84	48	6	30	0
4	E	1	84	48	6	30	0
4	E	1	84	48	6	30	0

*Continued on next page...*

*Continued from previous page...*

Mol	Chain	Residues	Atoms				AltConf
			Total	C	N	O	
4	E	1	Total 84	48	6	30	0
4	F	1	Total 84	48	6	30	0
4	F	1	Total 84	48	6	30	0
4	F	1	Total 84	48	6	30	0
4	F	1	Total 84	48	6	30	0
4	F	1	Total 84	48	6	30	0
4	F	1	Total 84	48	6	30	0



### 3 Residue-property plots [i](#)

These plots are drawn for all protein, RNA, DNA and oligosaccharide chains in the entry. The first graphic for a chain summarises the proportions of the various outlier classes displayed in the second graphic. The second graphic shows the sequence view annotated by issues in geometry and atom inclusion in map density. Residues are color-coded according to the number of geometric quality criteria for which they contain at least one outlier: green = 0, yellow = 1, orange = 2 and red = 3 or more. A red diamond above a residue indicates a poor fit to the EM map for this residue (all-atom inclusion < 40%). Stretches of 2 or more consecutive residues without any outlier are shown as a green connector. Residues present in the sample, but not in the model, are shown in grey.

- Molecule 1: Spike glycoprotein

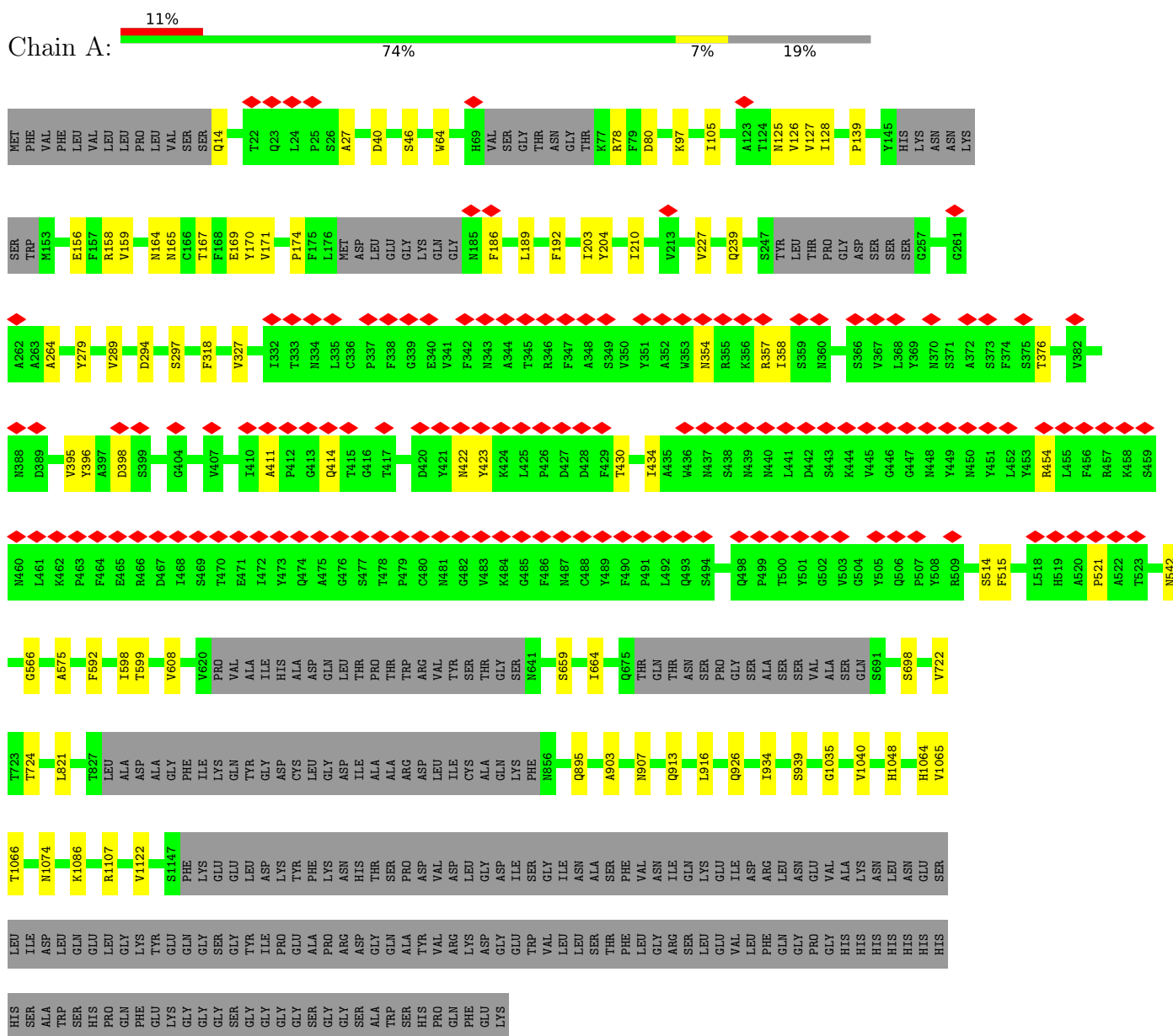

- Molecule 1: Spike glycoprotein

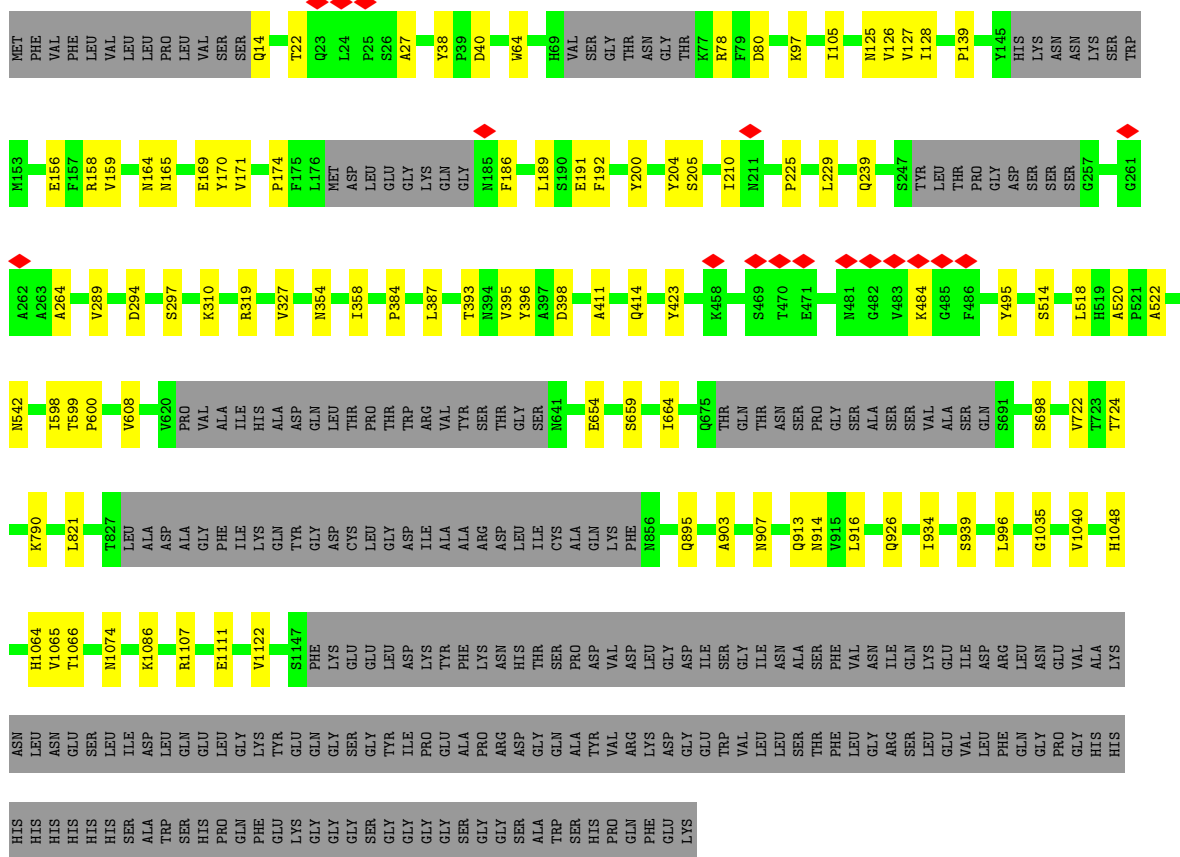
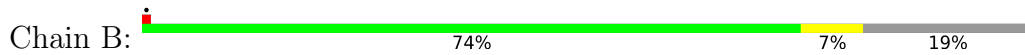

• Molecule 1: Spike glycoprotein

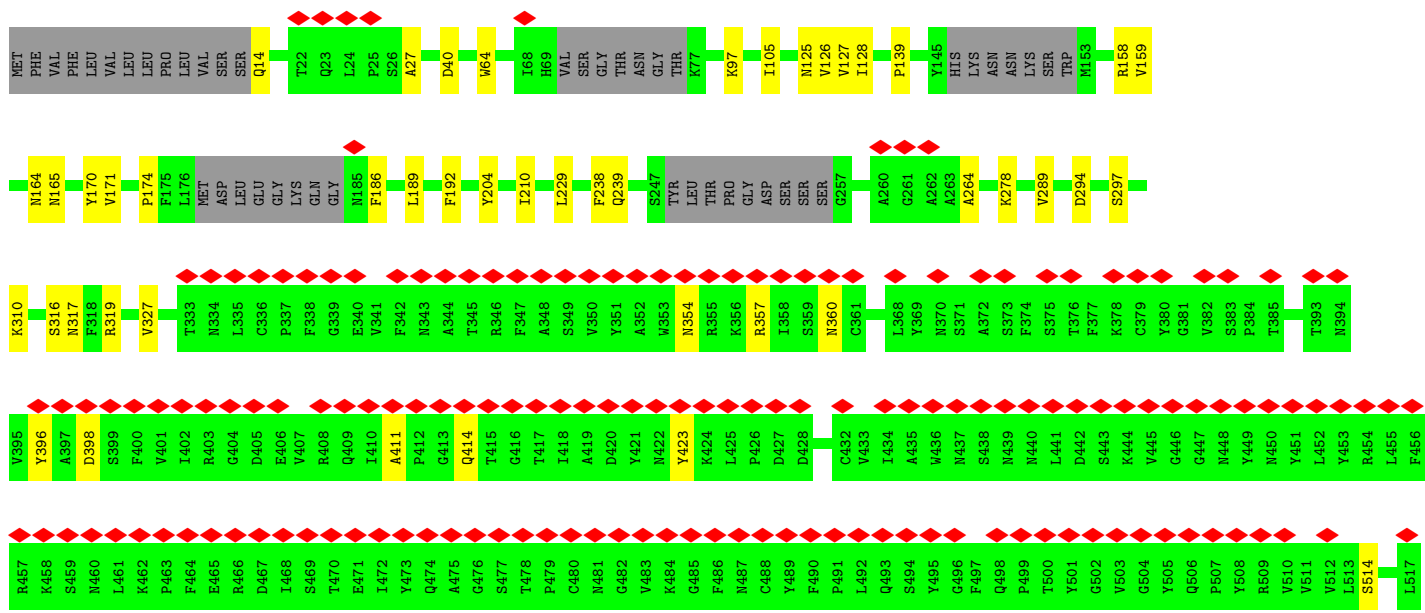
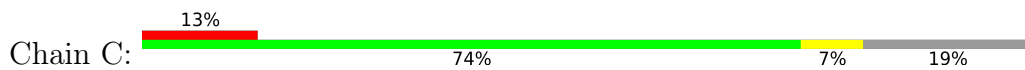

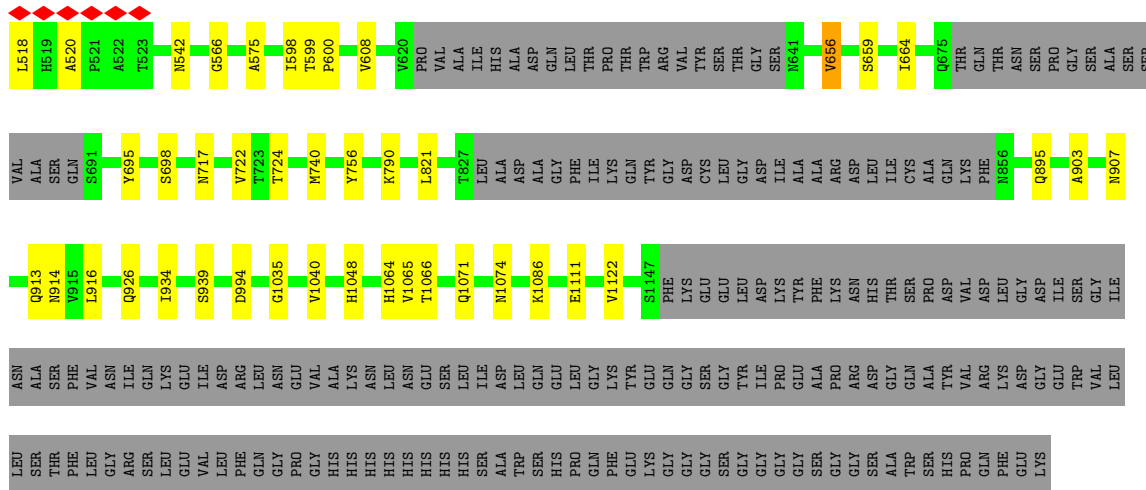

● Molecule 2: Processed angiotensin-converting enzyme 2

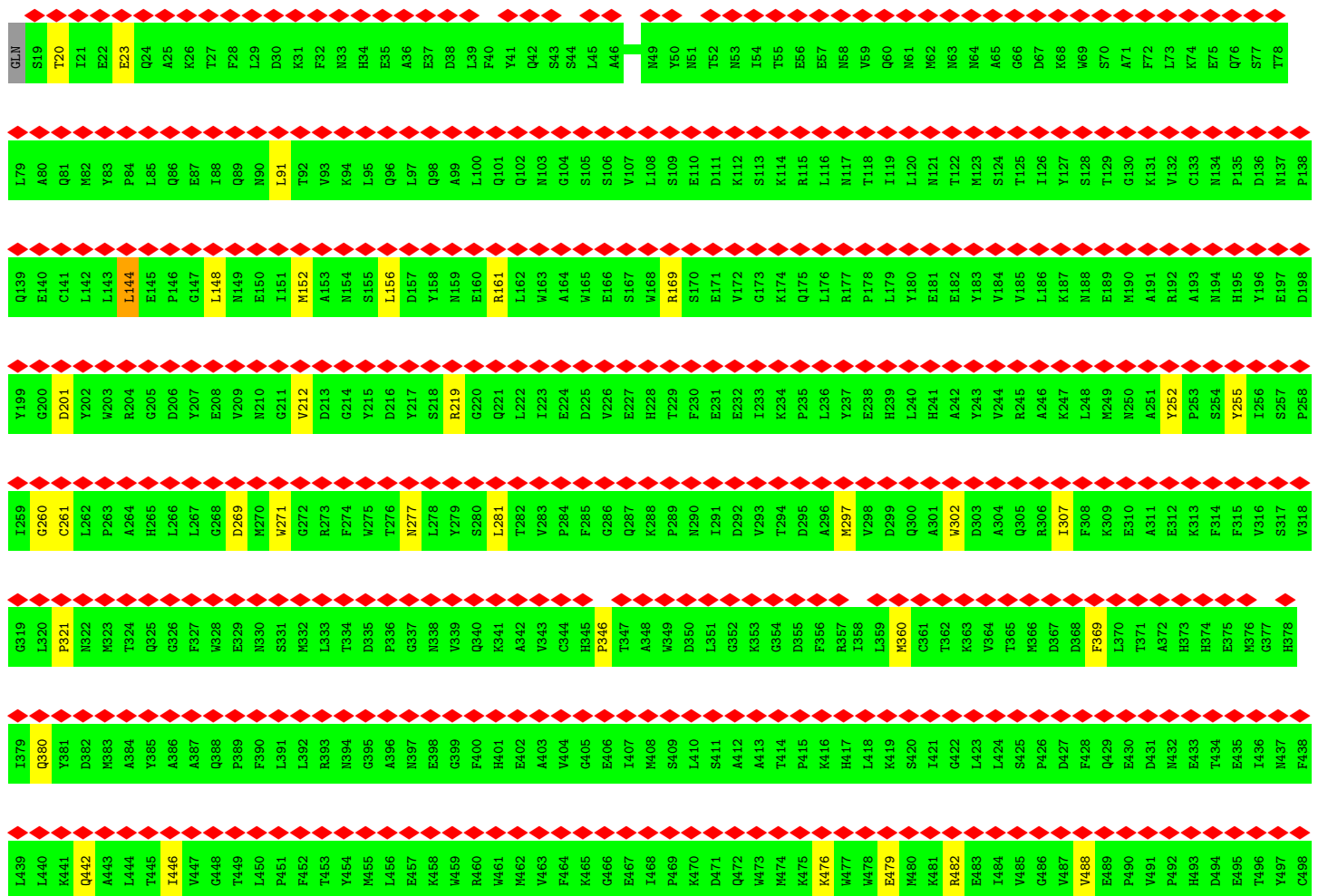
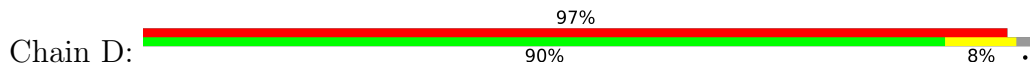



HIS  
HIS  
HIS  
HIS  
HIS

• Molecule 2: Processed angiotensin-converting enzyme 2

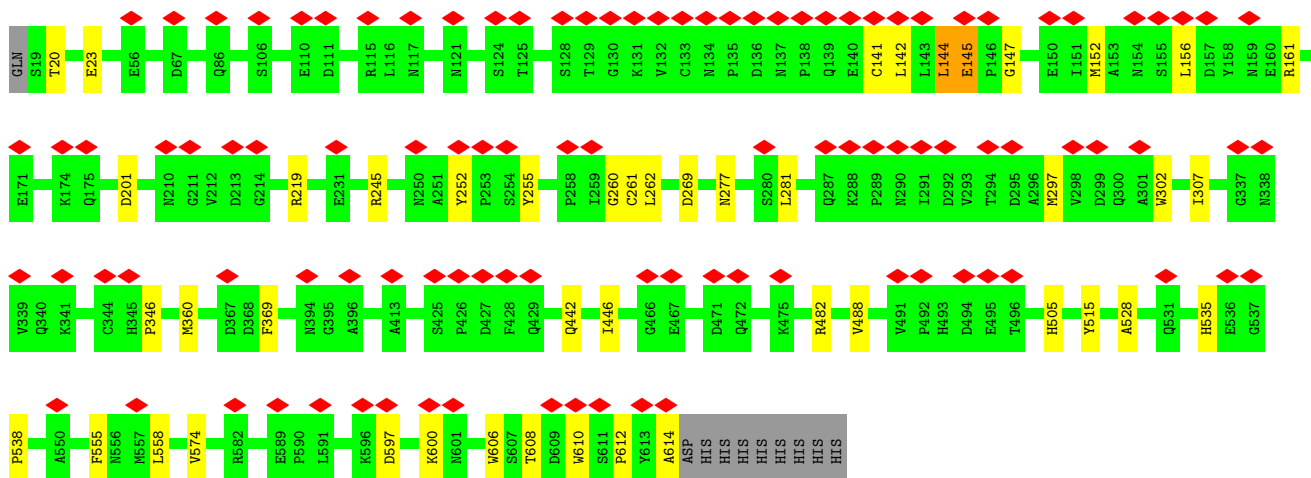
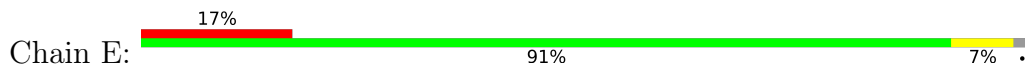

• Molecule 2: Processed angiotensin-converting enzyme 2

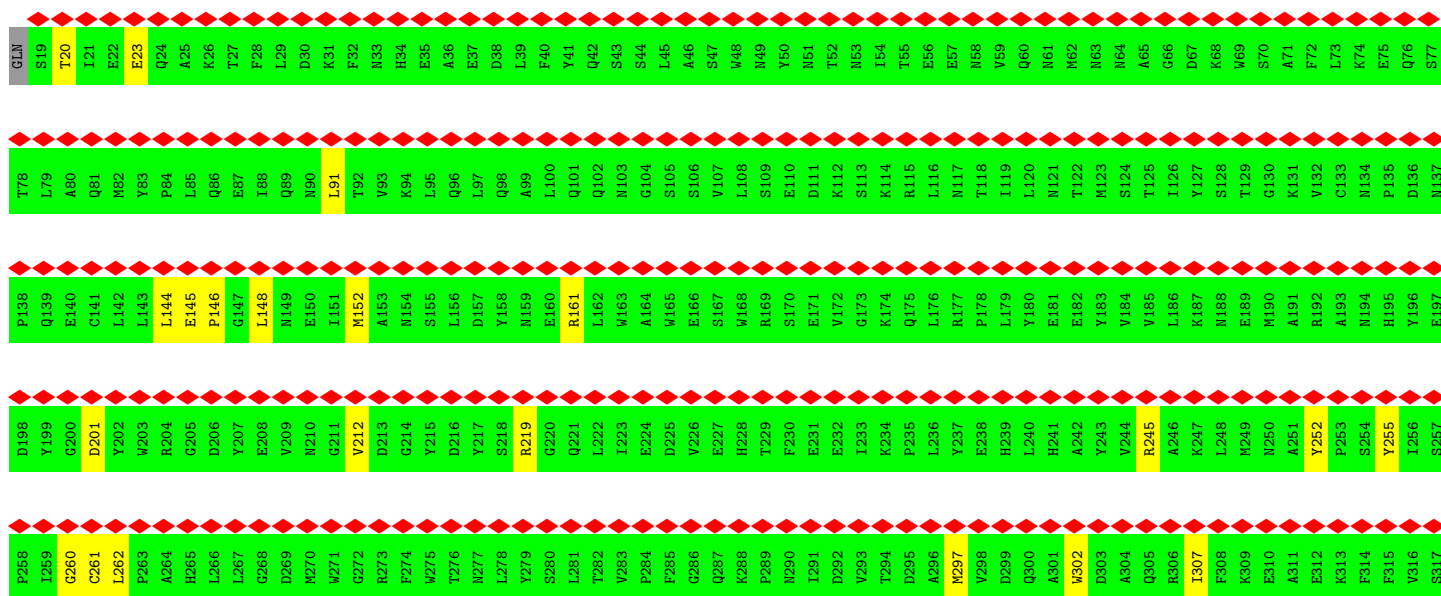
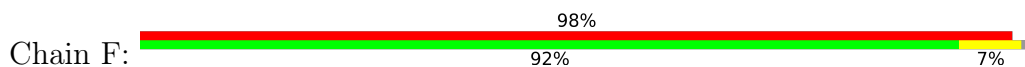

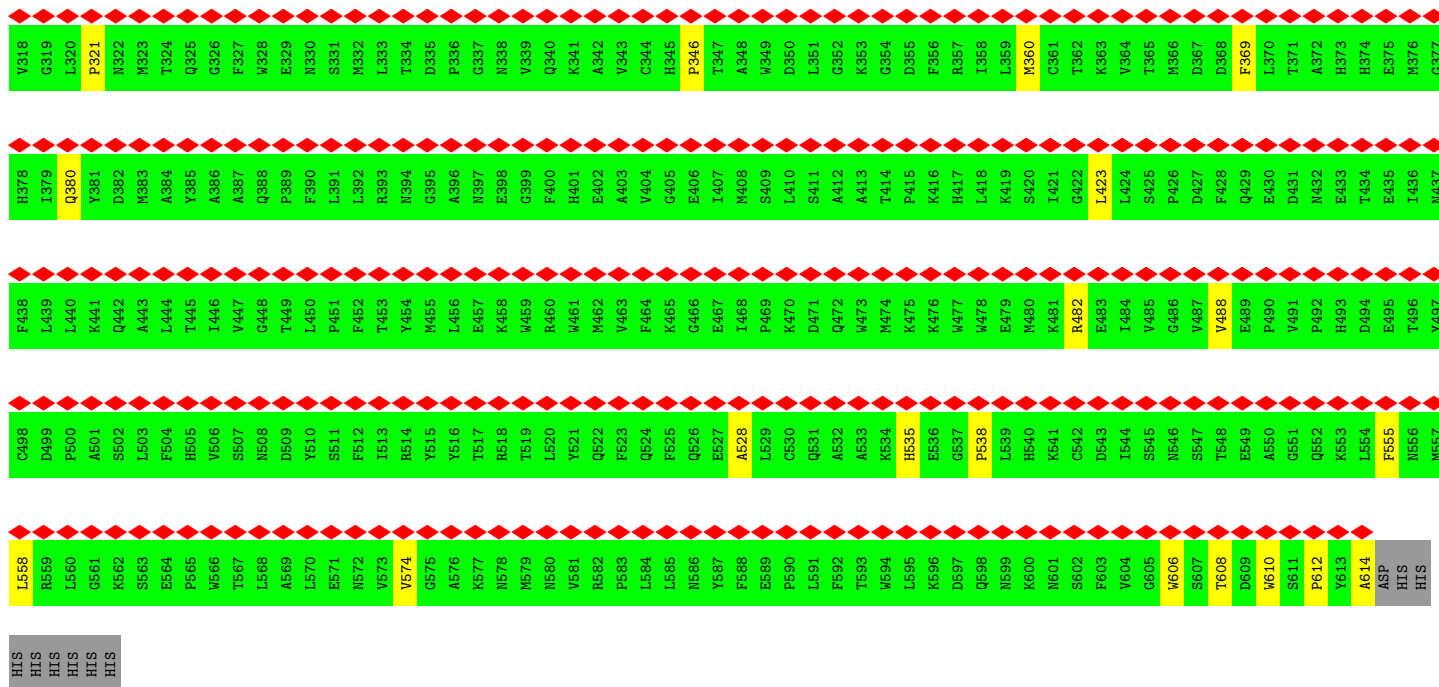

- Molecule 3: 2-acetamido-2-deoxy-beta-D-glucopyranose-(1-4)-2-acetamido-2-deoxy-beta-D-glucopyranose



- Molecule 3: 2-acetamido-2-deoxy-beta-D-glucopyranose-(1-4)-2-acetamido-2-deoxy-beta-D-glucopyranose



- Molecule 3: 2-acetamido-2-deoxy-beta-D-glucopyranose-(1-4)-2-acetamido-2-deoxy-beta-D-glucopyranose



- Molecule 3: 2-acetamido-2-deoxy-beta-D-glucopyranose-(1-4)-2-acetamido-2-deoxy-beta-D-glucopyranose





- Molecule 3: 2-acetamido-2-deoxy-beta-D-glucopyranose-(1-4)-2-acetamido-2-deoxy-beta-D-glucopyranose

Chain K:  100%



- Molecule 3: 2-acetamido-2-deoxy-beta-D-glucopyranose-(1-4)-2-acetamido-2-deoxy-beta-D-glucopyranose

Chain L:  100%



- Molecule 3: 2-acetamido-2-deoxy-beta-D-glucopyranose-(1-4)-2-acetamido-2-deoxy-beta-D-glucopyranose

Chain M:  100%  
100%



- Molecule 3: 2-acetamido-2-deoxy-beta-D-glucopyranose-(1-4)-2-acetamido-2-deoxy-beta-D-glucopyranose

Chain N:  50% 50%



- Molecule 3: 2-acetamido-2-deoxy-beta-D-glucopyranose-(1-4)-2-acetamido-2-deoxy-beta-D-glucopyranose

Chain O:  50% 50%



- Molecule 3: 2-acetamido-2-deoxy-beta-D-glucopyranose-(1-4)-2-acetamido-2-deoxy-beta-D-glucopyranose

Chain P:  100%



- Molecule 3: 2-acetamido-2-deoxy-beta-D-glucopyranose-(1-4)-2-acetamido-2-deoxy-beta-D-glucopyranose

Chain Q:  100%



- Molecule 3: 2-acetamido-2-deoxy-beta-D-glucopyranose-(1-4)-2-acetamido-2-deoxy-beta-D-glucopyranose

Chain R:  100%



- Molecule 3: 2-acetamido-2-deoxy-beta-D-glucopyranose-(1-4)-2-acetamido-2-deoxy-beta-D-glucopyranose

Chain S:  100%  
100%



- Molecule 3: 2-acetamido-2-deoxy-beta-D-glucopyranose-(1-4)-2-acetamido-2-deoxy-beta-D-glucopyranose

Chain T:  50% 50%



- Molecule 3: 2-acetamido-2-deoxy-beta-D-glucopyranose-(1-4)-2-acetamido-2-deoxy-beta-D-glucopyranose

Chain U:  50% 50%



- Molecule 3: 2-acetamido-2-deoxy-beta-D-glucopyranose-(1-4)-2-acetamido-2-deoxy-beta-D-glucopyranose

Chain V:  100%



- Molecule 3: 2-acetamido-2-deoxy-beta-D-glucopyranose-(1-4)-2-acetamido-2-deoxy-beta-D-glucopyranose

Chain W:  100%

HA61  
HA62

- Molecule 3: 2-acetamido-2-deoxy-beta-D-glucopyranose-(1-4)-2-acetamido-2-deoxy-beta-D-glucopyranose

Chain X:  100%

HA61  
HA62



## 4 Experimental information

Property	Value	Source
EM reconstruction method	SINGLE PARTICLE	Depositor
Imposed symmetry	POINT, Not provided	
Number of particles used	92780	Depositor
Resolution determination method	FSC 0.143 CUT-OFF	Depositor
CTF correction method	PHASE FLIPPING AND AMPLITUDE CORRECTION	Depositor
Microscope	TFS KRIOS	Depositor
Voltage (kV)	300	Depositor
Electron dose ( $e^-/\text{\AA}^2$ )	40	Depositor
Minimum defocus (nm)	500	Depositor
Maximum defocus (nm)	3000	Depositor
Magnification	Not provided	
Image detector	FEI FALCON IV (4k x 4k)	Depositor
Maximum map value	1.721	Depositor
Minimum map value	-0.505	Depositor
Average map value	-0.001	Depositor
Map value standard deviation	0.042	Depositor
Recommended contour level	0.211	Depositor
Map size ( $\text{\AA}$ )	400.0, 400.0, 400.0	wwPDB
Map dimensions	400, 400, 400	wwPDB
Map angles ( $^\circ$ )	90.0, 90.0, 90.0	wwPDB
Pixel spacing ( $\text{\AA}$ )	1.0, 1.0, 1.0	Depositor

## 5 Model quality [i](#)

### 5.1 Standard geometry [i](#)

Bond lengths and bond angles in the following residue types are not validated in this section: NAG

The Z score for a bond length (or angle) is the number of standard deviations the observed value is removed from the expected value. A bond length (or angle) with  $|Z| > 5$  is considered an outlier worth inspection. RMSZ is the root-mean-square of all Z scores of the bond lengths (or angles).

Mol	Chain	Bond lengths		Bond angles	
		RMSZ	# Z  >5	RMSZ	# Z  >5
1	A	0.29	0/8330	0.55	0/11340
1	B	0.29	0/8330	0.55	1/11340 (0.0%)
1	C	0.29	0/8330	0.55	0/11340
2	D	0.28	0/4999	0.51	0/6792
2	E	0.28	0/4999	0.51	1/6792 (0.0%)
2	F	0.28	0/4999	0.51	0/6792
All	All	0.28	0/39987	0.54	2/54396 (0.0%)

There are no bond length outliers.

All (2) bond angle outliers are listed below:

Mol	Chain	Res	Type	Atoms	Z	Observed(°)	Ideal(°)
1	B	495	TYR	CA-CB-CG	5.14	123.16	113.40
2	E	141	CYS	CA-CB-SG	5.09	123.16	114.00

There are no chirality outliers.

There are no planarity outliers.

### 5.2 Too-close contacts [i](#)

In the following table, the Non-H and H(model) columns list the number of non-hydrogen atoms and hydrogen atoms in the chain respectively. The H(added) column lists the number of hydrogen atoms added and optimized by MolProbity. The Clashes column lists the number of clashes within the asymmetric unit, whereas Symm-Clashes lists symmetry-related clashes.

Mol	Chain	Non-H	H(model)	H(added)	Clashes	Symm-Clashes
1	A	8139	0	7925	54	0
1	B	8139	0	7925	58	0
1	C	8139	0	7925	54	0

*Continued on next page...*

Continued from previous page...

Mol	Chain	Non-H	H(model)	H(added)	Clashes	Symm-Clashes
2	D	4862	0	4635	27	0
2	E	4862	0	4635	24	0
2	F	4862	0	4635	20	0
3	G	28	0	25	0	0
3	H	28	0	25	1	0
3	I	28	0	25	0	0
3	J	28	0	25	0	0
3	K	28	0	25	0	0
3	L	28	0	25	0	0
3	M	28	0	25	0	0
3	N	28	0	25	1	0
3	O	28	0	25	0	0
3	P	28	0	25	0	0
3	Q	28	0	25	0	0
3	R	28	0	25	0	0
3	S	28	0	25	0	0
3	T	28	0	25	1	0
3	U	28	0	25	0	0
3	V	28	0	25	0	0
3	W	28	0	25	0	0
3	X	28	0	25	0	0
4	A	112	0	104	1	0
4	B	112	0	104	1	0
4	C	112	0	104	1	0
4	D	84	0	78	0	0
4	E	84	0	78	0	0
4	F	84	0	78	0	0
All	All	40095	0	38676	224	0

The all-atom clashscore is defined as the number of clashes found per 1000 atoms (including hydrogen atoms). The all-atom clashscore for this structure is 3.

All (224) close contacts within the same asymmetric unit are listed below, sorted by their clash magnitude.

Atom-1	Atom-2	Interatomic distance (Å)	Clash overlap (Å)
2:D:144:LEU:HA	2:D:148:LEU:HB2	1.75	0.66
1:B:105:ILE:HB	1:B:239:GLN:HB2	1.83	0.61
1:C:105:ILE:HB	1:C:239:GLN:HB2	1.83	0.59
1:B:192:PHE:HA	1:B:204:TYR:O	2.01	0.59
1:A:105:ILE:HB	1:A:239:GLN:HB2	1.83	0.59
1:A:127:VAL:HG21	4:A:1302:NAG:H62	1.85	0.59

Continued on next page...

*Continued from previous page...*

Atom-1	Atom-2	Interatomic distance (Å)	Clash overlap (Å)
1:A:821:LEU:HD11	1:A:939:SER:HB3	1.86	0.58
1:A:396:TYR:HB2	1:A:514:SER:HB3	1.85	0.57
2:F:144:LEU:HA	2:F:148:LEU:HB2	1.86	0.57
1:B:821:LEU:HD11	1:B:939:SER:HB3	1.87	0.57
1:A:192:PHE:HA	1:A:204:TYR:O	2.06	0.56
2:E:505:HIS:HE2	2:E:515:TYR:HH	1.47	0.56
2:F:482:ARG:NH1	2:F:608:THR:O	2.39	0.56
2:D:152:MET:O	2:D:161:ARG:NH1	2.34	0.55
1:C:192:PHE:HA	1:C:204:TYR:O	2.07	0.55
2:E:261:CYS:HB2	2:E:488:VAL:HB	1.89	0.55
1:A:64:TRP:HE1	1:A:264:ALA:HB1	1.72	0.54
1:A:169:GLU:O	1:C:360:ASN:ND2	2.40	0.54
1:C:821:LEU:HD11	1:C:939:SER:HB3	1.88	0.54
1:C:64:TRP:HE1	1:C:264:ALA:HB1	1.72	0.54
2:E:142:LEU:HB3	2:E:147:GLY:HA3	1.88	0.54
2:E:482:ARG:NH1	2:E:608:THR:O	2.41	0.54
1:B:125:ASN:HD22	1:B:171:VAL:HG13	1.72	0.54
1:A:167:THR:O	1:C:357:ARG:NH1	2.42	0.53
1:B:27:ALA:HB3	1:B:64:TRP:HB3	1.90	0.53
2:E:144:LEU:HG	2:E:145:GLU:HG2	1.91	0.53
1:C:1048:HIS:HA	1:C:1066:THR:HG22	1.91	0.53
2:D:555:PHE:HA	2:D:558:LEU:HB2	1.91	0.53
2:F:260:GLY:HA3	2:F:612:PRO:HD3	1.90	0.53
2:D:261:CYS:HB2	2:D:488:VAL:HB	1.90	0.52
1:A:895:GLN:NE2	1:C:1074:ASN:OD1	2.42	0.52
1:C:125:ASN:HD22	1:C:171:VAL:HG13	1.74	0.52
2:D:482:ARG:NH1	2:D:608:THR:O	2.41	0.52
2:D:260:GLY:HA3	2:D:612:PRO:HD3	1.90	0.52
1:A:1048:HIS:HA	1:A:1066:THR:HG22	1.91	0.52
1:A:289:VAL:HG13	1:A:297:SER:HB3	1.92	0.52
2:E:555:PHE:HA	2:E:558:LEU:HB2	1.92	0.52
1:C:294:ASP:OD1	1:C:294:ASP:N	2.43	0.51
1:B:289:VAL:HG13	1:B:297:SER:HB3	1.92	0.51
1:B:128:ILE:HD13	1:B:170:TYR:HD2	1.74	0.51
2:F:261:CYS:HB2	2:F:488:VAL:HB	1.91	0.51
1:A:599:THR:HB	1:A:608:VAL:HG12	1.92	0.51
1:A:294:ASP:OD1	1:A:294:ASP:N	2.43	0.51
1:B:319:ARG:NH2	1:C:740:MET:SD	2.83	0.51
1:B:126:VAL:HG23	1:B:174:PRO:HA	1.93	0.51
2:F:201:ASP:OD2	2:F:219:ARG:NH1	2.44	0.51
1:A:659:SER:HB3	1:A:698:SER:HB3	1.93	0.51

*Continued on next page...*

*Continued from previous page...*

Atom-1	Atom-2	Interatomic distance (Å)	Clash overlap (Å)
2:E:297:MET:HB3	2:E:302:TRP:HB2	1.92	0.50
2:E:20:THR:HG23	2:E:23:GLU:H	1.76	0.50
1:C:289:VAL:HG13	1:C:297:SER:HB3	1.92	0.50
1:A:125:ASN:HD22	1:A:171:VAL:HG13	1.77	0.50
1:B:1048:HIS:HA	1:B:1066:THR:HG22	1.93	0.50
2:E:152:MET:O	2:E:161:ARG:NH1	2.39	0.50
1:A:1074:ASN:OD1	1:B:895:GLN:NE2	2.45	0.50
1:C:599:THR:HB	1:C:608:VAL:HG12	1.94	0.50
1:C:128:ILE:HD13	1:C:170:TYR:HD2	1.77	0.50
2:E:260:GLY:HA3	2:E:612:PRO:HD3	1.94	0.50
1:A:357:ARG:NH1	1:B:169:GLU:OE1	2.44	0.50
1:C:126:VAL:HG23	1:C:174:PRO:HA	1.94	0.50
1:A:430:THR:OG1	1:A:515:PHE:O	2.28	0.50
1:B:599:THR:HB	1:B:608:VAL:HG12	1.93	0.50
2:E:346:PRO:HB3	2:E:360:MET:HE2	1.94	0.49
1:B:294:ASP:N	1:B:294:ASP:OD1	2.43	0.49
1:A:128:ILE:HD13	1:A:170:TYR:HD2	1.77	0.49
2:F:346:PRO:HB3	2:F:360:MET:HE2	1.93	0.49
2:F:20:THR:HG23	2:F:23:GLU:H	1.77	0.49
1:A:1086:LYS:HD2	1:A:1122:VAL:HG11	1.94	0.49
2:F:482:ARG:O	2:F:606:TRP:NE1	2.44	0.49
1:C:926:GLN:NE2	3:T:1:NAG:O6	2.44	0.49
2:D:20:THR:HG23	2:D:23:GLU:H	1.77	0.49
2:D:321:PRO:O	2:D:380:GLN:NE2	2.44	0.49
2:D:346:PRO:HB3	2:D:360:MET:HE2	1.95	0.49
2:F:555:PHE:HA	2:F:558:LEU:HB2	1.95	0.49
1:B:926:GLN:NE2	3:N:1:NAG:O6	2.44	0.49
1:B:1074:ASN:OD1	1:C:895:GLN:NE2	2.44	0.48
1:A:156:GLU:OE2	1:A:158:ARG:NH1	2.47	0.48
1:A:1035:GLY:HA3	1:C:1040:VAL:HG21	1.95	0.48
1:C:127:VAL:HG21	4:C:1302:NAG:H62	1.96	0.48
1:C:724:THR:HG23	1:C:934:ILE:HD12	1.95	0.48
1:B:518:LEU:HD23	1:B:520:ALA:H	1.78	0.48
2:E:252:TYR:HB3	2:E:255:TYR:HD2	1.77	0.48
2:E:505:HIS:NE2	2:E:515:TYR:OH	2.41	0.48
1:A:97:LYS:HG2	1:A:186:PHE:HD1	1.78	0.48
1:A:521:PRO:HG3	1:B:200:TYR:HE1	1.78	0.48
2:E:482:ARG:O	2:E:606:TRP:NE1	2.47	0.48
1:C:396:TYR:HB2	1:C:514:SER:HB3	1.96	0.48
1:B:1086:LYS:HD2	1:B:1122:VAL:HG11	1.95	0.47
2:E:156:LEU:HD11	2:E:281:LEU:HD21	1.96	0.47

*Continued on next page...*

*Continued from previous page...*

Atom-1	Atom-2	Interatomic distance (Å)	Clash overlap (Å)
2:F:152:MET:O	2:F:161:ARG:NH1	2.39	0.47
1:C:1086:LYS:HD2	1:C:1122:VAL:HG11	1.97	0.47
2:F:252:TYR:HB3	2:F:255:TYR:HD2	1.79	0.47
1:C:518:LEU:HD23	1:C:520:ALA:H	1.78	0.47
1:B:97:LYS:HG2	1:B:186:PHE:HD1	1.79	0.47
1:B:914:ASN:ND2	1:B:1111:GLU:OE2	2.44	0.47
1:A:1040:VAL:HG21	1:B:1035:GLY:HA3	1.95	0.47
1:C:27:ALA:HB3	1:C:64:TRP:HB3	1.97	0.47
1:A:722:VAL:HG22	1:A:1065:VAL:HG22	1.97	0.46
2:D:297:MET:HB3	2:D:302:TRP:HB2	1.96	0.46
1:A:27:ALA:HB3	1:A:64:TRP:HB3	1.97	0.46
1:B:724:THR:HG23	1:B:934:ILE:HD12	1.96	0.46
2:D:201:ASP:OD2	2:D:219:ARG:NH1	2.48	0.46
2:D:269:ASP:OD1	2:D:277:ASN:ND2	2.48	0.46
1:B:1040:VAL:HG21	1:C:1035:GLY:HA3	1.95	0.46
1:B:14:GLN:HB3	1:B:158:ARG:HE	1.81	0.46
1:B:191:GLU:O	1:B:205:SER:HA	2.15	0.46
2:E:269:ASP:OD1	2:E:277:ASN:ND2	2.48	0.46
1:B:722:VAL:HG22	1:B:1065:VAL:HG22	1.98	0.46
1:B:156:GLU:OE2	1:B:158:ARG:NH1	2.48	0.46
1:C:97:LYS:HG2	1:C:186:PHE:HD1	1.79	0.46
2:D:252:TYR:HB3	2:D:255:TYR:HD2	1.81	0.46
1:A:422:ASN:ND2	1:A:454:ARG:O	2.46	0.46
1:C:105:ILE:O	1:C:238:PHE:HA	2.16	0.46
1:B:396:TYR:HB2	1:B:514:SER:HB3	1.97	0.45
2:E:201:ASP:OD2	2:E:219:ARG:NH1	2.49	0.45
1:A:354:ASN:O	1:A:398:ASP:HA	2.17	0.45
1:A:724:THR:HG23	1:A:934:ILE:HD12	1.98	0.45
1:B:354:ASN:O	1:B:398:ASP:HA	2.16	0.45
1:A:327:VAL:HG12	1:A:542:ASN:HB3	1.98	0.45
1:B:64:TRP:HE1	1:B:264:ALA:HB1	1.81	0.45
2:F:321:PRO:O	2:F:380:GLN:NE2	2.43	0.45
1:A:598:ILE:HG23	1:A:664:ILE:HG21	1.99	0.45
1:C:914:ASN:ND2	1:C:1111:GLU:OE2	2.45	0.45
2:D:91:LEU:HD11	2:D:212:VAL:HG22	1.99	0.45
1:A:934:ILE:HD13	1:A:934:ILE:HA	1.86	0.45
1:C:40:ASP:N	1:C:40:ASP:OD1	2.50	0.45
1:C:189:LEU:HD12	1:C:210:ILE:HD13	1.98	0.45
1:C:756:TYR:OH	1:C:994:ASP:OD1	2.33	0.45
2:F:535:HIS:NE2	2:F:538:PRO:O	2.45	0.45
1:A:318:PHE:O	1:A:592:PHE:HA	2.16	0.45

*Continued on next page...*

*Continued from previous page...*

Atom-1	Atom-2	Interatomic distance (Å)	Clash overlap (Å)
2:D:482:ARG:O	2:D:606:TRP:NE1	2.49	0.44
1:B:128:ILE:HG21	1:B:229:LEU:HD13	1.99	0.44
1:C:722:VAL:HA	1:C:1064:HIS:O	2.17	0.44
1:A:40:ASP:OD1	1:A:40:ASP:N	2.50	0.44
1:C:790:LYS:HB3	1:C:790:LYS:HE2	1.81	0.44
2:D:527:GLU:OE2	2:D:586:ASN:ND2	2.51	0.44
1:A:1107:ARG:HH22	1:B:907:ASN:HD22	1.66	0.44
1:A:126:VAL:HG23	1:A:174:PRO:HA	1.99	0.44
1:B:40:ASP:OD1	1:B:40:ASP:N	2.49	0.44
2:D:505:HIS:NE2	2:D:515:TYR:OH	2.45	0.44
1:C:354:ASN:O	1:C:398:ASP:HA	2.18	0.44
2:F:297:MET:HB3	2:F:302:TRP:HB2	1.99	0.44
2:D:597:ASP:HA	2:D:600:LYS:HE3	2.00	0.43
1:A:398:ASP:OD2	1:A:423:TYR:OH	2.32	0.43
1:B:327:VAL:HG12	1:B:542:ASN:HB3	2.00	0.43
1:C:722:VAL:HG22	1:C:1065:VAL:HG22	2.01	0.43
2:E:535:HIS:NE2	2:E:538:PRO:O	2.46	0.43
1:B:189:LEU:HD12	1:B:210:ILE:HD13	1.99	0.43
1:C:656:VAL:HG23	1:C:695:TYR:HB3	2.00	0.43
1:A:926:GLN:NE2	3:H:1:NAG:O6	2.48	0.43
1:B:358:ILE:HB	1:B:395:VAL:HB	2.01	0.43
1:C:14:GLN:HB3	1:C:158:ARG:HE	1.82	0.43
1:C:411:ALA:HB3	1:C:414:GLN:HG3	2.01	0.43
2:F:91:LEU:HD11	2:F:212:VAL:HG22	2.01	0.43
1:A:164:ASN:OD1	1:A:165:ASN:N	2.52	0.43
1:B:164:ASN:OD1	1:B:165:ASN:N	2.52	0.43
1:C:327:VAL:HG12	1:C:542:ASN:HB3	2.00	0.43
1:A:376:THR:O	1:A:434:ILE:HA	2.18	0.43
1:A:907:ASN:HD21	1:A:913:GLN:HG3	1.84	0.43
1:B:398:ASP:OD2	1:B:423:TYR:OH	2.31	0.43
2:E:307:ILE:HG23	2:E:369:PHE:HD1	1.84	0.43
2:F:307:ILE:HG23	2:F:369:PHE:HD1	1.84	0.43
1:A:14:GLN:HB3	1:A:158:ARG:HE	1.84	0.42
1:A:358:ILE:HB	1:A:395:VAL:HB	2.01	0.42
1:A:903:ALA:HB1	1:A:913:GLN:HG2	2.01	0.42
2:D:528:ALA:HB2	2:D:574:VAL:HG12	2.01	0.42
2:D:535:HIS:NE2	2:D:538:PRO:O	2.49	0.42
1:B:78:ARG:NH2	1:B:80:ASP:OD1	2.53	0.42
1:B:934:ILE:HD13	1:B:934:ILE:HA	1.85	0.42
1:A:203:ILE:HB	1:A:227:VAL:HG12	2.00	0.42
1:C:566:GLY:N	1:C:575:ALA:O	2.50	0.42

*Continued on next page...*

Continued from previous page...

Atom-1	Atom-2	Interatomic distance (Å)	Clash overlap (Å)
1:A:566:GLY:N	1:A:575:ALA:O	2.50	0.42
1:B:310:LYS:HG3	1:B:600:PRO:HA	2.02	0.42
2:D:169:ARG:HH22	2:D:271:TRP:HA	1.85	0.42
1:A:411:ALA:HB3	1:A:414:GLN:HG3	2.02	0.42
1:C:139:PRO:HB3	1:C:159:VAL:HA	2.02	0.42
1:C:659:SER:HB3	1:C:698:SER:HB3	2.02	0.42
2:E:597:ASP:HA	2:E:600:LYS:HE3	2.01	0.42
1:C:164:ASN:OD1	1:C:165:ASN:N	2.52	0.42
1:B:38:TYR:HB2	1:B:225:PRO:HD3	2.01	0.42
2:D:442:GLN:O	2:D:446:ILE:HB	2.20	0.42
2:F:528:ALA:HB2	2:F:574:VAL:HG12	2.02	0.42
1:B:139:PRO:HB3	1:B:159:VAL:HA	2.02	0.42
1:A:46:SER:HA	1:A:279:TYR:O	2.20	0.41
1:B:903:ALA:HB2	1:B:916:LEU:HD12	2.02	0.41
1:C:903:ALA:HB2	1:C:916:LEU:HD12	2.02	0.41
2:F:245:ARG:HA	2:F:262:LEU:HD21	2.02	0.41
1:A:903:ALA:HB2	1:A:916:LEU:HD12	2.02	0.41
1:B:790:LYS:HE2	1:B:790:LYS:HB3	1.80	0.41
2:D:156:LEU:HD11	2:D:281:LEU:HD21	2.02	0.41
2:D:307:ILE:HG23	2:D:369:PHE:HD1	1.85	0.41
1:A:722:VAL:HA	1:A:1064:HIS:O	2.21	0.41
1:B:384:PRO:HA	1:B:387:LEU:HD12	2.02	0.41
1:B:411:ALA:HB3	1:B:414:GLN:HG3	2.01	0.41
1:B:659:SER:HB3	1:B:698:SER:HB3	2.01	0.41
1:B:22:THR:O	1:B:78:ARG:NH1	2.50	0.41
1:A:78:ARG:NH2	1:A:80:ASP:OD1	2.54	0.41
1:B:598:ILE:HG23	1:B:664:ILE:HG21	2.01	0.41
2:D:610:TRP:HE3	2:D:614:ALA:HB3	1.85	0.41
2:F:610:TRP:HE3	2:F:614:ALA:HB3	1.85	0.41
1:B:996:LEU:HD23	1:B:996:LEU:HA	1.94	0.41
1:C:717:ASN:ND2	1:C:1071:GLN:OE1	2.53	0.41
2:D:476:LYS:O	2:D:479:GLU:HB3	2.20	0.41
2:F:423:LEU:HD23	2:F:423:LEU:HA	1.93	0.41
1:A:189:LEU:HD12	1:A:210:ILE:HD13	2.03	0.41
1:B:1107:ARG:HH22	1:C:907:ASN:HD22	1.69	0.41
1:C:316:SER:OG	1:C:317:ASN:N	2.53	0.41
1:C:907:ASN:HD21	1:C:913:GLN:HG3	1.85	0.41
2:E:442:GLN:O	2:E:446:ILE:HB	2.20	0.41
2:E:610:TRP:HE3	2:E:614:ALA:HB3	1.85	0.41
1:C:128:ILE:HG21	1:C:229:LEU:HD13	2.03	0.41
1:C:310:LYS:HG3	1:C:600:PRO:HA	2.02	0.40

Continued on next page...



Continued from previous page...

Atom-1	Atom-2	Interatomic distance (Å)	Clash overlap (Å)
1:C:598:ILE:HG23	1:C:664:ILE:HG21	2.03	0.40
1:A:139:PRO:HB3	1:A:159:VAL:HA	2.02	0.40
1:B:393:THR:HA	1:B:522:ALA:HA	2.01	0.40
1:B:127:VAL:HG21	4:B:1302:NAG:H62	2.02	0.40
1:B:484:LYS:H	1:B:484:LYS:HG2	1.69	0.40
1:B:903:ALA:HB1	1:B:913:GLN:HG2	2.04	0.40
1:C:398:ASP:OD2	1:C:423:TYR:OH	2.35	0.40
1:C:934:ILE:HD13	1:C:934:ILE:HA	1.87	0.40
2:E:528:ALA:HB2	2:E:574:VAL:HG12	2.04	0.40
1:B:722:VAL:HA	1:B:1064:HIS:O	2.21	0.40
1:C:278:LYS:HE3	1:C:278:LYS:HB2	1.86	0.40
2:D:505:HIS:HE2	2:D:515:TYR:HH	1.57	0.40
2:E:245:ARG:HA	2:E:262:LEU:HD21	2.04	0.40

There are no symmetry-related clashes.

## 5.3 Torsion angles [i](#)

### 5.3.1 Protein backbone [i](#)

In the following table, the Percentiles column shows the percent Ramachandran outliers of the chain as a percentile score with respect to all PDB entries followed by that with respect to all EM entries.

The Analysed column shows the number of residues for which the backbone conformation was analysed, and the total number of residues.

Mol	Chain	Analysed	Favoured	Allowed	Outliers	Percentiles	
1	A	1024/1288 (80%)	1002 (98%)	22 (2%)	0	100	100
1	B	1024/1288 (80%)	1001 (98%)	23 (2%)	0	100	100
1	C	1024/1288 (80%)	1001 (98%)	23 (2%)	0	100	100
2	D	594/606 (98%)	582 (98%)	12 (2%)	0	100	100
2	E	594/606 (98%)	581 (98%)	12 (2%)	1 (0%)	47	64
2	F	594/606 (98%)	580 (98%)	13 (2%)	1 (0%)	47	64
All	All	4854/5682 (85%)	4747 (98%)	105 (2%)	2 (0%)	100	100

All (2) Ramachandran outliers are listed below:

Mol	Chain	Res	Type
2	E	145	GLU
2	F	146	PRO

### 5.3.2 Protein sidechains [i](#)

In the following table, the Percentiles column shows the percent sidechain outliers of the chain as a percentile score with respect to all PDB entries followed by that with respect to all EM entries.

The Analysed column shows the number of residues for which the sidechain conformation was analysed, and the total number of residues.

Mol	Chain	Analysed	Rotameric	Outliers	Percentiles	
1	A	911/1115 (82%)	911 (100%)	0	100	100
1	B	911/1115 (82%)	910 (100%)	1 (0%)	93	97
1	C	911/1115 (82%)	909 (100%)	2 (0%)	93	97
2	D	526/536 (98%)	525 (100%)	1 (0%)	93	97
2	E	526/536 (98%)	525 (100%)	1 (0%)	93	97
2	F	526/536 (98%)	525 (100%)	1 (0%)	93	97
All	All	4311/4953 (87%)	4305 (100%)	6 (0%)	93	97

All (6) residues with a non-rotameric sidechain are listed below:

Mol	Chain	Res	Type
1	B	654	GLU
1	C	319	ARG
1	C	656	VAL
2	D	144	LEU
2	E	144	LEU
2	F	145	GLU

Sometimes sidechains can be flipped to improve hydrogen bonding and reduce clashes. All (3) such sidechains are listed below:

Mol	Chain	Res	Type
1	A	907	ASN
1	B	907	ASN
1	C	907	ASN

### 5.3.3 RNA [i](#)

There are no RNA molecules in this entry.

### 5.4 Non-standard residues in protein, DNA, RNA chains [i](#)

There are no non-standard protein/DNA/RNA residues in this entry.

### 5.5 Carbohydrates [i](#)

36 monosaccharides are modelled in this entry.

In the following table, the Counts columns list the number of bonds (or angles) for which Mogul statistics could be retrieved, the number of bonds (or angles) that are observed in the model and the number of bonds (or angles) that are defined in the Chemical Component Dictionary. The Link column lists molecule types, if any, to which the group is linked. The Z score for a bond length (or angle) is the number of standard deviations the observed value is removed from the expected value. A bond length (or angle) with  $|Z| > 2$  is considered an outlier worth inspection. RMSZ is the root-mean-square of all Z scores of the bond lengths (or angles).

Mol	Type	Chain	Res	Link	Bond lengths			Bond angles		
					Counts	RMSZ	# Z  > 2	Counts	RMSZ	# Z  > 2
3	NAG	G	1	3,1	14,14,15	0.51	0	17,19,21	0.53	0
3	NAG	G	2	3	14,14,15	0.41	0	17,19,21	0.49	0
3	NAG	H	1	3,1	14,14,15	0.22	0	17,19,21	0.59	0
3	NAG	H	2	3	14,14,15	0.37	0	17,19,21	0.48	0
3	NAG	I	1	3,1	14,14,15	0.29	0	17,19,21	1.04	1 (5%)
3	NAG	I	2	3	14,14,15	0.34	0	17,19,21	0.49	0
3	NAG	J	1	3,1	14,14,15	0.26	0	17,19,21	0.54	0
3	NAG	J	2	3	14,14,15	0.35	0	17,19,21	0.48	0
3	NAG	K	1	3,1	14,14,15	0.40	0	17,19,21	0.57	0
3	NAG	K	2	3	14,14,15	0.41	0	17,19,21	0.51	0
3	NAG	L	1	3,1	14,14,15	0.26	0	17,19,21	0.56	0
3	NAG	L	2	3	14,14,15	0.37	0	17,19,21	0.48	0
3	NAG	M	1	3,1	14,14,15	0.52	0	17,19,21	0.53	0
3	NAG	M	2	3	14,14,15	0.40	0	17,19,21	0.48	0
3	NAG	N	1	3,1	14,14,15	0.21	0	17,19,21	0.61	0
3	NAG	N	2	3	14,14,15	0.41	0	17,19,21	0.45	0
3	NAG	O	1	3,1	14,14,15	0.28	0	17,19,21	1.05	1 (5%)
3	NAG	O	2	3	14,14,15	0.34	0	17,19,21	0.49	0
3	NAG	P	1	3,1	14,14,15	0.31	0	17,19,21	0.52	0
3	NAG	P	2	3	14,14,15	0.35	0	17,19,21	0.47	0
3	NAG	Q	1	3,1	14,14,15	0.36	0	17,19,21	0.56	0
3	NAG	Q	2	3	14,14,15	0.36	0	17,19,21	0.51	0

Mol	Type	Chain	Res	Link	Bond lengths			Bond angles		
					Counts	RMSZ	# Z  > 2	Counts	RMSZ	# Z  > 2
3	NAG	R	1	3,1	14,14,15	0.29	0	17,19,21	0.56	0
3	NAG	R	2	3	14,14,15	0.33	0	17,19,21	0.49	0
3	NAG	S	1	3,1	14,14,15	0.51	0	17,19,21	0.54	0
3	NAG	S	2	3	14,14,15	0.41	0	17,19,21	0.48	0
3	NAG	T	1	3,1	14,14,15	0.24	0	17,19,21	0.59	0
3	NAG	T	2	3	14,14,15	0.40	0	17,19,21	0.47	0
3	NAG	U	1	3,1	14,14,15	0.30	0	17,19,21	1.04	1 (5%)
3	NAG	U	2	3	14,14,15	0.33	0	17,19,21	0.50	0
3	NAG	V	1	3,1	14,14,15	0.32	0	17,19,21	0.52	0
3	NAG	V	2	3	14,14,15	0.33	0	17,19,21	0.49	0
3	NAG	W	1	3,1	14,14,15	0.35	0	17,19,21	0.57	0
3	NAG	W	2	3	14,14,15	0.39	0	17,19,21	0.50	0
3	NAG	X	1	3,1	14,14,15	0.24	0	17,19,21	0.58	0
3	NAG	X	2	3	14,14,15	0.37	0	17,19,21	0.48	0

In the following table, the Chirals column lists the number of chiral outliers, the number of chiral centers analysed, the number of these observed in the model and the number defined in the Chemical Component Dictionary. Similar counts are reported in the Torsion and Rings columns. '-' means no outliers of that kind were identified.

Mol	Type	Chain	Res	Link	Chirals	Torsions	Rings
3	NAG	G	1	3,1	-	2/6/23/26	0/1/1/1
3	NAG	G	2	3	-	2/6/23/26	0/1/1/1
3	NAG	H	1	3,1	-	1/6/23/26	0/1/1/1
3	NAG	H	2	3	-	2/6/23/26	0/1/1/1
3	NAG	I	1	3,1	-	3/6/23/26	0/1/1/1
3	NAG	I	2	3	-	0/6/23/26	0/1/1/1
3	NAG	J	1	3,1	-	2/6/23/26	0/1/1/1
3	NAG	J	2	3	-	0/6/23/26	0/1/1/1
3	NAG	K	1	3,1	-	0/6/23/26	0/1/1/1
3	NAG	K	2	3	-	2/6/23/26	0/1/1/1
3	NAG	L	1	3,1	-	2/6/23/26	0/1/1/1
3	NAG	L	2	3	-	2/6/23/26	0/1/1/1
3	NAG	M	1	3,1	-	0/6/23/26	0/1/1/1
3	NAG	M	2	3	-	2/6/23/26	0/1/1/1
3	NAG	N	1	3,1	-	0/6/23/26	0/1/1/1
3	NAG	N	2	3	-	0/6/23/26	0/1/1/1
3	NAG	O	1	3,1	-	3/6/23/26	0/1/1/1
3	NAG	O	2	3	-	0/6/23/26	0/1/1/1
3	NAG	P	1	3,1	-	2/6/23/26	0/1/1/1

Continued on next page...

Continued from previous page...

Mol	Type	Chain	Res	Link	Chirals	Torsions	Rings
3	NAG	P	2	3	-	0/6/23/26	0/1/1/1
3	NAG	Q	1	3,1	-	2/6/23/26	0/1/1/1
3	NAG	Q	2	3	-	0/6/23/26	0/1/1/1
3	NAG	R	1	3,1	-	2/6/23/26	0/1/1/1
3	NAG	R	2	3	-	0/6/23/26	0/1/1/1
3	NAG	S	1	3,1	-	2/6/23/26	0/1/1/1
3	NAG	S	2	3	-	2/6/23/26	0/1/1/1
3	NAG	T	1	3,1	-	0/6/23/26	0/1/1/1
3	NAG	T	2	3	-	1/6/23/26	0/1/1/1
3	NAG	U	1	3,1	-	3/6/23/26	0/1/1/1
3	NAG	U	2	3	-	2/6/23/26	0/1/1/1
3	NAG	V	1	3,1	-	0/6/23/26	0/1/1/1
3	NAG	V	2	3	-	0/6/23/26	0/1/1/1
3	NAG	W	1	3,1	-	0/6/23/26	0/1/1/1
3	NAG	W	2	3	-	2/6/23/26	0/1/1/1
3	NAG	X	1	3,1	-	2/6/23/26	0/1/1/1
3	NAG	X	2	3	-	0/6/23/26	0/1/1/1

There are no bond length outliers.

All (3) bond angle outliers are listed below:

Mol	Chain	Res	Type	Atoms	Z	Observed(°)	Ideal(°)
3	O	1	NAG	C2-N2-C7	3.23	127.51	122.90
3	I	1	NAG	C2-N2-C7	3.21	127.48	122.90
3	U	1	NAG	C2-N2-C7	3.21	127.47	122.90

There are no chirality outliers.

All (43) torsion outliers are listed below:

Mol	Chain	Res	Type	Atoms
3	R	1	NAG	O5-C5-C6-O6
3	J	1	NAG	O5-C5-C6-O6
3	P	1	NAG	O5-C5-C6-O6
3	S	2	NAG	O5-C5-C6-O6
3	L	2	NAG	O5-C5-C6-O6
3	M	2	NAG	O5-C5-C6-O6
3	G	2	NAG	O5-C5-C6-O6
3	G	2	NAG	C4-C5-C6-O6
3	P	1	NAG	C4-C5-C6-O6

Continued on next page...

*Continued from previous page...*

Mol	Chain	Res	Type	Atoms
3	W	2	NAG	C4-C5-C6-O6
3	L	2	NAG	C4-C5-C6-O6
3	M	2	NAG	C4-C5-C6-O6
3	R	1	NAG	C4-C5-C6-O6
3	I	1	NAG	O5-C5-C6-O6
3	J	1	NAG	C4-C5-C6-O6
3	U	1	NAG	O5-C5-C6-O6
3	X	1	NAG	O5-C5-C6-O6
3	S	2	NAG	C4-C5-C6-O6
3	L	1	NAG	O5-C5-C6-O6
3	G	1	NAG	O5-C5-C6-O6
3	I	1	NAG	C4-C5-C6-O6
3	S	1	NAG	O5-C5-C6-O6
3	U	1	NAG	C4-C5-C6-O6
3	L	1	NAG	C4-C5-C6-O6
3	X	1	NAG	C4-C5-C6-O6
3	G	1	NAG	C4-C5-C6-O6
3	S	1	NAG	C4-C5-C6-O6
3	K	2	NAG	C4-C5-C6-O6
3	U	2	NAG	O5-C5-C6-O6
3	W	2	NAG	O5-C5-C6-O6
3	U	2	NAG	C4-C5-C6-O6
3	Q	1	NAG	O5-C5-C6-O6
3	Q	1	NAG	C4-C5-C6-O6
3	O	1	NAG	O5-C5-C6-O6
3	K	2	NAG	O5-C5-C6-O6
3	O	1	NAG	C4-C5-C6-O6
3	H	2	NAG	C4-C5-C6-O6
3	H	2	NAG	O5-C5-C6-O6
3	I	1	NAG	C3-C2-N2-C7
3	H	1	NAG	C4-C5-C6-O6
3	T	2	NAG	C4-C5-C6-O6
3	O	1	NAG	C3-C2-N2-C7
3	U	1	NAG	C3-C2-N2-C7

There are no ring outliers.

3 monomers are involved in 3 short contacts:

Mol	Chain	Res	Type	Clashes	Symm-Clashes
3	T	1	NAG	1	0
3	H	1	NAG	1	0
3	N	1	NAG	1	0

The following is a two-dimensional graphical depiction of Mogul quality analysis of bond lengths, bond angles, torsion angles, and ring geometry for oligosaccharide.

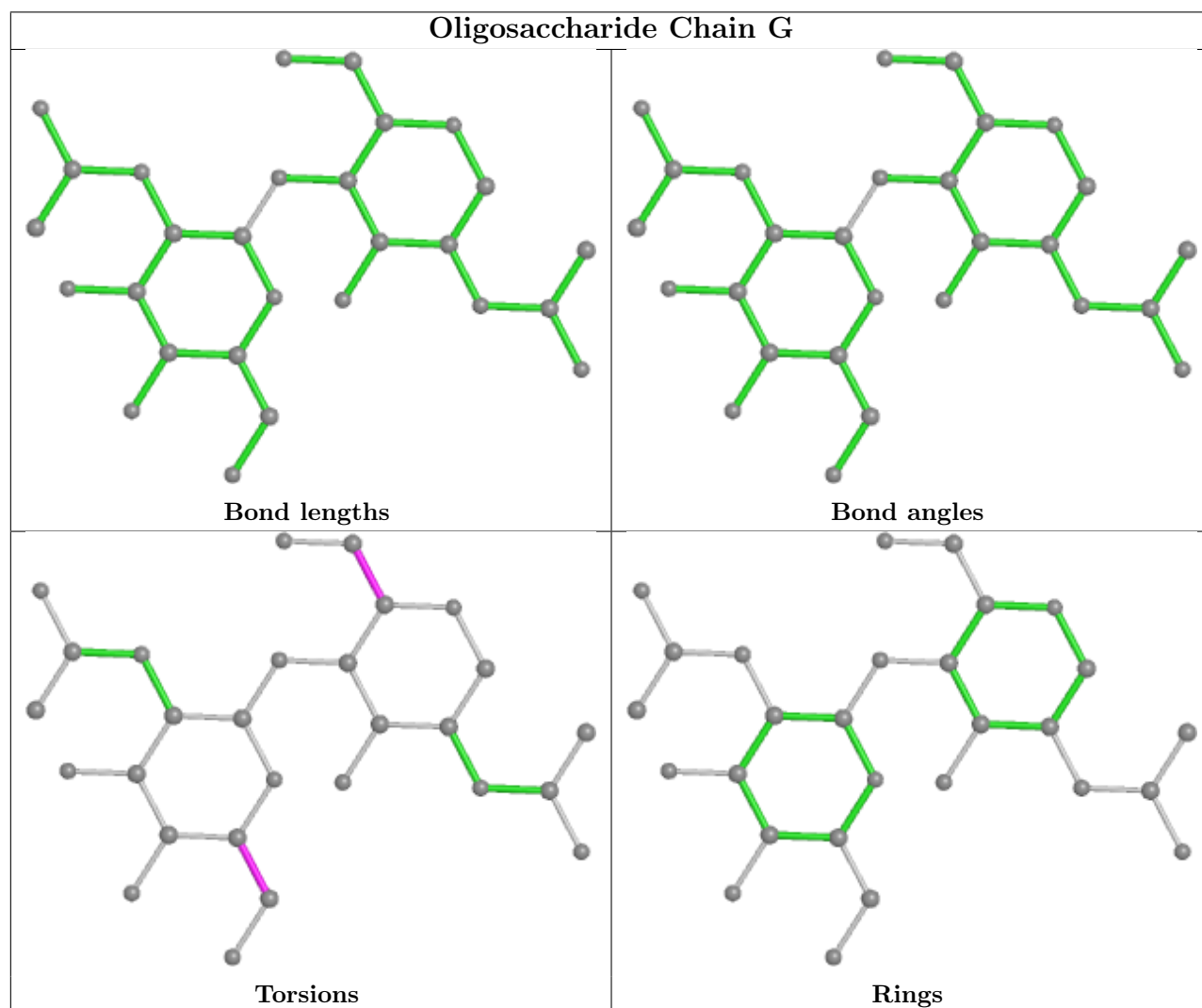

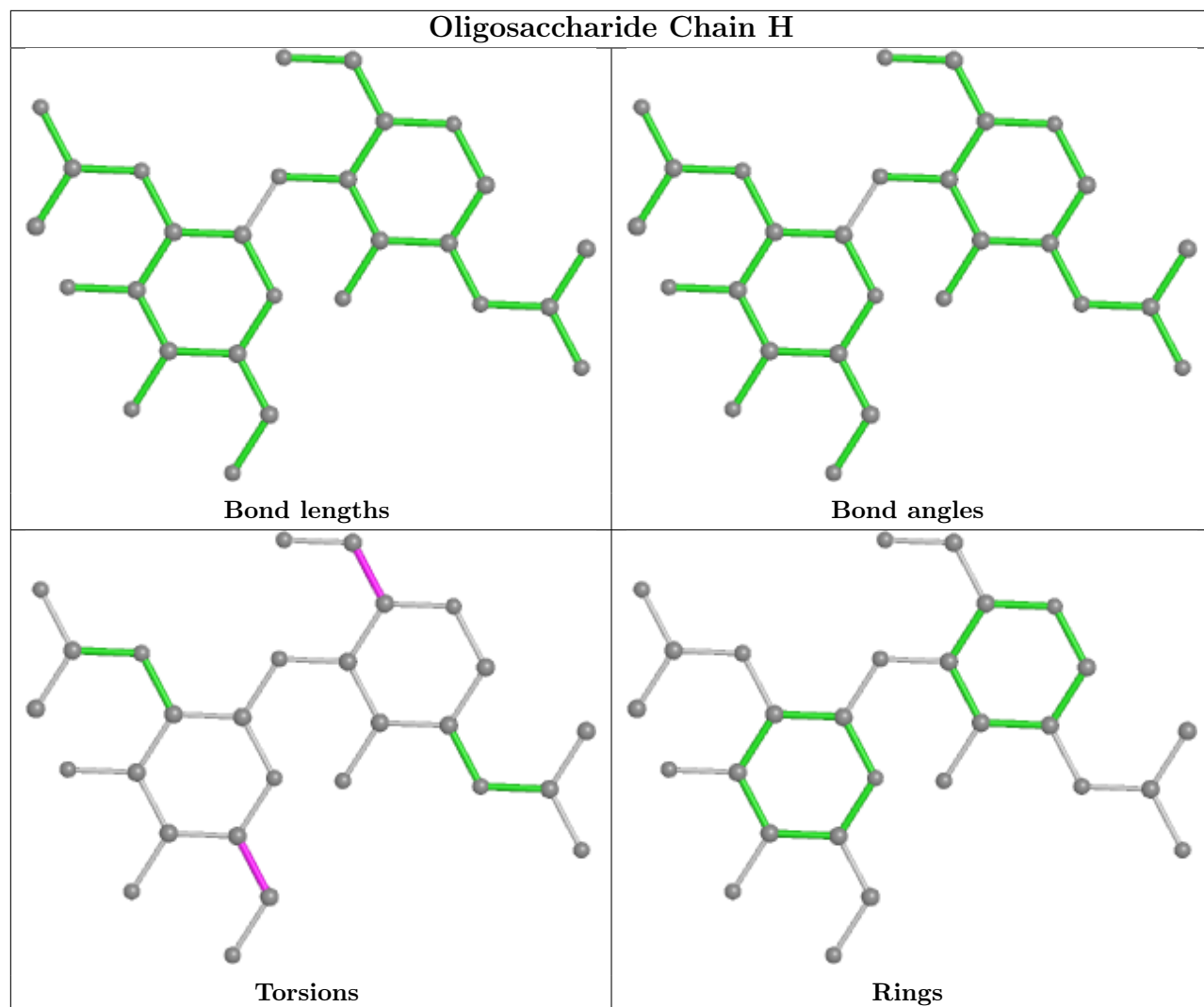



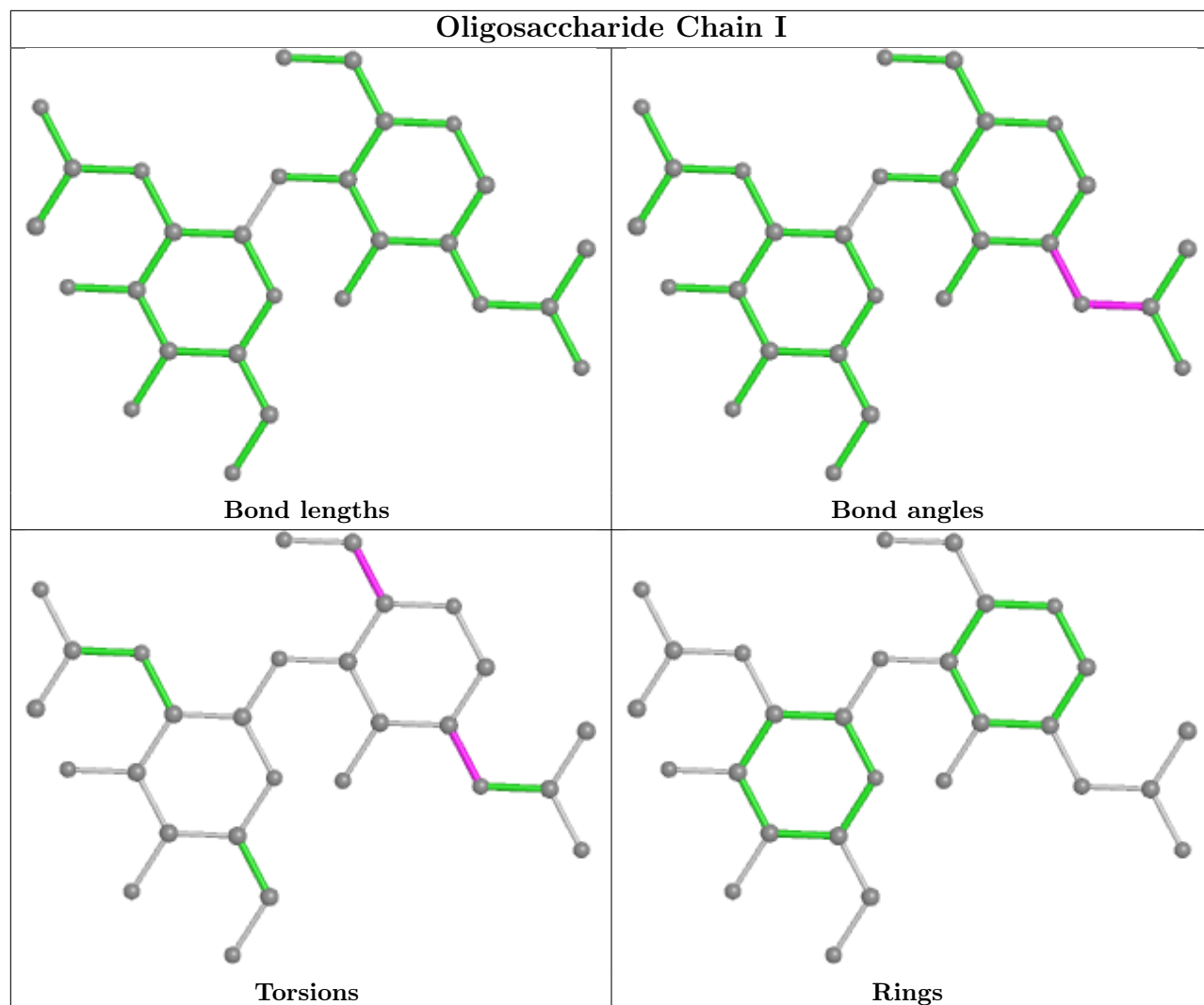

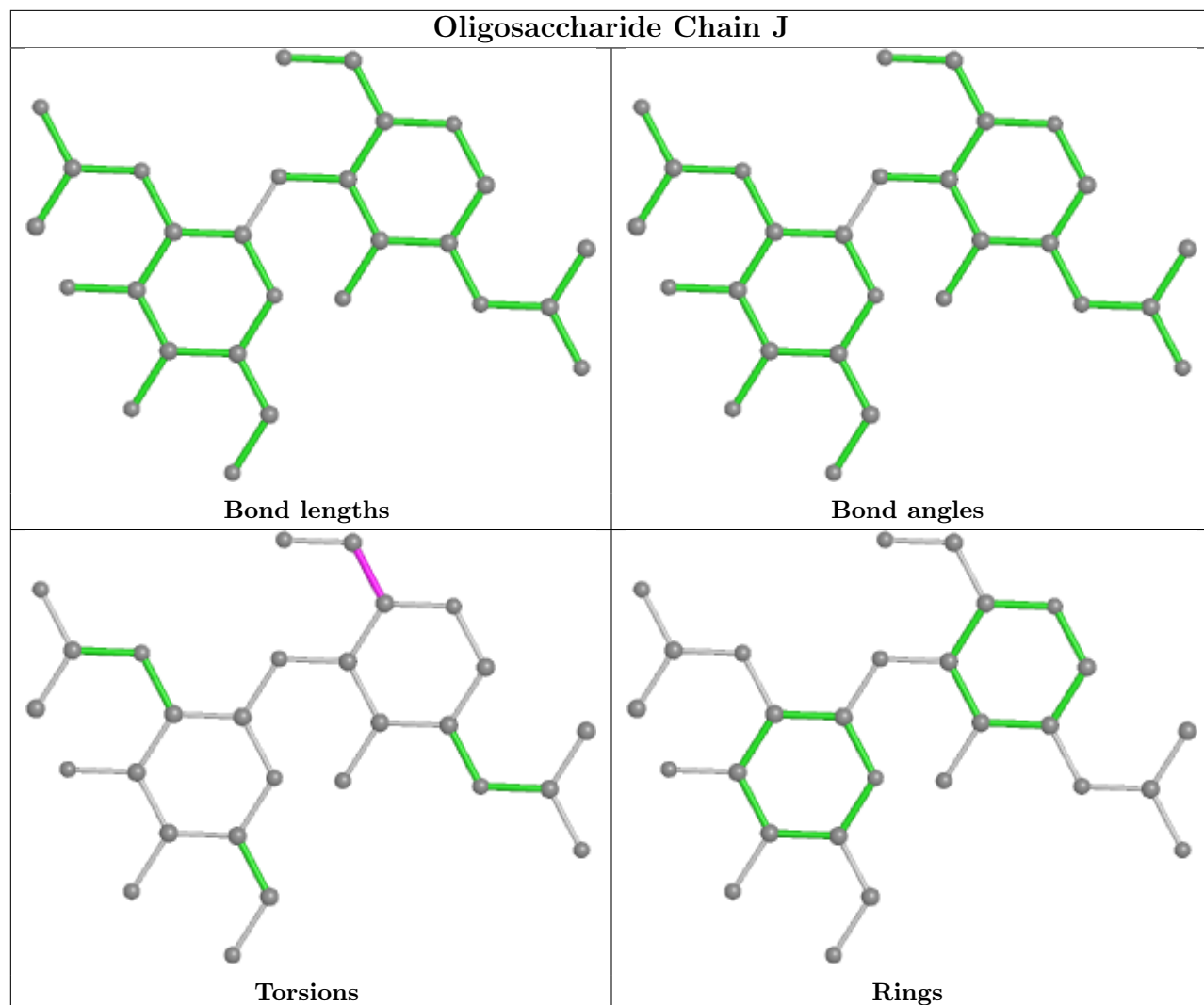

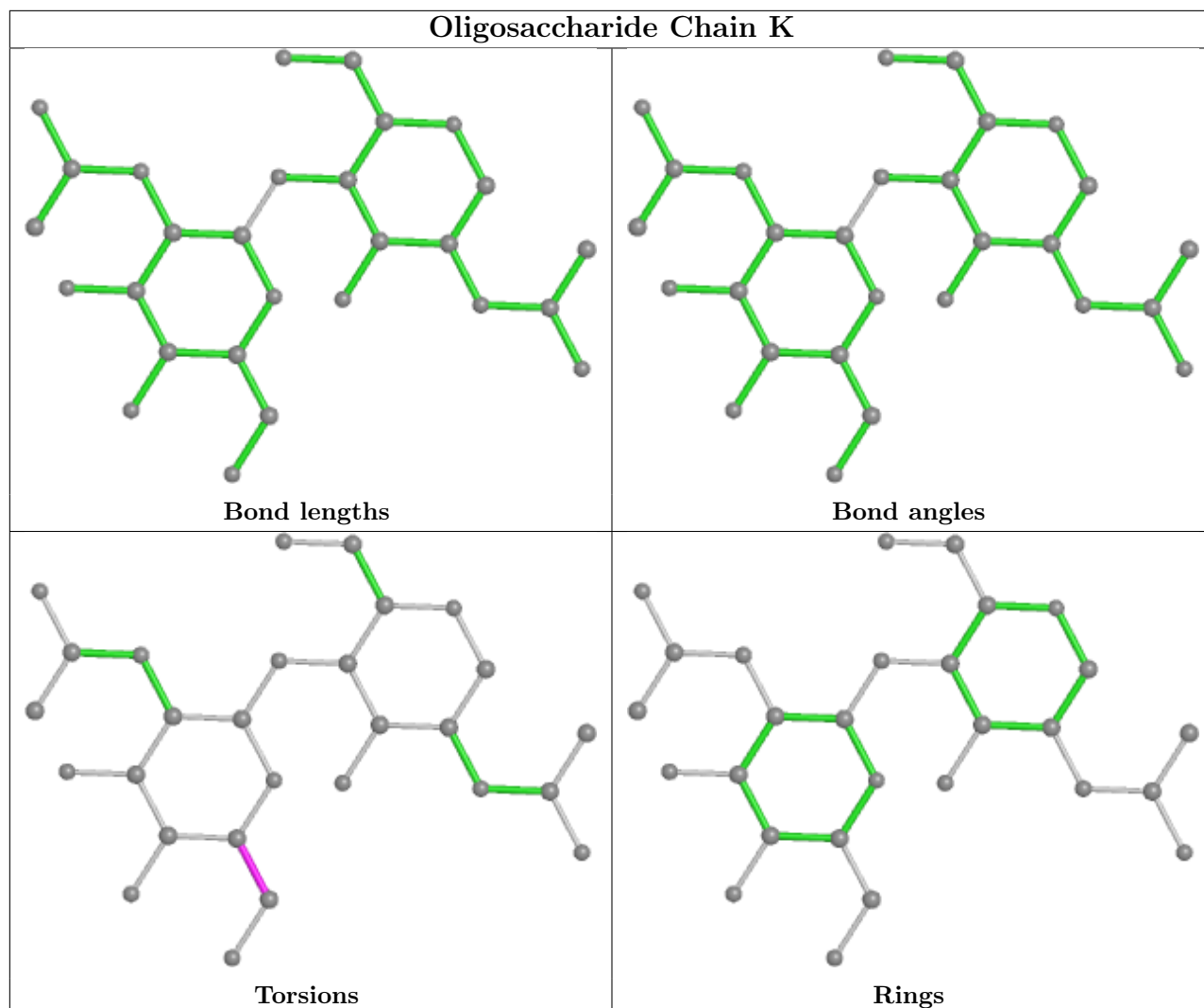

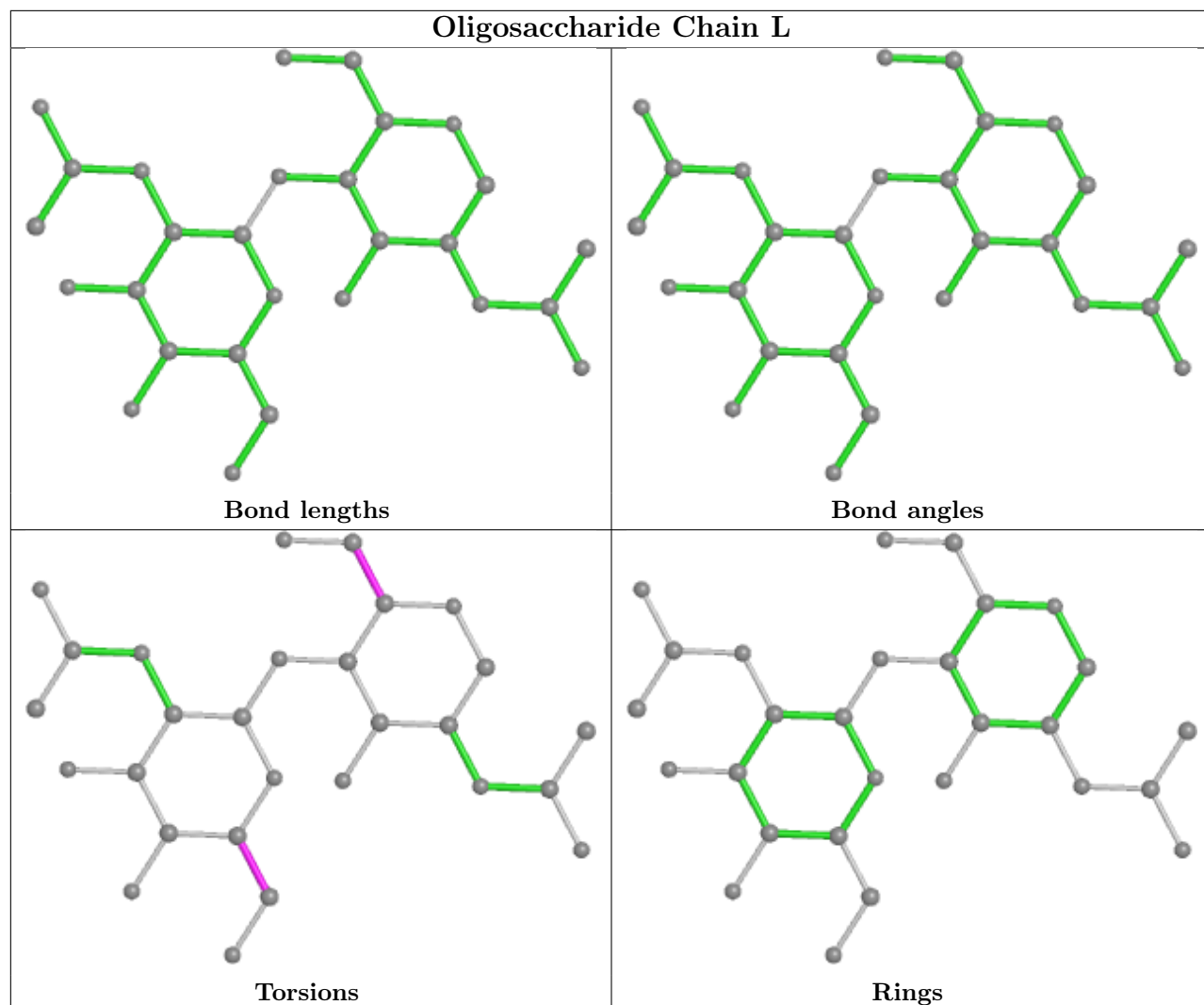

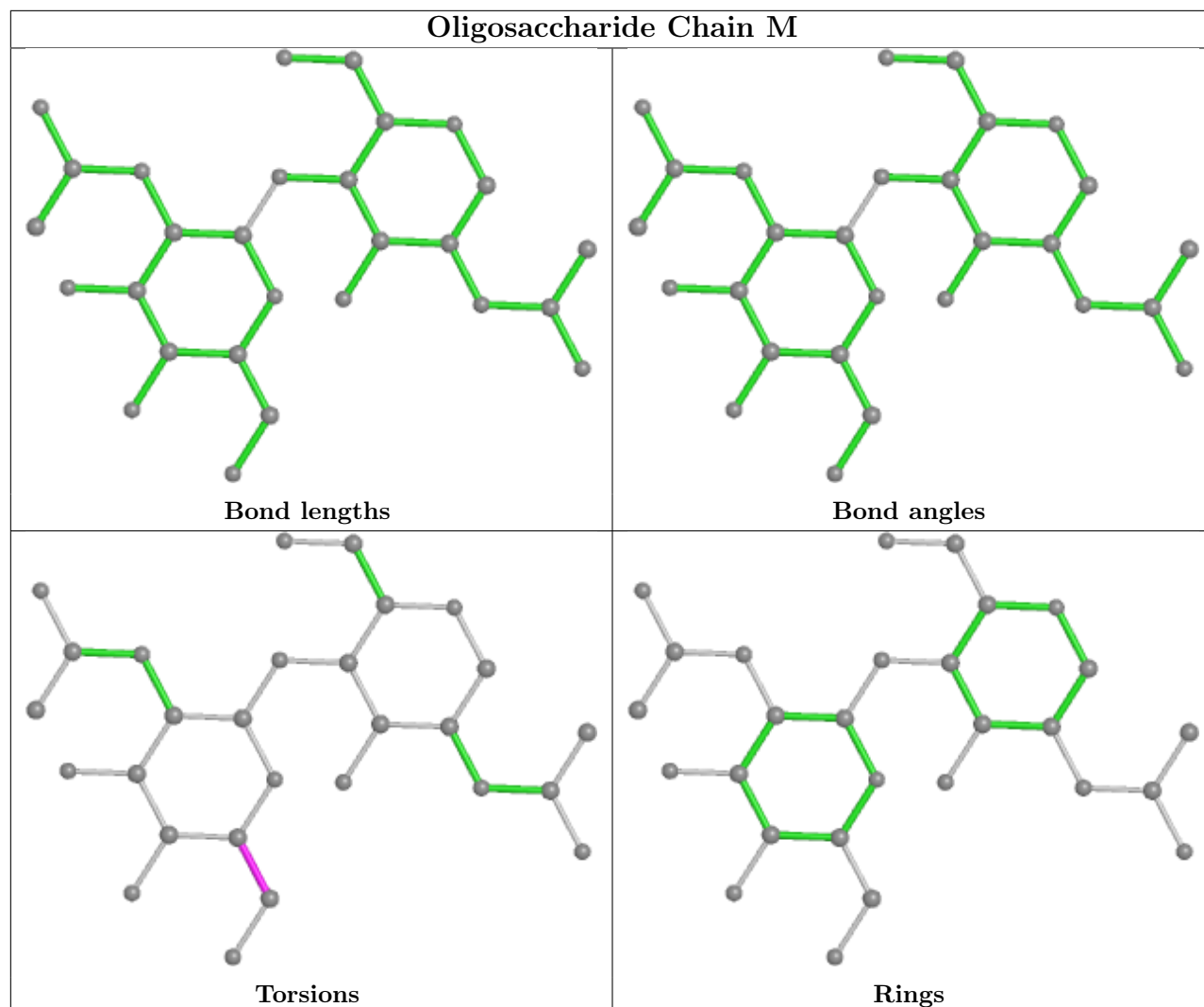

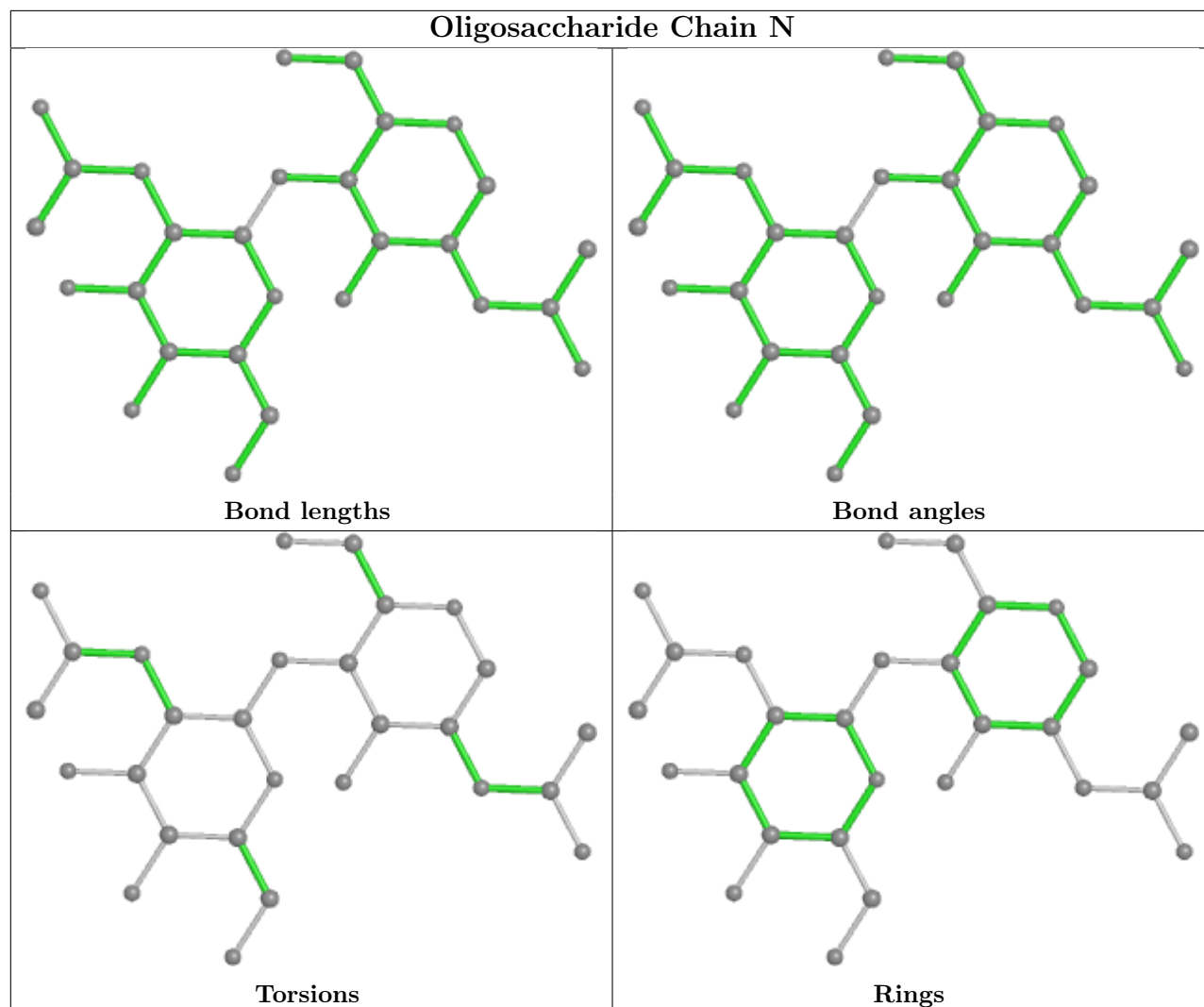

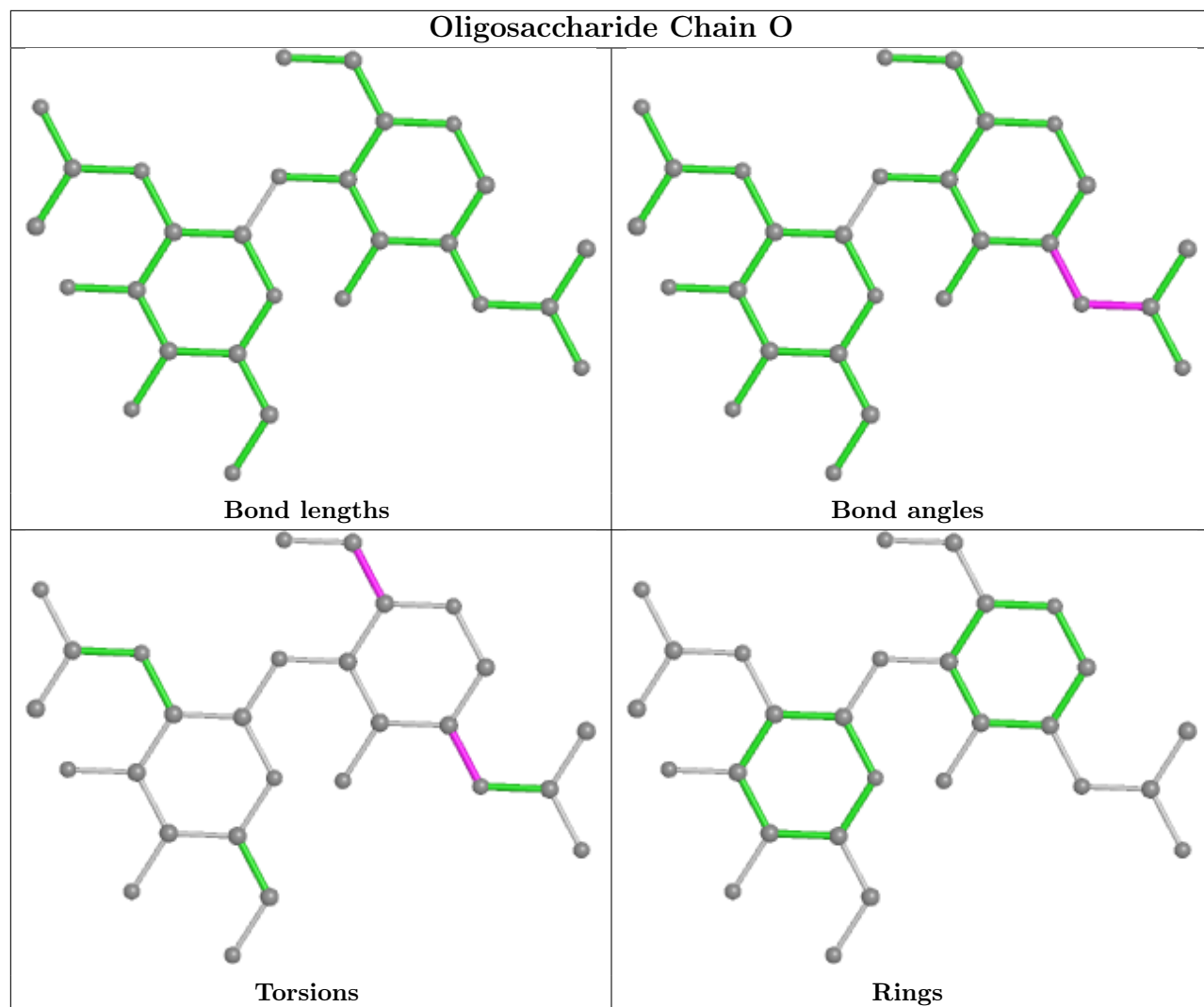

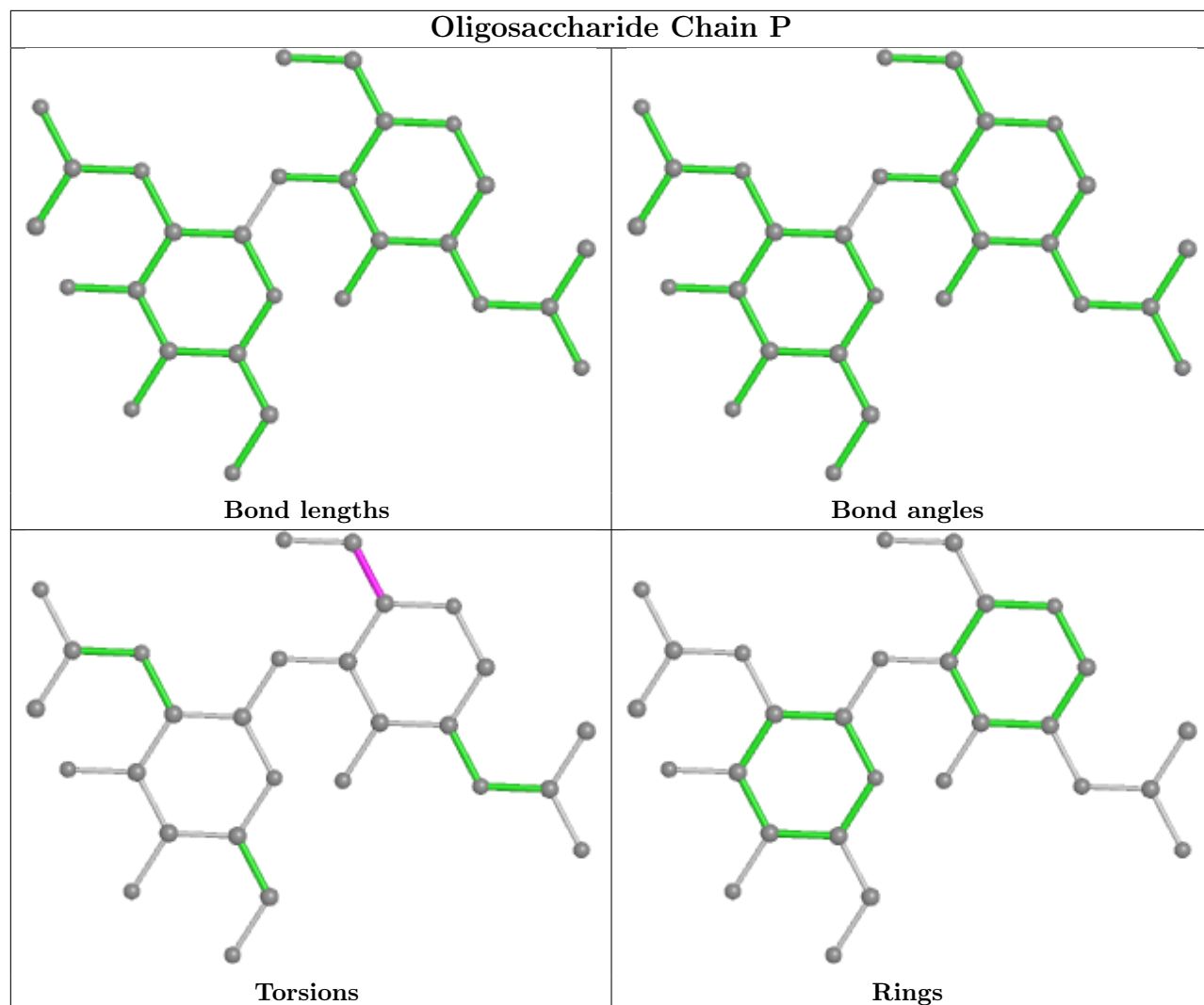



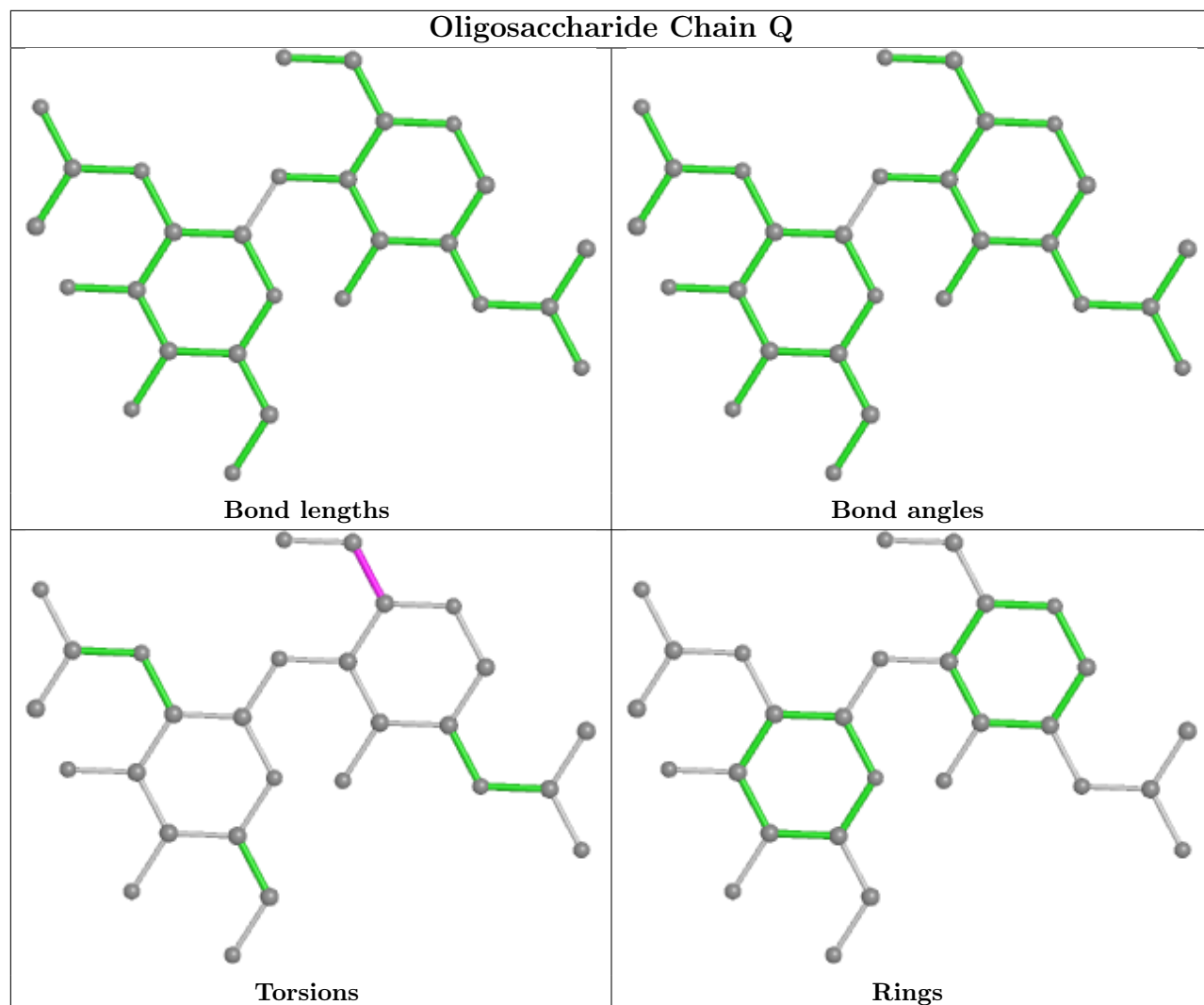

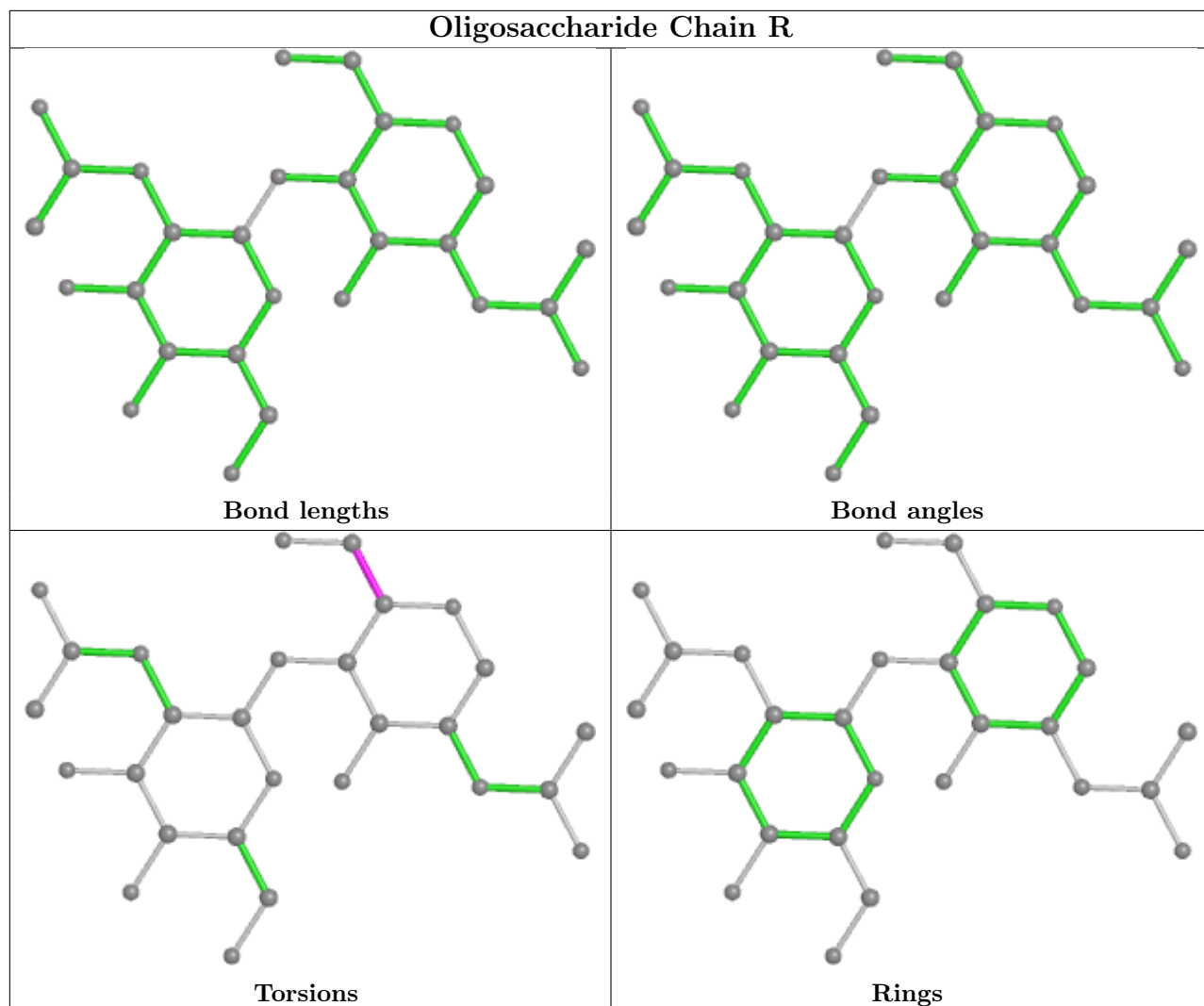

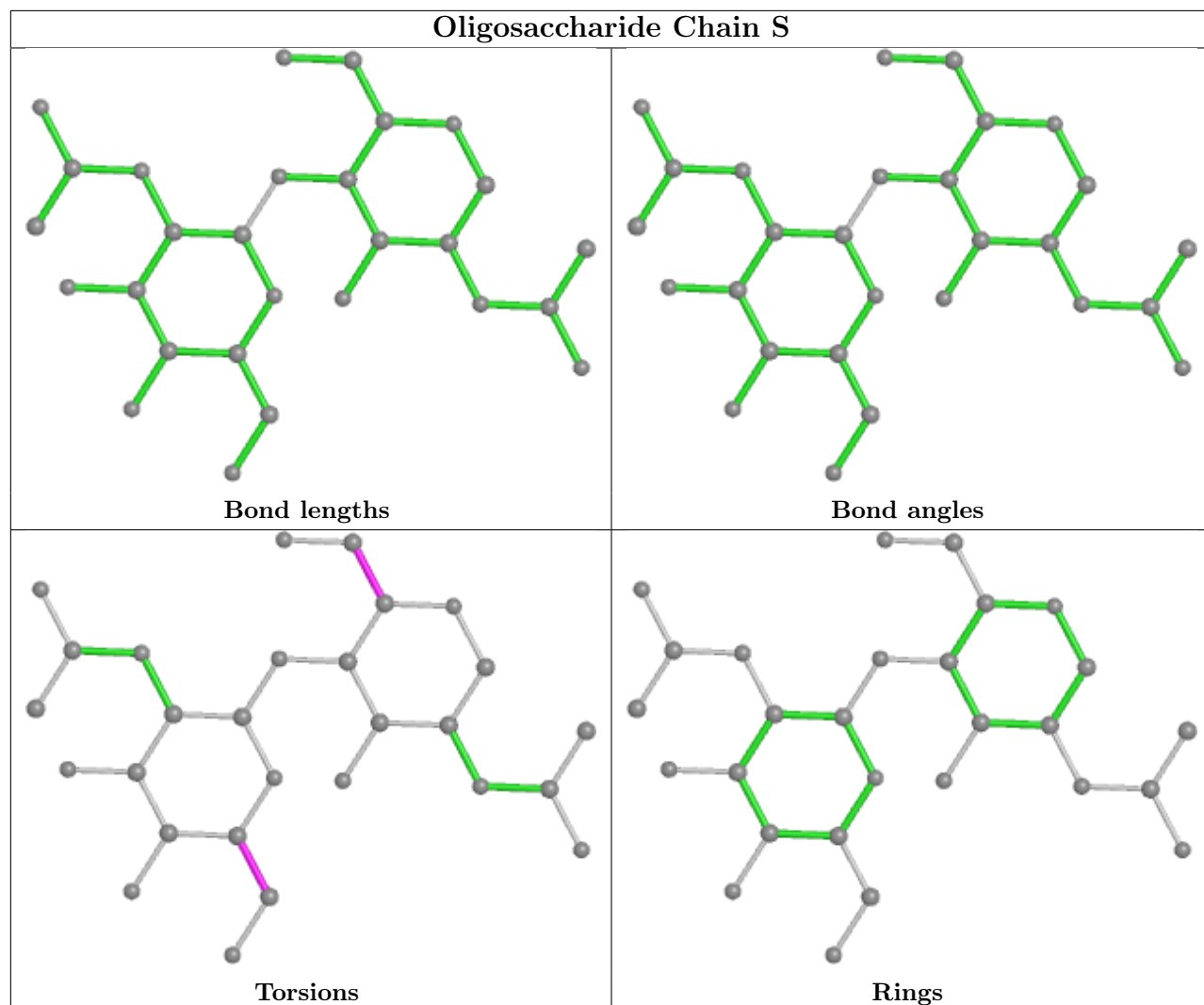

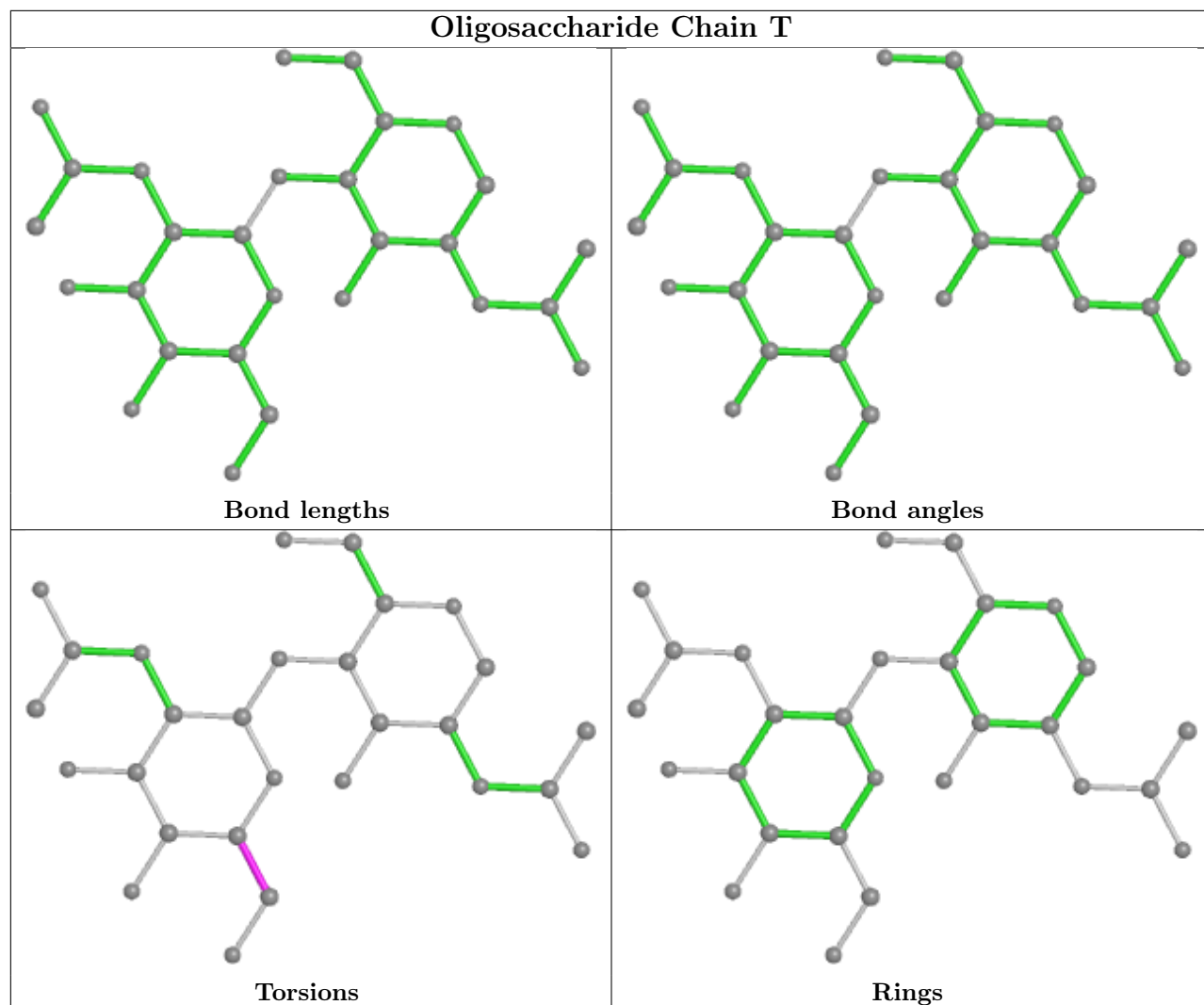

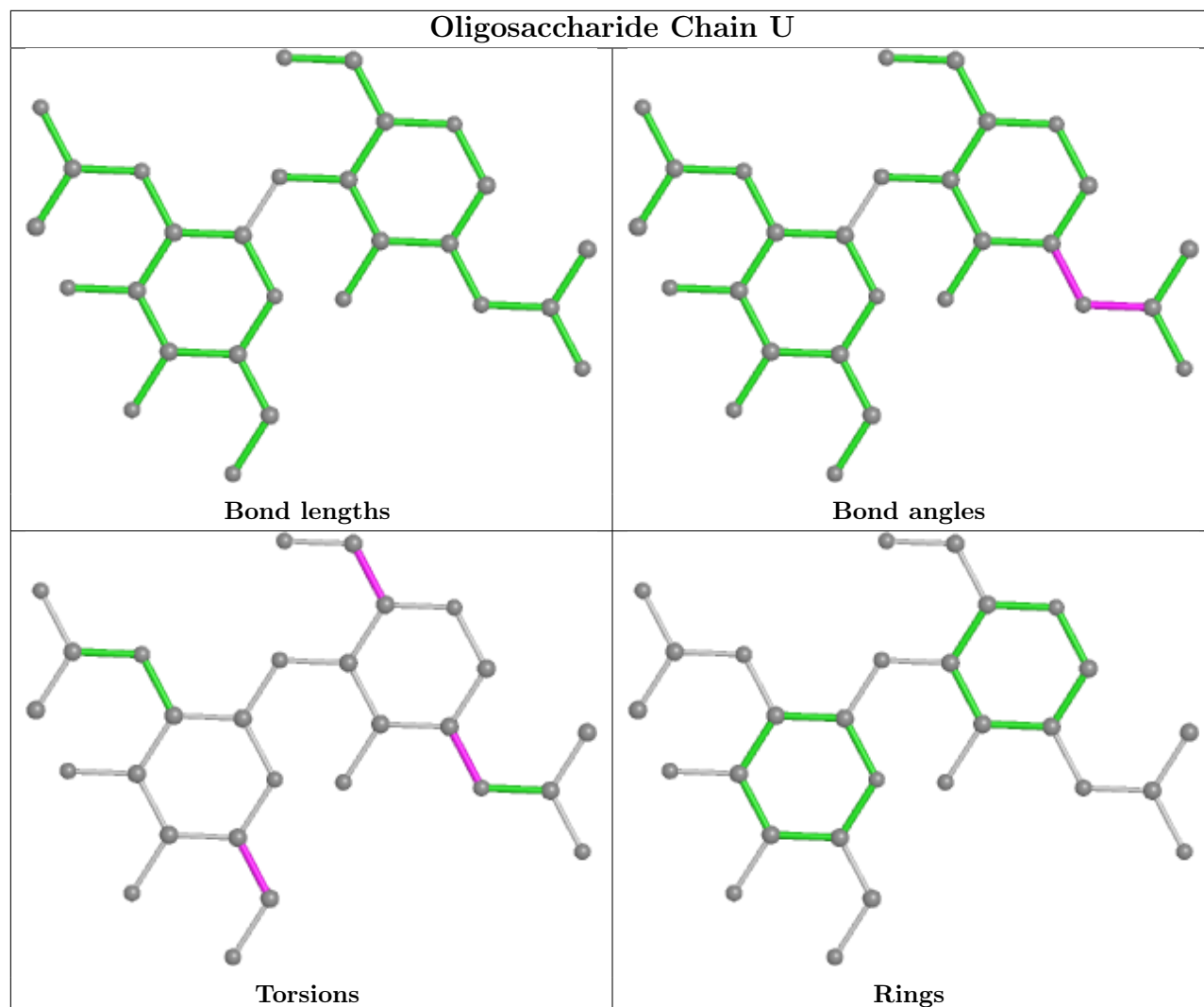

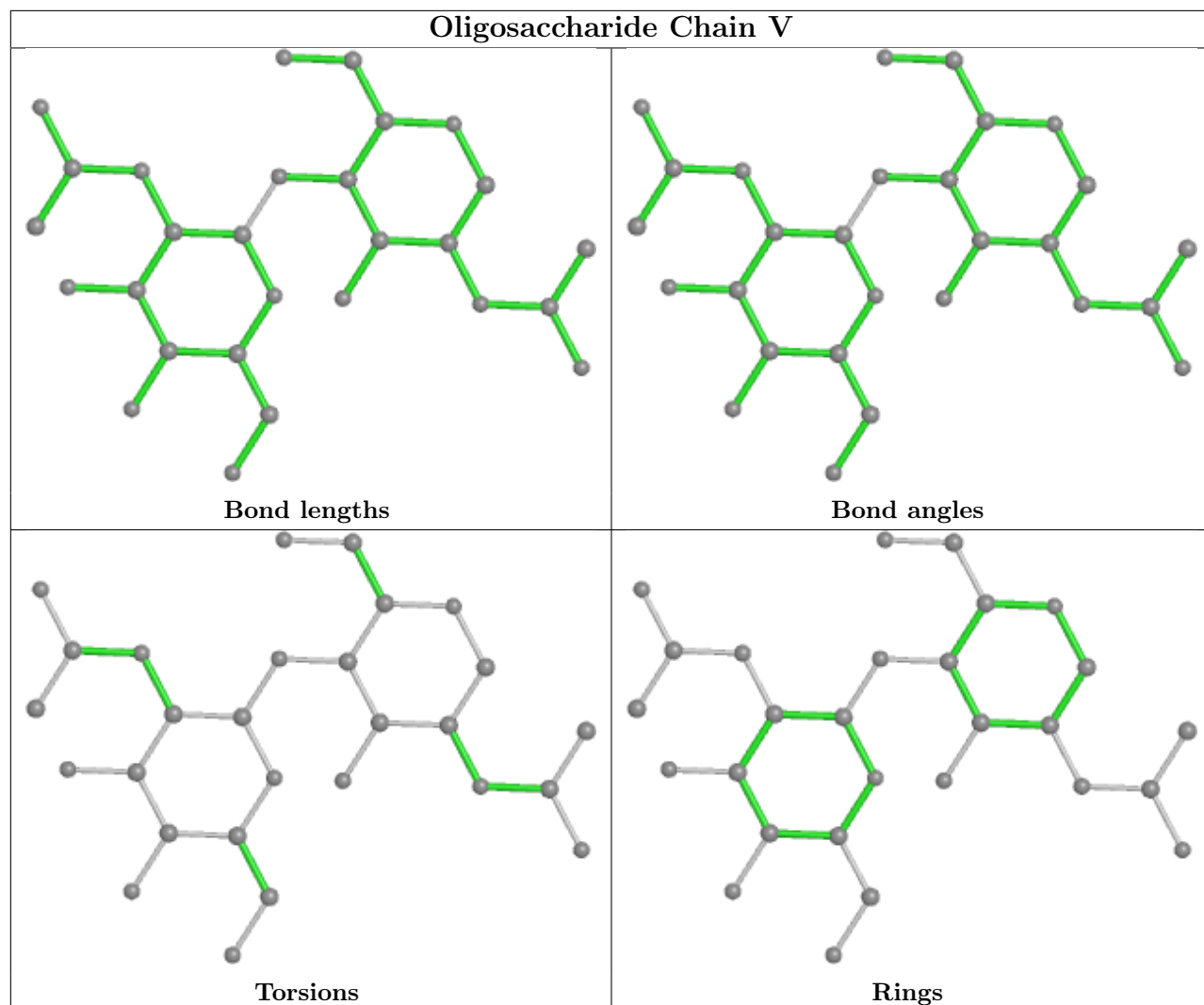

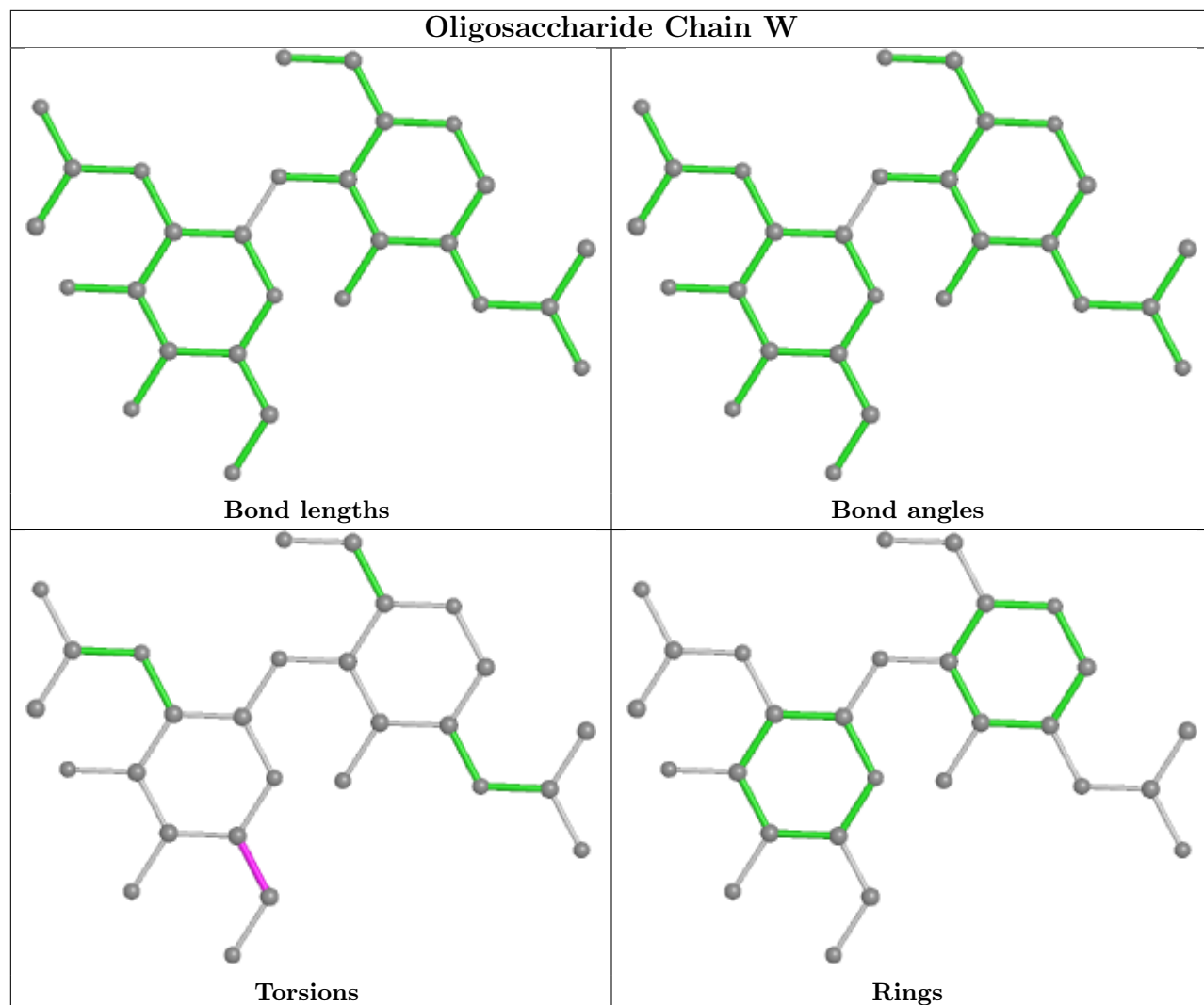

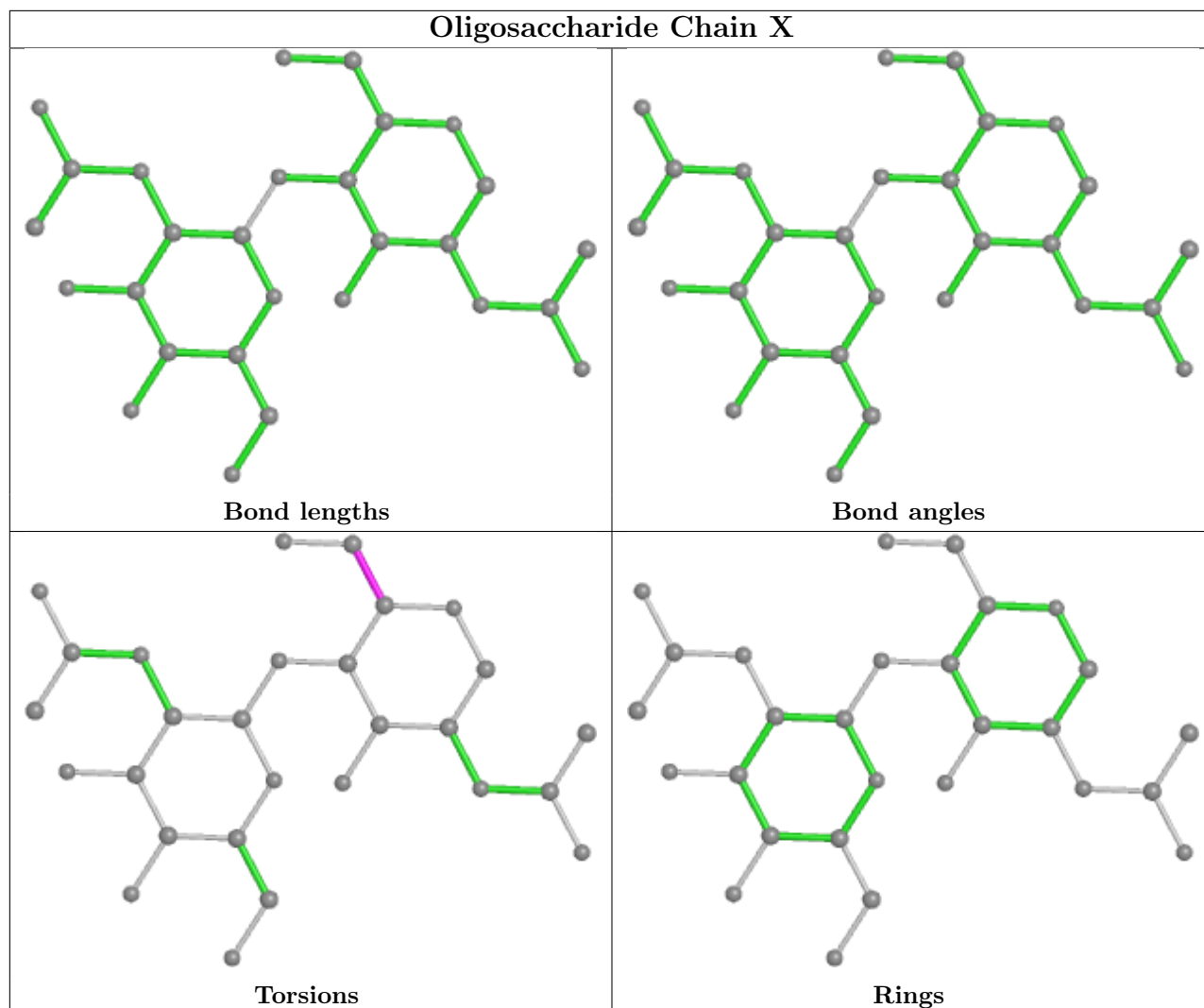

## 5.6 Ligand geometry [i](#)

42 ligands are modelled in this entry.

In the following table, the Counts columns list the number of bonds (or angles) for which Mogul statistics could be retrieved, the number of bonds (or angles) that are observed in the model and the number of bonds (or angles) that are defined in the Chemical Component Dictionary. The Link column lists molecule types, if any, to which the group is linked. The Z score for a bond length (or angle) is the number of standard deviations the observed value is removed from the expected value. A bond length (or angle) with  $|Z| > 2$  is considered an outlier worth inspection. RMSZ is the root-mean-square of all Z scores of the bond lengths (or angles).

Mol	Type	Chain	Res	Link	Bond lengths			Bond angles		
					Counts	RMSZ	$\# Z  > 2$	Counts	RMSZ	$\# Z  > 2$
4	NAG	E	706	2	14,14,15	0.50	0	17,19,21	0.71	1 (5%)
4	NAG	A	1303	1	14,14,15	0.55	0	17,19,21	0.47	0
4	NAG	A	1307	1	14,14,15	0.67	1 (7%)	17,19,21	1.06	2 (11%)



Mol	Type	Chain	Res	Link	Bond lengths			Bond angles		
					Counts	RMSZ	# Z  > 2	Counts	RMSZ	# Z  > 2
4	NAG	C	1301	1	14,14,15	0.33	0	17,19,21	0.52	0
4	NAG	C	1307	1	14,14,15	0.65	1 (7%)	17,19,21	1.07	2 (11%)
4	NAG	D	706	2	14,14,15	0.52	0	17,19,21	0.69	1 (5%)
4	NAG	F	702	2	14,14,15	0.60	0	17,19,21	0.58	0
4	NAG	B	1306	1	14,14,15	0.27	0	17,19,21	0.40	0
4	NAG	A	1308	1	14,14,15	0.32	0	17,19,21	0.47	0
4	NAG	B	1304	1	14,14,15	0.42	0	17,19,21	0.63	1 (5%)
4	NAG	E	702	2	14,14,15	0.62	0	17,19,21	0.60	0
4	NAG	F	705	2	14,14,15	0.37	0	17,19,21	0.59	1 (5%)
4	NAG	A	1304	1	14,14,15	0.46	0	17,19,21	0.61	1 (5%)
4	NAG	B	1308	1	14,14,15	0.35	0	17,19,21	0.47	0
4	NAG	A	1302	1	14,14,15	0.41	0	17,19,21	0.48	0
4	NAG	D	704	2	14,14,15	0.55	0	17,19,21	0.54	0
4	NAG	B	1307	1	14,14,15	0.65	1 (7%)	17,19,21	1.06	2 (11%)
4	NAG	B	1303	1	14,14,15	0.51	0	17,19,21	0.50	0
4	NAG	A	1306	1	14,14,15	0.29	0	17,19,21	0.40	0
4	NAG	D	703	2	14,14,15	0.40	0	17,19,21	0.43	0
4	NAG	E	701	2	14,14,15	0.41	0	17,19,21	0.48	0
4	NAG	A	1301	1	14,14,15	0.34	0	17,19,21	0.52	0
4	NAG	B	1301	1	14,14,15	0.32	0	17,19,21	0.52	0
4	NAG	F	706	2	14,14,15	0.51	0	17,19,21	0.70	1 (5%)
4	NAG	F	701	2	14,14,15	0.42	0	17,19,21	0.47	0
4	NAG	B	1305	1	14,14,15	0.43	0	17,19,21	0.46	0
4	NAG	C	1306	1	14,14,15	0.28	0	17,19,21	0.39	0
4	NAG	E	703	2	14,14,15	0.38	0	17,19,21	0.44	0
4	NAG	D	701	2	14,14,15	0.44	0	17,19,21	0.47	0
4	NAG	C	1303	1	14,14,15	0.51	0	17,19,21	0.50	0
4	NAG	F	704	2	14,14,15	0.56	0	17,19,21	0.55	0
4	NAG	C	1308	1	14,14,15	0.35	0	17,19,21	0.46	0
4	NAG	D	705	2	14,14,15	0.39	0	17,19,21	0.58	1 (5%)
4	NAG	E	705	2	14,14,15	0.36	0	17,19,21	0.60	1 (5%)
4	NAG	E	704	2	14,14,15	0.56	0	17,19,21	0.54	0
4	NAG	B	1302	1	14,14,15	0.46	0	17,19,21	0.47	0
4	NAG	D	702	2	14,14,15	0.62	0	17,19,21	0.59	0
4	NAG	F	703	2	14,14,15	0.39	0	17,19,21	0.44	0
4	NAG	A	1305	1	14,14,15	0.43	0	17,19,21	0.46	0
4	NAG	C	1304	1	14,14,15	0.42	0	17,19,21	0.62	1 (5%)
4	NAG	C	1305	1	14,14,15	0.41	0	17,19,21	0.45	0
4	NAG	C	1302	1	14,14,15	0.43	0	17,19,21	0.47	0

In the following table, the Chirals column lists the number of chiral outliers, the number of chiral

centers analysed, the number of these observed in the model and the number defined in the Chemical Component Dictionary. Similar counts are reported in the Torsion and Rings columns. '2' means no outliers of that kind were identified.

Mol	Type	Chain	Res	Link	Chirals	Torsions	Rings
4	NAG	E	706	2	-	0/6/23/26	0/1/1/1
4	NAG	A	1303	1	-	2/6/23/26	0/1/1/1
4	NAG	A	1307	1	-	3/6/23/26	0/1/1/1
4	NAG	C	1301	1	-	2/6/23/26	0/1/1/1
4	NAG	C	1307	1	-	1/6/23/26	0/1/1/1
4	NAG	D	706	2	-	0/6/23/26	0/1/1/1
4	NAG	F	702	2	-	2/6/23/26	0/1/1/1
4	NAG	B	1306	1	-	0/6/23/26	0/1/1/1
4	NAG	A	1308	1	-	0/6/23/26	0/1/1/1
4	NAG	B	1304	1	-	2/6/23/26	0/1/1/1
4	NAG	E	702	2	-	2/6/23/26	0/1/1/1
4	NAG	F	705	2	-	2/6/23/26	0/1/1/1
4	NAG	A	1304	1	-	2/6/23/26	0/1/1/1
4	NAG	B	1308	1	-	0/6/23/26	0/1/1/1
4	NAG	A	1302	1	-	0/6/23/26	0/1/1/1
4	NAG	D	704	2	-	2/6/23/26	0/1/1/1
4	NAG	B	1307	1	-	3/6/23/26	0/1/1/1
4	NAG	B	1303	1	-	0/6/23/26	0/1/1/1
4	NAG	A	1306	1	-	0/6/23/26	0/1/1/1
4	NAG	D	703	2	-	1/6/23/26	0/1/1/1
4	NAG	E	701	2	-	2/6/23/26	0/1/1/1
4	NAG	A	1301	1	-	2/6/23/26	0/1/1/1
4	NAG	B	1301	1	-	2/6/23/26	0/1/1/1
4	NAG	F	706	2	-	0/6/23/26	0/1/1/1
4	NAG	F	701	2	-	2/6/23/26	0/1/1/1
4	NAG	B	1305	1	-	0/6/23/26	0/1/1/1
4	NAG	C	1306	1	-	0/6/23/26	0/1/1/1
4	NAG	E	703	2	-	0/6/23/26	0/1/1/1
4	NAG	D	701	2	-	2/6/23/26	0/1/1/1
4	NAG	C	1303	1	-	2/6/23/26	0/1/1/1
4	NAG	F	704	2	-	2/6/23/26	0/1/1/1
4	NAG	C	1308	1	-	0/6/23/26	0/1/1/1
4	NAG	D	705	2	-	2/6/23/26	0/1/1/1
4	NAG	E	705	2	-	2/6/23/26	0/1/1/1
4	NAG	E	704	2	-	0/6/23/26	0/1/1/1

*Continued on next page...*

*Continued from previous page...*

Mol	Type	Chain	Res	Link	Chirals	Torsions	Rings
4	NAG	B	1302	1	-	2/6/23/26	0/1/1/1
4	NAG	D	702	2	-	2/6/23/26	0/1/1/1
4	NAG	F	703	2	-	1/6/23/26	0/1/1/1
4	NAG	A	1305	1	-	0/6/23/26	0/1/1/1
4	NAG	C	1304	1	-	2/6/23/26	0/1/1/1
4	NAG	C	1305	1	-	1/6/23/26	0/1/1/1
4	NAG	C	1302	1	-	2/6/23/26	0/1/1/1

All (3) bond length outliers are listed below:

Mol	Chain	Res	Type	Atoms	Z	Observed(Å)	Ideal(Å)
4	A	1307	NAG	C1-C2	2.09	1.55	1.52
4	C	1307	NAG	C1-C2	2.04	1.55	1.52
4	B	1307	NAG	C1-C2	2.03	1.55	1.52

All (15) bond angle outliers are listed below:

Mol	Chain	Res	Type	Atoms	Z	Observed(°)	Ideal(°)
4	C	1307	NAG	C2-N2-C7	3.05	127.25	122.90
4	A	1307	NAG	C2-N2-C7	3.05	127.24	122.90
4	B	1307	NAG	C2-N2-C7	3.01	127.18	122.90
4	E	706	NAG	C1-O5-C5	2.67	115.80	112.19
4	F	706	NAG	C1-O5-C5	2.61	115.73	112.19
4	D	706	NAG	C1-O5-C5	2.58	115.69	112.19
4	C	1307	NAG	C1-O5-C5	2.39	115.43	112.19
4	B	1307	NAG	C1-O5-C5	2.32	115.34	112.19
4	B	1304	NAG	C1-O5-C5	2.31	115.32	112.19
4	A	1307	NAG	C1-O5-C5	2.29	115.30	112.19
4	C	1304	NAG	C1-O5-C5	2.26	115.25	112.19
4	A	1304	NAG	C1-O5-C5	2.23	115.22	112.19
4	E	705	NAG	C1-O5-C5	2.16	115.12	112.19
4	F	705	NAG	C1-O5-C5	2.12	115.06	112.19
4	D	705	NAG	C1-O5-C5	2.08	115.00	112.19

There are no chirality outliers.

All (52) torsion outliers are listed below:

Mol	Chain	Res	Type	Atoms
4	A	1303	NAG	O5-C5-C6-O6
4	B	1304	NAG	O5-C5-C6-O6

*Continued on next page...*

*Continued from previous page...*

<b>Mol</b>	<b>Chain</b>	<b>Res</b>	<b>Type</b>	<b>Atoms</b>
4	D	702	NAG	O5-C5-C6-O6
4	E	705	NAG	O5-C5-C6-O6
4	D	705	NAG	O5-C5-C6-O6
4	A	1307	NAG	C4-C5-C6-O6
4	E	701	NAG	C4-C5-C6-O6
4	F	701	NAG	C4-C5-C6-O6
4	A	1304	NAG	O5-C5-C6-O6
4	E	702	NAG	O5-C5-C6-O6
4	D	702	NAG	C4-C5-C6-O6
4	C	1303	NAG	O5-C5-C6-O6
4	A	1301	NAG	O5-C5-C6-O6
4	D	701	NAG	O5-C5-C6-O6
4	F	705	NAG	O5-C5-C6-O6
4	C	1304	NAG	O5-C5-C6-O6
4	D	704	NAG	O5-C5-C6-O6
4	B	1304	NAG	C4-C5-C6-O6
4	E	705	NAG	C4-C5-C6-O6
4	A	1307	NAG	O5-C5-C6-O6
4	C	1301	NAG	O5-C5-C6-O6
4	A	1303	NAG	C4-C5-C6-O6
4	B	1301	NAG	O5-C5-C6-O6
4	A	1301	NAG	C4-C5-C6-O6
4	D	705	NAG	C4-C5-C6-O6
4	D	704	NAG	C4-C5-C6-O6
4	F	702	NAG	O5-C5-C6-O6
4	C	1304	NAG	C4-C5-C6-O6
4	E	702	NAG	C4-C5-C6-O6
4	F	705	NAG	C4-C5-C6-O6
4	C	1303	NAG	C4-C5-C6-O6
4	A	1304	NAG	C4-C5-C6-O6
4	B	1301	NAG	C4-C5-C6-O6
4	C	1301	NAG	C4-C5-C6-O6
4	E	701	NAG	O5-C5-C6-O6
4	F	701	NAG	O5-C5-C6-O6
4	F	702	NAG	C4-C5-C6-O6
4	F	704	NAG	O5-C5-C6-O6
4	F	704	NAG	C4-C5-C6-O6
4	B	1307	NAG	C4-C5-C6-O6
4	B	1302	NAG	C4-C5-C6-O6
4	C	1305	NAG	O5-C5-C6-O6
4	D	701	NAG	C4-C5-C6-O6
4	B	1307	NAG	O5-C5-C6-O6

*Continued on next page...*

*Continued from previous page...*

Mol	Chain	Res	Type	Atoms
4	C	1302	NAG	C4-C5-C6-O6
4	C	1302	NAG	O5-C5-C6-O6
4	B	1302	NAG	O5-C5-C6-O6
4	A	1307	NAG	C3-C2-N2-C7
4	B	1307	NAG	C3-C2-N2-C7
4	C	1307	NAG	C3-C2-N2-C7
4	D	703	NAG	O5-C5-C6-O6
4	F	703	NAG	O5-C5-C6-O6

There are no ring outliers.

3 monomers are involved in 3 short contacts:

Mol	Chain	Res	Type	Clashes	Symm-Clashes
4	A	1302	NAG	1	0
4	B	1302	NAG	1	0
4	C	1302	NAG	1	0

## 5.7 Other polymers [i](#)

There are no such residues in this entry.

## 5.8 Polymer linkage issues [i](#)

There are no chain breaks in this entry.

## 6 Map visualisation [i](#)

This section contains visualisations of the EMDB entry EMD-27509. These allow visual inspection of the internal detail of the map and identification of artifacts.

Images derived from a raw map, generated by summing the deposited half-maps, are presented below the corresponding image components of the primary map to allow further visual inspection and comparison with those of the primary map.

### 6.1 Orthogonal projections [i](#)

#### 6.1.1 Primary map

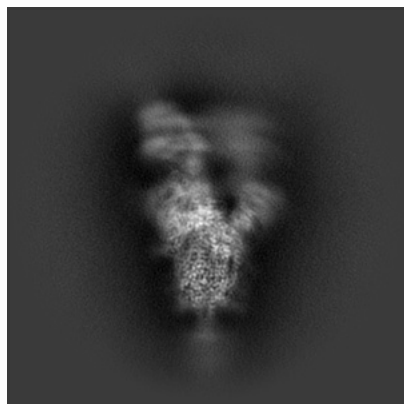

X

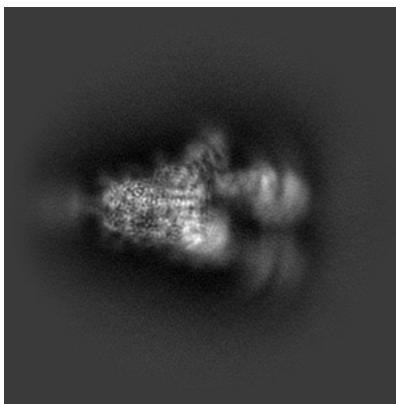

Y

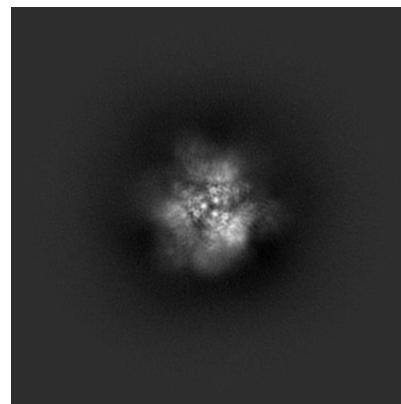

Z

#### 6.1.2 Raw map

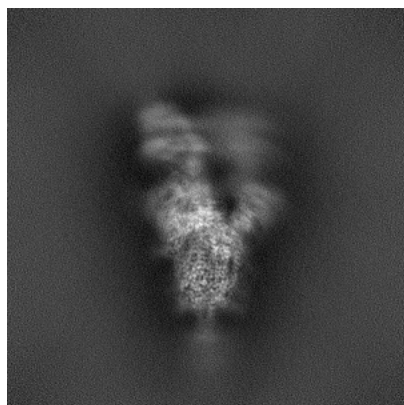

X

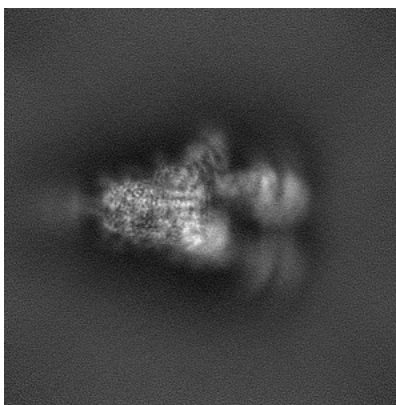

Y

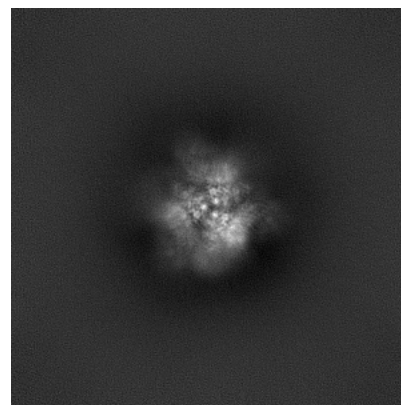

Z

The images above show the map projected in three orthogonal directions.

## 6.2 Central slices [i](#)

### 6.2.1 Primary map

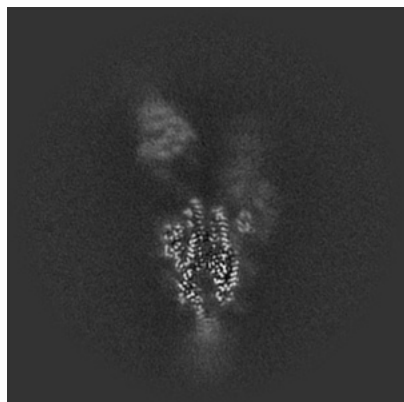

X Index: 200

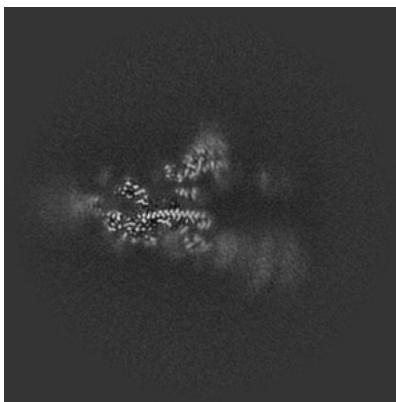

Y Index: 200

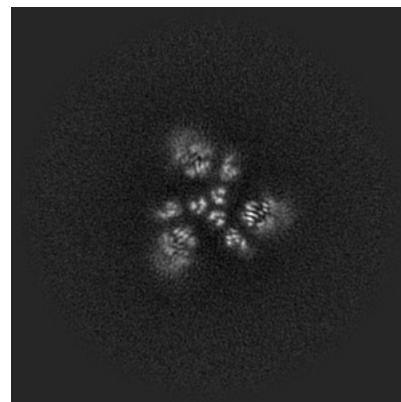

Z Index: 200

### 6.2.2 Raw map

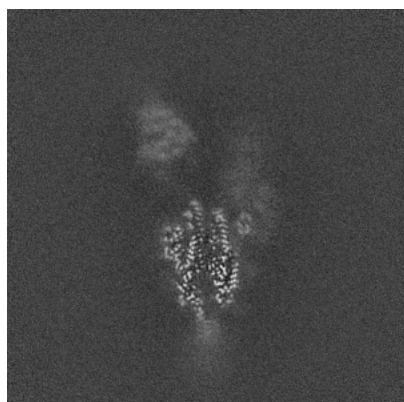

X Index: 200

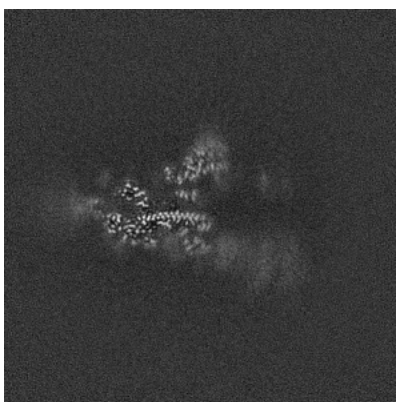

Y Index: 200

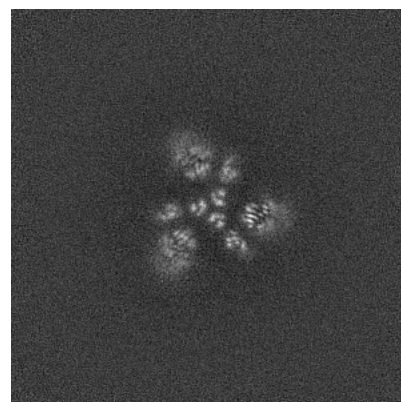

Z Index: 200

The images above show central slices of the map in three orthogonal directions.

## 6.3 Largest variance slices [i](#)

### 6.3.1 Primary map

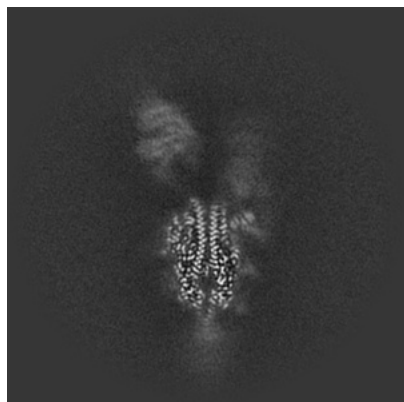

X Index: 204

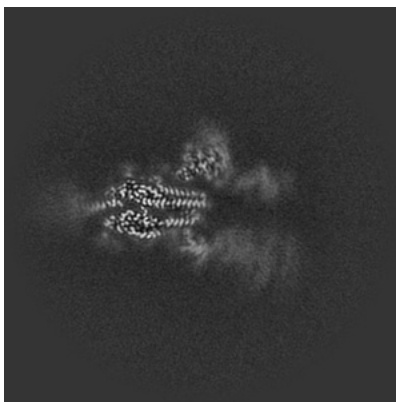

Y Index: 192

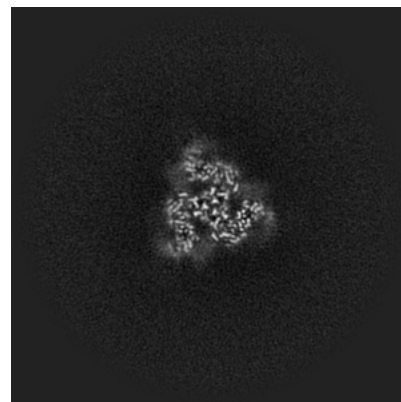

Z Index: 183

### 6.3.2 Raw map

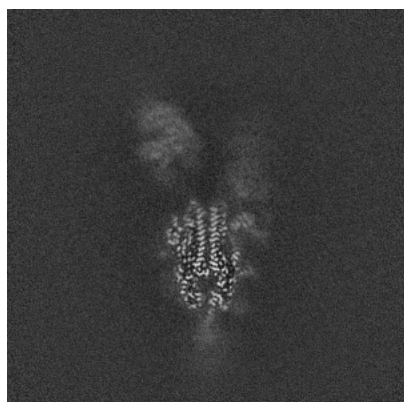

X Index: 205

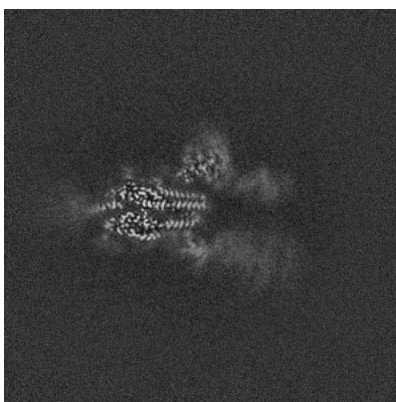

Y Index: 192

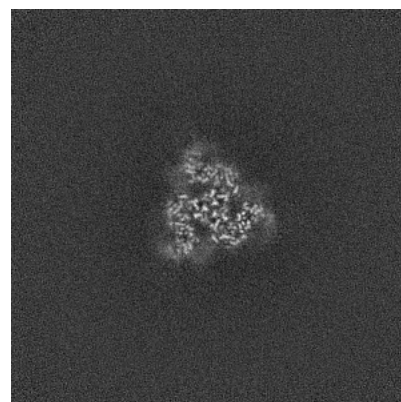

Z Index: 183

The images above show the largest variance slices of the map in three orthogonal directions.



## 6.4 Orthogonal surface views [i](#)

### 6.4.1 Primary map

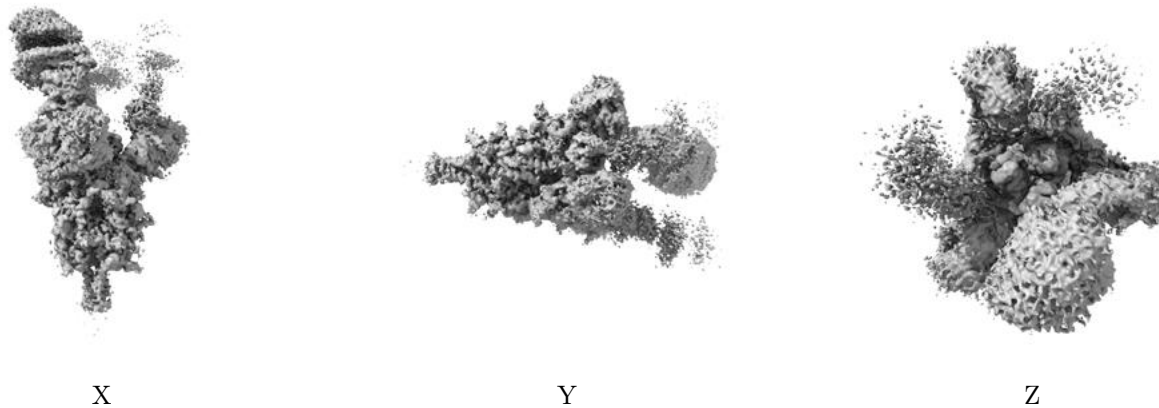

The images above show the 3D surface view of the map at the recommended contour level 0.211. These images, in conjunction with the slice images, may facilitate assessment of whether an appropriate contour level has been provided.

### 6.4.2 Raw map

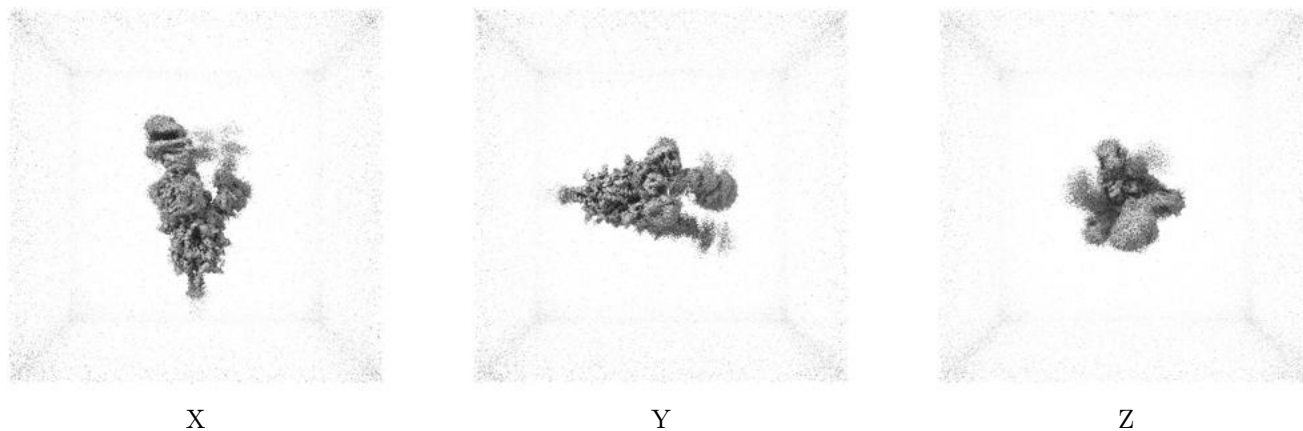

These images show the 3D surface of the raw map. The raw map's contour level was selected so that its surface encloses the same volume as the primary map does at its recommended contour level.

## 6.5 Mask visualisation [i](#)

This section was not generated. No masks/segmentation were deposited.

## 7 Map analysis [i](#)

This section contains the results of statistical analysis of the map.

### 7.1 Map-value distribution [i](#)

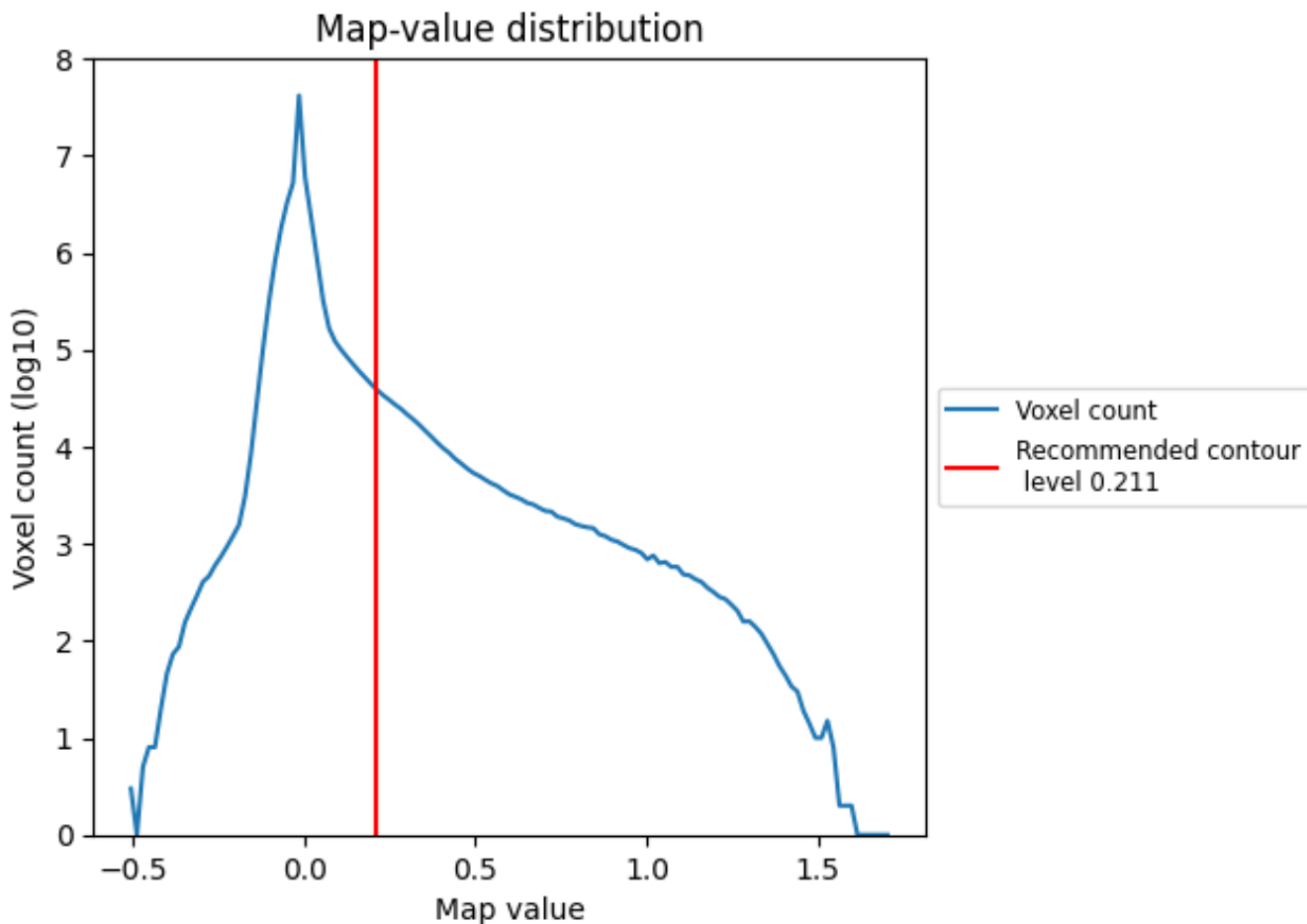

The map-value distribution is plotted in 128 intervals along the x-axis. The y-axis is logarithmic. A spike in this graph at zero usually indicates that the volume has been masked.

## 7.2 Volume estimate [i](#)

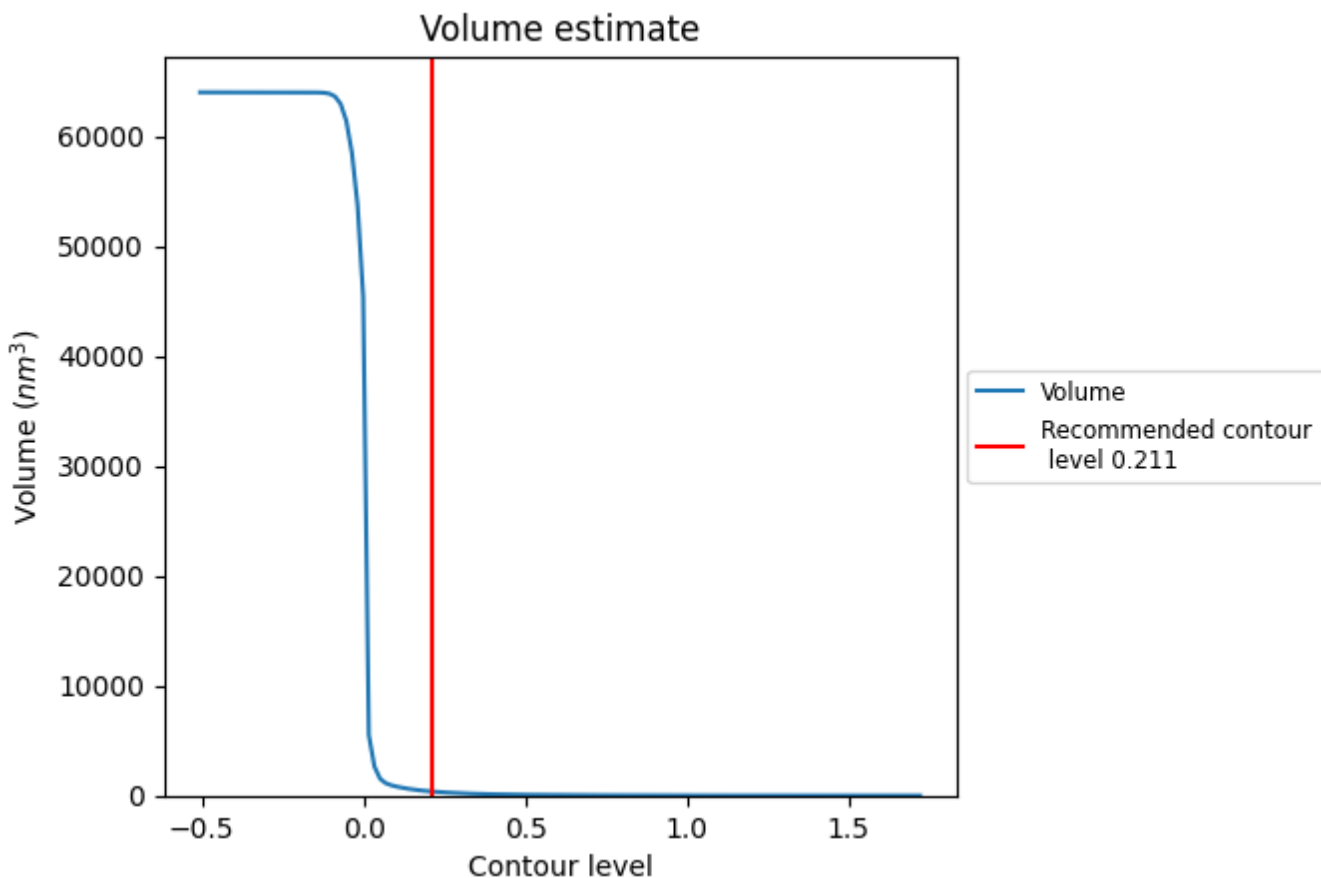

The volume at the recommended contour level is 372 nm<sup>3</sup>; this corresponds to an approximate mass of 336 kDa.

The volume estimate graph shows how the enclosed volume varies with the contour level. The recommended contour level is shown as a vertical line and the intersection between the line and the curve gives the volume of the enclosed surface at the given level.

### 7.3 Rotationally averaged power spectrum [i](#)

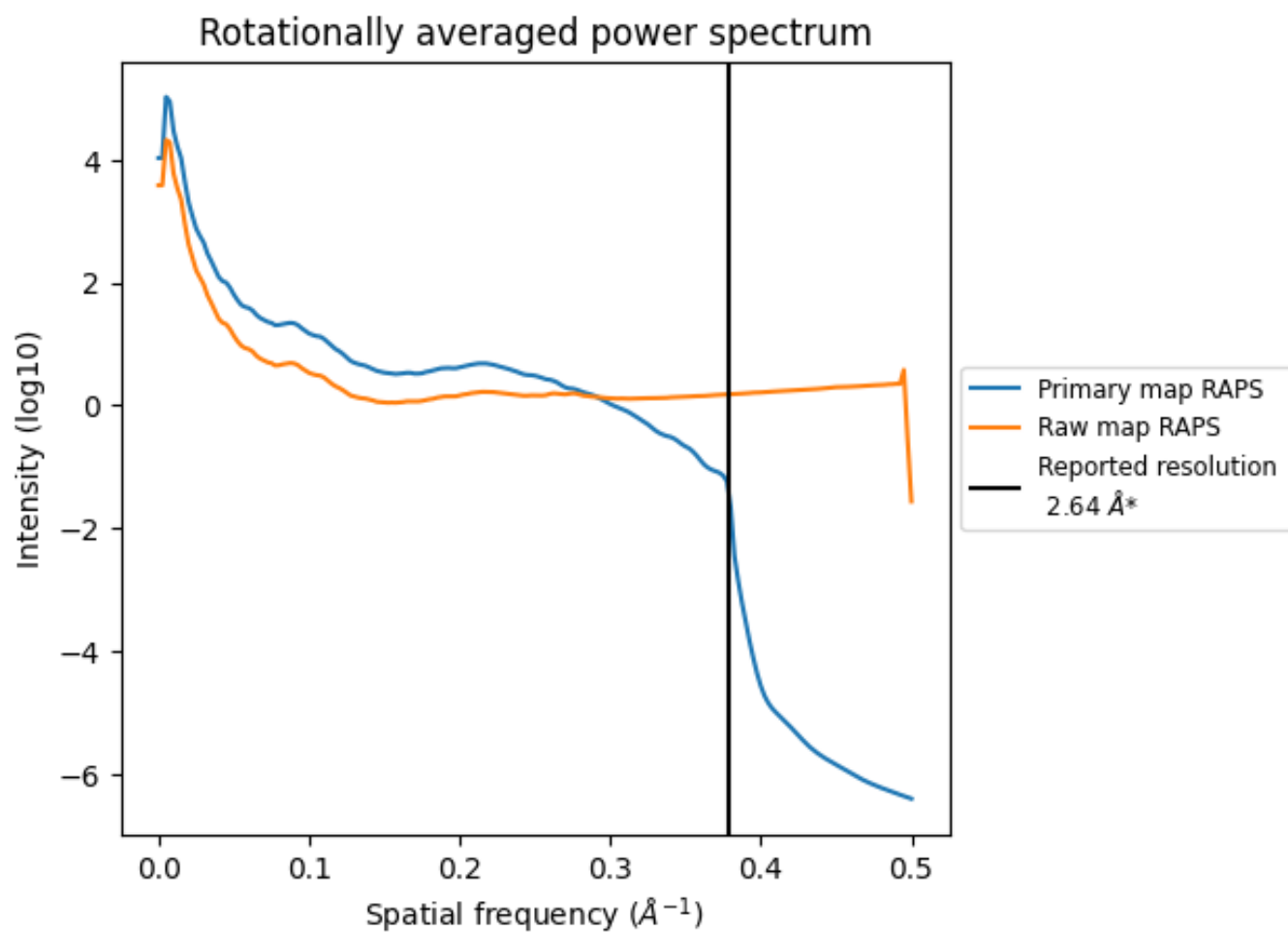

\*Reported resolution corresponds to spatial frequency of  $0.379 \text{ \AA}^{-1}$

## 8 Fourier-Shell correlation [i](#)

Fourier-Shell Correlation (FSC) is the most commonly used method to estimate the resolution of single-particle and subtomogram-averaged maps. The shape of the curve depends on the imposed symmetry, mask and whether or not the two 3D reconstructions used were processed from a common reference. The reported resolution is shown as a black line. A curve is displayed for the half-bit criterion in addition to lines showing the 0.143 gold standard cut-off and 0.5 cut-off.

### 8.1 FSC [i](#)

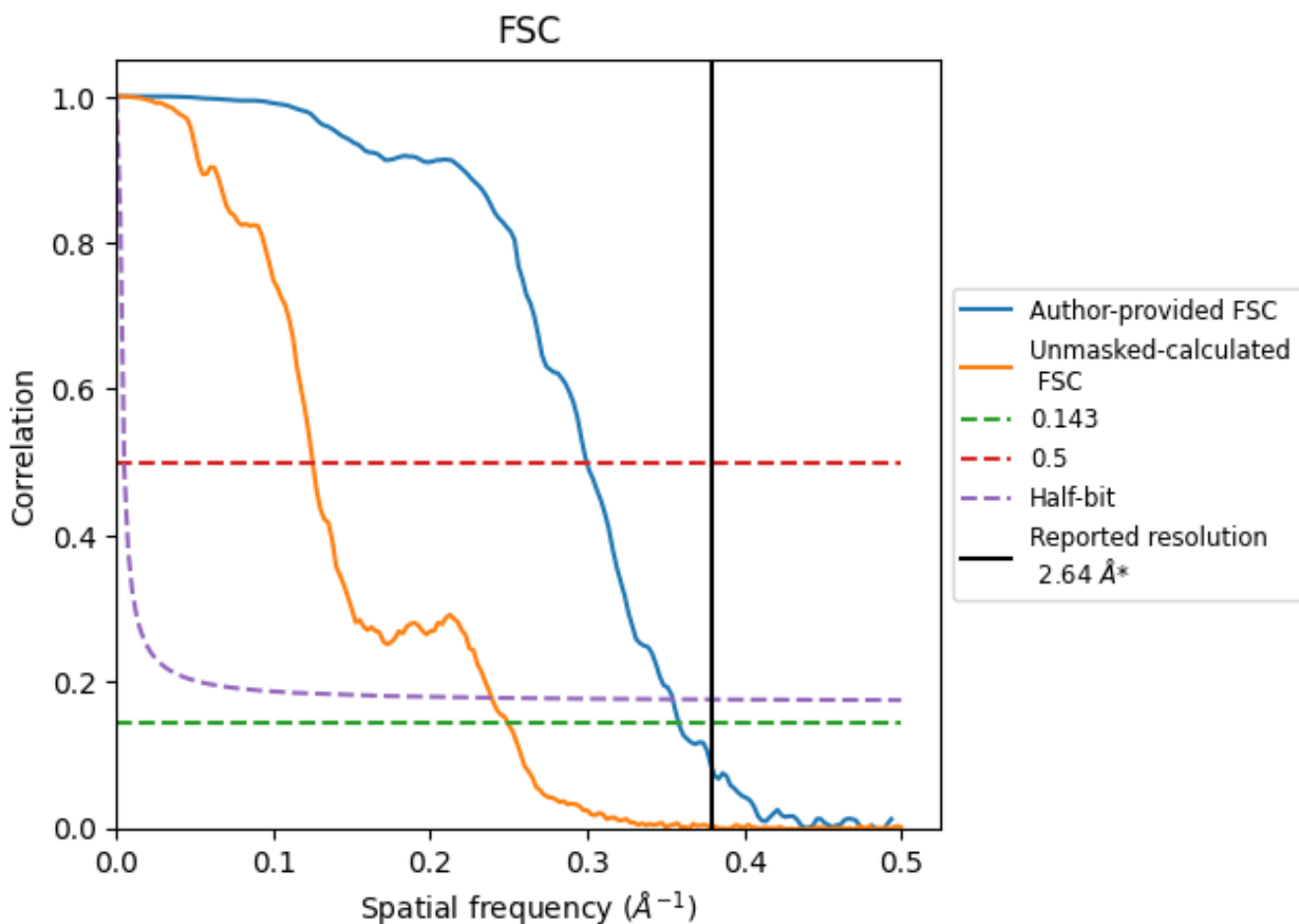

\*Reported resolution corresponds to spatial frequency of 0.379 Å<sup>-1</sup>

## 8.2 Resolution estimates [i](#)

Resolution estimate (Å)	Estimation criterion (FSC cut-off)		
	0.143	0.5	Half-bit
Reported by author	2.64	-	-
Author-provided FSC curve	2.79	3.34	2.82
Unmasked-calculated*	4.01	8.00	4.18

\*Resolution estimate based on FSC curve calculated by comparison of deposited half-maps. The value from deposited half-maps intersecting FSC 0.143 CUT-OFF 4.01 differs from the reported value 2.64 by more than 10 %

## 9 Map-model fit [i](#)

This section contains information regarding the fit between EMDB map EMD-27509 and PDB model 8DLP. Per-residue inclusion information can be found in section 3 on page 17.

### 9.1 Map-model overlay [i](#)

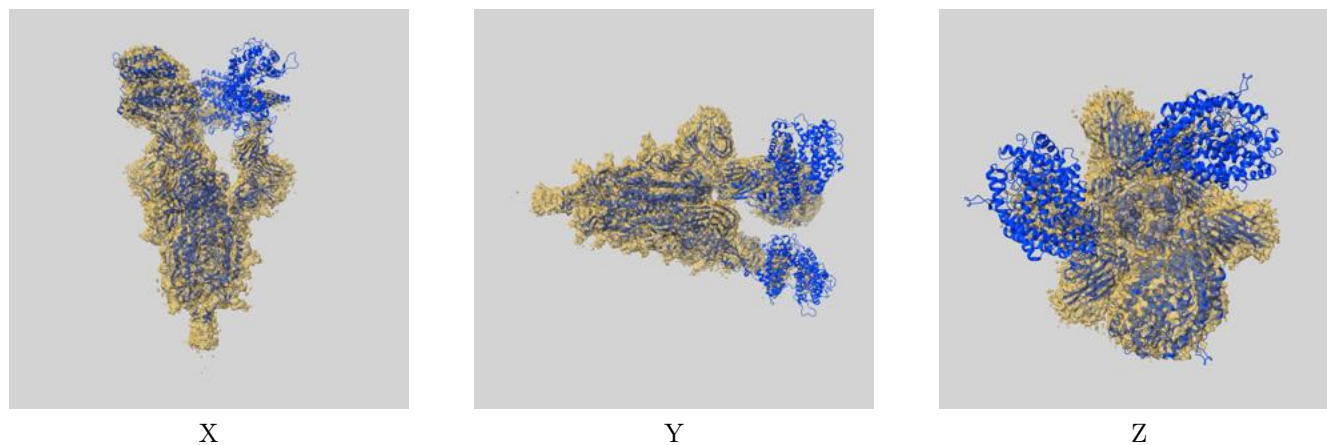

The images above show the 3D surface view of the map at the recommended contour level 0.211 at 50% transparency in yellow overlaid with a ribbon representation of the model coloured in blue. These images allow for the visual assessment of the quality of fit between the atomic model and the map.

## 9.2 Q-score mapped to coordinate model [\(i\)](#)

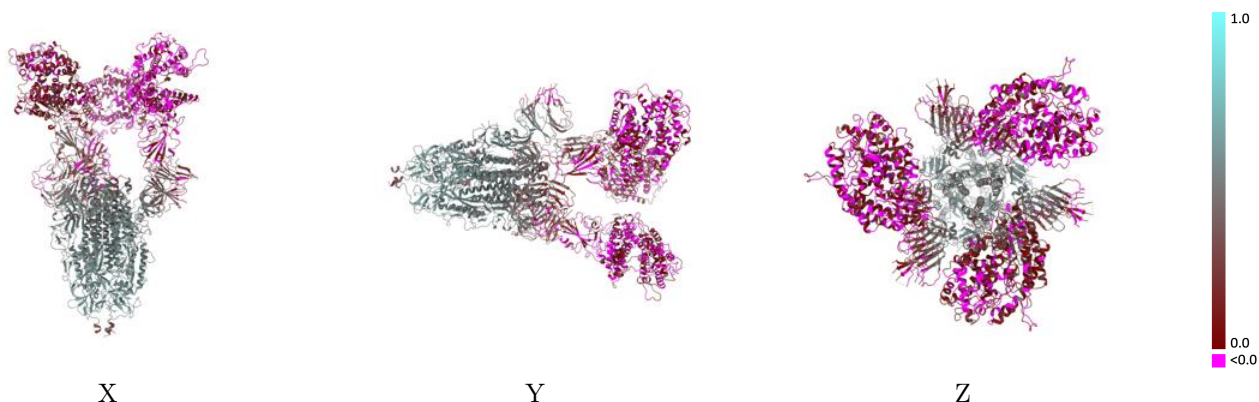

The images above show the model with each residue coloured according to its Q-score. This shows their resolvability in the map with higher Q-score values reflecting better resolvability. Please note: Q-score is calculating the resolvability of atoms, and thus high values are only expected at resolutions at which atoms can be resolved. Low Q-score values may therefore be expected for many entries.

## 9.3 Atom inclusion mapped to coordinate model [\(i\)](#)

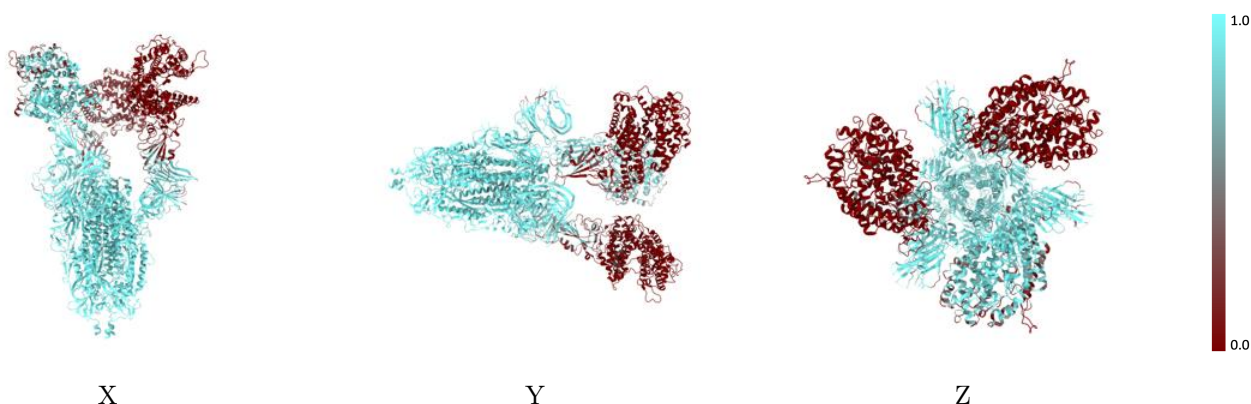

The images above show the model with each residue coloured according to its atom inclusion. This shows to what extent they are inside the map at the recommended contour level (0.211).





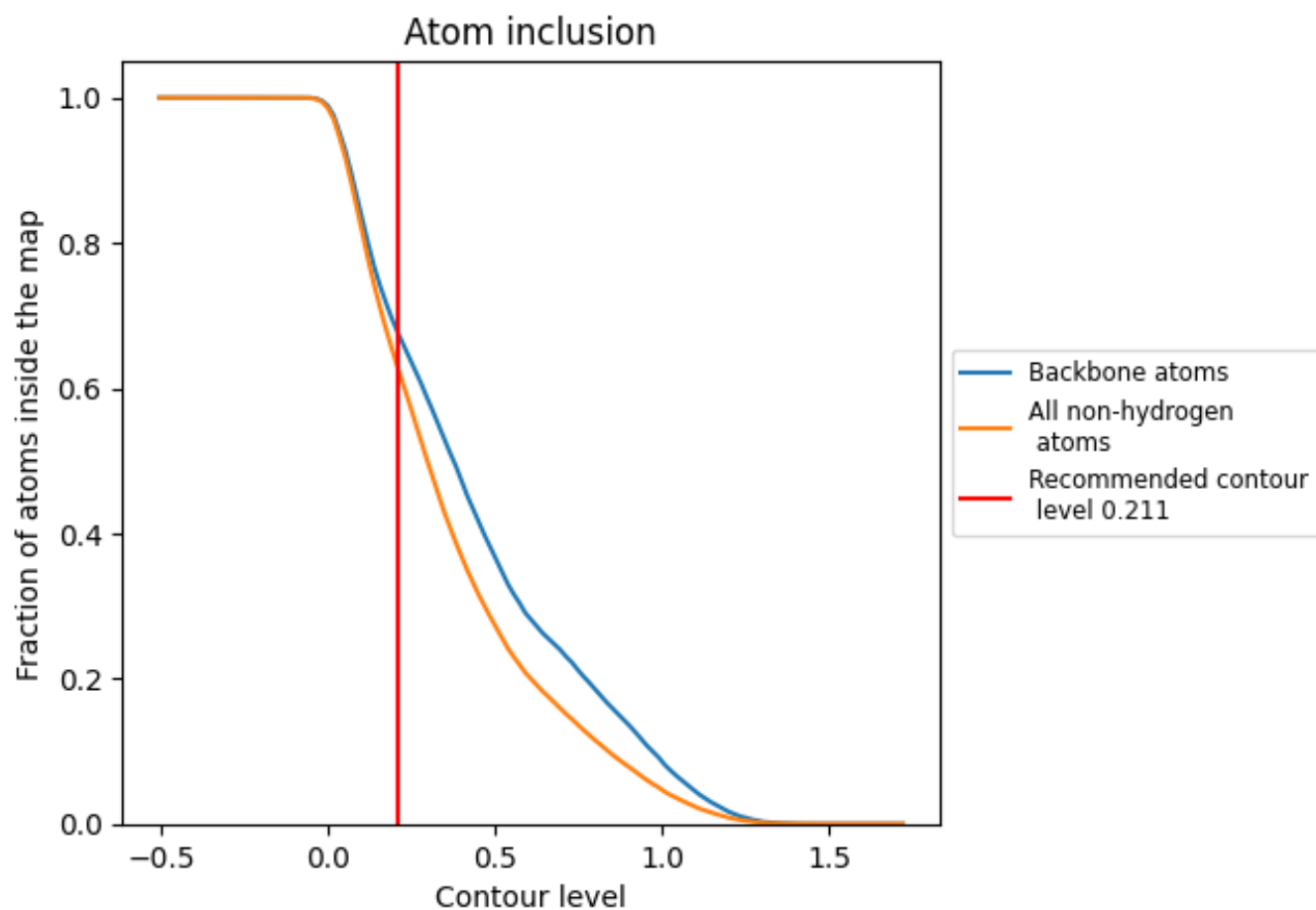















































## 9.4 Atom inclusion [i](#)



At the recommended contour level, 67% of all backbone atoms, 62% of all non-hydrogen atoms, are inside the map.

## 9.5 Map-model fit summary

The table lists the average atom inclusion at the recommended contour level (0.211) and Q-score for the entire model and for each chain.

Chain	Atom inclusion	Q-score
All	 0.6249	 0.2670
A	 0.8095	 0.3670
B	 0.9204	 0.4200
C	 0.7963	 0.3920
D	 0.0265	 0.0350
E	 0.7386	 0.1110
F	 0.0058	 0.0140
G	 0.2500	 0.1030
H	 1.0000	 0.5120
I	 0.9643	 0.4840
J	 0.6071	 0.4310
K	 0.9286	 0.4510
L	 0.9286	 0.4370
M	 0.1786	 0.1930
N	 0.9643	 0.5010
O	 0.9286	 0.4330
P	 0.7500	 0.4880
Q	 0.9286	 0.4340
R	 0.9286	 0.4600
S	 0.1429	 0.0460
T	 0.9286	 0.4820
U	 0.9286	 0.4530
V	 0.7500	 0.4870
W	 0.8571	 0.4410
X	 0.8929	 0.4060

