



Full wwPDB EM Validation Report ⓘ

Jun 2, 2024 – 03:48 PM EDT

PDB ID : 8DFA
EMDB ID : EMD-27403
Title : type I-C Cascade bound to ssDNA target
Authors : O'Brien, R.E.; Bravo, J.P.K.; Ramos, D.; Hibshman, G.N.; Wright, J.T.; Taylor, D.W.
Deposited on : 2022-06-21
Resolution : 2.80 Å(reported)

This is a Full wwPDB EM Validation Report for a publicly released PDB entry.

We welcome your comments at validation@mail.wwpdb.org

A user guide is available at

<https://www.wwpdb.org/validation/2017/EMValidationReportHelp>

with specific help available everywhere you see the ⓘ symbol.

The types of validation reports are described at

<http://www.wwpdb.org/validation/2017/FAQs#types>.

The following versions of software and data (see [references ⓘ](#)) were used in the production of this report:

EMDB validation analysis : 0.0.1.dev92
MolProbity : 4.02b-467
Percentile statistics : 20191225.v01 (using entries in the PDB archive December 25th 2019)
MapQ : 1.9.13
Ideal geometry (proteins) : Engh & Huber (2001)
Ideal geometry (DNA, RNA) : Parkinson et al. (1996)
Validation Pipeline (wwPDB-VP) : 2.36.2

1 Overall quality at a glance

The following experimental techniques were used to determine the structure:
ELECTRON MICROSCOPY

The reported resolution of this entry is 2.80 Å.

Percentile scores (ranging between 0-100) for global validation metrics of the entry are shown in the following graphic. The table shows the number of entries on which the scores are based.

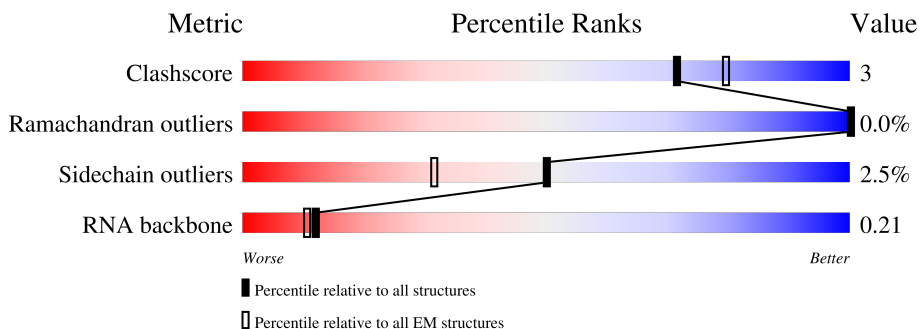

Metric	Whole archive (#Entries)	EM structures (#Entries)
Clashscore	158937	4297
Ramachandran outliers	154571	4023
Sidechain outliers	154315	3826
RNA backbone	4643	859

The table below summarises the geometric issues observed across the polymeric chains and their fit to the map. The red, orange, yellow and green segments of the bar indicate the fraction of residues that contain outliers for ≥ 3 , 2, 1 and 0 types of geometric quality criteria respectively. A grey segment represents the fraction of residues that are not modelled. The numeric value for each fraction is indicated below the corresponding segment, with a dot representing fractions $\leq 5\%$. The upper red bar (where present) indicates the fraction of residues that have poor fit to the EM map (all-atom inclusion $< 40\%$). The numeric value is given above the bar.

Mol	Chain	Length	Quality of chain
1	A	227	 17% 78% 16% ..
2	B	290	 10% 80% 13% 7%
2	C	290	 15% 78% 21% .
2	D	290	 16% 74% 23% ..
2	E	290	 16% 81% 16% ..
2	F	290	 22% 76% 21% ..
2	G	290	 30% 76% 20% ..

Continued on next page...

Continued from previous page...

Mol	Chain	Length	Quality of chain
2	H	290	
3	I	612	
4	J	124	
4	K	124	
5	L	46	
6	N	18	

2 Entry composition [i](#)

There are 6 unique types of molecules in this entry. The entry contains 46813 atoms, of which 23023 are hydrogens and 0 are deuteriums.

In the tables below, the AltConf column contains the number of residues with at least one atom in alternate conformation and the Trace column contains the number of residues modelled with at most 2 atoms.

- Molecule 1 is a protein called pre-crRNA processing endonuclease.

Mol	Chain	Residues	Atoms					AltConf	Trace	
			Total	C	H	N	O			S
1	A	220	3535	1123	1761	323	318	10	0	0

- Molecule 2 is a protein called CRISPR-associated protein, TM1801 family.

Mol	Chain	Residues	Atoms					AltConf	Trace	
			Total	C	H	N	O			S
2	B	270	4193	1324	2081	378	397	13	0	0
2	C	286	4462	1406	2224	399	419	14	0	0
2	D	286	4462	1406	2224	399	419	14	0	0
2	E	286	4462	1406	2224	399	419	14	0	0
2	F	286	4462	1406	2224	399	419	14	0	0
2	G	286	4462	1406	2224	399	419	14	0	0
2	H	286	4462	1406	2224	399	419	14	0	0

- Molecule 3 is a protein called CRISPR-associated protein, CT1133 family.

Mol	Chain	Residues	Atoms					AltConf	Trace	
			Total	C	H	N	O			S
3	I	415	6536	2067	3269	586	599	15	0	0

- Molecule 4 is a protein called CRISPR-associated protein, CT1133 family.

Mol	Chain	Residues	Atoms					AltConf	Trace	
			Total	C	H	N	O			S
4	J	117	1863	589	933	164	172	5	0	0

Continued on next page...

Continued from previous page...

Mol	Chain	Residues	Atoms					AltConf	Trace	
			Total	C	H	N	O			S
4	K	117	1863	589	933	164	172	5	0	0

- Molecule 5 is a RNA chain called RNA (46-MER).

Mol	Chain	Residues	Atoms					AltConf	Trace	
			Total	C	H	N	O			P
5	L	46	1480	438	500	178	319	45	0	0

- Molecule 6 is DNA/RNA hybrid called TS.

Mol	Chain	Residues	Atoms					AltConf	Trace	
			Total	C	H	N	O			P
6	N	18	571	174	202	69	108	18	0	0

3 Residue-property plots [i](#)

These plots are drawn for all protein, RNA, DNA and oligosaccharide chains in the entry. The first graphic for a chain summarises the proportions of the various outlier classes displayed in the second graphic. The second graphic shows the sequence view annotated by issues in geometry and atom inclusion in map density. Residues are color-coded according to the number of geometric quality criteria for which they contain at least one outlier: green = 0, yellow = 1, orange = 2 and red = 3 or more. A red diamond above a residue indicates a poor fit to the EM map for this residue (all-atom inclusion < 40%). Stretches of 2 or more consecutive residues without any outlier are shown as a green connector. Residues present in the sample, but not in the model, are shown in grey.

- Molecule 1: pre-crRNA processing endonuclease

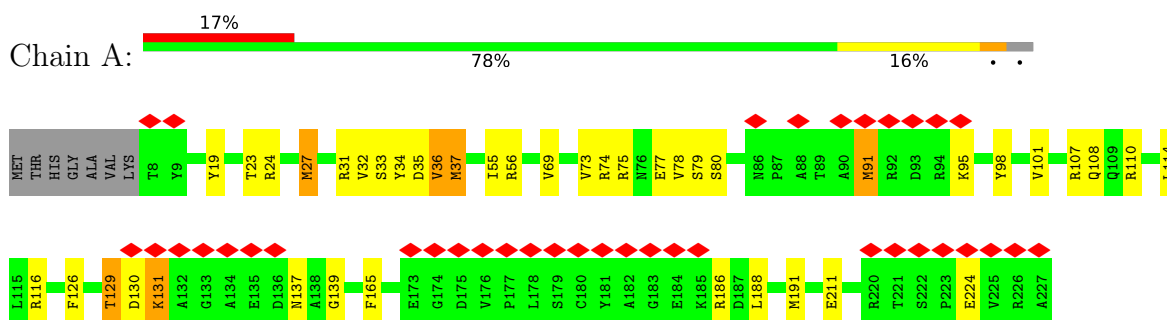

- Molecule 2: CRISPR-associated protein, TM1801 family

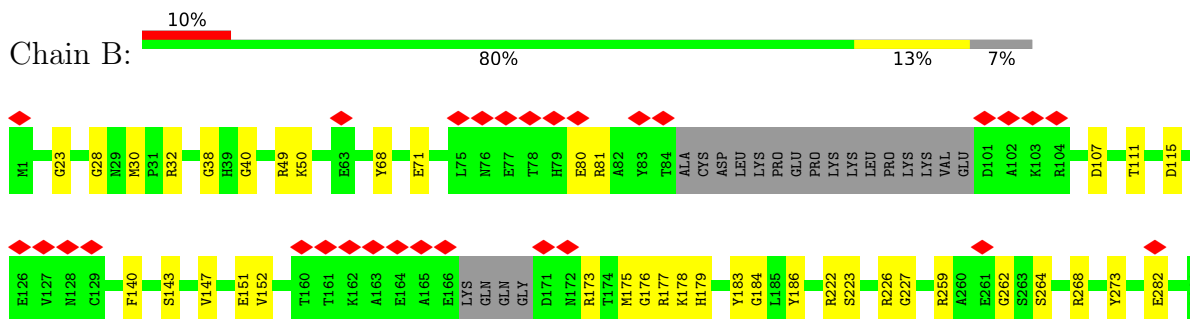

- Molecule 2: CRISPR-associated protein, TM1801 family

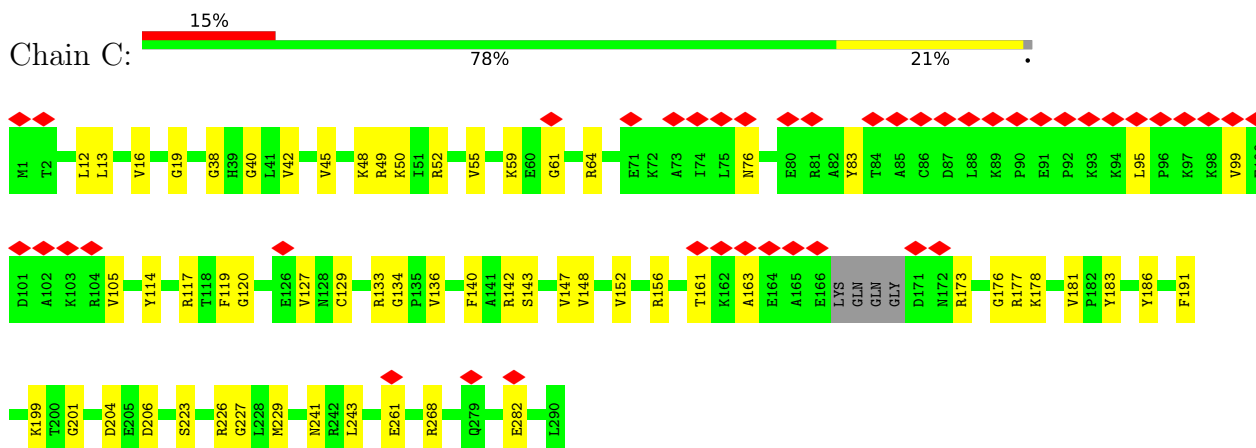

• Molecule 2: CRISPR-associated protein, TM1801 family

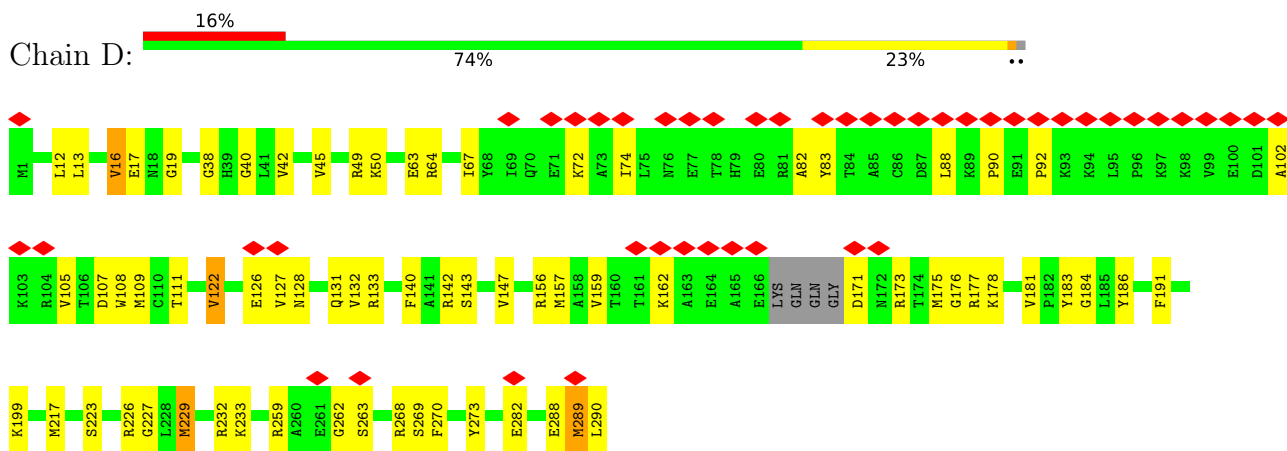

• Molecule 2: CRISPR-associated protein, TM1801 family

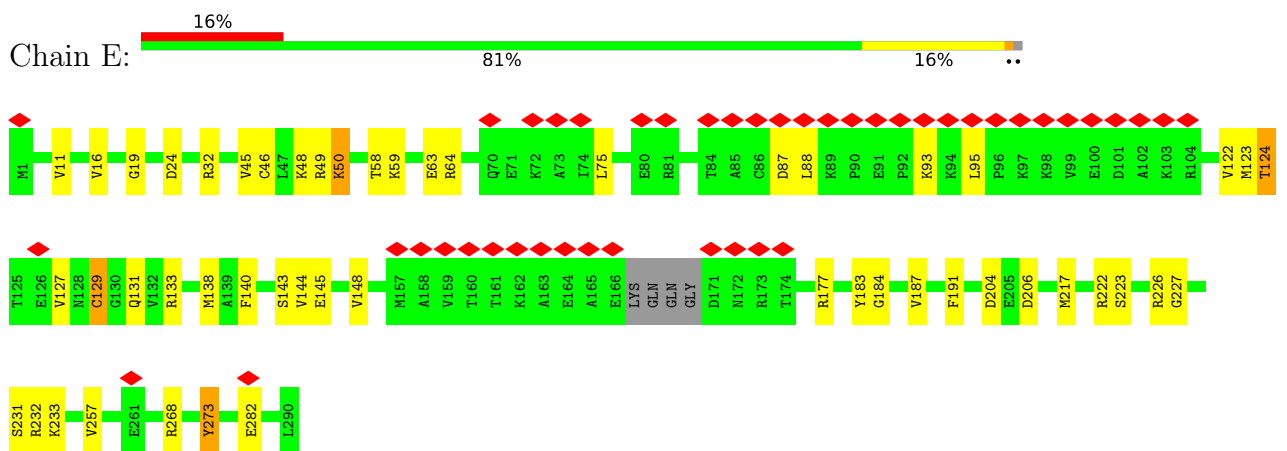

• Molecule 2: CRISPR-associated protein, TM1801 family

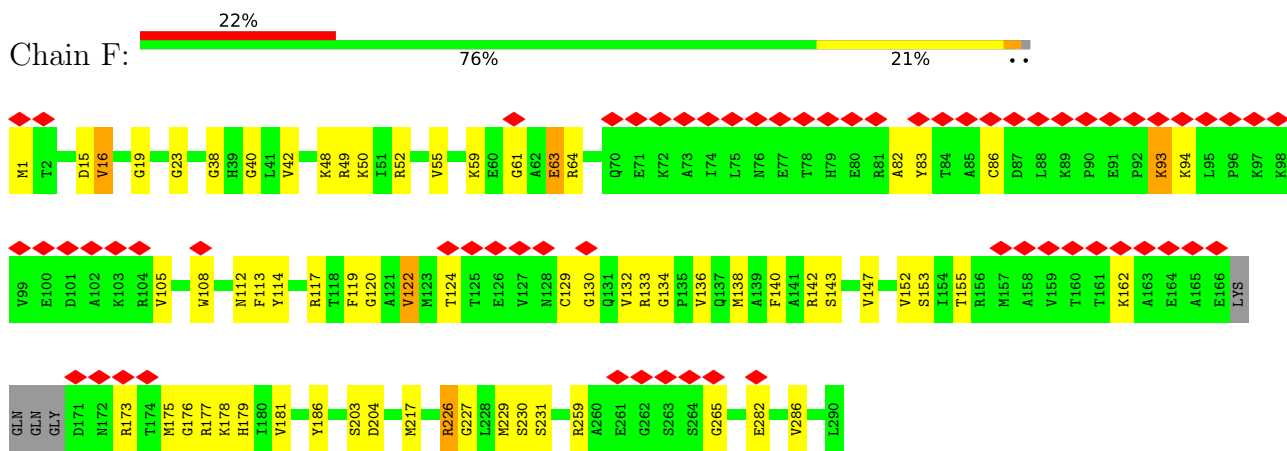

• Molecule 2: CRISPR-associated protein, TM1801 family



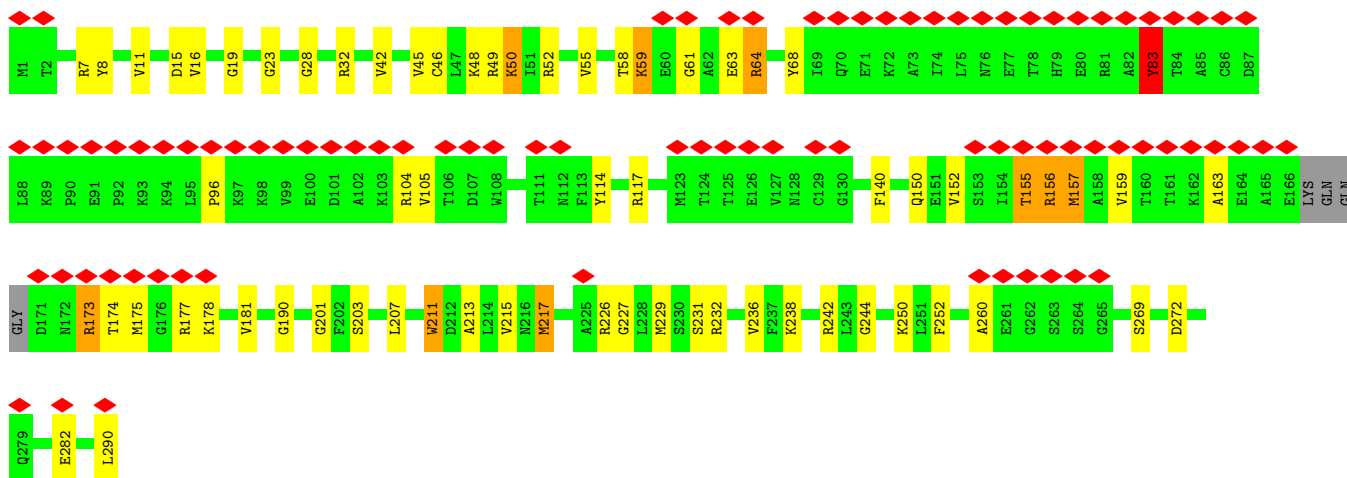

• Molecule 2: CRISPR-associated protein, TM1801 family

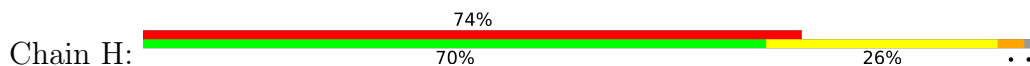

• Molecule 3: CRISPR-associated protein, CT1133 family

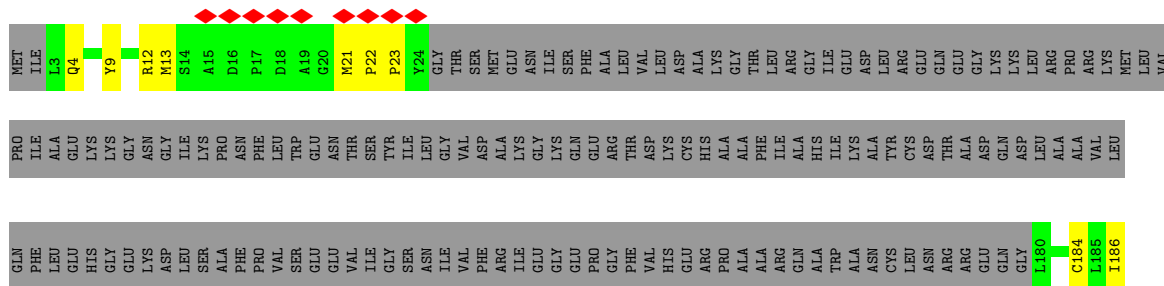

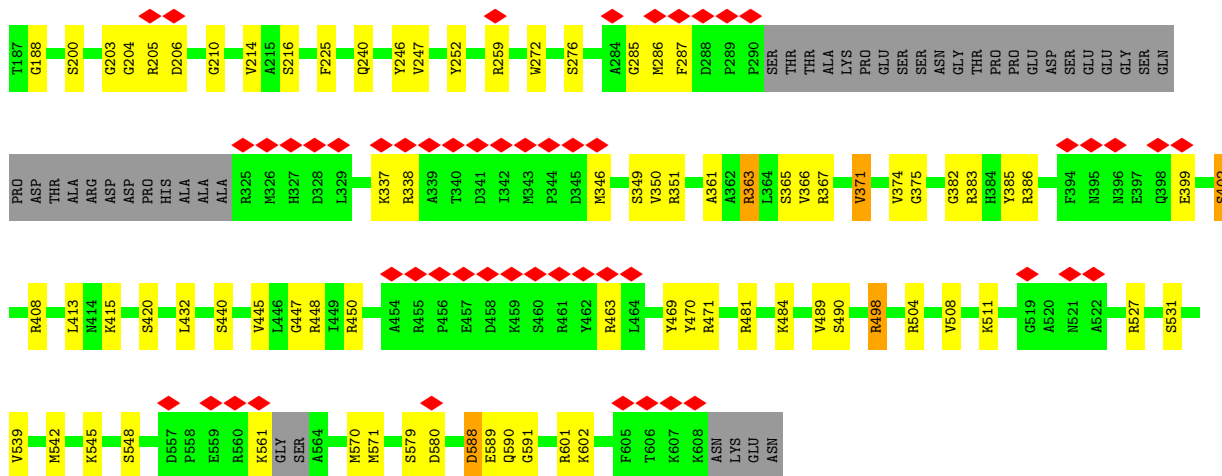

• Molecule 4: CRISPR-associated protein, CT1133 family

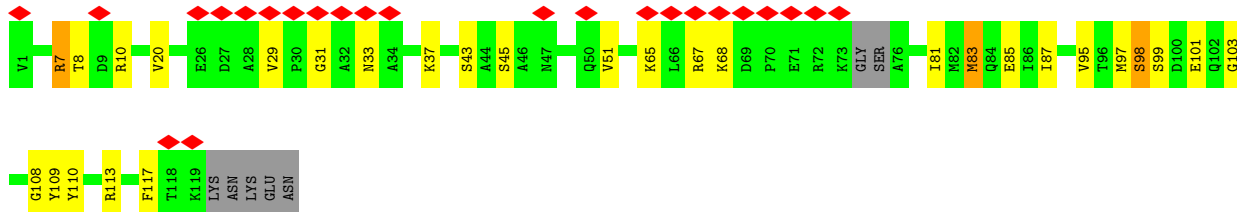

• Molecule 4: CRISPR-associated protein, CT1133 family

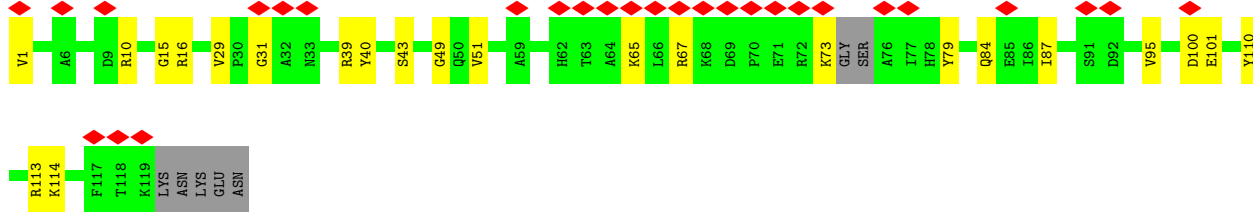
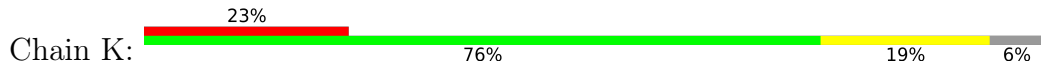

• Molecule 5: RNA (46-MER)

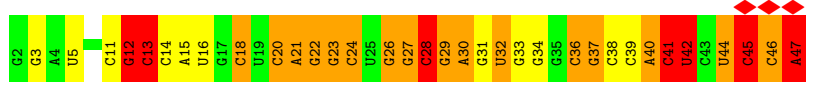
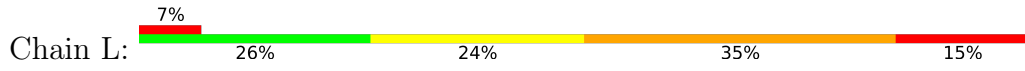

• Molecule 6: TS



T16	C17	G18	C19	C20	A21	G22	C23	C24	T25	G26	A27	G28	C29	A30	T31	G32	G33
-----	-----	-----	-----	-----	-----	-----	-----	-----	-----	-----	-----	-----	-----	-----	-----	-----	-----

4 Experimental information

Property	Value	Source
EM reconstruction method	SINGLE PARTICLE	Depositor
Imposed symmetry	POINT, Not provided	
Number of particles used	174004	Depositor
Resolution determination method	FSC 0.143 CUT-OFF	Depositor
CTF correction method	PHASE FLIPPING AND AMPLITUDE CORRECTION	Depositor
Microscope	TFS GLACIOS	Depositor
Voltage (kV)	200	Depositor
Electron dose ($e^-/\text{\AA}^2$)	40.5	Depositor
Minimum defocus (nm)	1200	Depositor
Maximum defocus (nm)	2200	Depositor
Magnification	Not provided	
Image detector	FEI FALCON IV (4k x 4k)	Depositor
Maximum map value	11.064	Depositor
Minimum map value	-4.191	Depositor
Average map value	-0.002	Depositor
Map value standard deviation	0.171	Depositor
Recommended contour level	1.55	Depositor
Map size (\AA)	422.40002, 422.40002, 422.40002	wwPDB
Map dimensions	384, 384, 384	wwPDB
Map angles ($^\circ$)	90.0, 90.0, 90.0	wwPDB
Pixel spacing (\AA)	1.1, 1.1, 1.1	Depositor

5 Model quality i

5.1 Standard geometry i

The Z score for a bond length (or angle) is the number of standard deviations the observed value is removed from the expected value. A bond length (or angle) with $|Z| > 5$ is considered an outlier worth inspection. RMSZ is the root-mean-square of all Z scores of the bond lengths (or angles).

Mol	Chain	Bond lengths		Bond angles	
		RMSZ	# Z >5	RMSZ	# Z >5
1	A	1.46	37/1817 (2.0%)	1.18	12/2460 (0.5%)
2	B	1.44	38/2153 (1.8%)	1.18	11/2909 (0.4%)
2	C	1.65	56/2283 (2.5%)	1.36	15/3085 (0.5%)
2	D	1.64	55/2283 (2.4%)	1.28	13/3085 (0.4%)
2	E	1.45	44/2283 (1.9%)	1.19	11/3085 (0.4%)
2	F	1.73	51/2283 (2.2%)	1.44	17/3085 (0.6%)
2	G	1.81	51/2283 (2.2%)	1.52	22/3085 (0.7%)
2	H	1.58	30/2283 (1.3%)	1.39	17/3085 (0.6%)
3	I	1.75	78/3334 (2.3%)	1.44	24/4506 (0.5%)
4	J	2.06	30/947 (3.2%)	1.60	6/1274 (0.5%)
4	K	1.96	21/947 (2.2%)	1.58	6/1274 (0.5%)
5	L	2.47	70/1095 (6.4%)	2.62	120/1706 (7.0%)
6	N	2.83	41/413 (9.9%)	3.01	45/635 (7.1%)
All	All	1.73	602/24404 (2.5%)	1.50	319/33274 (1.0%)

Chiral center outliers are detected by calculating the chiral volume of a chiral center and verifying if the center is modelled as a planar moiety or with the opposite hand. A planarity outlier is detected by checking planarity of atoms in a peptide group, atoms in a mainchain group or atoms of a sidechain that are expected to be planar.

Mol	Chain	#Chirality outliers	#Planarity outliers
2	F	0	1
2	G	0	4
2	H	0	3
3	I	0	1
5	L	0	3
All	All	0	12

All (602) bond length outliers are listed below:

Mol	Chain	Res	Type	Atoms	Z	Observed(Å)	Ideal(Å)
6	N	16	DT	C5-C7	-14.15	1.41	1.50
5	L	21	A	C6-N6	-12.94	1.23	1.33

Continued on next page...

Continued from previous page...

Mol	Chain	Res	Type	Atoms	Z	Observed(Å)	Ideal(Å)
5	L	15	A	C6-N6	-12.54	1.24	1.33
6	N	21	DA	C6-N6	-12.13	1.24	1.33
5	L	47	A	C6-N6	-11.91	1.24	1.33
5	L	11	C	C4-N4	-11.28	1.23	1.33
5	L	13	C	C4-N4	-11.26	1.23	1.33
5	L	28	C	C4-N4	-11.12	1.24	1.33
5	L	20	C	C4-N4	-11.02	1.24	1.33
6	N	20	DC	C4-N4	-10.76	1.24	1.33
6	N	23	DC	C4-N4	-10.68	1.24	1.33
6	N	17	DC	C4-N4	-10.67	1.24	1.33
6	N	24	DC	C4-N4	-10.53	1.24	1.33
5	L	33	G	C2-N2	-10.48	1.24	1.34
5	L	22	G	C2-N2	-10.34	1.24	1.34
6	N	24	DC	C5-C6	-10.24	1.26	1.34
6	N	17	DC	C5-C6	-10.14	1.26	1.34
5	L	12	G	C2-N2	-10.13	1.24	1.34
6	N	20	DC	C5-C6	-10.11	1.26	1.34
5	L	23	G	C2-N2	-10.07	1.24	1.34
6	N	22	DG	C2-N2	-10.05	1.24	1.34
5	L	27	G	C2-N2	-10.00	1.24	1.34
5	L	29	G	C2-N2	-9.94	1.24	1.34
5	L	26	G	C2-N2	-9.86	1.24	1.34
6	N	23	DC	C5-C6	-9.85	1.26	1.34
5	L	13	C	C5-C6	-9.83	1.26	1.34
5	L	11	C	C5-C6	-9.76	1.26	1.34
5	L	28	C	C5-C6	-9.68	1.26	1.34
5	L	20	C	C5-C6	-9.59	1.26	1.34
5	L	32	U	C5-C6	-9.30	1.25	1.34
5	L	42	U	C5-C6	-8.35	1.26	1.34
1	A	107	ARG	CZ-NH2	-7.94	1.22	1.33
2	G	49	ARG	CZ-NH2	-7.93	1.22	1.33
2	E	226	ARG	CZ-NH2	-7.89	1.22	1.33
1	A	74	ARG	CZ-NH2	-7.89	1.22	1.33
2	C	117	ARG	CZ-NH2	-7.89	1.22	1.33
2	B	32	ARG	CZ-NH2	-7.89	1.22	1.33
1	A	110	ARG	CZ-NH2	-7.88	1.22	1.33
2	C	156	ARG	CZ-NH2	-7.88	1.22	1.33
2	D	226	ARG	CZ-NH2	-7.88	1.22	1.33
1	A	75	ARG	CZ-NH2	-7.86	1.22	1.33
1	A	24	ARG	CZ-NH2	-7.86	1.22	1.33
4	J	67	ARG	CZ-NH2	-7.85	1.22	1.33
2	C	133	ARG	CZ-NH2	-7.85	1.22	1.33

Continued on next page...

Continued from previous page...

Mol	Chain	Res	Type	Atoms	Z	Observed(Å)	Ideal(Å)
2	C	226	ARG	CZ-NH2	-7.85	1.22	1.33
2	B	49	ARG	CZ-NH2	-7.84	1.22	1.33
2	D	142	ARG	CZ-NH2	-7.84	1.22	1.33
2	G	7	ARG	CZ-NH2	-7.84	1.22	1.33
2	D	49	ARG	CZ-NH2	-7.83	1.22	1.33
4	J	113	ARG	CZ-NH2	-7.83	1.22	1.33
2	G	52	ARG	CZ-NH2	-7.83	1.22	1.33
2	D	133	ARG	CZ-NH2	-7.83	1.22	1.33
2	E	133	ARG	CZ-NH2	-7.82	1.22	1.33
2	C	268	ARG	CZ-NH2	-7.82	1.22	1.33
1	A	116	ARG	CZ-NH2	-7.82	1.22	1.33
2	G	64	ARG	CZ-NH2	-7.82	1.22	1.33
4	K	39	ARG	CZ-NH2	-7.81	1.22	1.33
1	A	31	ARG	CZ-NH2	-7.81	1.23	1.33
3	I	351	ARG	CZ-NH2	-7.80	1.23	1.33
1	A	186	ARG	CZ-NH2	-7.79	1.23	1.33
2	D	177	ARG	CZ-NH2	-7.76	1.23	1.33
2	F	142	ARG	CZ-NH2	-7.75	1.23	1.33
2	C	173	ARG	CZ-NH2	-7.74	1.23	1.33
2	D	156	ARG	CZ-NH2	-7.73	1.23	1.33
2	D	173	ARG	CZ-NH2	-7.73	1.23	1.33
2	F	64	ARG	CZ-NH2	-7.71	1.23	1.33
2	B	259	ARG	CZ-NH2	-7.70	1.23	1.33
5	L	29	G	C8-N7	-7.69	1.26	1.30
2	B	268	ARG	CZ-NH2	-7.68	1.23	1.33
3	I	383	ARG	CZ-NH2	-7.68	1.23	1.33
4	K	113	ARG	CZ-NH2	-7.68	1.23	1.33
4	J	10	ARG	CZ-NH2	-7.67	1.23	1.33
3	I	338	ARG	CZ-NH2	-7.66	1.23	1.33
3	I	386	ARG	CZ-NH2	-7.66	1.23	1.33
3	I	259	ARG	CZ-NH2	-7.65	1.23	1.33
3	I	504	ARG	CZ-NH2	-7.65	1.23	1.33
2	G	32	ARG	CZ-NH2	-7.64	1.23	1.33
2	D	259	ARG	CZ-NH2	-7.63	1.23	1.33
2	B	226	ARG	CZ-NH2	-7.63	1.23	1.33
2	F	177	ARG	CZ-NH2	-7.63	1.23	1.33
2	B	222	ARG	CZ-NH2	-7.62	1.23	1.33
2	C	64	ARG	CZ-NH2	-7.62	1.23	1.33
3	I	448	ARG	CZ-NH2	-7.62	1.23	1.33
3	I	12	ARG	CZ-NH2	-7.61	1.23	1.33
4	K	10	ARG	CZ-NH2	-7.61	1.23	1.33
2	G	242	ARG	CZ-NH2	-7.61	1.23	1.33

Continued on next page...

Continued from previous page...

Mol	Chain	Res	Type	Atoms	Z	Observed(Å)	Ideal(Å)
2	E	268	ARG	CZ-NH2	-7.59	1.23	1.33
2	F	133	ARG	CZ-NH2	-7.59	1.23	1.33
2	E	232	ARG	CZ-NH2	-7.58	1.23	1.33
2	F	117	ARG	CZ-NH2	-7.58	1.23	1.33
2	E	49	ARG	CZ-NH2	-7.58	1.23	1.33
2	D	232	ARG	CZ-NH2	-7.56	1.23	1.33
2	H	52	ARG	CZ-NH2	-7.55	1.23	1.33
3	I	408	ARG	CZ-NH2	-7.55	1.23	1.33
2	C	142	ARG	CZ-NH2	-7.55	1.23	1.33
2	H	32	ARG	CZ-NH2	-7.54	1.23	1.33
2	H	64	ARG	CZ-NH2	-7.53	1.23	1.33
2	H	7	ARG	CZ-NH2	-7.52	1.23	1.33
4	J	7	ARG	CZ-NH2	-7.51	1.23	1.33
2	E	222	ARG	CZ-NH2	-7.51	1.23	1.33
2	H	242	ARG	CZ-NH2	-7.51	1.23	1.33
3	I	363	ARG	CZ-NH2	-7.49	1.23	1.33
2	H	81	ARG	CZ-NH2	-7.46	1.23	1.33
2	H	49	ARG	CZ-NH2	-7.46	1.23	1.33
3	I	205	ARG	CZ-NH2	-7.45	1.23	1.33
2	G	173	ARG	CZ-NH2	-7.44	1.23	1.33
2	B	32	ARG	CZ-NH1	-7.40	1.23	1.33
2	G	49	ARG	CZ-NH1	-7.38	1.23	1.33
6	N	26	DG	P-OP2	7.38	1.61	1.49
6	N	29	DC	P-OP1	7.37	1.61	1.49
5	L	33	G	C8-N7	-7.37	1.26	1.30
2	G	52	ARG	CZ-NH1	-7.35	1.23	1.33
2	C	268	ARG	CZ-NH1	-7.35	1.23	1.33
3	I	351	ARG	CZ-NH1	-7.34	1.23	1.33
2	E	226	ARG	CZ-NH1	-7.33	1.23	1.33
1	A	107	ARG	CZ-NH1	-7.33	1.23	1.33
1	A	75	ARG	CZ-NH1	-7.32	1.23	1.33
1	A	110	ARG	CZ-NH1	-7.32	1.23	1.33
2	D	142	ARG	CZ-NH1	-7.32	1.23	1.33
2	G	64	ARG	CZ-NH1	-7.31	1.23	1.33
2	C	117	ARG	CZ-NH1	-7.31	1.23	1.33
2	D	49	ARG	CZ-NH1	-7.30	1.23	1.33
2	D	156	ARG	CZ-NH1	-7.30	1.23	1.33
2	C	156	ARG	CZ-NH1	-7.30	1.23	1.33
4	J	67	ARG	CZ-NH1	-7.30	1.23	1.33
1	A	116	ARG	CZ-NH1	-7.30	1.23	1.33
2	B	49	ARG	CZ-NH1	-7.30	1.23	1.33
1	A	31	ARG	CZ-NH1	-7.30	1.23	1.33

Continued on next page...

Continued from previous page...

Mol	Chain	Res	Type	Atoms	Z	Observed(Å)	Ideal(Å)
2	C	226	ARG	CZ-NH1	-7.29	1.23	1.33
1	A	186	ARG	CZ-NH1	-7.29	1.23	1.33
1	A	74	ARG	CZ-NH1	-7.28	1.23	1.33
2	D	226	ARG	CZ-NH1	-7.28	1.23	1.33
6	N	17	DC	C2'-C1'	-7.28	1.45	1.52
2	C	173	ARG	CZ-NH1	-7.26	1.23	1.33
2	F	142	ARG	CZ-NH1	-7.26	1.23	1.33
2	D	173	ARG	CZ-NH1	-7.25	1.23	1.33
4	K	39	ARG	CZ-NH1	-7.25	1.23	1.33
2	D	177	ARG	CZ-NH1	-7.24	1.23	1.33
2	C	133	ARG	CZ-NH1	-7.24	1.23	1.33
2	E	133	ARG	CZ-NH1	-7.23	1.23	1.33
4	J	113	ARG	CZ-NH1	-7.23	1.23	1.33
1	A	24	ARG	CZ-NH1	-7.22	1.23	1.33
2	D	133	ARG	CZ-NH1	-7.21	1.23	1.33
4	K	10	ARG	CZ-NH1	-7.20	1.23	1.33
2	G	7	ARG	CZ-NH1	-7.18	1.23	1.33
3	I	448	ARG	CZ-NH1	-7.18	1.23	1.33
3	I	386	ARG	CZ-NH1	-7.18	1.23	1.33
3	I	259	ARG	CZ-NH1	-7.17	1.23	1.33
2	G	242	ARG	CZ-NH1	-7.17	1.23	1.33
3	I	383	ARG	CZ-NH1	-7.17	1.23	1.33
2	G	32	ARG	CZ-NH1	-7.17	1.23	1.33
4	J	10	ARG	CZ-NH1	-7.16	1.23	1.33
3	I	338	ARG	CZ-NH1	-7.15	1.23	1.33
4	K	113	ARG	CZ-NH1	-7.15	1.23	1.33
4	J	7	ARG	CZ-NH1	-7.14	1.23	1.33
6	N	20	DC	N1-C6	-7.11	1.32	1.37
2	B	222	ARG	CZ-NH1	-7.11	1.23	1.33
2	H	49	ARG	CZ-NH1	-7.10	1.23	1.33
2	E	232	ARG	CZ-NH1	-7.09	1.23	1.33
5	L	12	G	C8-N7	-7.09	1.26	1.30
5	L	26	G	C8-N7	-7.09	1.26	1.30
2	E	268	ARG	CZ-NH1	-7.08	1.23	1.33
2	F	177	ARG	CZ-NH1	-7.08	1.23	1.33
2	F	64	ARG	CZ-NH1	-7.07	1.23	1.33
2	D	232	ARG	CZ-NH1	-7.07	1.23	1.33
3	I	363	ARG	CZ-NH1	-7.07	1.23	1.33
2	E	49	ARG	CZ-NH1	-7.07	1.23	1.33
2	B	268	ARG	CZ-NH1	-7.06	1.23	1.33
2	B	226	ARG	CZ-NH1	-7.06	1.23	1.33
2	C	64	ARG	CZ-NH1	-7.05	1.23	1.33

Continued on next page...

Continued from previous page...

Mol	Chain	Res	Type	Atoms	Z	Observed(Å)	Ideal(Å)
2	F	117	ARG	CZ-NH1	-7.05	1.23	1.33
2	B	259	ARG	CZ-NH1	-7.05	1.23	1.33
2	H	64	ARG	CZ-NH1	-7.04	1.23	1.33
2	E	222	ARG	CZ-NH1	-7.04	1.24	1.33
2	H	242	ARG	CZ-NH1	-7.04	1.24	1.33
3	I	504	ARG	CZ-NH1	-7.03	1.24	1.33
5	L	13	C	N1-C6	-7.03	1.32	1.37
2	C	142	ARG	CZ-NH1	-7.02	1.24	1.33
2	G	173	ARG	CZ-NH1	-7.02	1.24	1.33
3	I	12	ARG	CZ-NH1	-7.02	1.24	1.33
3	I	408	ARG	CZ-NH1	-7.01	1.24	1.33
2	D	259	ARG	CZ-NH1	-7.01	1.24	1.33
2	H	52	ARG	CZ-NH1	-7.00	1.24	1.33
2	H	81	ARG	CZ-NH1	-6.99	1.24	1.33
5	L	23	G	C8-N7	-6.99	1.26	1.30
5	L	27	G	C8-N7	-6.99	1.26	1.30
2	F	133	ARG	CZ-NH1	-6.99	1.24	1.33
2	H	7	ARG	CZ-NH1	-6.97	1.24	1.33
5	L	22	G	C8-N7	-6.97	1.26	1.30
2	H	32	ARG	CZ-NH1	-6.97	1.24	1.33
3	I	205	ARG	CZ-NH1	-6.96	1.24	1.33
6	N	17	DC	N1-C6	-6.96	1.32	1.37
5	L	20	C	N1-C6	-6.77	1.33	1.37
6	N	24	DC	N1-C6	-6.76	1.33	1.37
6	N	22	DG	C8-N7	-6.72	1.26	1.30
6	N	23	DC	N1-C6	-6.64	1.33	1.37
5	L	11	C	N1-C6	-6.46	1.33	1.37
5	L	26	G	N9-C8	-6.42	1.33	1.37
5	L	21	A	C8-N7	-6.36	1.27	1.31
6	N	23	DC	C2'-C1'	-6.35	1.45	1.52
5	L	12	G	N9-C8	-6.33	1.33	1.37
5	L	33	G	N9-C8	-6.32	1.33	1.37
5	L	29	G	N9-C8	-6.28	1.33	1.37
5	L	23	G	N9-C8	-6.27	1.33	1.37
5	L	27	G	N9-C8	-6.27	1.33	1.37
3	I	246	TYR	CD2-CE2	-6.20	1.30	1.39
2	F	186	TYR	CD1-CE1	-6.19	1.30	1.39
5	L	28	C	N1-C6	-6.17	1.33	1.37
2	C	183	TYR	CD1-CE1	-6.14	1.30	1.39
5	L	22	G	N9-C8	-6.14	1.33	1.37
6	N	21	DA	C2'-C1'	-6.14	1.46	1.52
1	A	34	TYR	CD1-CE1	-6.13	1.30	1.39

Continued on next page...

Continued from previous page...

Mol	Chain	Res	Type	Atoms	Z	Observed(Å)	Ideal(Å)
2	B	186	TYR	CD2-CE2	-6.12	1.30	1.39
2	C	186	TYR	CD2-CE2	-6.11	1.30	1.39
5	L	47	A	C8-N7	-6.10	1.27	1.31
2	B	68	TYR	CD1-CE1	-6.09	1.30	1.39
2	B	183	TYR	CD1-CE1	-6.09	1.30	1.39
1	A	34	TYR	CD2-CE2	-6.09	1.30	1.39
5	L	15	A	C8-N7	-6.09	1.27	1.31
6	N	21	DA	N9-C8	-6.08	1.32	1.37
2	C	186	TYR	CD1-CE1	-6.08	1.30	1.39
2	F	186	TYR	CD2-CE2	-6.08	1.30	1.39
2	D	186	TYR	CD2-CE2	-6.06	1.30	1.39
2	D	273	TYR	CD1-CE1	-6.05	1.30	1.39
5	L	29	G	C6-N1	-6.04	1.35	1.39
3	I	469	TYR	CD2-CE2	-6.03	1.30	1.39
2	B	183	TYR	CD2-CE2	-6.03	1.30	1.39
4	J	110	TYR	CD1-CE1	-6.01	1.30	1.39
2	D	186	TYR	CD1-CE1	-6.01	1.30	1.39
2	B	273	TYR	CD1-CE1	-6.01	1.30	1.39
2	E	183	TYR	CD2-CE2	-6.00	1.30	1.39
2	E	273	TYR	CD1-CE1	-6.00	1.30	1.39
6	N	24	DC	C2'-C1'	-6.00	1.46	1.52
2	G	8	TYR	CD2-CE2	-5.99	1.30	1.39
6	N	20	DC	C2'-C1'	-5.99	1.46	1.52
4	J	110	TYR	CD2-CE2	-5.98	1.30	1.39
3	I	469	TYR	CD1-CE1	-5.97	1.30	1.39
3	I	470	TYR	CD1-CE1	-5.97	1.30	1.39
3	I	470	TYR	CD2-CE2	-5.97	1.30	1.39
2	E	183	TYR	CD1-CE1	-5.97	1.30	1.39
2	B	273	TYR	CD2-CE2	-5.96	1.30	1.39
2	C	227	GLY	N-CA	-5.96	1.37	1.46
2	D	183	TYR	CD1-CE1	-5.96	1.30	1.39
2	D	273	TYR	CD2-CE2	-5.96	1.30	1.39
2	B	68	TYR	CD2-CE2	-5.95	1.30	1.39
2	B	186	TYR	CD1-CE1	-5.94	1.30	1.39
1	A	19	TYR	CD2-CE2	-5.93	1.30	1.39
1	A	19	TYR	CD1-CE1	-5.92	1.30	1.39
4	K	40	TYR	CD2-CE2	-5.91	1.30	1.39
5	L	33	G	C6-N1	-5.91	1.35	1.39
4	J	109	TYR	CD2-CE2	-5.91	1.30	1.39
2	G	8	TYR	CD1-CE1	-5.90	1.30	1.39
2	C	183	TYR	CD2-CE2	-5.90	1.30	1.39
2	E	273	TYR	CD2-CE2	-5.90	1.30	1.39

Continued on next page...

Continued from previous page...

Mol	Chain	Res	Type	Atoms	Z	Observed(Å)	Ideal(Å)
4	K	110	TYR	CD1-CE1	-5.90	1.30	1.39
1	A	98	TYR	CD1-CE1	-5.90	1.30	1.39
3	I	9	TYR	CD1-CE1	-5.89	1.30	1.39
2	C	114	TYR	CD2-CE2	-5.89	1.30	1.39
3	I	9	TYR	CD2-CE2	-5.87	1.30	1.39
2	D	183	TYR	CD2-CE2	-5.87	1.30	1.39
3	I	385	TYR	CD1-CE1	-5.87	1.30	1.39
5	L	28	C	C4-C5	-5.87	1.38	1.43
1	A	98	TYR	CD2-CE2	-5.86	1.30	1.39
2	C	45	VAL	CB-CG1	-5.86	1.40	1.52
6	N	22	DG	N9-C8	-5.86	1.33	1.37
2	F	114	TYR	CD1-CE1	-5.86	1.30	1.39
3	I	246	TYR	CD1-CE1	-5.86	1.30	1.39
5	L	26	G	C5'-C4'	-5.85	1.44	1.51
4	K	110	TYR	CD2-CE2	-5.85	1.30	1.39
4	J	109	TYR	CD1-CE1	-5.85	1.30	1.39
5	L	27	G	C6-N1	-5.85	1.35	1.39
2	F	114	TYR	CD2-CE2	-5.84	1.30	1.39
2	F	134	GLY	N-CA	-5.84	1.37	1.46
6	N	24	DC	C5'-C4'	-5.84	1.45	1.51
2	B	28	GLY	N-CA	-5.83	1.37	1.46
2	D	227	GLY	N-CA	-5.83	1.37	1.46
2	G	114	TYR	CD2-CE2	-5.83	1.30	1.39
6	N	21	DA	C5'-C4'	-5.82	1.45	1.51
2	E	227	GLY	N-CA	-5.82	1.37	1.46
3	I	252	TYR	CD1-CE1	-5.81	1.30	1.39
3	I	252	TYR	CD2-CE2	-5.79	1.30	1.39
2	C	114	TYR	CD1-CE1	-5.79	1.30	1.39
2	G	28	GLY	N-CA	-5.79	1.37	1.46
3	I	385	TYR	CD2-CE2	-5.79	1.30	1.39
5	L	32	U	C5'-C4'	-5.76	1.44	1.51
6	N	21	DA	C8-N7	-5.76	1.27	1.31
2	D	40	GLY	N-CA	-5.74	1.37	1.46
2	F	227	GLY	N-CA	-5.74	1.37	1.46
2	G	114	TYR	CD1-CE1	-5.72	1.30	1.39
4	J	20	VAL	CB-CG1	-5.71	1.40	1.52
5	L	20	C	C5'-C4'	-5.70	1.44	1.51
2	H	8	TYR	CD1-CE1	-5.70	1.30	1.39
2	C	181	VAL	CB-CG2	-5.69	1.40	1.52
4	K	40	TYR	CD1-CE1	-5.69	1.30	1.39
2	H	8	TYR	CD2-CE2	-5.69	1.30	1.39
5	L	18	C	C4-N4	-5.68	1.28	1.33

Continued on next page...

Continued from previous page...

Mol	Chain	Res	Type	Atoms	Z	Observed(Å)	Ideal(Å)
2	F	120	GLY	N-CA	-5.67	1.37	1.46
2	H	114	TYR	CD2-CE2	-5.67	1.30	1.39
2	B	40	GLY	N-CA	-5.67	1.37	1.46
2	G	45	VAL	CB-CG2	-5.65	1.41	1.52
2	F	40	GLY	N-CA	-5.65	1.37	1.46
2	H	244	GLY	N-CA	-5.62	1.37	1.46
1	A	32	VAL	CB-CG2	-5.62	1.41	1.52
2	G	244	GLY	N-CA	-5.61	1.37	1.46
5	L	26	G	C6-N1	-5.61	1.35	1.39
2	G	227	GLY	N-CA	-5.61	1.37	1.46
2	B	38	GLY	N-CA	-5.60	1.37	1.46
2	G	19	GLY	N-CA	-5.59	1.37	1.46
2	H	114	TYR	CD1-CE1	-5.59	1.30	1.39
2	B	152	VAL	CB-CG1	-5.59	1.41	1.52
2	C	152	VAL	CB-CG1	-5.58	1.41	1.52
2	D	122	VAL	CB-CG1	-5.58	1.41	1.52
1	A	79	SER	CB-OG	-5.57	1.35	1.42
1	A	101	VAL	CB-CG2	-5.57	1.41	1.52
2	D	45	VAL	CB-CG1	-5.57	1.41	1.52
2	G	45	VAL	CB-CG1	-5.57	1.41	1.52
2	C	42	VAL	CB-CG2	-5.55	1.41	1.52
2	D	38	GLY	N-CA	-5.55	1.37	1.46
1	A	78	VAL	CB-CG1	-5.55	1.41	1.52
6	N	16	DT	C5'-C4'	-5.55	1.45	1.51
2	B	23	GLY	N-CA	-5.54	1.37	1.46
1	A	78	VAL	CB-CG2	-5.53	1.41	1.52
2	F	42	VAL	CB-CG2	-5.53	1.41	1.52
3	I	375	GLY	N-CA	-5.52	1.37	1.46
1	A	36	VAL	CB-CG2	-5.52	1.41	1.52
2	C	42	VAL	CB-CG1	-5.52	1.41	1.52
6	N	22	DG	C5'-C4'	-5.52	1.45	1.51
5	L	15	A	N9-C8	-5.52	1.33	1.37
2	F	130	GLY	N-CA	-5.51	1.37	1.46
2	D	45	VAL	CB-CG2	-5.50	1.41	1.52
2	D	223	SER	CB-OG	-5.50	1.35	1.42
2	F	153	SER	CB-OG	-5.50	1.35	1.42
1	A	73	VAL	CB-CG2	-5.50	1.41	1.52
2	C	223	SER	CB-OG	-5.50	1.35	1.42
1	A	32	VAL	CB-CG1	-5.49	1.41	1.52
2	D	262	GLY	N-CA	-5.49	1.37	1.46
3	I	539	VAL	CB-CG1	-5.49	1.41	1.52
5	L	22	G	C5'-C4'	-5.49	1.44	1.51

Continued on next page...

Continued from previous page...

Mol	Chain	Res	Type	Atoms	Z	Observed(Å)	Ideal(Å)
3	I	285	GLY	N-CA	-5.49	1.37	1.46
2	C	19	GLY	N-CA	-5.48	1.37	1.46
5	L	42	U	C2-N3	-5.48	1.33	1.37
2	F	42	VAL	CB-CG1	-5.48	1.41	1.52
6	N	17	DC	C5'-C4'	-5.48	1.45	1.51
2	D	42	VAL	CB-CG1	-5.48	1.41	1.52
3	I	420	SER	CB-OG	-5.48	1.35	1.42
6	N	16	DT	C2'-C1'	-5.48	1.46	1.52
2	B	227	GLY	N-CA	-5.47	1.37	1.46
2	D	19	GLY	N-CA	-5.47	1.37	1.46
1	A	36	VAL	CB-CG1	-5.45	1.41	1.52
2	F	181	VAL	CB-CG1	-5.45	1.41	1.52
1	A	69	VAL	CB-CG1	-5.45	1.41	1.52
1	A	73	VAL	CB-CG1	-5.45	1.41	1.52
2	C	40	GLY	N-CA	-5.45	1.37	1.46
2	H	190	GLY	N-CA	-5.45	1.37	1.46
2	E	19	GLY	N-CA	-5.44	1.37	1.46
1	A	80	SER	CB-OG	-5.44	1.35	1.42
2	H	42	VAL	CB-CG2	-5.43	1.41	1.52
3	I	366	VAL	CB-CG1	-5.43	1.41	1.52
3	I	366	VAL	CB-CG2	-5.43	1.41	1.52
2	C	134	GLY	N-CA	-5.43	1.38	1.46
4	J	108	GLY	N-CA	-5.43	1.38	1.46
6	N	17	DC	C3'-C2'	-5.43	1.45	1.52
2	C	16	VAL	CB-CG1	-5.42	1.41	1.52
2	D	147	VAL	CB-CG1	-5.42	1.41	1.52
2	D	181	VAL	CB-CG2	-5.42	1.41	1.52
2	B	143	SER	CB-OG	-5.42	1.35	1.42
2	F	38	GLY	N-CA	-5.42	1.38	1.46
3	I	349	SER	CB-OG	-5.42	1.35	1.42
2	B	147	VAL	CB-CG1	-5.41	1.41	1.52
2	B	223	SER	CB-OG	-5.41	1.35	1.42
3	I	210	GLY	N-CA	-5.41	1.38	1.46
2	C	45	VAL	CB-CG2	-5.41	1.41	1.52
2	F	55	VAL	CB-CG2	-5.41	1.41	1.52
3	I	371	VAL	CB-CG2	-5.41	1.41	1.52
2	G	61	GLY	N-CA	-5.40	1.38	1.46
2	H	201	GLY	N-CA	-5.40	1.38	1.46
2	C	147	VAL	CB-CG2	-5.40	1.41	1.52
2	B	262	GLY	N-CA	-5.39	1.38	1.46
2	G	23	GLY	N-CA	-5.39	1.38	1.46
2	D	122	VAL	CB-CG2	-5.39	1.41	1.52

Continued on next page...

Continued from previous page...

Mol	Chain	Res	Type	Atoms	Z	Observed(Å)	Ideal(Å)
2	D	132	VAL	CB-CG1	-5.39	1.41	1.52
2	F	147	VAL	CB-CG2	-5.39	1.41	1.52
2	F	231	SER	CB-OG	-5.39	1.35	1.42
2	G	181	VAL	CB-CG2	-5.39	1.41	1.52
3	I	350	VAL	CB-CG2	-5.39	1.41	1.52
2	C	38	GLY	N-CA	-5.38	1.38	1.46
2	G	55	VAL	CB-CG2	-5.38	1.41	1.52
2	E	231	SER	CB-OG	-5.38	1.35	1.42
2	F	23	GLY	N-CA	-5.38	1.38	1.46
2	C	16	VAL	CB-CG2	-5.38	1.41	1.52
2	C	120	GLY	N-CA	-5.38	1.38	1.46
3	I	204	GLY	N-CA	-5.38	1.38	1.46
5	L	11	C	C5'-C4'	-5.38	1.44	1.51
2	C	176	GLY	N-CA	-5.37	1.38	1.46
2	D	181	VAL	CB-CG1	-5.37	1.41	1.52
1	A	69	VAL	CB-CG2	-5.37	1.41	1.52
2	F	176	GLY	N-CA	-5.37	1.38	1.46
2	G	48	LYS	CE-NZ	-5.37	1.35	1.49
2	G	16	VAL	CB-CG1	-5.37	1.41	1.52
2	D	42	VAL	CB-CG2	-5.37	1.41	1.52
3	I	203	GLY	N-CA	-5.37	1.38	1.46
5	L	23	G	C6-N1	-5.37	1.35	1.39
2	C	147	VAL	CB-CG1	-5.37	1.41	1.52
2	E	45	VAL	CB-CG1	-5.37	1.41	1.52
2	G	42	VAL	CB-CG2	-5.37	1.41	1.52
4	J	51	VAL	CB-CG2	-5.37	1.41	1.52
4	J	99	SER	CB-OG	-5.36	1.35	1.42
2	B	184	GLY	N-CA	-5.36	1.38	1.46
2	C	201	GLY	N-CA	-5.36	1.38	1.46
2	E	223	SER	CB-OG	-5.36	1.35	1.42
5	L	28	C	C5'-C4'	-5.35	1.45	1.51
3	I	539	VAL	CB-CG2	-5.35	1.41	1.52
2	G	201	GLY	N-CA	-5.35	1.38	1.46
3	I	374	VAL	CB-CG2	-5.35	1.41	1.52
2	E	11	VAL	CB-CG1	-5.34	1.41	1.52
3	I	382	GLY	N-CA	-5.34	1.38	1.46
2	B	152	VAL	CB-CG2	-5.34	1.41	1.52
2	D	132	VAL	CB-CG2	-5.34	1.41	1.52
3	I	272	TRP	CD1-NE1	-5.34	1.28	1.38
3	I	579	SER	CB-OG	-5.34	1.35	1.42
2	G	211	TRP	CD1-NE1	-5.33	1.28	1.38
2	D	147	VAL	CB-CG2	-5.33	1.41	1.52

Continued on next page...

Continued from previous page...

Mol	Chain	Res	Type	Atoms	Z	Observed(Å)	Ideal(Å)
2	C	152	VAL	CB-CG2	-5.33	1.41	1.52
2	F	19	GLY	N-CA	-5.33	1.38	1.46
2	G	181	VAL	CB-CG1	-5.33	1.41	1.52
6	N	23	DC	C3'-C2'	-5.33	1.45	1.52
2	H	211	TRP	CD1-NE1	-5.32	1.28	1.38
4	J	51	VAL	CB-CG1	-5.32	1.41	1.52
2	C	50	LYS	CE-NZ	-5.31	1.35	1.49
2	E	122	VAL	CB-CG1	-5.31	1.41	1.52
2	D	16	VAL	CB-CG2	-5.31	1.41	1.52
3	I	200	SER	CB-OG	-5.31	1.35	1.42
2	C	181	VAL	CB-CG1	-5.31	1.41	1.52
2	D	16	VAL	CB-CG1	-5.31	1.41	1.52
2	F	162	LYS	CE-NZ	-5.31	1.35	1.49
3	I	490	SER	CB-OG	-5.31	1.35	1.42
4	J	43	SER	CB-OG	-5.30	1.35	1.42
6	N	23	DC	C5'-C4'	-5.30	1.45	1.51
2	D	263	SER	CB-OG	-5.30	1.35	1.42
2	D	269	SER	CB-OG	-5.30	1.35	1.42
2	E	144	VAL	CB-CG2	-5.30	1.41	1.52
2	D	50	LYS	CE-NZ	-5.29	1.35	1.49
2	F	16	VAL	CB-CG2	-5.29	1.41	1.52
2	E	144	VAL	CB-CG1	-5.29	1.41	1.52
4	K	51	VAL	CB-CG2	-5.29	1.41	1.52
3	I	276	SER	CB-OG	-5.29	1.35	1.42
5	L	21	A	N9-C8	-5.29	1.33	1.37
2	G	215	VAL	CB-CG2	-5.29	1.41	1.52
2	F	136	VAL	CB-CG2	-5.28	1.41	1.52
2	G	42	VAL	CB-CG1	-5.28	1.41	1.52
2	G	203	SER	CB-OG	-5.28	1.35	1.42
3	I	350	VAL	CB-CG1	-5.28	1.41	1.52
2	C	148	VAL	CB-CG2	-5.28	1.41	1.52
2	F	16	VAL	CB-CG1	-5.27	1.41	1.52
2	F	181	VAL	CB-CG2	-5.27	1.41	1.52
3	I	531	SER	CB-OG	-5.27	1.35	1.42
2	E	122	VAL	CB-CG2	-5.27	1.41	1.52
2	E	127	VAL	CB-CG1	-5.27	1.41	1.52
2	E	187	VAL	CB-CG1	-5.27	1.41	1.52
4	J	103	GLY	N-CA	-5.27	1.38	1.46
2	F	136	VAL	CB-CG1	-5.27	1.41	1.52
2	F	230	SER	CB-OG	-5.27	1.35	1.42
3	I	371	VAL	CB-CG1	-5.27	1.41	1.52
2	B	178	LYS	CE-NZ	-5.27	1.35	1.49

Continued on next page...

Continued from previous page...

Mol	Chain	Res	Type	Atoms	Z	Observed(Å)	Ideal(Å)
2	E	187	VAL	CB-CG2	-5.27	1.41	1.52
4	J	31	GLY	N-CA	-5.27	1.38	1.46
2	F	147	VAL	CB-CG1	-5.26	1.41	1.52
2	E	16	VAL	CB-CG2	-5.26	1.41	1.52
4	J	20	VAL	CB-CG2	-5.26	1.41	1.52
5	L	13	C	C5'-C4'	-5.26	1.45	1.51
3	I	447	GLY	N-CA	-5.26	1.38	1.46
4	K	43	SER	CB-OG	-5.25	1.35	1.42
3	I	374	VAL	CB-CG1	-5.25	1.41	1.52
2	E	11	VAL	CB-CG2	-5.25	1.41	1.52
4	K	49	GLY	N-CA	-5.25	1.38	1.46
2	F	48	LYS	CE-NZ	-5.25	1.35	1.49
5	L	12	G	C5'-C4'	-5.25	1.45	1.51
5	L	12	G	C6-N1	-5.25	1.35	1.39
5	L	27	G	C5'-C4'	-5.24	1.45	1.51
2	C	148	VAL	CB-CG1	-5.24	1.41	1.52
2	C	178	LYS	CE-NZ	-5.24	1.35	1.49
2	D	143	SER	CB-OG	-5.24	1.35	1.42
2	D	176	GLY	N-CA	-5.24	1.38	1.46
3	I	445	VAL	CB-CG2	-5.23	1.41	1.52
4	J	98	SER	CB-OG	-5.23	1.35	1.42
1	A	101	VAL	CB-CG1	-5.23	1.41	1.52
2	C	61	GLY	N-CA	-5.23	1.38	1.46
2	F	61	GLY	N-CA	-5.23	1.38	1.46
2	G	215	VAL	CB-CG1	-5.22	1.41	1.52
5	L	20	C	C4-C5	-5.22	1.38	1.43
5	L	13	C	C4-C5	-5.22	1.38	1.43
3	I	489	VAL	CB-CG2	-5.21	1.42	1.52
4	K	15	GLY	N-CA	-5.21	1.38	1.46
2	C	199	LYS	CE-NZ	-5.21	1.36	1.49
2	G	236	VAL	CB-CG2	-5.21	1.42	1.52
5	L	15	A	C5'-C4'	-5.21	1.45	1.51
2	E	93	LYS	CE-NZ	-5.21	1.36	1.49
2	E	257	VAL	CB-CG1	-5.21	1.42	1.52
3	I	440	SER	CB-OG	-5.21	1.35	1.42
2	H	203	SER	CB-OG	-5.20	1.35	1.42
2	D	72	LYS	CE-NZ	-5.20	1.36	1.49
2	G	236	VAL	CB-CG1	-5.20	1.42	1.52
2	C	143	SER	CB-OG	-5.20	1.35	1.42
2	E	127	VAL	CB-CG2	-5.19	1.42	1.52
2	G	59	LYS	CE-NZ	-5.19	1.36	1.49
2	B	147	VAL	CB-CG2	-5.19	1.42	1.52

Continued on next page...

Continued from previous page...

Mol	Chain	Res	Type	Atoms	Z	Observed(Å)	Ideal(Å)
2	C	136	VAL	CB-CG2	-5.18	1.42	1.52
3	I	445	VAL	CB-CG1	-5.18	1.42	1.52
2	D	162	LYS	CE-NZ	-5.18	1.36	1.49
2	G	231	SER	CB-OG	-5.18	1.35	1.42
6	N	22	DG	C2'-C1'	-5.18	1.47	1.52
2	F	122	VAL	CB-CG2	-5.18	1.42	1.52
3	I	511	LYS	CE-NZ	-5.18	1.36	1.49
2	E	257	VAL	CB-CG2	-5.18	1.42	1.52
2	C	55	VAL	CB-CG2	-5.17	1.42	1.52
2	C	136	VAL	CB-CG1	-5.17	1.42	1.52
2	B	176	GLY	N-CA	-5.17	1.38	1.46
2	E	16	VAL	CB-CG1	-5.17	1.42	1.52
2	F	55	VAL	CB-CG1	-5.17	1.42	1.52
2	G	50	LYS	CE-NZ	-5.17	1.36	1.49
4	J	37	LYS	CE-NZ	-5.17	1.36	1.49
2	B	264	SER	CB-OG	-5.17	1.35	1.42
3	I	216	SER	CB-OG	-5.16	1.35	1.42
2	F	93	LYS	CE-NZ	-5.16	1.36	1.49
3	I	602	LYS	CE-NZ	-5.16	1.36	1.49
2	G	238	LYS	CE-NZ	-5.16	1.36	1.49
2	H	108	TRP	CD1-NE1	-5.16	1.29	1.38
2	B	151	GLU	CB-CG	-5.15	1.42	1.52
2	G	16	VAL	CB-CG2	-5.15	1.42	1.52
2	D	178	LYS	CE-NZ	-5.15	1.36	1.49
4	K	51	VAL	CB-CG1	-5.14	1.42	1.52
2	G	11	VAL	CB-CG2	-5.14	1.42	1.52
6	N	16	DT	C2-N3	-5.14	1.33	1.37
5	L	21	A	C5'-C4'	-5.14	1.45	1.51
2	F	143	SER	CB-OG	-5.14	1.35	1.42
3	I	247	VAL	CB-CG2	-5.14	1.42	1.52
2	G	55	VAL	CB-CG1	-5.13	1.42	1.52
4	J	29	VAL	CB-CG1	-5.13	1.42	1.52
2	G	11	VAL	CB-CG1	-5.13	1.42	1.52
2	H	55	VAL	CB-CG2	-5.12	1.42	1.52
5	L	22	G	C6-N1	-5.12	1.35	1.39
2	E	184	GLY	N-CA	-5.12	1.38	1.46
2	H	42	VAL	CB-CG1	-5.12	1.42	1.52
4	K	29	VAL	CB-CG1	-5.12	1.42	1.52
4	K	31	GLY	N-CA	-5.12	1.38	1.46
5	L	33	G	C5'-C4'	-5.12	1.45	1.51
2	F	50	LYS	CE-NZ	-5.12	1.36	1.49
2	F	94	LYS	CE-NZ	-5.12	1.36	1.49

Continued on next page...

Continued from previous page...

Mol	Chain	Res	Type	Atoms	Z	Observed(Å)	Ideal(Å)
4	K	114	LYS	CE-NZ	-5.12	1.36	1.49
2	E	143	SER	CB-OG	-5.11	1.35	1.42
4	J	65	LYS	CE-NZ	-5.11	1.36	1.49
5	L	11	C	C4-C5	-5.11	1.38	1.43
2	E	45	VAL	CB-CG2	-5.11	1.42	1.52
2	E	50	LYS	CE-NZ	-5.11	1.36	1.49
3	I	337	LYS	CE-NZ	-5.11	1.36	1.49
1	A	33	SER	CB-OG	-5.10	1.35	1.42
2	C	55	VAL	CB-CG1	-5.10	1.42	1.52
2	B	50	LYS	CE-NZ	-5.10	1.36	1.49
3	I	247	VAL	CB-CG1	-5.09	1.42	1.52
4	J	68	LYS	CE-NZ	-5.09	1.36	1.49
2	E	48	LYS	CE-NZ	-5.09	1.36	1.49
2	E	148	VAL	CB-CG1	-5.09	1.42	1.52
5	L	47	A	C5'-C4'	-5.09	1.45	1.51
2	F	152	VAL	CB-CG2	-5.09	1.42	1.52
4	J	95	VAL	CB-CG1	-5.08	1.42	1.52
2	F	132	VAL	CB-CG2	-5.08	1.42	1.52
6	N	20	DC	C4-C5	-5.08	1.38	1.43
3	I	484	LYS	CE-NZ	-5.08	1.36	1.49
3	I	508	VAL	CB-CG1	-5.07	1.42	1.52
4	J	45	SER	CB-OG	-5.07	1.35	1.42
3	I	489	VAL	CB-CG1	-5.07	1.42	1.52
4	J	29	VAL	CB-CG2	-5.07	1.42	1.52
2	C	48	LYS	CE-NZ	-5.06	1.36	1.49
3	I	548	SER	CB-OG	-5.06	1.35	1.42
2	E	233	LYS	CE-NZ	-5.06	1.36	1.49
5	L	46	C	C4-N4	-5.06	1.29	1.33
2	G	190	GLY	N-CA	-5.06	1.38	1.46
2	F	132	VAL	CB-CG1	-5.06	1.42	1.52
2	G	250	LYS	CE-NZ	-5.05	1.36	1.49
6	N	16	DT	N1-C6	-5.05	1.34	1.38
3	I	365	SER	CB-OG	-5.05	1.35	1.42
4	K	95	VAL	CB-CG1	-5.04	1.42	1.52
6	N	22	DG	C6-N1	-5.04	1.36	1.39
2	D	159	VAL	CB-CG1	-5.04	1.42	1.52
4	J	95	VAL	CB-CG2	-5.04	1.42	1.52
3	I	545	LYS	CE-NZ	-5.03	1.36	1.49
2	G	152	VAL	CB-CG2	-5.03	1.42	1.52
6	N	16	DT	C3'-C2'	-5.03	1.46	1.52
2	F	59	LYS	CE-NZ	-5.03	1.36	1.49
3	I	402	SER	CB-OG	-5.03	1.35	1.42

Continued on next page...

Continued from previous page...

Mol	Chain	Res	Type	Atoms	Z	Observed(Å)	Ideal(Å)
2	D	199	LYS	CE-NZ	-5.02	1.36	1.49
2	H	55	VAL	CB-CG1	-5.02	1.42	1.52
2	D	184	GLY	N-CA	-5.02	1.38	1.46
4	K	1	VAL	CB-CG1	-5.02	1.42	1.52
3	I	214	VAL	CB-CG2	-5.02	1.42	1.52
2	H	48	LYS	CE-NZ	-5.01	1.36	1.49
2	C	59	LYS	CE-NZ	-5.01	1.36	1.49
2	E	148	VAL	CB-CG2	-5.01	1.42	1.52
2	F	178	LYS	CE-NZ	-5.01	1.36	1.49
4	K	95	VAL	CB-CG2	-5.01	1.42	1.52
3	I	415	LYS	CE-NZ	-5.00	1.36	1.49
2	H	199	LYS	CE-NZ	-5.00	1.36	1.49

All (319) bond angle outliers are listed below:

Mol	Chain	Res	Type	Atoms	Z	Observed(°)	Ideal(°)
6	N	25	DT	OP2-P-O3'	-44.21	7.94	105.20
5	L	45	C	O4'-C1'-N1	19.71	123.97	108.20
5	L	29	G	N7-C8-N9	13.19	119.70	113.10
5	L	21	A	N1-C2-N3	12.20	135.40	129.30
5	L	47	A	N7-C8-N9	12.12	119.86	113.80
5	L	47	A	N1-C2-N3	12.00	135.30	129.30
6	N	26	DG	P-O3'-C3'	-11.91	105.41	119.70
5	L	23	G	N7-C8-N9	11.67	118.93	113.10
6	N	22	DG	N7-C8-N9	11.67	118.93	113.10
5	L	26	G	N7-C8-N9	11.66	118.93	113.10
5	L	15	A	N1-C2-N3	11.52	135.06	129.30
6	N	21	DA	N1-C2-N3	11.50	135.05	129.30
5	L	22	G	N7-C8-N9	11.49	118.85	113.10
5	L	33	G	N7-C8-N9	11.45	118.83	113.10
5	L	21	A	N7-C8-N9	11.43	119.51	113.80
5	L	27	G	N7-C8-N9	11.31	118.76	113.10
6	N	21	DA	N7-C8-N9	10.95	119.27	113.80
5	L	15	A	N7-C8-N9	10.88	119.24	113.80
5	L	12	G	N7-C8-N9	10.78	118.49	113.10
5	L	30	A	N1-C6-N6	-10.64	112.22	118.60
5	L	28	C	C6-N1-C2	-9.89	116.34	120.30
5	L	27	G	C6-N1-C2	9.80	130.98	125.10
5	L	42	U	C2-N3-C4	9.71	132.83	127.00
5	L	47	A	O4'-C1'-N9	9.52	115.81	108.20
5	L	33	G	C6-N1-C2	9.43	130.76	125.10
6	N	16	DT	C2-N3-C4	9.40	132.84	127.20

Continued on next page...

Continued from previous page...

Mol	Chain	Res	Type	Atoms	Z	Observed(°)	Ideal(°)
5	L	23	G	C6-N1-C2	9.31	130.69	125.10
5	L	26	G	C6-N1-C2	9.29	130.67	125.10
5	L	12	G	C6-N1-C2	9.24	130.65	125.10
5	L	42	U	N3-C4-C5	-9.15	109.11	114.60
5	L	29	G	C6-N1-C2	9.12	130.57	125.10
6	N	22	DG	C6-N1-C2	9.06	130.53	125.10
2	C	52	ARG	NE-CZ-NH2	9.01	124.81	120.30
2	G	156	ARG	NE-CZ-NH2	9.00	124.80	120.30
5	L	20	C	C6-N1-C2	-8.99	116.70	120.30
6	N	16	DT	C5-C6-N1	8.80	128.98	123.70
4	K	67	ARG	NE-CZ-NH2	8.62	124.61	120.30
6	N	16	DT	N3-C4-O4	8.61	125.06	119.90
5	L	29	G	C8-N9-C4	-8.58	102.97	106.40
5	L	32	U	C2-N3-C4	8.30	131.98	127.00
5	L	11	C	C6-N1-C2	-8.28	116.99	120.30
5	L	40	A	N1-C6-N6	-8.27	113.64	118.60
6	N	25	DT	P-O3'-C3'	-8.27	109.77	119.70
5	L	22	G	C8-N9-C4	-8.15	103.14	106.40
5	L	22	G	C6-N1-C2	8.12	129.97	125.10
5	L	29	G	O4'-C1'-N9	8.00	114.60	108.20
5	L	47	A	C8-N9-C4	-7.89	102.64	105.80
5	L	30	A	C5-C6-N1	7.84	121.62	117.70
2	B	177	ARG	NE-CZ-NH2	7.81	124.21	120.30
2	F	52	ARG	NE-CZ-NH2	7.81	124.21	120.30
5	L	20	C	N3-C4-C5	-7.76	118.80	121.90
5	L	32	U	N3-C4-C5	-7.67	110.00	114.60
6	N	22	DG	C8-N9-C4	-7.65	103.34	106.40
5	L	45	C	C1'-O4'-C4'	-7.63	103.79	109.90
2	G	177	ARG	NE-CZ-NH2	7.61	124.10	120.30
5	L	28	C	C5-C6-N1	7.60	124.80	121.00
5	L	28	C	O4'-C1'-N1	7.53	114.23	108.20
5	L	40	A	C5-C6-N1	7.53	121.47	117.70
5	L	28	C	N3-C4-C5	-7.51	118.89	121.90
5	L	13	C	C6-N1-C2	-7.49	117.30	120.30
5	L	32	U	C5-C6-N1	7.31	126.36	122.70
5	L	47	A	C5'-C4'-O4'	7.29	117.85	109.10
2	D	268	ARG	NE-CZ-NH2	7.21	123.91	120.30
5	L	26	G	C8-N9-C4	-7.18	103.53	106.40
5	L	44	U	C3'-C2'-C1'	7.11	107.19	101.50
2	H	252	PHE	CB-CG-CD2	7.08	125.76	120.80
2	G	156	ARG	C-N-CA	7.08	139.39	121.70
2	C	177	ARG	NE-CZ-NH2	7.04	123.82	120.30

Continued on next page...

Continued from previous page...

Mol	Chain	Res	Type	Atoms	Z	Observed(°)	Ideal(°)
3	I	471	ARG	NE-CZ-NH2	7.04	123.82	120.30
3	I	225	PHE	CB-CG-CD2	7.03	125.72	120.80
5	L	23	G	C8-N9-C4	-7.03	103.59	106.40
5	L	27	G	C8-N9-C4	-7.03	103.59	106.40
5	L	21	A	C8-N9-C4	-6.99	103.00	105.80
5	L	46	C	N3-C2-O2	-6.97	117.02	121.90
2	B	140	PHE	CB-CG-CD2	6.96	125.67	120.80
5	L	39	C	N3-C2-O2	-6.95	117.03	121.90
3	I	385	TYR	CB-CG-CD2	6.87	125.12	121.00
2	F	140	PHE	CB-CG-CD2	6.87	125.61	120.80
5	L	22	G	O4'-C1'-N9	6.85	113.68	108.20
5	L	14	C	N3-C2-O2	-6.84	117.11	121.90
2	E	140	PHE	CB-CG-CD2	6.83	125.58	120.80
6	N	31	DT	C6-C5-C7	-6.82	118.81	122.90
2	C	140	PHE	CB-CG-CD2	6.82	125.57	120.80
6	N	17	DC	N3-C4-C5	-6.80	119.18	121.90
4	K	16	ARG	NE-CZ-NH2	6.79	123.69	120.30
6	N	26	DG	OP1-P-OP2	-6.79	109.42	119.60
2	H	68	TYR	CB-CG-CD2	-6.78	116.93	121.00
6	N	23	DC	N3-C4-C5	-6.78	119.19	121.90
5	L	29	G	C5-N7-C8	-6.78	100.91	104.30
6	N	29	DC	OP1-P-OP2	-6.75	109.48	119.60
2	D	140	PHE	CB-CG-CD2	6.74	125.52	120.80
6	N	20	DC	N3-C4-C5	-6.73	119.21	121.90
6	N	24	DC	N3-C4-C5	-6.73	119.21	121.90
1	A	75	ARG	CD-NE-CZ	6.72	133.01	123.60
6	N	20	DC	C6-N1-C2	-6.71	117.61	120.30
3	I	12	ARG	CD-NE-CZ	6.68	132.95	123.60
2	G	252	PHE	CB-CG-CD2	6.67	125.47	120.80
2	H	7	ARG	CD-NE-CZ	6.67	132.94	123.60
1	A	110	ARG	CD-NE-CZ	6.67	132.93	123.60
5	L	21	A	C6-N1-C2	-6.63	114.62	118.60
1	A	165	PHE	CB-CG-CD2	6.63	125.44	120.80
3	I	383	ARG	CD-NE-CZ	6.61	132.86	123.60
5	L	33	G	C8-N9-C4	-6.61	103.76	106.40
2	G	7	ARG	CD-NE-CZ	6.59	132.83	123.60
4	J	7	ARG	CD-NE-CZ	6.59	132.82	123.60
2	G	49	ARG	CD-NE-CZ	6.58	132.81	123.60
2	E	222	ARG	CD-NE-CZ	6.57	132.80	123.60
1	A	107	ARG	CD-NE-CZ	6.56	132.79	123.60
2	E	133	ARG	CD-NE-CZ	6.56	132.79	123.60
2	H	81	ARG	CD-NE-CZ	6.55	132.77	123.60

Continued on next page...

Continued from previous page...

Mol	Chain	Res	Type	Atoms	Z	Observed(°)	Ideal(°)
3	I	527	ARG	NE-CZ-NH2	6.55	123.57	120.30
5	L	23	G	C5-N7-C8	-6.55	101.03	104.30
5	L	20	C	C5-C6-N1	6.55	124.27	121.00
3	I	386	ARG	CD-NE-CZ	6.54	132.76	123.60
2	F	133	ARG	CD-NE-CZ	6.54	132.76	123.60
2	B	49	ARG	CD-NE-CZ	6.53	132.75	123.60
2	C	133	ARG	CD-NE-CZ	6.53	132.74	123.60
5	L	47	A	OP1-P-OP2	-6.52	109.81	119.60
2	H	49	ARG	CD-NE-CZ	6.51	132.71	123.60
1	A	74	ARG	CD-NE-CZ	6.50	132.70	123.60
3	I	504	ARG	CD-NE-CZ	6.50	132.70	123.60
2	D	133	ARG	CD-NE-CZ	6.50	132.69	123.60
3	I	408	ARG	CD-NE-CZ	6.50	132.69	123.60
1	A	24	ARG	CD-NE-CZ	6.49	132.69	123.60
2	D	49	ARG	CD-NE-CZ	6.49	132.69	123.60
2	D	157	MET	CA-CB-CG	6.49	124.33	113.30
2	G	173	ARG	CD-NE-CZ	6.48	132.67	123.60
2	E	232	ARG	CD-NE-CZ	6.48	132.67	123.60
5	L	11	C	N3-C4-C5	-6.47	119.31	121.90
5	L	15	A	C8-N9-C4	-6.46	103.22	105.80
4	K	10	ARG	CD-NE-CZ	6.46	132.64	123.60
2	C	156	ARG	CD-NE-CZ	6.46	132.64	123.60
5	L	15	A	P-O3'-C3'	6.45	127.44	119.70
1	A	186	ARG	CD-NE-CZ	6.45	132.63	123.60
6	N	23	DC	C6-N1-C2	-6.45	117.72	120.30
2	E	49	ARG	CD-NE-CZ	6.44	132.62	123.60
5	L	13	C	N3-C4-C5	-6.44	119.32	121.90
5	L	33	G	C5-C6-N1	-6.44	108.28	111.50
4	J	10	ARG	CD-NE-CZ	6.43	132.61	123.60
2	D	232	ARG	CD-NE-CZ	6.43	132.60	123.60
2	B	222	ARG	CD-NE-CZ	6.43	132.60	123.60
6	N	19	DC	N3-C2-O2	-6.43	117.40	121.90
5	L	29	G	C5-C6-N1	-6.42	108.29	111.50
2	G	32	ARG	CD-NE-CZ	6.40	132.56	123.60
5	L	12	G	C8-N9-C4	-6.39	103.84	106.40
2	B	177	ARG	NE-CZ-NH1	-6.39	117.10	120.30
5	L	33	G	C5-N7-C8	-6.39	101.11	104.30
2	E	177	ARG	NE-CZ-NH2	6.38	123.49	120.30
5	L	13	C	P-O3'-C3'	6.34	127.31	119.70
2	B	259	ARG	CD-NE-CZ	6.34	132.47	123.60
2	E	183	TYR	CB-CG-CD2	6.34	124.80	121.00
3	I	367	ARG	NE-CZ-NH2	6.33	123.47	120.30

Continued on next page...

Continued from previous page...

Mol	Chain	Res	Type	Atoms	Z	Observed(°)	Ideal(°)
5	L	37	G	C5'-C4'-C3'	-6.33	105.88	116.00
2	G	83	TYR	CB-CG-CD2	-6.32	117.21	121.00
5	L	26	G	C5-N7-C8	-6.31	101.15	104.30
6	N	21	DA	C8-N9-C4	-6.30	103.28	105.80
2	B	173	ARG	NE-CZ-NH2	6.29	123.44	120.30
2	F	64	ARG	CD-NE-CZ	6.29	132.40	123.60
2	F	217	MET	CA-CB-CG	6.29	123.99	113.30
6	N	24	DC	C6-N1-C2	-6.29	117.79	120.30
5	L	41	C	C4'-C3'-C2'	-6.27	96.33	102.60
2	G	104	ARG	NE-CZ-NH2	6.27	123.43	120.30
2	H	104	ARG	NE-CZ-NH2	6.26	123.43	120.30
5	L	40	A	C4-C5-C6	-6.25	113.88	117.00
6	N	17	DC	C6-N1-C2	-6.21	117.81	120.30
2	G	140	PHE	CB-CG-CD2	6.21	125.14	120.80
5	L	21	A	C5-N7-C8	-6.20	100.80	103.90
2	G	64	ARG	CD-NE-CZ	6.18	132.25	123.60
5	L	27	G	C5-N7-C8	-6.16	101.22	104.30
6	N	22	DG	C5-N7-C8	-6.13	101.23	104.30
1	A	34	TYR	CB-CG-CD2	6.10	124.66	121.00
3	I	346	MET	CA-CB-CG	6.09	123.66	113.30
3	I	450	ARG	NE-CZ-NH2	6.09	123.35	120.30
5	L	47	A	C5-N7-C8	-6.07	100.86	103.90
5	L	11	C	C5-C6-N1	6.06	124.03	121.00
3	I	481	ARG	NE-CZ-NH2	6.05	123.33	120.30
2	H	217	MET	CA-CB-CG	6.04	123.56	113.30
2	H	64	ARG	CD-NE-CZ	6.02	132.03	123.60
3	I	469	TYR	CB-CG-CD2	5.99	124.59	121.00
5	L	45	C	N3-C2-O2	-5.98	117.71	121.90
5	L	12	G	C5-N7-C8	-5.97	101.32	104.30
2	D	177	ARG	CD-NE-CZ	5.95	131.93	123.60
5	L	24	C	N3-C2-O2	-5.95	117.73	121.90
6	N	20	DC	C5-C6-N1	5.95	123.97	121.00
3	I	601	ARG	NE-CZ-NH2	5.94	123.27	120.30
2	C	49	ARG	NE-CZ-NH2	5.93	123.27	120.30
5	L	44	U	O4'-C1'-N1	5.93	112.94	108.20
4	J	97	MET	CA-CB-CG	5.92	123.36	113.30
5	L	13	C	C4-C5-C6	5.90	120.35	117.40
5	L	26	G	O4'-C1'-N9	5.87	112.90	108.20
4	K	40	TYR	CB-CG-CD2	5.87	124.52	121.00
5	L	15	A	C5-N7-C8	-5.87	100.97	103.90
2	E	123	MET	CA-CB-CG	5.86	123.27	113.30
2	C	119	PHE	CB-CG-CD2	5.84	124.89	120.80

Continued on next page...

Continued from previous page...

Mol	Chain	Res	Type	Atoms	Z	Observed(°)	Ideal(°)
2	F	1	MET	CA-CB-CG	5.83	123.20	113.30
4	J	110	TYR	CB-CG-CD2	5.82	124.49	121.00
6	N	21	DA	C5-N7-C8	-5.81	100.99	103.90
2	G	117	ARG	NE-CZ-NH2	5.81	123.21	120.30
6	N	20	DC	C4-C5-C6	5.81	120.31	117.40
2	C	142	ARG	CD-NE-CZ	5.80	131.72	123.60
5	L	42	U	C5-C6-N1	5.80	125.60	122.70
3	I	571	MET	CA-CB-CG	5.79	123.13	113.30
5	L	23	G	C5-C6-N1	-5.78	108.61	111.50
5	L	18	C	N3-C4-N4	-5.78	113.96	118.00
2	C	64	ARG	CD-NE-CZ	5.77	131.68	123.60
2	G	229	MET	CA-CB-CG	5.77	123.11	113.30
5	L	20	C	C4-C5-C6	5.75	120.28	117.40
6	N	24	DC	C5-C6-N1	5.75	123.87	121.00
2	G	242	ARG	CD-NE-CZ	5.73	131.63	123.60
6	N	17	DC	C4-C5-C6	5.73	120.27	117.40
3	I	252	TYR	CB-CG-CD2	5.73	124.44	121.00
2	G	156	ARG	O-C-N	-5.73	113.54	122.70
6	N	23	DC	C5-C6-N1	5.72	123.86	121.00
2	F	229	MET	CA-CB-CG	5.71	123.01	113.30
2	C	186	TYR	CB-CG-CD2	5.71	124.42	121.00
2	H	68	TYR	CB-CG-CD1	5.70	124.42	121.00
5	L	41	C	N3-C2-O2	-5.70	117.91	121.90
6	N	21	DA	C2-N3-C4	-5.70	107.75	110.60
5	L	15	A	C2-N3-C4	-5.68	107.76	110.60
6	N	17	DC	C5-C6-N1	5.67	123.83	121.00
2	F	49	ARG	NE-CZ-NH2	5.66	123.13	120.30
2	B	68	TYR	CB-CG-CD2	5.66	124.39	121.00
2	E	226	ARG	CD-NE-CZ	5.66	131.52	123.60
5	L	33	G	P-O3'-C3'	5.63	126.46	119.70
6	N	24	DC	C4-C5-C6	5.63	120.22	117.40
5	L	22	G	C5-N7-C8	-5.63	101.49	104.30
2	C	117	ARG	CD-NE-CZ	5.61	131.45	123.60
5	L	28	C	C5-C4-N4	5.60	124.12	120.20
5	L	36	C	N3-C2-O2	-5.60	117.98	121.90
6	N	23	DC	C4-C5-C6	5.57	120.18	117.40
5	L	46	C	N1-C2-O2	5.55	122.23	118.90
2	G	155	THR	O-C-N	-5.53	113.86	122.70
2	D	183	TYR	CB-CG-CD2	5.52	124.31	121.00
5	L	18	C	N3-C2-O2	-5.51	118.04	121.90
5	L	18	C	N1-C2-O2	5.51	122.20	118.90
5	L	46	C	C3'-C2'-C1'	5.50	105.90	101.50

Continued on next page...

Continued from previous page...

Mol	Chain	Res	Type	Atoms	Z	Observed(°)	Ideal(°)
2	F	186	TYR	CB-CG-CD2	5.50	124.30	121.00
5	L	30	A	C4-C5-C6	-5.48	114.26	117.00
2	H	133	ARG	NE-CZ-NH2	5.47	123.03	120.30
5	L	39	C	N1-C2-O2	5.46	122.18	118.90
5	L	30	A	O4'-C1'-C2'	-5.46	100.34	105.80
2	B	186	TYR	CB-CG-CD2	5.46	124.28	121.00
2	F	119	PHE	CB-CG-CD2	5.46	124.62	120.80
5	L	13	C	C5-C6-N1	5.46	123.73	121.00
5	L	27	G	C5-C6-N1	-5.44	108.78	111.50
1	A	186	ARG	CG-CD-NE	5.43	123.20	111.80
2	H	113	PHE	CB-CG-CD2	5.43	124.60	120.80
2	C	229	MET	CA-CB-CG	5.43	122.52	113.30
2	F	117	ARG	CD-NE-CZ	5.42	131.19	123.60
6	N	31	DT	O4'-C1'-N1	5.41	111.79	108.00
4	J	117	PHE	CB-CG-CD2	5.41	124.59	120.80
5	L	41	C	N1-C2-O2	5.40	122.14	118.90
5	L	26	G	N1-C2-N3	-5.40	120.66	123.90
3	I	9	TYR	CB-CG-CD2	5.39	124.23	121.00
5	L	11	C	C4-C5-C6	5.39	120.09	117.40
5	L	47	A	C2-N3-C4	-5.37	107.92	110.60
2	H	68	TYR	CA-CB-CG	5.36	123.58	113.40
5	L	15	A	O4'-C1'-N9	5.35	112.48	108.20
5	L	12	G	C5-C6-N1	-5.34	108.83	111.50
2	F	142	ARG	CD-NE-CZ	5.34	131.07	123.60
2	H	140	PHE	CB-CG-CD2	5.33	124.53	120.80
2	H	67	ILE	O-C-N	-5.33	114.17	122.70
3	I	338	ARG	CD-NE-CZ	5.33	131.06	123.60
3	I	570	MET	CA-CB-CG	5.32	122.35	113.30
2	C	183	TYR	CB-CG-CD2	5.31	124.19	121.00
6	N	16	DT	C6-N1-C2	-5.31	118.64	121.30
2	F	173	ARG	NE-CZ-NH2	5.28	122.94	120.30
5	L	15	A	C6-N1-C2	-5.26	115.44	118.60
2	H	242	ARG	CD-NE-CZ	5.26	130.96	123.60
6	N	31	DT	N3-C2-O2	-5.25	119.15	122.30
5	L	22	G	C5-C6-N1	-5.24	108.88	111.50
6	N	28	DG	C1'-O4'-C4'	-5.23	104.87	110.10
2	F	138	MET	CA-CB-CG	5.23	122.19	113.30
6	N	20	DC	C3'-C2'-C1'	5.22	108.76	102.50
6	N	21	DA	C3'-C2'-C1'	5.21	108.75	102.50
2	G	52	ARG	CA-CB-CG	5.21	124.85	113.40
2	E	138	MET	CA-CB-CG	5.20	122.14	113.30
3	I	498	ARG	NE-CZ-NH2	5.18	122.89	120.30

Continued on next page...

Continued from previous page...

Mol	Chain	Res	Type	Atoms	Z	Observed(°)	Ideal(°)
5	L	23	G	N1-C6-O6	5.18	123.01	119.90
2	H	210	PHE	CB-CG-CD2	5.18	124.43	120.80
2	D	229	MET	CA-CB-CG	5.18	122.10	113.30
1	A	24	ARG	CA-CB-CG	5.16	124.76	113.40
6	N	33	DG	N1-C6-O6	-5.15	116.81	119.90
2	D	270	PHE	CB-CG-CD2	5.15	124.41	120.80
2	G	178	LYS	C-N-CA	5.15	134.57	121.70
1	A	116	ARG	CD-NE-CZ	5.15	130.81	123.60
5	L	20	C	O4'-C1'-N1	5.14	112.31	108.20
5	L	36	C	O4'-C1'-N1	5.13	112.31	108.20
2	H	7	ARG	CA-CB-CG	5.13	124.69	113.40
5	L	39	C	O4'-C1'-N1	5.13	112.31	108.20
5	L	44	U	C5-C6-N1	-5.12	120.14	122.70
4	J	83	MET	CA-CB-CG	5.12	122.00	113.30
2	B	222	ARG	CG-CD-NE	5.12	122.55	111.80
3	I	361	ALA	CB-CA-C	5.12	117.78	110.10
2	D	178	LYS	CA-CB-CG	5.11	124.64	113.40
2	G	217	MET	CA-CB-CG	5.10	121.97	113.30
4	K	79	TYR	CB-CG-CD2	-5.09	117.95	121.00
2	C	133	ARG	CG-CD-NE	5.07	122.46	111.80
3	I	463	ARG	NE-CZ-NH2	5.07	122.84	120.30
6	N	22	DG	C5-C6-N1	-5.07	108.96	111.50
5	L	21	A	C2-N3-C4	-5.07	108.06	110.60
2	B	175	MET	C-N-CA	5.07	132.94	122.30
2	F	94	LYS	CA-CB-CG	5.07	124.55	113.40
5	L	29	G	N1-C6-O6	5.06	122.94	119.90
5	L	44	U	C4'-C3'-C2'	-5.06	97.54	102.60
1	A	74	ARG	CG-CD-NE	5.06	122.42	111.80
6	N	19	DC	N3-C4-C5	5.06	123.92	121.90
2	D	232	ARG	CG-CD-NE	5.05	122.41	111.80
3	I	351	ARG	CD-NE-CZ	5.05	130.68	123.60
6	N	29	DC	OP2-P-O3'	5.05	116.31	105.20
2	F	178	LYS	CA-CB-CG	5.04	124.48	113.40
5	L	47	A	C6-N1-C2	-5.03	115.58	118.60
2	G	7	ARG	CA-CB-CG	5.03	124.47	113.40
2	F	226	ARG	NE-CZ-NH2	5.03	122.81	120.30
4	K	65	LYS	CA-CB-CG	5.02	124.44	113.40
2	G	83	TYR	CB-CG-CD1	5.01	124.01	121.00
2	E	232	ARG	CG-CD-NE	5.01	122.31	111.80
2	C	268	ARG	CD-NE-CZ	5.00	130.60	123.60
2	D	259	ARG	CD-NE-CZ	5.00	130.60	123.60

There are no chirality outliers.

All (12) planarity outliers are listed below:

Mol	Chain	Res	Type	Group
2	F	226	ARG	Sidechain
2	G	155	THR	Mainchain
2	G	226	ARG	Sidechain
2	G	68	TYR	Sidechain
2	G	83	TYR	Sidechain
2	H	117	ARG	Sidechain
2	H	123	MET	Peptide
2	H	83	TYR	Sidechain
3	I	498	ARG	Sidechain
5	L	41	C	Sidechain
5	L	44	U	Sidechain
5	L	45	C	Sidechain

5.2 Too-close contacts [i](#)

In the following table, the Non-H and H(model) columns list the number of non-hydrogen atoms and hydrogen atoms in the chain respectively. The H(added) column lists the number of hydrogen atoms added and optimized by MolProbity. The Clashes column lists the number of clashes within the asymmetric unit, whereas Symm-Clashes lists symmetry-related clashes.

Mol	Chain	Non-H	H(model)	H(added)	Clashes	Symm-Clashes
1	A	1774	1761	1762	11	0
2	B	2112	2081	2079	6	0
2	C	2238	2224	2223	9	0
2	D	2238	2224	2223	25	0
2	E	2238	2224	2223	12	0
2	F	2238	2224	2223	13	0
2	G	2238	2224	2223	17	0
2	H	2238	2224	2223	39	0
3	I	3267	3269	3261	11	0
4	J	930	933	931	6	0
4	K	930	933	931	2	0
5	L	980	500	459	13	0
6	N	369	202	188	8	0
All	All	23790	23023	22949	159	0

The all-atom clashscore is defined as the number of clashes found per 1000 atoms (including hydrogen atoms). The all-atom clashscore for this structure is 3.

All (159) close contacts within the same asymmetric unit are listed below, sorted by their clash magnitude.

Atom-1	Atom-2	Interatomic distance (Å)	Clash overlap (Å)
3:I:590:GLN:O	3:I:591:GLY:N	1.67	1.27
3:I:588:ASP:O	3:I:589:GLU:N	1.78	1.16
4:K:100:ASP:O	4:K:101:GLU:N	1.80	1.13
2:E:282:GLU:OE1	2:E:282:GLU:N	2.12	0.81
2:F:282:GLU:N	2:F:282:GLU:OE1	2.13	0.81
2:D:282:GLU:OE1	2:D:282:GLU:N	2.13	0.80
1:A:211:GLU:N	1:A:211:GLU:OE1	2.16	0.78
2:B:282:GLU:N	2:B:282:GLU:OE1	2.14	0.78
2:F:155:THR:OG1	5:L:42:U:OP2	2.03	0.77
2:C:261:GLU:N	2:C:261:GLU:OE1	2.17	0.77
2:B:107:ASP:O	2:B:111:THR:HG23	1.84	0.76
6:N:26:DG:C8	6:N:26:DG:H5'	2.22	0.75
6:N:26:DG:H2'	6:N:27:DA:C8	2.22	0.75
2:C:282:GLU:N	2:C:282:GLU:OE1	2.20	0.73
2:G:282:GLU:N	2:G:282:GLU:OE1	2.20	0.72
2:H:45:VAL:O	5:L:47:A:O3'	2.04	0.70
2:E:63:GLU:OE1	2:E:64:ARG:N	2.27	0.67
2:H:45:VAL:HG22	5:L:47:A:O3'	1.95	0.67
6:N:29:DC:H4'	6:N:30:DA:OP2	1.95	0.66
4:J:83:MET:O	4:J:87:ILE:HG22	1.95	0.66
2:D:83:TYR:OH	2:D:128:ASN:O	2.03	0.66
2:E:131:GLN:NE2	5:L:26:G:N3	2.44	0.66
2:D:107:ASP:O	2:D:111:THR:HG23	1.96	0.66
2:H:20:ASN:N	2:H:225:ALA:O	2.30	0.65
1:A:224:GLU:N	1:A:224:GLU:OE1	2.31	0.64
2:C:161:THR:OG1	2:D:126:GLU:OE2	2.17	0.62
2:H:63:GLU:O	2:H:66:ASN:ND2	2.33	0.61
2:D:289:MET:SD	2:D:289:MET:N	2.74	0.61
2:H:46:CYS:O	5:L:47:A:O2'	2.18	0.61
5:L:12:G:O2'	5:L:13:C:OP2	2.15	0.61
2:B:80:GLU:OE1	2:B:81:ARG:N	2.31	0.60
2:C:161:THR:HG22	2:C:163:ALA:H	1.66	0.60
2:D:102:ALA:O	2:D:105:VAL:HG22	2.02	0.60
2:H:16:VAL:HG12	2:H:184:GLY:O	2.02	0.59
6:N:26:DG:H2''	6:N:27:DA:O4'	2.01	0.59
2:D:131:GLN:NE2	5:L:20:C:O2	2.36	0.58
2:H:66:ASN:N	2:H:112:ASN:O	2.35	0.58
2:H:15:ASP:OD2	2:H:232:ARG:NE	2.37	0.58
2:G:46:CYS:SG	2:G:50:LYS:NZ	2.77	0.57
3:I:399:GLU:N	3:I:399:GLU:OE1	2.37	0.57
4:J:7:ARG:O	4:J:8:THR:OG1	2.17	0.57
3:I:240:GLN:N	3:I:240:GLN:OE1	2.38	0.56

Continued on next page...

Continued from previous page...

Atom-1	Atom-2	Interatomic distance (Å)	Clash overlap (Å)
4:J:101:GLU:OE1	4:J:101:GLU:N	2.38	0.56
2:H:40:GLY:N	2:H:143:SER:OG	2.33	0.56
1:A:55:ILE:HD13	1:A:126:PHE:CZ	2.41	0.56
2:H:269:SER:N	2:H:272:ASP:OD2	2.35	0.55
2:H:42:VAL:HG23	2:H:186:TYR:CE2	2.41	0.55
2:G:157:MET:SD	2:G:157:MET:N	2.80	0.55
2:E:217:MET:HA	2:E:217:MET:HE3	1.87	0.55
2:B:30:MET:SD	2:B:179:HIS:ND1	2.80	0.54
2:H:241:ASN:ND2	2:H:243:LEU:O	2.41	0.54
2:D:82:ALA:HB2	2:D:108:TRP:CE3	2.42	0.54
2:G:173:ARG:NH1	2:H:71:GLU:OE2	2.40	0.54
3:I:4:GLN:HA	3:I:186:ILE:HD11	1.89	0.53
6:N:26:DG:C4	6:N:27:DA:C6	2.97	0.53
1:A:55:ILE:HD12	1:A:56:ARG:N	2.23	0.53
3:I:22:PRO:N	3:I:23:PRO:CD	2.72	0.53
2:H:24:ASP:N	2:H:30:MET:O	2.36	0.52
2:E:46:CYS:SG	2:E:50:LYS:NZ	2.83	0.51
2:B:115:ASP:N	2:B:115:ASP:OD1	2.43	0.51
2:H:159:VAL:HG22	2:H:160:THR:H	1.75	0.51
2:D:83:TYR:O	2:D:88:LEU:N	2.40	0.51
2:H:128:ASN:CG	2:H:129:CYS:H	2.14	0.50
4:J:98:SER:N	4:J:101:GLU:OE1	2.44	0.50
2:D:122:VAL:HG21	5:L:21:A:C2	2.47	0.50
2:F:105:VAL:HG11	2:F:129:CYS:SG	2.51	0.50
2:E:87:ASP:O	2:E:88:LEU:HD13	2.12	0.49
6:N:26:DG:H1'	6:N:27:DA:C4	2.46	0.49
2:C:12:LEU:C	2:C:13:LEU:HD12	2.33	0.49
3:I:184:CYS:O	3:I:188:GLY:N	2.44	0.49
2:E:95:LEU:HD21	2:E:129:CYS:HA	1.95	0.48
2:E:124:THR:O	2:E:124:THR:HG23	2.12	0.48
2:F:15:ASP:OD1	2:F:16:VAL:N	2.46	0.48
2:G:63:GLU:OE2	2:G:64:ARG:N	2.46	0.48
2:G:156:ARG:O	2:G:174:THR:N	2.46	0.48
2:H:37:THR:OG1	2:H:39:HIS:ND1	2.45	0.48
2:H:46:CYS:HA	5:L:47:A:H2'	1.95	0.48
3:I:371:VAL:HG12	3:I:371:VAL:O	2.12	0.48
2:C:204:ASP:N	2:C:204:ASP:OD1	2.45	0.47
5:L:27:G:O2'	5:L:28:C:OP2	2.23	0.47
1:A:91:MET:SD	1:A:91:MET:N	2.76	0.47
2:H:16:VAL:HG12	2:H:184:GLY:C	2.36	0.47
2:H:268:ARG:N	2:H:272:ASP:OD2	2.46	0.47

Continued on next page...

Continued from previous page...

Atom-1	Atom-2	Interatomic distance (Å)	Clash overlap (Å)
2:H:289:MET:H	2:H:289:MET:CE	2.27	0.47
2:H:16:VAL:HG22	2:H:16:VAL:O	2.14	0.47
4:J:98:SER:O	4:J:101:GLU:N	2.48	0.46
2:H:68:TYR:N	2:H:115:ASP:OD2	2.47	0.46
2:F:259:ARG:NH1	2:F:265:GLY:O	2.38	0.46
2:G:15:ASP:OD2	2:G:232:ARG:NE	2.39	0.46
2:H:44:ASP:HB2	2:H:138:MET:HE1	1.97	0.46
2:F:63:GLU:N	2:F:63:GLU:OE1	2.49	0.46
2:D:289:MET:H	2:D:289:MET:CE	2.29	0.46
2:D:290:LEU:HD12	2:D:290:LEU:H	1.81	0.45
2:D:74:ILE:HD12	2:D:74:ILE:N	2.32	0.45
2:D:92:PRO:HA	2:D:127:VAL:HA	1.98	0.45
2:G:157:MET:HE3	2:G:173:ARG:HG3	1.99	0.45
2:H:148:VAL:HG13	2:H:148:VAL:O	2.17	0.45
1:A:129:THR:OG1	1:A:130:ASP:N	2.50	0.45
2:G:156:ARG:N	2:G:174:THR:O	2.50	0.45
3:I:588:ASP:C	3:I:589:GLU:N	2.64	0.45
2:D:67:ILE:O	2:D:67:ILE:HG23	2.17	0.44
2:D:126:GLU:OE1	2:D:126:GLU:N	2.45	0.44
2:B:71:GLU:O	2:B:71:GLU:HG3	2.17	0.44
2:G:269:SER:N	2:G:272:ASP:OD2	2.45	0.44
1:A:77:GLU:N	1:A:108:GLN:O	2.47	0.44
2:H:16:VAL:HG22	2:H:19:GLY:O	2.18	0.44
1:A:27:MET:SD	1:A:27:MET:N	2.91	0.44
2:D:16:VAL:HG22	2:D:17:GLU:N	2.33	0.44
6:N:26:DG:C5	6:N:27:DA:N6	2.86	0.43
2:H:58:THR:HG23	2:H:59:LYS:N	2.33	0.43
2:C:76:ASN:ND2	2:C:127:VAL:H	2.15	0.43
2:H:45:VAL:O	5:L:47:A:O2'	2.36	0.43
2:D:83:TYR:CG	2:D:90:PRO:HA	2.53	0.43
2:G:83:TYR:CE2	2:G:96:PRO:HD3	2.53	0.43
2:D:63:GLU:OE2	2:D:64:ARG:N	2.49	0.43
4:K:84:GLN:HA	4:K:87:ILE:HG22	2.01	0.43
2:F:203:SER:OG	2:F:204:ASP:N	2.52	0.43
2:D:12:LEU:C	2:D:13:LEU:HD12	2.39	0.43
2:D:82:ALA:CB	2:D:109:MET:HE2	2.49	0.43
2:H:175:MET:C	2:H:175:MET:SD	2.97	0.43
2:E:204:ASP:N	2:E:204:ASP:OD1	2.52	0.42
1:A:36:VAL:HG22	1:A:37:MET:N	2.35	0.42
3:I:206:ASP:N	3:I:206:ASP:OD1	2.52	0.42
2:G:213:ALA:O	2:G:217:MET:HB3	2.19	0.42

Continued on next page...

Continued from previous page...

Atom-1	Atom-2	Interatomic distance (Å)	Clash overlap (Å)
2:E:58:THR:HG23	2:E:59:LYS:N	2.33	0.42
2:C:241:ASN:ND2	2:C:243:LEU:O	2.53	0.42
2:D:233:LYS:NZ	2:D:288:GLU:OE2	2.43	0.42
2:F:86:CYS:SG	2:F:105:VAL:HA	2.59	0.42
2:E:145:GLU:OE1	2:E:273:TYR:OH	2.34	0.42
2:F:93:LYS:O	2:F:124:THR:HG23	2.20	0.42
2:H:54:HIS:ND1	2:H:213:ALA:HA	2.35	0.42
2:D:289:MET:H	2:D:289:MET:HE3	1.85	0.42
2:H:27:ALA:HB3	2:H:30:MET:HB2	2.01	0.42
2:H:183:TYR:CZ	2:H:270:PHE:HA	2.55	0.42
2:F:112:ASN:OD1	2:F:113:PHE:N	2.53	0.41
2:G:58:THR:HG23	2:G:59:LYS:N	2.35	0.41
2:G:207:LEU:HD11	2:G:211:TRP:CZ2	2.55	0.41
6:N:26:DG:C2'	6:N:27:DA:C8	3.00	0.41
2:C:99:VAL:HG21	2:C:105:VAL:CG2	2.51	0.41
2:H:49:ARG:HB2	5:L:47:A:H4'	2.02	0.41
1:A:131:LYS:HD2	1:A:131:LYS:O	2.21	0.41
2:H:45:VAL:HG13	5:L:47:A:O3'	2.20	0.41
2:H:237:PHE:CD2	2:H:286:VAL:HG22	2.55	0.41
2:D:12:LEU:O	2:D:13:LEU:HD12	2.21	0.41
2:H:117:ARG:HE	2:H:206:ASP:CG	2.24	0.41
2:G:260:ALA:N	2:G:272:ASP:O	2.44	0.41
2:E:50:LYS:O	2:E:217:MET:HE1	2.21	0.41
2:G:156:ARG:O	2:G:174:THR:HB	2.22	0.41
2:H:15:ASP:CG	2:H:232:ARG:HE	2.23	0.41
3:I:22:PRO:CD	3:I:23:PRO:HD3	2.51	0.40
2:F:82:ALA:C	2:F:105:VAL:HG13	2.42	0.40
2:H:259:ARG:NH2	2:H:265:GLY:O	2.42	0.40
2:F:82:ALA:HA	2:F:108:TRP:CZ3	2.56	0.40
2:G:159:VAL:HG21	2:G:163:ALA:HB3	2.03	0.40
1:A:137:ASN:OD1	1:A:139:GLY:N	2.55	0.40
2:D:16:VAL:HG23	2:D:229:MET:HG2	2.03	0.40
2:F:286:VAL:O	2:F:286:VAL:HG13	2.20	0.40
2:H:197:ALA:O	2:H:201:GLY:N	2.52	0.40
4:J:81:ILE:O	4:J:85:GLU:HG2	2.21	0.40

There are no symmetry-related clashes.

5.3 Torsion angles [i](#)

5.3.1 Protein backbone [i](#)

In the following table, the Percentiles column shows the percent Ramachandran outliers of the chain as a percentile score with respect to all PDB entries followed by that with respect to all EM entries.

The Analysed column shows the number of residues for which the backbone conformation was analysed, and the total number of residues.

Mol	Chain	Analysed	Favoured	Allowed	Outliers	Percentiles	
1	A	218/227 (96%)	210 (96%)	8 (4%)	0	100	100
2	B	264/290 (91%)	253 (96%)	11 (4%)	0	100	100
2	C	282/290 (97%)	266 (94%)	16 (6%)	0	100	100
2	D	282/290 (97%)	266 (94%)	16 (6%)	0	100	100
2	E	282/290 (97%)	267 (95%)	15 (5%)	0	100	100
2	F	282/290 (97%)	265 (94%)	17 (6%)	0	100	100
2	G	282/290 (97%)	262 (93%)	20 (7%)	0	100	100
2	H	282/290 (97%)	259 (92%)	22 (8%)	1 (0%)	34	66
3	I	402/612 (66%)	383 (95%)	19 (5%)	0	100	100
4	J	111/124 (90%)	108 (97%)	3 (3%)	0	100	100
4	K	111/124 (90%)	109 (98%)	2 (2%)	0	100	100
All	All	2798/3117 (90%)	2648 (95%)	149 (5%)	1 (0%)	100	100

All (1) Ramachandran outliers are listed below:

Mol	Chain	Res	Type
2	H	122	VAL

5.3.2 Protein sidechains [i](#)

In the following table, the Percentiles column shows the percent sidechain outliers of the chain as a percentile score with respect to all PDB entries followed by that with respect to all EM entries.

The Analysed column shows the number of residues for which the sidechain conformation was analysed, and the total number of residues.

Mol	Chain	Analysed	Rotameric	Outliers	Percentiles	
1	A	189/194 (97%)	178 (94%)	11 (6%)	20	50

Continued on next page...

Continued from previous page...

Mol	Chain	Analysed	Rotameric	Outliers	Percentiles	
2	B	224/242 (93%)	224 (100%)	0	100	100
2	C	239/242 (99%)	234 (98%)	5 (2%)	53	84
2	D	239/242 (99%)	234 (98%)	5 (2%)	53	84
2	E	239/242 (99%)	232 (97%)	7 (3%)	42	76
2	F	239/242 (99%)	234 (98%)	5 (2%)	53	84
2	G	239/242 (99%)	234 (98%)	5 (2%)	53	84
2	H	239/242 (99%)	231 (97%)	8 (3%)	38	72
3	I	347/508 (68%)	335 (96%)	12 (4%)	36	70
4	J	99/105 (94%)	98 (99%)	1 (1%)	76	93
4	K	99/105 (94%)	98 (99%)	1 (1%)	76	93
All	All	2392/2606 (92%)	2332 (98%)	60 (2%)	50	80

All (60) residues with a non-rotameric sidechain are listed below:

Mol	Chain	Res	Type
1	A	23	THR
1	A	27	MET
1	A	35	ASP
1	A	37	MET
1	A	91	MET
1	A	95	LYS
1	A	114	LEU
1	A	129	THR
1	A	131	LYS
1	A	188	LEU
1	A	191	MET
2	C	83	TYR
2	C	95	LEU
2	C	129	CYS
2	C	191	PHE
2	C	206	ASP
2	D	171	ASP
2	D	175	MET
2	D	191	PHE
2	D	217	MET
2	D	289	MET
2	E	24	ASP
2	E	32	ARG

Continued on next page...

Continued from previous page...

Mol	Chain	Res	Type
2	E	75	LEU
2	E	124	THR
2	E	129	CYS
2	E	191	PHE
2	E	206	ASP
2	F	63	GLU
2	F	83	TYR
2	F	122	VAL
2	F	175	MET
2	F	179	HIS
2	G	105	VAL
2	G	150	GLN
2	G	157	MET
2	G	175	MET
2	G	290	LEU
2	H	68	TYR
2	H	105	VAL
2	H	112	ASN
2	H	124	THR
2	H	138	MET
2	H	175	MET
2	H	229	MET
2	H	289	MET
3	I	13	MET
3	I	21	MET
3	I	286	MET
3	I	287	PHE
3	I	363	ARG
3	I	402	SER
3	I	413	LEU
3	I	432	LEU
3	I	542	MET
3	I	561	LYS
3	I	580	ASP
3	I	588	ASP
4	J	33	ASN
4	K	73	LYS

Sometimes sidechains can be flipped to improve hydrogen bonding and reduce clashes. All (9) such sidechains are listed below:

Mol	Chain	Res	Type
2	B	79	HIS

Continued on next page...

Continued from previous page...

Mol	Chain	Res	Type
2	E	179	HIS
2	F	179	HIS
2	G	79	HIS
2	G	179	HIS
2	G	220	HIS
2	H	66	ASN
2	H	112	ASN
2	H	245	ASN

5.3.3 RNA [i](#)

Mol	Chain	Analysed	Backbone Outliers	Pucker Outliers
5	L	45/46 (97%)	24 (53%)	3 (6%)
6	N	0/18	-	-
All	All	45/64 (70%)	24 (53%)	3 (6%)

All (24) RNA backbone outliers are listed below:

Mol	Chain	Res	Type
5	L	3	G
5	L	5	U
5	L	12	G
5	L	13	C
5	L	16	U
5	L	18	C
5	L	22	G
5	L	23	G
5	L	24	C
5	L	28	C
5	L	29	G
5	L	30	A
5	L	31	G
5	L	32	U
5	L	34	G
5	L	36	C
5	L	37	G
5	L	38	C
5	L	40	A
5	L	41	C
5	L	42	U
5	L	45	C

Continued on next page...

Continued from previous page...

Mol	Chain	Res	Type
5	L	46	C
5	L	47	A

All (3) RNA pucker outliers are listed below:

Mol	Chain	Res	Type
5	L	30	A
5	L	36	C
5	L	46	C

5.4 Non-standard residues in protein, DNA, RNA chains [i](#)

There are no non-standard protein/DNA/RNA residues in this entry.

5.5 Carbohydrates [i](#)

There are no monosaccharides in this entry.

5.6 Ligand geometry [i](#)

There are no ligands in this entry.

5.7 Other polymers [i](#)

There are no such residues in this entry.

5.8 Polymer linkage issues [i](#)

The following chains have linkage breaks:

Mol	Chain	Number of breaks
3	I	3
4	J	1
4	K	1

All chain breaks are listed below:

Model	Chain	Residue-1	Atom-1	Residue-2	Atom-2	Distance (Å)
1	I	325:ARG	C	326:MET	N	4.99
1	J	100:ASP	C	101:GLU	N	3.12
1	K	100:ASP	C	101:GLU	N	2.76
1	I	590:GLN	C	591:GLY	N	2.65
1	I	588:ASP	C	589:GLU	N	2.64

6 Map visualisation [i](#)

This section contains visualisations of the EMDB entry EMD-27403. These allow visual inspection of the internal detail of the map and identification of artifacts.

Images derived from a raw map, generated by summing the deposited half-maps, are presented below the corresponding image components of the primary map to allow further visual inspection and comparison with those of the primary map.

6.1 Orthogonal projections [i](#)

6.1.1 Primary map

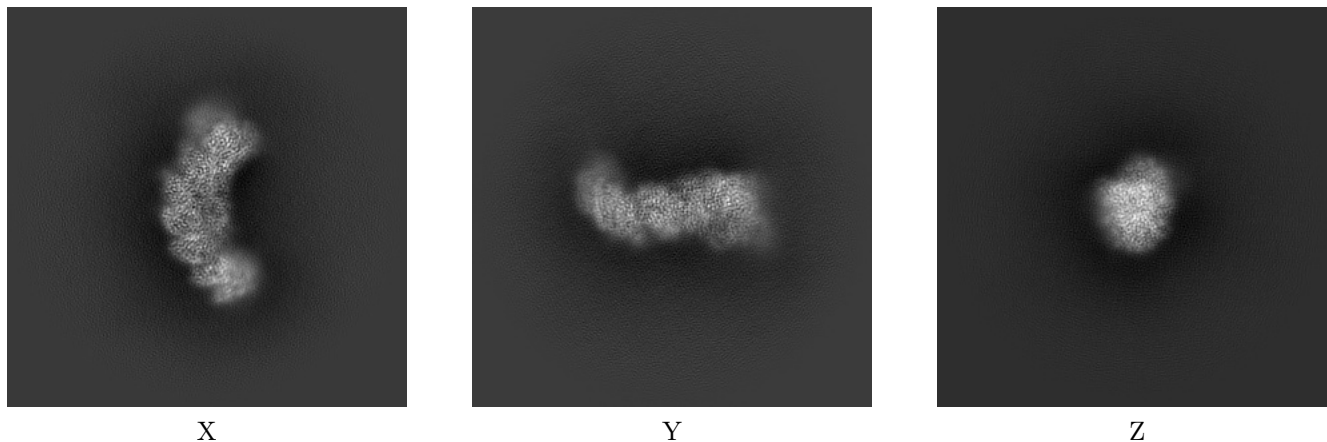

6.1.2 Raw map

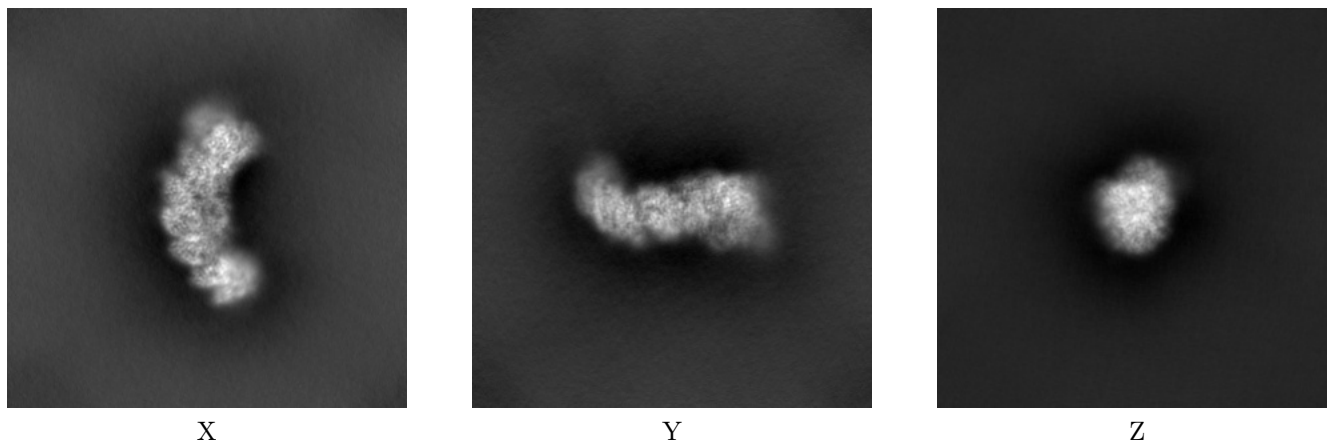

The images above show the map projected in three orthogonal directions.

6.2 Central slices [i](#)

6.2.1 Primary map

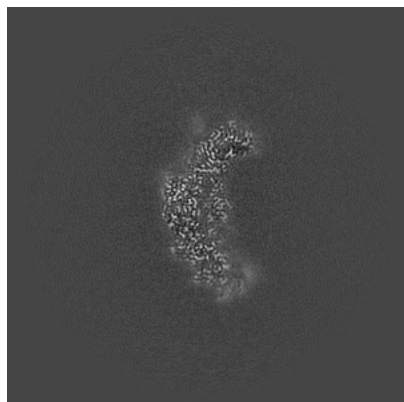

X Index: 192

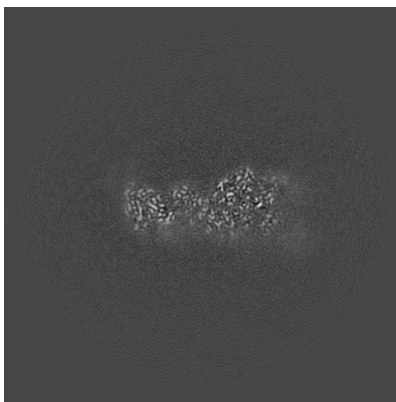

Y Index: 192

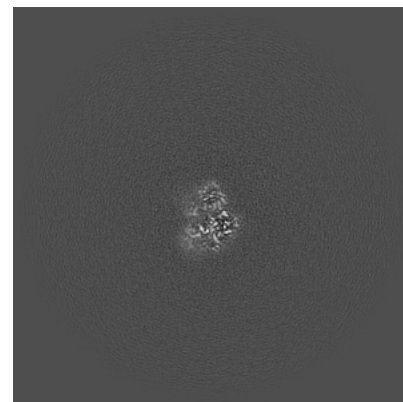

Z Index: 192

6.2.2 Raw map

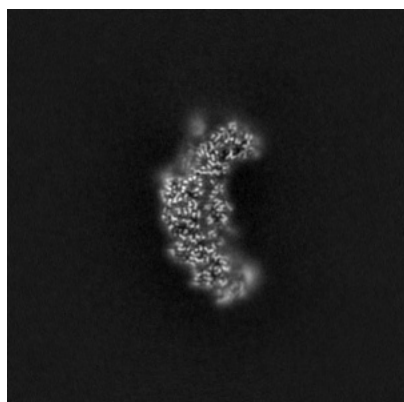

X Index: 192

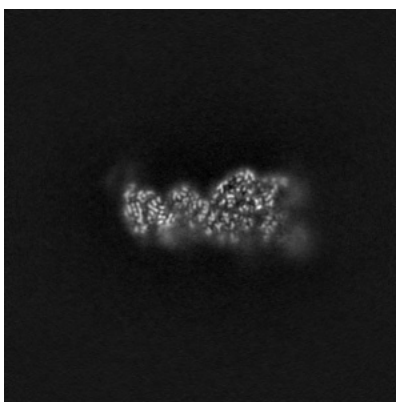

Y Index: 192

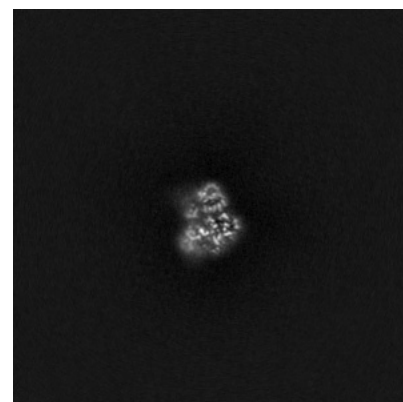

Z Index: 192

The images above show central slices of the map in three orthogonal directions.

6.3 Largest variance slices [i](#)

6.3.1 Primary map

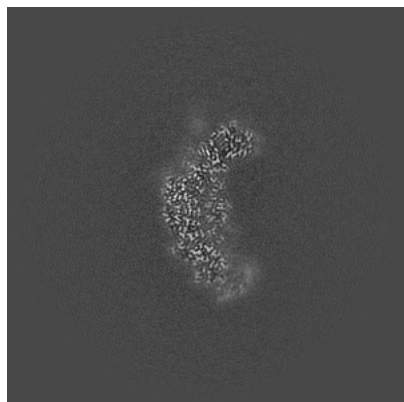

X Index: 193

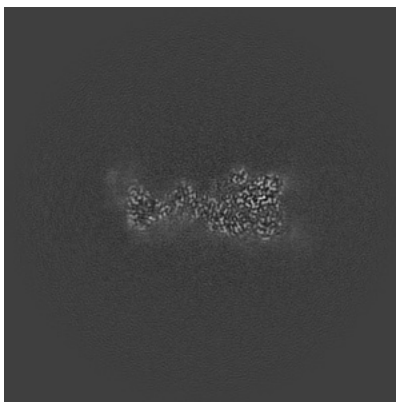

Y Index: 198

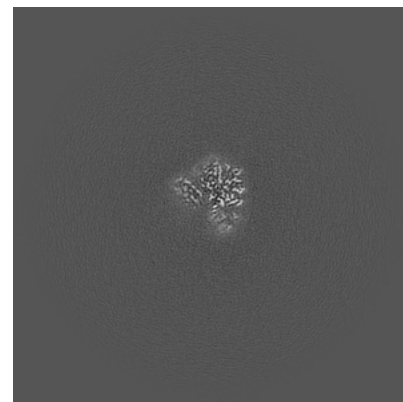

Z Index: 245

6.3.2 Raw map

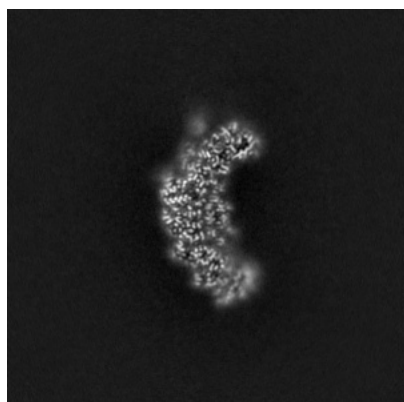

X Index: 194

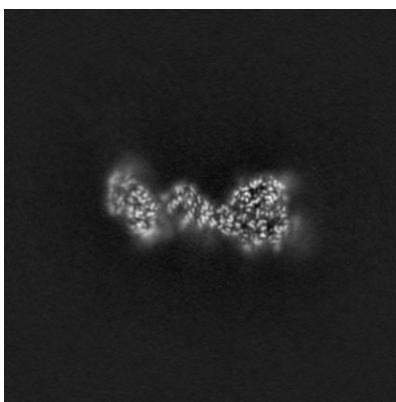

Y Index: 205

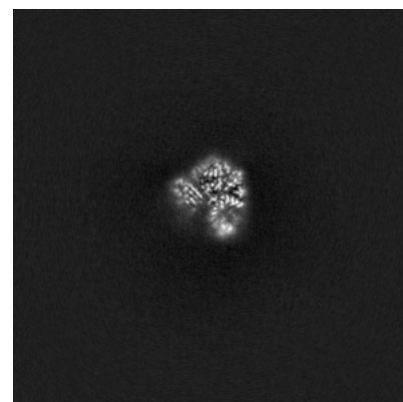

Z Index: 246

The images above show the largest variance slices of the map in three orthogonal directions.

6.4 Orthogonal standard-deviation projections (False-color) [i](#)

6.4.1 Primary map

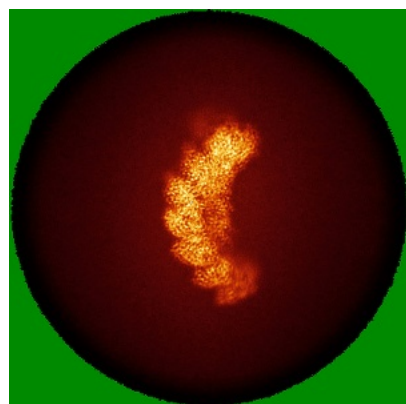

X

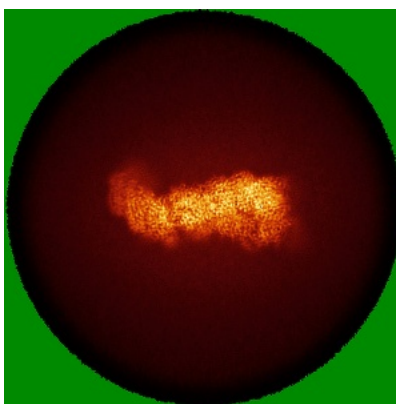

Y

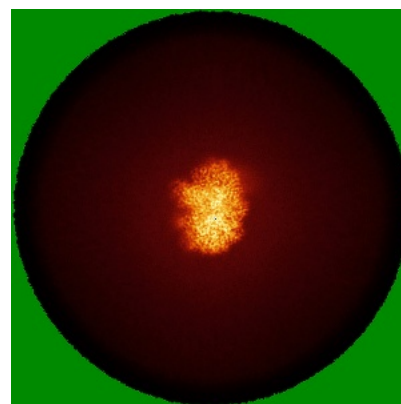

Z

6.4.2 Raw map

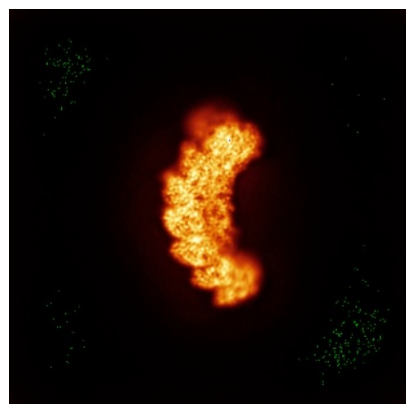

X

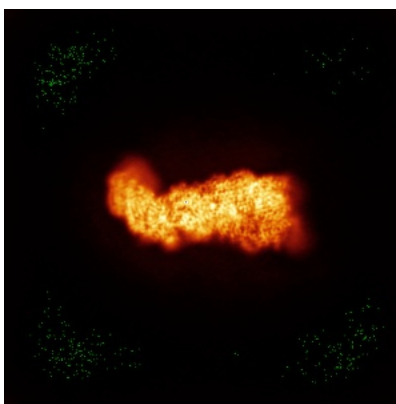

Y

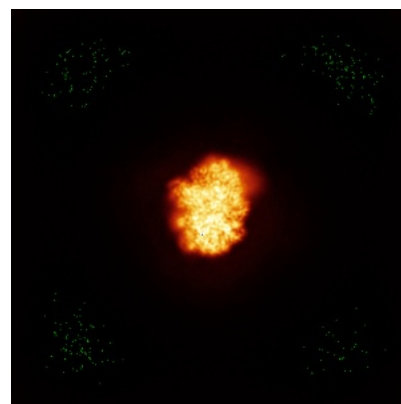

Z

The images above show the map standard deviation projections with false color in three orthogonal directions. Minimum values are shown in green, max in blue, and dark to light orange shades represent small to large values respectively.

6.5 Orthogonal surface views [i](#)

6.5.1 Primary map

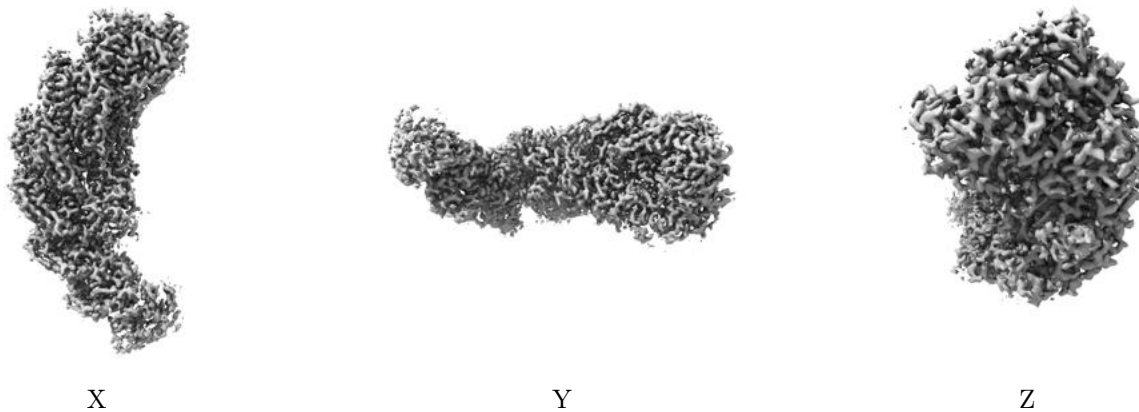

The images above show the 3D surface view of the map at the recommended contour level 1.55. These images, in conjunction with the slice images, may facilitate assessment of whether an appropriate contour level has been provided.

6.5.2 Raw map

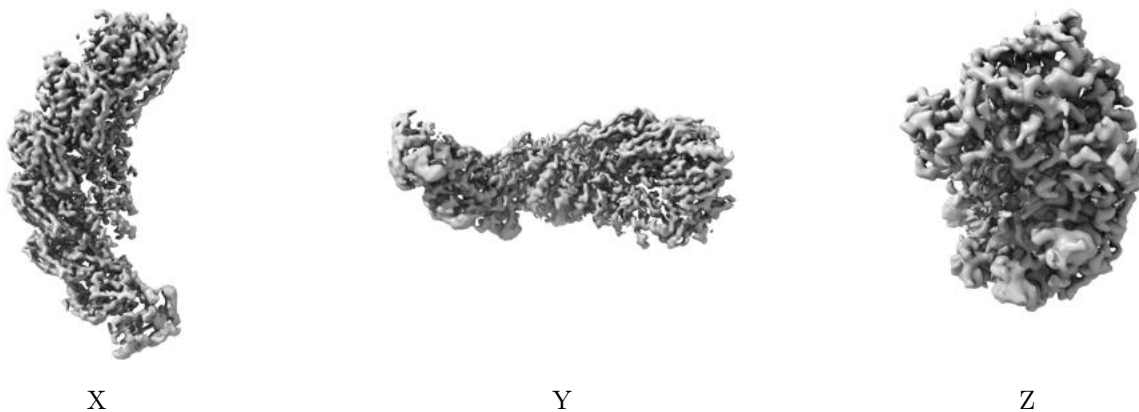

These images show the 3D surface of the raw map. The raw map's contour level was selected so that its surface encloses the same volume as the primary map does at its recommended contour level.

6.6 Mask visualisation [i](#)

This section was not generated. No masks/segmentation were deposited.

7 Map analysis [i](#)

This section contains the results of statistical analysis of the map.

7.1 Map-value distribution [i](#)

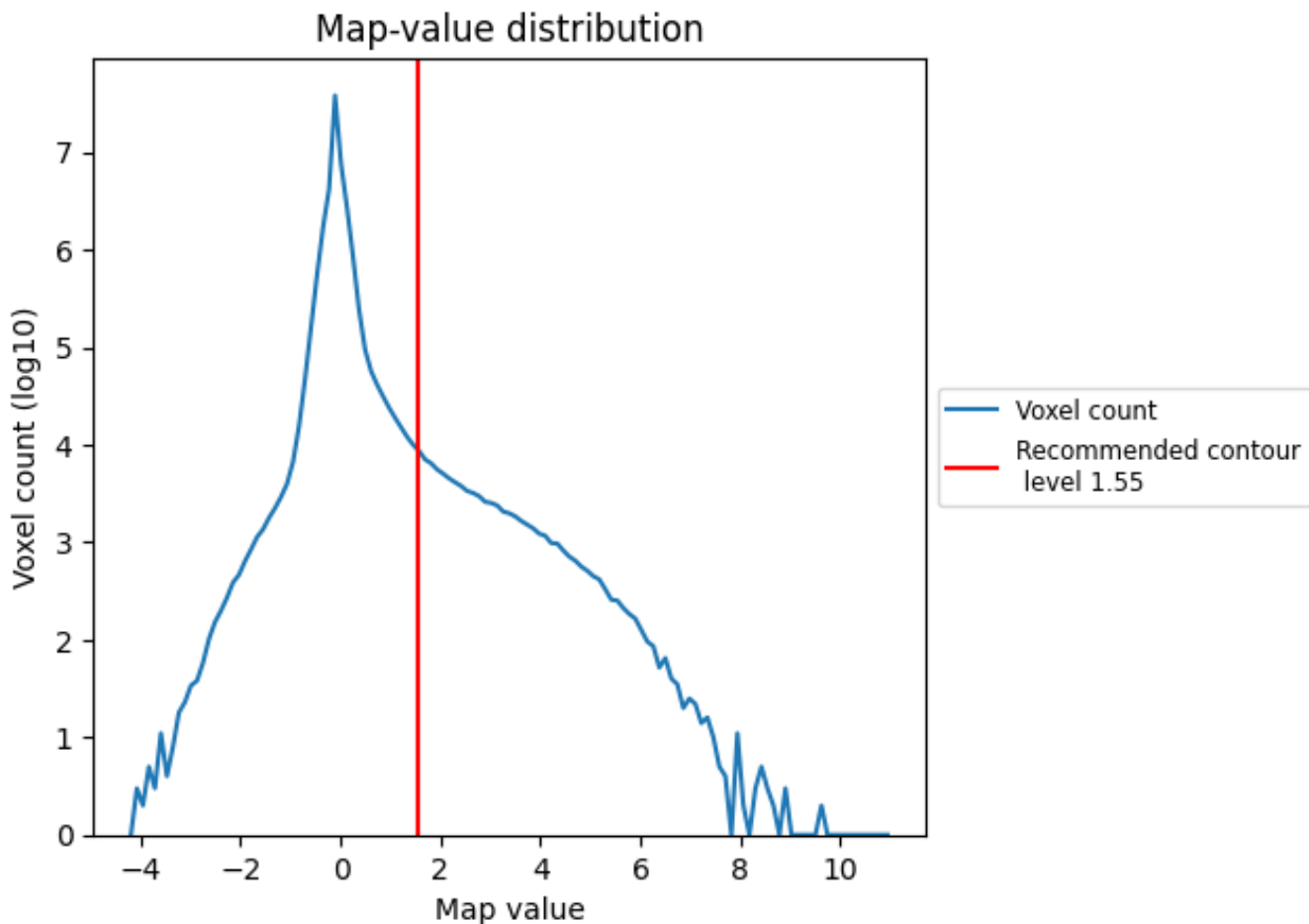

The map-value distribution is plotted in 128 intervals along the x-axis. The y-axis is logarithmic. A spike in this graph at zero usually indicates that the volume has been masked.

7.2 Volume estimate [i](#)

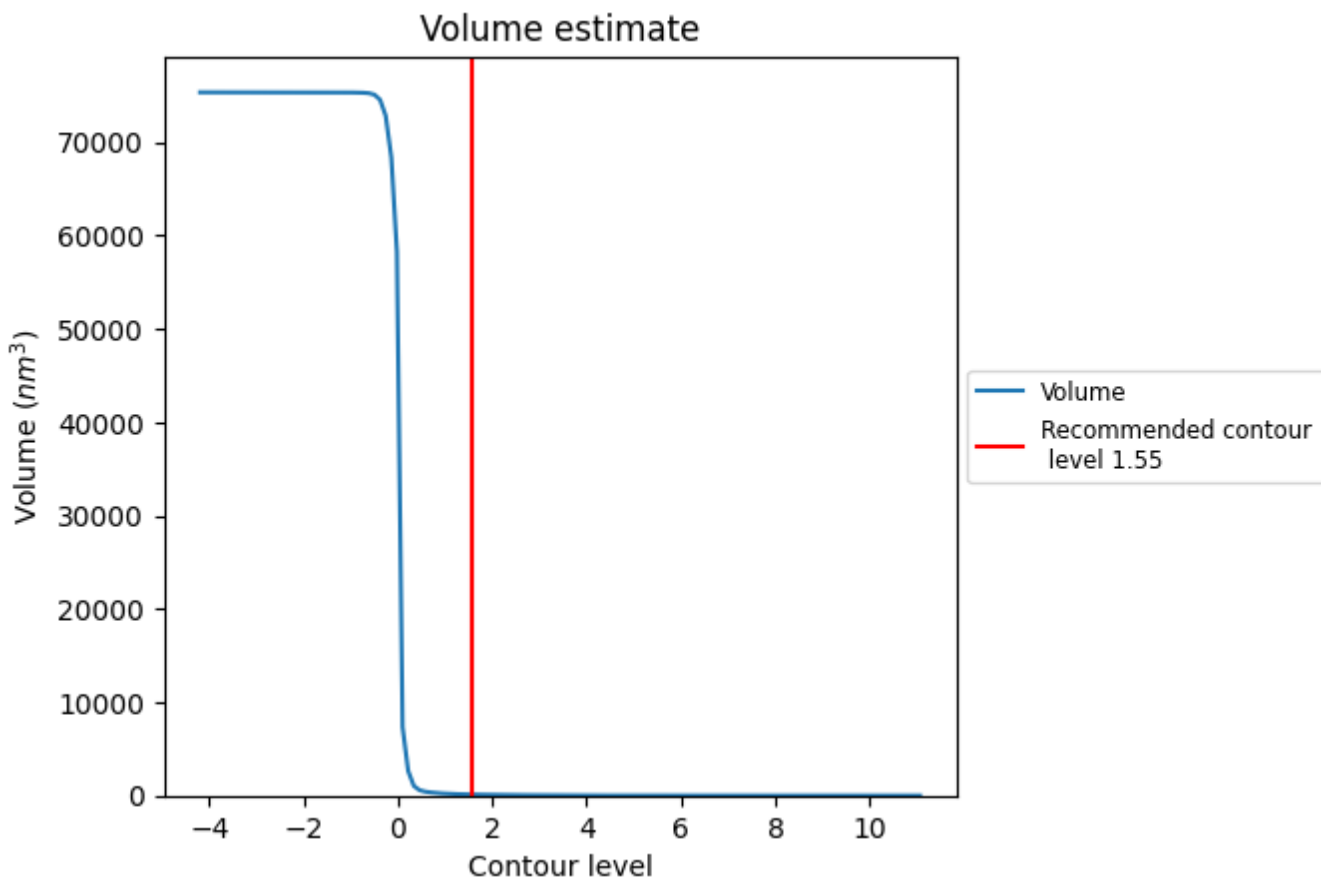

The volume at the recommended contour level is 114 nm³; this corresponds to an approximate mass of 103 kDa.

The volume estimate graph shows how the enclosed volume varies with the contour level. The recommended contour level is shown as a vertical line and the intersection between the line and the curve gives the volume of the enclosed surface at the given level.

7.3 Rotationally averaged power spectrum [i](#)

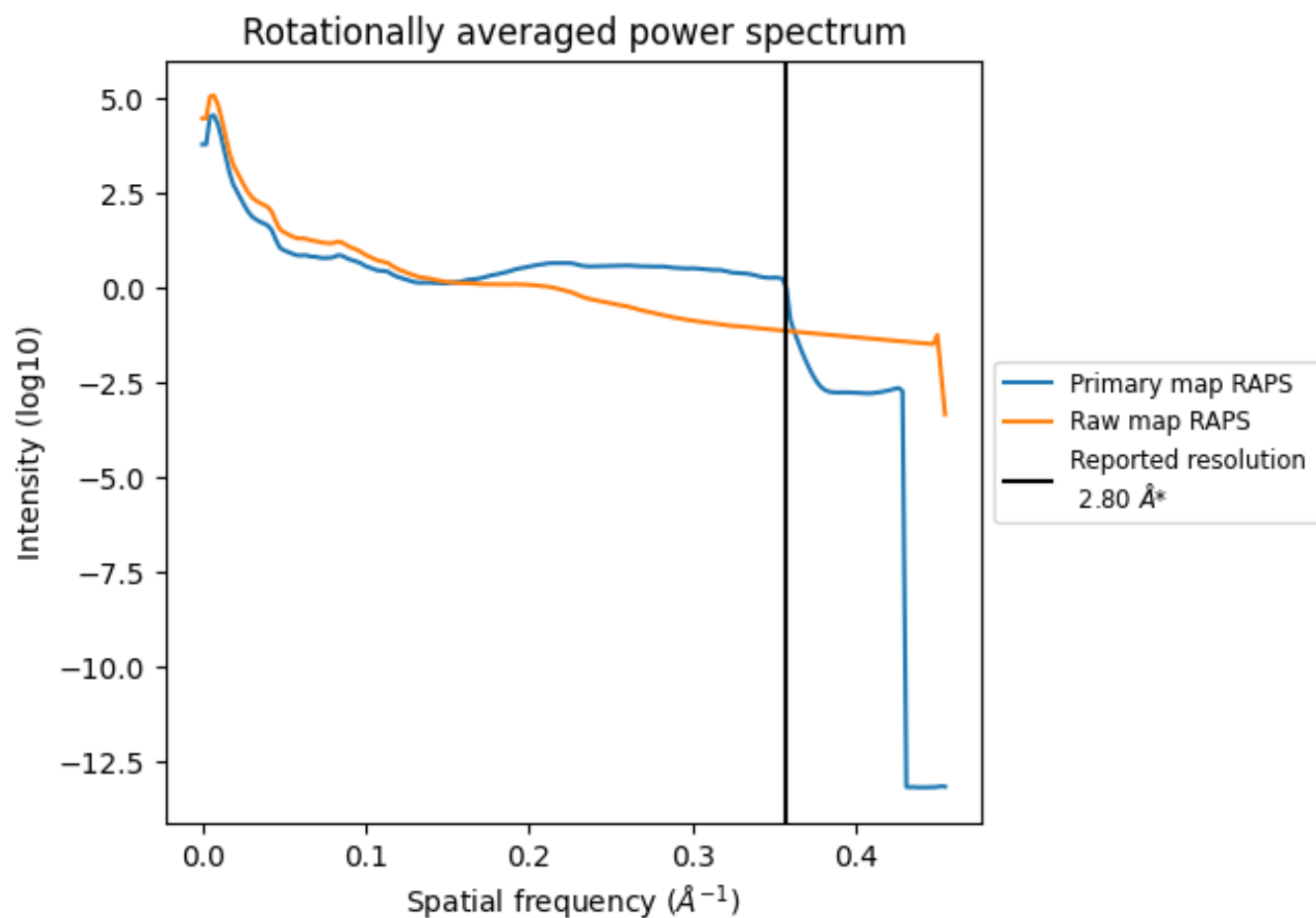

*Reported resolution corresponds to spatial frequency of 0.357 Å⁻¹

8 Fourier-Shell correlation [i](#)

Fourier-Shell Correlation (FSC) is the most commonly used method to estimate the resolution of single-particle and subtomogram-averaged maps. The shape of the curve depends on the imposed symmetry, mask and whether or not the two 3D reconstructions used were processed from a common reference. The reported resolution is shown as a black line. A curve is displayed for the half-bit criterion in addition to lines showing the 0.143 gold standard cut-off and 0.5 cut-off.

8.1 FSC [i](#)

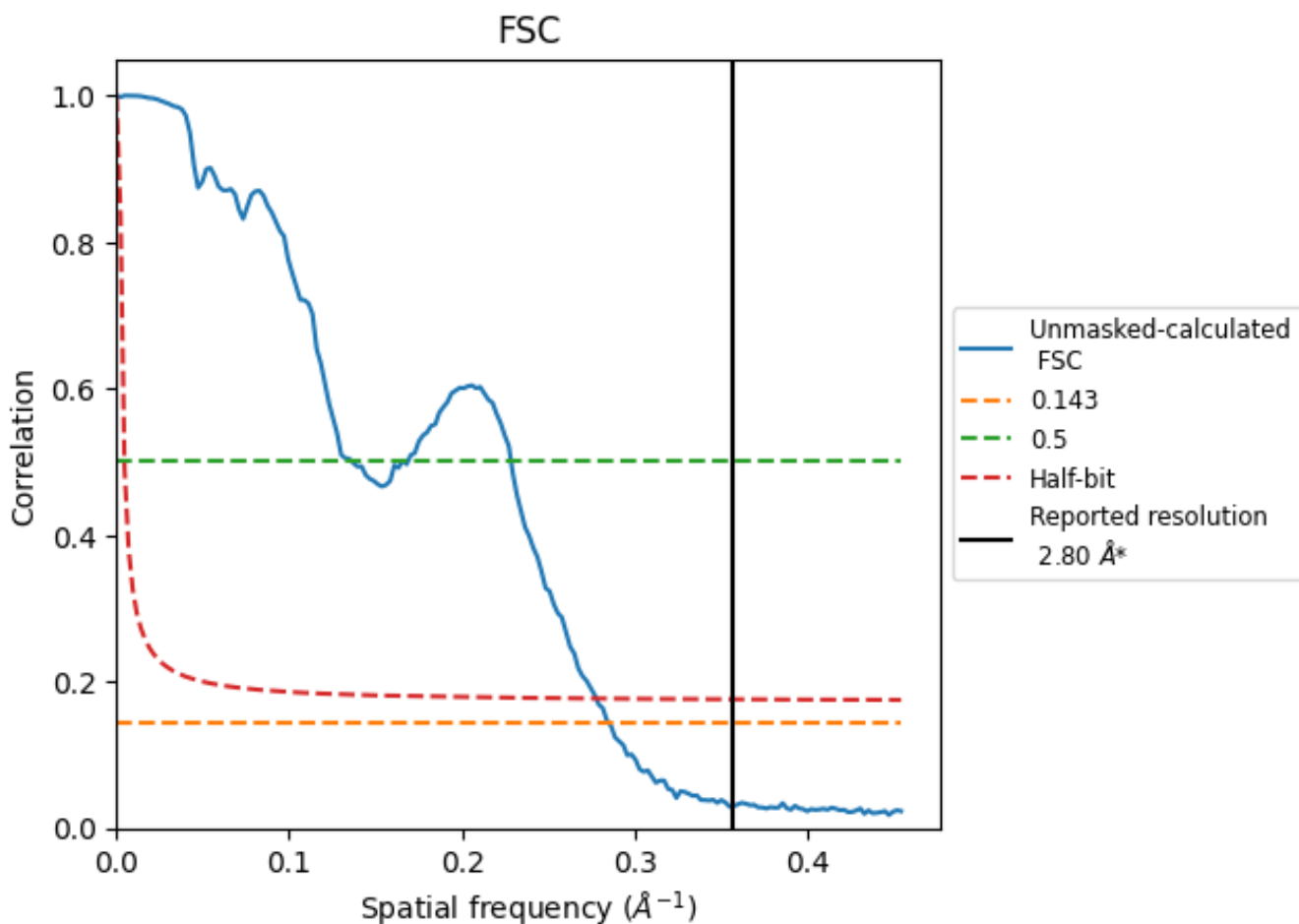

*Reported resolution corresponds to spatial frequency of 0.357 Å⁻¹

8.2 Resolution estimates [i](#)

Resolution estimate (Å)	Estimation criterion (FSC cut-off)		
	0.143	0.5	Half-bit
Reported by author	2.80	-	-
Author-provided FSC curve	-	-	-
Unmasked-calculated*	3.51	7.33	3.60

*Resolution estimate based on FSC curve calculated by comparison of deposited half-maps. The value from deposited half-maps intersecting FSC 0.143 CUT-OFF 3.51 differs from the reported value 2.8 by more than 10 %

9 Map-model fit [i](#)

This section contains information regarding the fit between EMDB map EMD-27403 and PDB model 8DFA. Per-residue inclusion information can be found in section 3 on page 6.

9.1 Map-model overlay [i](#)

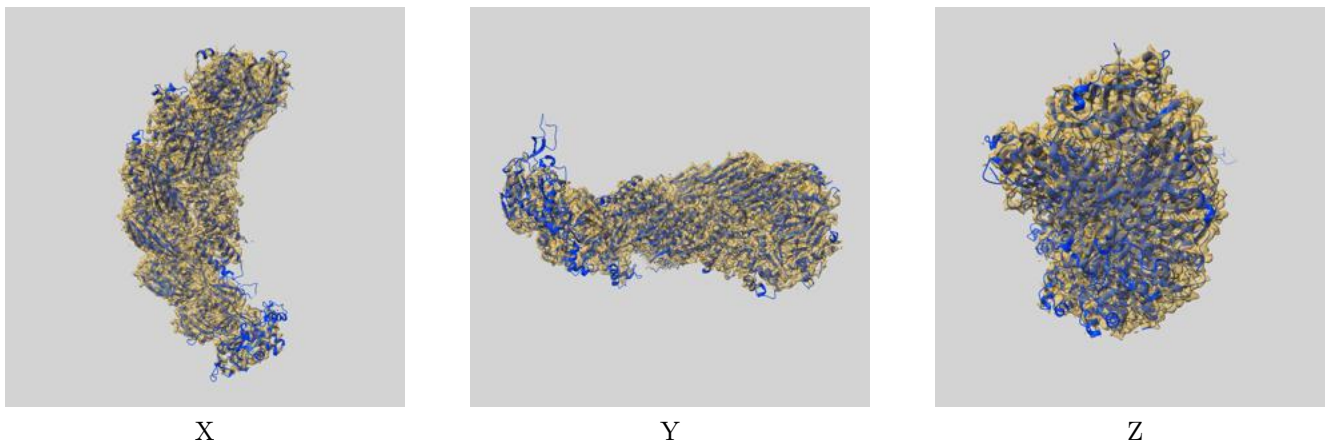

The images above show the 3D surface view of the map at the recommended contour level 1.55 at 50% transparency in yellow overlaid with a ribbon representation of the model coloured in blue. These images allow for the visual assessment of the quality of fit between the atomic model and the map.

9.2 Q-score mapped to coordinate model [i](#)

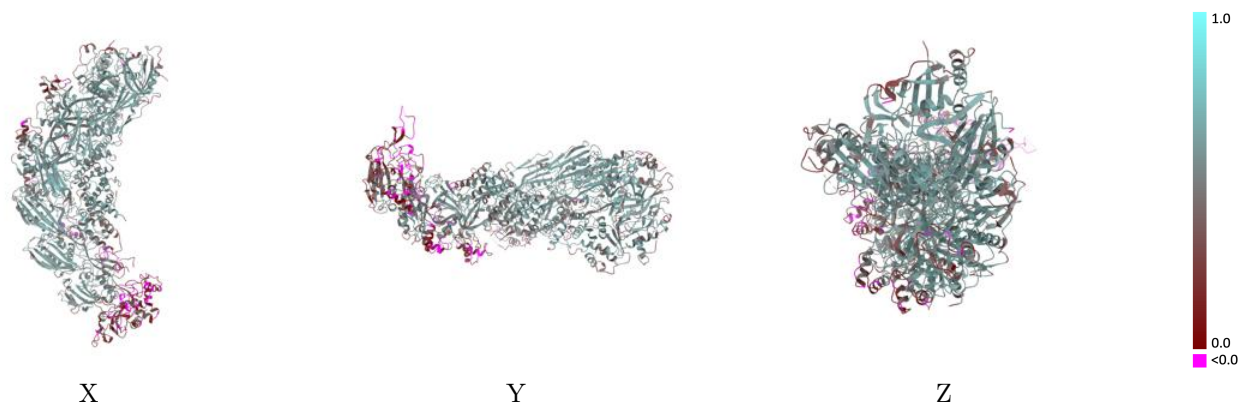

The images above show the model with each residue coloured according to its Q-score. This shows their resolvability in the map with higher Q-score values reflecting better resolvability. Please note: Q-score is calculating the resolvability of atoms, and thus high values are only expected at resolutions at which atoms can be resolved. Low Q-score values may therefore be expected for many entries.

9.3 Atom inclusion mapped to coordinate model [i](#)

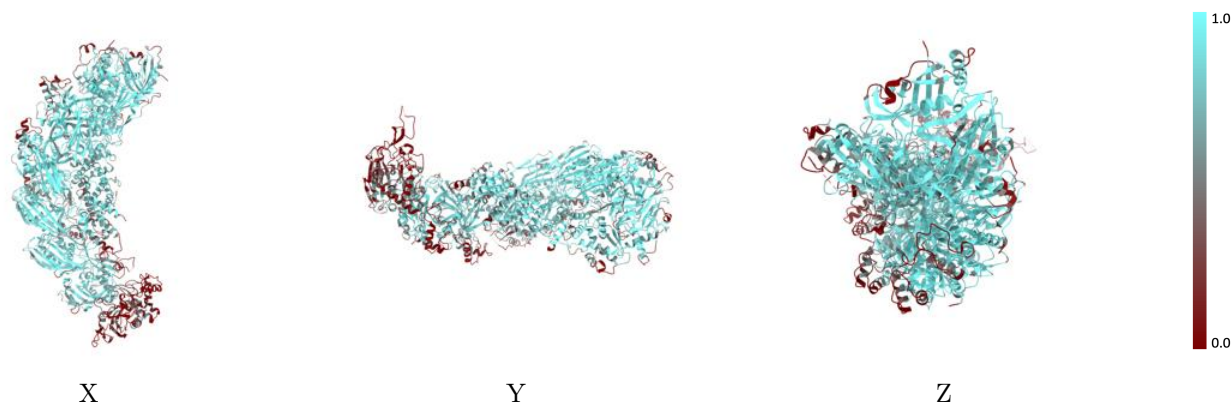

The images above show the model with each residue coloured according to its atom inclusion. This shows to what extent they are inside the map at the recommended contour level (1.55).



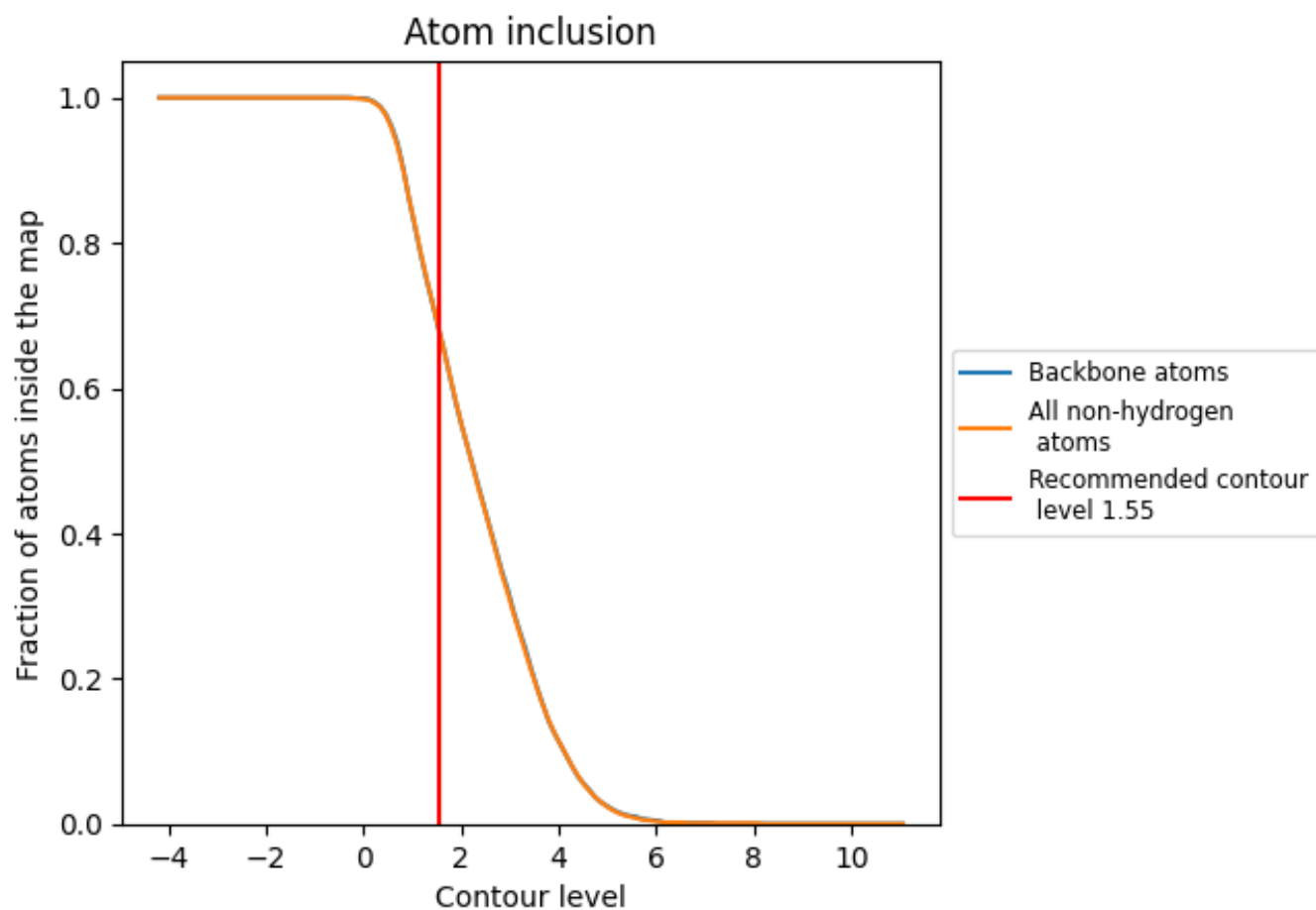

























9.4 Atom inclusion [i](#)



At the recommended contour level, 68% of all backbone atoms, 68% of all non-hydrogen atoms, are inside the map.

9.5 Map-model fit summary

The table lists the average atom inclusion at the recommended contour level (1.55) and Q-score for the entire model and for each chain.

Chain	Atom inclusion	Q-score
All	 0.6790	 0.4800
A	 0.7520	 0.5310
B	 0.8030	 0.5560
C	 0.7740	 0.5360
D	 0.7590	 0.5160
E	 0.7560	 0.5200
F	 0.6920	 0.4610
G	 0.5820	 0.4140
H	 0.2250	 0.2260
I	 0.7120	 0.5170
J	 0.6810	 0.5140
K	 0.6340	 0.4900
L	 0.9000	 0.5570
N	 0.6370	 0.4470

