



Full wwPDB EM Validation Report ⓘ

Mar 28, 2023 – 08:47 PM JST

PDB ID : 7CPJ
EMDB ID : EMD-30431
Title : ycbZ-stalled 70S ribosome
Authors : Yokoyama, T.; Shirouzu, M.; Ito, T.
Deposited on : 2020-08-07
Resolution : 3.30 Å (reported)

This is a Full wwPDB EM Validation Report for a publicly released PDB entry.

We welcome your comments at validation@mail.wwpdb.org

A user guide is available at

<https://www.wwpdb.org/validation/2017/EMValidationReportHelp>

with specific help available everywhere you see the ⓘ symbol.

The types of validation reports are described at

<http://www.wwpdb.org/validation/2017/FAQs#types>.

The following versions of software and data (see [references ⓘ](#)) were used in the production of this report:

EMDB validation analysis : 0.0.1.dev50
Mogul : 1.8.5 (274361), CSD as541be (2020)
MolProbity : 4.02b-467
Percentile statistics : 20191225.v01 (using entries in the PDB archive December 25th 2019)
MapQ : 1.9.9
Ideal geometry (proteins) : Engh & Huber (2001)
Ideal geometry (DNA, RNA) : Parkinson et al. (1996)
Validation Pipeline (wwPDB-VP) : 2.32.2

1 Overall quality at a glance

The following experimental techniques were used to determine the structure:
ELECTRON MICROSCOPY

The reported resolution of this entry is 3.30 Å.

Percentile scores (ranging between 0-100) for global validation metrics of the entry are shown in the following graphic. The table shows the number of entries on which the scores are based.

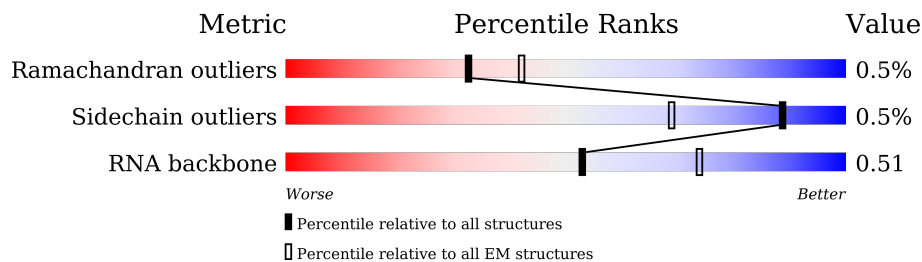

Metric	Whole archive (#Entries)	EM structures (#Entries)
Ramachandran outliers	154571	4023
Sidechain outliers	154315	3826
RNA backbone	4643	859

The table below summarises the geometric issues observed across the polymeric chains and their fit to the map. The red, orange, yellow and green segments of the bar indicate the fraction of residues that contain outliers for ≥ 3 , 2, 1 and 0 types of geometric quality criteria respectively. A grey segment represents the fraction of residues that are not modelled. The numeric value for each fraction is indicated below the corresponding segment, with a dot representing fractions $\leq 5\%$. The upper red bar (where present) indicates the fraction of residues that have poor fit to the EM map (all-atom inclusion $< 40\%$). The numeric value is given above the bar.

Mol	Chain	Length	Quality of chain
1	a	1539	
2	b	240	
3	c	233	
4	d	206	
5	e	167	
6	f	135	
7	g	179	
8	h	130	

Continued on next page...

Continued from previous page...

Mol	Chain	Length	Quality of chain
9	i	130	35% 96%
10	j	103	49% 93% 5%
11	k	129	26% 89% 10%
12	l	124	19% 96%
13	m	118	46% 95%
14	n	102	35% 99%
15	o	89	17% 98%
16	p	82	17% 99%
17	q	84	21% 90% 5%
18	r	75	31% 87% 13%
19	s	92	34% 86% 14%
20	t	87	14% 98%
21	u	71	92% 86% 6% 8%
22	A	2903	9% 78% 21%
23	B	120	5% 79% 20%
24	C	273	7% 99%
25	D	209	6% 100%
26	E	201	15% 99%
27	F	179	36% 97%
28	G	177	29% 98%
29	H	149	84% 99%
30	I	142	99% 98%
31	J	142	6% 99%
32	K	123	14% 98%
33	L	144	9% 99%

Continued on next page...

Continued from previous page...

Mol	Chain	Length	Quality of chain
34	M	136	8% 99%
35	N	127	5% 94% 6%
36	O	117	12% 98%
37	P	115	13% 99%
38	Q	118	99%
39	R	103	11% 98%
40	S	110	12% 98%
41	T	100	19% 93% 7%
42	U	104	20% 93% 5%
43	V	94	15% 100%
44	W	85	9% 88% 12%
45	X	78	14% 99%
46	Y	63	27% 98%
47	Z	59	8% 98%
48	0	57	14% 98%
49	1	55	91% 91% 9%
50	2	46	7% 100%
51	3	65	6% 94% 5%
52	4	38	11% 100%
53	5	165	79% 79% 21%
54	6	70	87% 91% 6%
55	9	77	42% 60% 38%
56	x	3	100%

2 Entry composition [i](#)

There are 58 unique types of molecules in this entry. The entry contains 145941 atoms, of which 0 are hydrogens and 0 are deuteriums.

In the tables below, the AltConf column contains the number of residues with at least one atom in alternate conformation and the Trace column contains the number of residues modelled with at most 2 atoms.

- Molecule 1 is a RNA chain called 16S ribosomal RNA.

Mol	Chain	Residues	Atoms					AltConf	Trace
			Total	C	N	O	P		
1	a	1539	33030	14739	6052	10700	1539	0	0

- Molecule 2 is a protein called 30S ribosomal protein S2.

Mol	Chain	Residues	Atoms					AltConf	Trace
			Total	C	N	O	S		
2	b	218	1704	1081	305	311	7	0	0

- Molecule 3 is a protein called 30S ribosomal protein S3.

Mol	Chain	Residues	Atoms					AltConf	Trace
			Total	C	N	O	S		
3	c	206	1624	1028	305	288	3	0	0

- Molecule 4 is a protein called 30S ribosomal protein S4.

Mol	Chain	Residues	Atoms					AltConf	Trace
			Total	C	N	O	S		
4	d	205	1643	1026	315	298	4	0	0

- Molecule 5 is a protein called 30S ribosomal protein S5.

Mol	Chain	Residues	Atoms					AltConf	Trace
			Total	C	N	O	S		
5	e	157	1141	709	218	208	6	0	0

- Molecule 6 is a protein called 30S ribosomal protein S6.

Mol	Chain	Residues	Atoms					AltConf	Trace
			Total	C	N	O	S		
6	f	100	817	515	148	148	6	0	0

- Molecule 7 is a protein called 30S ribosomal protein S7.

Mol	Chain	Residues	Atoms					AltConf	Trace
			Total	C	N	O	S		
7	g	151	1181	735	227	215	4	0	0

- Molecule 8 is a protein called 30S ribosomal protein S8.

Mol	Chain	Residues	Atoms					AltConf	Trace
			Total	C	N	O	S		
8	h	129	979	616	173	184	6	0	0

- Molecule 9 is a protein called 30S ribosomal protein S9.

Mol	Chain	Residues	Atoms					AltConf	Trace
			Total	C	N	O	S		
9	i	127	1022	634	206	179	3	0	0

- Molecule 10 is a protein called 30S ribosomal protein S10.

Mol	Chain	Residues	Atoms					AltConf	Trace
			Total	C	N	O	S		
10	j	98	786	493	150	142	1	0	0

- Molecule 11 is a protein called 30S ribosomal protein S11.

Mol	Chain	Residues	Atoms					AltConf	Trace
			Total	C	N	O	S		
11	k	116	869	535	173	158	3	0	0

- Molecule 12 is a protein called 30S ribosomal protein S12.

Mol	Chain	Residues	Atoms					AltConf	Trace
			Total	C	N	O	S		
12	l	123	955	590	196	165	4	0	0

- Molecule 13 is a protein called 30S ribosomal protein S13.

Mol	Chain	Residues	Atoms					AltConf	Trace
			Total	C	N	O	S		
13	m	114	883	546	178	156	3	0	0

- Molecule 14 is a protein called 30S ribosomal protein S14.

Mol	Chain	Residues	Atoms					AltConf	Trace
14	n	101	Total	C	N	O	S	0	0
			799	498	165	133	3		

- Molecule 15 is a protein called 30S ribosomal protein S15.

Mol	Chain	Residues	Atoms					AltConf	Trace
15	o	88	Total	C	N	O	S	0	0
			714	439	144	130	1		

- Molecule 16 is a protein called 30S ribosomal protein S16.

Mol	Chain	Residues	Atoms					AltConf	Trace
16	p	82	Total	C	N	O	S	0	0
			649	406	128	114	1		

- Molecule 17 is a protein called 30S ribosomal protein S17.

Mol	Chain	Residues	Atoms					AltConf	Trace
17	q	80	Total	C	N	O	S	0	0
			648	411	121	113	3		

- Molecule 18 is a protein called 30S ribosomal protein S18.

Mol	Chain	Residues	Atoms				AltConf	Trace
18	r	65	Total	C	N	O	0	0
			504	317	96	91		

- Molecule 19 is a protein called 30S ribosomal protein S19.

Mol	Chain	Residues	Atoms					AltConf	Trace
19	s	79	Total	C	N	O	S	0	0
			637	408	120	107	2		

- Molecule 20 is a protein called 30S ribosomal protein S20.

Mol	Chain	Residues	Atoms					AltConf	Trace
20	t	85	Total	C	N	O	S	0	0
			665	411	137	114	3		

- Molecule 21 is a protein called 30S ribosomal protein S21.

Mol	Chain	Residues	Atoms					AltConf	Trace
21	u	65	Total	C	N	O	S	0	0
			495	307	100	87	1		

- Molecule 22 is a RNA chain called 23S ribosomal RNA.

Mol	Chain	Residues	Atoms					AltConf	Trace
22	A	2900	Total	C	N	O	P	0	0
			62276	27788	11460	20128	2900		

- Molecule 23 is a RNA chain called 5S ribosomal RNA.

Mol	Chain	Residues	Atoms					AltConf	Trace
23	B	120	Total	C	N	O	P	0	0
			2572	1145	471	836	120		

- Molecule 24 is a protein called 50S ribosomal protein L2.

Mol	Chain	Residues	Atoms					AltConf	Trace
24	C	271	Total	C	N	O	S	0	0
			2082	1288	423	364	7		

- Molecule 25 is a protein called 50S ribosomal protein L3.

Mol	Chain	Residues	Atoms					AltConf	Trace
25	D	209	Total	C	N	O	S	0	0
			1565	979	288	294	4		

- Molecule 26 is a protein called 50S ribosomal protein L4.

Mol	Chain	Residues	Atoms					AltConf	Trace
26	E	201	Total	C	N	O	S	0	0
			1552	974	283	290	5		

- Molecule 27 is a protein called 50S ribosomal protein L5.

Mol	Chain	Residues	Atoms					AltConf	Trace
27	F	177	Total	C	N	O	S	0	0
			1410	899	249	256	6		

- Molecule 28 is a protein called 50S ribosomal protein L6.

Mol	Chain	Residues	Atoms					AltConf	Trace
			Total	C	N	O	S		
28	G	176	1323	832	243	246	2	0	0

- Molecule 29 is a protein called 50S ribosomal protein L9.

Mol	Chain	Residues	Atoms					AltConf	Trace
			Total	C	N	O	S		
29	H	149	1111	699	197	214	1	0	0

- Molecule 30 is a protein called 50S ribosomal protein L11.

Mol	Chain	Residues	Atoms					AltConf	Trace
			Total	C	N	O	S		
30	I	141	1032	651	179	196	6	0	0

- Molecule 31 is a protein called 50S ribosomal protein L13.

Mol	Chain	Residues	Atoms					AltConf	Trace
			Total	C	N	O	S		
31	J	142	1129	714	212	199	4	0	0

- Molecule 32 is a protein called 50S ribosomal protein L14.

Mol	Chain	Residues	Atoms					AltConf	Trace
			Total	C	N	O	S		
32	K	122	938	587	180	165	6	0	0

- Molecule 33 is a protein called 50S ribosomal protein L15.

Mol	Chain	Residues	Atoms					AltConf	Trace
			Total	C	N	O	S		
33	L	143	1045	649	206	189	1	0	0

- Molecule 34 is a protein called 50S ribosomal protein L16.

Mol	Chain	Residues	Atoms					AltConf	Trace
			Total	C	N	O	S		
34	M	136	1074	686	205	177	6	0	0

- Molecule 35 is a protein called 50S ribosomal protein L17.

Mol	Chain	Residues	Atoms					AltConf	Trace
			Total	C	N	O	S		
35	N	120	960	593	196	166	5	0	0

- Molecule 36 is a protein called 50S ribosomal protein L18.

Mol	Chain	Residues	Atoms					AltConf	Trace
			Total	C	N	O	S		
36	O	116	892	552	178	162		0	0

- Molecule 37 is a protein called 50S ribosomal protein L19.

Mol	Chain	Residues	Atoms					AltConf	Trace
			Total	C	N	O	S		
37	P	114	917	574	179	163	1	0	0

- Molecule 38 is a protein called 50S ribosomal protein L20.

Mol	Chain	Residues	Atoms					AltConf	Trace
			Total	C	N	O	S		
38	Q	117	947	604	192	151		0	0

- Molecule 39 is a protein called 50S ribosomal protein L21.

Mol	Chain	Residues	Atoms					AltConf	Trace
			Total	C	N	O	S		
39	R	103	816	516	153	145	2	0	0

- Molecule 40 is a protein called 50S ribosomal protein L22.

Mol	Chain	Residues	Atoms					AltConf	Trace
			Total	C	N	O	S		
40	S	110	857	532	166	156	3	0	0

- Molecule 41 is a protein called 50S ribosomal protein L23.

Mol	Chain	Residues	Atoms					AltConf	Trace
			Total	C	N	O	S		
41	T	93	738	466	139	131	2	0	0

- Molecule 42 is a protein called 50S ribosomal protein L24.

Mol	Chain	Residues	Atoms				AltConf	Trace
42	U	102	Total	C	N	O		
			779	492	146	141	0	0

- Molecule 43 is a protein called 50S ribosomal protein L25.

Mol	Chain	Residues	Atoms					AltConf	Trace
43	V	94	Total	C	N	O	S		
			753	479	137	134	3	0	0

- Molecule 44 is a protein called 50S ribosomal protein L27.

Mol	Chain	Residues	Atoms					AltConf	Trace
44	W	75	Total	C	N	O	S		
			575	356	116	102	1	0	0

- Molecule 45 is a protein called 50S ribosomal protein L28.

Mol	Chain	Residues	Atoms					AltConf	Trace
45	X	77	Total	C	N	O	S		
			625	388	129	106	2	0	0

- Molecule 46 is a protein called 50S ribosomal protein L29.

Mol	Chain	Residues	Atoms					AltConf	Trace
46	Y	63	Total	C	N	O	S		
			509	313	99	95	2	0	0

- Molecule 47 is a protein called 50S ribosomal protein L30.

Mol	Chain	Residues	Atoms					AltConf	Trace
47	Z	58	Total	C	N	O	S		
			449	281	87	79	2	0	0

- Molecule 48 is a protein called 50S ribosomal protein L32.

Mol	Chain	Residues	Atoms					AltConf	Trace
48	0	56	Total	C	N	O	S		
			444	269	94	80	1	0	0

- Molecule 49 is a protein called 50S ribosomal protein L33.

Mol	Chain	Residues	Atoms				AltConf	Trace
49	1	50	Total	C	N	O	0	0
			409	263	75	71		

- Molecule 50 is a protein called 50S ribosomal protein L34.

Mol	Chain	Residues	Atoms					AltConf	Trace
50	2	46	Total	C	N	O	S	0	0
			377	228	90	57	2		

- Molecule 51 is a protein called 50S ribosomal protein L35.

Mol	Chain	Residues	Atoms					AltConf	Trace
51	3	64	Total	C	N	O	S	0	0
			504	323	105	74	2		

- Molecule 52 is a protein called 50S ribosomal protein L36.

Mol	Chain	Residues	Atoms					AltConf	Trace
52	4	38	Total	C	N	O	S	0	0
			302	185	65	48	4		

- Molecule 53 is a protein called 50S ribosomal protein L10.

Mol	Chain	Residues	Atoms					AltConf	Trace
53	5	131	Total	C	N	O	S	0	0
			988	625	175	183	5		

- Molecule 54 is a protein called 50S ribosomal protein L31.

Mol	Chain	Residues	Atoms					AltConf	Trace
54	6	66	Total	C	N	O	S	0	0
			522	323	99	94	6		

- Molecule 55 is a RNA chain called P/P tRNA.

Mol	Chain	Residues	Atoms					AltConf	Trace
55	9	77	Total	C	N	O	P	0	0
			1646	733	295	541	77		

- Molecule 56 is a RNA chain called mRNA.

Mol	Chain	Residues	Atoms				AltConf	Trace	
			Total	C	N	O			P
56	x	3	63	28	11	21	3	0	0

- Molecule 57 is ISOLEUCINE (three-letter code: ILE) (formula: $C_6H_{13}NO_2$).

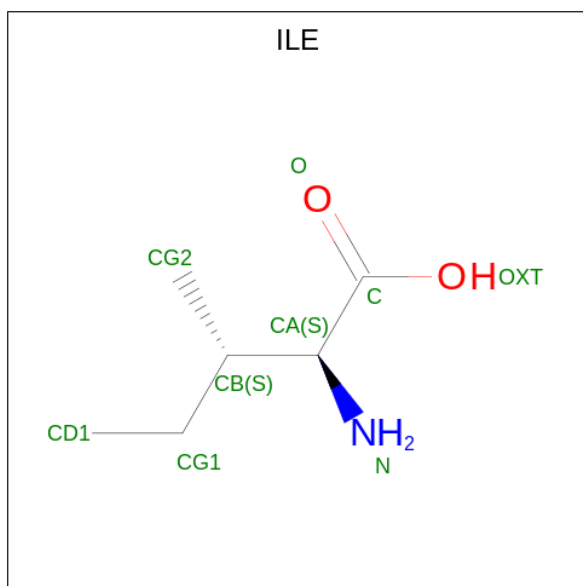

Mol	Chain	Residues	Atoms				AltConf
			Total	C	N	O	
57	A	1	8	6	1	1	0

- Molecule 58 is PROLINE (three-letter code: PRO) (formula: $C_5H_9NO_2$).

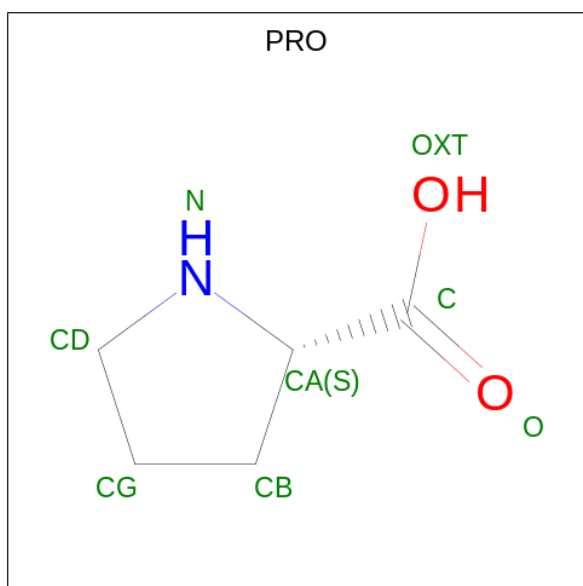

Mol	Chain	Residues	Atoms				AltConf
			Total	C	N	O	
58	9	1	7	5	1	1	0

3 Residue-property plots

These plots are drawn for all protein, RNA, DNA and oligosaccharide chains in the entry. The first graphic for a chain summarises the proportions of the various outlier classes displayed in the second graphic. The second graphic shows the sequence view annotated by issues in geometry and atom inclusion in map density. Residues are color-coded according to the number of geometric quality criteria for which they contain at least one outlier: green = 0, yellow = 1, orange = 2 and red = 3 or more. A red diamond above a residue indicates a poor fit to the EM map for this residue (all-atom inclusion < 40%). Stretches of 2 or more consecutive residues without any outlier are shown as a green connector. Residues present in the sample, but not in the model, are shown in grey.

- Molecule 1: 16S ribosomal RNA

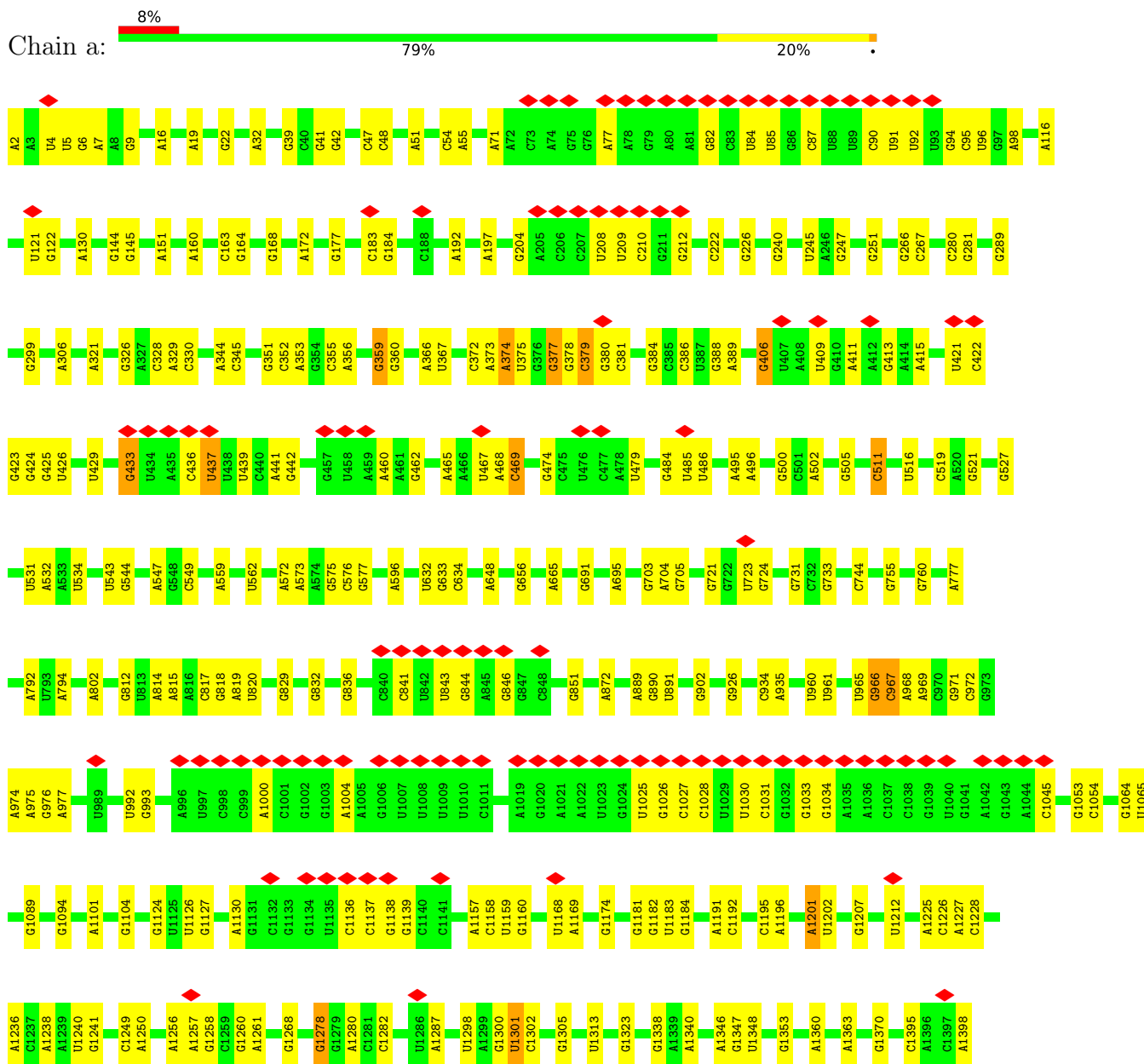

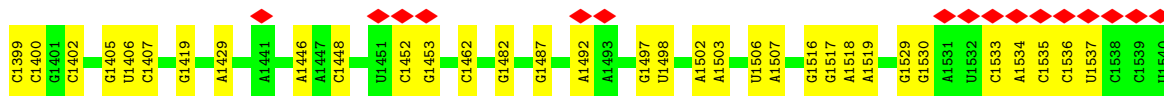

• Molecule 2: 30S ribosomal protein S2

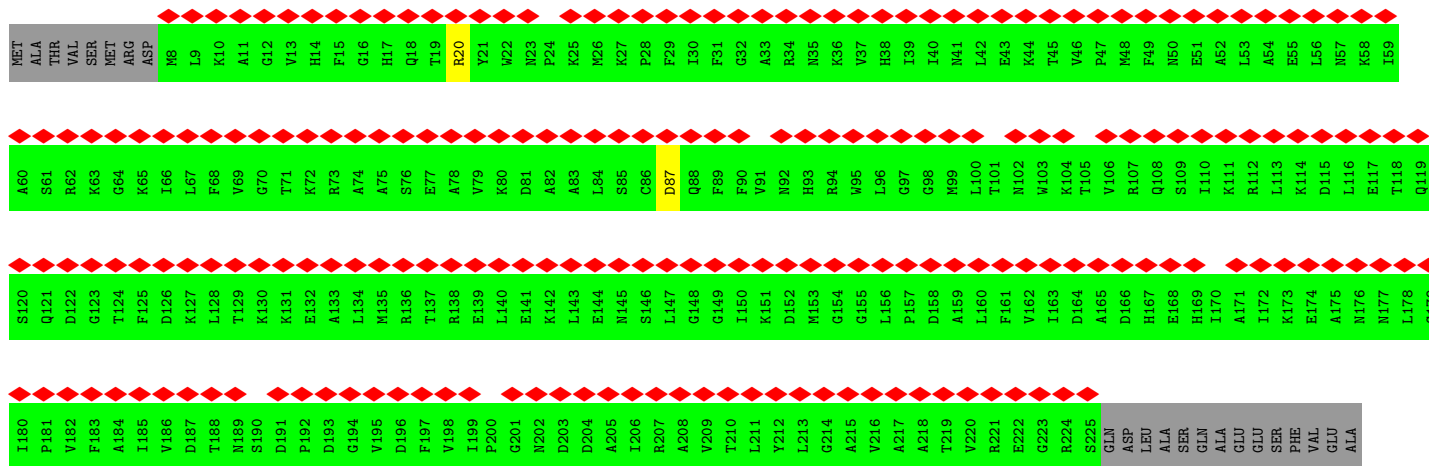
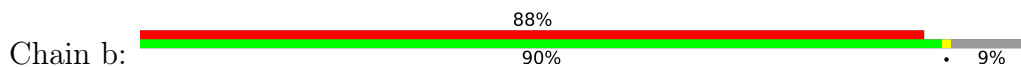

• Molecule 3: 30S ribosomal protein S3

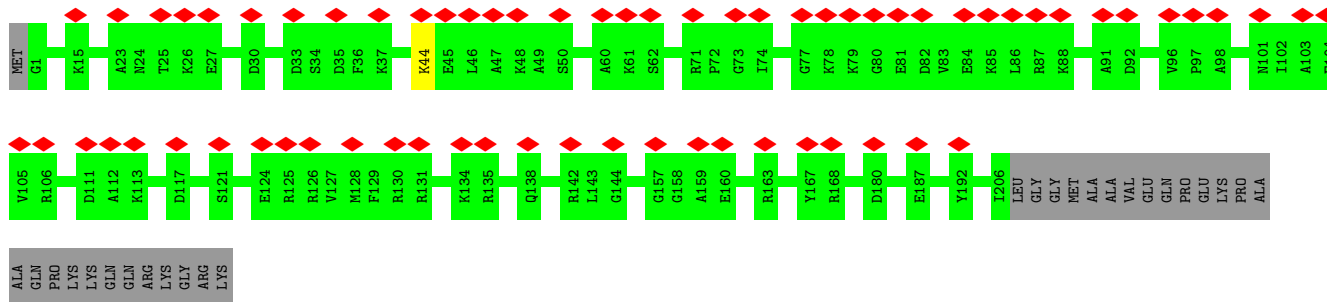
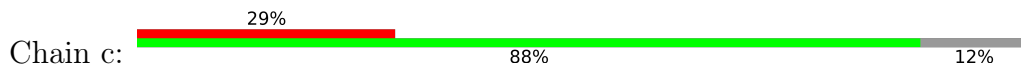

• Molecule 4: 30S ribosomal protein S4

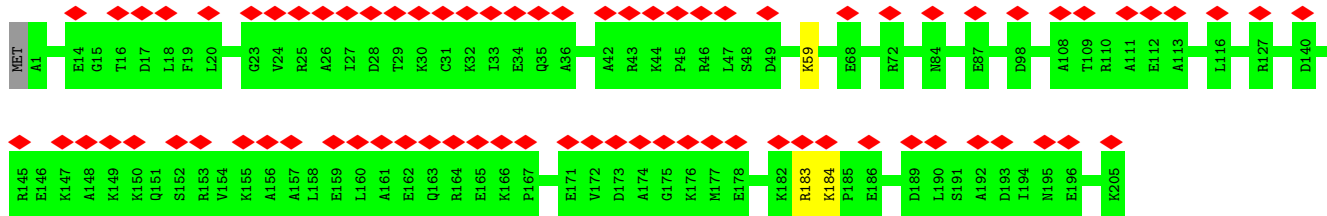

• Molecule 5: 30S ribosomal protein S5

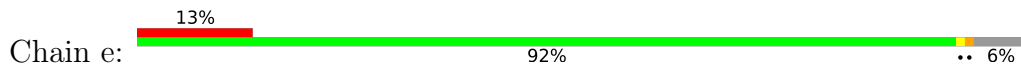

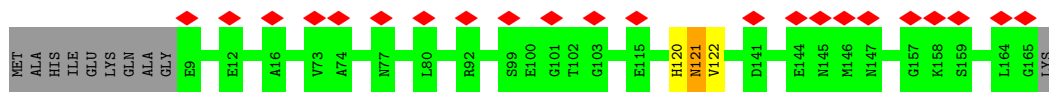

• Molecule 6: 30S ribosomal protein S6

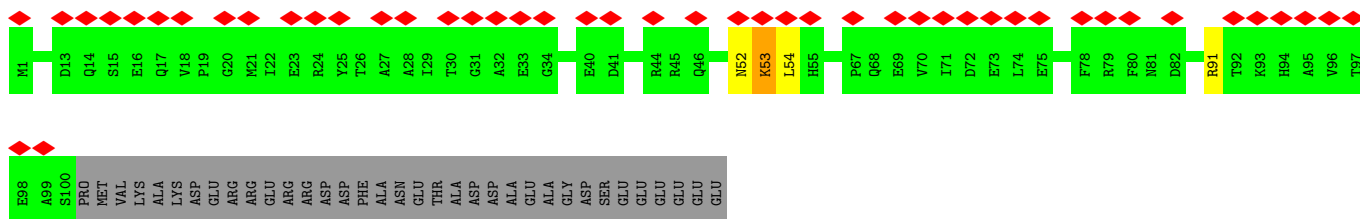

• Molecule 7: 30S ribosomal protein S7

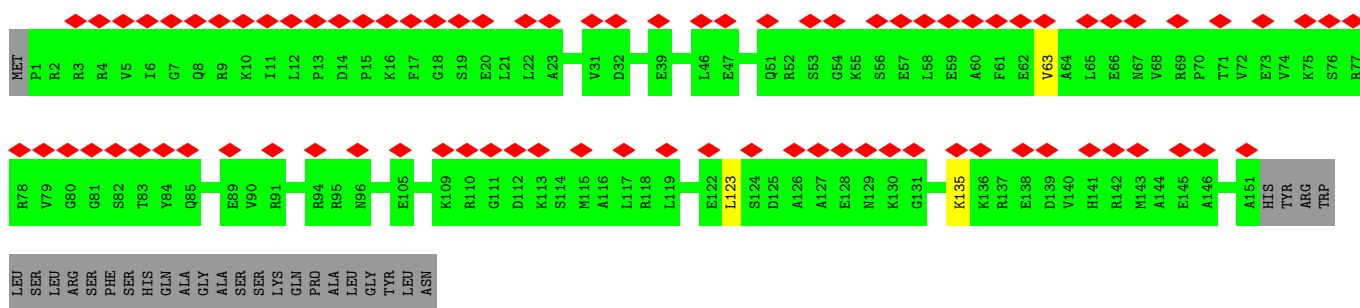
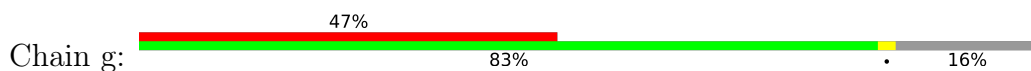

• Molecule 8: 30S ribosomal protein S8

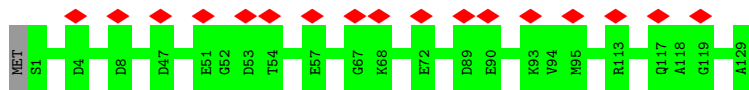

• Molecule 9: 30S ribosomal protein S9

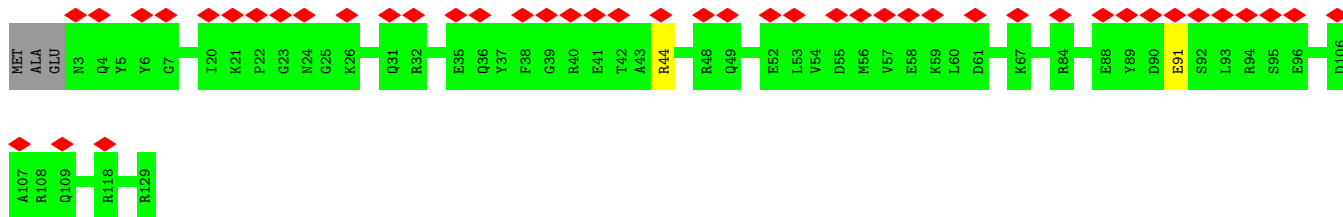

• Molecule 10: 30S ribosomal protein S10

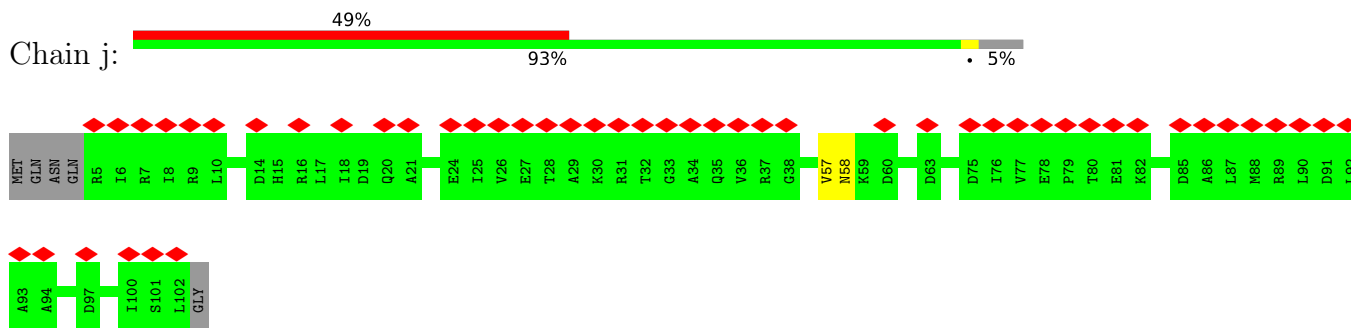

• Molecule 11: 30S ribosomal protein S11

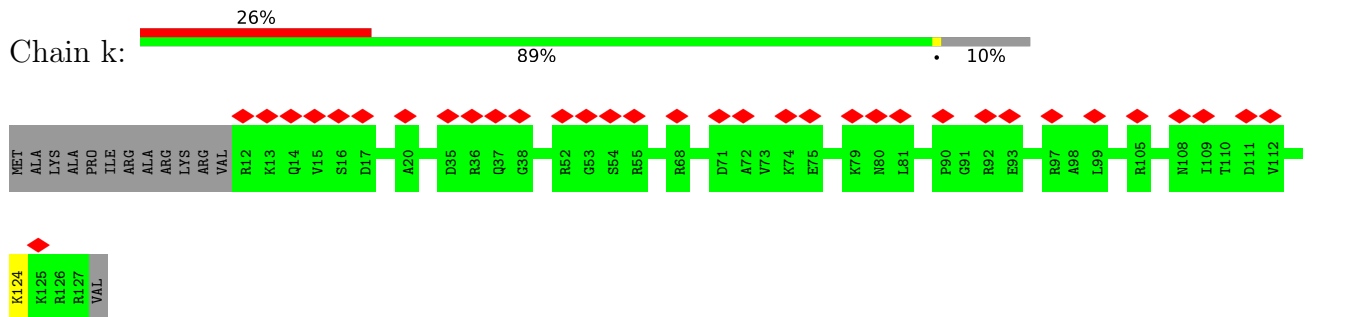

• Molecule 12: 30S ribosomal protein S12

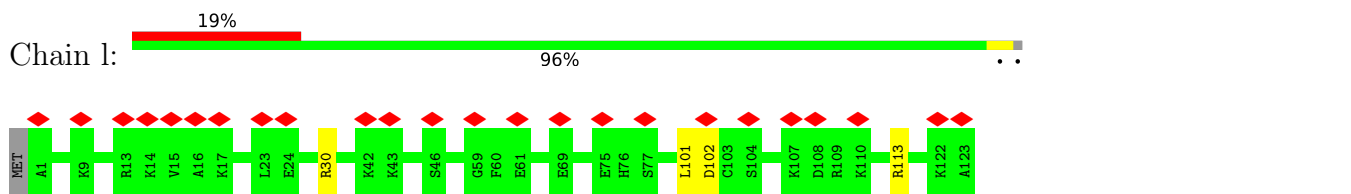

• Molecule 13: 30S ribosomal protein S13

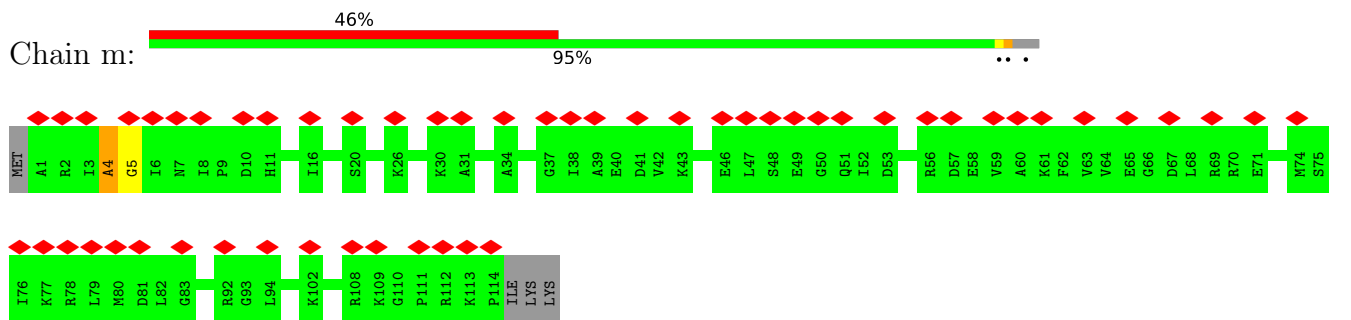

• Molecule 14: 30S ribosomal protein S14

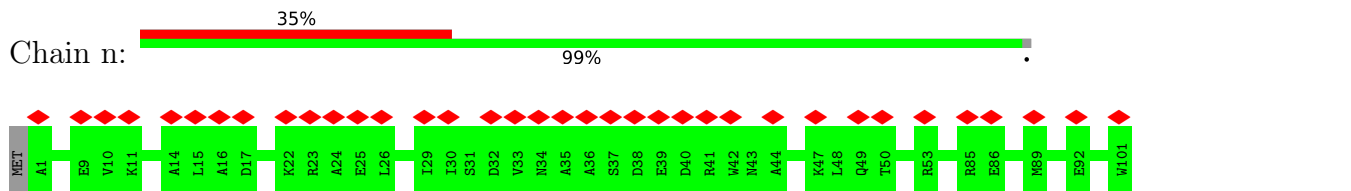

• Molecule 15: 30S ribosomal protein S15



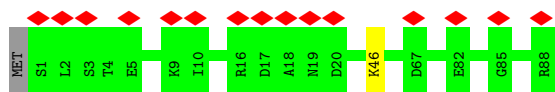

- Molecule 16: 30S ribosomal protein S16

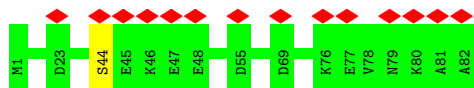

- Molecule 17: 30S ribosomal protein S17

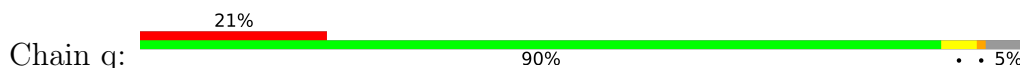

- Molecule 18: 30S ribosomal protein S18

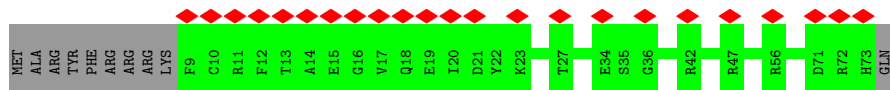
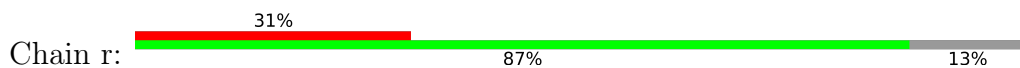

- Molecule 19: 30S ribosomal protein S19

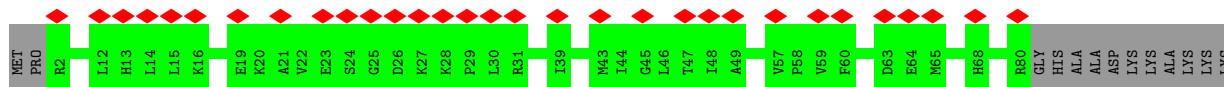
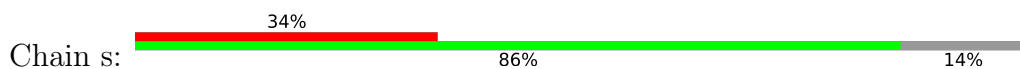

- Molecule 20: 30S ribosomal protein S20

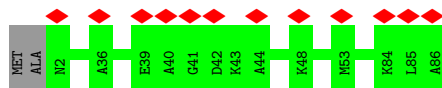

- Molecule 21: 30S ribosomal protein S21

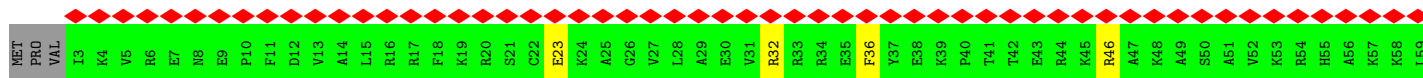
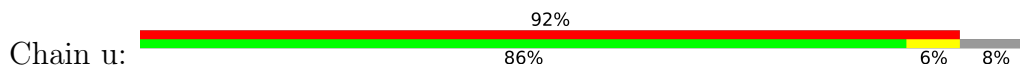

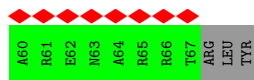

• Molecule 22: 23S ribosomal RNA

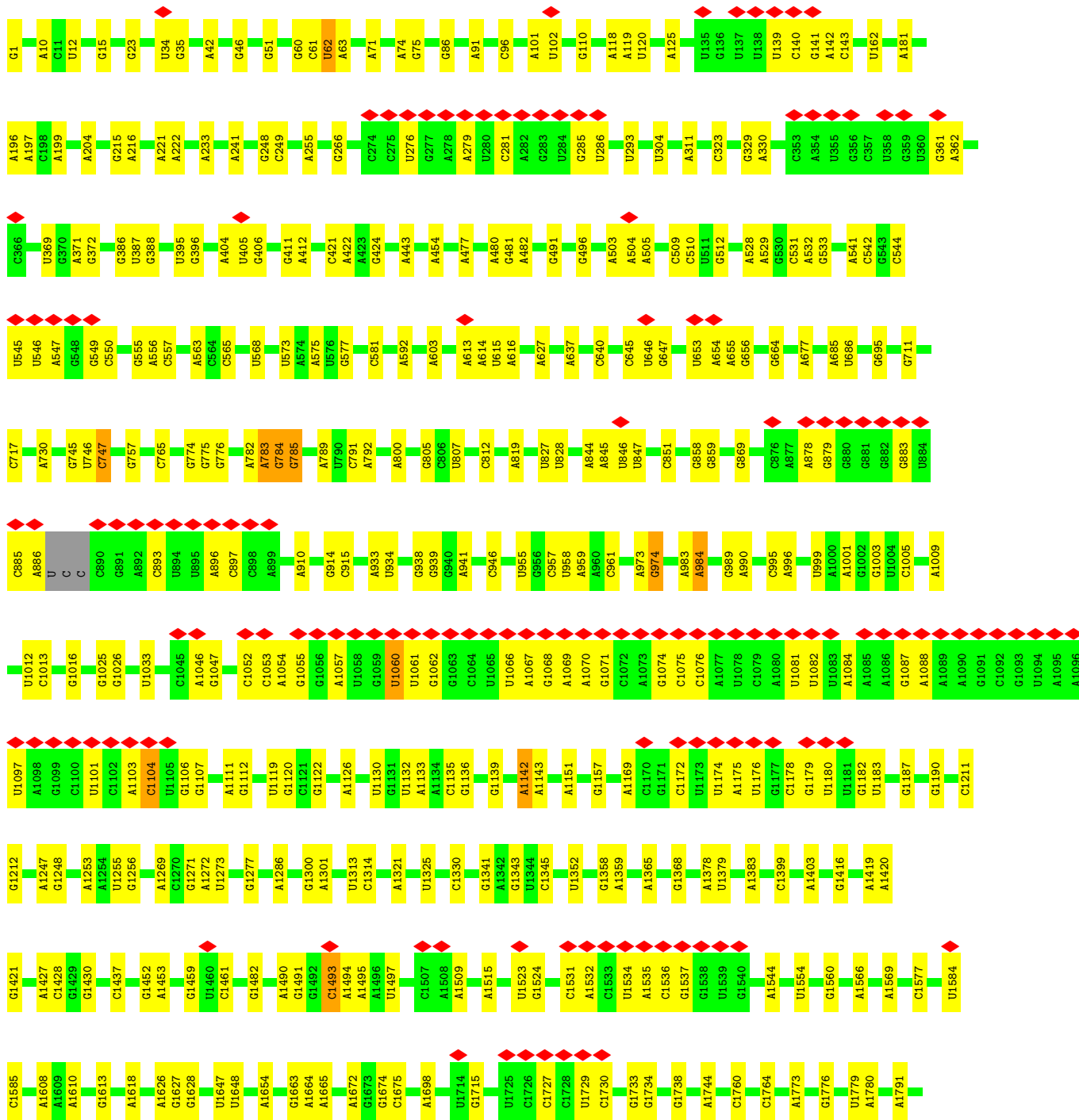
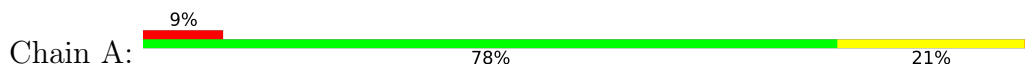

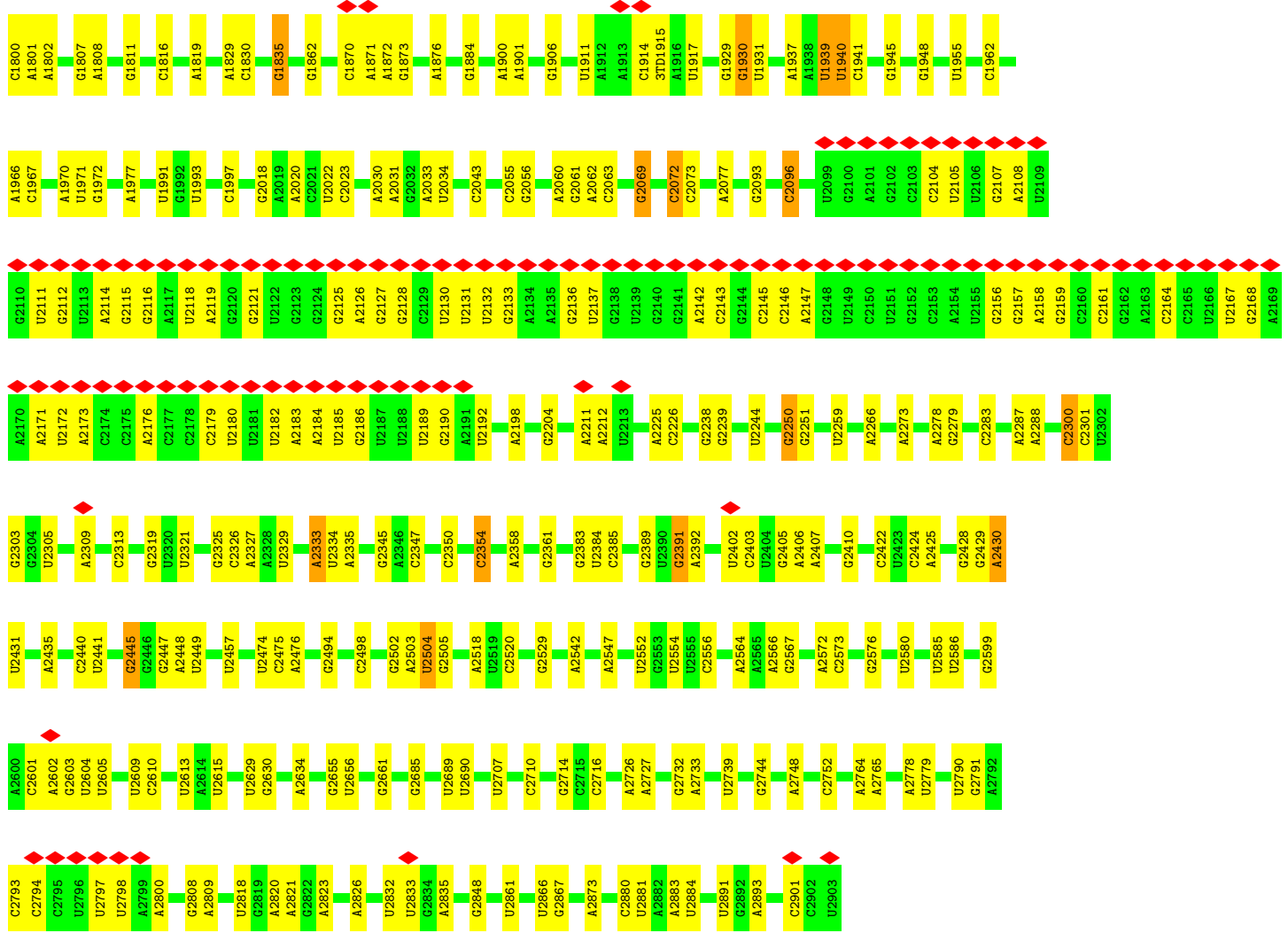

• Molecule 23: 5S ribosomal RNA

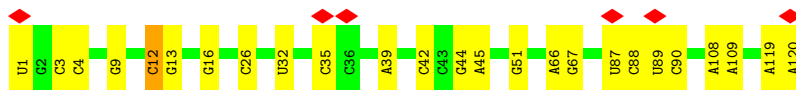
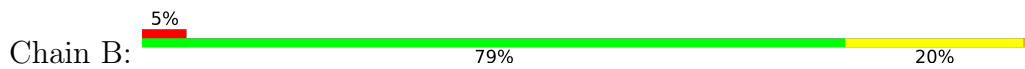

• Molecule 24: 50S ribosomal protein L2



• Molecule 25: 50S ribosomal protein L3



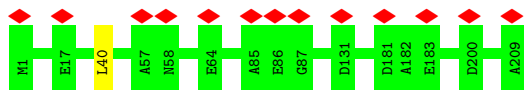

- Molecule 26: 50S ribosomal protein L4

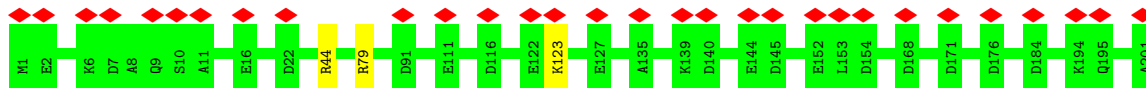

- Molecule 27: 50S ribosomal protein L5

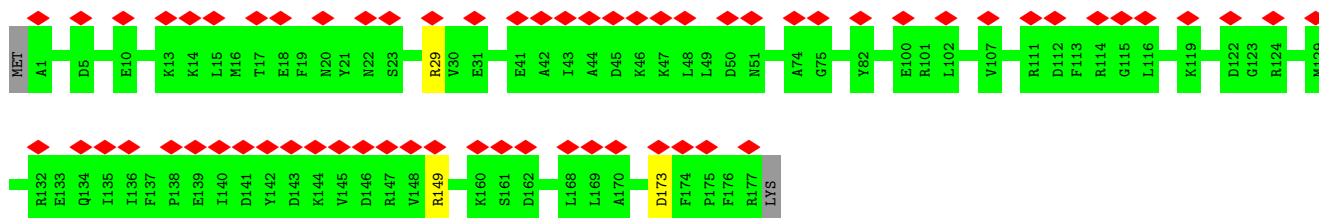

- Molecule 28: 50S ribosomal protein L6

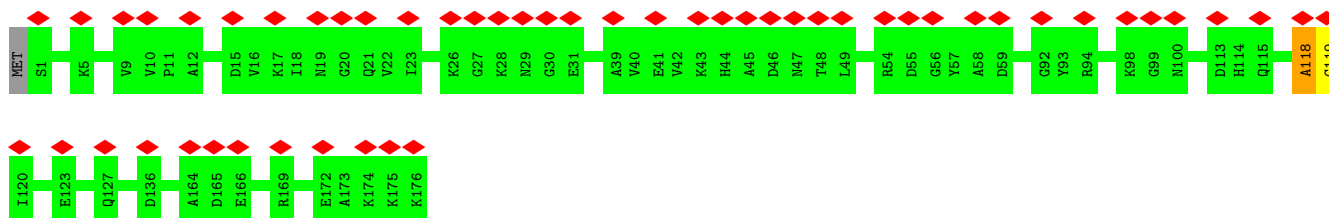

- Molecule 29: 50S ribosomal protein L9

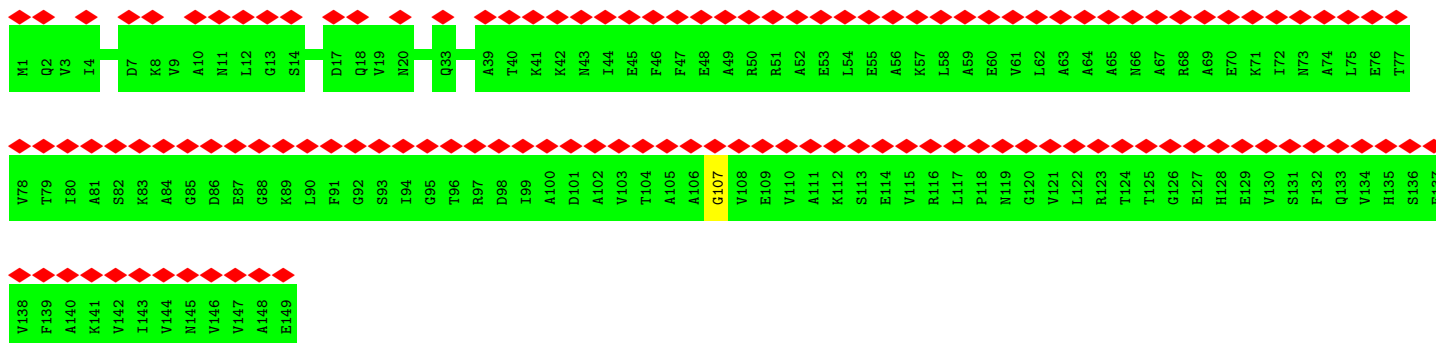
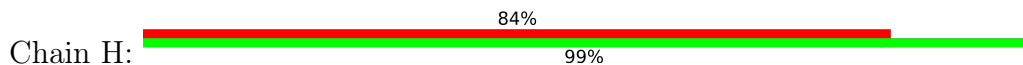

- Molecule 30: 50S ribosomal protein L11

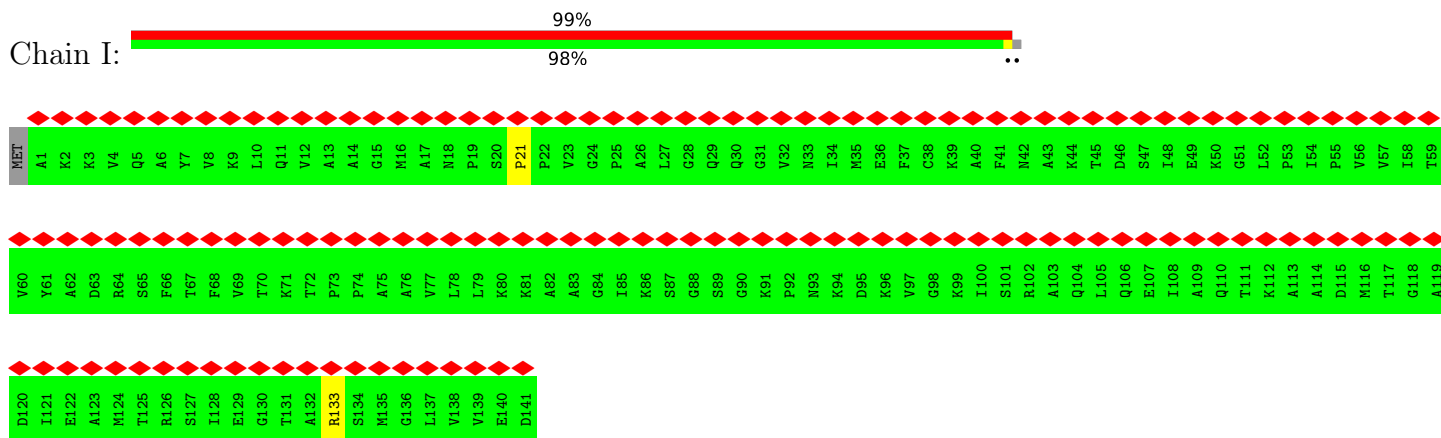

• Molecule 31: 50S ribosomal protein L13

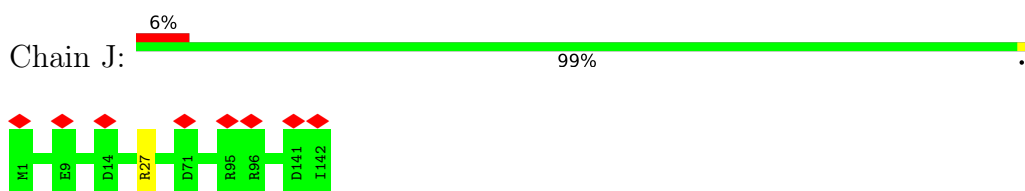

• Molecule 32: 50S ribosomal protein L14

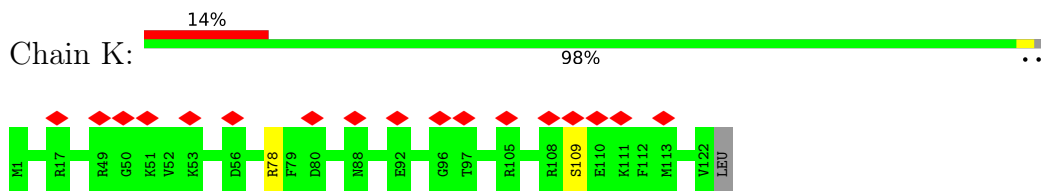

• Molecule 33: 50S ribosomal protein L15

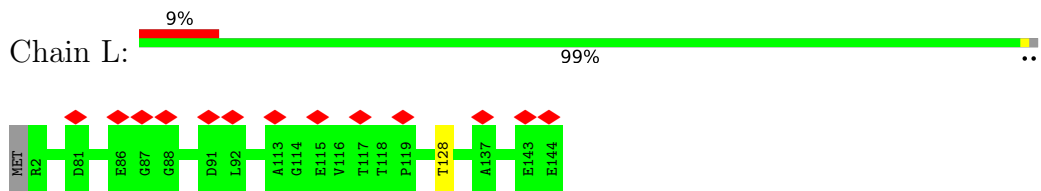

• Molecule 34: 50S ribosomal protein L16

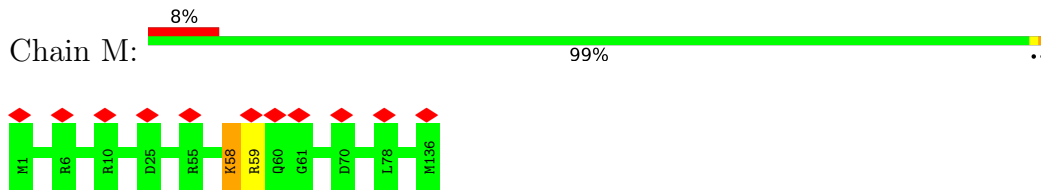

• Molecule 35: 50S ribosomal protein L17

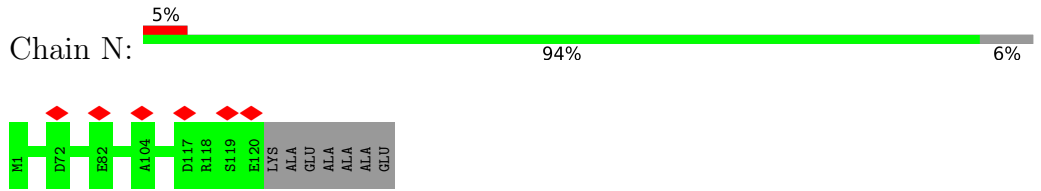

- Molecule 36: 50S ribosomal protein L18

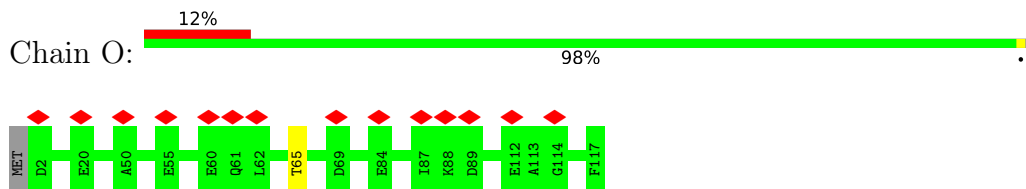

- Molecule 37: 50S ribosomal protein L19

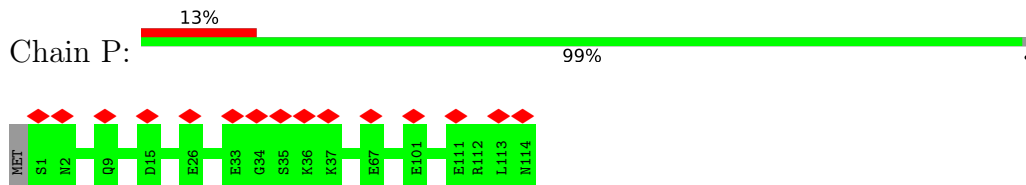

- Molecule 38: 50S ribosomal protein L20

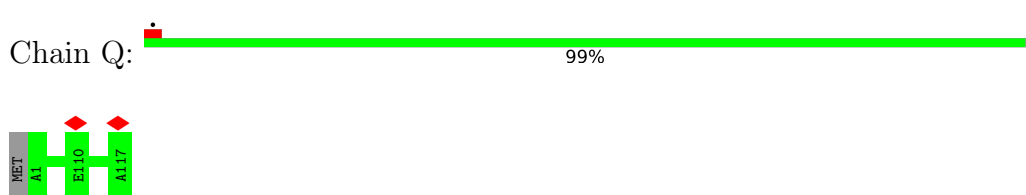

- Molecule 39: 50S ribosomal protein L21

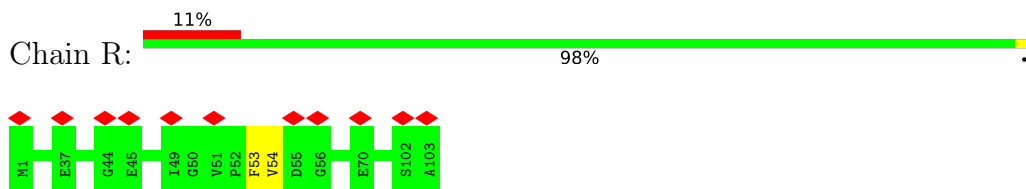

- Molecule 40: 50S ribosomal protein L22

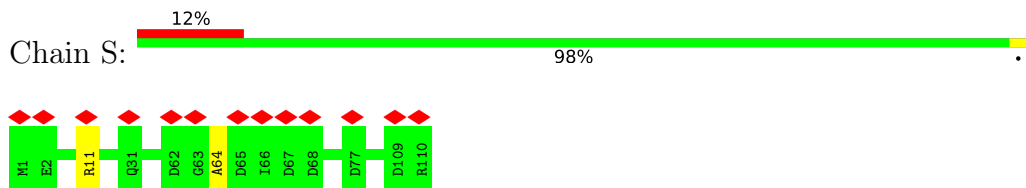

- Molecule 41: 50S ribosomal protein L23

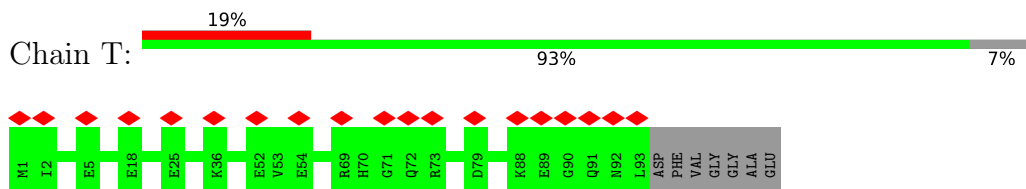

- Molecule 42: 50S ribosomal protein L24

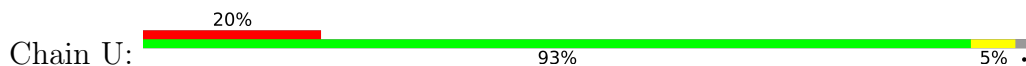

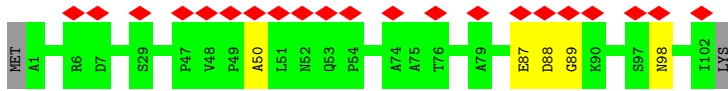

- Molecule 43: 50S ribosomal protein L25

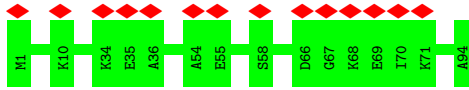

- Molecule 44: 50S ribosomal protein L27

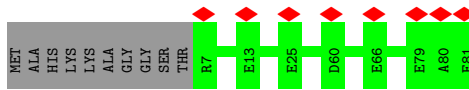
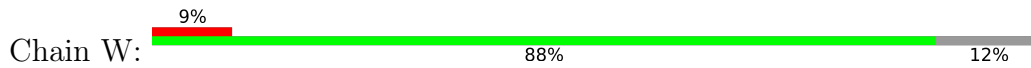

- Molecule 45: 50S ribosomal protein L28

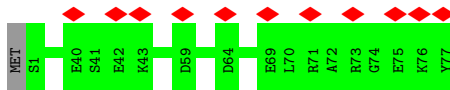

- Molecule 46: 50S ribosomal protein L29

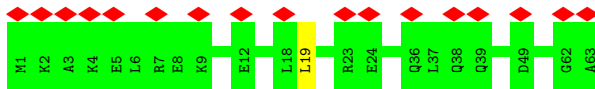

- Molecule 47: 50S ribosomal protein L30

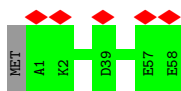

- Molecule 48: 50S ribosomal protein L32

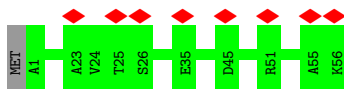

- Molecule 49: 50S ribosomal protein L33

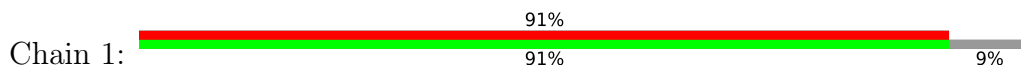

• Molecule 50: 50S ribosomal protein L34

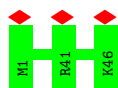

• Molecule 51: 50S ribosomal protein L35

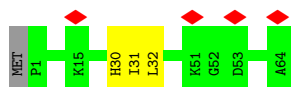
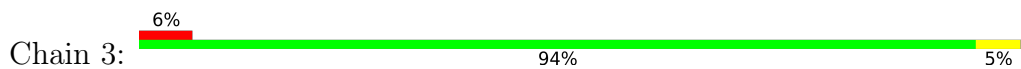

• Molecule 52: 50S ribosomal protein L36

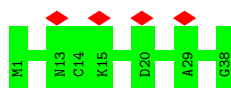

• Molecule 53: 50S ribosomal protein L10

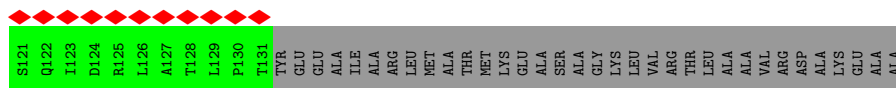
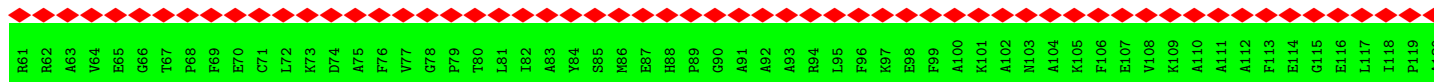
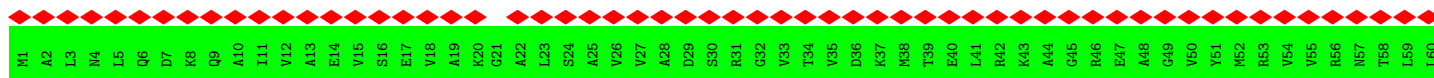
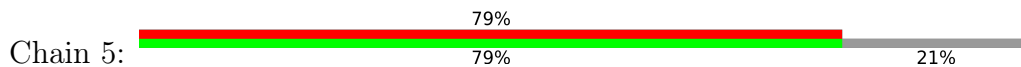

• Molecule 54: 50S ribosomal protein L31

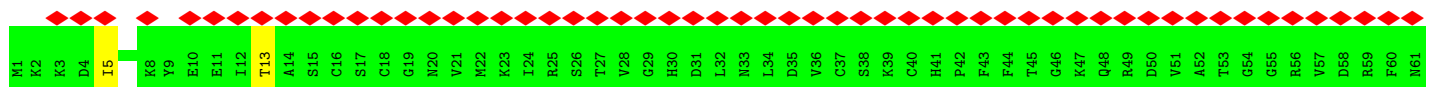
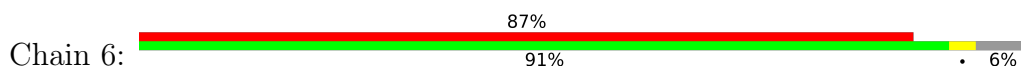

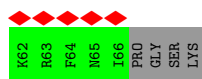

- Molecule 55: P/P tRNA

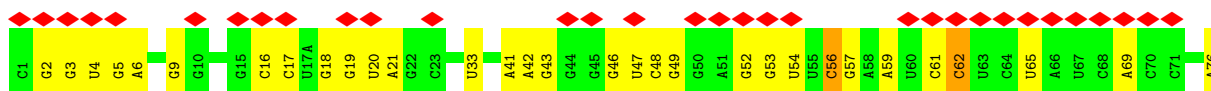
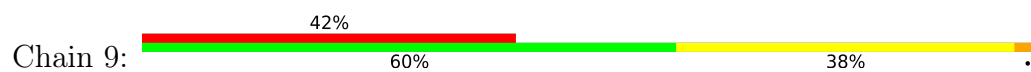

- Molecule 56: mRNA



There are no outlier residues recorded for this chain.

4 Experimental information

Property	Value	Source
EM reconstruction method	SINGLE PARTICLE	Depositor
Imposed symmetry	POINT, Not provided	
Number of particles used	40231	Depositor
Resolution determination method	FSC 0.143 CUT-OFF	Depositor
CTF correction method	PHASE FLIPPING AND AMPLITUDE CORRECTION	Depositor
Microscope	FEI TECNAI ARCTICA	Depositor
Voltage (kV)	200	Depositor
Electron dose ($e^-/\text{\AA}^2$)	50	Depositor
Minimum defocus (nm)	Not provided	
Maximum defocus (nm)	Not provided	
Magnification	23500	Depositor
Image detector	GATAN K2 SUMMIT (4k x 4k)	Depositor
Maximum map value	0.272	Depositor
Minimum map value	-0.164	Depositor
Average map value	0.000	Depositor
Map value standard deviation	0.013	Depositor
Recommended contour level	0.046	Depositor
Map size (Å)	441.0, 441.0, 441.0	wwPDB
Map dimensions	300, 300, 300	wwPDB
Map angles (°)	90.0, 90.0, 90.0	wwPDB
Pixel spacing (Å)	1.47, 1.47, 1.47	Depositor

5 Model quality i

5.1 Standard geometry i

Bond lengths and bond angles in the following residue types are not validated in this section: UR3, OMG, OMU, 2MG, 5MC, 5MU, 2MA, 1MG, MA6, OMC, 4OC, 6MZ, 3TD, H2U, PSU, G7M

The Z score for a bond length (or angle) is the number of standard deviations the observed value is removed from the expected value. A bond length (or angle) with $|Z| > 5$ is considered an outlier worth inspection. RMSZ is the root-mean-square of all Z scores of the bond lengths (or angles).

Mol	Chain	Bond lengths		Bond angles	
		RMSZ	# Z >5	RMSZ	# Z >5
1	a	0.98	4/36675 (0.0%)	0.95	39/57205 (0.1%)
2	b	0.35	0/1735	0.54	0/2338
3	c	0.42	0/1651	0.53	0/2225
4	d	0.44	0/1665	0.59	0/2227
5	e	0.50	0/1154	0.58	0/1554
6	f	0.43	0/835	0.59	0/1128
7	g	0.35	0/1195	0.54	1/1602 (0.1%)
8	h	0.51	0/989	0.55	0/1326
9	i	0.39	0/1034	0.57	0/1375
10	j	0.40	0/796	0.62	0/1077
11	k	0.42	0/885	0.55	0/1195
12	l	0.54	0/969	0.63	0/1300
13	m	0.36	0/892	0.55	0/1193
14	n	0.39	0/811	0.51	0/1081
15	o	0.46	0/722	0.54	0/964
16	p	0.51	0/659	0.59	0/884
17	q	0.48	0/657	0.58	0/881
18	r	0.45	0/511	0.58	0/689
19	s	0.38	0/652	0.56	0/877
20	t	0.43	0/671	0.53	0/888
21	u	0.33	0/500	0.59	0/668
22	A	1.15	10/69174 (0.0%)	0.97	56/107910 (0.1%)
23	B	0.93	1/2876 (0.0%)	0.98	1/4483 (0.0%)
24	C	0.60	0/2121	0.58	0/2852
25	D	0.61	0/1586	0.57	0/2134
26	E	0.51	0/1571	0.56	0/2113
27	F	0.43	0/1434	0.56	0/1926
28	G	0.42	0/1343	0.55	0/1816
29	H	0.35	0/1122	0.59	0/1515
30	I	0.30	0/1046	0.57	0/1410
31	J	0.60	0/1152	0.56	0/1551

Mol	Chain	Bond lengths		Bond angles	
		RMSZ	# Z >5	RMSZ	# Z >5
32	K	0.56	0/947	0.58	0/1268
33	L	0.53	0/1054	0.63	0/1403
34	M	0.56	0/1093	0.55	0/1460
35	N	0.56	0/973	0.61	0/1301
36	O	0.46	0/902	0.54	0/1209
37	P	0.61	0/929	0.55	0/1242
38	Q	0.71	0/960	0.56	0/1278
39	R	0.60	0/829	0.60	0/1107
40	S	0.56	0/864	0.63	0/1156
41	T	0.49	0/744	0.50	0/994
42	U	0.44	0/787	0.54	0/1051
43	V	0.49	0/766	0.53	0/1025
44	W	0.59	0/582	0.51	0/769
45	X	0.54	0/635	0.56	0/848
46	Y	0.40	0/510	0.55	0/677
47	Z	0.50	0/453	0.56	0/605
48	0	0.57	0/450	0.57	0/599
49	1	0.33	0/416	0.52	0/554
50	2	0.54	0/380	0.59	0/498
51	3	0.52	0/513	0.65	0/676
52	4	0.59	0/303	0.53	0/397
53	5	0.31	0/1001	0.60	0/1350
54	6	0.33	0/531	0.55	1/709 (0.1%)
55	9	0.67	0/1839	1.06	5/2866 (0.2%)
56	x	0.89	0/69	1.04	0/105
All	All	0.95	15/157613 (0.0%)	0.88	103/235534 (0.0%)

Chiral center outliers are detected by calculating the chiral volume of a chiral center and verifying if the center is modelled as a planar moiety or with the opposite hand. A planarity outlier is detected by checking planarity of atoms in a peptide group, atoms in a mainchain group or atoms of a sidechain that are expected to be planar.

Mol	Chain	#Chirality outliers	#Planarity outliers
2	b	0	1
5	e	0	2
6	f	0	3
7	g	0	1
12	l	0	1
13	m	0	1
16	p	0	1
17	q	0	2
21	u	0	1

Continued on next page...

Continued from previous page...

Mol	Chain	#Chirality outliers	#Planarity outliers
27	F	0	1
28	G	0	1
29	H	0	1
30	I	0	1
32	K	0	1
34	M	0	1
39	R	0	1
42	U	0	1
51	3	0	1
All	All	0	22

All (15) bond length outliers are listed below:

Mol	Chain	Res	Type	Atoms	Z	Observed(Å)	Ideal(Å)
22	A	1	G	OP3-P	-10.67	1.48	1.61
23	B	1	U	OP3-P	-10.66	1.48	1.61
1	a	2	A	OP3-P	-10.36	1.48	1.61
1	a	378	G	N9-C4	-6.65	1.32	1.38
22	A	528	A	N9-C4	-5.86	1.34	1.37
22	A	783	A	N9-C4	-5.78	1.34	1.37
22	A	984	A	N9-C4	-5.39	1.34	1.37
1	a	386	C	N1-C2	-5.35	1.34	1.40
22	A	581	C	N1-C6	-5.34	1.33	1.37
22	A	565	C	N1-C6	-5.31	1.33	1.37
22	A	1142	A	N9-C4	-5.19	1.34	1.37
1	a	374	A	N9-C4	5.15	1.41	1.37
22	A	528	A	N3-C4	-5.11	1.31	1.34
22	A	2333	A	N9-C4	-5.09	1.34	1.37
22	A	640	C	N1-C6	-5.02	1.34	1.37

All (103) bond angle outliers are listed below:

Mol	Chain	Res	Type	Atoms	Z	Observed(°)	Ideal(°)
1	a	378	G	N3-C4-N9	-10.86	119.48	126.00
1	a	437	U	C2-N1-C1'	8.64	128.07	117.70
1	a	378	G	N3-C4-C5	8.62	132.91	128.60
22	A	528	A	C2-N3-C4	-7.92	106.64	110.60
1	a	511	C	C2-N1-C1'	-7.71	110.32	118.80
1	a	437	U	C6-N1-C1'	-7.61	110.55	121.20
1	a	386	C	C2-N1-C1'	-7.19	110.90	118.80
1	a	733	G	C4-N9-C1'	-7.01	117.39	126.50
22	A	1104	C	N3-C2-O2	-7.00	117.00	121.90

Continued on next page...

Continued from previous page...

Mol	Chain	Res	Type	Atoms	Z	Observed(°)	Ideal(°)
1	a	386	C	C6-N1-C1'	6.95	129.14	120.80
22	A	2179	C	C2-N1-C1'	6.82	126.30	118.80
22	A	62	U	C2-N1-C1'	6.77	125.83	117.70
1	a	377	G	C2-N3-C4	-6.76	108.52	111.90
22	A	1313	U	C2-N1-C1'	6.70	125.74	117.70
22	A	1779	U	C5-C6-N1	-6.69	119.35	122.70
1	a	379	C	C6-N1-C2	-6.60	117.66	120.30
1	a	379	C	O4'-C1'-N1	6.57	113.46	108.20
22	A	1727	C	N3-C2-O2	-6.51	117.34	121.90
22	A	2096	C	C2-N1-C1'	6.47	125.92	118.80
22	A	1314	C	C2-N1-C1'	6.46	125.91	118.80
22	A	984	A	C2-N3-C4	-6.40	107.40	110.60
22	A	143	C	C2-N1-C1'	6.39	125.83	118.80
1	a	733	G	C8-N9-C1'	6.37	135.28	127.00
1	a	377	G	N3-C4-N9	-6.24	122.26	126.00
22	A	1830	C	C2-N1-C1'	6.14	125.55	118.80
22	A	785	G	O5'-P-OP2	-6.09	100.22	105.70
55	9	56	C	C2-N1-C1'	6.07	125.48	118.80
22	A	512	G	O4'-C1'-N9	6.07	113.05	108.20
1	a	511	C	N1-C2-O2	-6.02	115.29	118.90
1	a	378	G	C4-N9-C1'	-6.00	118.70	126.50
55	9	62	C	C2-N1-C1'	5.99	125.39	118.80
1	a	378	G	C5-C6-O6	5.95	132.17	128.60
1	a	377	G	C5-C6-O6	5.91	132.15	128.60
22	A	528	A	N1-C2-N3	5.90	132.25	129.30
1	a	378	G	C8-N9-C1'	5.89	134.66	127.00
1	a	378	G	C6-C5-N7	5.88	133.93	130.40
22	A	1776	G	C4-N9-C1'	5.87	134.13	126.50
1	a	437	U	C5-C4-O4	-5.81	122.41	125.90
1	a	733	G	O4'-C1'-N9	5.79	112.83	108.20
22	A	2391	G	P-O3'-C3'	5.77	126.63	119.70
55	9	61	C	C2-N1-C1'	5.69	125.06	118.80
22	A	1142	A	C2-N3-C4	-5.66	107.77	110.60
1	a	511	C	C6-N1-C1'	5.65	127.58	120.80
1	a	733	G	N3-C4-N9	-5.64	122.61	126.00
1	a	433	G	N7-C8-N9	5.61	115.90	113.10
22	A	783	A	C5-N7-C8	-5.60	101.10	103.90
22	A	2179	C	C6-N1-C1'	-5.60	114.08	120.80
23	B	12	C	C2-N1-C1'	5.59	124.95	118.80
22	A	2244	U	N3-C4-O4	5.58	123.31	119.40
1	a	575	G	N3-C4-N9	-5.55	122.67	126.00
1	a	1278	G	O4'-C1'-N9	5.52	112.61	108.20

Continued on next page...

Continued from previous page...

Mol	Chain	Res	Type	Atoms	Z	Observed(°)	Ideal(°)
22	A	974	G	O4'-C1'-N9	5.51	112.61	108.20
1	a	378	G	N9-C4-C5	5.50	107.60	105.40
22	A	2250	G	C5-N7-C8	-5.46	101.57	104.30
1	a	1301	U	P-O3'-C3'	5.45	126.24	119.70
22	A	914	G	N3-C4-C5	5.45	131.32	128.60
1	a	380	G	P-O3'-C3'	-5.44	113.17	119.70
22	A	1313	U	N1-C2-O2	5.43	126.60	122.80
22	A	62	U	N1-C2-O2	5.42	126.59	122.80
22	A	914	G	N3-C4-N9	-5.38	122.77	126.00
22	A	1940	U	P-O3'-C3'	5.37	126.14	119.70
7	g	123	LEU	CA-CB-CG	5.37	127.65	115.30
22	A	2250	G	C4-C5-N7	5.37	112.95	110.80
22	A	784	G	P-O3'-C3'	5.35	126.12	119.70
1	a	1201	A	P-O3'-C3'	5.35	126.12	119.70
22	A	2354	C	C6-N1-C2	-5.34	118.16	120.30
1	a	511	C	C5-C6-N1	-5.30	118.35	121.00
1	a	377	G	N3-C4-C5	5.29	131.25	128.60
1	a	359	G	C6-C5-N7	-5.29	127.22	130.40
54	6	5	ILE	C-N-CA	-5.29	108.47	121.70
22	A	2300	C	C2-N1-C1'	5.29	124.61	118.80
22	A	1945	G	C8-N9-C1'	-5.28	120.14	127.00
22	A	1314	C	C6-N1-C1'	-5.27	114.47	120.80
22	A	1493	C	N1-C2-O2	5.27	122.06	118.90
55	9	65	U	C2-N1-C1'	5.26	124.01	117.70
22	A	2096	C	N1-C2-O2	5.26	122.06	118.90
22	A	2096	C	C6-N1-C1'	-5.26	114.49	120.80
55	9	62	C	C6-N1-C1'	-5.25	114.50	120.80
22	A	2354	C	C5-C6-N1	5.24	123.62	121.00
22	A	1060	U	N3-C2-O2	-5.24	118.53	122.20
22	A	62	U	C5-C6-N1	5.23	125.31	122.70
22	A	2072	C	C5-C6-N1	5.22	123.61	121.00
1	a	469	C	C6-N1-C2	-5.21	118.22	120.30
1	a	1395	C	C2-N1-C1'	5.20	124.52	118.80
22	A	1945	G	N3-C4-N9	5.20	129.12	126.00
22	A	879	G	N9-C4-C5	5.16	107.46	105.40
22	A	1930	G	P-O3'-C3'	5.15	125.88	119.70
22	A	1776	G	C8-N9-C1'	-5.14	120.31	127.00
22	A	1577	C	C6-N1-C2	-5.14	118.24	120.30
1	a	386	C	C5-C4-N4	5.14	123.80	120.20
1	a	374	A	C2-N3-C4	5.13	113.16	110.60
1	a	406	G	C4-C5-N7	5.11	112.84	110.80
22	A	1734	G	C5-C6-O6	5.10	131.66	128.60

Continued on next page...

Continued from previous page...

Mol	Chain	Res	Type	Atoms	Z	Observed(°)	Ideal(°)
1	a	1301	U	OP1-P-O3'	5.10	116.41	105.20
22	A	2250	G	C2-N3-C4	-5.10	109.35	111.90
22	A	1945	G	N9-C4-C5	-5.09	103.36	105.40
22	A	2430	A	C2-N3-C4	5.07	113.13	110.60
22	A	143	C	C6-N1-C1'	-5.05	114.75	120.80
22	A	528	A	C5-N7-C8	-5.04	101.38	103.90
22	A	783	A	C4-C5-N7	5.02	113.21	110.70
22	A	2710	C	N1-C2-O2	-5.01	115.89	118.90
22	A	1157	G	C6-C5-N7	-5.01	127.40	130.40
22	A	2329	U	C5-C6-N1	5.00	125.20	122.70

There are no chirality outliers.

All (22) planarity outliers are listed below:

Mol	Chain	Res	Type	Group
51	3	30	HIS	Peptide
27	F	173	ASP	Peptide
28	G	118	ALA	Peptide
29	H	107	GLY	Peptide
30	I	21	PRO	Peptide
32	K	109	SER	Peptide
34	M	58	LYS	Peptide
39	R	53	PHE	Peptide
42	U	88	ASP	Peptide
2	b	87	ASP	Peptide
5	e	120	HIS	Peptide
5	e	121	ASN	Peptide
6	f	52	ASN	Peptide
6	f	53	LYS	Peptide
6	f	91	ARG	Peptide
7	g	63	VAL	Peptide
12	l	101	LEU	Peptide
13	m	4	ALA	Peptide
16	p	44	SER	Peptide
17	q	49	ASN	Peptide
17	q	69	THR	Peptide
21	u	23	GLU	Peptide

5.2 Too-close contacts

Due to software issues we are unable to calculate clashes - this section is therefore empty.

5.3 Torsion angles [i](#)

5.3.1 Protein backbone [i](#)

In the following table, the Percentiles column shows the percent Ramachandran outliers of the chain as a percentile score with respect to all PDB entries followed by that with respect to all EM entries.

The Analysed column shows the number of residues for which the backbone conformation was analysed, and the total number of residues.

Mol	Chain	Analysed	Favoured	Allowed	Outliers	Percentiles	
2	b	216/240 (90%)	179 (83%)	37 (17%)	0	100	100
3	c	204/233 (88%)	187 (92%)	17 (8%)	0	100	100
4	d	203/206 (98%)	158 (78%)	45 (22%)	0	100	100
5	e	155/167 (93%)	126 (81%)	27 (17%)	2 (1%)	12	40
6	f	98/135 (73%)	71 (72%)	25 (26%)	2 (2%)	7	32
7	g	149/179 (83%)	132 (89%)	17 (11%)	0	100	100
8	h	127/130 (98%)	112 (88%)	15 (12%)	0	100	100
9	i	125/130 (96%)	101 (81%)	23 (18%)	1 (1%)	19	51
10	j	96/103 (93%)	76 (79%)	18 (19%)	2 (2%)	7	31
11	k	114/129 (88%)	94 (82%)	20 (18%)	0	100	100
12	l	121/124 (98%)	87 (72%)	33 (27%)	1 (1%)	19	51
13	m	112/118 (95%)	92 (82%)	18 (16%)	2 (2%)	8	35
14	n	99/102 (97%)	82 (83%)	17 (17%)	0	100	100
15	o	86/89 (97%)	78 (91%)	7 (8%)	1 (1%)	13	42
16	p	80/82 (98%)	68 (85%)	12 (15%)	0	100	100
17	q	78/84 (93%)	66 (85%)	9 (12%)	3 (4%)	3	19
18	r	63/75 (84%)	52 (82%)	11 (18%)	0	100	100
19	s	77/92 (84%)	64 (83%)	13 (17%)	0	100	100
20	t	83/87 (95%)	75 (90%)	8 (10%)	0	100	100
21	u	63/71 (89%)	44 (70%)	18 (29%)	1 (2%)	9	36
24	C	269/273 (98%)	244 (91%)	25 (9%)	0	100	100
25	D	207/209 (99%)	183 (88%)	24 (12%)	0	100	100
26	E	199/201 (99%)	181 (91%)	18 (9%)	0	100	100
27	F	175/179 (98%)	153 (87%)	22 (13%)	0	100	100
28	G	174/177 (98%)	146 (84%)	26 (15%)	2 (1%)	14	45

Continued on next page...

Continued from previous page...

Mol	Chain	Analysed	Favoured	Allowed	Outliers	Percentiles	
29	H	147/149 (99%)	119 (81%)	28 (19%)	0	100	100
30	I	139/142 (98%)	111 (80%)	28 (20%)	0	100	100
31	J	140/142 (99%)	129 (92%)	11 (8%)	0	100	100
32	K	120/123 (98%)	102 (85%)	18 (15%)	0	100	100
33	L	141/144 (98%)	115 (82%)	25 (18%)	1 (1%)	22	54
34	M	134/136 (98%)	123 (92%)	9 (7%)	2 (2%)	10	38
35	N	118/127 (93%)	104 (88%)	14 (12%)	0	100	100
36	O	114/117 (97%)	105 (92%)	9 (8%)	0	100	100
37	P	112/115 (97%)	100 (89%)	12 (11%)	0	100	100
38	Q	115/118 (98%)	113 (98%)	2 (2%)	0	100	100
39	R	101/103 (98%)	84 (83%)	16 (16%)	1 (1%)	15	46
40	S	108/110 (98%)	93 (86%)	14 (13%)	1 (1%)	17	48
41	T	91/100 (91%)	77 (85%)	14 (15%)	0	100	100
42	U	100/104 (96%)	81 (81%)	15 (15%)	4 (4%)	3	18
43	V	92/94 (98%)	88 (96%)	4 (4%)	0	100	100
44	W	73/85 (86%)	67 (92%)	6 (8%)	0	100	100
45	X	75/78 (96%)	68 (91%)	7 (9%)	0	100	100
46	Y	61/63 (97%)	56 (92%)	5 (8%)	0	100	100
47	Z	56/59 (95%)	52 (93%)	4 (7%)	0	100	100
48	0	54/57 (95%)	48 (89%)	6 (11%)	0	100	100
49	1	48/55 (87%)	44 (92%)	4 (8%)	0	100	100
50	2	44/46 (96%)	41 (93%)	3 (7%)	0	100	100
51	3	62/65 (95%)	55 (89%)	5 (8%)	2 (3%)	4	22
52	4	36/38 (95%)	28 (78%)	8 (22%)	0	100	100
53	5	129/165 (78%)	104 (81%)	25 (19%)	0	100	100
54	6	64/70 (91%)	53 (83%)	11 (17%)	0	100	100
All	All	5847/6220 (94%)	5011 (86%)	808 (14%)	28 (0%)	32	61

All (28) Ramachandran outliers are listed below:

Mol	Chain	Res	Type
15	o	46	LYS
17	q	70	LYS

Continued on next page...

Continued from previous page...

Mol	Chain	Res	Type
51	3	31	ILE
51	3	32	LEU
5	e	122	VAL
12	l	102	ASP
28	G	119	GLY
34	M	59	ARG
39	R	54	VAL
42	U	89	GLY
5	e	121	ASN
13	m	4	ALA
13	m	5	GLY
21	u	36	PHE
28	G	118	ALA
33	L	128	THR
34	M	58	LYS
6	f	53	LYS
10	j	57	VAL
10	j	58	ASN
17	q	48	GLU
42	U	98	ASN
9	i	91	GLU
17	q	69	THR
40	S	64	ALA
42	U	50	ALA
42	U	87	GLU
6	f	54	LEU

5.3.2 Protein sidechains [i](#)

In the following table, the Percentiles column shows the percent sidechain outliers of the chain as a percentile score with respect to all PDB entries followed by that with respect to all EM entries.

The Analysed column shows the number of residues for which the sidechain conformation was analysed, and the total number of residues.

Mol	Chain	Analysed	Rotameric	Outliers	Percentiles	
2	b	180/198 (91%)	179 (99%)	1 (1%)	86	91
3	c	170/190 (90%)	169 (99%)	1 (1%)	86	91
4	d	172/173 (99%)	169 (98%)	3 (2%)	60	78
5	e	114/126 (90%)	114 (100%)	0	100	100

Continued on next page...

Continued from previous page...

Mol	Chain	Analysed	Rotameric	Outliers	Percentiles	
6	f	87/116 (75%)	87 (100%)	0	100	100
7	g	124/147 (84%)	123 (99%)	1 (1%)	81	89
8	h	104/105 (99%)	104 (100%)	0	100	100
9	i	105/107 (98%)	104 (99%)	1 (1%)	76	86
10	j	86/90 (96%)	86 (100%)	0	100	100
11	k	89/99 (90%)	88 (99%)	1 (1%)	73	85
12	l	103/104 (99%)	101 (98%)	2 (2%)	57	77
13	m	92/96 (96%)	92 (100%)	0	100	100
14	n	79/84 (94%)	79 (100%)	0	100	100
15	o	76/77 (99%)	76 (100%)	0	100	100
16	p	65/65 (100%)	65 (100%)	0	100	100
17	q	74/78 (95%)	74 (100%)	0	100	100
18	r	48/65 (74%)	48 (100%)	0	100	100
19	s	70/79 (89%)	70 (100%)	0	100	100
20	t	65/66 (98%)	65 (100%)	0	100	100
21	u	44/61 (72%)	42 (96%)	2 (4%)	27	58
24	C	216/218 (99%)	216 (100%)	0	100	100
25	D	164/164 (100%)	163 (99%)	1 (1%)	86	91
26	E	165/165 (100%)	162 (98%)	3 (2%)	59	78
27	F	148/150 (99%)	146 (99%)	2 (1%)	67	82
28	G	137/138 (99%)	137 (100%)	0	100	100
29	H	114/114 (100%)	114 (100%)	0	100	100
30	I	109/110 (99%)	108 (99%)	1 (1%)	78	87
31	J	116/116 (100%)	115 (99%)	1 (1%)	78	87
32	K	103/104 (99%)	102 (99%)	1 (1%)	76	86
33	L	102/103 (99%)	102 (100%)	0	100	100
34	M	109/109 (100%)	109 (100%)	0	100	100
35	N	100/103 (97%)	100 (100%)	0	100	100
36	O	86/87 (99%)	85 (99%)	1 (1%)	71	83
37	P	99/100 (99%)	99 (100%)	0	100	100
38	Q	89/90 (99%)	89 (100%)	0	100	100

Continued on next page...

Continued from previous page...

Mol	Chain	Analysed	Rotameric	Outliers	Percentiles	
39	R	84/84 (100%)	84 (100%)	0	100	100
40	S	93/93 (100%)	92 (99%)	1 (1%)	73	85
41	T	80/84 (95%)	80 (100%)	0	100	100
42	U	83/85 (98%)	83 (100%)	0	100	100
43	V	78/78 (100%)	78 (100%)	0	100	100
44	W	57/63 (90%)	57 (100%)	0	100	100
45	X	67/68 (98%)	67 (100%)	0	100	100
46	Y	55/55 (100%)	54 (98%)	1 (2%)	59	78
47	Z	48/49 (98%)	48 (100%)	0	100	100
48	0	47/48 (98%)	47 (100%)	0	100	100
49	1	45/49 (92%)	45 (100%)	0	100	100
50	2	38/38 (100%)	38 (100%)	0	100	100
51	3	51/52 (98%)	51 (100%)	0	100	100
52	4	34/34 (100%)	34 (100%)	0	100	100
53	5	100/123 (81%)	100 (100%)	0	100	100
54	6	59/62 (95%)	58 (98%)	1 (2%)	60	78
All	All	4823/5062 (95%)	4798 (100%)	25 (0%)	89	93

All (25) residues with a non-rotameric sidechain are listed below:

Mol	Chain	Res	Type
2	b	20	ARG
3	c	44	LYS
4	d	59	LYS
4	d	183	ARG
4	d	184	LYS
7	g	135	LYS
9	i	44	ARG
11	k	124	LYS
12	l	30	ARG
12	l	113	ARG
21	u	32	ARG
21	u	46	ARG
25	D	40	LEU
26	E	44	ARG
26	E	79	ARG

Continued on next page...

Continued from previous page...

Mol	Chain	Res	Type
26	E	123	LYS
27	F	29	ARG
27	F	149	ARG
30	I	133	ARG
31	J	27	ARG
32	K	78	ARG
36	O	65	THR
40	S	11	ARG
46	Y	19	LEU
54	6	13	THR

Sometimes sidechains can be flipped to improve hydrogen bonding and reduce clashes. All (74) such sidechains are listed below:

Mol	Chain	Res	Type
2	b	41	ASN
3	c	101	ASN
3	c	138	GLN
3	c	189	HIS
4	d	40	HIS
4	d	58	GLN
4	d	88	ASN
4	d	99	ASN
4	d	195	ASN
5	e	76	ASN
5	e	88	HIS
5	e	121	ASN
7	g	67	ASN
7	g	129	ASN
9	i	30	ASN
9	i	74	GLN
9	i	80	HIS
11	k	23	HIS
11	k	27	ASN
11	k	39	ASN
11	k	80	ASN
13	m	13	HIS
13	m	51	GLN
14	n	60	GLN
14	n	66	GLN
15	o	27	GLN
15	o	36	ASN
15	o	39	GLN

Continued on next page...

Continued from previous page...

Mol	Chain	Res	Type
15	o	45	HIS
16	p	18	GLN
17	q	30	HIS
18	r	51	GLN
19	s	51	HIS
19	s	68	HIS
20	t	77	ASN
24	C	20	ASN
24	C	45	ASN
24	C	89	ASN
24	C	127	ASN
24	C	242	HIS
25	D	32	ASN
25	D	49	GLN
25	D	136	ASN
25	D	164	GLN
26	E	41	GLN
27	F	4	HIS
27	F	51	ASN
28	G	37	ASN
28	G	63	GLN
28	G	127	GLN
30	I	18	ASN
30	I	104	GLN
30	I	110	GLN
31	J	58	ASN
32	K	3	GLN
32	K	29	HIS
36	O	29	HIS
36	O	38	GLN
37	P	11	GLN
38	Q	71	ASN
39	R	82	HIS
40	S	7	HIS
40	S	31	GLN
41	T	15	HIS
42	U	65	GLN
42	U	98	ASN
44	W	8	ASN
44	W	72	ASN
46	Y	58	ASN
48	0	41	HIS

Continued on next page...

Continued from previous page...

Mol	Chain	Res	Type
49	1	18	HIS
52	4	35	GLN
53	5	88	HIS
54	6	41	HIS

5.3.3 RNA [i](#)

Mol	Chain	Analysed	Backbone Outliers	Pucker Outliers
1	a	1535/1539 (99%)	310 (20%)	0
22	A	2894/2903 (99%)	586 (20%)	31 (1%)
23	B	119/120 (99%)	22 (18%)	2 (1%)
55	9	76/77 (98%)	28 (36%)	3 (3%)
56	x	2/3 (66%)	0	0
All	All	4626/4642 (99%)	946 (20%)	36 (0%)

All (946) RNA backbone outliers are listed below:

Mol	Chain	Res	Type
1	a	4	U
1	a	5	U
1	a	6	G
1	a	7	A
1	a	9	G
1	a	16	A
1	a	19	A
1	a	22	G
1	a	32	A
1	a	39	G
1	a	41	G
1	a	42	G
1	a	47	C
1	a	48	C
1	a	51	A
1	a	54	C
1	a	55	A
1	a	71	A
1	a	77	A
1	a	82	G
1	a	84	U
1	a	85	U
1	a	87	C

Continued on next page...

Continued from previous page...

Mol	Chain	Res	Type
1	a	90	C
1	a	91	U
1	a	92	U
1	a	94	G
1	a	95	C
1	a	96	U
1	a	98	A
1	a	116	A
1	a	121	U
1	a	122	G
1	a	130	A
1	a	144	G
1	a	145	G
1	a	151	A
1	a	160	A
1	a	163	C
1	a	164	G
1	a	168	G
1	a	172	A
1	a	177	G
1	a	183	C
1	a	184	G
1	a	192	A
1	a	197	A
1	a	204	G
1	a	208	U
1	a	209	U
1	a	210	C
1	a	212	G
1	a	222	C
1	a	226	G
1	a	240	G
1	a	245	U
1	a	247	G
1	a	251	G
1	a	266	G
1	a	267	C
1	a	280	C
1	a	281	G
1	a	289	G
1	a	299	G
1	a	306	A

Continued on next page...

Continued from previous page...

Mol	Chain	Res	Type
1	a	321	A
1	a	326	G
1	a	328	C
1	a	329	A
1	a	330	C
1	a	344	A
1	a	345	C
1	a	351	G
1	a	352	C
1	a	353	A
1	a	355	C
1	a	356	A
1	a	359	G
1	a	360	G
1	a	366	A
1	a	367	U
1	a	372	C
1	a	373	A
1	a	374	A
1	a	375	U
1	a	377	G
1	a	379	C
1	a	381	C
1	a	384	G
1	a	388	G
1	a	389	A
1	a	406	G
1	a	409	U
1	a	411	A
1	a	413	G
1	a	415	A
1	a	421	U
1	a	422	C
1	a	423	G
1	a	424	G
1	a	425	G
1	a	426	U
1	a	429	U
1	a	433	G
1	a	436	C
1	a	437	U
1	a	439	U

Continued on next page...

Continued from previous page...

Mol	Chain	Res	Type
1	a	441	A
1	a	442	G
1	a	460	A
1	a	462	G
1	a	465	A
1	a	467	U
1	a	468	A
1	a	469	C
1	a	474	G
1	a	479	U
1	a	484	G
1	a	485	U
1	a	486	U
1	a	495	A
1	a	496	A
1	a	500	G
1	a	502	A
1	a	505	G
1	a	511	C
1	a	519	C
1	a	521	G
1	a	531	U
1	a	532	A
1	a	534	U
1	a	543	U
1	a	544	G
1	a	547	A
1	a	549	C
1	a	559	A
1	a	562	U
1	a	572	A
1	a	573	A
1	a	576	C
1	a	577	G
1	a	596	A
1	a	632	U
1	a	633	G
1	a	634	C
1	a	648	A
1	a	656	G
1	a	665	A
1	a	691	G

Continued on next page...

Continued from previous page...

Mol	Chain	Res	Type
1	a	695	A
1	a	703	G
1	a	704	A
1	a	705	G
1	a	721	G
1	a	723	U
1	a	724	G
1	a	731	G
1	a	744	C
1	a	755	G
1	a	760	G
1	a	777	A
1	a	792	A
1	a	794	A
1	a	802	A
1	a	812	G
1	a	814	A
1	a	815	A
1	a	817	C
1	a	818	G
1	a	819	A
1	a	820	U
1	a	829	G
1	a	832	G
1	a	836	G
1	a	841	C
1	a	843	U
1	a	844	G
1	a	846	G
1	a	851	G
1	a	872	A
1	a	889	A
1	a	890	G
1	a	891	U
1	a	902	G
1	a	926	G
1	a	934	C
1	a	935	A
1	a	960	U
1	a	961	U
1	a	965	U
1	a	966	2MG

Continued on next page...

Continued from previous page...

Mol	Chain	Res	Type
1	a	967	5MC
1	a	968	A
1	a	969	A
1	a	971	G
1	a	972	C
1	a	974	A
1	a	975	A
1	a	976	G
1	a	977	A
1	a	992	U
1	a	993	G
1	a	1000	A
1	a	1004	A
1	a	1025	U
1	a	1026	G
1	a	1027	C
1	a	1028	C
1	a	1030	U
1	a	1031	C
1	a	1033	G
1	a	1034	G
1	a	1045	C
1	a	1053	G
1	a	1054	C
1	a	1064	G
1	a	1065	U
1	a	1089	G
1	a	1094	G
1	a	1101	A
1	a	1104	G
1	a	1124	G
1	a	1126	U
1	a	1127	G
1	a	1130	A
1	a	1136	C
1	a	1137	C
1	a	1138	G
1	a	1139	G
1	a	1157	A
1	a	1158	C
1	a	1159	U
1	a	1160	G

Continued on next page...

Continued from previous page...

Mol	Chain	Res	Type
1	a	1168	U
1	a	1169	A
1	a	1174	G
1	a	1181	G
1	a	1182	G
1	a	1183	U
1	a	1184	G
1	a	1191	A
1	a	1192	C
1	a	1195	C
1	a	1196	A
1	a	1201	A
1	a	1202	U
1	a	1212	U
1	a	1225	A
1	a	1226	C
1	a	1227	A
1	a	1228	C
1	a	1236	A
1	a	1238	A
1	a	1240	U
1	a	1241	G
1	a	1249	C
1	a	1250	A
1	a	1256	A
1	a	1257	A
1	a	1258	G
1	a	1260	G
1	a	1261	A
1	a	1268	G
1	a	1278	G
1	a	1280	A
1	a	1282	C
1	a	1287	A
1	a	1298	U
1	a	1300	G
1	a	1301	U
1	a	1302	C
1	a	1305	G
1	a	1313	U
1	a	1323	G
1	a	1338	G

Continued on next page...

Continued from previous page...

Mol	Chain	Res	Type
1	a	1340	A
1	a	1346	A
1	a	1347	G
1	a	1348	U
1	a	1353	G
1	a	1360	A
1	a	1363	A
1	a	1370	G
1	a	1398	A
1	a	1399	C
1	a	1400	C
1	a	1406	U
1	a	1419	G
1	a	1429	A
1	a	1446	A
1	a	1448	C
1	a	1452	C
1	a	1453	G
1	a	1462	C
1	a	1482	G
1	a	1487	G
1	a	1492	A
1	a	1497	G
1	a	1502	A
1	a	1503	A
1	a	1506	U
1	a	1507	A
1	a	1517	G
1	a	1529	G
1	a	1530	G
1	a	1533	C
1	a	1534	A
1	a	1535	C
1	a	1536	C
1	a	1537	U
22	A	10	A
22	A	12	U
22	A	15	G
22	A	23	G
22	A	34	U
22	A	35	G
22	A	42	A

Continued on next page...

Continued from previous page...

Mol	Chain	Res	Type
22	A	46	G
22	A	51	G
22	A	60	G
22	A	61	C
22	A	62	U
22	A	63	A
22	A	71	A
22	A	74	A
22	A	75	G
22	A	91	A
22	A	96	C
22	A	101	A
22	A	102	U
22	A	110	G
22	A	118	A
22	A	119	A
22	A	120	U
22	A	125	A
22	A	139	U
22	A	140	C
22	A	141	G
22	A	142	A
22	A	162	U
22	A	181	A
22	A	196	A
22	A	197	A
22	A	199	A
22	A	204	A
22	A	215	G
22	A	216	A
22	A	221	A
22	A	222	A
22	A	233	A
22	A	241	A
22	A	248	G
22	A	249	C
22	A	255	A
22	A	266	G
22	A	276	U
22	A	279	A
22	A	281	C
22	A	285	G

Continued on next page...

Continued from previous page...

Mol	Chain	Res	Type
22	A	286	U
22	A	293	U
22	A	304	U
22	A	311	A
22	A	323	C
22	A	329	G
22	A	330	A
22	A	361	G
22	A	362	A
22	A	369	U
22	A	371	A
22	A	372	G
22	A	386	G
22	A	387	U
22	A	388	G
22	A	395	U
22	A	396	G
22	A	404	A
22	A	405	U
22	A	406	G
22	A	411	G
22	A	412	A
22	A	422	A
22	A	424	G
22	A	443	A
22	A	454	A
22	A	477	A
22	A	480	A
22	A	481	G
22	A	482	A
22	A	491	G
22	A	496	G
22	A	503	A
22	A	504	A
22	A	505	A
22	A	509	C
22	A	510	C
22	A	529	A
22	A	531	C
22	A	532	A
22	A	533	G
22	A	541	A

Continued on next page...

Continued from previous page...

Mol	Chain	Res	Type
22	A	542	C
22	A	544	C
22	A	545	U
22	A	546	U
22	A	547	A
22	A	550	C
22	A	556	A
22	A	557	C
22	A	563	A
22	A	568	U
22	A	573	U
22	A	575	A
22	A	577	G
22	A	592	A
22	A	603	A
22	A	613	A
22	A	614	A
22	A	615	U
22	A	616	A
22	A	627	A
22	A	637	A
22	A	645	C
22	A	646	U
22	A	647	G
22	A	653	U
22	A	654	A
22	A	655	A
22	A	656	G
22	A	664	G
22	A	677	A
22	A	685	A
22	A	686	U
22	A	695	G
22	A	711	G
22	A	717	C
22	A	730	A
22	A	747	5MC
22	A	757	G
22	A	765	C
22	A	774	G
22	A	775	G
22	A	776	G

Continued on next page...

Continued from previous page...

Mol	Chain	Res	Type
22	A	782	A
22	A	783	A
22	A	784	G
22	A	785	G
22	A	789	A
22	A	791	C
22	A	792	A
22	A	800	A
22	A	805	G
22	A	807	U
22	A	812	C
22	A	819	A
22	A	827	U
22	A	828	U
22	A	844	A
22	A	845	A
22	A	846	U
22	A	847	U
22	A	851	C
22	A	858	G
22	A	859	G
22	A	869	G
22	A	878	A
22	A	883	G
22	A	885	C
22	A	886	A
22	A	893	C
22	A	896	A
22	A	897	C
22	A	910	A
22	A	915	C
22	A	933	A
22	A	934	U
22	A	938	G
22	A	939	G
22	A	941	A
22	A	946	C
22	A	957	C
22	A	958	U
22	A	959	A
22	A	961	C
22	A	973	A

Continued on next page...

Continued from previous page...

Mol	Chain	Res	Type
22	A	974	G
22	A	983	A
22	A	984	A
22	A	989	G
22	A	990	A
22	A	995	C
22	A	996	A
22	A	999	U
22	A	1001	A
22	A	1003	G
22	A	1005	C
22	A	1009	A
22	A	1012	U
22	A	1013	C
22	A	1016	G
22	A	1025	G
22	A	1026	G
22	A	1033	U
22	A	1046	A
22	A	1047	G
22	A	1052	C
22	A	1053	C
22	A	1054	A
22	A	1055	G
22	A	1057	A
22	A	1060	U
22	A	1061	U
22	A	1062	G
22	A	1066	U
22	A	1067	A
22	A	1068	G
22	A	1069	A
22	A	1070	A
22	A	1071	G
22	A	1074	G
22	A	1075	C
22	A	1076	C
22	A	1081	U
22	A	1082	U
22	A	1084	A
22	A	1087	G
22	A	1088	A

Continued on next page...

Continued from previous page...

Mol	Chain	Res	Type
22	A	1097	U
22	A	1101	U
22	A	1103	A
22	A	1104	C
22	A	1106	G
22	A	1107	G
22	A	1111	A
22	A	1112	G
22	A	1119	U
22	A	1120	G
22	A	1122	G
22	A	1126	A
22	A	1130	U
22	A	1132	U
22	A	1133	A
22	A	1135	C
22	A	1136	G
22	A	1139	G
22	A	1142	A
22	A	1143	A
22	A	1151	A
22	A	1169	A
22	A	1172	C
22	A	1174	U
22	A	1175	A
22	A	1176	U
22	A	1178	C
22	A	1179	G
22	A	1180	U
22	A	1187	G
22	A	1190	G
22	A	1211	C
22	A	1212	G
22	A	1247	A
22	A	1248	G
22	A	1253	A
22	A	1255	U
22	A	1256	G
22	A	1269	A
22	A	1271	G
22	A	1272	A
22	A	1273	U

Continued on next page...

Continued from previous page...

Mol	Chain	Res	Type
22	A	1277	G
22	A	1286	A
22	A	1300	G
22	A	1301	A
22	A	1321	A
22	A	1325	U
22	A	1330	C
22	A	1341	G
22	A	1343	G
22	A	1345	C
22	A	1352	U
22	A	1359	A
22	A	1365	A
22	A	1368	G
22	A	1378	A
22	A	1379	U
22	A	1383	A
22	A	1403	A
22	A	1416	G
22	A	1419	A
22	A	1420	A
22	A	1421	G
22	A	1427	A
22	A	1428	C
22	A	1430	G
22	A	1437	C
22	A	1453	A
22	A	1459	G
22	A	1461	C
22	A	1482	G
22	A	1490	A
22	A	1491	G
22	A	1493	C
22	A	1494	A
22	A	1495	A
22	A	1497	U
22	A	1509	A
22	A	1515	A
22	A	1523	U
22	A	1524	G
22	A	1531	C
22	A	1532	A

Continued on next page...

Continued from previous page...

Mol	Chain	Res	Type
22	A	1534	U
22	A	1535	A
22	A	1536	C
22	A	1537	G
22	A	1544	A
22	A	1554	U
22	A	1560	G
22	A	1566	A
22	A	1569	A
22	A	1584	U
22	A	1585	C
22	A	1608	A
22	A	1610	A
22	A	1613	G
22	A	1627	G
22	A	1628	G
22	A	1647	U
22	A	1648	U
22	A	1654	A
22	A	1664	A
22	A	1665	A
22	A	1672	A
22	A	1674	G
22	A	1675	C
22	A	1698	A
22	A	1715	G
22	A	1729	U
22	A	1730	C
22	A	1733	G
22	A	1738	G
22	A	1744	A
22	A	1760	C
22	A	1764	C
22	A	1773	A
22	A	1780	A
22	A	1791	A
22	A	1800	C
22	A	1801	A
22	A	1802	A
22	A	1807	G
22	A	1808	A
22	A	1811	G

Continued on next page...

Continued from previous page...

Mol	Chain	Res	Type
22	A	1816	C
22	A	1819	A
22	A	1829	A
22	A	1835	2MG
22	A	1862	G
22	A	1870	C
22	A	1871	A
22	A	1872	A
22	A	1873	G
22	A	1876	A
22	A	1884	G
22	A	1900	A
22	A	1901	A
22	A	1906	G
22	A	1914	C
22	A	1929	G
22	A	1930	G
22	A	1931	U
22	A	1937	A
22	A	1939	5MU
22	A	1940	U
22	A	1941	C
22	A	1948	G
22	A	1955	U
22	A	1966	A
22	A	1967	C
22	A	1970	A
22	A	1971	U
22	A	1972	G
22	A	1977	A
22	A	1991	U
22	A	1993	U
22	A	1997	C
22	A	2018	G
22	A	2020	A
22	A	2022	U
22	A	2023	C
22	A	2031	A
22	A	2033	A
22	A	2034	U
22	A	2043	C
22	A	2055	C

Continued on next page...

Continued from previous page...

Mol	Chain	Res	Type
22	A	2056	G
22	A	2060	A
22	A	2061	G
22	A	2062	A
22	A	2063	C
22	A	2069	G7M
22	A	2072	C
22	A	2073	C
22	A	2077	A
22	A	2093	G
22	A	2096	C
22	A	2104	C
22	A	2105	U
22	A	2107	G
22	A	2108	A
22	A	2111	U
22	A	2112	G
22	A	2114	A
22	A	2115	G
22	A	2116	G
22	A	2118	U
22	A	2119	A
22	A	2121	G
22	A	2125	G
22	A	2126	A
22	A	2127	G
22	A	2128	G
22	A	2130	U
22	A	2131	U
22	A	2132	U
22	A	2133	G
22	A	2136	G
22	A	2137	U
22	A	2142	A
22	A	2143	C
22	A	2145	C
22	A	2146	C
22	A	2147	A
22	A	2156	G
22	A	2157	G
22	A	2158	A
22	A	2159	G

Continued on next page...

Continued from previous page...

Mol	Chain	Res	Type
22	A	2161	C
22	A	2164	C
22	A	2167	U
22	A	2168	G
22	A	2171	A
22	A	2172	U
22	A	2173	A
22	A	2176	A
22	A	2180	U
22	A	2182	U
22	A	2183	A
22	A	2184	A
22	A	2185	U
22	A	2186	G
22	A	2189	U
22	A	2190	G
22	A	2192	U
22	A	2198	A
22	A	2204	G
22	A	2211	A
22	A	2212	A
22	A	2225	A
22	A	2226	C
22	A	2238	G
22	A	2239	G
22	A	2250	G
22	A	2259	U
22	A	2266	A
22	A	2273	A
22	A	2278	A
22	A	2279	G
22	A	2283	C
22	A	2287	A
22	A	2288	A
22	A	2300	C
22	A	2301	C
22	A	2303	G
22	A	2305	U
22	A	2309	A
22	A	2313	C
22	A	2319	G
22	A	2321	U

Continued on next page...

Continued from previous page...

Mol	Chain	Res	Type
22	A	2325	G
22	A	2327	A
22	A	2333	A
22	A	2334	U
22	A	2335	A
22	A	2345	G
22	A	2347	C
22	A	2350	C
22	A	2354	C
22	A	2358	A
22	A	2361	G
22	A	2383	G
22	A	2384	U
22	A	2385	C
22	A	2389	G
22	A	2391	G
22	A	2392	A
22	A	2402	U
22	A	2403	C
22	A	2405	G
22	A	2406	A
22	A	2407	A
22	A	2410	G
22	A	2422	C
22	A	2424	C
22	A	2425	A
22	A	2428	G
22	A	2429	G
22	A	2430	A
22	A	2431	U
22	A	2435	A
22	A	2440	C
22	A	2441	U
22	A	2445	2MG
22	A	2447	G
22	A	2448	A
22	A	2475	C
22	A	2476	A
22	A	2494	G
22	A	2502	G
22	A	2504	PSU
22	A	2505	G

Continued on next page...

Continued from previous page...

Mol	Chain	Res	Type
22	A	2518	A
22	A	2520	C
22	A	2529	G
22	A	2542	A
22	A	2547	A
22	A	2554	U
22	A	2556	C
22	A	2564	A
22	A	2566	A
22	A	2567	G
22	A	2572	A
22	A	2573	C
22	A	2576	G
22	A	2585	U
22	A	2586	U
22	A	2599	G
22	A	2601	C
22	A	2602	A
22	A	2603	G
22	A	2609	U
22	A	2610	C
22	A	2613	U
22	A	2615	U
22	A	2629	U
22	A	2630	G
22	A	2634	A
22	A	2655	G
22	A	2656	U
22	A	2661	G
22	A	2685	G
22	A	2689	U
22	A	2690	U
22	A	2707	U
22	A	2714	G
22	A	2716	C
22	A	2726	A
22	A	2727	A
22	A	2732	G
22	A	2733	A
22	A	2739	U
22	A	2744	G
22	A	2748	A

Continued on next page...

Continued from previous page...

Mol	Chain	Res	Type
22	A	2752	C
22	A	2764	A
22	A	2765	A
22	A	2778	A
22	A	2779	U
22	A	2790	U
22	A	2791	G
22	A	2793	C
22	A	2794	C
22	A	2797	U
22	A	2798	U
22	A	2800	A
22	A	2809	A
22	A	2818	U
22	A	2820	A
22	A	2821	A
22	A	2823	A
22	A	2826	A
22	A	2832	U
22	A	2833	U
22	A	2835	A
22	A	2848	G
22	A	2861	U
22	A	2866	U
22	A	2867	G
22	A	2873	A
22	A	2880	C
22	A	2881	U
22	A	2883	A
22	A	2884	U
22	A	2891	U
22	A	2893	A
22	A	2901	C
23	B	3	C
23	B	4	C
23	B	9	G
23	B	13	G
23	B	16	G
23	B	26	C
23	B	32	U
23	B	35	C
23	B	39	A

Continued on next page...

Continued from previous page...

Mol	Chain	Res	Type
23	B	42	C
23	B	44	G
23	B	45	A
23	B	51	G
23	B	67	G
23	B	87	U
23	B	88	C
23	B	89	U
23	B	90	C
23	B	108	A
23	B	109	A
23	B	119	A
23	B	120	A
55	9	3	G
55	9	4	U
55	9	5	G
55	9	6	A
55	9	9	G
55	9	16	C
55	9	17	C
55	9	18	G
55	9	19	G
55	9	20	U
55	9	21	A
55	9	33	U
55	9	41	A
55	9	42	A
55	9	43	G
55	9	46	G
55	9	47	U
55	9	48	C
55	9	49	G
55	9	52	G
55	9	53	G
55	9	54	U
55	9	56	C
55	9	57	G
55	9	59	A
55	9	62	C
55	9	69	A
55	9	76	A

All (36) RNA pucker outliers are listed below:

Mol	Chain	Res	Type
22	A	86	G
22	A	421	C
22	A	481	G
22	A	546	U
22	A	549	G
22	A	555	G
22	A	784	G
22	A	1070	A
22	A	1103	A
22	A	1111	A
22	A	1182	G
22	A	1183	U
22	A	1300	G
22	A	1358	G
22	A	1399	C
22	A	1452	G
22	A	1490	A
22	A	1493	C
22	A	1626	A
22	A	1663	G
22	A	1900	A
22	A	1930	G
22	A	1940	U
22	A	2326	C
22	A	2391	G
22	A	2402	U
22	A	2474	U
22	A	2655	G
22	A	2808	G
22	A	2820	A
22	A	2832	U
23	B	12	C
23	B	66	A
55	9	2	G
55	9	3	G
55	9	41	A

5.4 Non-standard residues in protein, DNA, RNA chains [i](#)

36 non-standard protein/DNA/RNA residues are modelled in this entry.

In the following table, the Counts columns list the number of bonds (or angles) for which Mogul statistics could be retrieved, the number of bonds (or angles) that are observed in the model and the number of bonds (or angles) that are defined in the Chemical Component Dictionary. The

Link column lists molecule types, if any, to which the group is linked. The Z score for a bond length (or angle) is the number of standard deviations the observed value is removed from the expected value. A bond length (or angle) with $|Z| > 2$ is considered an outlier worth inspection. RMSZ is the root-mean-square of all Z scores of the bond lengths (or angles).

Mol	Type	Chain	Res	Link	Bond lengths			Bond angles		
					Counts	RMSZ	# Z > 2	Counts	RMSZ	# Z > 2
22	PSU	A	955	22	18,21,22	1.13	1 (5%)	22,30,33	1.87	4 (18%)
22	6MZ	A	1618	22	18,25,26	2.09	2 (11%)	16,36,39	2.20	4 (25%)
1	MA6	a	1519	1	19,26,27	1.39	4 (21%)	18,38,41	4.32	2 (11%)
22	PSU	A	2605	22	18,21,22	1.13	3 (16%)	22,30,33	1.75	4 (18%)
22	6MZ	A	2030	22	18,25,26	2.10	3 (16%)	16,36,39	2.88	5 (31%)
1	2MG	a	1516	1	18,26,27	2.60	7 (38%)	16,38,41	1.33	3 (18%)
22	PSU	A	746	22	18,21,22	1.04	3 (16%)	22,30,33	1.56	3 (13%)
22	H2U	A	2449	22	18,21,22	1.48	3 (16%)	21,30,33	1.94	3 (14%)
22	PSU	A	1917	22	18,21,22	1.08	2 (11%)	22,30,33	1.91	5 (22%)
22	5MC	A	747	22	18,22,23	3.58	7 (38%)	26,32,35	1.14	1 (3%)
1	4OC	a	1402	1	20,23,24	2.99	8 (40%)	26,32,35	0.86	1 (3%)
22	OMU	A	2552	22	19,22,23	2.75	7 (36%)	26,31,34	1.79	5 (19%)
22	2MA	A	2503	22	17,25,26	2.30	4 (23%)	17,37,40	1.46	4 (23%)
1	5MC	a	1407	1	18,22,23	3.62	7 (38%)	26,32,35	1.04	3 (11%)
22	PSU	A	2604	22	18,21,22	1.10	2 (11%)	22,30,33	1.73	4 (18%)
1	G7M	a	1405	1	20,26,27	3.83	9 (45%)	17,39,42	1.12	1 (5%)
22	PSU	A	2457	22	18,21,22	1.12	2 (11%)	22,30,33	2.05	5 (22%)
22	1MG	A	745	22	18,26,27	2.53	5 (27%)	19,39,42	1.58	4 (21%)
22	PSU	A	2580	22	18,21,22	1.13	2 (11%)	22,30,33	1.86	5 (22%)
1	2MG	a	966	1	18,26,27	2.59	7 (38%)	16,38,41	1.53	4 (25%)
22	5MU	A	1939	22	19,22,23	4.69	7 (36%)	28,32,35	4.00	10 (35%)
1	PSU	a	516	1	18,21,22	1.00	3 (16%)	22,30,33	1.69	5 (22%)
1	2MG	a	1207	1	18,26,27	2.65	7 (38%)	16,38,41	1.59	4 (25%)
22	OMG	A	2251	22,55	18,26,27	2.36	8 (44%)	19,38,41	1.50	4 (21%)
22	2MG	A	1835	22	18,26,27	2.57	7 (38%)	16,38,41	1.62	4 (25%)
22	3TD	A	1915	22	18,22,23	4.09	7 (38%)	22,32,35	1.62	3 (13%)
1	G7M	a	527	1	20,26,27	4.04	9 (45%)	17,39,42	1.01	1 (5%)
22	G7M	A	2069	22	20,26,27	3.91	8 (40%)	17,39,42	1.05	1 (5%)
22	PSU	A	2504	22	18,21,22	1.11	2 (11%)	22,30,33	1.95	4 (18%)
1	UR3	a	1498	1	19,22,23	2.83	7 (36%)	26,32,35	1.34	2 (7%)
1	MA6	a	1518	1	19,26,27	1.23	2 (10%)	18,38,41	4.98	2 (11%)

Mol	Type	Chain	Res	Link	Bond lengths			Bond angles		
					Counts	RMSZ	# Z > 2	Counts	RMSZ	# Z > 2
22	PSU	A	1911	22	18,21,22	1.04	2 (11%)	22,30,33	1.89	4 (18%)
1	5MC	a	967	1	18,22,23	3.76	7 (38%)	26,32,35	0.98	1 (3%)
22	OMC	A	2498	22	19,22,23	2.96	8 (42%)	26,31,34	0.83	1 (3%)
22	2MG	A	2445	22	18,26,27	2.53	7 (38%)	16,38,41	1.65	4 (25%)
22	5MC	A	1962	22	18,22,23	3.56	7 (38%)	26,32,35	1.26	3 (11%)

In the following table, the Chirals column lists the number of chiral outliers, the number of chiral centers analysed, the number of these observed in the model and the number defined in the Chemical Component Dictionary. Similar counts are reported in the Torsion and Rings columns. '-' means no outliers of that kind were identified.

Mol	Type	Chain	Res	Link	Chirals	Torsions	Rings
22	PSU	A	955	22	-	0/7/25/26	0/2/2/2
22	6MZ	A	1618	22	-	0/5/27/28	0/3/3/3
1	MA6	a	1519	1	-	1/7/29/30	0/3/3/3
22	PSU	A	2605	22	-	0/7/25/26	0/2/2/2
22	6MZ	A	2030	22	-	3/5/27/28	0/3/3/3
1	2MG	a	1516	1	-	0/5/27/28	0/3/3/3
22	PSU	A	746	22	-	1/7/25/26	0/2/2/2
22	H2U	A	2449	22	-	0/7/38/39	0/2/2/2
22	PSU	A	1917	22	-	2/7/25/26	0/2/2/2
22	5MC	A	747	22	-	1/7/25/26	0/2/2/2
1	4OC	a	1402	1	-	2/9/29/30	0/2/2/2
22	OMU	A	2552	22	-	4/9/27/28	0/2/2/2
22	2MA	A	2503	22	-	2/3/25/26	0/3/3/3
1	5MC	a	1407	1	-	0/7/25/26	0/2/2/2
22	PSU	A	2604	22	-	0/7/25/26	0/2/2/2
1	G7M	a	1405	1	-	0/3/25/26	0/3/3/3
22	PSU	A	2457	22	-	0/7/25/26	0/2/2/2
22	1MG	A	745	22	-	0/3/25/26	0/3/3/3
22	PSU	A	2580	22	-	0/7/25/26	0/2/2/2
1	2MG	a	966	1	-	2/5/27/28	0/3/3/3
22	5MU	A	1939	22	-	2/7/25/26	0/2/2/2
1	PSU	a	516	1	-	0/7/25/26	0/2/2/2
1	2MG	a	1207	1	-	0/5/27/28	0/3/3/3
22	OMG	A	2251	22,55	-	1/5/27/28	0/3/3/3
22	2MG	A	1835	22	-	2/5/27/28	0/3/3/3
22	3TD	A	1915	22	-	5/7/25/26	0/2/2/2
1	G7M	a	527	1	-	2/3/25/26	0/3/3/3

Continued on next page...

Continued from previous page...

Mol	Type	Chain	Res	Link	Chirals	Torsions	Rings
22	G7M	A	2069	22	-	2/3/25/26	0/3/3/3
22	PSU	A	2504	22	-	2/7/25/26	0/2/2/2
1	UR3	a	1498	1	-	2/7/25/26	0/2/2/2
1	MA6	a	1518	1	-	5/7/29/30	0/3/3/3
22	PSU	A	1911	22	-	2/7/25/26	0/2/2/2
1	5MC	a	967	1	-	2/7/25/26	0/2/2/2
22	OMC	A	2498	22	-	1/9/27/28	0/2/2/2
22	2MG	A	2445	22	-	2/5/27/28	0/3/3/3
22	5MC	A	1962	22	-	0/7/25/26	0/2/2/2

All (186) bond length outliers are listed below:

Mol	Chain	Res	Type	Atoms	Z	Observed(Å)	Ideal(Å)
22	A	1915	3TD	C6-C5	12.01	1.49	1.35
1	a	527	G7M	C8-N7	10.31	1.51	1.33
22	A	1939	5MU	C2-N1	10.15	1.54	1.38
22	A	2069	G7M	C8-N7	10.05	1.51	1.33
22	A	1939	5MU	C6-N1	10.04	1.55	1.38
1	a	1405	G7M	C8-N7	9.74	1.50	1.33
1	a	967	5MC	C6-C5	9.72	1.50	1.34
22	A	1939	5MU	C4-C5	9.68	1.60	1.44
22	A	747	5MC	C6-C5	9.50	1.50	1.34
1	a	527	G7M	C8-N9	9.36	1.50	1.33
22	A	2069	G7M	C8-N9	9.28	1.50	1.33
1	a	1407	5MC	C6-C5	9.22	1.49	1.34
1	a	1405	G7M	C8-N9	9.09	1.49	1.33
22	A	1915	3TD	C2-N1	8.94	1.48	1.37
22	A	1962	5MC	C6-C5	8.83	1.49	1.34
22	A	1939	5MU	C4-N3	-7.93	1.24	1.38
22	A	1618	6MZ	C6-N6	7.27	1.46	1.35
1	a	1498	UR3	C2-N1	7.06	1.48	1.38
22	A	2503	2MA	C2-N3	6.97	1.46	1.31
1	a	1498	UR3	C6-C5	6.94	1.51	1.35
22	A	2030	6MZ	C6-N6	6.73	1.46	1.35
1	a	967	5MC	C4-N3	6.71	1.45	1.34
22	A	1962	5MC	C4-N3	6.70	1.45	1.34
1	a	1402	4OC	C4-N3	6.64	1.44	1.32
1	a	1407	5MC	C4-N3	6.49	1.45	1.34
1	a	967	5MC	C2-N3	6.38	1.49	1.36
22	A	1962	5MC	C2-N3	6.20	1.48	1.36
22	A	2552	OMU	C2-N3	6.19	1.49	1.38

Continued on next page...

Continued from previous page...

Mol	Chain	Res	Type	Atoms	Z	Observed(Å)	Ideal(Å)
22	A	1939	5MU	C6-C5	6.19	1.44	1.34
1	a	1407	5MC	C2-N3	6.13	1.48	1.36
1	a	1402	4OC	C6-C5	6.09	1.49	1.35
22	A	745	1MG	C2-N2	5.95	1.45	1.34
22	A	747	5MC	C2-N3	5.95	1.48	1.36
22	A	2498	OMC	C6-C5	5.90	1.48	1.35
22	A	747	5MC	C4-N3	5.89	1.44	1.34
22	A	2552	OMU	C2-N1	5.78	1.47	1.38
22	A	745	1MG	C2-N3	5.77	1.45	1.34
22	A	1915	3TD	C6-N1	5.70	1.45	1.36
1	a	1405	G7M	C2-N3	5.59	1.46	1.33
1	a	527	G7M	C2-N3	5.58	1.46	1.33
1	a	1402	4OC	C2-N3	5.57	1.47	1.36
22	A	2498	OMC	C4-N4	5.52	1.46	1.33
1	a	966	2MG	C2-N1	5.43	1.45	1.36
22	A	2552	OMU	C6-C5	5.42	1.47	1.35
1	a	1207	2MG	C2-N1	5.38	1.45	1.36
1	a	1516	2MG	C2-N1	5.35	1.45	1.36
22	A	2498	OMC	C2-N3	5.33	1.47	1.36
1	a	1207	2MG	C2-N2	5.30	1.45	1.33
22	A	2498	OMC	C4-N3	5.20	1.45	1.34
1	a	1516	2MG	C2-N2	5.18	1.44	1.33
22	A	1835	2MG	C2-N1	5.15	1.45	1.36
22	A	2445	2MG	C2-N1	5.15	1.45	1.36
22	A	1835	2MG	C4-N3	5.12	1.49	1.37
1	a	966	2MG	C2-N2	5.11	1.44	1.33
22	A	2069	G7M	C2-N3	5.08	1.45	1.33
22	A	1835	2MG	C2-N2	5.02	1.44	1.33
1	a	966	2MG	C4-N3	4.98	1.49	1.37
1	a	967	5MC	C4-N4	4.98	1.47	1.34
1	a	1207	2MG	C4-N3	4.97	1.49	1.37
1	a	1407	5MC	C4-N4	4.97	1.47	1.34
22	A	1962	5MC	C4-N4	4.93	1.46	1.34
1	a	1498	UR3	C2-N3	4.92	1.48	1.39
22	A	2251	OMG	C2-N3	4.85	1.45	1.33
22	A	2445	2MG	C4-N3	4.81	1.49	1.37
22	A	747	5MC	C4-N4	4.72	1.46	1.34
1	a	527	G7M	C2-N2	4.66	1.45	1.34
1	a	527	G7M	C6-N1	4.61	1.44	1.37
22	A	2069	G7M	C2-N2	4.58	1.45	1.34
1	a	1516	2MG	C4-N3	4.57	1.48	1.37
1	a	967	5MC	C6-N1	4.57	1.45	1.38

Continued on next page...

Continued from previous page...

Mol	Chain	Res	Type	Atoms	Z	Observed(Å)	Ideal(Å)
22	A	2445	2MG	C2-N2	4.54	1.43	1.33
22	A	745	1MG	C4-N3	4.48	1.48	1.37
22	A	2251	OMG	C4-N3	4.42	1.48	1.37
22	A	1915	3TD	C2-N3	4.41	1.48	1.38
22	A	747	5MC	C6-N1	4.38	1.45	1.38
22	A	2503	2MA	C4-N3	4.38	1.48	1.37
1	a	527	G7M	C4-N3	4.30	1.47	1.37
1	a	1407	5MC	C6-N1	4.29	1.45	1.38
1	a	1405	G7M	C2-N2	4.28	1.44	1.34
22	A	2251	OMG	C2-N2	4.28	1.44	1.34
1	a	1402	4OC	C4-N4	4.28	1.44	1.35
1	a	967	5MC	C2-N1	4.11	1.48	1.40
1	a	1405	G7M	C4-N3	4.05	1.47	1.37
22	A	2069	G7M	C6-N1	4.01	1.43	1.37
22	A	1962	5MC	C6-N1	3.99	1.44	1.38
22	A	2069	G7M	C4-N3	3.95	1.46	1.37
1	a	1207	2MG	C6-N1	3.94	1.43	1.37
1	a	527	G7M	C2-N1	3.87	1.47	1.37
22	A	2498	OMC	O2-C2	-3.82	1.16	1.23
22	A	2498	OMC	C2-N1	3.81	1.48	1.40
22	A	2069	G7M	O6-C6	-3.78	1.15	1.23
22	A	1962	5MC	C2-N1	3.78	1.48	1.40
1	a	1405	G7M	C6-N1	3.74	1.43	1.37
1	a	966	2MG	C6-N1	3.73	1.43	1.37
1	a	1407	5MC	C2-N1	3.71	1.48	1.40
22	A	747	5MC	C2-N1	3.68	1.48	1.40
1	a	1516	2MG	C5-C6	3.67	1.54	1.47
22	A	1835	2MG	C6-N1	3.67	1.43	1.37
1	a	1402	4OC	C5-C4	3.66	1.48	1.40
22	A	2069	G7M	C2-N1	3.62	1.46	1.37
1	a	1402	4OC	O2-C2	-3.58	1.17	1.23
1	a	1516	2MG	C6-N1	3.50	1.43	1.37
22	A	2449	H2U	C2-N1	-3.48	1.30	1.35
22	A	745	1MG	C5-C4	-3.42	1.34	1.43
1	a	1405	G7M	C2-N1	3.41	1.46	1.37
22	A	2445	2MG	C6-N1	3.35	1.42	1.37
1	a	1405	G7M	O6-C6	-3.34	1.16	1.23
1	a	527	G7M	O6-C6	-3.33	1.16	1.23
1	a	1207	2MG	C5-C6	3.33	1.54	1.47
1	a	966	2MG	C5-C6	3.33	1.54	1.47
22	A	747	5MC	O2-C2	-3.32	1.17	1.23
22	A	2449	H2U	C2-N3	-3.27	1.32	1.38

Continued on next page...

Continued from previous page...

Mol	Chain	Res	Type	Atoms	Z	Observed(Å)	Ideal(Å)
22	A	2251	OMG	C5-C4	-3.26	1.34	1.43
22	A	2552	OMU	O4-C4	-3.23	1.18	1.24
1	a	1402	4OC	C2-N1	3.19	1.46	1.40
22	A	2449	H2U	C4-N3	-3.19	1.32	1.37
1	a	1498	UR3	O4-C4	-3.18	1.16	1.23
22	A	2552	OMU	O2-C2	-3.16	1.17	1.23
22	A	2445	2MG	CM2-N2	-3.12	1.40	1.45
22	A	2030	6MZ	C5-C4	-3.12	1.32	1.40
22	A	2503	2MA	C5-C4	-3.12	1.35	1.43
1	a	1519	MA6	C5-C4	-3.09	1.32	1.40
22	A	2552	OMU	C4-N3	3.09	1.44	1.38
1	a	1407	5MC	O2-C2	-3.08	1.18	1.23
22	A	2498	OMC	C6-N1	3.06	1.45	1.38
22	A	1962	5MC	O2-C2	-3.05	1.18	1.23
22	A	1835	2MG	C5-C6	2.98	1.53	1.47
1	a	1402	4OC	C6-N1	2.96	1.45	1.38
22	A	2251	OMG	C6-N1	2.96	1.42	1.37
22	A	1618	6MZ	C5-C4	-2.87	1.33	1.40
22	A	1911	PSU	C6-C5	2.85	1.38	1.35
22	A	1915	3TD	O2-C2	-2.80	1.17	1.23
22	A	2445	2MG	C5-C4	-2.78	1.36	1.43
1	a	967	5MC	O2-C2	-2.74	1.18	1.23
22	A	2605	PSU	C4-C5	-2.73	1.36	1.44
22	A	1835	2MG	C5-C4	-2.72	1.36	1.43
1	a	1518	MA6	C5-C4	-2.70	1.33	1.40
22	A	2445	2MG	C5-C6	2.70	1.52	1.47
22	A	1917	PSU	C6-C5	2.68	1.38	1.35
22	A	1939	5MU	O4-C4	-2.68	1.18	1.23
1	a	527	G7M	C5-C6	2.64	1.52	1.45
22	A	1915	3TD	C4-N3	2.63	1.46	1.40
22	A	2504	PSU	C4-C5	-2.62	1.36	1.44
22	A	1939	5MU	O2-C2	-2.62	1.18	1.23
1	a	1516	2MG	C5-C4	-2.57	1.36	1.43
1	a	1405	G7M	C5-C6	2.55	1.52	1.45
1	a	1207	2MG	CM2-N2	-2.52	1.41	1.45
22	A	2251	OMG	O6-C6	-2.50	1.18	1.23
1	a	1516	2MG	CM2-N2	-2.50	1.41	1.45
22	A	955	PSU	C4-C5	-2.50	1.37	1.44
22	A	2457	PSU	O4'-C1'	-2.48	1.40	1.43
22	A	2580	PSU	O4'-C1'	-2.48	1.40	1.43
22	A	1835	2MG	CM2-N2	-2.45	1.41	1.45
1	a	516	PSU	C6-C5	2.44	1.38	1.35

Continued on next page...

Continued from previous page...

Mol	Chain	Res	Type	Atoms	Z	Observed(Å)	Ideal(Å)
22	A	2552	OMU	C6-N1	2.43	1.43	1.38
22	A	2030	6MZ	C6-N1	-2.43	1.30	1.34
22	A	2580	PSU	C4-C5	-2.38	1.37	1.44
1	a	966	2MG	C5-C4	-2.38	1.37	1.43
22	A	2503	2MA	C2-N1	2.36	1.43	1.36
1	a	1207	2MG	C5-C4	-2.36	1.37	1.43
22	A	1917	PSU	C4-C5	-2.34	1.37	1.44
22	A	2251	OMG	C2-N1	2.31	1.43	1.37
1	a	1519	MA6	C5-N7	-2.31	1.31	1.39
22	A	746	PSU	C6-C5	2.29	1.38	1.35
1	a	966	2MG	CM2-N2	-2.29	1.41	1.45
22	A	2504	PSU	C6-C5	2.26	1.38	1.35
22	A	2605	PSU	C6-C5	2.26	1.38	1.35
22	A	2604	PSU	C6-C5	2.25	1.37	1.35
22	A	745	1MG	O6-C6	-2.24	1.18	1.22
1	a	1498	UR3	O2-C2	-2.23	1.18	1.22
22	A	746	PSU	C4-C5	-2.23	1.37	1.44
1	a	1519	MA6	C8-N7	-2.19	1.30	1.34
22	A	2457	PSU	C4-C5	-2.17	1.38	1.44
1	a	516	PSU	O4'-C1'	-2.13	1.40	1.43
1	a	1498	UR3	C6-N1	2.12	1.43	1.38
1	a	1498	UR3	C5-C4	2.12	1.49	1.43
1	a	1518	MA6	C5-N7	-2.11	1.32	1.39
22	A	746	PSU	O4'-C1'	-2.09	1.40	1.43
22	A	2604	PSU	C4-C5	-2.07	1.38	1.44
1	a	516	PSU	C4-C5	-2.07	1.38	1.44
22	A	2498	OMC	C5-C4	2.07	1.47	1.42
22	A	1915	3TD	O4-C4	-2.05	1.18	1.23
22	A	1911	PSU	C4-C5	-2.03	1.38	1.44
1	a	1519	MA6	C2-N3	2.03	1.35	1.32
22	A	2251	OMG	C5-C6	2.01	1.51	1.47
22	A	2605	PSU	O4'-C1'	-2.01	1.41	1.43

All (123) bond angle outliers are listed below:

Mol	Chain	Res	Type	Atoms	Z	Observed(°)	Ideal(°)
1	a	1518	MA6	N1-C6-N6	-20.28	95.71	117.06
1	a	1519	MA6	N1-C6-N6	-17.46	98.68	117.06
22	A	1939	5MU	C5-C4-N3	13.04	126.44	115.31
22	A	1939	5MU	C5-C6-N1	-11.53	111.48	123.34
22	A	2030	6MZ	C9-N6-C6	-9.01	115.12	122.87
22	A	2449	H2U	C4-N3-C2	-7.59	119.49	125.79

Continued on next page...

Continued from previous page...

Mol	Chain	Res	Type	Atoms	Z	Observed(°)	Ideal(°)
22	A	1939	5MU	C4-N3-C2	-5.91	119.71	127.35
22	A	1618	6MZ	C9-N6-C6	-5.49	118.14	122.87
1	a	1518	MA6	N3-C2-N1	-5.36	120.31	128.68
22	A	2552	OMU	C4-N3-C2	-5.35	119.52	126.58
22	A	2457	PSU	N1-C2-N3	5.32	121.15	115.13
22	A	1618	6MZ	N3-C2-N1	-5.31	120.38	128.68
22	A	1915	3TD	N1-C2-N3	5.23	120.27	116.14
1	a	1519	MA6	N3-C2-N1	-5.21	120.54	128.68
22	A	2030	6MZ	N3-C2-N1	-5.20	120.56	128.68
22	A	2457	PSU	C4-N3-C2	-5.15	118.91	126.34
1	a	1498	UR3	C4-N3-C2	-5.10	119.76	124.56
22	A	1939	5MU	N3-C2-N1	5.03	121.57	114.89
22	A	2605	PSU	C4-N3-C2	-5.00	119.13	126.34
22	A	1911	PSU	C4-N3-C2	-5.00	119.14	126.34
22	A	955	PSU	C4-N3-C2	-4.96	119.19	126.34
22	A	1917	PSU	C4-N3-C2	-4.93	119.23	126.34
22	A	2580	PSU	N1-C2-N3	4.73	120.49	115.13
22	A	1911	PSU	N1-C2-N3	4.73	120.48	115.13
22	A	2504	PSU	N1-C2-N3	4.70	120.45	115.13
22	A	2552	OMU	N3-C2-N1	4.68	121.10	114.89
22	A	1917	PSU	N1-C2-N3	4.66	120.41	115.13
22	A	1939	5MU	O4-C4-C5	-4.65	119.51	124.90
22	A	746	PSU	C4-N3-C2	-4.64	119.65	126.34
22	A	955	PSU	N1-C2-N3	4.59	120.33	115.13
22	A	2580	PSU	C4-N3-C2	-4.57	119.75	126.34
22	A	745	1MG	C5-C6-N1	4.49	120.66	113.90
22	A	2604	PSU	C4-N3-C2	-4.47	119.91	126.34
22	A	2604	PSU	N1-C2-N3	4.42	120.14	115.13
22	A	2504	PSU	C4-N3-C2	-4.39	120.01	126.34
22	A	2504	PSU	O2-C2-N1	-4.23	118.13	122.79
1	a	516	PSU	C4-N3-C2	-4.19	120.30	126.34
22	A	2445	2MG	CM2-N2-C2	-4.01	115.00	123.86
22	A	747	5MC	C5-C6-N1	-3.99	119.23	123.34
22	A	2503	2MA	C5-C6-N1	3.96	120.85	114.02
22	A	1835	2MG	C5-C6-N1	3.93	120.88	113.95
1	a	516	PSU	N1-C2-N3	3.91	119.56	115.13
22	A	1915	3TD	C4-N3-C2	-3.89	120.39	124.61
22	A	1939	5MU	O2-C2-N1	-3.83	117.69	122.79
22	A	2605	PSU	N1-C2-N3	3.82	119.46	115.13
22	A	1939	5MU	C5M-C5-C6	-3.68	117.94	122.85
22	A	2504	PSU	C6-N1-C2	-3.65	118.95	122.68
1	a	1207	2MG	C5-C6-N1	3.61	120.32	113.95

Continued on next page...

Continued from previous page...

Mol	Chain	Res	Type	Atoms	Z	Observed(°)	Ideal(°)
1	a	966	2MG	C5-C6-N1	3.58	120.27	113.95
22	A	746	PSU	N1-C2-N3	3.48	119.08	115.13
1	a	1405	G7M	C2-N1-C6	-3.41	118.82	125.10
22	A	2251	OMG	C5-C6-N1	3.39	119.95	113.95
22	A	1962	5MC	C5-C6-N1	-3.38	119.86	123.34
22	A	2445	2MG	C5-C6-N1	3.36	119.88	113.95
1	a	1207	2MG	CM2-N2-C2	-3.29	116.59	123.86
1	a	516	PSU	O2-C2-N1	-3.25	119.21	122.79
22	A	1939	5MU	C5M-C5-C4	3.25	122.34	118.77
22	A	1939	5MU	O4-C4-N3	-3.17	114.05	120.12
22	A	2580	PSU	C6-N1-C2	-3.14	119.47	122.68
22	A	2552	OMU	C5-C4-N3	3.13	119.52	114.84
22	A	1911	PSU	O2-C2-N1	-3.12	119.35	122.79
1	a	967	5MC	C5-C6-N1	-3.09	120.16	123.34
22	A	2457	PSU	O2-C2-N1	-3.09	119.39	122.79
22	A	2251	OMG	C2-N1-C6	-3.01	119.56	125.10
1	a	527	G7M	C2-N1-C6	-2.95	119.67	125.10
1	a	1516	2MG	C5-C6-N1	2.93	119.13	113.95
22	A	1835	2MG	O6-C6-C5	-2.93	118.66	124.37
22	A	2030	6MZ	C2-N1-C6	2.85	119.04	116.59
1	a	966	2MG	CM2-N2-C2	-2.82	117.62	123.86
22	A	1618	6MZ	C2-N1-C6	2.82	119.01	116.59
22	A	2030	6MZ	C1'-N9-C4	-2.81	121.70	126.64
1	a	1407	5MC	C5-C6-N1	-2.77	120.49	123.34
22	A	1917	PSU	O2-C2-N1	-2.77	119.74	122.79
22	A	745	1MG	C8-N7-C5	2.76	108.24	102.99
22	A	955	PSU	O2-C2-N1	-2.76	119.76	122.79
22	A	2445	2MG	C8-N7-C5	2.75	108.23	102.99
22	A	2069	G7M	C2-N1-C6	-2.73	120.07	125.10
22	A	2457	PSU	C6-N1-C2	-2.67	119.95	122.68
22	A	2503	2MA	C8-N7-C5	2.67	108.08	102.99
1	a	1516	2MG	C8-N7-C5	2.65	108.03	102.99
22	A	2604	PSU	O2-C2-N1	-2.64	119.88	122.79
1	a	1407	5MC	CM5-C5-C6	-2.62	119.35	122.85
1	a	1207	2MG	O6-C6-C5	-2.59	119.31	124.37
22	A	2449	H2U	C5-C6-N1	-2.58	103.12	111.61
22	A	955	PSU	C6-N1-C2	-2.58	120.05	122.68
22	A	1835	2MG	C8-N7-C5	2.58	107.90	102.99
22	A	2580	PSU	O2-C2-N1	-2.54	120.00	122.79
1	a	966	2MG	O6-C6-C5	-2.53	119.43	124.37
22	A	2457	PSU	C6-C5-C4	2.51	119.95	118.20
1	a	966	2MG	C8-N7-C5	2.49	107.74	102.99

Continued on next page...

Continued from previous page...

Mol	Chain	Res	Type	Atoms	Z	Observed(°)	Ideal(°)
22	A	1962	5MC	C1'-N1-C6	-2.49	116.98	121.12
22	A	1618	6MZ	C1'-N9-C4	-2.47	122.31	126.64
22	A	2251	OMG	C8-N7-C5	2.46	107.68	102.99
22	A	2552	OMU	O4-C4-C5	-2.45	120.85	125.16
22	A	1835	2MG	CM2-N2-C2	-2.45	118.46	123.86
22	A	2445	2MG	O6-C6-C5	-2.43	119.63	124.37
22	A	2605	PSU	O4-C4-C5	-2.43	117.70	124.05
22	A	2605	PSU	C5-C4-N3	2.38	121.96	116.58
22	A	2251	OMG	O6-C6-C5	-2.37	119.73	124.37
22	A	1917	PSU	C6-C5-C4	2.31	119.81	118.20
1	a	1207	2MG	C8-N7-C5	2.29	107.35	102.99
1	a	516	PSU	O4'-C1'-C2'	2.26	108.34	105.14
22	A	2503	2MA	N1-C2-N3	-2.26	119.31	123.06
22	A	745	1MG	O6-C6-C5	-2.26	120.19	124.19
22	A	1917	PSU	C6-N1-C2	-2.23	120.40	122.68
22	A	2604	PSU	C6-N1-C2	-2.23	120.41	122.68
22	A	1911	PSU	C6-N1-C2	-2.22	120.41	122.68
1	a	1407	5MC	C5-C4-N3	-2.22	119.28	121.67
22	A	2580	PSU	O4'-C1'-C2'	2.17	108.21	105.14
22	A	1962	5MC	CM5-C5-C6	-2.17	119.95	122.85
1	a	1516	2MG	CM2-N2-C2	-2.13	119.16	123.86
1	a	516	PSU	C6-N1-C2	-2.11	120.53	122.68
22	A	745	1MG	CM1-N1-C6	2.11	120.43	117.55
1	a	1402	4OC	CM4-N4-C4	-2.11	118.34	122.45
22	A	2449	H2U	O4-C4-N3	2.09	123.60	120.28
22	A	2030	6MZ	C4-C5-N7	-2.08	107.23	109.40
22	A	746	PSU	O2-C2-N1	-2.06	120.52	122.79
22	A	2503	2MA	CM2-C2-N1	2.05	120.80	116.23
22	A	2498	OMC	O2-C2-N3	-2.04	119.01	122.33
1	a	1498	UR3	C3U-N3-C4	2.04	120.80	117.89
22	A	1939	5MU	C6-C5-C4	2.02	119.72	118.03
22	A	2552	OMU	O2-C2-N1	-2.02	120.10	122.79
22	A	1915	3TD	O4'-C1'-C2'	2.02	107.99	105.14

There are no chirality outliers.

All (48) torsion outliers are listed below:

Mol	Chain	Res	Type	Atoms
1	a	967	5MC	O4'-C4'-C5'-O5'
1	a	1498	UR3	O4'-C1'-N1-C2
1	a	1518	MA6	C3'-C4'-C5'-O5'
1	a	1518	MA6	C5-C6-N6-C10

Continued on next page...

Continued from previous page...

Mol	Chain	Res	Type	Atoms
22	A	1915	3TD	O4'-C1'-C5-C4
22	A	1915	3TD	C2'-C1'-C5-C6
22	A	1915	3TD	O4'-C1'-C5-C6
22	A	1915	3TD	O4'-C4'-C5'-O5'
22	A	1939	5MU	O4'-C4'-C5'-O5'
22	A	2030	6MZ	N1-C6-N6-C9
22	A	2030	6MZ	O4'-C4'-C5'-O5'
22	A	2030	6MZ	C3'-C4'-C5'-O5'
22	A	2251	OMG	C1'-C2'-O2'-CM2
22	A	2445	2MG	O4'-C4'-C5'-O5'
22	A	2445	2MG	C3'-C4'-C5'-O5'
22	A	2503	2MA	O4'-C4'-C5'-O5'
22	A	2552	OMU	O4'-C1'-N1-C2
22	A	2552	OMU	O4'-C1'-N1-C6
1	a	1498	UR3	O4'-C1'-N1-C6
1	a	967	5MC	C3'-C4'-C5'-O5'
1	a	1402	4OC	O4'-C4'-C5'-O5'
1	a	1518	MA6	O4'-C4'-C5'-O5'
22	A	1915	3TD	C3'-C4'-C5'-O5'
22	A	1939	5MU	C3'-C4'-C5'-O5'
22	A	2504	PSU	O4'-C4'-C5'-O5'
1	a	1518	MA6	N1-C6-N6-C10
1	a	1402	4OC	C3'-C4'-C5'-O5'
22	A	1835	2MG	O4'-C4'-C5'-O5'
1	a	1518	MA6	C5-C6-N6-C9
1	a	966	2MG	C3'-C4'-C5'-O5'
22	A	1835	2MG	C3'-C4'-C5'-O5'
22	A	2069	G7M	O4'-C4'-C5'-O5'
1	a	1519	MA6	C4'-C5'-O5'-P
22	A	2503	2MA	C3'-C4'-C5'-O5'
22	A	747	5MC	C4'-C5'-O5'-P
22	A	2552	OMU	C3'-C4'-C5'-O5'
22	A	2552	OMU	O4'-C4'-C5'-O5'
1	a	527	G7M	C4'-C5'-O5'-P
22	A	2069	G7M	C3'-C4'-C5'-O5'
22	A	2504	PSU	C3'-C4'-C5'-O5'
22	A	1911	PSU	O4'-C1'-C5-C4
22	A	1917	PSU	O4'-C1'-C5-C4
1	a	966	2MG	O4'-C4'-C5'-O5'
22	A	746	PSU	O4'-C1'-C5-C6
22	A	1911	PSU	O4'-C1'-C5-C6
22	A	1917	PSU	O4'-C1'-C5-C6

Continued on next page...

Continued from previous page...

Mol	Chain	Res	Type	Atoms
22	A	2498	OMC	C4'-C5'-O5'-P
1	a	527	G7M	C3'-C4'-C5'-O5'

There are no ring outliers.

No monomer is involved in short contacts.

5.5 Carbohydrates [i](#)

There are no monosaccharides in this entry.

5.6 Ligand geometry [i](#)

2 ligands are modelled in this entry.

In the following table, the Counts columns list the number of bonds (or angles) for which Mogul statistics could be retrieved, the number of bonds (or angles) that are observed in the model and the number of bonds (or angles) that are defined in the Chemical Component Dictionary. The Link column lists molecule types, if any, to which the group is linked. The Z score for a bond length (or angle) is the number of standard deviations the observed value is removed from the expected value. A bond length (or angle) with $|Z| > 2$ is considered an outlier worth inspection. RMSZ is the root-mean-square of all Z scores of the bond lengths (or angles).

Mol	Type	Chain	Res	Link	Bond lengths			Bond angles		
					Counts	RMSZ	# Z > 2	Counts	RMSZ	# Z > 2
57	ILE	A	3001	-	6,7,8	0.51	0	5,8,10	1.69	2 (40%)
58	PRO	9	101	55	5,7,8	0.60	0	7,8,10	2.00	1 (14%)

In the following table, the Chirals column lists the number of chiral outliers, the number of chiral centers analysed, the number of these observed in the model and the number defined in the Chemical Component Dictionary. Similar counts are reported in the Torsion and Rings columns. '-' means no outliers of that kind were identified.

Mol	Type	Chain	Res	Link	Chirals	Torsions	Rings
57	ILE	A	3001	-	-	1/7/8/10	-
58	PRO	9	101	55	-	0/0/9/11	0/1/1/1

There are no bond length outliers.

All (3) bond angle outliers are listed below:

Mol	Chain	Res	Type	Atoms	Z	Observed(°)	Ideal(°)
58	9	101	PRO	O-C-CA	-4.85	112.07	124.78
57	A	3001	ILE	CB-CA-C	-2.72	108.67	112.83
57	A	3001	ILE	O-C-CA	-2.59	117.98	124.78

There are no chirality outliers.

All (1) torsion outliers are listed below:

Mol	Chain	Res	Type	Atoms
57	A	3001	ILE	C-CA-CB-CG1

There are no ring outliers.

No monomer is involved in short contacts.

5.7 Other polymers [i](#)

There are no such residues in this entry.

5.8 Polymer linkage issues [i](#)

There are no chain breaks in this entry.

6 Map visualisation [i](#)

This section contains visualisations of the EMDB entry EMD-30431. These allow visual inspection of the internal detail of the map and identification of artifacts.

No raw map or half-maps were deposited for this entry and therefore no images, graphs, etc. pertaining to the raw map can be shown.

6.1 Orthogonal projections [i](#)

6.1.1 Primary map

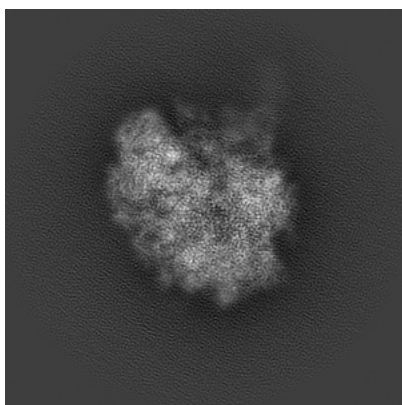

X

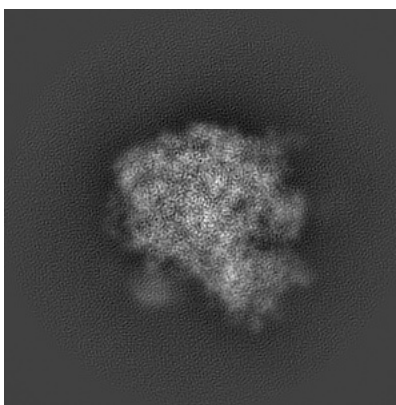

Y

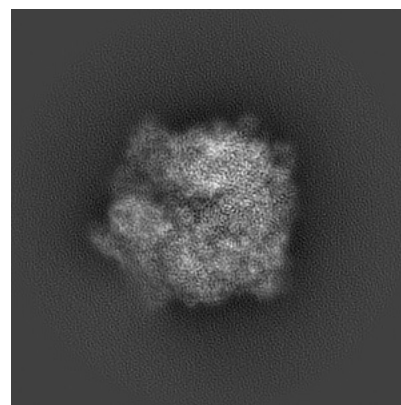

Z

The images above show the map projected in three orthogonal directions.

6.2 Central slices [i](#)

6.2.1 Primary map

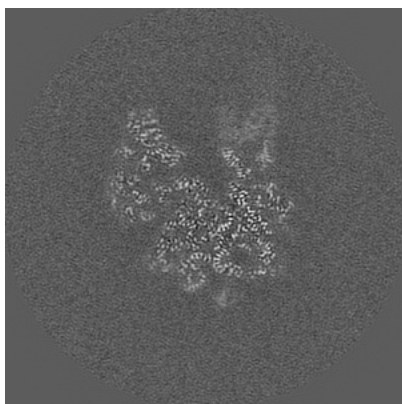

X Index: 150

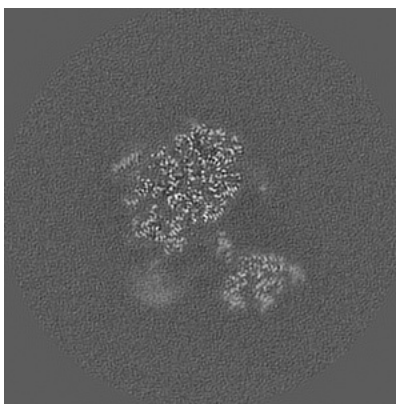

Y Index: 150

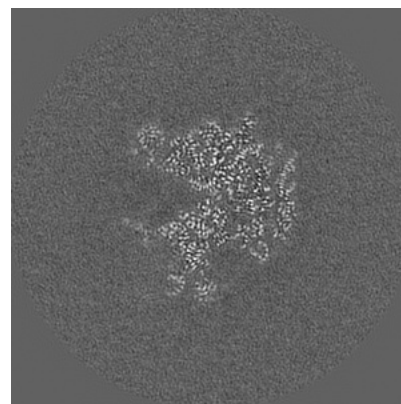

Z Index: 150

The images above show central slices of the map in three orthogonal directions.

6.3 Largest variance slices [i](#)

6.3.1 Primary map

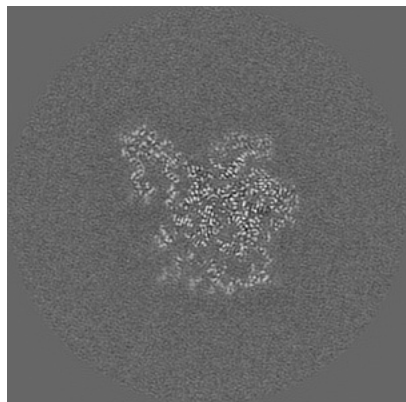

X Index: 173

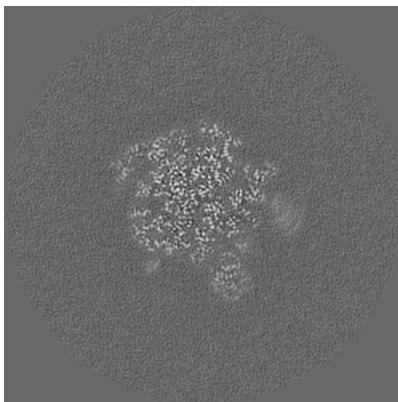

Y Index: 179

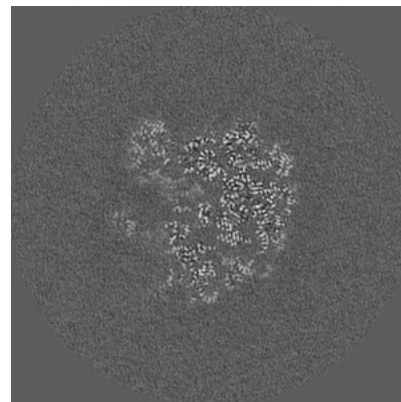

Z Index: 158

The images above show the largest variance slices of the map in three orthogonal directions.

6.4 Orthogonal standard-deviation projections (False-color) [i](#)

6.4.1 Primary map

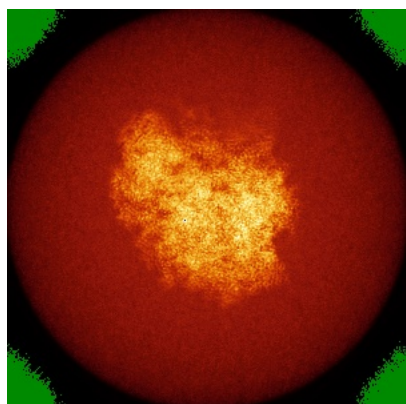

X

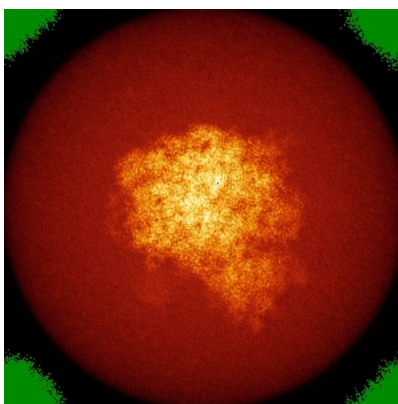

Y

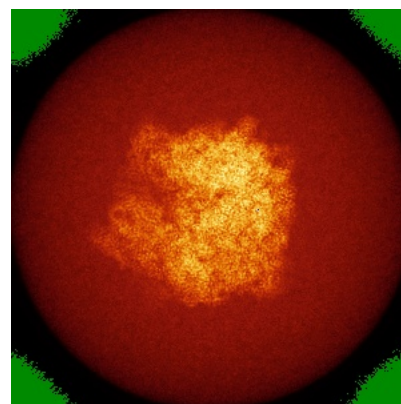

Z

The images above show the map standard deviation projections with false color in three orthogonal directions. Minimum values are shown in green, max in blue, and dark to light orange shades represent small to large values respectively.

6.5 Orthogonal surface views [i](#)

6.5.1 Primary map

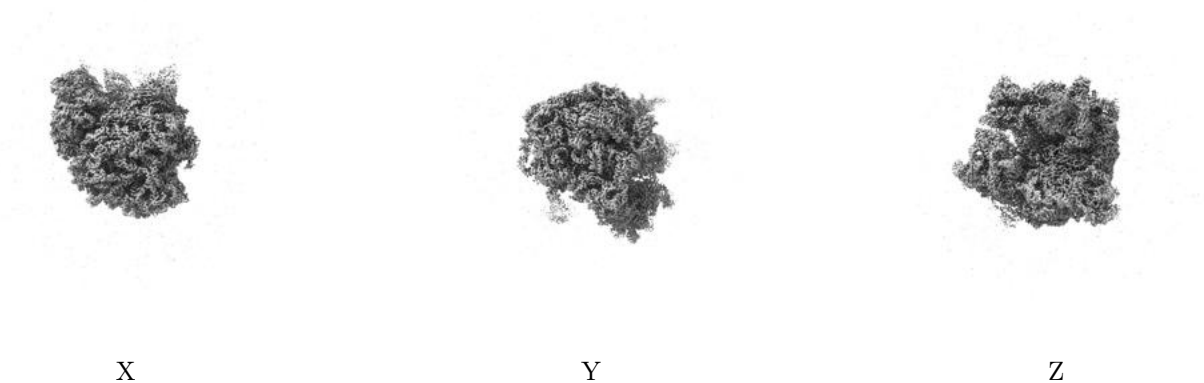

The images above show the 3D surface view of the map at the recommended contour level 0.046. These images, in conjunction with the slice images, may facilitate assessment of whether an appropriate contour level has been provided.

6.6 Mask visualisation [i](#)

This section was not generated. No masks/segmentation were deposited.

7 Map analysis [i](#)

This section contains the results of statistical analysis of the map.

7.1 Map-value distribution [i](#)

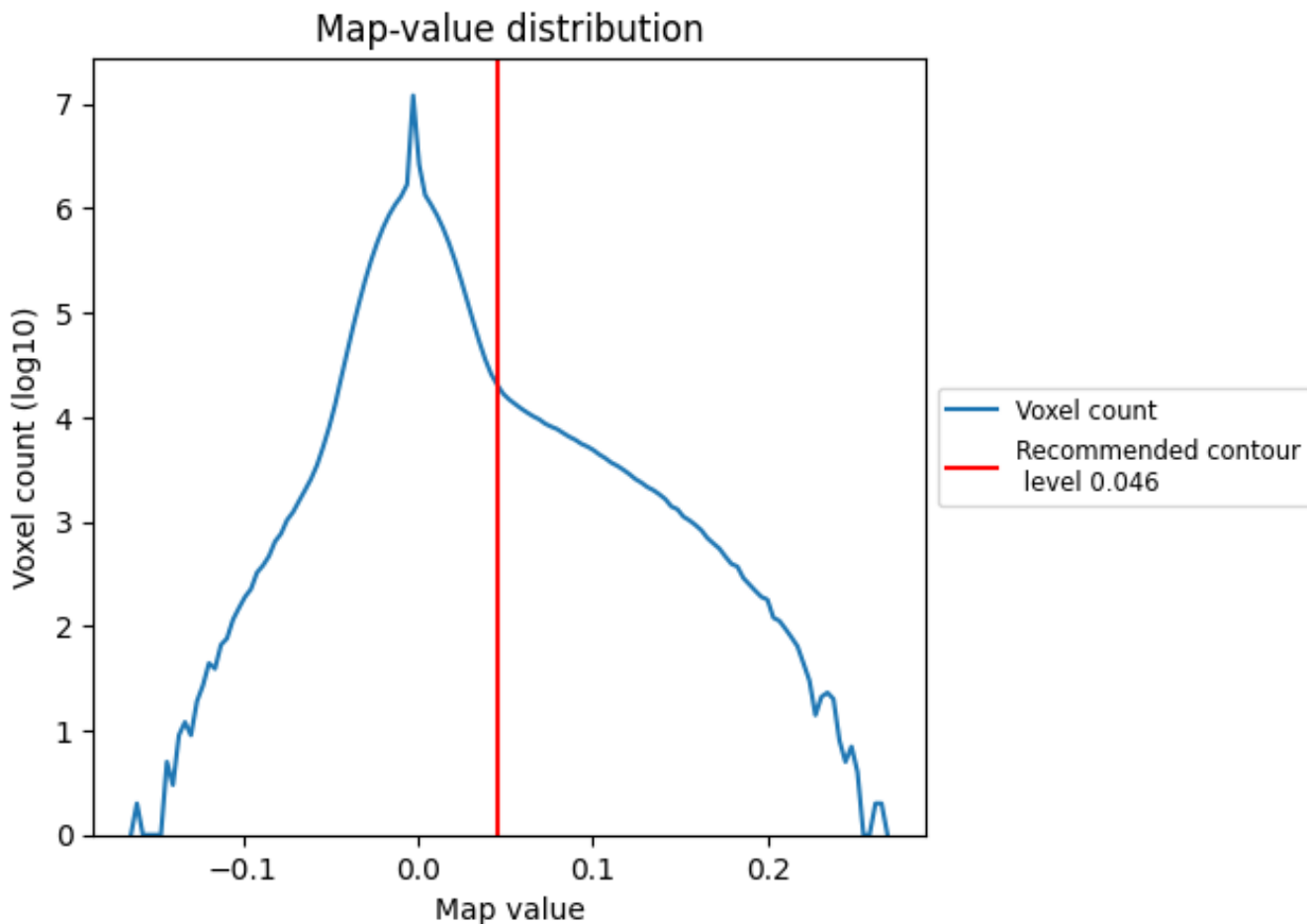

The map-value distribution is plotted in 128 intervals along the x-axis. The y-axis is logarithmic. A spike in this graph at zero usually indicates that the volume has been masked.

7.2 Volume estimate [i](#)

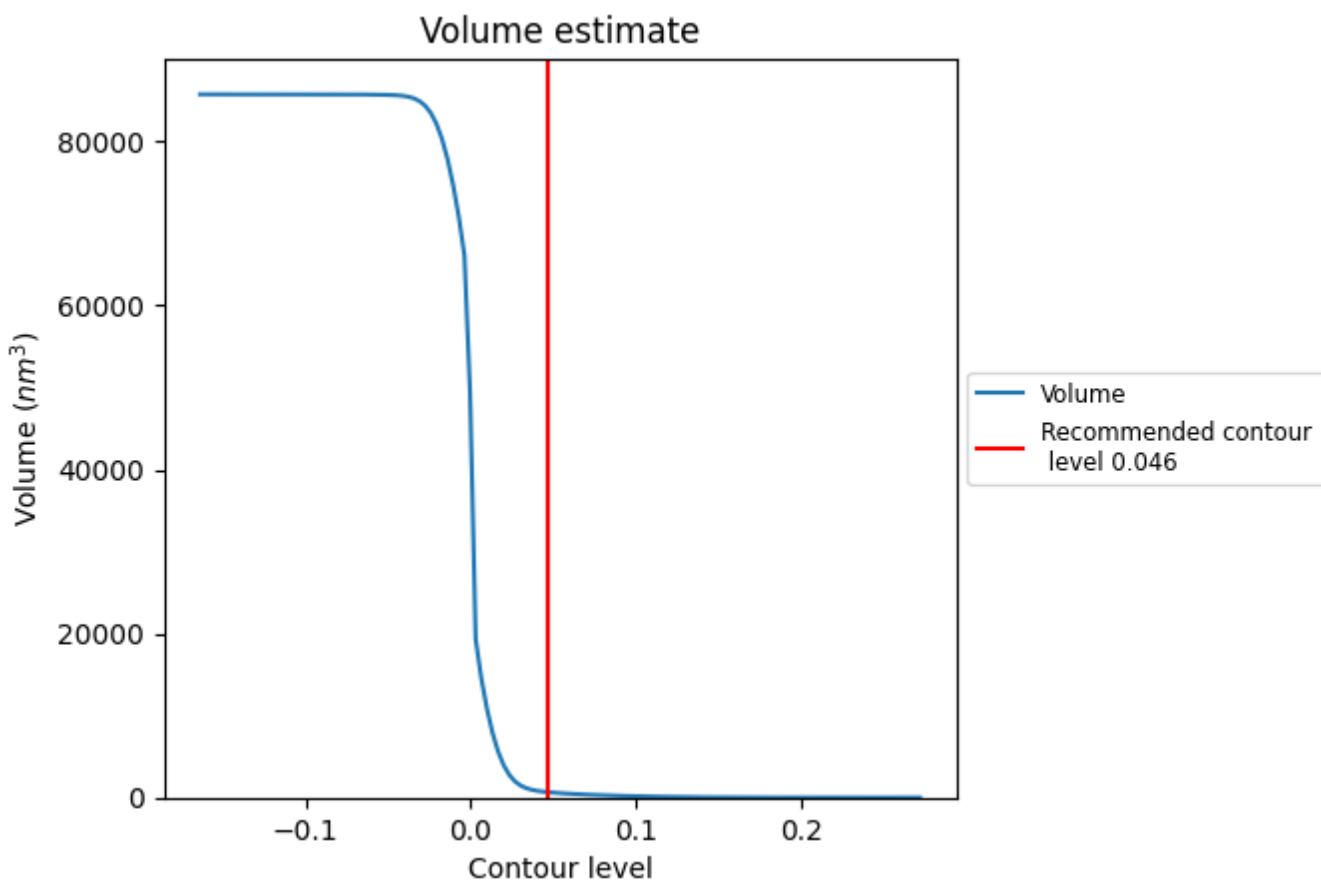

The volume at the recommended contour level is 668 nm³; this corresponds to an approximate mass of 604 kDa.

The volume estimate graph shows how the enclosed volume varies with the contour level. The recommended contour level is shown as a vertical line and the intersection between the line and the curve gives the volume of the enclosed surface at the given level.

7.3 Rotationally averaged power spectrum [\(i\)](#)

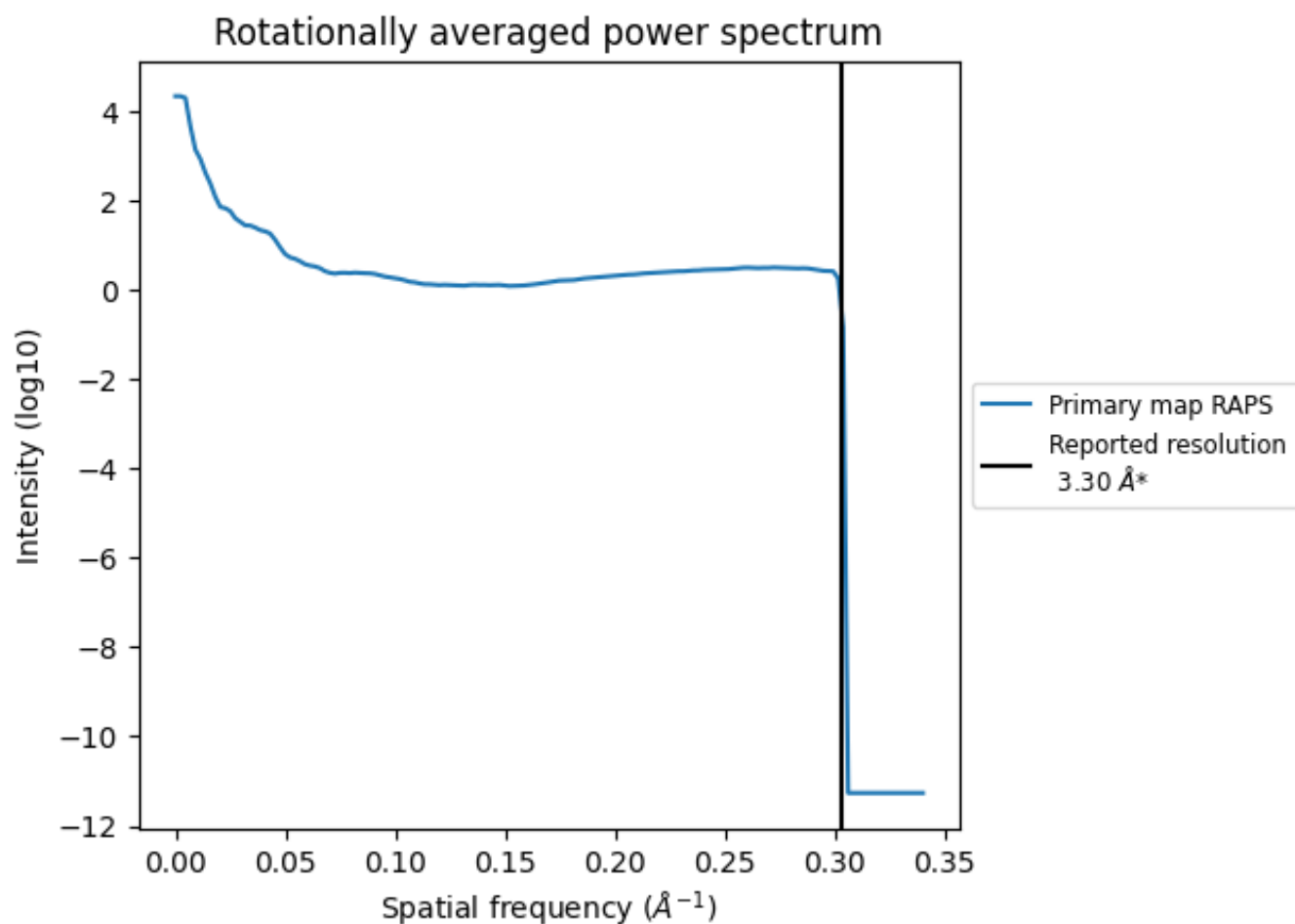

*Reported resolution corresponds to spatial frequency of 0.303 Å⁻¹

8 Fourier-Shell correlation [i](#)

Fourier-Shell Correlation (FSC) is the most commonly used method to estimate the resolution of single-particle and subtomogram-averaged maps. The shape of the curve depends on the imposed symmetry, mask and whether or not the two 3D reconstructions used were processed from a common reference. The reported resolution is shown as a black line. A curve is displayed for the half-bit criterion in addition to lines showing the 0.143 gold standard cut-off and 0.5 cut-off.

8.1 FSC [i](#)

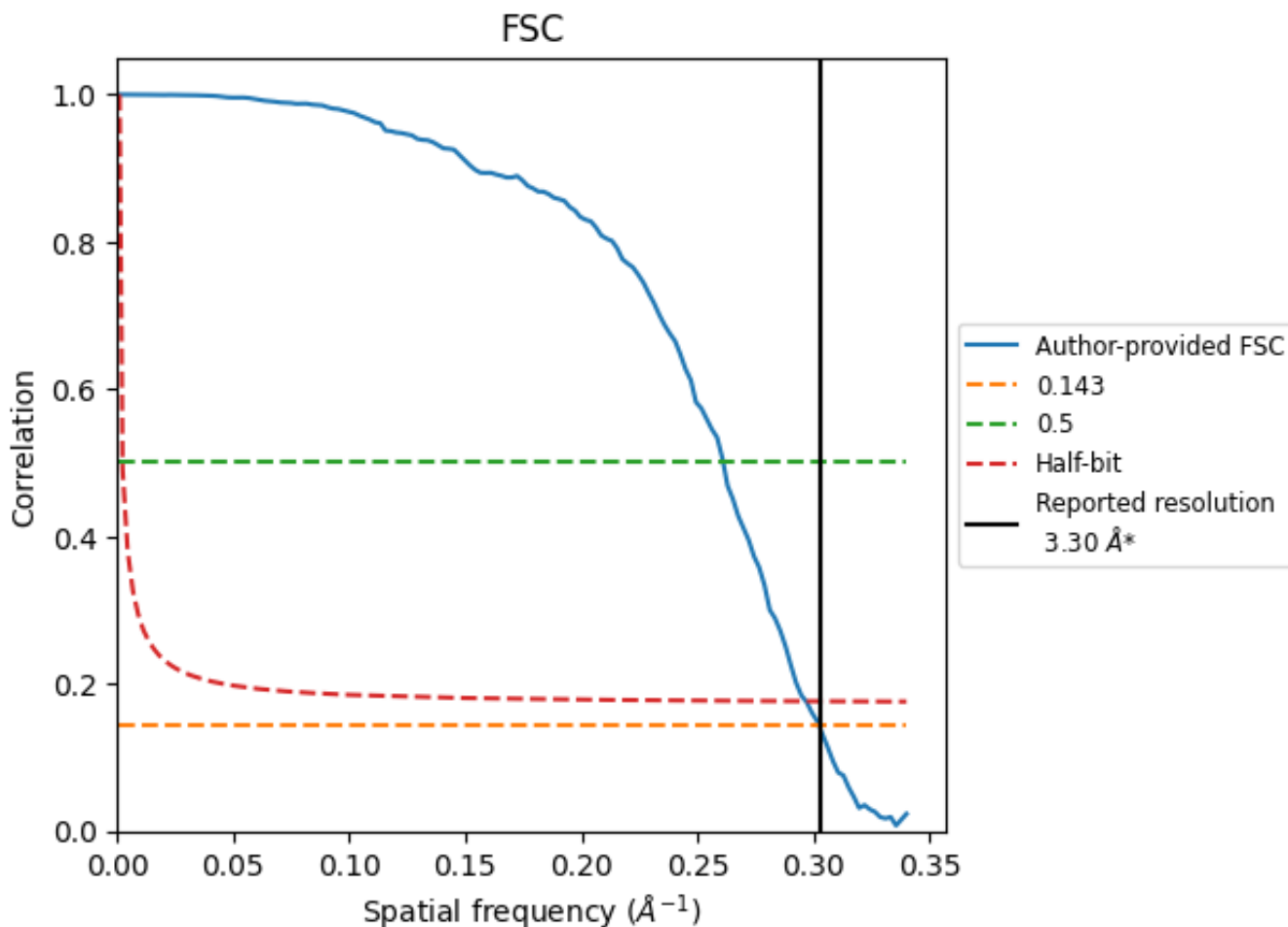

*Reported resolution corresponds to spatial frequency of 0.303 Å⁻¹

8.2 Resolution estimates [i](#)

Resolution estimate (Å)	Estimation criterion (FSC cut-off)		
	0.143	0.5	Half-bit
Reported by author	3.30	-	-
Author-provided FSC curve	3.31	3.83	3.37
Unmasked-calculated*	-	-	-

*Resolution estimate based on FSC curve calculated by comparison of deposited half-maps.

9 Map-model fit [i](#)

This section contains information regarding the fit between EMDB map EMD-30431 and PDB model 7CPJ. Per-residue inclusion information can be found in section 3 on page 15.

9.1 Map-model overlay [i](#)

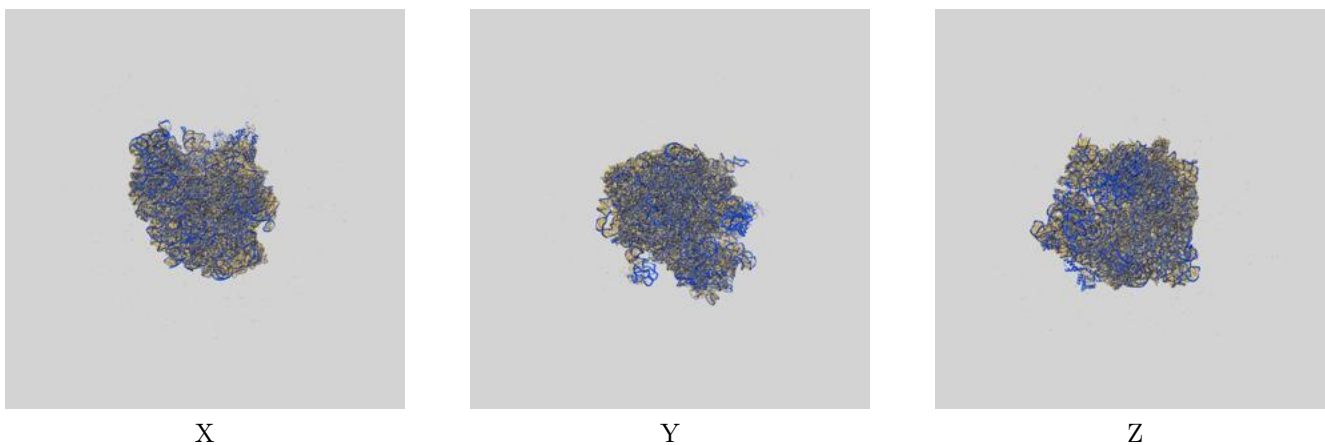

The images above show the 3D surface view of the map at the recommended contour level 0.046 at 50% transparency in yellow overlaid with a ribbon representation of the model coloured in blue. These images allow for the visual assessment of the quality of fit between the atomic model and the map.

9.2 Q-score mapped to coordinate model [i](#)

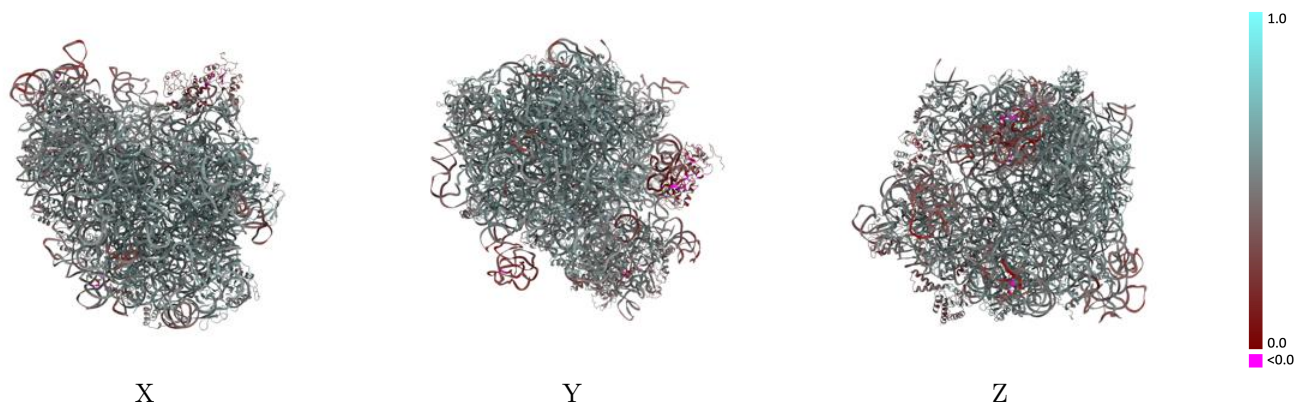

The images above show the model with each residue coloured according to its Q-score. This shows their resolvability in the map with higher Q-score values reflecting better resolvability. Please note: Q-score is calculating the resolvability of atoms, and thus high values are only expected at resolutions at which atoms can be resolved. Low Q-score values may therefore be expected for many entries.

9.3 Atom inclusion mapped to coordinate model [i](#)

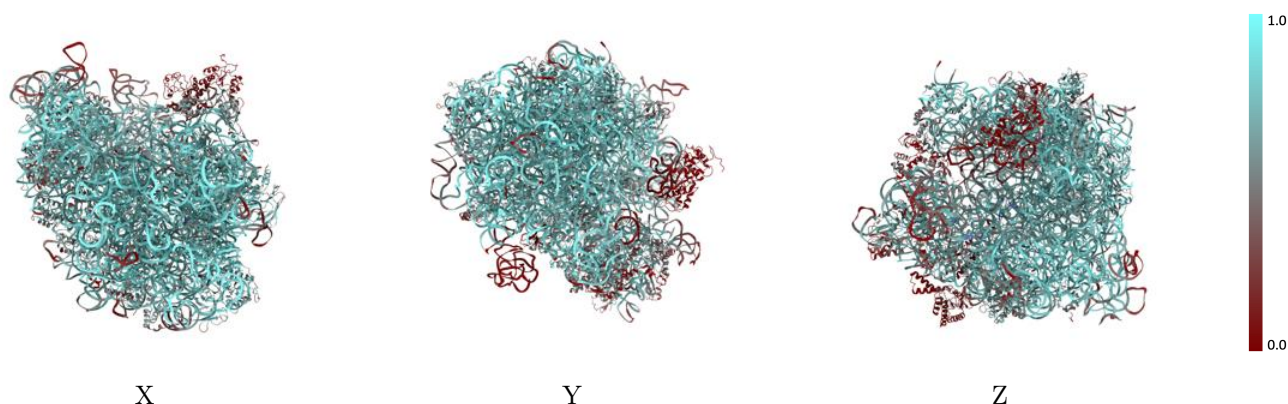

The images above show the model with each residue coloured according to its atom inclusion. This shows to what extent they are inside the map at the recommended contour level (0.046).



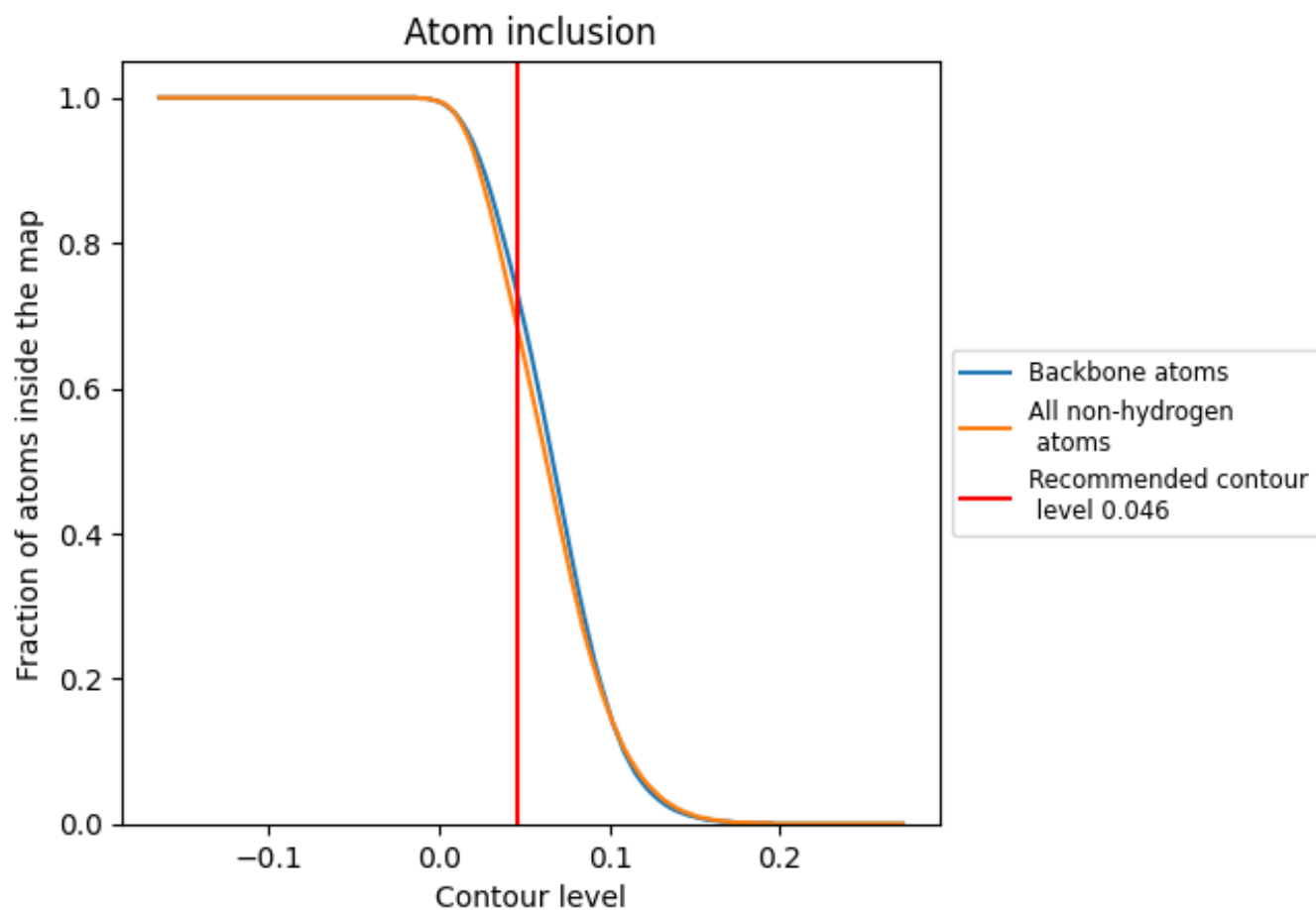



































































9.4 Atom inclusion [i](#)



At the recommended contour level, 73% of all backbone atoms, 68% of all non-hydrogen atoms, are inside the map.

9.5 Map-model fit summary













































The table lists the average atom inclusion at the recommended contour level (0.046) and Q-score for the entire model and for each chain.

Chain	Atom inclusion	Q-score
All	 0.6840	 0.5020
0	 0.6780	 0.5500
1	 0.0130	 0.3880
2	 0.7350	 0.5520
3	 0.7450	 0.5720
4	 0.6710	 0.5560
5	 0.0650	 0.2970
6	 0.1170	 0.3540
9	 0.4420	 0.4360
A	 0.7720	 0.5100
B	 0.7640	 0.5010
C	 0.6930	 0.5610
D	 0.7190	 0.5640
E	 0.6340	 0.5380
F	 0.4650	 0.4800
G	 0.4990	 0.5070
H	 0.1410	 0.3630
I	 0.0150	 0.2600
J	 0.7160	 0.5580
K	 0.6780	 0.5500
L	 0.6780	 0.5410
M	 0.6770	 0.5490
N	 0.7290	 0.5590
O	 0.6370	 0.5230
P	 0.6590	 0.5530
Q	 0.7610	 0.5640
R	 0.6830	 0.5500
S	 0.6570	 0.5470
T	 0.5890	 0.5330
U	 0.5450	 0.5180
V	 0.6410	 0.5390
W	 0.7030	 0.5720
X	 0.6570	 0.5450
Y	 0.5190	 0.4910
Z	 0.6750	 0.5490



Continued on next page...

Continued from previous page...

Chain	Atom inclusion	Q-score
a	 0.7410	 0.4930
b	 0.1030	 0.4270
c	 0.5080	 0.5040
d	 0.4910	 0.4490
e	 0.6170	 0.5220
f	 0.4520	 0.4660
g	 0.3950	 0.4650
h	 0.6140	 0.5370
i	 0.4760	 0.4770
j	 0.3840	 0.4550
k	 0.5300	 0.5020
l	 0.5960	 0.5280
m	 0.4220	 0.4830
n	 0.5080	 0.4950
o	 0.6130	 0.5160
p	 0.6300	 0.5110
q	 0.5580	 0.5200
r	 0.5150	 0.5080
s	 0.4270	 0.4760
t	 0.6230	 0.5150
u	 0.0230	 0.3580
x	 0.6980	 0.5340