



Full wwPDB X-ray Structure Validation Report ⓘ

May 29, 2020 – 02:19 am BST

PDB ID : 3CI0
Title : The Crystal Structure of the GspK-GspI-GspJ complex from enterotoxigenic Escherichia coli Type 2 Secretion System
Authors : Korotkov, K.V.; Hol, W.G.J.
Deposited on : 2008-03-10
Resolution : 2.20 Å(reported)

This is a Full wwPDB X-ray Structure Validation Report for a publicly released PDB entry.

We welcome your comments at validation@mail.wwpdb.org

A user guide is available at

<https://www.wwpdb.org/validation/2017/XrayValidationReportHelp>

with specific help available everywhere you see the ⓘ symbol.

The following versions of software and data (see [references ⓘ](#)) were used in the production of this report:

MolProbity : 4.02b-467
Mogul : 1.8.5 (274361), CSD as541be (2020)
Xtriage (Phenix) : 1.13
EDS : 2.11
Percentile statistics : 20191225.v01 (using entries in the PDB archive December 25th 2019)
Refmac : 5.8.0158
CCP4 : 7.0.044 (Gargrove)
Ideal geometry (proteins) : Engh & Huber (2001)
Ideal geometry (DNA, RNA) : Parkinson et al. (1996)
Validation Pipeline (wwPDB-VP) : 2.11

1 Overall quality at a glance

The following experimental techniques were used to determine the structure:

X-RAY DIFFRACTION

The reported resolution of this entry is 2.20 Å.

Percentile scores (ranging between 0-100) for global validation metrics of the entry are shown in the following graphic. The table shows the number of entries on which the scores are based.

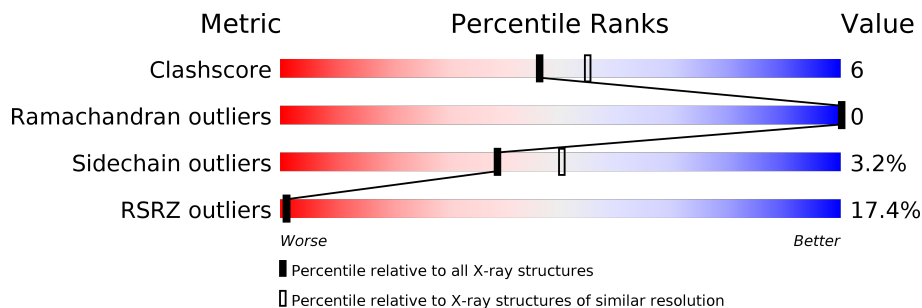

Metric	Whole archive (#Entries)	Similar resolution (#Entries, resolution range(Å))
Clashscore	141614	5594 (2.20-2.20)
Ramachandran outliers	138981	5503 (2.20-2.20)
Sidechain outliers	138945	5504 (2.20-2.20)
RSRZ outliers	127900	4800 (2.20-2.20)

The table below summarises the geometric issues observed across the polymeric chains and their fit to the electron density. The red, orange, yellow and green segments on the lower bar indicate the fraction of residues that contain outliers for ≥ 3 , 2, 1 and 0 types of geometric quality criteria respectively. A grey segment represents the fraction of residues that are not modelled. The numeric value for each fraction is indicated below the corresponding segment, with a dot representing fractions $\leq 5\%$. The upper red bar (where present) indicates the fraction of residues that have poor fit to the electron density. The numeric value is given above the bar.

Mol	Chain	Length	Quality of chain
1	I	89	
2	J	163	
3	K	298	

2 Entry composition i

There are 6 unique types of molecules in this entry. The entry contains 4302 atoms, of which 0 are hydrogens and 0 are deuteriums.

In the tables below, the ZeroOcc column contains the number of atoms modelled with zero occupancy, the AltConf column contains the number of residues with at least one atom in alternate conformation and the Trace column contains the number of residues modelled with at most 2 atoms.

- Molecule 1 is a protein called Pseudopilin GspI.

Mol	Chain	Residues	Atoms					ZeroOcc	AltConf	Trace
			Total	C	N	O	Se			
1	I	83	664	414	122	126	2	0	0	0

There are 3 discrepancies between the modelled and reference sequences:

Chain	Residue	Modelled	Actual	Comment	Reference
I	26	GLY	-	EXPRESSION TAG	UNP Q8VPC3
I	27	ALA	-	EXPRESSION TAG	UNP Q8VPC3
I	28	MET	-	EXPRESSION TAG	UNP Q8VPC3

- Molecule 2 is a protein called Pseudopilin GspJ.

Mol	Chain	Residues	Atoms					ZeroOcc	AltConf	Trace
			Total	C	N	O	Se			
2	J	154	1223	773	225	217	8	0	0	0

There is a discrepancy between the modelled and reference sequences:

Chain	Residue	Modelled	Actual	Comment	Reference
J	30	MET	-	EXPRESSION TAG	UNP Q8VRM4

- Molecule 3 is a protein called Pseudopilin GspK.

Mol	Chain	Residues	Atoms					ZeroOcc	AltConf	Trace
			Total	C	N	O	S			
3	K	280	2221	1407	391	416	7	0	0	0

There are 3 discrepancies between the modelled and reference sequences:

Chain	Residue	Modelled	Actual	Comment	Reference
K	19	GLY	-	EXPRESSION TAG	UNP A7ZRI8

Continued on next page...

Continued from previous page...

Chain	Residue	Modelled	Actual	Comment	Reference
K	20	ALA	-	EXPRESSION TAG	UNP A7ZRI8
K	21	MET	-	EXPRESSION TAG	UNP A7ZRI8

- Molecule 4 is CHLORIDE ION (three-letter code: CL) (formula: Cl).

Mol	Chain	Residues	Atoms	ZeroOcc	AltConf
4	I	1	Total Cl 1 1	0	0

- Molecule 5 is CALCIUM ION (three-letter code: CA) (formula: Ca).

Mol	Chain	Residues	Atoms	ZeroOcc	AltConf
5	I	1	Total Ca 1 1	0	0
5	K	2	Total Ca 2 2	0	0

- Molecule 6 is water.

Mol	Chain	Residues	Atoms	ZeroOcc	AltConf
6	I	32	Total O 32 32	0	0
6	J	67	Total O 67 67	0	0
6	K	91	Total O 91 91	0	0

3 Residue-property plots [i](#)

These plots are drawn for all protein, RNA and DNA chains in the entry. The first graphic for a chain summarises the proportions of the various outlier classes displayed in the second graphic. The second graphic shows the sequence view annotated by issues in geometry and electron density. Residues are color-coded according to the number of geometric quality criteria for which they contain at least one outlier: green = 0, yellow = 1, orange = 2 and red = 3 or more. A red dot above a residue indicates a poor fit to the electron density ($RSRZ > 2$). Stretches of 2 or more consecutive residues without any outlier are shown as a green connector. Residues present in the sample, but not in the model, are shown in grey.

- Molecule 1: Pseudopilin GspI

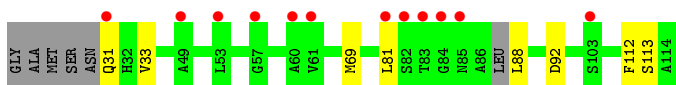
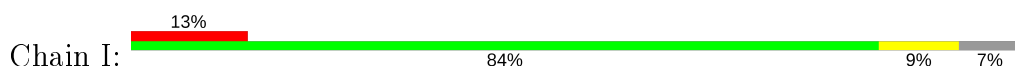

- Molecule 2: Pseudopilin GspJ

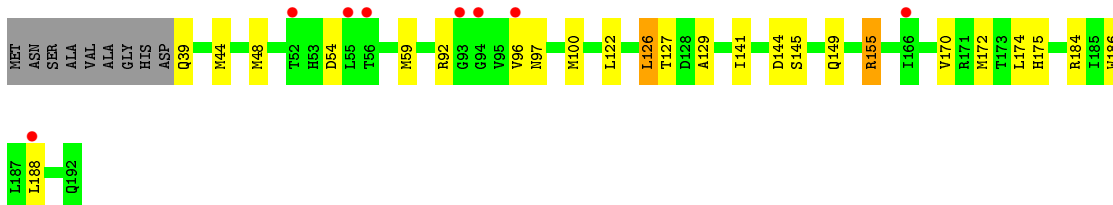
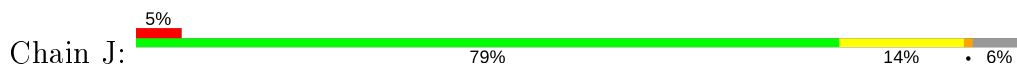

- Molecule 3: Pseudopilin GspK

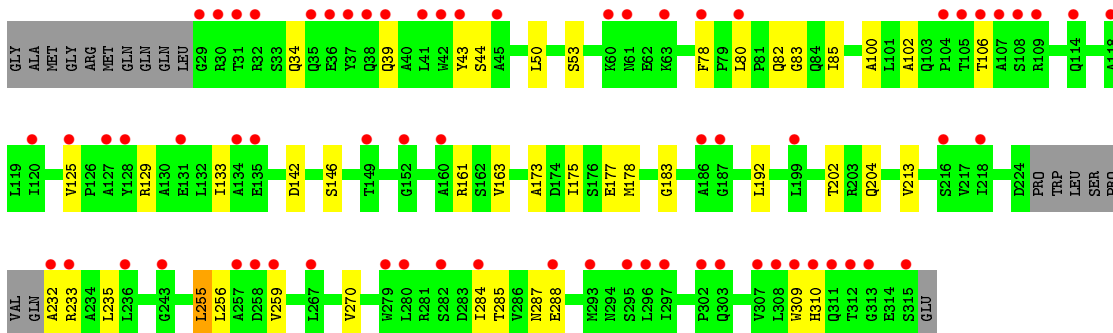
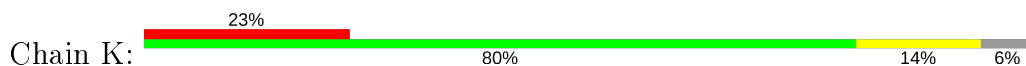

4 Data and refinement statistics

Property	Value	Source
Space group	P 41 21 2	Depositor
Cell constants a, b, c, α , β , γ	96.12Å 96.12Å 108.44Å 90.00° 90.00° 90.00°	Depositor
Resolution (Å)	35.96 – 2.20 35.96 – 2.20	Depositor EDS
% Data completeness (in resolution range)	99.9 (35.96-2.20) 99.9 (35.96-2.20)	Depositor EDS
R_{merge}	0.08	Depositor
R_{sym}	0.08	Depositor
$\langle I/\sigma(I) \rangle$ ¹	2.01 (at 2.20Å)	Xtrriage
Refinement program	REFMAC	Depositor
R, R_{free}	0.192 , 0.259 0.204 , (Not available)	Depositor DCC
R_{free} test set	No test flags present.	wwPDB-VP
Wilson B-factor (Å ²)	46.0	Xtrriage
Anisotropy	0.273	Xtrriage
Bulk solvent k_{sol} (e/Å ³), B_{sol} (Å ²)	0.30 , 60.4	EDS
L-test for twinning ²	$\langle L \rangle = 0.49$, $\langle L^2 \rangle = 0.32$	Xtrriage
Estimated twinning fraction	No twinning to report.	Xtrriage
F_o, F_c correlation	0.94	EDS
Total number of atoms	4302	wwPDB-VP
Average B, all atoms (Å ²)	68.0	wwPDB-VP

Xtrriage's analysis on translational NCS is as follows: *The largest off-origin peak in the Patterson function is 3.82% of the height of the origin peak. No significant pseudotranslation is detected.*

¹Intensities estimated from amplitudes.

²Theoretical values of $\langle |L| \rangle$, $\langle L^2 \rangle$ for acentric reflections are 0.5, 0.333 respectively for untwinned datasets, and 0.375, 0.2 for perfectly twinned datasets.

5 Model quality [i](#)

5.1 Standard geometry [i](#)

Bond lengths and bond angles in the following residue types are not validated in this section: CA, CL

The Z score for a bond length (or angle) is the number of standard deviations the observed value is removed from the expected value. A bond length (or angle) with $|Z| > 5$ is considered an outlier worth inspection. RMSZ is the root-mean-square of all Z scores of the bond lengths (or angles).

Mol	Chain	Bond lengths		Bond angles	
		RMSZ	# Z >5	RMSZ	# Z >5
1	I	0.60	0/675	0.70	0/911
2	J	0.63	0/1244	0.74	0/1673
3	K	0.53	0/2264	0.63	1/3078 (0.0%)
All	All	0.57	0/4183	0.68	1/5662 (0.0%)

There are no bond length outliers.

All (1) bond angle outliers are listed below:

Mol	Chain	Res	Type	Atoms	Z	Observed(°)	Ideal(°)
3	K	142	ASP	CB-CG-OD1	5.75	123.47	118.30

There are no chirality outliers.

There are no planarity outliers.

5.2 Too-close contacts [i](#)

In the following table, the Non-H and H(model) columns list the number of non-hydrogen atoms and hydrogen atoms in the chain respectively. The H(added) column lists the number of hydrogen atoms added and optimized by MolProbity. The Clashes column lists the number of clashes within the asymmetric unit, whereas Symm-Clashes lists symmetry related clashes.

Mol	Chain	Non-H	H(model)	H(added)	Clashes	Symm-Clashes
1	I	664	0	637	4	0
2	J	1223	0	1234	23	0
3	K	2221	0	2220	29	0
4	I	1	0	0	0	0
5	I	1	0	0	0	0
5	K	2	0	0	0	0
6	I	32	0	0	1	0

Continued on next page...

Continued from previous page...

Mol	Chain	Non-H	H(model)	H(added)	Clashes	Symm-Clashes
6	J	67	0	0	4	0
6	K	91	0	0	5	0
All	All	4302	0	4091	52	0

The all-atom clashscore is defined as the number of clashes found per 1000 atoms (including hydrogen atoms). The all-atom clashscore for this structure is 6.

All (52) close contacts within the same asymmetric unit are listed below, sorted by their clash magnitude.

Atom-1	Atom-2	Interatomic distance (Å)	Clash overlap (Å)
3:K:50:LEU:HD21	3:K:78:PHE:CZ	2.11	0.84
3:K:232:ALA:HA	6:K:469:HOH:O	1.80	0.81
2:J:149:GLN:HG2	6:J:225:HOH:O	1.89	0.71
2:J:59:MSE:HE1	3:K:309:TRP:CE2	2.26	0.69
2:J:48:MSE:HE2	2:J:184:ARG:HE	1.57	0.68
2:J:127:THR:HG23	6:J:218:HOH:O	1.94	0.67
3:K:43:TYR:CG	3:K:80:LEU:HD13	2.30	0.66
3:K:39:GLN:HG3	3:K:43:TYR:CE2	2.33	0.64
3:K:85:ILE:HG22	3:K:284:ILE:HG12	1.82	0.62
2:J:48:MSE:CE	2:J:184:ARG:HE	2.13	0.61
3:K:43:TYR:CD1	3:K:80:LEU:HD13	2.36	0.61
3:K:213:VAL:HG12	3:K:233:ARG:HD2	1.83	0.60
3:K:125:VAL:HG13	3:K:129:ARG:HD3	1.87	0.57
2:J:172:MSE:HE3	2:J:174:LEU:HD23	1.87	0.57
2:J:59:MSE:HE1	3:K:309:TRP:CD2	2.41	0.56
2:J:170:VAL:HG23	2:J:188:LEU:HD11	1.89	0.55
3:K:232:ALA:CA	6:K:469:HOH:O	2.48	0.55
2:J:54:ASP:HA	2:J:92:ARG:HD2	1.89	0.53
3:K:161:ARG:HD3	6:K:456:HOH:O	2.07	0.53
2:J:174:LEU:C	2:J:174:LEU:HD12	2.29	0.53
2:J:126:LEU:HD21	3:K:163:VAL:HG12	1.90	0.52
3:K:133:ILE:HD11	3:K:183:GLY:O	2.09	0.52
1:I:69:MSE:HE2	6:J:211:HOH:O	2.10	0.52
3:K:83:GLY:HA3	3:K:285:THR:O	2.11	0.51
3:K:232:ALA:CB	6:K:469:HOH:O	2.58	0.50
2:J:126:LEU:CD1	2:J:129:ALA:HB2	2.41	0.50
2:J:145:SER:O	2:J:174:LEU:HA	2.11	0.50
1:I:88:LEU:HD12	1:I:112:PHE:O	2.11	0.49
2:J:155:ARG:HB2	2:J:155:ARG:HH11	1.78	0.49
3:K:255:LEU:HD13	6:K:468:HOH:O	2.13	0.48
3:K:50:LEU:HD21	3:K:78:PHE:CE2	2.48	0.48

Continued on next page...

Continued from previous page...

Atom-1	Atom-2	Interatomic distance (Å)	Clash overlap (Å)
2:J:172:MSE:HE3	2:J:174:LEU:CD2	2.44	0.46
3:K:100:ALA:HA	3:K:202:THR:O	2.16	0.46
1:I:31:GLN:NE2	6:I:146:HOH:O	2.49	0.46
3:K:50:LEU:CD2	3:K:78:PHE:CE2	2.99	0.46
3:K:102:ALA:HB3	3:K:202:THR:HG22	1.98	0.45
2:J:39:GLN:N	6:J:203:HOH:O	2.50	0.45
2:J:144:ASP:OD2	2:J:175:HIS:ND1	2.49	0.45
2:J:44:MSE:HE1	2:J:141:ILE:HD13	1.99	0.45
2:J:48:MSE:HB2	3:K:34:GLN:HE22	1.82	0.45
3:K:106:THR:O	3:K:106:THR:HG23	2.17	0.44
3:K:235:LEU:HD21	3:K:256:LEU:HD21	2.00	0.43
3:K:204:GLN:O	3:K:270:VAL:HA	2.19	0.42
2:J:97:ASN:O	2:J:100:MSE:SE	2.87	0.42
3:K:82:GLN:HB3	3:K:287:ASN:OD1	2.19	0.42
3:K:173:ALA:N	3:K:177:GLU:OE1	2.40	0.42
2:J:122:LEU:HD12	2:J:122:LEU:N	2.35	0.41
3:K:235:LEU:HD11	3:K:256:LEU:HD21	2.02	0.41
2:J:48:MSE:HE1	2:J:186:TRP:CZ2	2.56	0.41
1:I:81:LEU:CD1	1:I:92:ASP:OD2	2.70	0.40
2:J:96:VAL:HG13	2:J:96:VAL:O	2.22	0.40
3:K:50:LEU:CD2	3:K:78:PHE:CZ	2.96	0.40

There are no symmetry-related clashes.

5.3 Torsion angles [i](#)

5.3.1 Protein backbone [i](#)

In the following table, the Percentiles column shows the percent Ramachandran outliers of the chain as a percentile score with respect to all X-ray entries followed by that with respect to entries of similar resolution.

The Analysed column shows the number of residues for which the backbone conformation was analysed, and the total number of residues.

Mol	Chain	Analysed	Favoured	Allowed	Outliers	Percentiles	
1	I	79/89 (89%)	78 (99%)	1 (1%)	0	100	100
2	J	152/163 (93%)	146 (96%)	6 (4%)	0	100	100
3	K	276/298 (93%)	270 (98%)	6 (2%)	0	100	100
All	All	507/550 (92%)	494 (97%)	13 (3%)	0	100	100

There are no Ramachandran outliers to report.

5.3.2 Protein sidechains [i](#)

In the following table, the Percentiles column shows the percent sidechain outliers of the chain as a percentile score with respect to all X-ray entries followed by that with respect to entries of similar resolution.

The Analysed column shows the number of residues for which the sidechain conformation was analysed, and the total number of residues.

Mol	Chain	Analysed	Rotameric	Outliers	Percentiles	
1	I	69/71 (97%)	67 (97%)	2 (3%)	42	54
2	J	131/129 (102%)	129 (98%)	2 (2%)	65	78
3	K	240/257 (93%)	230 (96%)	10 (4%)	30	38
All	All	440/457 (96%)	426 (97%)	14 (3%)	39	50

All (14) residues with a non-rotameric sidechain are listed below:

Mol	Chain	Res	Type
1	I	33	VAL
1	I	113	SER
2	J	126	LEU
2	J	155	ARG
3	K	44	SER
3	K	53	SER
3	K	146	SER
3	K	175	ILE
3	K	178	MET
3	K	192	LEU
3	K	255	LEU
3	K	259	VAL
3	K	288	GLU
3	K	310	HIS

Some sidechains can be flipped to improve hydrogen bonding and reduce clashes. There are no such sidechains identified.

5.3.3 RNA [i](#)

There are no RNA molecules in this entry.

5.4 Non-standard residues in protein, DNA, RNA chains [i](#)

There are no non-standard protein/DNA/RNA residues in this entry.

5.5 Carbohydrates [i](#)

There are no carbohydrates in this entry.

5.6 Ligand geometry [i](#)

Of 4 ligands modelled in this entry, 4 are monoatomic - leaving 0 for Mogul analysis.

There are no bond length outliers.

There are no bond angle outliers.

There are no chirality outliers.

There are no torsion outliers.

There are no ring outliers.

No monomer is involved in short contacts.

5.7 Other polymers [i](#)

There are no such residues in this entry.

5.8 Polymer linkage issues [i](#)

There are no chain breaks in this entry.

6 Fit of model and data

6.1 Protein, DNA and RNA chains

In the following table, the column labelled ‘#RSRZ> 2’ contains the number (and percentage) of RSRZ outliers, followed by percent RSRZ outliers for the chain as percentile scores relative to all X-ray entries and entries of similar resolution. The OWAB column contains the minimum, median, 95th percentile and maximum values of the occupancy-weighted average B-factor per residue. The column labelled ‘Q< 0.9’ lists the number of (and percentage) of residues with an average occupancy less than 0.9.

Mol	Chain	Analysed	<RSRZ>	#RSRZ>2	OWAB(Å ²)	Q<0.9
1	I	81/89 (91%)	0.66	12 (14%) 2 2	59, 67, 85, 89	0
2	J	146/163 (89%)	0.60	8 (5%) 25 24	54, 59, 68, 73	0
3	K	280/298 (93%)	1.21	68 (24%) 0 0	56, 73, 80, 82	0
All	All	507/550 (92%)	0.95	88 (17%) 1 1	54, 69, 80, 89	0

All (88) RSRZ outliers are listed below:

Mol	Chain	Res	Type	RSRZ
3	K	108	SER	6.9
3	K	107	ALA	6.5
1	I	84	GLY	5.3
1	I	81	LEU	4.7
3	K	152	GLY	4.6
3	K	31	THR	4.4
3	K	61	ASN	4.4
3	K	315	SER	4.4
3	K	312	THR	4.3
3	K	106	THR	4.3
3	K	128	TYR	4.3
3	K	104	PRO	4.2
3	K	259	VAL	4.2
3	K	125	VAL	4.0
3	K	127	ALA	3.9
3	K	187	GLY	3.7
3	K	35	GLN	3.6
3	K	109	ARG	3.6
3	K	303	GLN	3.6
3	K	186	ALA	3.6
3	K	309	TRP	3.6
2	J	166	ILE	3.5
3	K	257	ALA	3.5

Continued on next page...

Continued from previous page...

Mol	Chain	Res	Type	RSRZ
3	K	38	GLN	3.4
3	K	41	LEU	3.3
3	K	63	LYS	3.2
3	K	288	GLU	3.1
3	K	29	GLY	3.1
2	J	55	LEU	3.0
3	K	149	THR	3.0
1	I	53	LEU	2.9
3	K	114	GLN	2.9
1	I	57	GLY	2.9
2	J	188	LEU	2.9
3	K	78	PHE	2.9
3	K	32	ARG	2.9
3	K	199	LEU	2.8
3	K	313	GLY	2.8
3	K	267	LEU	2.8
1	I	60	ALA	2.8
3	K	308	LEU	2.8
3	K	135	GLU	2.8
3	K	43	TYR	2.7
3	K	60	LYS	2.7
3	K	45	ALA	2.7
3	K	310	HIS	2.7
3	K	297	ILE	2.6
3	K	39	GLN	2.6
3	K	42	TRP	2.6
2	J	52	THR	2.6
3	K	293	MET	2.5
1	I	103	SER	2.5
3	K	302	PRO	2.5
3	K	295	SER	2.5
1	I	85	ASN	2.5
3	K	279	TRP	2.5
3	K	296	LEU	2.5
3	K	243	GLY	2.4
3	K	311	GLN	2.4
3	K	284	ILE	2.4
3	K	118	ALA	2.4
1	I	83	THR	2.4
3	K	80	LEU	2.3
3	K	307	VAL	2.3
3	K	218	ILE	2.3

Continued on next page...

Continued from previous page...

Mol	Chain	Res	Type	RSRZ
2	J	56	THR	2.3
3	K	258	ASP	2.3
3	K	105	THR	2.3
1	I	82	SER	2.2
3	K	36	GLU	2.2
3	K	30	ARG	2.2
3	K	216	SER	2.2
3	K	236	LEU	2.2
3	K	280	LEU	2.2
2	J	94	GLY	2.2
3	K	120	ILE	2.2
1	I	61	VAL	2.2
3	K	233	ARG	2.2
3	K	37	TYR	2.1
3	K	232	ALA	2.1
3	K	160	ALA	2.1
3	K	131	GLU	2.1
2	J	96	VAL	2.1
2	J	93	GLY	2.0
1	I	31	GLN	2.0
3	K	282	SER	2.0
1	I	49	ALA	2.0
3	K	134	ALA	2.0

6.2 Non-standard residues in protein, DNA, RNA chains [i](#)

There are no non-standard protein/DNA/RNA residues in this entry.

6.3 Carbohydrates [i](#)

There are no carbohydrates in this entry.

6.4 Ligands [i](#)

In the following table, the Atoms column lists the number of modelled atoms in the group and the number defined in the chemical component dictionary. The B-factors column lists the minimum, median, 95th percentile and maximum values of B factors of atoms in the group. The column labelled 'Q< 0.9' lists the number of atoms with occupancy less than 0.9.

Continued on next page...

Continued from previous page...

Mol	Type	Chain	Res	Atoms	RSCC	RSR	B-factors(\AA^2)	Q<0.9
5	CA	K	401	1/1	0.88	0.07	73,73,73,73	0
5	CA	I	115	1/1	0.91	0.13	69,69,69,69	0
4	CL	I	1	1/1	0.95	0.08	54,54,54,54	0
5	CA	K	402	1/1	0.97	0.03	71,71,71,71	0

6.5 Other polymers [i](#)

There are no such residues in this entry.