



wwPDB X-ray Structure Validation Summary Report ⓘ

Nov 22, 2023 – 10:38 AM JST

PDB ID : 7CDA
Title : Crystal structure of T2R-TTL-PAC complex
Authors : Chen, L.J.; Chen, Q.; Yu, Y.; Yang, J.H.
Deposited on : 2020-06-19
Resolution : 2.66 Å(reported)

This is a wwPDB X-ray Structure Validation Summary Report for a publicly released PDB entry.

We welcome your comments at validation@mail.wwpdb.org

A user guide is available at

<https://www.wwpdb.org/validation/2017/XrayValidationReportHelp>

with specific help available everywhere you see the ⓘ symbol.

The types of validation reports are described at

<https://www.wwpdb.org/validation/2017/FAQs#types>.

The following versions of software and data (see [references ⓘ](#)) were used in the production of this report:

MolProbity : 4.02b-467
Mogul : 1.8.5 (274361), CSD as541be (2020)
Xtriage (Phenix) : 1.13
EDS : 2.36
buster-report : 1.1.7 (2018)
Percentile statistics : 20191225.v01 (using entries in the PDB archive December 25th 2019)
Refmac : 5.8.0158
CCP4 : 7.0.044 (Gargrove)
Ideal geometry (proteins) : Engh & Huber (2001)
Ideal geometry (DNA, RNA) : Parkinson et al. (1996)
Validation Pipeline (wwPDB-VP) : 2.36

1 Overall quality at a glance

The following experimental techniques were used to determine the structure:

X-RAY DIFFRACTION

The reported resolution of this entry is 2.66 Å.

Percentile scores (ranging between 0-100) for global validation metrics of the entry are shown in the following graphic. The table shows the number of entries on which the scores are based.

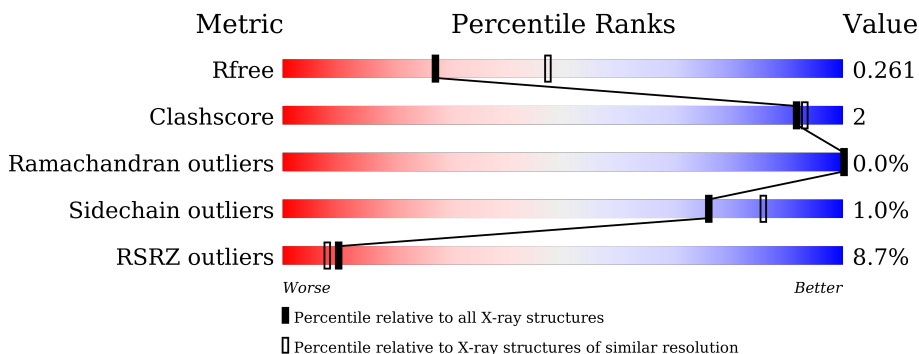

Metric	Whole archive (#Entries)	Similar resolution (#Entries, resolution range(Å))
R_{free}	130704	1332 (2.68-2.64)
Clashscore	141614	1374 (2.68-2.64)
Ramachandran outliers	138981	1349 (2.68-2.64)
Sidechain outliers	138945	1349 (2.68-2.64)
RSRZ outliers	127900	1318 (2.68-2.64)

The table below summarises the geometric issues observed across the polymeric chains and their fit to the electron density. The red, orange, yellow and green segments of the lower bar indicate the fraction of residues that contain outliers for ≥ 3 , 2, 1 and 0 types of geometric quality criteria respectively. A grey segment represents the fraction of residues that are not modelled. The numeric value for each fraction is indicated below the corresponding segment, with a dot representing fractions $\leq 5\%$. The upper red bar (where present) indicates the fraction of residues that have poor fit to the electron density. The numeric value is given above the bar.

Mol	Chain	Length	Quality of chain
1	A	450	 % 94%
1	C	450	 % 96%
2	B	445	 3% 91%
2	D	445	 18% 87% 7% 5%
3	E	143	 6% 83% 15%
4	F	384	 20% 83% 5% 12%

2 Entry composition i

There are 13 unique types of molecules in this entry. The entry contains 34882 atoms, of which 16913 are hydrogens and 0 are deuteriums.

In the tables below, the ZeroOcc column contains the number of atoms modelled with zero occupancy, the AltConf column contains the number of residues with at least one atom in alternate conformation and the Trace column contains the number of residues modelled with at most 2 atoms.

- Molecule 1 is a protein called Tubulin alpha-1B chain.

Mol	Chain	Residues	Atoms					ZeroOcc	AltConf	Trace	
			Total	C	H	N	O				S
1	A	437	6772	2174	3335	585	654	24	0	3	0
1	C	440	6783	2178	3340	585	657	23	0	1	0

- Molecule 2 is a protein called Tubulin beta chain.

Mol	Chain	Residues	Atoms					ZeroOcc	AltConf	Trace	
			Total	C	H	N	O				S
2	B	427	6589	2110	3228	576	649	26	0	0	0
2	D	421	6486	2080	3177	562	640	27	0	0	0

- Molecule 3 is a protein called Stathmin-4.

Mol	Chain	Residues	Atoms					ZeroOcc	AltConf	Trace	
			Total	C	H	N	O				S
3	E	121	2043	627	1025	186	200	5	0	2	0

There are 2 discrepancies between the modelled and reference sequences:

Chain	Residue	Modelled	Actual	Comment	Reference
E	3	MET	-	expression tag	UNP P63043
E	4	ALA	-	expression tag	UNP P63043

- Molecule 4 is a protein called Tubulin tyrosine ligase.

Mol	Chain	Residues	Atoms					ZeroOcc	AltConf	Trace	
			Total	C	H	N	O				S
4	F	338	5494	1785	2709	482	504	14	0	0	0

There are 6 discrepancies between the modelled and reference sequences:

Chain	Residue	Modelled	Actual	Comment	Reference
F	379	HIS	-	expression tag	UNP E1BQ43
F	380	HIS	-	expression tag	UNP E1BQ43
F	381	HIS	-	expression tag	UNP E1BQ43
F	382	HIS	-	expression tag	UNP E1BQ43
F	383	HIS	-	expression tag	UNP E1BQ43
F	384	HIS	-	expression tag	UNP E1BQ43

- Molecule 5 is GUANOSINE-5'-TRIPHOSPHATE (three-letter code: GTP) (formula: $C_{10}H_{16}N_5O_{14}P_3$).

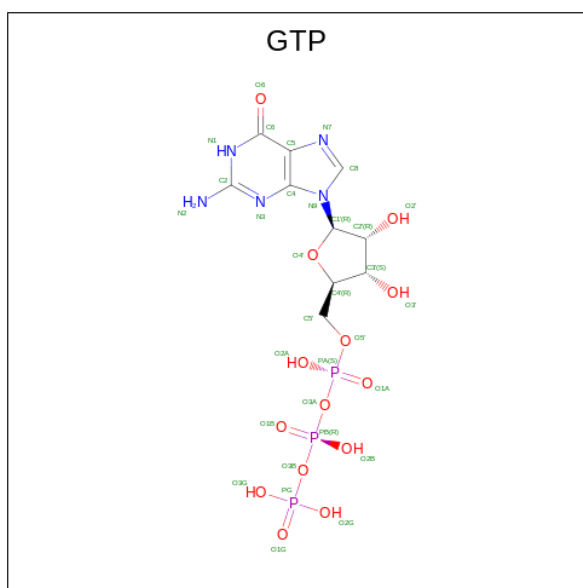

Mol	Chain	Residues	Atoms					ZeroOcc	AltConf	
			Total	C	H	N	O			P
5	A	1	Total	C	H	N	O	P	0	0
			42	10	10	5	14	3		
5	C	1	Total	C	H	N	O	P	0	0
			42	10	10	5	14	3		
5	D	1	Total	C	H	N	O	P	0	0
			42	10	10	5	14	3		

- Molecule 6 is MAGNESIUM ION (three-letter code: MG) (formula: Mg).

Mol	Chain	Residues	Atoms		ZeroOcc	AltConf
6	A	1	Total	Mg	0	0
			1	1		
6	B	1	Total	Mg	0	0
			1	1		
6	C	1	Total	Mg	0	0
			1	1		

Continued on next page...

Continued from previous page...

Mol	Chain	Residues	Atoms		ZeroOcc	AltConf
6	D	1	Total	Mg	0	0
			1	1		

- Molecule 7 is CALCIUM ION (three-letter code: CA) (formula: Ca).

Mol	Chain	Residues	Atoms		ZeroOcc	AltConf
7	A	1	Total	Ca	0	0
			1	1		
7	C	1	Total	Ca	0	0
			1	1		

- Molecule 8 is GLYCEROL (three-letter code: GOL) (formula: C₃H₈O₃).

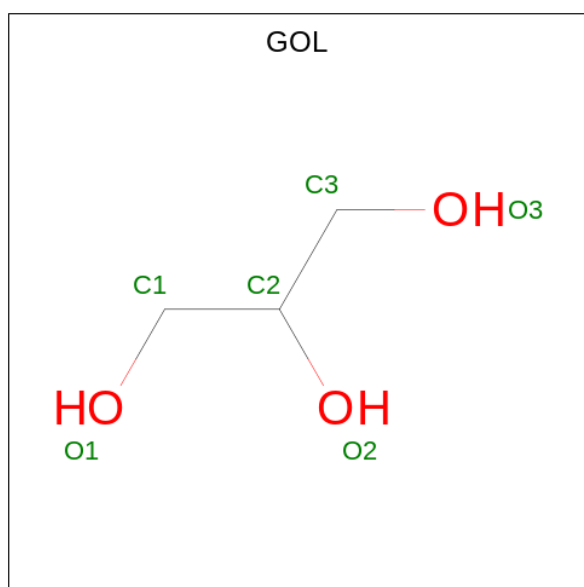

Mol	Chain	Residues	Atoms				ZeroOcc	AltConf
8	A	1	Total	C	H	O	0	0
			14	3	8	3		

- Molecule 9 is GUANOSINE-5'-DIPHOSPHATE (three-letter code: GDP) (formula: C₁₀H₁₅N₅O₁₁P₂).

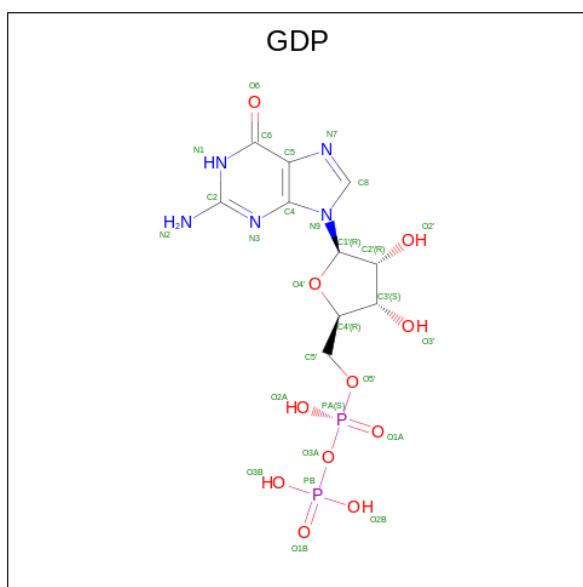

Mol	Chain	Residues	Atoms					ZeroOcc	AltConf	
			Total	C	H	N	O			P
9	B	1	38	10	10	5	11	2	0	0

- Molecule 10 is 2-(N-MORPHOLINO)-ETHANESULFONIC ACID (three-letter code: MES) (formula: C₆H₁₃NO₄S).

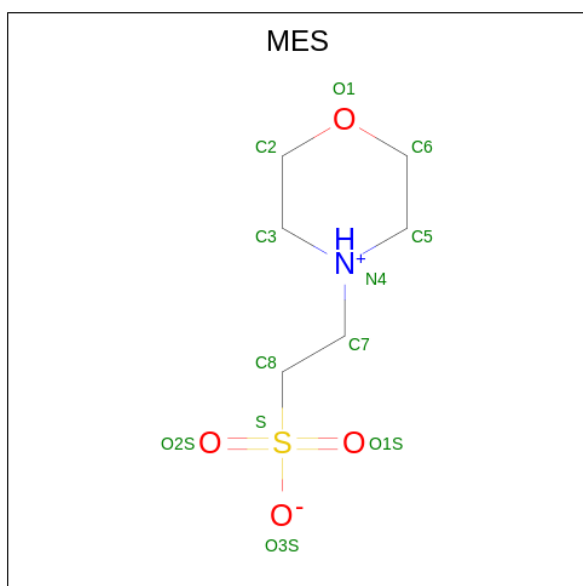

Mol	Chain	Residues	Atoms					ZeroOcc	AltConf	
			Total	C	H	N	O			S
10	B	1	25	6	13	1	4	1	0	0

- Molecule 11 is N-[(3-phenoxyphenyl)methyl]-9H-beta-carboline-3-amine (three-letter code: AEU) (formula: C₂₄H₁₉N₃O) (labeled as "Ligand of Interest" by depositor).

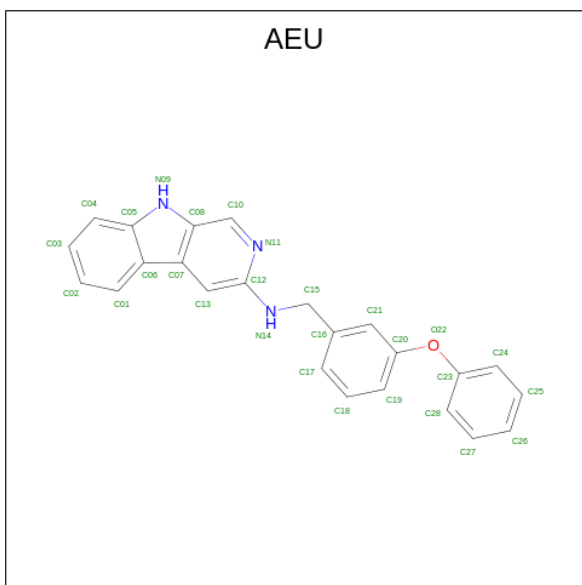

Mol	Chain	Residues	Atoms					ZeroOcc	AltConf
11	B	1	Total	C	H	N	O	0	0
			47	24	19	3	1		
11	D	1	Total	C	H	N	O	0	0
			47	24	19	3	1		

- Molecule 12 is PHOSPHOMETHYLPHOSPHONIC ACID ADENYLATE ESTER (three-letter code: ACP) (formula: C₁₁H₁₈N₅O₁₂P₃).

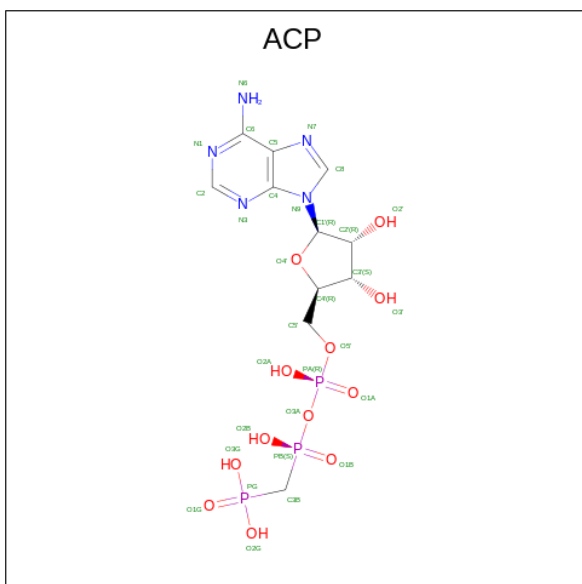

Mol	Chain	Residues	Atoms					ZeroOcc	AltConf
12	F	1	Total	C	N	O	P	0	0
			31	11	5	12	3		

- Molecule 13 is water.

Mol	Chain	Residues	Atoms		ZeroOcc	AltConf
13	A	104	Total 104	O 104	0	0
13	B	69	Total 69	O 69	0	0
13	C	120	Total 120	O 120	0	0
13	D	35	Total 35	O 35	0	0
13	E	13	Total 13	O 13	0	0
13	F	40	Total 40	O 40	0	0

3 Residue-property plots [i](#)

These plots are drawn for all protein, RNA, DNA and oligosaccharide chains in the entry. The first graphic for a chain summarises the proportions of the various outlier classes displayed in the second graphic. The second graphic shows the sequence view annotated by issues in geometry and electron density. Residues are color-coded according to the number of geometric quality criteria for which they contain at least one outlier: green = 0, yellow = 1, orange = 2 and red = 3 or more. A red dot above a residue indicates a poor fit to the electron density ($RSRZ > 2$). Stretches of 2 or more consecutive residues without any outlier are shown as a green connector. Residues present in the sample, but not in the model, are shown in grey.

- Molecule 1: Tubulin alpha-1B chain



- Molecule 1: Tubulin alpha-1B chain

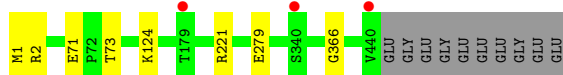

- Molecule 2: Tubulin beta chain

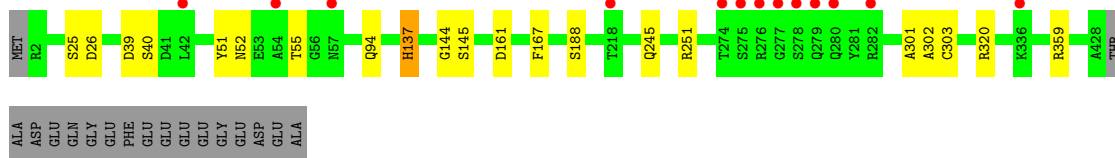
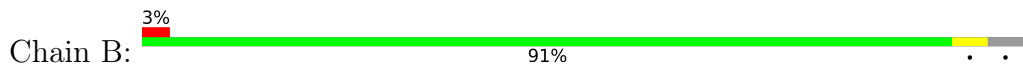

- Molecule 2: Tubulin beta chain

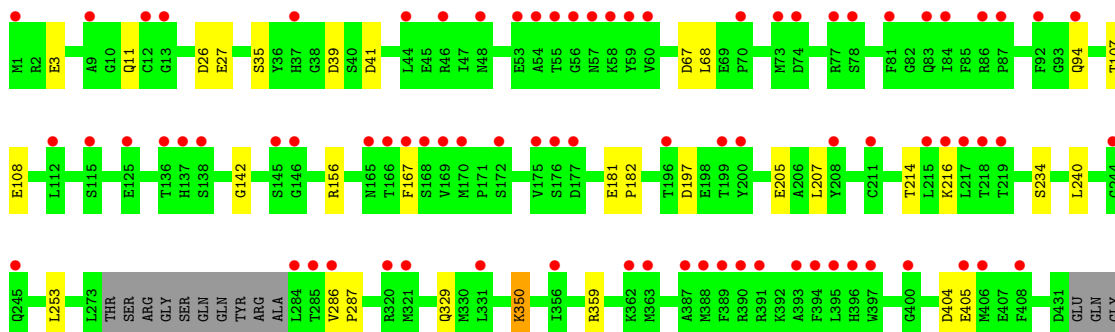
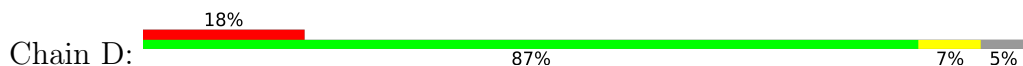

GLU
PHE
GLU
GLU
GLU
GLU
GLY
GLY
ASP
GLU
ALA

• Molecule 3: Stathmin-4

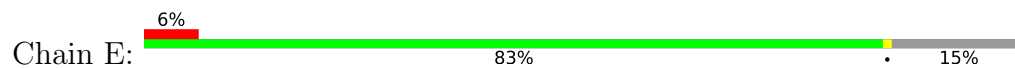

MET
ALA
ASP
R6
E7
L24
K25
S28
PHE
ASP
GLY
VAL
PRO
GLU
PHE
ASN
ALA
SER
LEU
PRO
ARG
ARG
ARG
D44
K75
N92
D128
E131
K135
E138
L139
K140
E141
GLU
ALA
SER
ARG

• Molecule 4: Tubulin tyrosine ligase

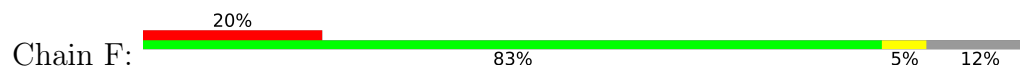

M1
L20
L21
L22
A23
T24
G25
Q26
W27
R31
R36
R46
K82
I100
Y101
P102
T103
ASN
LEU
LYS
THR
PRO
VAL
ALA
PRO
ALA
GLN
ASN
GLY
ILE
ARG
HIS
LEU
ILE
ASN
ASN
THR
ARG
THR
D126
E127
R128
E129
V130
F131
L132
A133
A134
Y135
M136
R137
R138
R139
E140
G141
R142
E143
G144
N145
V146
V147
I148
A149
LYS
SER
SER
ALA
GLY
ALA
LYS
LYS
GLY
GLY
ILE
L161
I162
S163
S164
E165
A166
S167
E168
L169
L170
D171
F172
I173
D174
E175
Q176
Q177
Q178
V179
H180
V181
I182
Y185
R197
K198
F199
D200
T223
S224
S225
E226
S230
A231
N232
F233
Q234
R235
K236
H239
L240
T241
N242
I245
Q246
K247
GLU
TYR
SER
LYS
N252
Y253
G254
R255
Y256
E257
E299
P300
T304
Q310
G316
R320
E331
C338
A339
P352
L361
A362
ASP
THR
GLY
GLN
LYS
THR
SER
GLN
PRO
T372
H382
H383
H384

4 Data and refinement statistics

Property	Value	Source
Space group	P 21 21 21	Depositor
Cell constants a, b, c, α , β , γ	105.09Å 156.83Å 182.41Å 90.00° 90.00° 90.00°	Depositor
Resolution (Å)	39.76 – 2.66 39.76 – 2.66	Depositor EDS
% Data completeness (in resolution range)	98.2 (39.76-2.66) 98.2 (39.76-2.66)	Depositor EDS
R_{merge}	(Not available)	Depositor
R_{sym}	(Not available)	Depositor
$\langle I/\sigma(I) \rangle$ ¹	2.63 (at 2.65Å)	Xtrriage
Refinement program	PHENIX 1.8.4_1496	Depositor
R, R_{free}	0.222 , 0.257 0.225 , 0.261	Depositor DCC
R_{free} test set	4281 reflections (5.00%)	wwPDB-VP
Wilson B-factor (Å ²)	41.2	Xtrriage
Anisotropy	0.093	Xtrriage
Bulk solvent k_{sol} (e/Å ³), B_{sol} (Å ²)	0.35 , 43.5	EDS
L-test for twinning ²	$\langle L \rangle = 0.50$, $\langle L^2 \rangle = 0.34$	Xtrriage
Estimated twinning fraction	No twinning to report.	Xtrriage
F_o, F_c correlation	0.92	EDS
Total number of atoms	34882	wwPDB-VP
Average B, all atoms (Å ²)	57.0	wwPDB-VP

Xtrriage's analysis on translational NCS is as follows: *The largest off-origin peak in the Patterson function is 2.88% of the height of the origin peak. No significant pseudotranslation is detected.*

¹Intensities estimated from amplitudes.

²Theoretical values of $\langle |L| \rangle$, $\langle L^2 \rangle$ for acentric reflections are 0.5, 0.333 respectively for untwinned datasets, and 0.375, 0.2 for perfectly twinned datasets.

5 Model quality [i](#)

5.1 Standard geometry [i](#)

Bond lengths and bond angles in the following residue types are not validated in this section: AEU, MG, GDP, GTP, GOL, MES, ACP, CA

The Z score for a bond length (or angle) is the number of standard deviations the observed value is removed from the expected value. A bond length (or angle) with $|Z| > 5$ is considered an outlier worth inspection. RMSZ is the root-mean-square of all Z scores of the bond lengths (or angles).

Mol	Chain	Bond lengths		Bond angles	
		RMSZ	# Z >5	RMSZ	# Z >5
1	A	0.23	0/3515	0.39	0/4771
1	C	0.23	0/3521	0.38	0/4781
2	B	0.23	0/3436	0.39	0/4654
2	D	0.23	0/3382	0.38	0/4581
3	E	0.21	0/1027	0.32	0/1363
4	F	0.22	0/2851	0.37	0/3851
All	All	0.22	0/17732	0.38	0/24001

There are no bond length outliers.

There are no bond angle outliers.

There are no chirality outliers.

There are no planarity outliers.

5.2 Too-close contacts [i](#)

In the following table, the Non-H and H(model) columns list the number of non-hydrogen atoms and hydrogen atoms in the chain respectively. The H(added) column lists the number of hydrogen atoms added and optimized by MolProbity. The Clashes column lists the number of clashes within the asymmetric unit, whereas Symm-Clashes lists symmetry-related clashes.

Mol	Chain	Non-H	H(model)	H(added)	Clashes	Symm-Clashes
1	A	3437	3335	3346	7	0
1	C	3443	3340	3353	5	0
2	B	3361	3228	3238	9	0
2	D	3309	3177	3189	17	0
3	E	1018	1025	1029	1	0
4	F	2785	2709	2737	15	0
5	A	32	10	12	0	0

Continued on next page...

Continued from previous page...

Mol	Chain	Non-H	H(model)	H(added)	Clashes	Symm-Clashes
5	C	32	10	12	0	0
5	D	32	10	12	1	0
6	A	1	0	0	0	0
6	B	1	0	0	0	0
6	C	1	0	0	0	0
6	D	1	0	0	0	0
7	A	1	0	0	0	0
7	C	1	0	0	0	0
8	A	6	8	8	0	0
9	B	28	10	12	0	0
10	B	12	13	12	0	0
11	B	28	19	0	0	0
11	D	28	19	0	1	0
12	F	31	0	14	6	0
13	A	104	0	0	1	0
13	B	69	0	0	1	0
13	C	120	0	0	3	0
13	D	35	0	0	3	0
13	E	13	0	0	1	0
13	F	40	0	0	2	0
All	All	17969	16913	16974	55	0

The all-atom clashscore is defined as the number of clashes found per 1000 atoms (including hydrogen atoms). The all-atom clashscore for this structure is 2.

The worst 5 of 55 close contacts within the same asymmetric unit are listed below, sorted by their clash magnitude.

Atom-1	Atom-2	Interatomic distance (Å)	Clash overlap (Å)
4:F:242:ASN:OD1	12:F:401:ACP:H5'1	1.62	0.98
4:F:331:GLU:OE2	12:F:401:ACP:O2G	1.93	0.87
12:F:401:ACP:O2G	12:F:401:ACP:O1B	2.05	0.74
2:D:207:LEU:O	13:D:601:HOH:O	2.09	0.70
2:D:214:THR:N	13:D:604:HOH:O	2.28	0.66

There are no symmetry-related clashes.

5.3 Torsion angles [i](#)

5.3.1 Protein backbone [i](#)

In the following table, the Percentiles column shows the percent Ramachandran outliers of the chain as a percentile score with respect to all X-ray entries followed by that with respect to entries of similar resolution.

The Analysed column shows the number of residues for which the backbone conformation was analysed, and the total number of residues.

Mol	Chain	Analysed	Favoured	Allowed	Outliers	Percentiles	
1	A	438/450 (97%)	424 (97%)	14 (3%)	0	100	100
1	C	439/450 (98%)	427 (97%)	12 (3%)	0	100	100
2	B	425/445 (96%)	411 (97%)	13 (3%)	1 (0%)	47	64
2	D	417/445 (94%)	403 (97%)	14 (3%)	0	100	100
3	E	119/143 (83%)	117 (98%)	2 (2%)	0	100	100
4	F	328/384 (85%)	309 (94%)	19 (6%)	0	100	100
All	All	2166/2317 (94%)	2091 (96%)	74 (3%)	1 (0%)	100	100

All (1) Ramachandran outliers are listed below:

Mol	Chain	Res	Type
2	B	302	ALA

5.3.2 Protein sidechains [i](#)

In the following table, the Percentiles column shows the percent sidechain outliers of the chain as a percentile score with respect to all X-ray entries followed by that with respect to entries of similar resolution.

The Analysed column shows the number of residues for which the sidechain conformation was analysed, and the total number of residues.

Mol	Chain	Analysed	Rotameric	Outliers	Percentiles	
1	A	371/378 (98%)	368 (99%)	3 (1%)	81	89
1	C	372/378 (98%)	370 (100%)	2 (0%)	88	94
2	B	369/383 (96%)	364 (99%)	5 (1%)	67	81
2	D	364/383 (95%)	356 (98%)	8 (2%)	52	70
3	E	111/127 (87%)	110 (99%)	1 (1%)	78	87
4	F	305/342 (89%)	304 (100%)	1 (0%)	92	96

Continued on next page...

Continued from previous page...

Mol	Chain	Analysed	Rotameric	Outliers	Percentiles
All	All	1892/1991 (95%)	1872 (99%)	20 (1%)	76 85

5 of 20 residues with a non-rotameric sidechain are listed below:

Mol	Chain	Res	Type
2	D	167	PHE
2	D	350	LYS
4	F	310	GLN
3	E	75	LYS
2	B	245	GLN

Sometimes sidechains can be flipped to improve hydrogen bonding and reduce clashes. All (2) such sidechains are listed below:

Mol	Chain	Res	Type
2	B	190	HIS
4	F	180	HIS

5.3.3 RNA [i](#)

There are no RNA molecules in this entry.

5.4 Non-standard residues in protein, DNA, RNA chains [i](#)

There are no non-standard protein/DNA/RNA residues in this entry.

5.5 Carbohydrates [i](#)

There are no monosaccharides in this entry.

5.6 Ligand geometry [i](#)

Of 15 ligands modelled in this entry, 6 are monoatomic - leaving 9 for Mogul analysis.

In the following table, the Counts columns list the number of bonds (or angles) for which Mogul statistics could be retrieved, the number of bonds (or angles) that are observed in the model and the number of bonds (or angles) that are defined in the Chemical Component Dictionary. The Link column lists molecule types, if any, to which the group is linked. The Z score for a bond length (or angle) is the number of standard deviations the observed value is removed from the

expected value. A bond length (or angle) with $|Z| > 2$ is considered an outlier worth inspection. RMSZ is the root-mean-square of all Z scores of the bond lengths (or angles).

Mol	Type	Chain	Res	Link	Bond lengths			Bond angles		
					Counts	RMSZ	# Z > 2	Counts	RMSZ	# Z > 2
5	GTP	C	501	6	26,34,34	1.15	2 (7%)	32,54,54	1.45	6 (18%)
11	AEU	B	504	-	31,32,32	1.47	7 (22%)	42,44,44	1.05	3 (7%)
9	GDP	B	501	6	24,30,30	0.97	1 (4%)	30,47,47	1.12	3 (10%)
11	AEU	D	502	-	31,32,32	1.52	7 (22%)	42,44,44	1.07	5 (11%)
5	GTP	D	501	6	26,34,34	1.13	2 (7%)	32,54,54	1.44	6 (18%)
10	MES	B	503	-	12,12,12	2.21	1 (8%)	14,16,16	1.70	2 (14%)
12	ACP	F	401	-	27,33,33	1.37	3 (11%)	32,52,52	1.76	8 (25%)
8	GOL	A	504	-	5,5,5	0.37	0	5,5,5	0.25	0
5	GTP	A	501	6	26,34,34	1.16	2 (7%)	32,54,54	1.47	6 (18%)

In the following table, the Chirals column lists the number of chiral outliers, the number of chiral centers analysed, the number of these observed in the model and the number defined in the Chemical Component Dictionary. Similar counts are reported in the Torsion and Rings columns. '-' means no outliers of that kind were identified.

Mol	Type	Chain	Res	Link	Chirals	Torsions	Rings
5	GTP	C	501	6	-	6/18/38/38	0/3/3/3
11	AEU	B	504	-	-	0/9/9/9	0/5/5/5
9	GDP	B	501	6	-	5/12/32/32	0/3/3/3
11	AEU	D	502	-	-	0/9/9/9	0/5/5/5
5	GTP	D	501	6	-	3/18/38/38	0/3/3/3
10	MES	B	503	-	-	3/6/14/14	0/1/1/1
12	ACP	F	401	-	-	9/15/38/38	0/3/3/3
8	GOL	A	504	-	-	2/4/4/4	-
5	GTP	A	501	6	-	7/18/38/38	0/3/3/3

The worst 5 of 25 bond length outliers are listed below:

Mol	Chain	Res	Type	Atoms	Z	Observed(Å)	Ideal(Å)
10	B	503	MES	C8-S	-7.41	1.67	1.77
5	A	501	GTP	C5-C6	-4.19	1.38	1.47
5	C	501	GTP	C5-C6	-4.13	1.39	1.47
5	D	501	GTP	C5-C6	-4.02	1.39	1.47
12	F	401	ACP	C2'-C1'	-3.17	1.48	1.53

The worst 5 of 39 bond angle outliers are listed below:

Mol	Chain	Res	Type	Atoms	Z	Observed(°)	Ideal(°)
11	B	504	AEU	C10-N11-C12	4.10	121.95	117.81
12	F	401	ACP	N3-C2-N1	-4.06	122.33	128.68
11	D	502	AEU	C10-N11-C12	4.01	121.86	117.81
10	B	503	MES	C5-N4-C3	3.83	117.45	108.83
12	F	401	ACP	C4-C5-N7	-3.70	105.54	109.40

There are no chirality outliers.

5 of 35 torsion outliers are listed below:

Mol	Chain	Res	Type	Atoms
5	A	501	GTP	PB-O3B-PG-O2G
5	A	501	GTP	C5'-O5'-PA-O1A
5	A	501	GTP	C5'-O5'-PA-O2A
5	C	501	GTP	PB-O3B-PG-O2G
5	C	501	GTP	C5'-O5'-PA-O1A

There are no ring outliers.

3 monomers are involved in 8 short contacts:

Mol	Chain	Res	Type	Clashes	Symm-Clashes
11	D	502	AEU	1	0
5	D	501	GTP	1	0
12	F	401	ACP	6	0

The following is a two-dimensional graphical depiction of Mogul quality analysis of bond lengths, bond angles, torsion angles, and ring geometry for all instances of the Ligand of Interest. In addition, ligands with molecular weight > 250 and outliers as shown on the validation Tables will also be included. For torsion angles, if less than 5% of the Mogul distribution of torsion angles is within 10 degrees of the torsion angle in question, then that torsion angle is considered an outlier. Any bond that is central to one or more torsion angles identified as an outlier by Mogul will be highlighted in the graph. For rings, the root-mean-square deviation (RMSD) between the ring in question and similar rings identified by Mogul is calculated over all ring torsion angles. If the average RMSD is greater than 60 degrees and the minimal RMSD between the ring in question and any Mogul-identified rings is also greater than 60 degrees, then that ring is considered an outlier. The outliers are highlighted in purple. The color gray indicates Mogul did not find sufficient equivalents in the CSD to analyse the geometry.

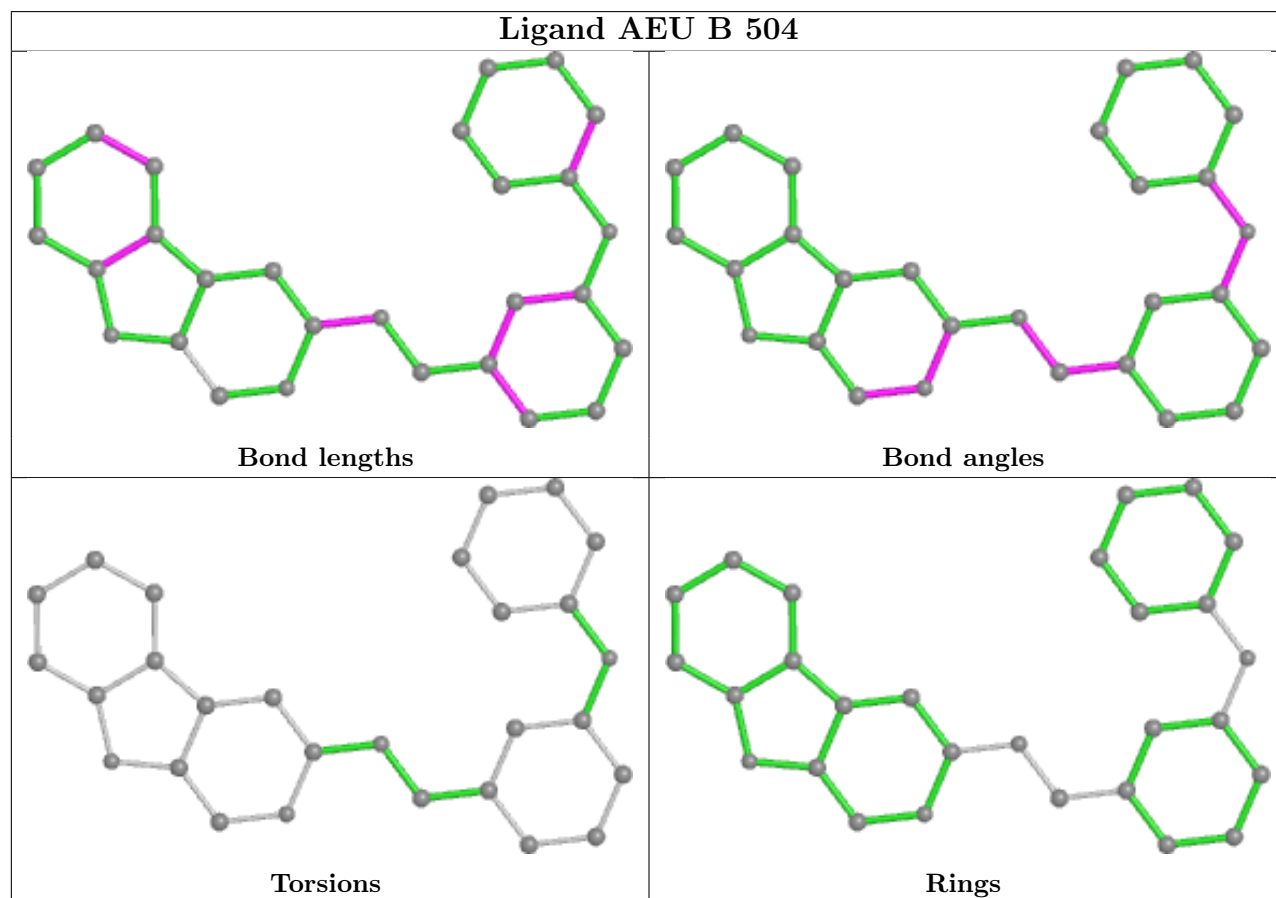
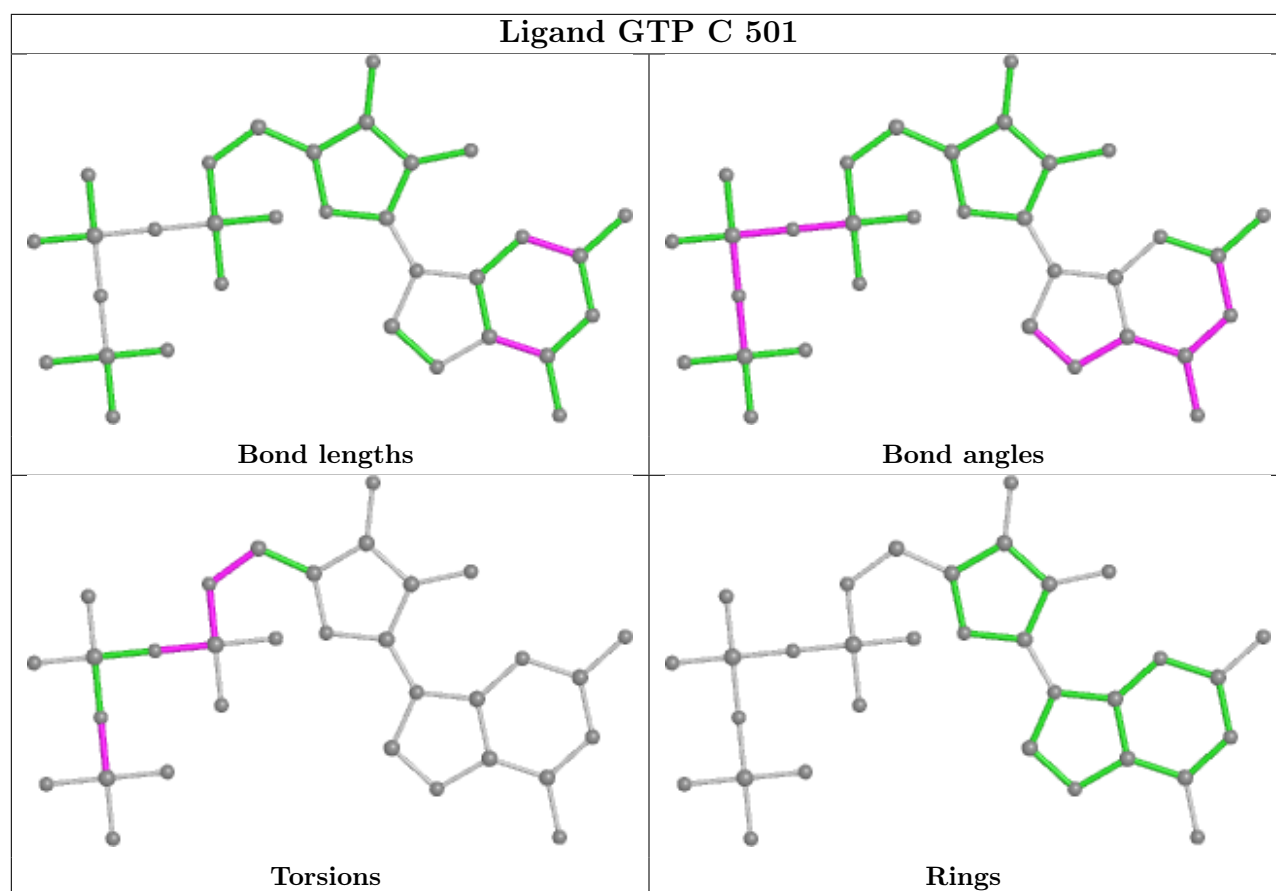

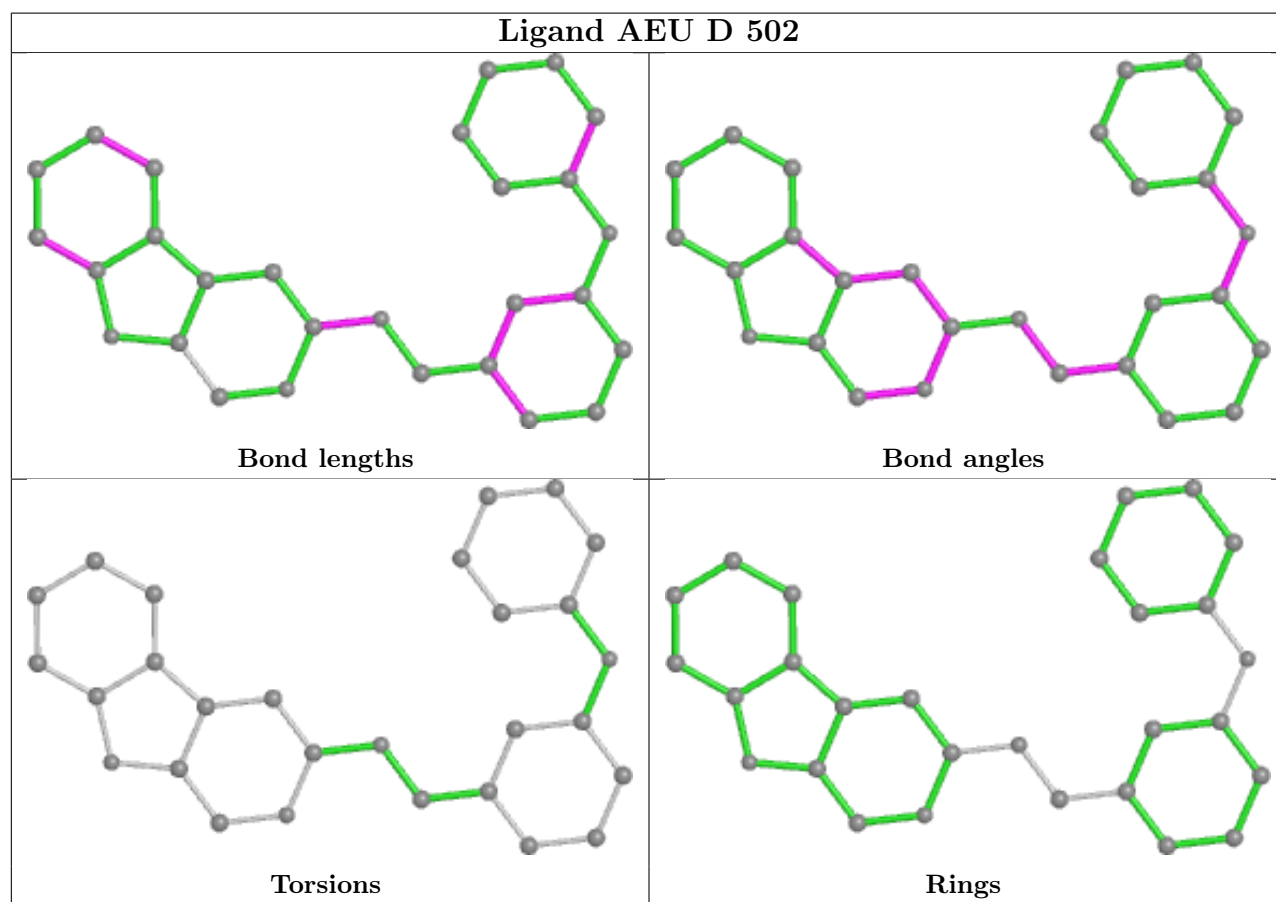
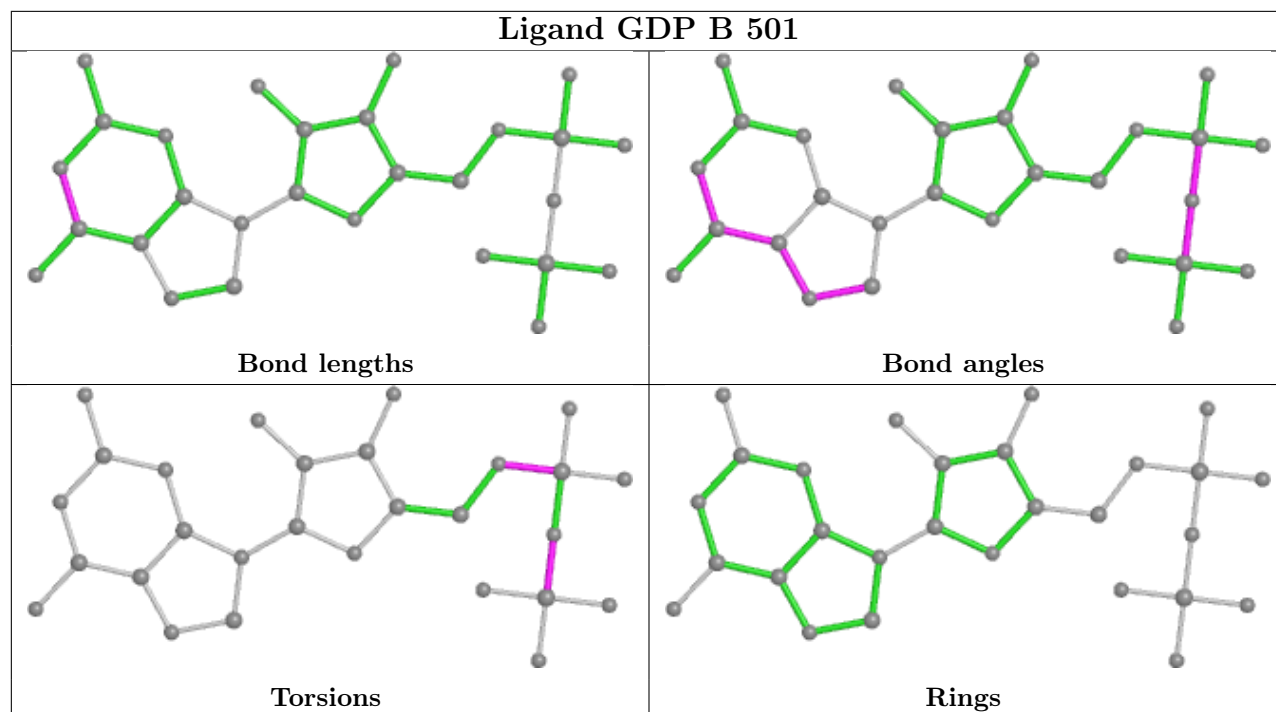

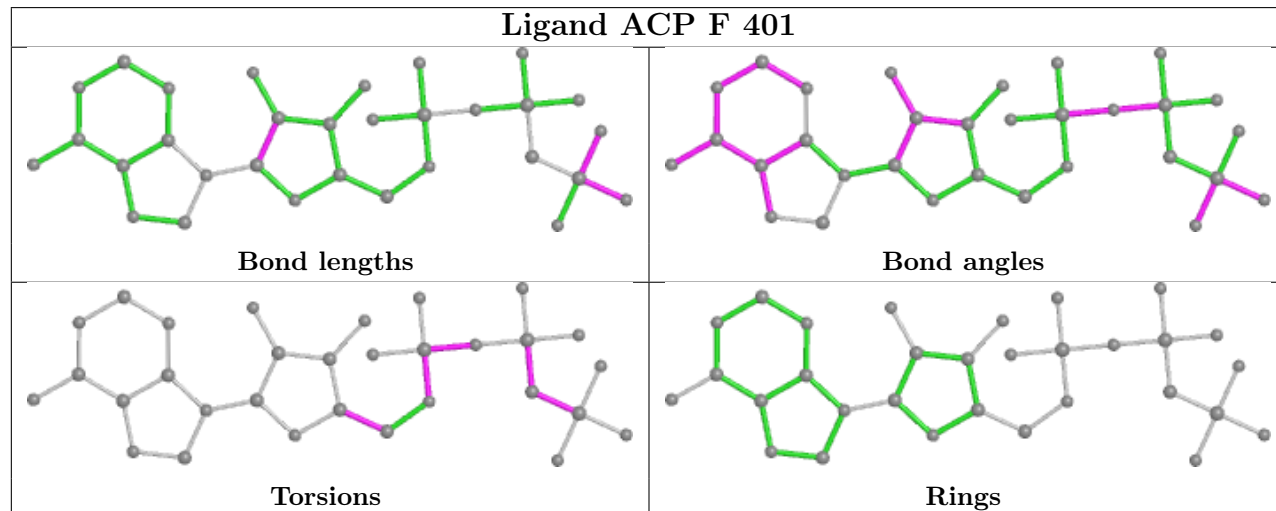
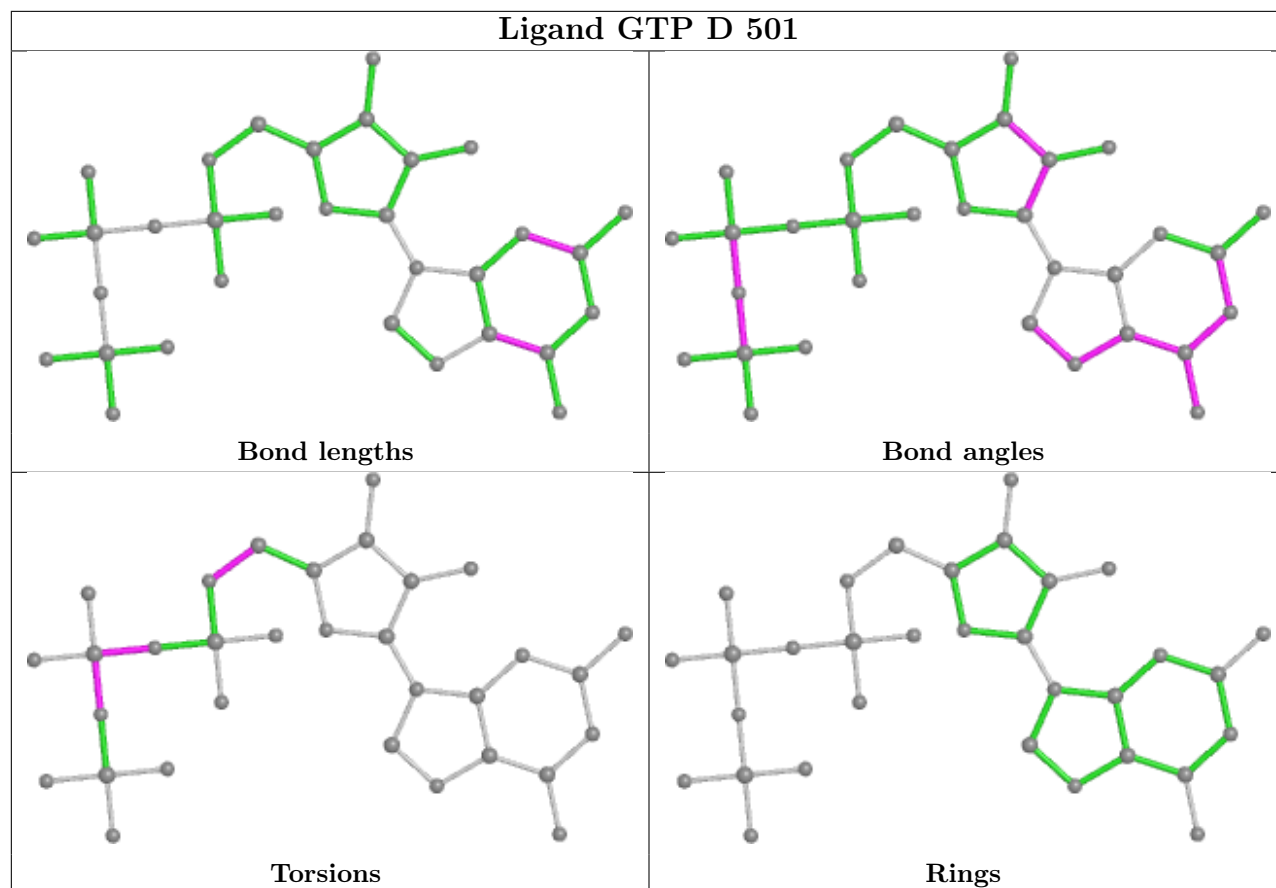

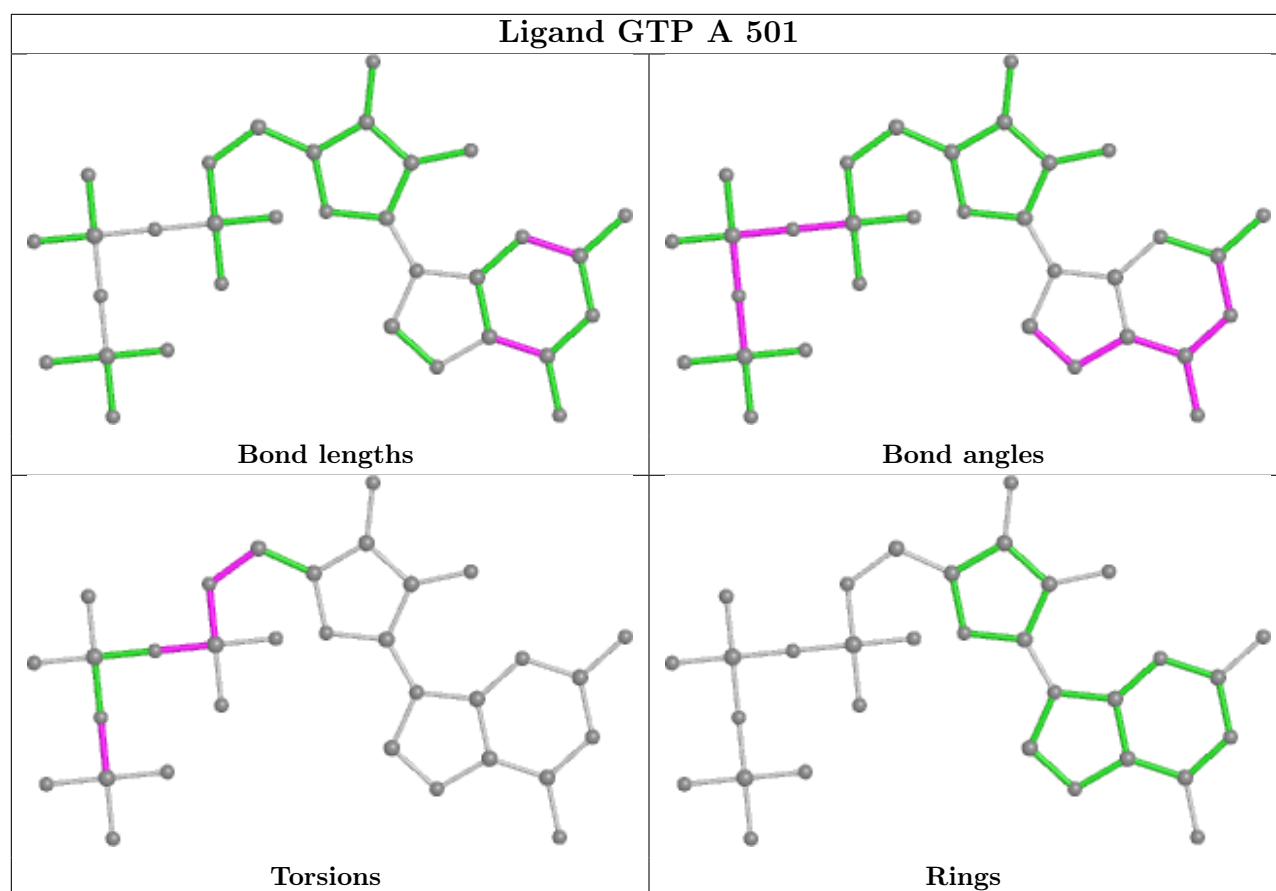

5.7 Other polymers [i](#)

There are no such residues in this entry.

5.8 Polymer linkage issues [i](#)

There are no chain breaks in this entry.

6 Fit of model and data [i](#)

6.1 Protein, DNA and RNA chains [i](#)

In the following table, the column labelled ‘#RSRZ > 2’ contains the number (and percentage) of RSRZ outliers, followed by percent RSRZ outliers for the chain as percentile scores relative to all X-ray entries and entries of similar resolution. The OWAB column contains the minimum, median, 95th percentile and maximum values of the occupancy-weighted average B-factor per residue. The column labelled ‘Q < 0.9’ lists the number of (and percentage) of residues with an average occupancy less than 0.9.

Mol	Chain	Analysed	<RSRZ>	#RSRZ>2	OWAB(Å ²)	Q<0.9
1	A	437/450 (97%)	0.07	5 (1%) 80 79	20, 37, 65, 91	0
1	C	440/450 (97%)	-0.22	3 (0%) 87 87	14, 29, 58, 108	0
2	B	427/445 (95%)	0.16	13 (3%) 50 47	17, 37, 80, 136	0
2	D	421/445 (94%)	1.11	81 (19%) 1 1	33, 67, 110, 139	0
3	E	121/143 (84%)	0.51	9 (7%) 14 12	25, 60, 97, 107	0
4	F	338/384 (88%)	1.19	78 (23%) 0 0	32, 72, 132, 153	0
All	All	2184/2317 (94%)	0.43	189 (8%) 10 8	14, 47, 107, 153	0

The worst 5 of 189 RSRZ outliers are listed below:

Mol	Chain	Res	Type	RSRZ
4	F	161	LEU	11.4
4	F	173	ILE	11.3
4	F	178	GLN	8.4
4	F	169	LEU	8.4
2	D	245	GLN	7.9

6.2 Non-standard residues in protein, DNA, RNA chains [i](#)

There are no non-standard protein/DNA/RNA residues in this entry.

6.3 Carbohydrates [i](#)

There are no monosaccharides in this entry.

6.4 Ligands

In the following table, the Atoms column lists the number of modelled atoms in the group and the number defined in the chemical component dictionary. The B-factors column lists the minimum, median, 95th percentile and maximum values of B factors of atoms in the group. The column labelled 'Q< 0.9' lists the number of atoms with occupancy less than 0.9.

Mol	Type	Chain	Res	Atoms	RSCC	RSR	B-factors(Å ²)	Q<0.9
11	AEU	D	502	28/28	0.76	0.38	59,79,101,112	0
6	MG	D	503	1/1	0.77	0.22	107,107,107,107	0
12	ACP	F	401	31/31	0.80	0.25	82,103,128,130	0
5	GTP	D	501	32/32	0.90	0.25	56,68,95,136	0
8	GOL	A	504	6/6	0.91	0.28	33,50,63,75	0
10	MES	B	503	12/12	0.93	0.18	30,43,61,85	0
11	AEU	B	504	28/28	0.95	0.21	24,31,39,46	0
9	GDP	B	501	28/28	0.96	0.19	12,25,30,36	0
7	CA	A	503	1/1	0.97	0.10	53,53,53,53	0
7	CA	C	503	1/1	0.97	0.04	33,33,33,33	0
6	MG	C	502	1/1	0.97	0.06	23,23,23,23	0
5	GTP	A	501	32/32	0.97	0.18	16,24,30,32	0
5	GTP	C	501	32/32	0.98	0.15	13,21,28,33	0
6	MG	B	502	1/1	0.98	0.19	23,23,23,23	0
6	MG	A	502	1/1	0.99	0.16	21,21,21,21	0

The following is a graphical depiction of the model fit to experimental electron density of all instances of the Ligand of Interest. In addition, ligands with molecular weight > 250 and outliers as shown on the geometry validation Tables will also be included. Each fit is shown from different orientation to approximate a three-dimensional view.

Electron density around AEU D 502:

$2mF_o-DF_c$ (at 0.7 rmsd) in gray
 mF_o-DF_c (at 3 rmsd) in purple (negative)
and green (positive)

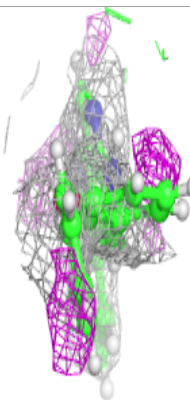
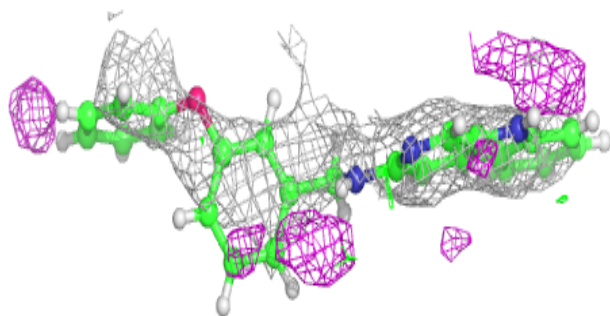
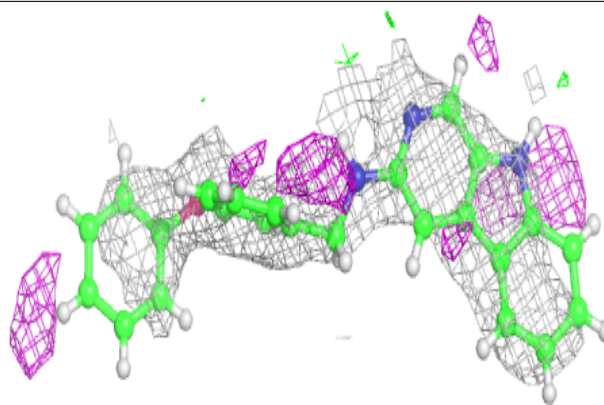
**Electron density around ACP F 401:**

$2mF_o-DF_c$ (at 0.7 rmsd) in gray
 mF_o-DF_c (at 3 rmsd) in purple (negative)
and green (positive)

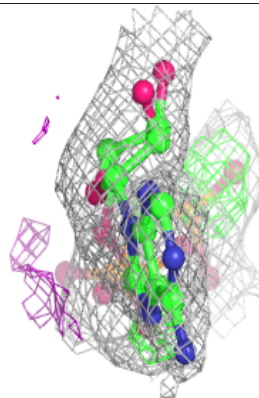
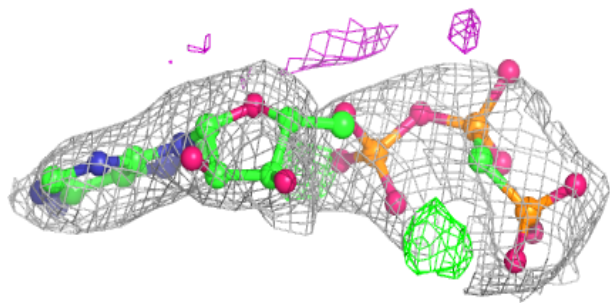
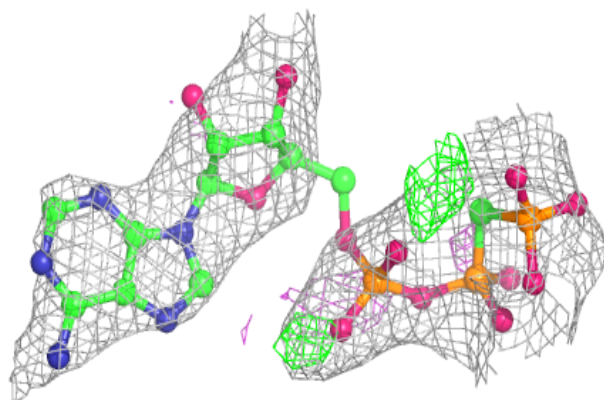

Electron density around GTP D 501:

$2mF_o-DF_c$ (at 0.7 rmsd) in gray
 mF_o-DF_c (at 3 rmsd) in purple (negative)
and green (positive)

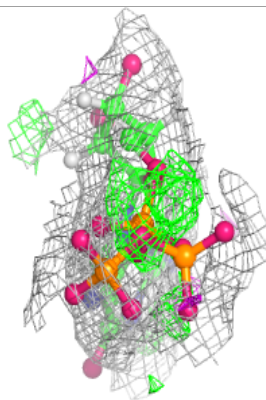
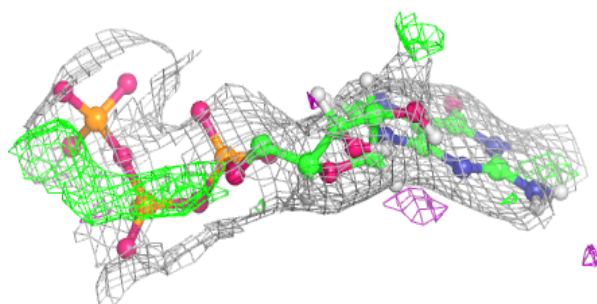
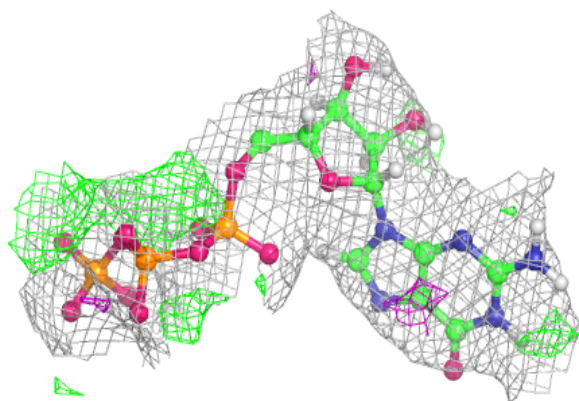
**Electron density around AEU B 504:**

$2mF_o-DF_c$ (at 0.7 rmsd) in gray
 mF_o-DF_c (at 3 rmsd) in purple (negative)
and green (positive)

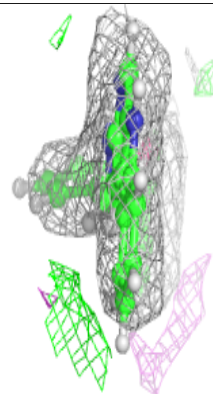
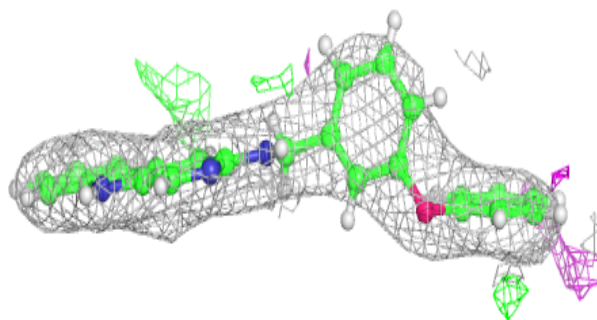
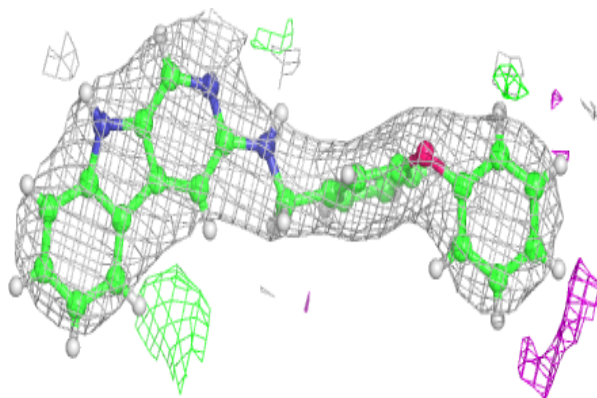

Electron density around GDP B 501:

$2mF_o-DF_c$ (at 0.7 rmsd) in gray
 mF_o-DF_c (at 3 rmsd) in purple (negative)
and green (positive)

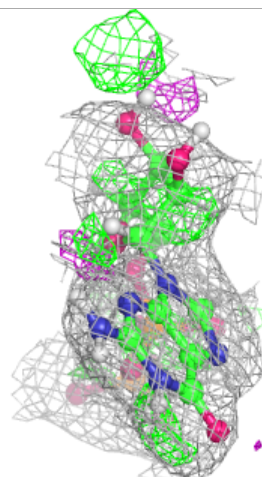
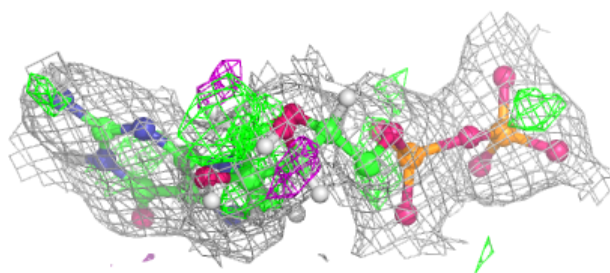
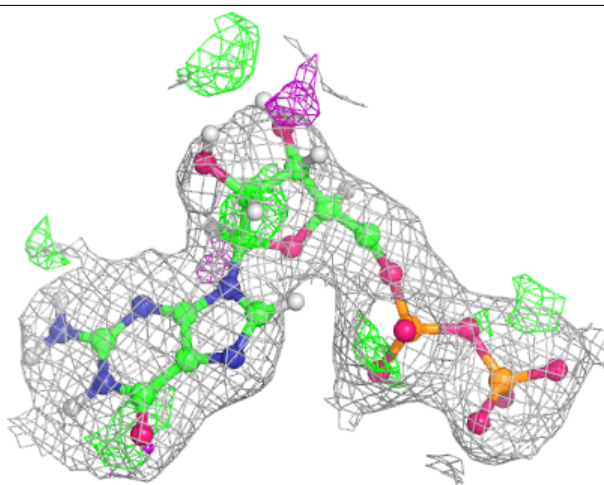

Electron density around GTP A 501:

$2mF_o-DF_c$ (at 0.7 rmsd) in gray
 mF_o-DF_c (at 3 rmsd) in purple (negative)
and green (positive)

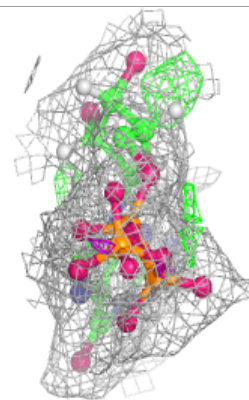
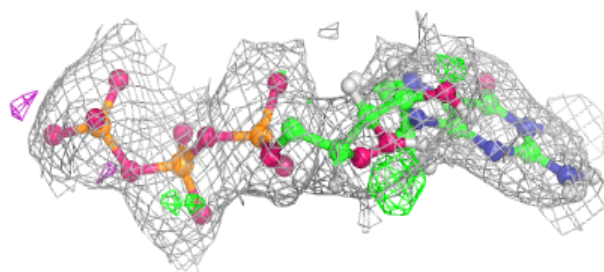
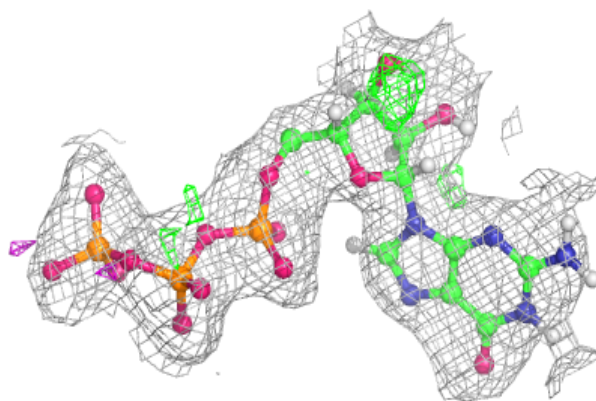
**Electron density around GTP C 501:**

$2mF_o-DF_c$ (at 0.7 rmsd) in gray
 mF_o-DF_c (at 3 rmsd) in purple (negative)
and green (positive)

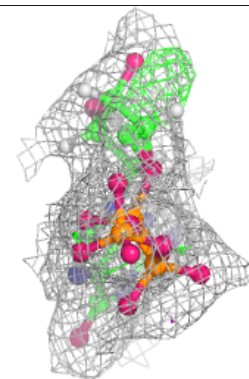
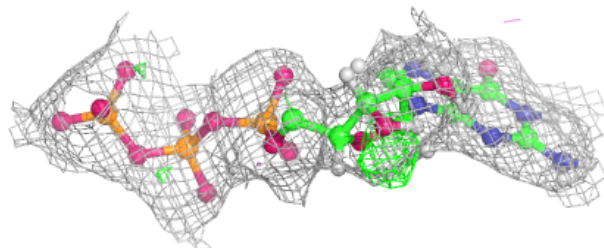
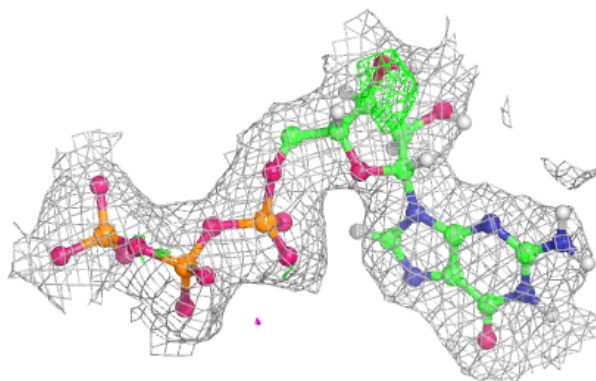

6.5 Other polymers [i](#)

There are no such residues in this entry.