



# wwPDB X-ray Structure Validation Summary Report ⓘ

Mar 5, 2024 – 05:17 PM EST

PDB ID : 3AXG  
Title : Structure of 6-aminohexanoate-oligomer hydrolase  
Authors : Negoro, S.; Shibata, N.; Tanaka, Y.; Yasuhira, K.; Shibata, H.; Hashimoto, H.; Lee, Y.H.; Ohshima, S.; Santa, R.; Mochiji, K.; Goto, Y.; Ikegami, T.; Nagai, K.; Kato, D.; Takeo, M.; Higuchi, Y.  
Deposited on : 2011-04-04  
Resolution : 2.00 Å(reported)

This is a wwPDB X-ray Structure Validation Summary Report for a publicly released PDB entry.

We welcome your comments at [validation@mail.wwpdb.org](mailto:validation@mail.wwpdb.org)

A user guide is available at

<https://www.wwpdb.org/validation/2017/XrayValidationReportHelp>

with specific help available everywhere you see the ⓘ symbol.

The types of validation reports are described at

<http://www.wwpdb.org/validation/2017/FAQs#types>.

---

The following versions of software and data (see [references ⓘ](#)) were used in the production of this report:

MolProbity : 4.02b-467  
Xtriage (Phenix) : 1.13  
EDS : 2.36  
Percentile statistics : 20191225.v01 (using entries in the PDB archive December 25th 2019)  
Refmac : 5.8.0158  
CCP4 : 7.0.044 (Gargrove)  
Ideal geometry (proteins) : Engh & Huber (2001)  
Ideal geometry (DNA, RNA) : Parkinson et al. (1996)  
Validation Pipeline (wwPDB-VP) : 2.36

# 1 Overall quality at a glance i

The following experimental techniques were used to determine the structure:

*X-RAY DIFFRACTION*

The reported resolution of this entry is 2.00 Å.

Percentile scores (ranging between 0-100) for global validation metrics of the entry are shown in the following graphic. The table shows the number of entries on which the scores are based.

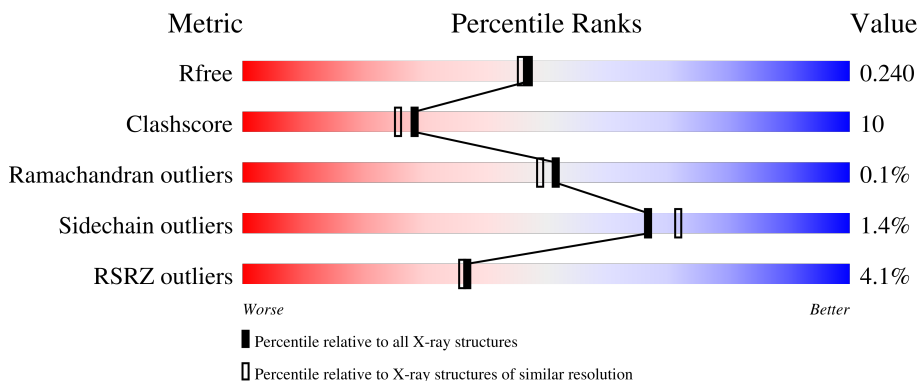

Metric	Whole archive (#Entries)	Similar resolution (#Entries, resolution range(Å))
$R_{free}$	130704	8085 (2.00-2.00)
Clashscore	141614	9178 (2.00-2.00)
Ramachandran outliers	138981	9054 (2.00-2.00)
Sidechain outliers	138945	9053 (2.00-2.00)
RSRZ outliers	127900	7900 (2.00-2.00)

The table below summarises the geometric issues observed across the polymeric chains and their fit to the electron density. The red, orange, yellow and green segments of the lower bar indicate the fraction of residues that contain outliers for  $\geq 3$ , 2, 1 and 0 types of geometric quality criteria respectively. A grey segment represents the fraction of residues that are not modelled. The numeric value for each fraction is indicated below the corresponding segment, with a dot representing fractions  $\leq 5\%$ . The upper red bar (where present) indicates the fraction of residues that have poor fit to the electron density. The numeric value is given above the bar.

Mol	Chain	Length	Quality of chain
1	A	355	<div style="display: flex; align-items: center;"> <div style="width: 3%; height: 10px; background-color: red; margin-right: 5px;"></div> <div style="width: 81%; height: 10px; background-color: green; margin-right: 5px;"></div> <div style="width: 16%; height: 10px; background-color: yellow; margin-right: 5px;"></div> <div style="width: 1%; height: 10px; background-color: grey; margin-right: 5px;"></div> </div> <p style="text-align: center;">81%      16%      .</p>
1	B	355	<div style="display: flex; align-items: center;"> <div style="width: 6%; height: 10px; background-color: red; margin-right: 5px;"></div> <div style="width: 74%; height: 10px; background-color: green; margin-right: 5px;"></div> <div style="width: 23%; height: 10px; background-color: yellow; margin-right: 5px;"></div> <div style="width: 1%; height: 10px; background-color: grey; margin-right: 5px;"></div> </div> <p style="text-align: center;">74%      23%      ..</p>
1	C	355	<div style="display: flex; align-items: center;"> <div style="width: 3%; height: 10px; background-color: red; margin-right: 5px;"></div> <div style="width: 81%; height: 10px; background-color: green; margin-right: 5px;"></div> <div style="width: 15%; height: 10px; background-color: yellow; margin-right: 5px;"></div> <div style="width: 1%; height: 10px; background-color: grey; margin-right: 5px;"></div> </div> <p style="text-align: center;">81%      15%      ..</p>
1	D	355	<div style="display: flex; align-items: center;"> <div style="width: 4%; height: 10px; background-color: red; margin-right: 5px;"></div> <div style="width: 79%; height: 10px; background-color: green; margin-right: 5px;"></div> <div style="width: 18%; height: 10px; background-color: yellow; margin-right: 5px;"></div> <div style="width: 1%; height: 10px; background-color: grey; margin-right: 5px;"></div> </div> <p style="text-align: center;">79%      18%      .</p>
1	E	355	<div style="display: flex; align-items: center;"> <div style="width: 7%; height: 10px; background-color: red; margin-right: 5px;"></div> <div style="width: 78%; height: 10px; background-color: green; margin-right: 5px;"></div> <div style="width: 19%; height: 10px; background-color: yellow; margin-right: 5px;"></div> <div style="width: 1%; height: 10px; background-color: grey; margin-right: 5px;"></div> </div> <p style="text-align: center;">78%      19%      .</p>

*Continued on next page...*

*Continued from previous page...*

Mol	Chain	Length	Quality of chain
1	F	355	<p>5% 77% 20% ..</p>
1	G	355	<p>3% 78% 18% .</p>
1	H	355	<p>8% 79% 17% .</p>
1	I	355	<p>8% 74% 22% ..</p>
1	J	355	<p>5% 81% 15% ..</p>
1	K	355	<p>4% 78% 17% ..</p>
1	L	355	<p>3% 80% 16% ..</p>
1	M	355	<p>1% 85% 12% .</p>
1	N	355	<p>0% 85% 11% .</p>
1	O	355	<p>0% 87% 10% .</p>

## 2 Entry composition

There are 3 unique types of molecules in this entry. The entry contains 40681 atoms, of which 0 are hydrogens and 0 are deuteriums.

In the tables below, the ZeroOcc column contains the number of atoms modelled with zero occupancy, the AltConf column contains the number of residues with at least one atom in alternate conformation and the Trace column contains the number of residues modelled with at most 2 atoms.

- Molecule 1 is a protein called Endotype 6-aminohexanoat-oligomer hydrolase.

Mol	Chain	Residues	Atoms					ZeroOcc	AltConf	Trace
			Total	C	N	O	S			
1	A	344	2522	1578	451	485	8	0	0	0
1	B	344	2522	1578	451	485	8	0	0	0
1	C	344	2522	1578	451	485	8	0	0	0
1	D	344	2522	1578	451	485	8	0	0	0
1	E	344	2522	1578	451	485	8	0	0	0
1	F	344	2522	1578	451	485	8	0	0	0
1	G	344	2522	1578	451	485	8	0	0	0
1	H	344	2522	1578	451	485	8	0	0	0
1	I	344	2522	1578	451	485	8	0	0	0
1	J	344	2522	1578	451	485	8	0	0	0
1	K	342	2511	1571	449	483	8	0	0	0
1	L	344	2522	1578	451	485	8	0	0	0
1	M	344	2522	1578	451	485	8	0	0	0
1	N	344	2522	1578	451	485	8	0	0	0
1	O	344	2522	1578	451	485	8	0	0	0

- Molecule 2 is SODIUM ION (three-letter code: NA) (formula: Na).

Mol	Chain	Residues	Atoms	ZeroOcc	AltConf
2	A	1	Total Na 1 1	0	0
2	K	1	Total Na 1 1	0	0
2	L	1	Total Na 1 1	0	0
2	M	1	Total Na 1 1	0	0
2	N	1	Total Na 1 1	0	0
2	O	1	Total Na 1 1	0	0

- Molecule 3 is water.

Mol	Chain	Residues	Atoms	ZeroOcc	AltConf
3	A	188	Total O 188 188	0	0
3	B	104	Total O 104 104	0	0
3	C	194	Total O 194 194	0	0
3	D	165	Total O 165 165	0	0
3	E	99	Total O 99 99	0	0
3	F	182	Total O 182 182	0	0
3	G	161	Total O 161 161	0	0
3	H	116	Total O 116 116	0	0
3	I	117	Total O 117 117	0	0
3	J	170	Total O 170 170	0	0
3	K	217	Total O 217 217	0	0
3	L	174	Total O 174 174	0	0
3	M	333	Total O 333 333	0	0
3	N	318	Total O 318 318	0	0

*Continued on next page...*

*Continued from previous page...*

<b>Mol</b>	<b>Chain</b>	<b>Residues</b>	<b>Atoms</b>		<b>ZeroOcc</b>	<b>AltConf</b>
3	O	318	Total 318	O 318	0	0

### 3 Residue-property plots [i](#)

These plots are drawn for all protein, RNA, DNA and oligosaccharide chains in the entry. The first graphic for a chain summarises the proportions of the various outlier classes displayed in the second graphic. The second graphic shows the sequence view annotated by issues in geometry and electron density. Residues are color-coded according to the number of geometric quality criteria for which they contain at least one outlier: green = 0, yellow = 1, orange = 2 and red = 3 or more. A red dot above a residue indicates a poor fit to the electron density ( $RSRZ > 2$ ). Stretches of 2 or more consecutive residues without any outlier are shown as a green connector. Residues present in the sample, but not in the model, are shown in grey.

- Molecule 1: Endotype 6-aminohexanoat-oligomer hydrolase

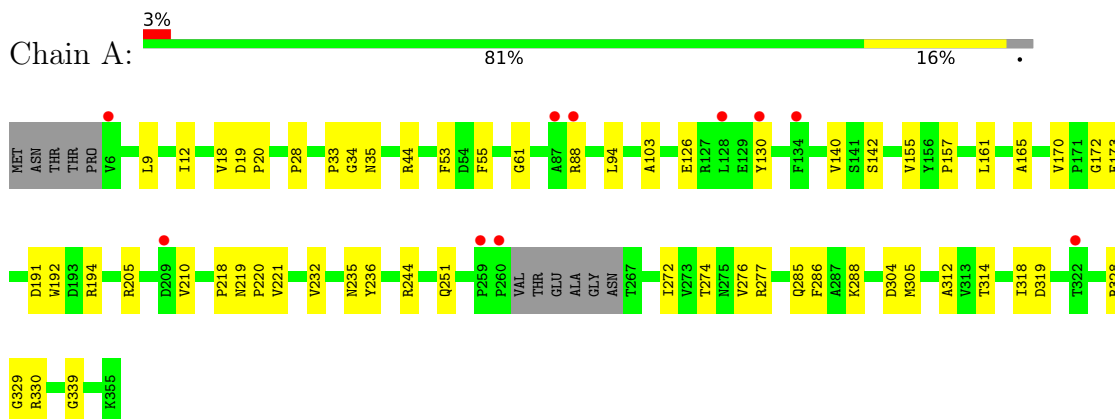

- Molecule 1: Endotype 6-aminohexanoat-oligomer hydrolase

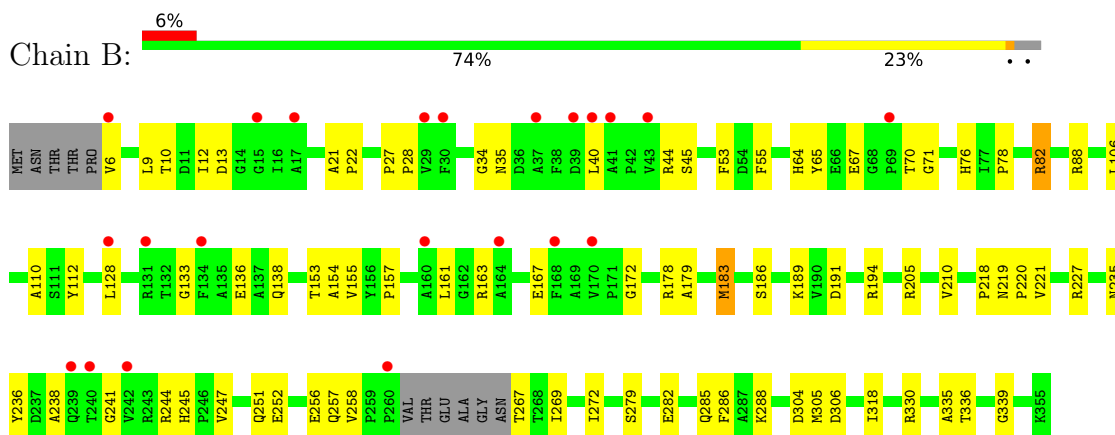

- Molecule 1: Endotype 6-aminohexanoat-oligomer hydrolase

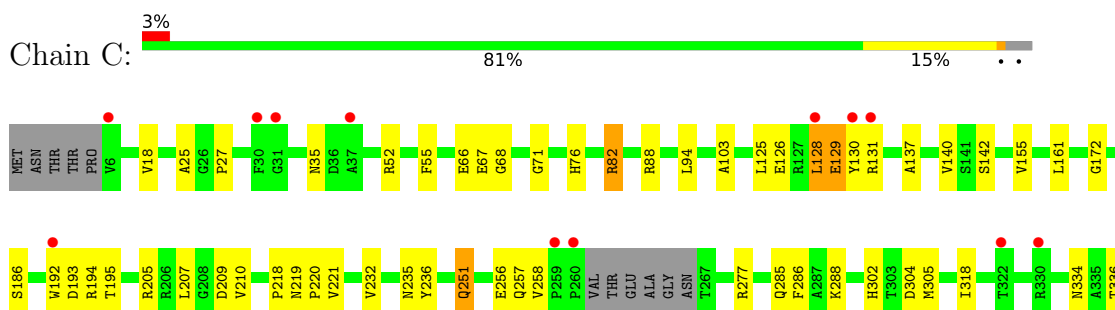



- Molecule 1: Endotype 6-aminohexanoat-oligomer hydrolase

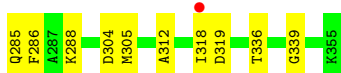
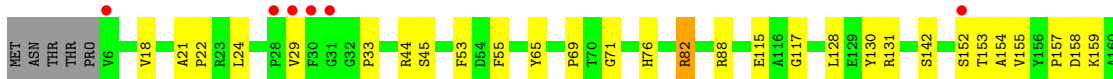
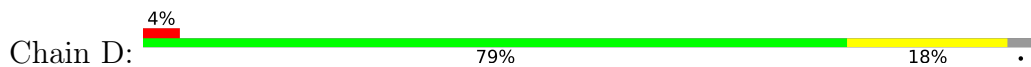

- Molecule 1: Endotype 6-aminohexanoat-oligomer hydrolase

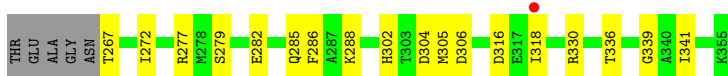
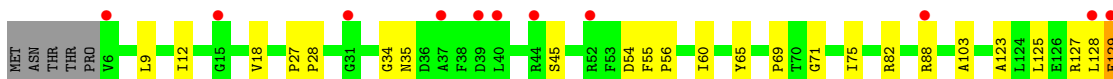
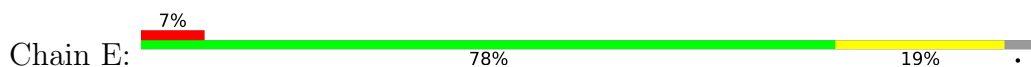

- Molecule 1: Endotype 6-aminohexanoat-oligomer hydrolase

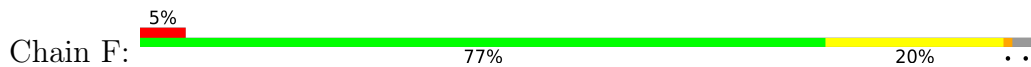

- Molecule 1: Endotype 6-aminohexanoat-oligomer hydrolase

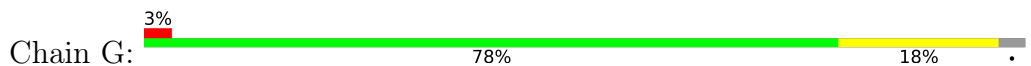



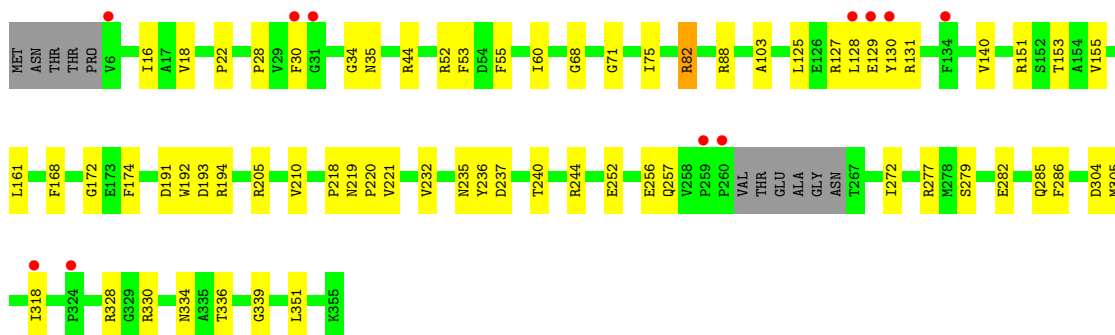

- Molecule 1: Endotype 6-aminohexanoat-oligomer hydrolase

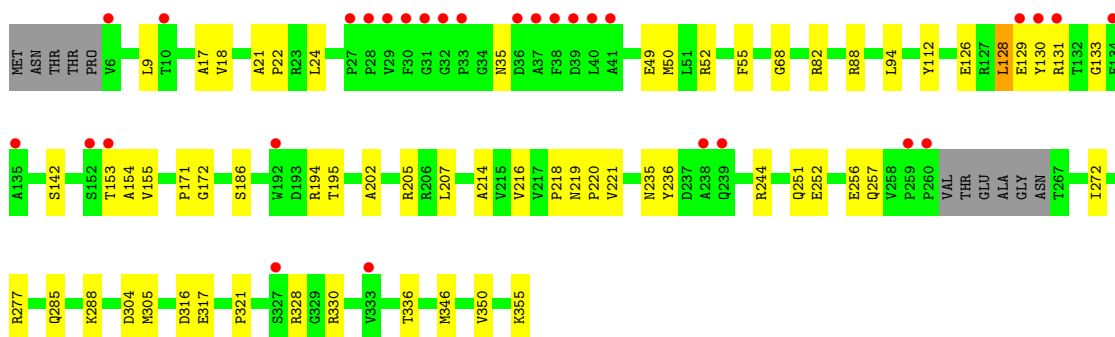
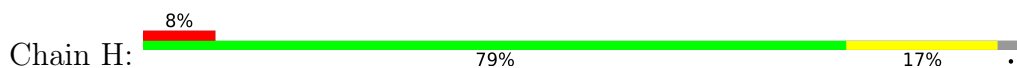

- Molecule 1: Endotype 6-aminohexanoat-oligomer hydrolase

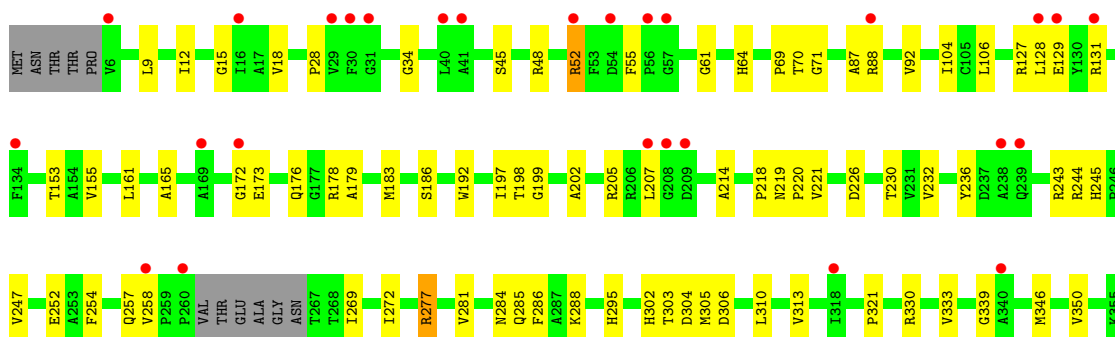
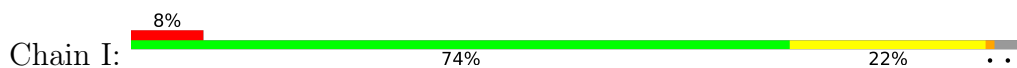

- Molecule 1: Endotype 6-aminohexanoat-oligomer hydrolase

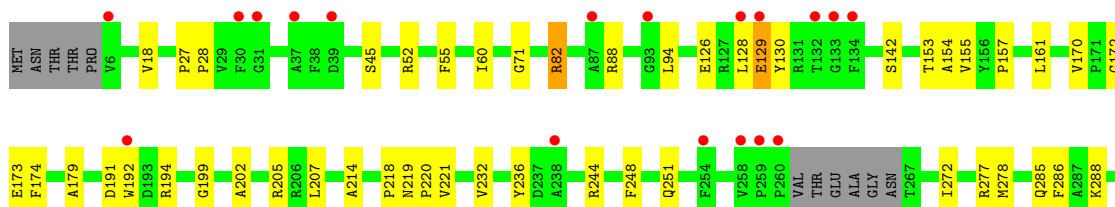
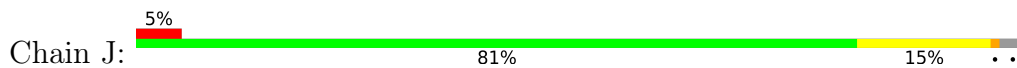



- Molecule 1: Endotype 6-aminohexanoat-oligomer hydrolase

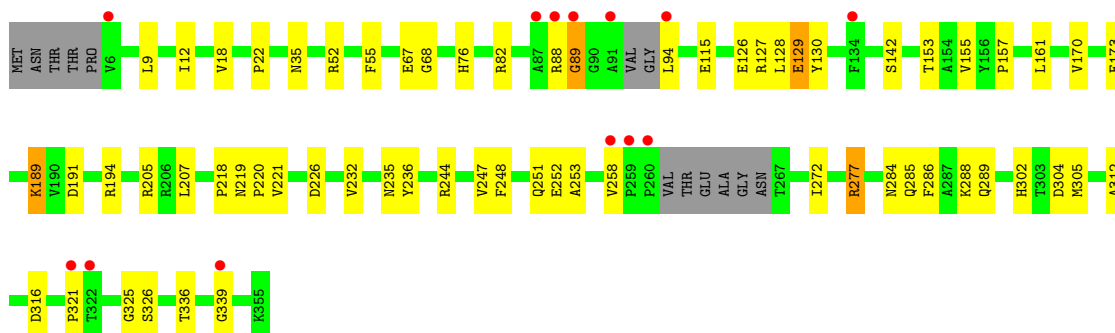
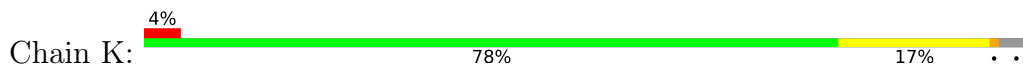

- Molecule 1: Endotype 6-aminohexanoat-oligomer hydrolase

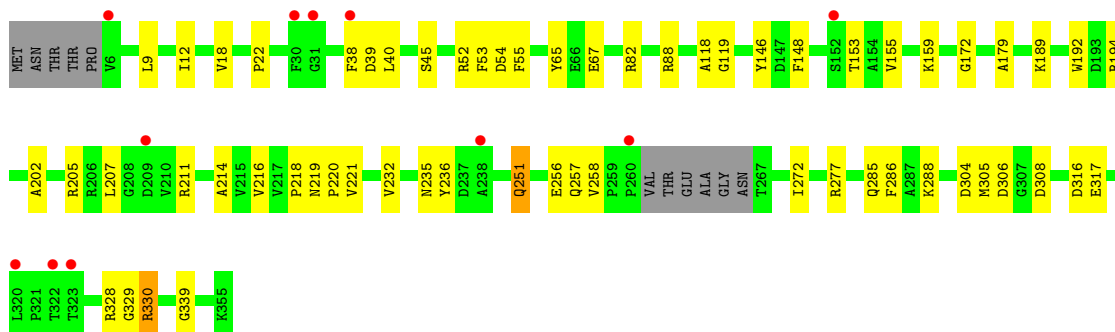
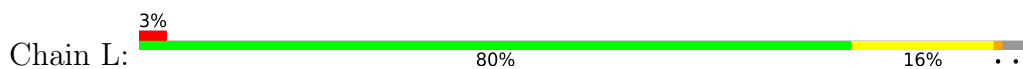

- Molecule 1: Endotype 6-aminohexanoat-oligomer hydrolase

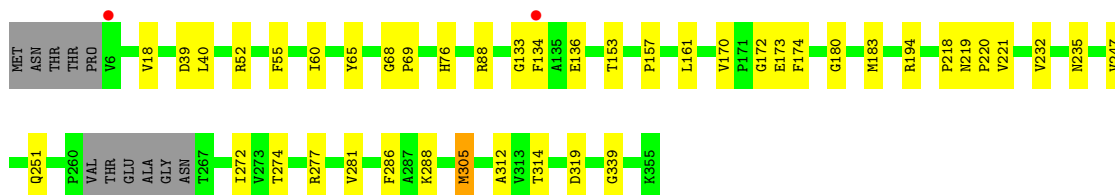
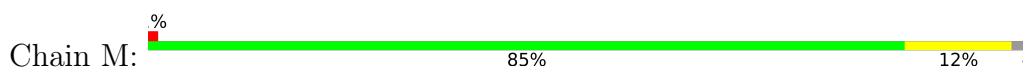

- Molecule 1: Endotype 6-aminohexanoat-oligomer hydrolase

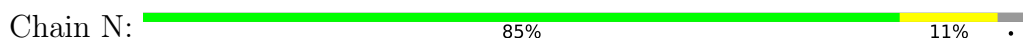

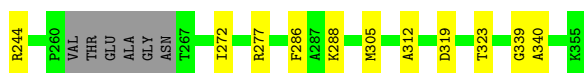

- Molecule 1: Endotype 6-aminohexanoat-oligomer hydrolase

Chain O: 87% 10%



## 4 Data and refinement statistics

Property	Value	Source
Space group	I 2 2 2	Depositor
Cell constants a, b, c, $\alpha$ , $\beta$ , $\gamma$	155.86Å 214.45Å 478.80Å 90.00° 90.00° 90.00°	Depositor
Resolution (Å)	49.99 – 2.00 49.99 – 2.00	Depositor EDS
% Data completeness (in resolution range)	94.1 (49.99-2.00) 94.2 (49.99-2.00)	Depositor EDS
$R_{merge}$	0.11	Depositor
$R_{sym}$	(Not available)	Depositor
$\langle I/\sigma(I) \rangle$ <sup>1</sup>	2.15 (at 2.00Å)	Xtrriage
Refinement program	CNS 1.1	Depositor
R, $R_{free}$	0.211 , 0.240 0.211 , 0.240	Depositor DCC
$R_{free}$ test set	50323 reflections (10.02%)	wwPDB-VP
Wilson B-factor (Å <sup>2</sup> )	24.6	Xtrriage
Anisotropy	0.304	Xtrriage
Bulk solvent $k_{sol}$ (e/Å <sup>3</sup> ), $B_{sol}$ (Å <sup>2</sup> )	0.37 , 64.0	EDS
L-test for twinning <sup>2</sup>	$\langle  L  \rangle = 0.48$ , $\langle L^2 \rangle = 0.31$	Xtrriage
Estimated twinning fraction	No twinning to report.	Xtrriage
$F_o, F_c$ correlation	0.94	EDS
Total number of atoms	40681	wwPDB-VP
Average B, all atoms (Å <sup>2</sup> )	33.0	wwPDB-VP

Xtrriage's analysis on translational NCS is as follows: *The largest off-origin peak in the Patterson function is 18.35% of the height of the origin peak. No significant pseudotranslation is detected.*

<sup>1</sup>Intensities estimated from amplitudes.

<sup>2</sup>Theoretical values of  $\langle |L| \rangle$ ,  $\langle L^2 \rangle$  for acentric reflections are 0.5, 0.333 respectively for untwinned datasets, and 0.375, 0.2 for perfectly twinned datasets.

## 5 Model quality

### 5.1 Standard geometry

Bond lengths and bond angles in the following residue types are not validated in this section:  
NA

The Z score for a bond length (or angle) is the number of standard deviations the observed value is removed from the expected value. A bond length (or angle) with  $|Z| > 5$  is considered an outlier worth inspection. RMSZ is the root-mean-square of all Z scores of the bond lengths (or angles).

Mol	Chain	Bond lengths		Bond angles	
		RMSZ	# Z  >5	RMSZ	# Z  >5
1	A	0.33	0/2576	0.50	0/3505
1	B	0.31	0/2576	0.47	0/3505
1	C	0.34	0/2576	0.48	0/3505
1	D	0.33	0/2576	0.48	0/3505
1	E	0.31	0/2576	0.47	0/3505
1	F	0.33	0/2576	0.48	0/3505
1	G	0.33	0/2576	0.48	0/3505
1	H	0.32	0/2576	0.47	0/3505
1	I	0.31	0/2576	0.46	0/3505
1	J	0.33	0/2576	0.48	0/3505
1	K	0.33	0/2564	0.49	0/3487
1	L	0.33	0/2576	0.47	0/3505
1	M	0.39	0/2576	0.53	0/3505
1	N	0.39	1/2576 (0.0%)	0.54	0/3505
1	O	0.36	0/2576	0.51	0/3505
All	All	0.34	1/38628 (0.0%)	0.49	0/52557

All (1) bond length outliers are listed below:

Mol	Chain	Res	Type	Atoms	Z	Observed(Å)	Ideal(Å)
1	N	340	ALA	CA-CB	5.36	1.63	1.52

There are no bond angle outliers.

There are no chirality outliers.

There are no planarity outliers.

## 5.2 Too-close contacts

In the following table, the Non-H and H(model) columns list the number of non-hydrogen atoms and hydrogen atoms in the chain respectively. The H(added) column lists the number of hydrogen atoms added and optimized by MolProbity. The Clashes column lists the number of clashes within the asymmetric unit, whereas Symm-Clashes lists symmetry-related clashes.

Mol	Chain	Non-H	H(model)	H(added)	Clashes	Symm-Clashes
1	A	2522	0	2454	55	0
1	B	2522	0	2454	76	0
1	C	2522	0	2454	55	0
1	D	2522	0	2454	62	0
1	E	2522	0	2454	62	0
1	F	2522	0	2454	62	0
1	G	2522	0	2454	61	0
1	H	2522	0	2454	62	0
1	I	2522	0	2454	77	0
1	J	2522	0	2454	60	0
1	K	2511	0	2441	65	0
1	L	2522	0	2454	51	0
1	M	2522	0	2454	33	0
1	N	2522	0	2454	31	0
1	O	2522	0	2454	28	0
2	A	1	0	0	0	0
2	K	1	0	0	0	0
2	L	1	0	0	0	0
2	M	1	0	0	0	0
2	N	1	0	0	0	0
2	O	1	0	0	0	0
3	A	188	0	0	2	0
3	B	104	0	0	3	0
3	C	194	0	0	2	0
3	D	165	0	0	7	0
3	E	99	0	0	1	0
3	F	182	0	0	3	0
3	G	161	0	0	2	0
3	H	116	0	0	2	0
3	I	117	0	0	4	0
3	J	170	0	0	2	0
3	K	217	0	0	6	0
3	L	174	0	0	1	0
3	M	333	0	0	7	0
3	N	318	0	0	3	0
3	O	318	0	0	3	0
All	All	40681	0	36797	730	0

The all-atom clashscore is defined as the number of clashes found per 1000 atoms (including hydrogen atoms). The all-atom clashscore for this structure is 10.

The worst 5 of 730 close contacts within the same asymmetric unit are listed below, sorted by their clash magnitude.

Atom-1	Atom-2	Interatomic distance (Å)	Clash overlap (Å)
1:E:153:THR:HG22	1:E:155:VAL:H	1.29	0.95
1:J:153:THR:HG22	1:J:155:VAL:H	1.32	0.95
1:I:257:GLN:HE21	1:K:326:SER:HA	1.31	0.93
1:F:276:VAL:HG22	1:F:318:ILE:HD11	1.52	0.92
1:N:88:ARG:HH12	1:N:288:LYS:HB3	1.35	0.91

There are no symmetry-related clashes.

## 5.3 Torsion angles [i](#)

### 5.3.1 Protein backbone [i](#)

In the following table, the Percentiles column shows the percent Ramachandran outliers of the chain as a percentile score with respect to all X-ray entries followed by that with respect to entries of similar resolution.

The Analysed column shows the number of residues for which the backbone conformation was analysed, and the total number of residues.

Mol	Chain	Analysed	Favoured	Allowed	Outliers	Percentiles	
1	A	340/355 (96%)	326 (96%)	14 (4%)	0	100	100
1	B	340/355 (96%)	324 (95%)	16 (5%)	0	100	100
1	C	340/355 (96%)	327 (96%)	12 (4%)	1 (0%)	41	37
1	D	340/355 (96%)	329 (97%)	11 (3%)	0	100	100
1	E	340/355 (96%)	321 (94%)	19 (6%)	0	100	100
1	F	340/355 (96%)	327 (96%)	11 (3%)	2 (1%)	25	19
1	G	340/355 (96%)	327 (96%)	13 (4%)	0	100	100
1	H	340/355 (96%)	322 (95%)	17 (5%)	1 (0%)	41	37
1	I	340/355 (96%)	326 (96%)	14 (4%)	0	100	100
1	J	340/355 (96%)	320 (94%)	20 (6%)	0	100	100
1	K	336/355 (95%)	319 (95%)	16 (5%)	1 (0%)	41	37
1	L	340/355 (96%)	322 (95%)	18 (5%)	0	100	100

*Continued on next page...*

Continued from previous page...

Mol	Chain	Analysed	Favoured	Allowed	Outliers	Percentiles	
1	M	340/355 (96%)	327 (96%)	13 (4%)	0	100	100
1	N	340/355 (96%)	326 (96%)	13 (4%)	1 (0%)	41	37
1	O	340/355 (96%)	326 (96%)	14 (4%)	0	100	100
All	All	5096/5325 (96%)	4869 (96%)	221 (4%)	6 (0%)	51	49

5 of 6 Ramachandran outliers are listed below:

Mol	Chain	Res	Type
1	K	89	GLY
1	C	68	GLY
1	F	68	GLY
1	F	89	GLY
1	N	68	GLY

### 5.3.2 Protein sidechains [i](#)

In the following table, the Percentiles column shows the percent sidechain outliers of the chain as a percentile score with respect to all X-ray entries followed by that with respect to entries of similar resolution.

The Analysed column shows the number of residues for which the sidechain conformation was analysed, and the total number of residues.

Mol	Chain	Analysed	Rotameric	Outliers	Percentiles	
1	A	252/261 (97%)	250 (99%)	2 (1%)	81	86
1	B	252/261 (97%)	248 (98%)	4 (2%)	62	67
1	C	252/261 (97%)	245 (97%)	7 (3%)	43	44
1	D	252/261 (97%)	250 (99%)	2 (1%)	81	86
1	E	252/261 (97%)	249 (99%)	3 (1%)	71	76
1	F	252/261 (97%)	248 (98%)	4 (2%)	62	67
1	G	252/261 (97%)	249 (99%)	3 (1%)	71	76
1	H	252/261 (97%)	249 (99%)	3 (1%)	71	76
1	I	252/261 (97%)	247 (98%)	5 (2%)	55	58
1	J	252/261 (97%)	248 (98%)	4 (2%)	62	67
1	K	251/261 (96%)	247 (98%)	4 (2%)	62	67
1	L	252/261 (97%)	246 (98%)	6 (2%)	49	51
1	M	252/261 (97%)	249 (99%)	3 (1%)	71	76

Continued on next page...



*Continued from previous page...*

Mol	Chain	Analysed	Rotameric	Outliers	Percentiles	
1	N	252/261 (97%)	251 (100%)	1 (0%)	91	93
1	O	252/261 (97%)	250 (99%)	2 (1%)	81	86
All	All	3779/3915 (96%)	3726 (99%)	53 (1%)	67	72

5 of 53 residues with a non-rotameric sidechain are listed below:

Mol	Chain	Res	Type
1	I	52	ARG
1	J	129	GLU
1	M	305	MET
1	I	55	PHE
1	I	277	ARG

Sometimes sidechains can be flipped to improve hydrogen bonding and reduce clashes. 5 of 22 such sidechains are listed below:

Mol	Chain	Res	Type
1	I	176	GLN
1	J	257	GLN
1	J	76	HIS
1	L	257	GLN
1	C	334	ASN

### 5.3.3 RNA [i](#)

There are no RNA molecules in this entry.

## 5.4 Non-standard residues in protein, DNA, RNA chains [i](#)

There are no non-standard protein/DNA/RNA residues in this entry.

## 5.5 Carbohydrates [i](#)

There are no monosaccharides in this entry.

## 5.6 Ligand geometry [i](#)

Of 6 ligands modelled in this entry, 6 are monoatomic - leaving 0 for Mogul analysis.

There are no bond length outliers.

There are no bond angle outliers.

There are no chirality outliers.

There are no torsion outliers.

There are no ring outliers.

No monomer is involved in short contacts.

## 5.7 Other polymers [i](#)

There are no such residues in this entry.

## 5.8 Polymer linkage issues [i](#)

There are no chain breaks in this entry.

## 6 Fit of model and data

### 6.1 Protein, DNA and RNA chains

In the following table, the column labelled ‘#RSRZ> 2’ contains the number (and percentage) of RSRZ outliers, followed by percent RSRZ outliers for the chain as percentile scores relative to all X-ray entries and entries of similar resolution. The OWAB column contains the minimum, median, 95<sup>th</sup> percentile and maximum values of the occupancy-weighted average B-factor per residue. The column labelled ‘Q< 0.9’ lists the number of (and percentage) of residues with an average occupancy less than 0.9.

Mol	Chain	Analysed	<RSRZ>	#RSRZ>2	OWAB(Å <sup>2</sup> )	Q<0.9
1	A	344/355 (96%)	0.04	10 (2%) 51 50	18, 31, 50, 71	0
1	B	344/355 (96%)	0.34	22 (6%) 19 18	22, 40, 60, 70	0
1	C	344/355 (96%)	0.02	12 (3%) 44 43	18, 30, 51, 64	0
1	D	344/355 (96%)	0.10	13 (3%) 40 39	18, 32, 53, 74	0
1	E	344/355 (96%)	0.41	25 (7%) 15 14	21, 39, 60, 83	0
1	F	344/355 (96%)	0.16	18 (5%) 27 26	21, 32, 54, 77	0
1	G	344/355 (96%)	-0.04	11 (3%) 47 46	18, 31, 53, 69	0
1	H	344/355 (96%)	0.50	29 (8%) 11 10	20, 37, 59, 74	0
1	I	344/355 (96%)	0.57	27 (7%) 13 12	25, 38, 55, 67	0
1	J	344/355 (96%)	0.18	19 (5%) 25 24	19, 30, 56, 71	0
1	K	342/355 (96%)	0.03	13 (3%) 40 39	19, 30, 49, 64	0
1	L	344/355 (96%)	0.15	11 (3%) 47 46	20, 32, 51, 63	0
1	M	344/355 (96%)	-0.44	2 (0%) 89 88	10, 18, 35, 57	0
1	N	344/355 (96%)	-0.50	1 (0%) 94 93	10, 19, 33, 49	0
1	O	344/355 (96%)	-0.46	1 (0%) 94 93	13, 21, 34, 45	0
All	All	5158/5325 (96%)	0.07	214 (4%) 37 36	10, 31, 54, 83	0

The worst 5 of 214 RSRZ outliers are listed below:

Mol	Chain	Res	Type	RSRZ
1	E	134	PHE	8.0
1	J	134	PHE	7.7
1	A	134	PHE	7.4
1	H	31	GLY	7.0
1	D	30	PHE	6.5

## 6.2 Non-standard residues in protein, DNA, RNA chains [i](#)

There are no non-standard protein/DNA/RNA residues in this entry.

## 6.3 Carbohydrates [i](#)

There are no monosaccharides in this entry.

## 6.4 Ligands [i](#)

In the following table, the Atoms column lists the number of modelled atoms in the group and the number defined in the chemical component dictionary. The B-factors column lists the minimum, median, 95<sup>th</sup> percentile and maximum values of B factors of atoms in the group. The column labelled 'Q< 0.9' lists the number of atoms with occupancy less than 0.9.

Mol	Type	Chain	Res	Atoms	RSCC	RSR	B-factors( $\text{\AA}^2$ )	Q<0.9
2	NA	O	3004	1/1	0.94	0.08	34,34,34,34	0
2	NA	L	3006	1/1	0.96	0.15	44,44,44,44	0
2	NA	K	3001	1/1	0.96	0.10	28,28,28,28	0
2	NA	M	3003	1/1	0.97	0.06	32,32,32,32	0
2	NA	A	3005	1/1	0.97	0.09	32,32,32,32	0
2	NA	N	3002	1/1	0.99	0.10	32,32,32,32	0

## 6.5 Other polymers [i](#)

There are no such residues in this entry.