



# wwPDB EM Validation Summary Report ⓘ

Apr 28, 2024 – 01:05 pm BST

PDB ID : 4AAQ  
EMDB ID : EMD-1998  
Title : ATP-triggered molecular mechanics of the chaperonin GroEL  
Authors : Clare, D.K.; Vasishtan, D.; Stagg, S.; Quispe, J.; Farr, G.W.; Topf, M.; Horwich, A.L.; Saibil, H.R.  
Deposited on : 2011-12-05  
Resolution : 8.00 Å(reported)  
Based on initial model : 1OEL

This is a wwPDB EM Validation Summary Report for a publicly released PDB entry.

We welcome your comments at [validation@mail.wwpdb.org](mailto:validation@mail.wwpdb.org)

A user guide is available at

<https://www.wwpdb.org/validation/2017/EMValidationReportHelp>

with specific help available everywhere you see the ⓘ symbol.

The types of validation reports are described at

<http://www.wwpdb.org/validation/2017/FAQs#types>.

---

The following versions of software and data (see [references ⓘ](#)) were used in the production of this report:

EMDB validation analysis : 0.0.1.dev92  
Mogul : 1.8.4, CSD as541be (2020)  
MolProbity : 4.02b-467  
buster-report : 1.1.7 (2018)  
Percentile statistics : 20191225.v01 (using entries in the PDB archive December 25th 2019)  
MapQ : 1.9.13  
Ideal geometry (proteins) : Engh & Huber (2001)  
Ideal geometry (DNA, RNA) : Parkinson et al. (1996)  
Validation Pipeline (wwPDB-VP) : 2.36.2

# 1 Overall quality at a glance i

The following experimental techniques were used to determine the structure:

*ELECTRON MICROSCOPY*

The reported resolution of this entry is 8.00 Å.

Percentile scores (ranging between 0-100) for global validation metrics of the entry are shown in the following graphic. The table shows the number of entries on which the scores are based.

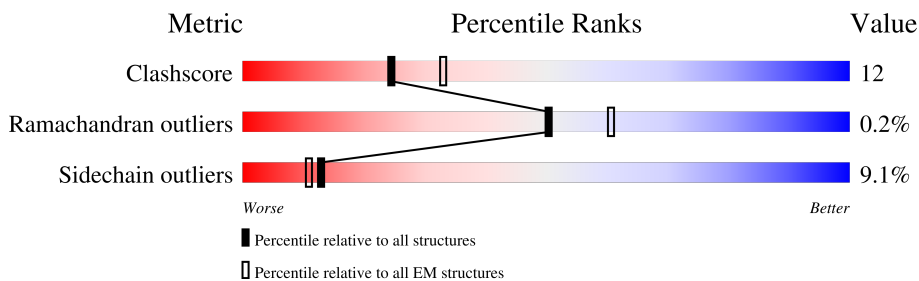

Metric	Whole archive (#Entries)	EM structures (#Entries)
Clashscore	158937	4297
Ramachandran outliers	154571	4023
Sidechain outliers	154315	3826

The table below summarises the geometric issues observed across the polymeric chains and their fit to the map. The red, orange, yellow and green segments of the bar indicate the fraction of residues that contain outliers for  $\geq 3$ , 2, 1 and 0 types of geometric quality criteria respectively. A grey segment represents the fraction of residues that are not modelled. The numeric value for each fraction is indicated below the corresponding segment, with a dot representing fractions  $\leq 5\%$ . The upper red bar (where present) indicates the fraction of residues that have poor fit to the EM map (all-atom inclusion  $< 40\%$ ). The numeric value is given above the bar.

Mol	Chain	Length	Quality of chain
1	A	548	
1	B	548	
1	C	548	
1	D	548	
1	E	548	
1	F	548	
1	G	548	
1	H	548	

Continued on next page...

Continued from previous page...

Mol	Chain	Length	Quality of chain			
1	I	548	6%	78%	14%	...
1	J	548	6%	78%	14%	...
1	K	548	6%	79%	14%	...
1	L	548	5%	78%	14%	...
1	M	548	5%	78%	14%	...
1	N	548	6%	78%	14%	...

The following table lists non-polymeric compounds, carbohydrate monomers and non-standard residues in protein, DNA, RNA chains that are outliers for geometric or electron-density-fit criteria:

Mol	Type	Chain	Res	Chirality	Geometry	Clashes	Electron density
3	PO4	A	1526	-	-	X	-
3	PO4	B	1526	-	-	X	-
3	PO4	C	1527	-	-	X	-
3	PO4	D	1526	-	-	X	-
3	PO4	E	1526	-	-	X	-
3	PO4	F	1525	-	-	X	-
3	PO4	G	1525	-	-	X	-

## 2 Entry composition [i](#)

There are 4 unique types of molecules in this entry. The entry contains 54159 atoms, of which 84 are hydrogens and 0 are deuteriums.

In the tables below, the AltConf column contains the number of residues with at least one atom in alternate conformation and the Trace column contains the number of residues modelled with at most 2 atoms.

- Molecule 1 is a protein called 60 KDA CHAPERONIN.

Mol	Chain	Residues	Atoms					AltConf	Trace
			Total	C	N	O	S		
1	A	524	3846	2391	665	770	20	0	1
1	B	524	3846	2391	665	770	20	0	1
1	C	524	3846	2391	665	770	20	0	1
1	D	524	3846	2391	665	770	20	0	1
1	E	524	3846	2391	665	770	20	0	1
1	F	524	3846	2391	665	770	20	0	1
1	G	524	3846	2391	665	770	20	0	1
1	H	524	3846	2391	665	770	20	0	1
1	I	524	3846	2391	665	770	20	0	1
1	J	524	3846	2391	665	770	20	0	1
1	K	524	3846	2391	665	770	20	0	1
1	L	524	3846	2391	665	770	20	0	1
1	M	524	3846	2391	665	770	20	0	1
1	N	524	3846	2391	665	770	20	0	1

There are 14 discrepancies between the modelled and reference sequences:

Chain	Residue	Modelled	Actual	Comment	Reference
A	398	ALA	ASP	engineered mutation	UNP P0A6F5
B	398	ALA	ASP	engineered mutation	UNP P0A6F5

*Continued on next page...*

Continued from previous page...

Chain	Residue	Modelled	Actual	Comment	Reference
C	398	ALA	ASP	engineered mutation	UNP P0A6F5
D	398	ALA	ASP	engineered mutation	UNP P0A6F5
E	398	ALA	ASP	engineered mutation	UNP P0A6F5
F	398	ALA	ASP	engineered mutation	UNP P0A6F5
G	398	ALA	ASP	engineered mutation	UNP P0A6F5
H	398	ALA	ASP	engineered mutation	UNP P0A6F5
I	398	ALA	ASP	engineered mutation	UNP P0A6F5
J	398	ALA	ASP	engineered mutation	UNP P0A6F5
K	398	ALA	ASP	engineered mutation	UNP P0A6F5
L	398	ALA	ASP	engineered mutation	UNP P0A6F5
M	398	ALA	ASP	engineered mutation	UNP P0A6F5
N	398	ALA	ASP	engineered mutation	UNP P0A6F5

- Molecule 2 is ADENOSINE-5'-TRIPHOSPHATE (three-letter code: ATP) (formula:  $C_{10}H_{16}N_5O_{13}P_3$ ).

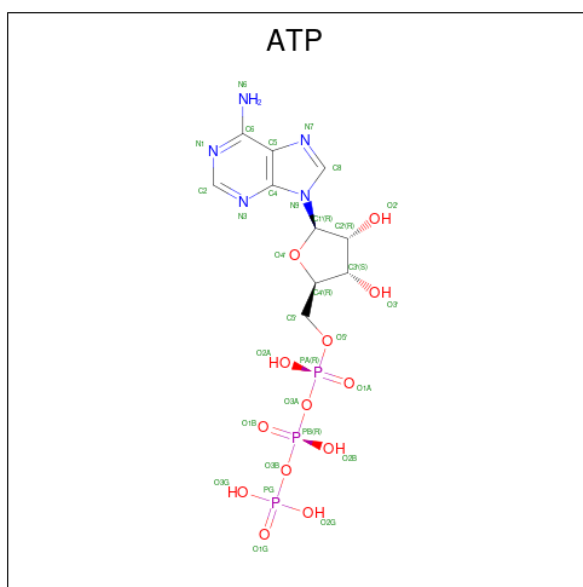

Mol	Chain	Residues	Atoms					AltConf	
			Total	C	H	N	O		P
2	A	1	Total	C	H	N	O	P	0
			43	10	12	5	13	3	
2	B	1	Total	C	H	N	O	P	0
			43	10	12	5	13	3	
2	C	1	Total	C	H	N	O	P	0
			43	10	12	5	13	3	
2	D	1	Total	C	H	N	O	P	0
			43	10	12	5	13	3	
2	E	1	Total	C	H	N	O	P	0
			43	10	12	5	13	3	

Continued on next page...

Continued from previous page...

Mol	Chain	Residues	Atoms					AltConf	
			Total	C	H	N	O		P
2	F	1	43	10	12	5	13	3	0
2	G	1	43	10	12	5	13	3	0

- Molecule 3 is PHOSPHATE ION (three-letter code: PO4) (formula: O<sub>4</sub>P).

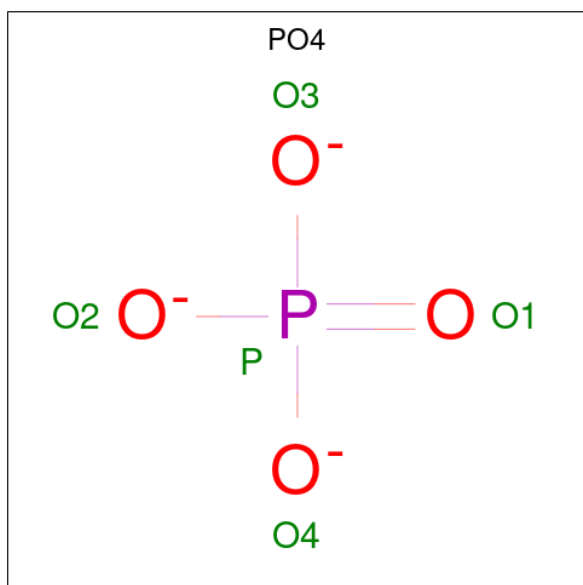

Mol	Chain	Residues	Atoms		AltConf
3	A	1	Total	P	0
			1	1	
3	B	1	Total	P	0
			1	1	
3	C	1	Total	P	0
			1	1	
3	D	1	Total	P	0
			1	1	
3	E	1	Total	P	0
			1	1	
3	F	1	Total	P	0
			1	1	
3	G	1	Total	P	0
			1	1	

- Molecule 4 is MAGNESIUM ION (three-letter code: MG) (formula: Mg).

Mol	Chain	Residues	Atoms		AltConf
4	A	1	Total 1	Mg 1	0
4	B	1	Total 1	Mg 1	0
4	C	1	Total 1	Mg 1	0
4	D	1	Total 1	Mg 1	0
4	E	1	Total 1	Mg 1	0
4	F	1	Total 1	Mg 1	0
4	G	1	Total 1	Mg 1	0

### 3 Residue-property plots [i](#)

These plots are drawn for all protein, RNA, DNA and oligosaccharide chains in the entry. The first graphic for a chain summarises the proportions of the various outlier classes displayed in the second graphic. The second graphic shows the sequence view annotated by issues in geometry and atom inclusion in map density. Residues are color-coded according to the number of geometric quality criteria for which they contain at least one outlier: green = 0, yellow = 1, orange = 2 and red = 3 or more. A red diamond above a residue indicates a poor fit to the EM map for this residue (all-atom inclusion < 40%). Stretches of 2 or more consecutive residues without any outlier are shown as a green connector. Residues present in the sample, but not in the model, are shown in grey.

- Molecule 1: 60 KDA CHAPERONIN

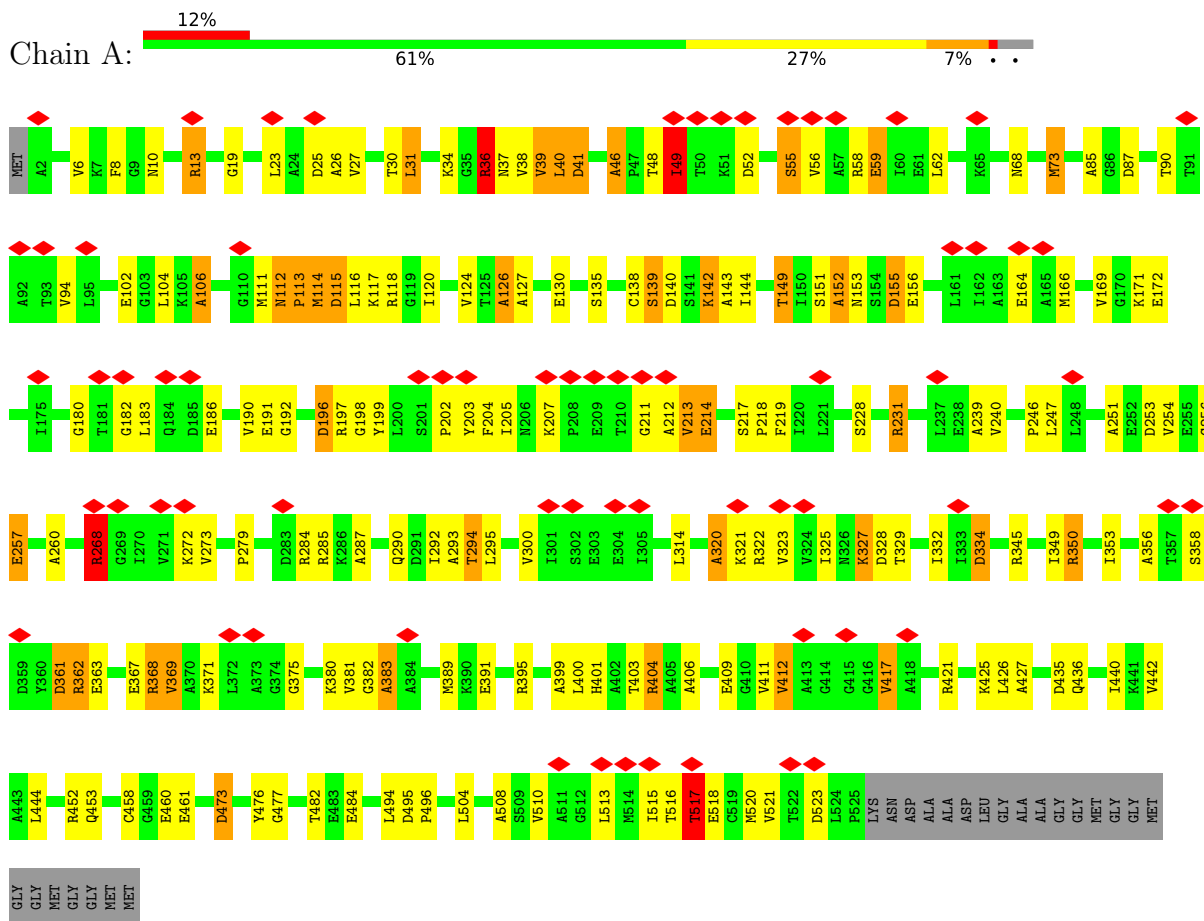

- Molecule 1: 60 KDA CHAPERONIN

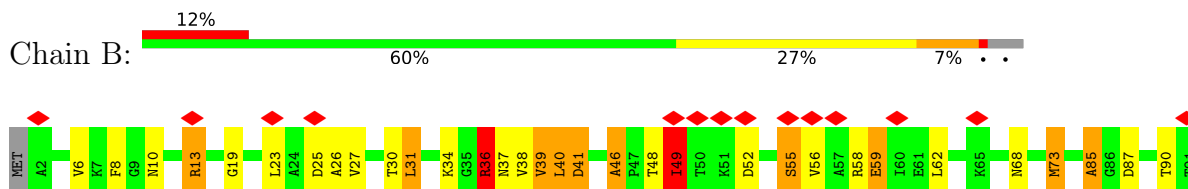



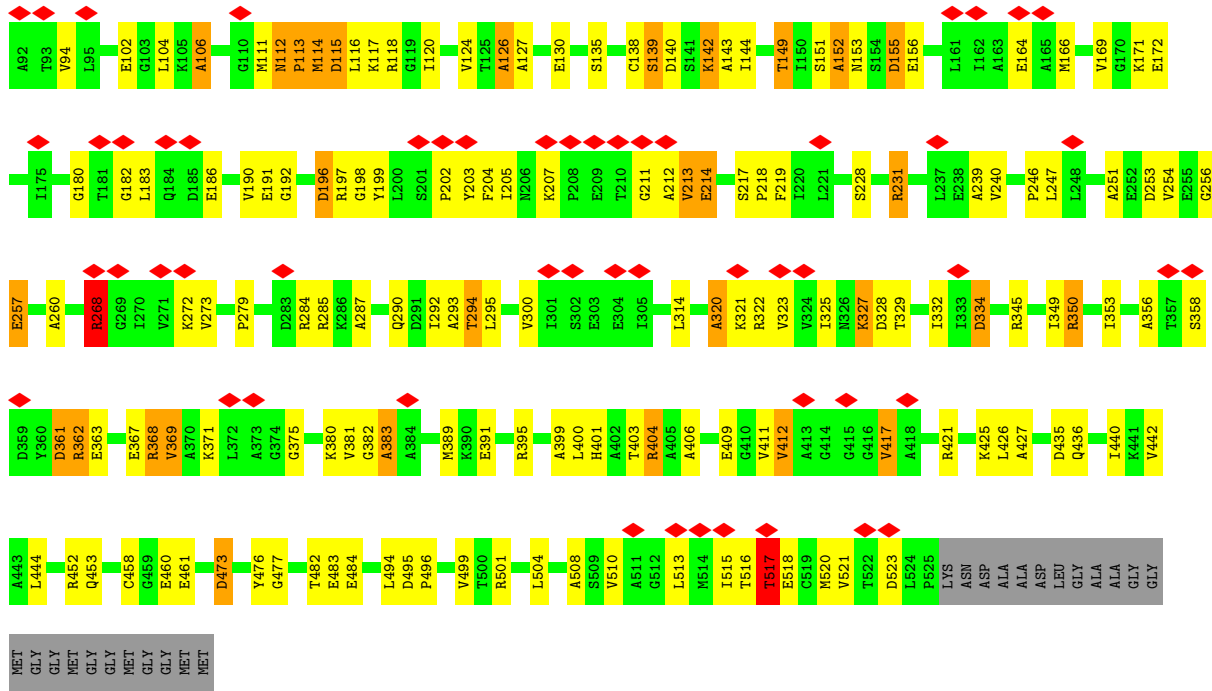

• Molecule 1: 60 KDA CHAPERONIN

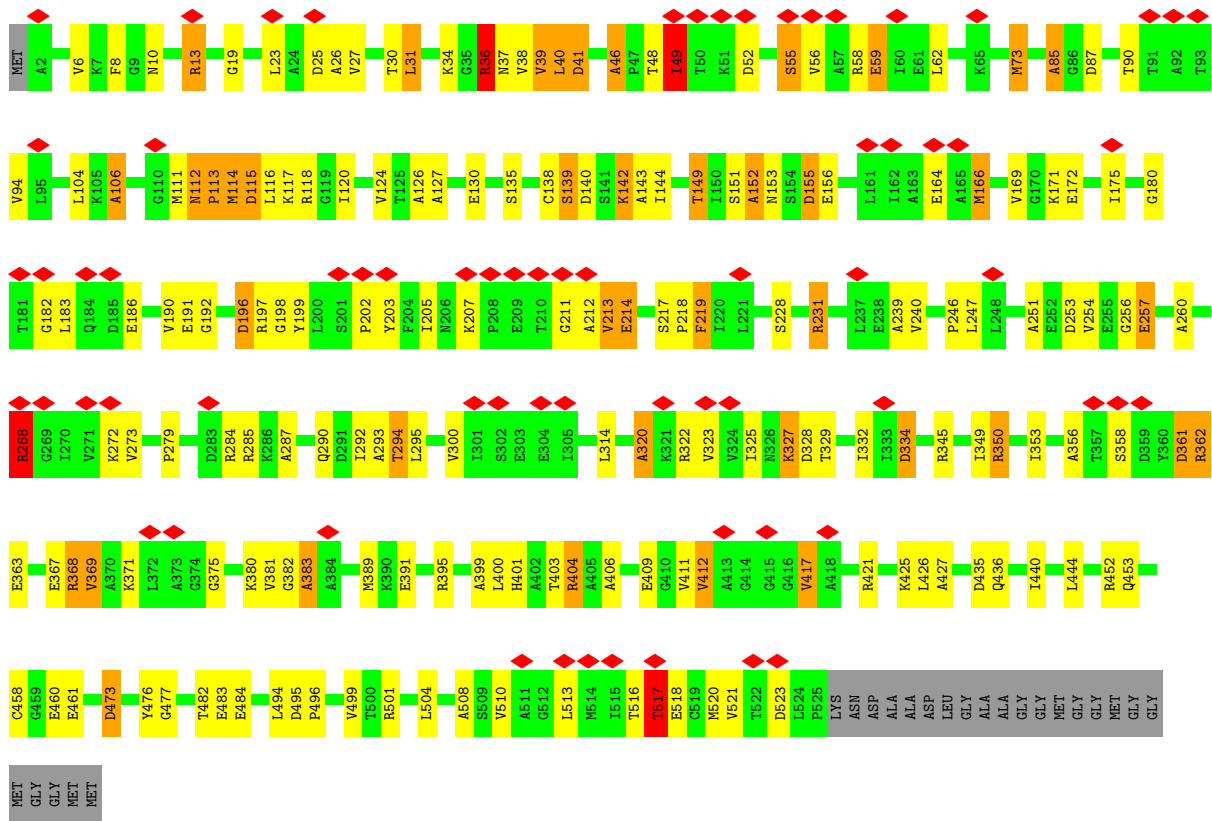

• Molecule 1: 60 KDA CHAPERONIN



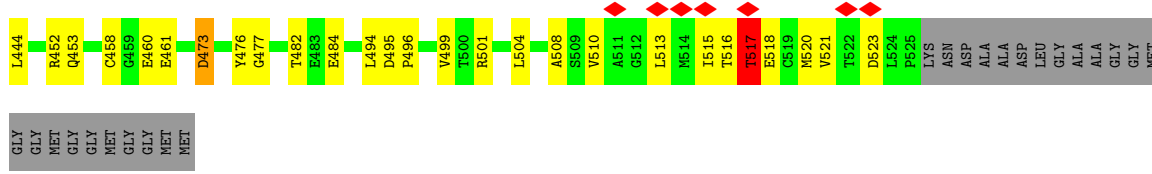

• Molecule 1: 60 KDA CHAPERONIN

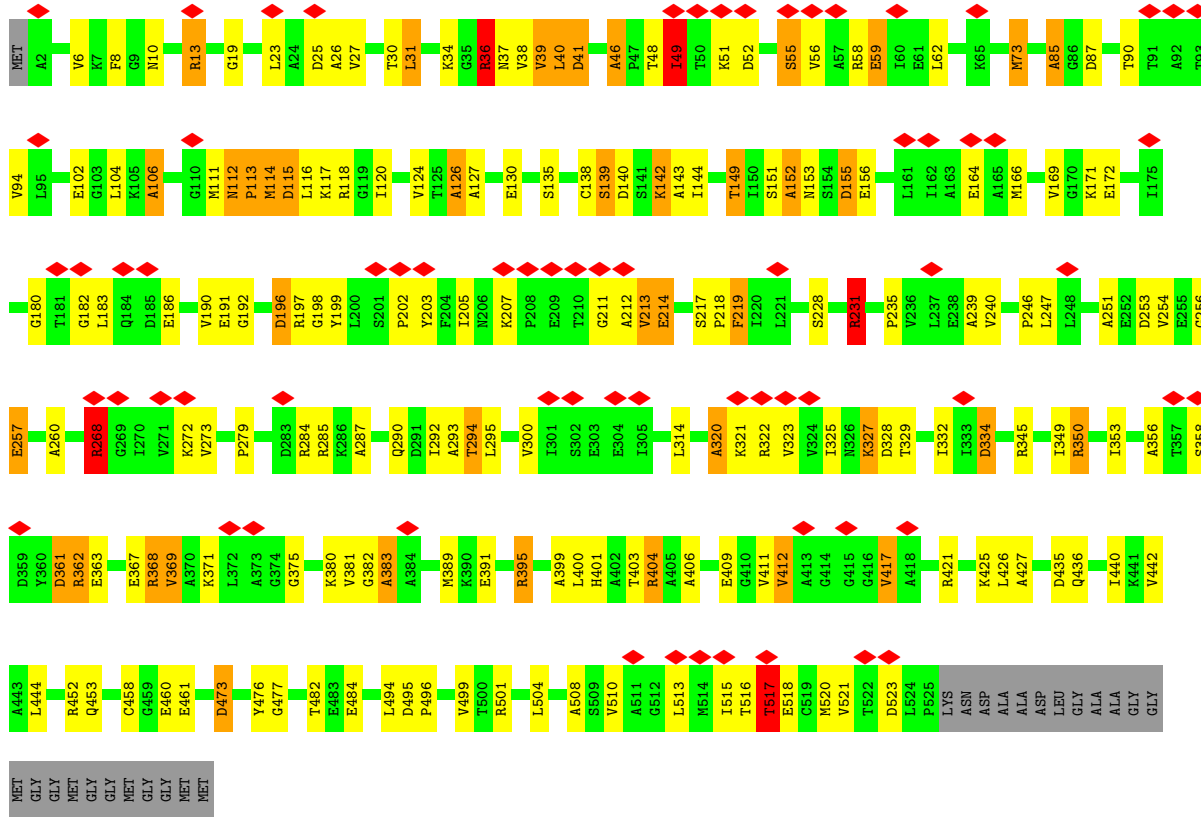

• Molecule 1: 60 KDA CHAPERONIN

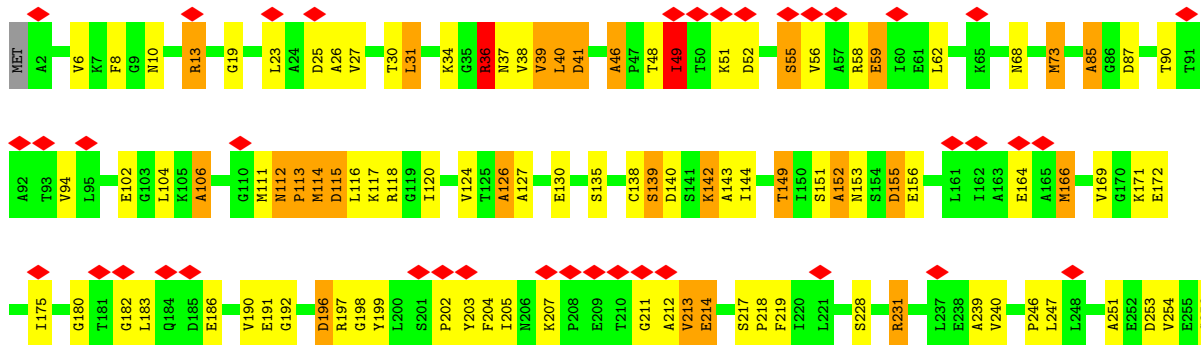

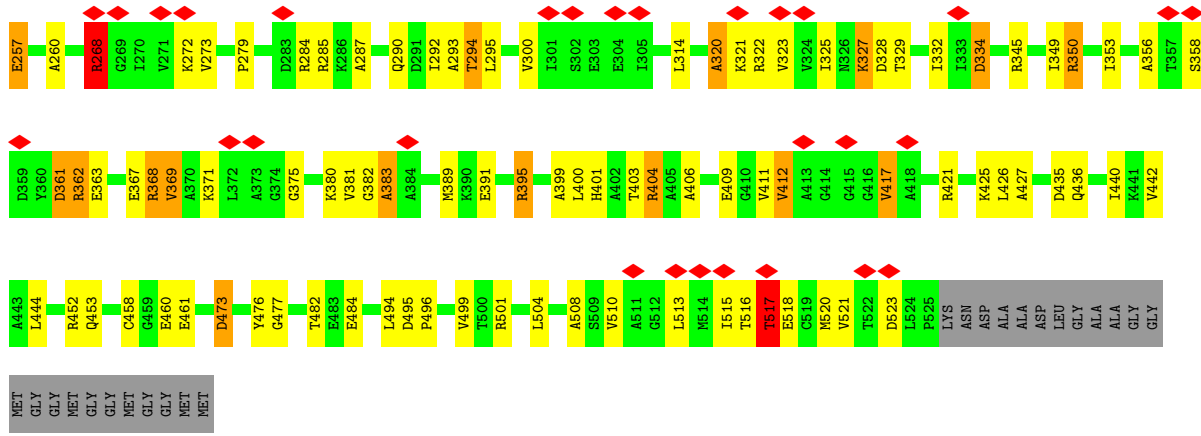

● Molecule 1: 60 KDA CHAPERONIN

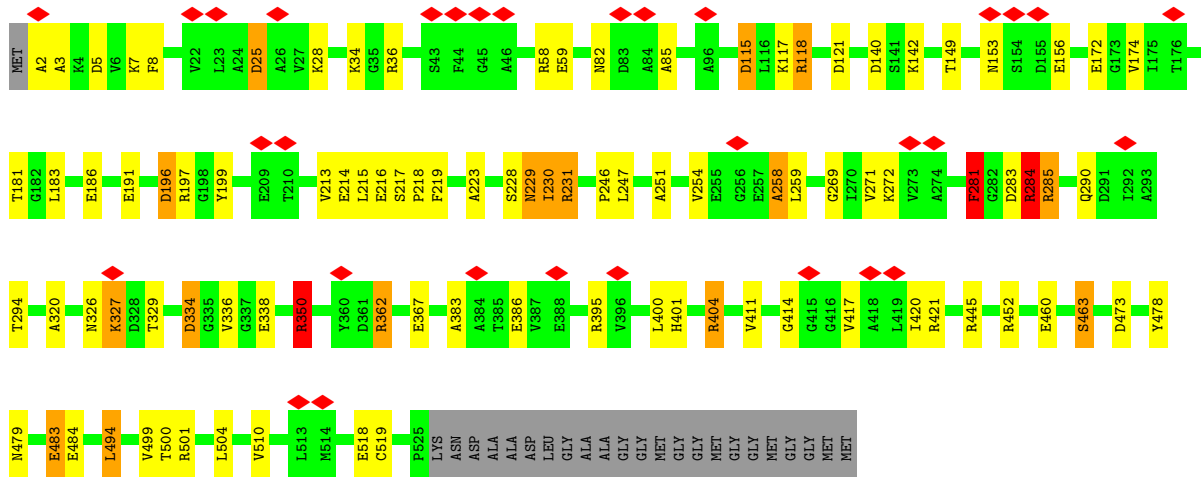
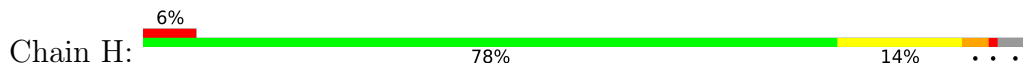

● Molecule 1: 60 KDA CHAPERONIN

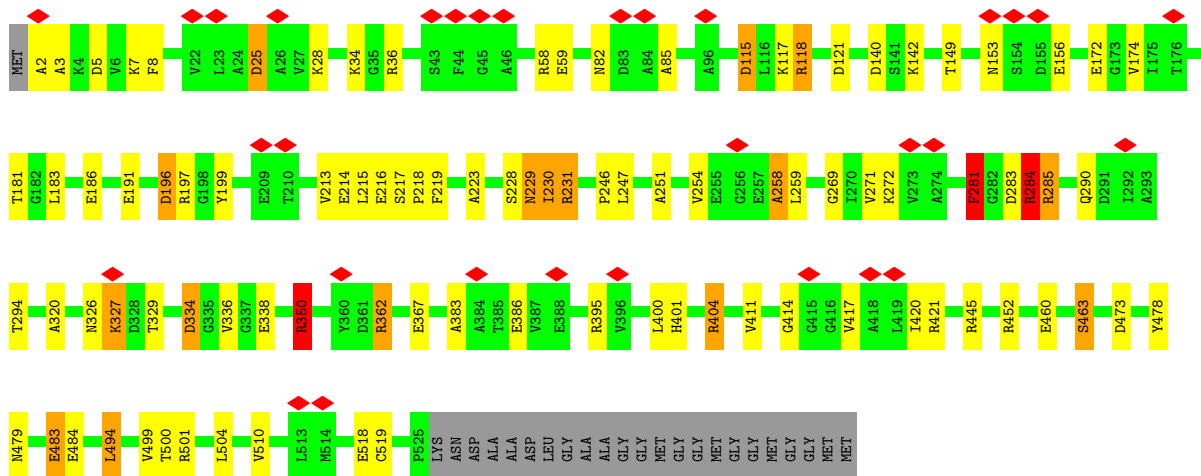
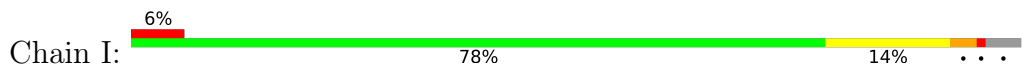

● Molecule 1: 60 KDA CHAPERONIN

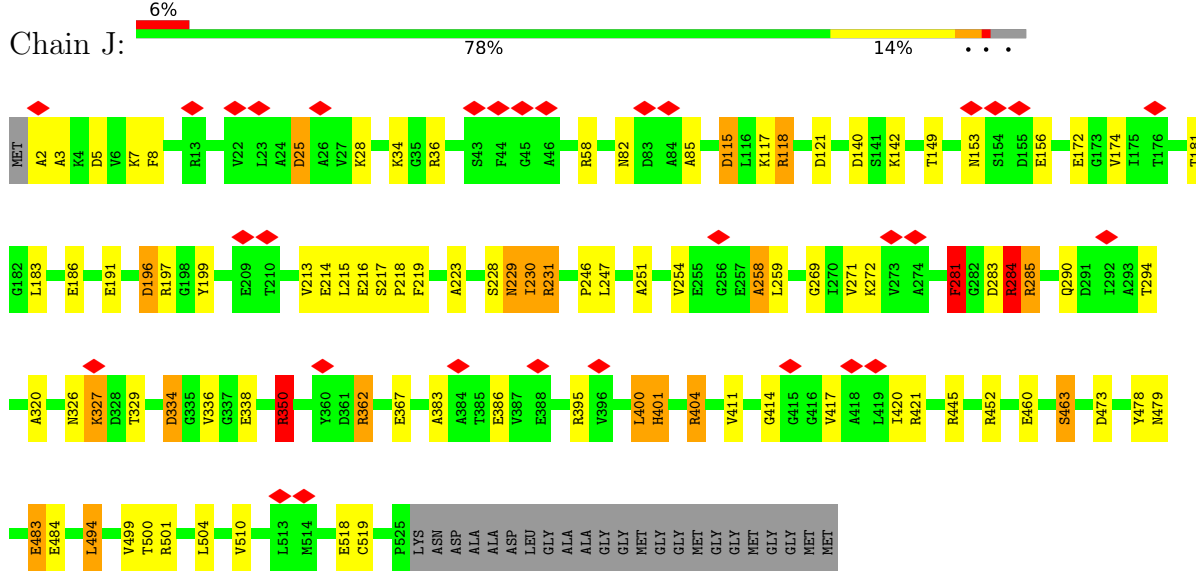

● Molecule 1: 60 KDA CHAPERONIN

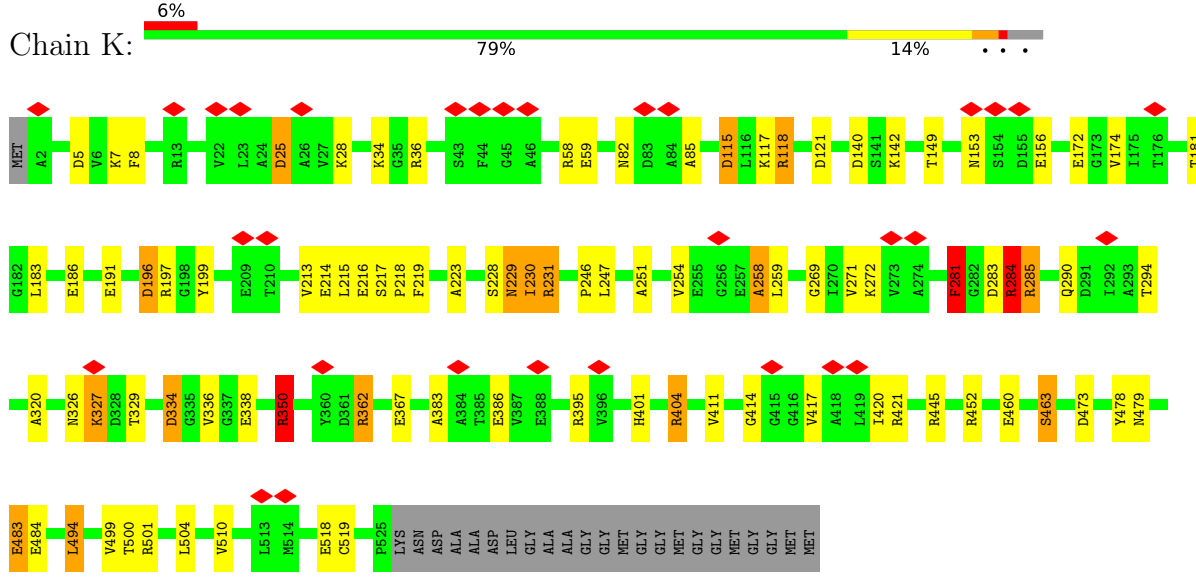

● Molecule 1: 60 KDA CHAPERONIN

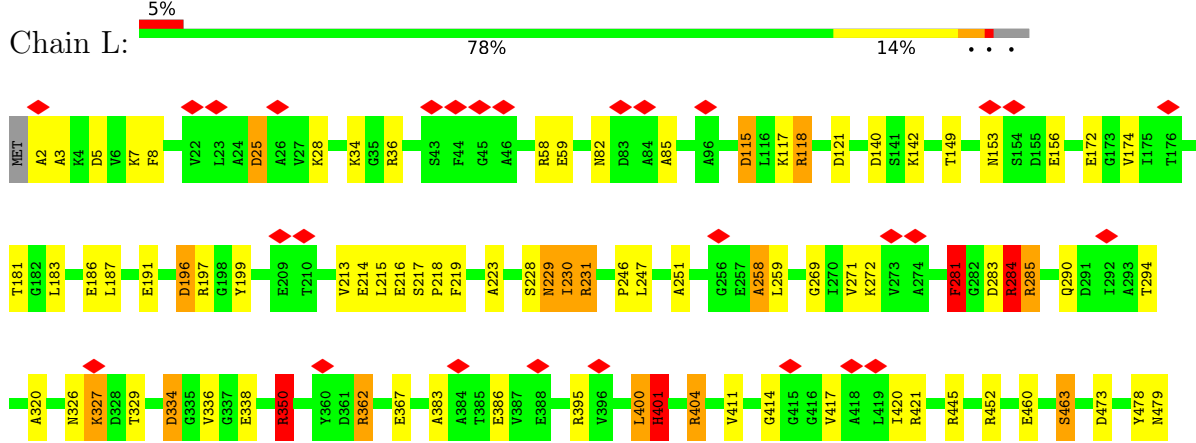

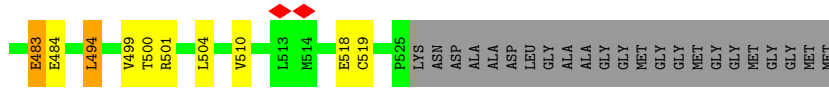

• Molecule 1: 60 KDA CHAPERONIN

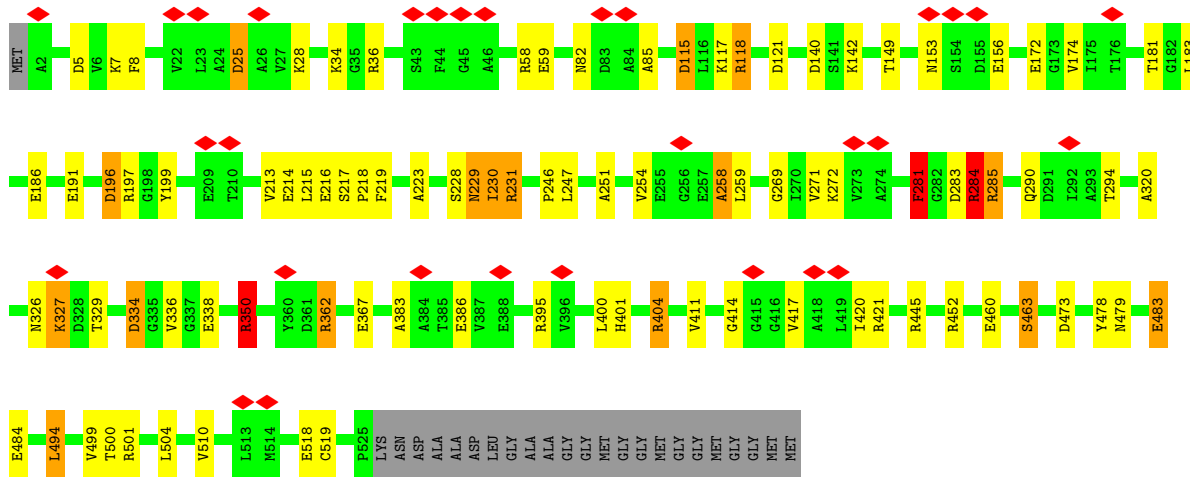
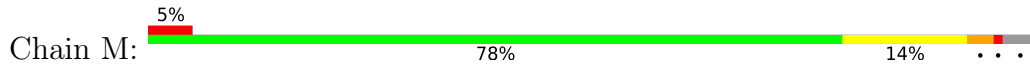

• Molecule 1: 60 KDA CHAPERONIN

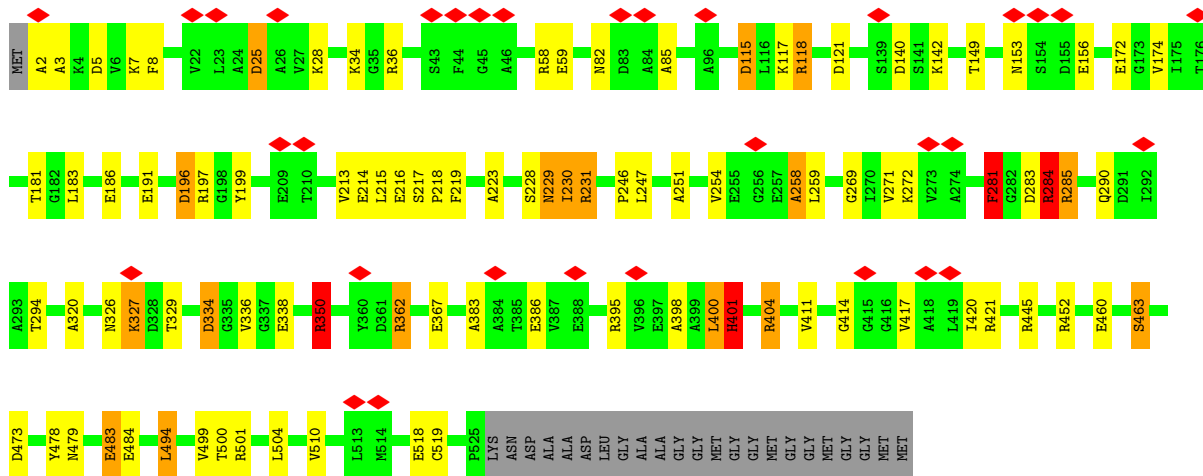
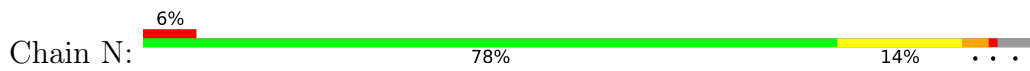

## 4 Experimental information

Property	Value	Source
EM reconstruction method	SINGLE PARTICLE	Depositor
Imposed symmetry	POINT, C7	Depositor
Number of particles used	5500	Depositor
Resolution determination method	Not provided	
CTF correction method	EACH PARTICLE WAS PHASE FLIPPED	Depositor
Microscope	FEI TECNAI F20	Depositor
Voltage (kV)	120	Depositor
Electron dose ( $e^-/\text{\AA}^2$ )	15	Depositor
Minimum defocus (nm)	700	Depositor
Maximum defocus (nm)	3500	Depositor
Magnification	148500	Depositor
Image detector	GATAN ULTRASCAN 4000 (4k x 4k)	Depositor
Maximum map value	3.488	Depositor
Minimum map value	-2.732	Depositor
Average map value	0.009	Depositor
Map value standard deviation	0.135	Depositor
Recommended contour level	0.2	Depositor
Map size ( $\text{\AA}$ )	387.84, 387.84, 387.84	wwPDB
Map dimensions	192, 192, 192	wwPDB
Map angles ( $^\circ$ )	90.0, 90.0, 90.0	wwPDB
Pixel spacing ( $\text{\AA}$ )	2.02, 2.02, 2.02	Depositor

## 5 Model quality i

### 5.1 Standard geometry i

Bond lengths and bond angles in the following residue types are not validated in this section: MG, PO4, ATP

The Z score for a bond length (or angle) is the number of standard deviations the observed value is removed from the expected value. A bond length (or angle) with  $|Z| > 5$  is considered an outlier worth inspection. RMSZ is the root-mean-square of all Z scores of the bond lengths (or angles).

Mol	Chain	Bond lengths		Bond angles	
		RMSZ	# Z  >5	RMSZ	# Z  >5
1	A	1.79	4/3873 (0.1%)	1.57	89/5229 (1.7%)
1	B	1.79	4/3873 (0.1%)	1.57	90/5229 (1.7%)
1	C	1.79	4/3873 (0.1%)	1.57	87/5229 (1.7%)
1	D	1.79	4/3873 (0.1%)	1.57	89/5229 (1.7%)
1	E	1.80	4/3873 (0.1%)	1.57	89/5229 (1.7%)
1	F	1.79	4/3873 (0.1%)	1.57	89/5229 (1.7%)
1	G	1.79	4/3873 (0.1%)	1.57	89/5229 (1.7%)
1	H	0.70	2/3873 (0.1%)	1.09	22/5229 (0.4%)
1	I	0.68	2/3873 (0.1%)	1.09	22/5229 (0.4%)
1	J	0.74	2/3873 (0.1%)	1.11	24/5229 (0.5%)
1	K	0.69	1/3873 (0.0%)	1.10	23/5229 (0.4%)
1	L	0.74	1/3873 (0.0%)	1.12	28/5229 (0.5%)
1	M	0.68	1/3873 (0.0%)	1.12	27/5229 (0.5%)
1	N	0.81	2/3873 (0.1%)	1.10	23/5229 (0.4%)
All	All	1.37	39/54222 (0.1%)	1.36	791/73206 (1.1%)

Chiral center outliers are detected by calculating the chiral volume of a chiral center and verifying if the center is modelled as a planar moiety or with the opposite hand. A planarity outlier is detected by checking planarity of atoms in a peptide group, atoms in a mainchain group or atoms of a sidechain that are expected to be planar.

Mol	Chain	#Chirality outliers	#Planarity outliers
1	A	0	9
1	B	0	9
1	C	0	10
1	D	0	10
1	E	0	9
1	F	0	10
1	G	0	9
1	H	0	10
1	I	0	10

*Continued on next page...*



Continued from previous page...

Mol	Chain	#Chirality outliers	#Planarity outliers
1	J	0	10
1	K	0	10
1	L	0	11
1	M	0	10
1	N	0	11
All	All	0	138

The worst 5 of 39 bond length outliers are listed below:

Mol	Chain	Res	Type	Atoms	Z	Observed(Å)	Ideal(Å)
1	E	36	ARG	CZ-NH1	91.40	2.51	1.33
1	G	36	ARG	CZ-NH1	91.28	2.51	1.33
1	B	36	ARG	CZ-NH1	91.26	2.51	1.33
1	F	36	ARG	CZ-NH1	91.25	2.51	1.33
1	D	36	ARG	CZ-NH1	91.20	2.51	1.33

The worst 5 of 791 bond angle outliers are listed below:

Mol	Chain	Res	Type	Atoms	Z	Observed(°)	Ideal(°)
1	F	36	ARG	NE-CZ-NH1	22.64	131.62	120.30
1	D	36	ARG	NE-CZ-NH1	22.58	131.59	120.30
1	G	36	ARG	NE-CZ-NH1	22.57	131.58	120.30
1	C	36	ARG	NE-CZ-NH1	22.51	131.56	120.30
1	A	36	ARG	NE-CZ-NH1	22.48	131.54	120.30

There are no chirality outliers.

5 of 138 planarity outliers are listed below:

Mol	Chain	Res	Type	Group
1	A	13	ARG	Sidechain
1	A	197	ARG	Sidechain
1	A	231	ARG	Sidechain
1	A	268	ARG	Sidechain
1	A	36	ARG	Sidechain

## 5.2 Too-close contacts

In the following table, the Non-H and H(model) columns list the number of non-hydrogen atoms and hydrogen atoms in the chain respectively. The H(added) column lists the number of hydrogen atoms added and optimized by MolProbity. The Clashes column lists the number of clashes within the asymmetric unit, whereas Symm-Clashes lists symmetry-related clashes.

Mol	Chain	Non-H	H(model)	H(added)	Clashes	Symm-Clashes
1	A	3846	0	3970	203	0
1	B	3846	0	3970	205	0
1	C	3846	0	3970	205	0
1	D	3846	0	3970	210	0
1	E	3846	0	3970	209	0
1	F	3846	0	3970	208	0
1	G	3846	0	3970	207	0
1	H	3846	0	3970	28	0
1	I	3846	0	3970	28	0
1	J	3846	0	3968	29	0
1	K	3846	0	3969	27	0
1	L	3846	0	3969	30	0
1	M	3846	0	3970	27	0
1	N	3846	0	3968	32	0
2	A	31	12	12	4	0
2	B	31	12	12	3	0
2	C	31	12	12	3	0
2	D	31	12	12	3	0
2	E	31	12	12	3	0
2	F	31	12	12	4	0
2	G	31	12	12	4	0
3	A	1	0	0	5	0
3	B	1	0	0	4	0
3	C	1	0	0	4	0
3	D	1	0	0	4	0
3	E	1	0	0	4	0
3	F	1	0	0	5	0
3	G	1	0	0	5	0
4	A	1	0	0	0	0
4	B	1	0	0	0	0
4	C	1	0	0	0	0
4	D	1	0	0	0	0
4	E	1	0	0	0	0
4	F	1	0	0	0	0
4	G	1	0	0	0	0
All	All	54075	84	55658	1291	0

The all-atom clashscore is defined as the number of clashes found per 1000 atoms (including hydrogen atoms). The all-atom clashscore for this structure is 12.

The worst 5 of 1291 close contacts within the same asymmetric unit are listed below, sorted by their clash magnitude.

Atom-1	Atom-2	Interatomic distance (Å)	Clash overlap (Å)
1:J:400:LEU:C	1:J:401:HIS:N	1.72	1.43
1:A:115:ASP:H	1:B:36:ARG:CZ	1.37	1.37
1:C:115:ASP:H	1:D:36:ARG:CZ	1.37	1.37
1:D:115:ASP:H	1:E:36:ARG:CZ	1.37	1.36
1:A:116:LEU:H	1:B:36:ARG:NH1	1.24	1.36

There are no symmetry-related clashes.

## 5.3 Torsion angles [i](#)

### 5.3.1 Protein backbone [i](#)

In the following table, the Percentiles column shows the percent Ramachandran outliers of the chain as a percentile score with respect to all PDB entries followed by that with respect to all EM entries.

The Analysed column shows the number of residues for which the backbone conformation was analysed, and the total number of residues.

Mol	Chain	Analysed	Favoured	Allowed	Outliers	Percentiles	
1	A	522/548 (95%)	517 (99%)	5 (1%)	0	100	100
1	B	522/548 (95%)	517 (99%)	5 (1%)	0	100	100
1	C	522/548 (95%)	517 (99%)	5 (1%)	0	100	100
1	D	522/548 (95%)	517 (99%)	5 (1%)	0	100	100
1	E	522/548 (95%)	517 (99%)	5 (1%)	0	100	100
1	F	522/548 (95%)	517 (99%)	5 (1%)	0	100	100
1	G	522/548 (95%)	517 (99%)	5 (1%)	0	100	100
1	H	522/548 (95%)	498 (95%)	22 (4%)	2 (0%)	34	72
1	I	522/548 (95%)	498 (95%)	22 (4%)	2 (0%)	34	72
1	J	522/548 (95%)	498 (95%)	22 (4%)	2 (0%)	34	72
1	K	522/548 (95%)	498 (95%)	22 (4%)	2 (0%)	34	72
1	L	522/548 (95%)	498 (95%)	22 (4%)	2 (0%)	34	72
1	M	522/548 (95%)	498 (95%)	22 (4%)	2 (0%)	34	72
1	N	522/548 (95%)	498 (95%)	22 (4%)	2 (0%)	34	72
All	All	7308/7672 (95%)	7105 (97%)	189 (3%)	14 (0%)	50	81

5 of 14 Ramachandran outliers are listed below:

Mol	Chain	Res	Type
1	H	269	GLY
1	I	269	GLY
1	J	269	GLY
1	K	269	GLY
1	L	269	GLY

### 5.3.2 Protein sidechains [i](#)

In the following table, the Percentiles column shows the percent sidechain outliers of the chain as a percentile score with respect to all PDB entries followed by that with respect to all EM entries.

The Analysed column shows the number of residues for which the sidechain conformation was analysed, and the total number of residues.

Mol	Chain	Analysed	Rotameric	Outliers	Percentiles
1	A	402/414 (97%)	364 (90%)	38 (10%)	8 27
1	B	402/414 (97%)	364 (90%)	38 (10%)	8 27
1	C	402/414 (97%)	364 (90%)	38 (10%)	8 27
1	D	402/414 (97%)	364 (90%)	38 (10%)	8 27
1	E	402/414 (97%)	364 (90%)	38 (10%)	8 27
1	F	402/414 (97%)	364 (90%)	38 (10%)	8 27
1	G	402/414 (97%)	364 (90%)	38 (10%)	8 27
1	H	402/414 (97%)	367 (91%)	35 (9%)	10 31
1	I	402/414 (97%)	367 (91%)	35 (9%)	10 31
1	J	402/414 (97%)	367 (91%)	35 (9%)	10 31
1	K	402/414 (97%)	367 (91%)	35 (9%)	10 31
1	L	402/414 (97%)	366 (91%)	36 (9%)	9 30
1	M	402/414 (97%)	367 (91%)	35 (9%)	10 31
1	N	402/414 (97%)	367 (91%)	35 (9%)	10 31
All	All	5628/5796 (97%)	5116 (91%)	512 (9%)	13 29

5 of 512 residues with a non-rotameric sidechain are listed below:

Mol	Chain	Res	Type
1	M	329	THR
1	M	510	VAL
1	M	327	LYS

*Continued on next page...*

*Continued from previous page...*

Mol	Chain	Res	Type
1	F	49	ILE
1	E	523	ASP

Sometimes sidechains can be flipped to improve hydrogen bonding and reduce clashes. 5 of 21 such sidechains are listed below:

Mol	Chain	Res	Type
1	K	326	ASN
1	M	68	ASN
1	N	326	ASN
1	M	326	ASN
1	L	326	ASN

### 5.3.3 RNA [i](#)

There are no RNA molecules in this entry.

## 5.4 Non-standard residues in protein, DNA, RNA chains [i](#)

There are no non-standard protein/DNA/RNA residues in this entry.

## 5.5 Carbohydrates [i](#)

There are no monosaccharides in this entry.

## 5.6 Ligand geometry [i](#)

Of 21 ligands modelled in this entry, 7 are modelled with single atom and 7 are monoatomic - leaving 7 for Mogul analysis.

In the following table, the Counts columns list the number of bonds (or angles) for which Mogul statistics could be retrieved, the number of bonds (or angles) that are observed in the model and the number of bonds (or angles) that are defined in the Chemical Component Dictionary. The Link column lists molecule types, if any, to which the group is linked. The Z score for a bond length (or angle) is the number of standard deviations the observed value is removed from the expected value. A bond length (or angle) with  $|Z| > 2$  is considered an outlier worth inspection. RMSZ is the root-mean-square of all Z scores of the bond lengths (or angles).

Mol	Type	Chain	Res	Link	Bond lengths			Bond angles		
					Counts	RMSZ	$\# Z  > 2$	Counts	RMSZ	$\# Z  > 2$
2	ATP	C	1526	4	26,33,33	1.02	1 (3%)	31,52,52	1.79	5 (16%)

Mol	Type	Chain	Res	Link	Bond lengths			Bond angles		
					Counts	RMSZ	# Z  > 2	Counts	RMSZ	# Z  > 2
2	ATP	E	1527	4	26,33,33	1.03	1 (3%)	31,52,52	1.79	5 (16%)
2	ATP	B	1525	4	26,33,33	1.01	1 (3%)	31,52,52	1.79	5 (16%)
2	ATP	A	1525	4	26,33,33	1.00	1 (3%)	31,52,52	1.80	5 (16%)
2	ATP	G	1527	4	26,33,33	1.01	1 (3%)	31,52,52	1.79	5 (16%)
2	ATP	F	1527	4	26,33,33	1.02	1 (3%)	31,52,52	1.80	5 (16%)
2	ATP	D	1525	4	26,33,33	1.02	1 (3%)	31,52,52	1.80	5 (16%)

In the following table, the Chirals column lists the number of chiral outliers, the number of chiral centers analysed, the number of these observed in the model and the number defined in the Chemical Component Dictionary. Similar counts are reported in the Torsion and Rings columns. '-' means no outliers of that kind were identified.

Mol	Type	Chain	Res	Link	Chirals	Torsions	Rings
2	ATP	C	1526	4	-	0/18/38/38	0/3/3/3
2	ATP	E	1527	4	-	0/18/38/38	0/3/3/3
2	ATP	B	1525	4	-	0/18/38/38	0/3/3/3
2	ATP	A	1525	4	-	0/18/38/38	0/3/3/3
2	ATP	G	1527	4	-	0/18/38/38	0/3/3/3
2	ATP	F	1527	4	-	0/18/38/38	0/3/3/3
2	ATP	D	1525	4	-	0/18/38/38	0/3/3/3

The worst 5 of 7 bond length outliers are listed below:

Mol	Chain	Res	Type	Atoms	Z	Observed(Å)	Ideal(Å)
2	E	1527	ATP	C2'-C1'	-3.58	1.48	1.53
2	C	1526	ATP	C2'-C1'	-3.57	1.48	1.53
2	D	1525	ATP	C2'-C1'	-3.56	1.48	1.53
2	G	1527	ATP	C2'-C1'	-3.53	1.48	1.53
2	B	1525	ATP	C2'-C1'	-3.53	1.48	1.53

The worst 5 of 35 bond angle outliers are listed below:

Mol	Chain	Res	Type	Atoms	Z	Observed(°)	Ideal(°)
2	B	1525	ATP	PA-O3A-PB	-5.96	112.37	132.83
2	A	1525	ATP	PA-O3A-PB	-5.96	112.39	132.83
2	F	1527	ATP	PA-O3A-PB	-5.95	112.40	132.83
2	D	1525	ATP	PA-O3A-PB	-5.95	112.42	132.83
2	E	1527	ATP	PA-O3A-PB	-5.95	112.42	132.83

There are no chirality outliers.

There are no torsion outliers.

There are no ring outliers.

7 monomers are involved in 24 short contacts:

Mol	Chain	Res	Type	Clashes	Symm-Clashes
2	C	1526	ATP	3	0
2	E	1527	ATP	3	0
2	B	1525	ATP	3	0
2	A	1525	ATP	4	0
2	G	1527	ATP	4	0
2	F	1527	ATP	4	0
2	D	1525	ATP	3	0

The following is a two-dimensional graphical depiction of Mogul quality analysis of bond lengths, bond angles, torsion angles, and ring geometry for all instances of the Ligand of Interest. In addition, ligands with molecular weight > 250 and outliers as shown on the validation Tables will also be included. For torsion angles, if less than 5% of the Mogul distribution of torsion angles is within 10 degrees of the torsion angle in question, then that torsion angle is considered an outlier. Any bond that is central to one or more torsion angles identified as an outlier by Mogul will be highlighted in the graph. For rings, the root-mean-square deviation (RMSD) between the ring in question and similar rings identified by Mogul is calculated over all ring torsion angles. If the average RMSD is greater than 60 degrees and the minimal RMSD between the ring in question and any Mogul-identified rings is also greater than 60 degrees, then that ring is considered an outlier. The outliers are highlighted in purple. The color gray indicates Mogul did not find sufficient equivalents in the CSD to analyse the geometry.

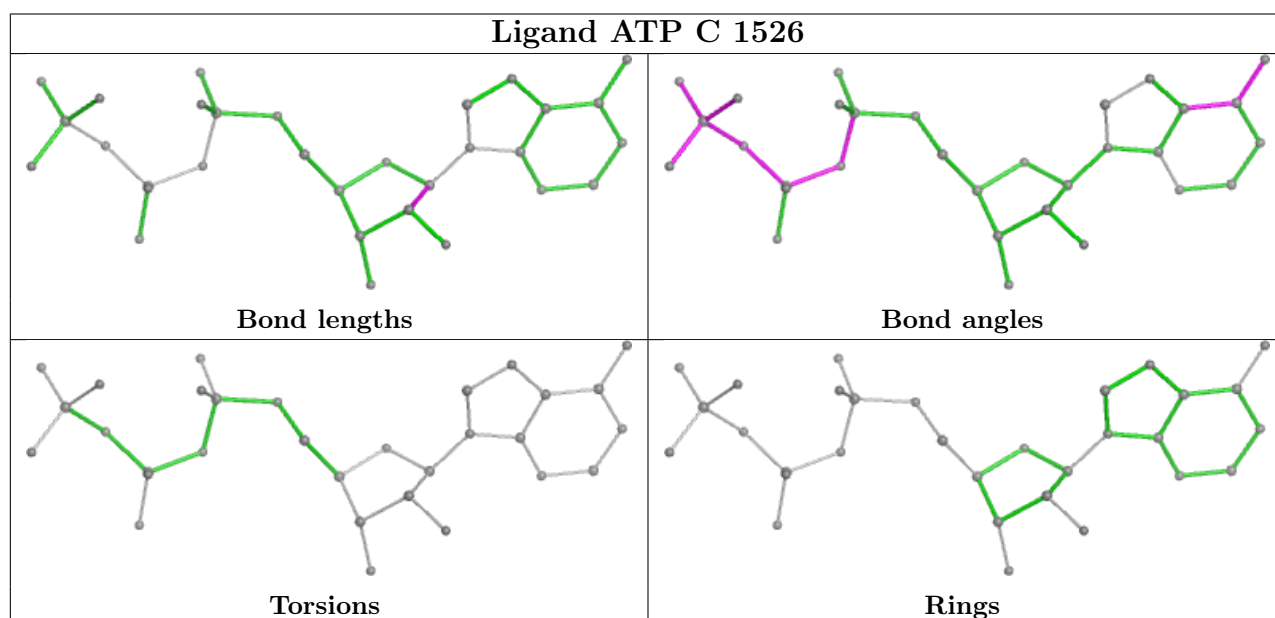

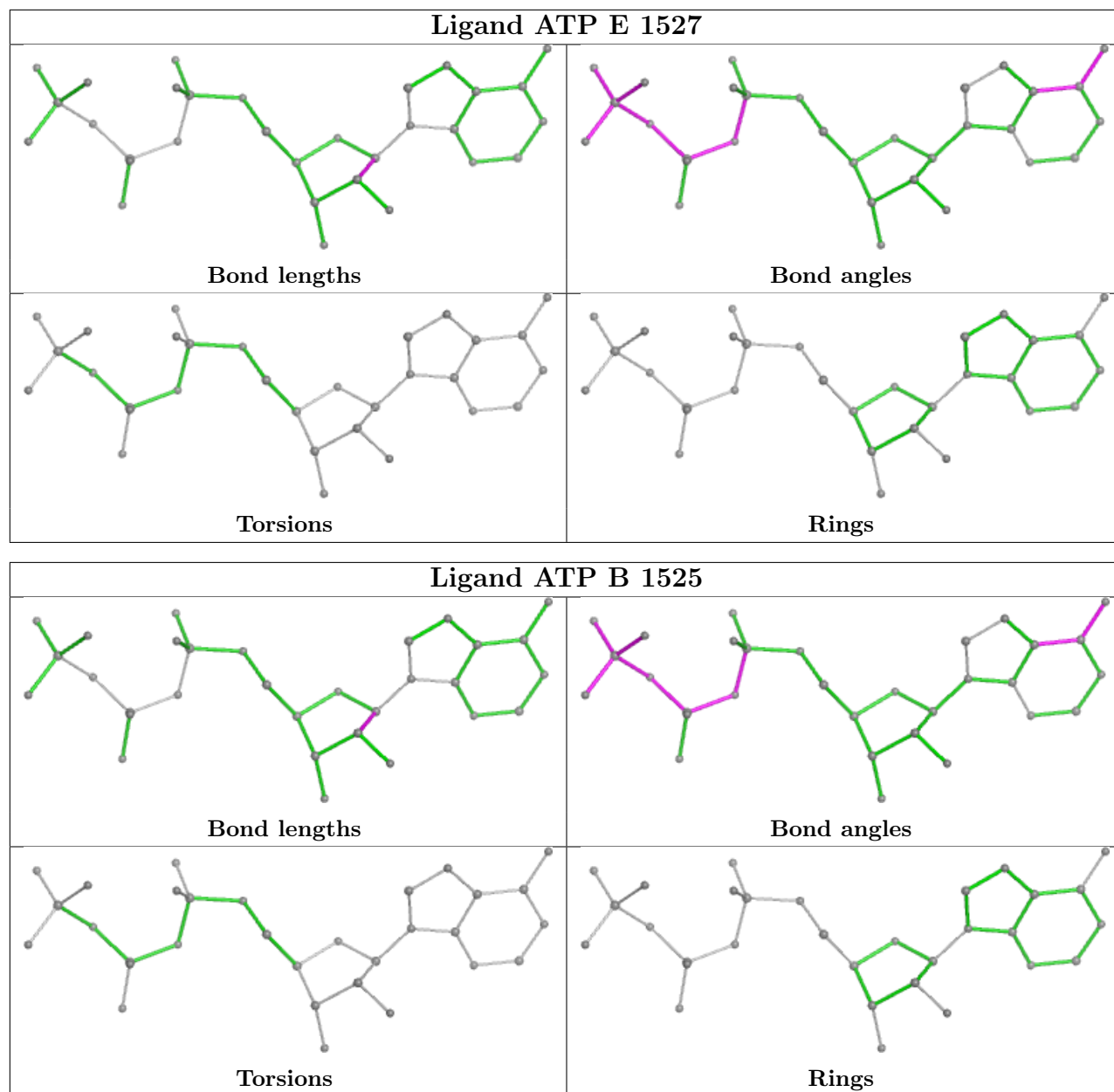



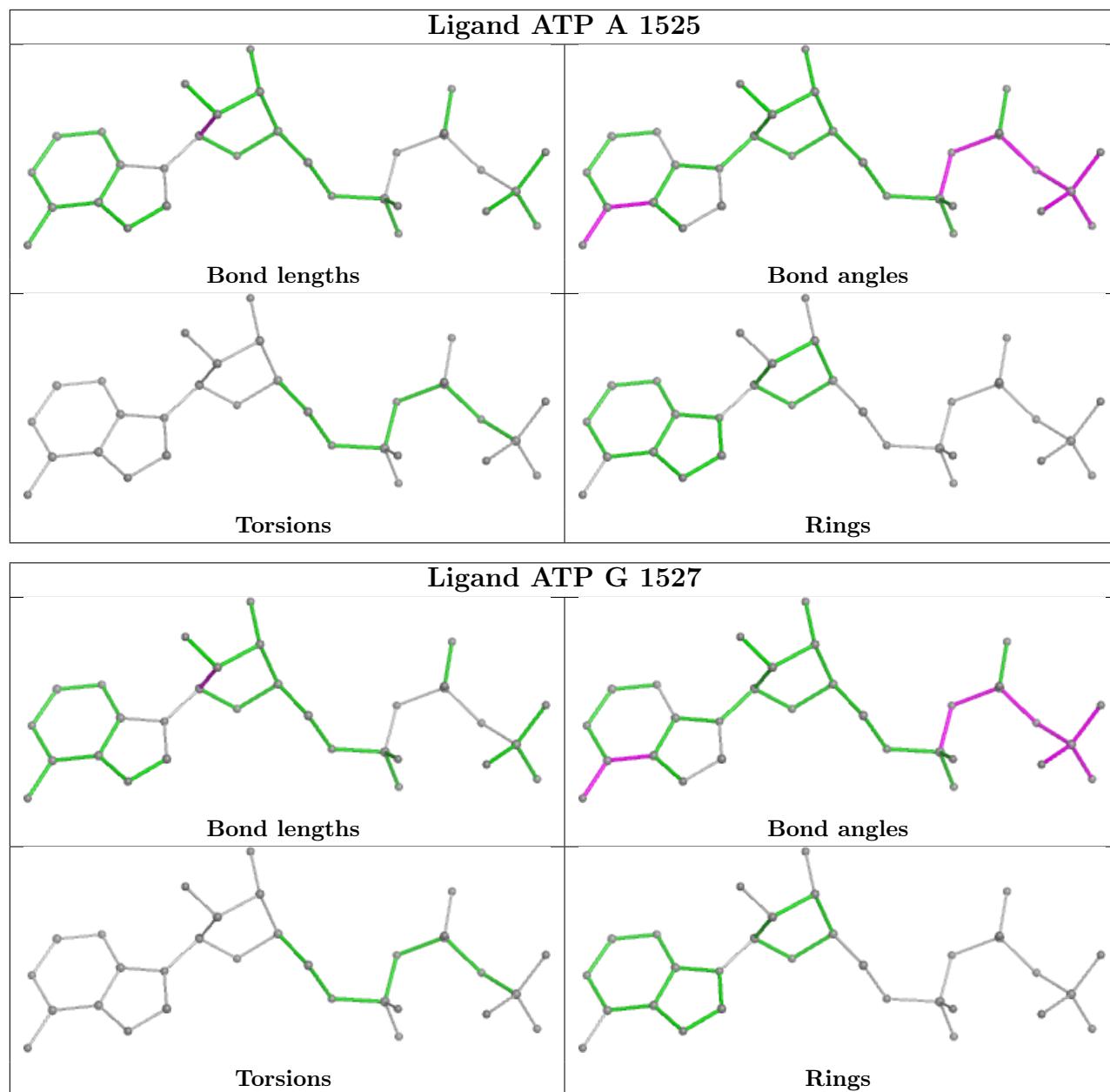

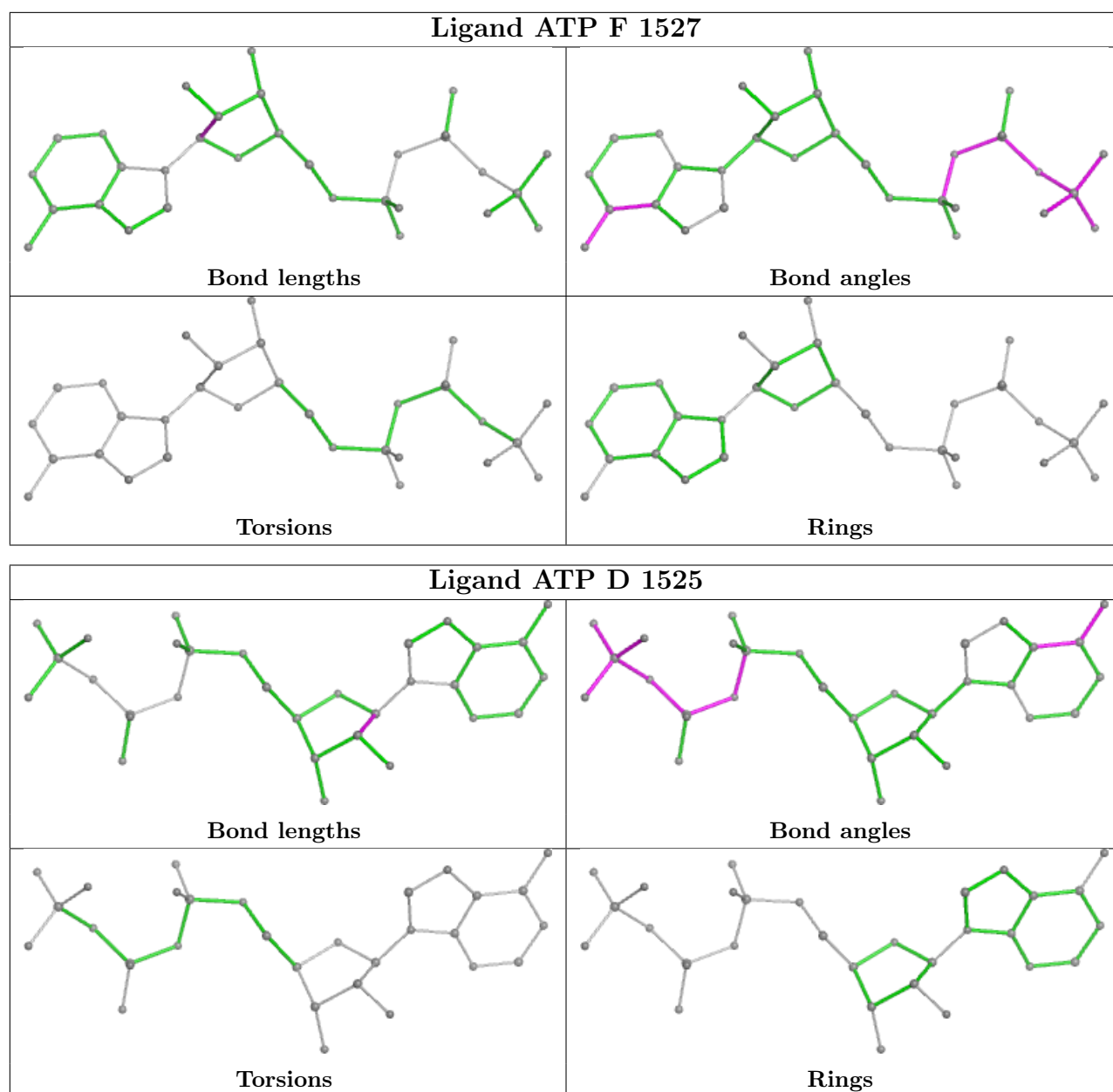

## 5.7 Other polymers [i](#)

There are no such residues in this entry.

## 5.8 Polymer linkage issues [i](#)

The following chains have linkage breaks:

Mol	Chain	Number of breaks
1	N	2
1	J	2

*Continued on next page...*

*Continued from previous page...*

Mol	Chain	Number of breaks
1	L	1
1	K	1

The worst 5 of 6 chain breaks are listed below:

Model	Chain	Residue-1	Atom-1	Residue-2	Atom-2	Distance (Å)
1	N	400:LEU	C	401:HIS	N	1.83
1	L	400:LEU	C	401:HIS	N	1.78
1	J	400:LEU	C	401:HIS	N	1.72
1	J	401:HIS	C	402:ALA	N	1.14
1	K	401:HIS	C	402:ALA	N	1.10

## 6 Map visualisation [i](#)

This section contains visualisations of the EMDB entry EMD-1998. These allow visual inspection of the internal detail of the map and identification of artifacts.

No raw map or half-maps were deposited for this entry and therefore no images, graphs, etc. pertaining to the raw map can be shown.

### 6.1 Orthogonal projections [i](#)

#### 6.1.1 Primary map



X



Y



Z

The images above show the map projected in three orthogonal directions.

### 6.2 Central slices [i](#)

#### 6.2.1 Primary map



X Index: 96



Y Index: 96



Z Index: 96

The images above show central slices of the map in three orthogonal directions.

## 6.3 Largest variance slices [\(i\)](#)

### 6.3.1 Primary map



X Index: 80

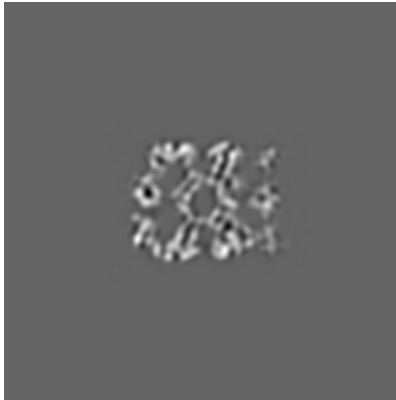

Y Index: 74

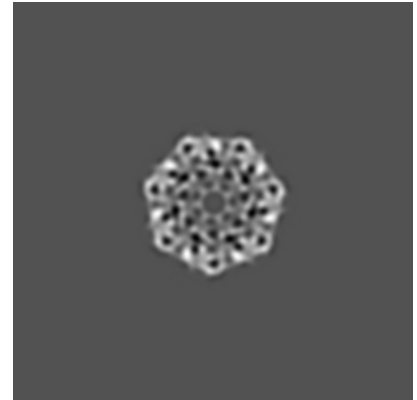

Z Index: 102

The images above show the largest variance slices of the map in three orthogonal directions.

## 6.4 Orthogonal standard-deviation projections (False-color) [\(i\)](#)

### 6.4.1 Primary map

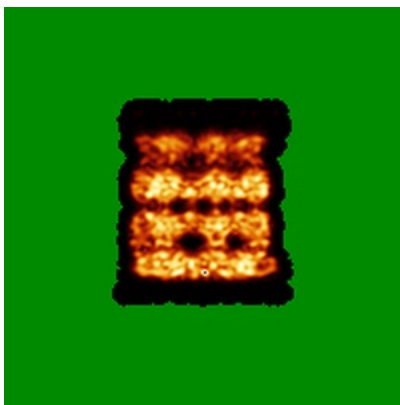

X

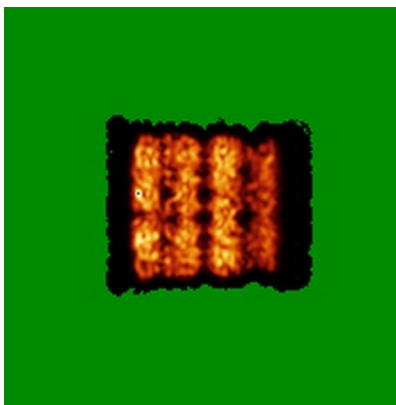

Y

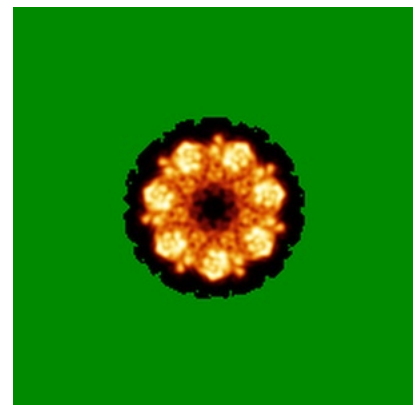

Z

The images above show the map standard deviation projections with false color in three orthogonal directions. Minimum values are shown in green, max in blue, and dark to light orange shades represent small to large values respectively.

## 6.5 Orthogonal surface views [i](#)

### 6.5.1 Primary map

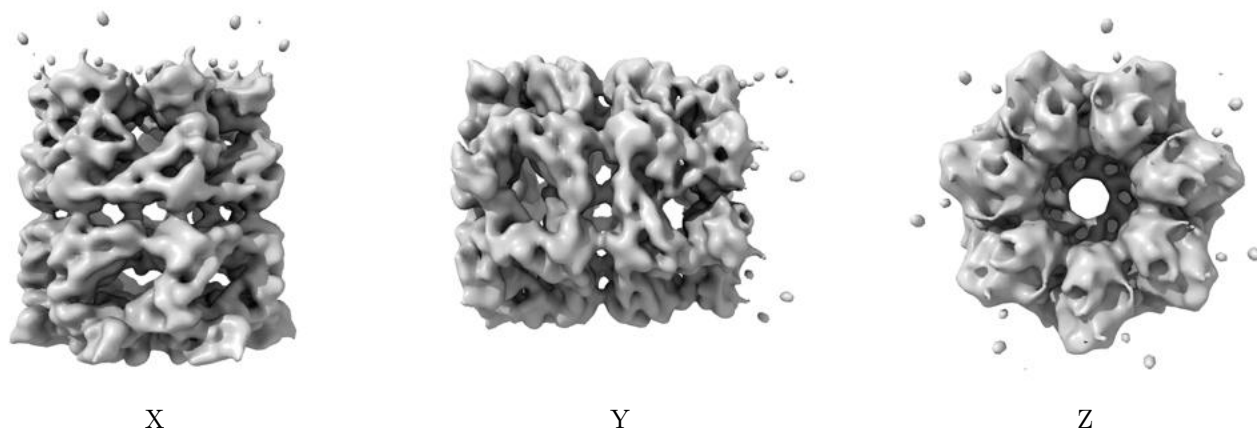

The images above show the 3D surface view of the map at the recommended contour level 0.2. These images, in conjunction with the slice images, may facilitate assessment of whether an appropriate contour level has been provided.

## 6.6 Mask visualisation [i](#)

This section was not generated. No masks/segmentation were deposited.

## 7 Map analysis [i](#)

This section contains the results of statistical analysis of the map.

### 7.1 Map-value distribution [i](#)

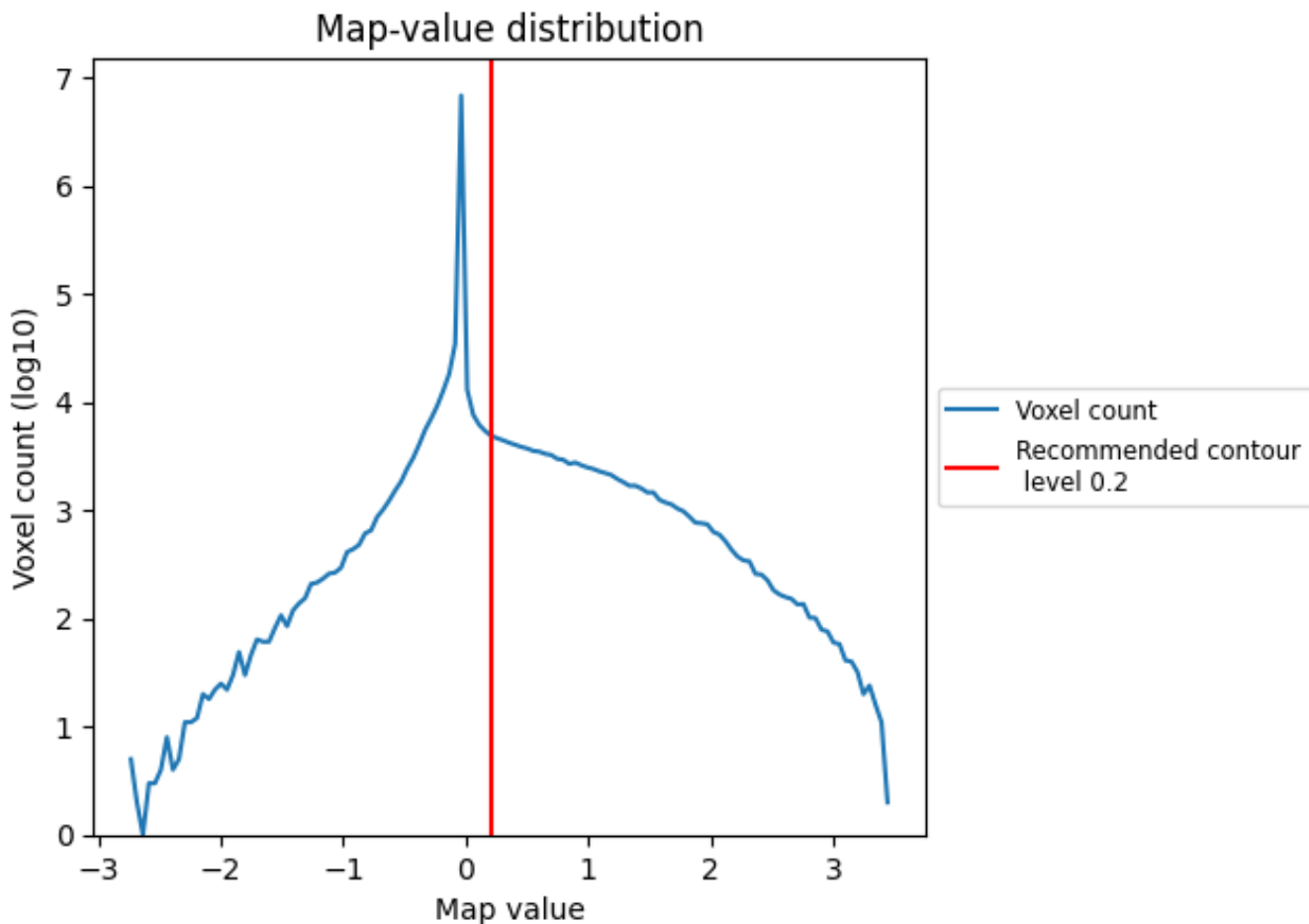

The map-value distribution is plotted in 128 intervals along the x-axis. The y-axis is logarithmic. A spike in this graph at zero usually indicates that the volume has been masked.

## 7.2 Volume estimate [i](#)

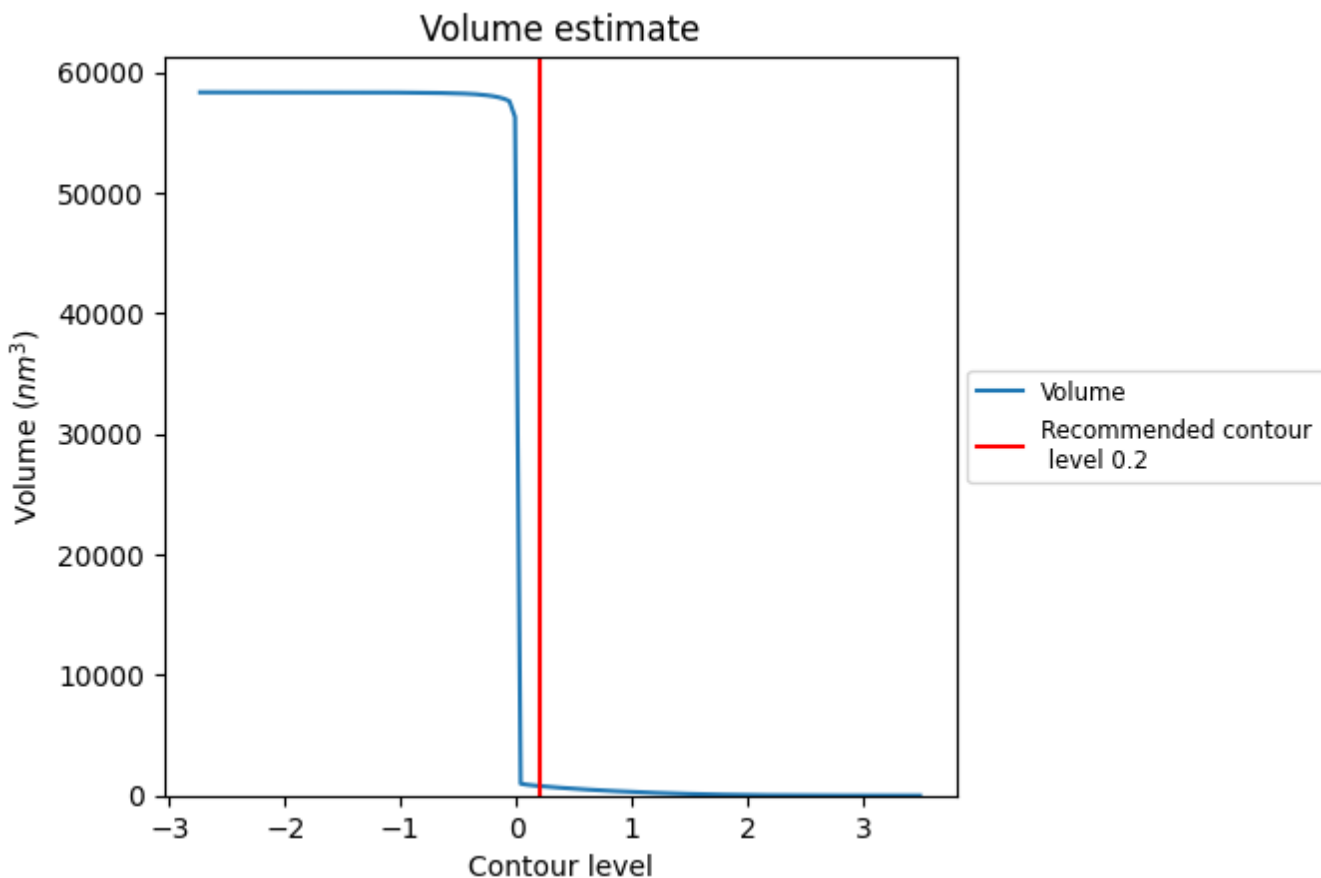

The volume at the recommended contour level is 791 nm<sup>3</sup>; this corresponds to an approximate mass of 714 kDa.

The volume estimate graph shows how the enclosed volume varies with the contour level. The recommended contour level is shown as a vertical line and the intersection between the line and the curve gives the volume of the enclosed surface at the given level.



### 7.3 Rotationally averaged power spectrum i

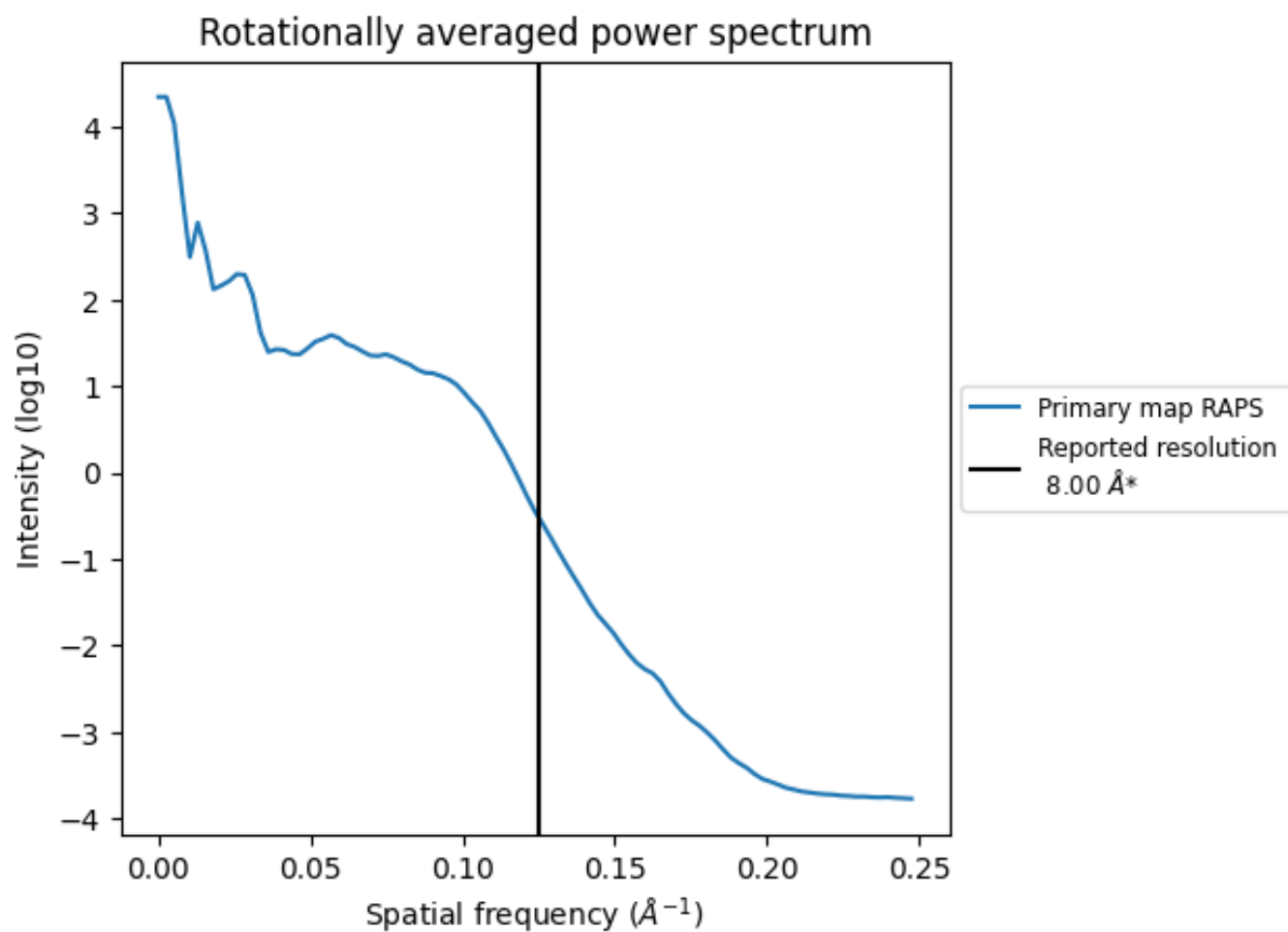

\*Reported resolution corresponds to spatial frequency of 0.125 Å<sup>-1</sup>

## 8 Fourier-Shell correlation

This section was not generated. No FSC curve or half-maps provided.

## 9 Map-model fit [i](#)

This section contains information regarding the fit between EMDB map EMD-1998 and PDB model 4AAQ. Per-residue inclusion information can be found in section [3](#) on page [8](#).

### 9.1 Map-model overlay [i](#)

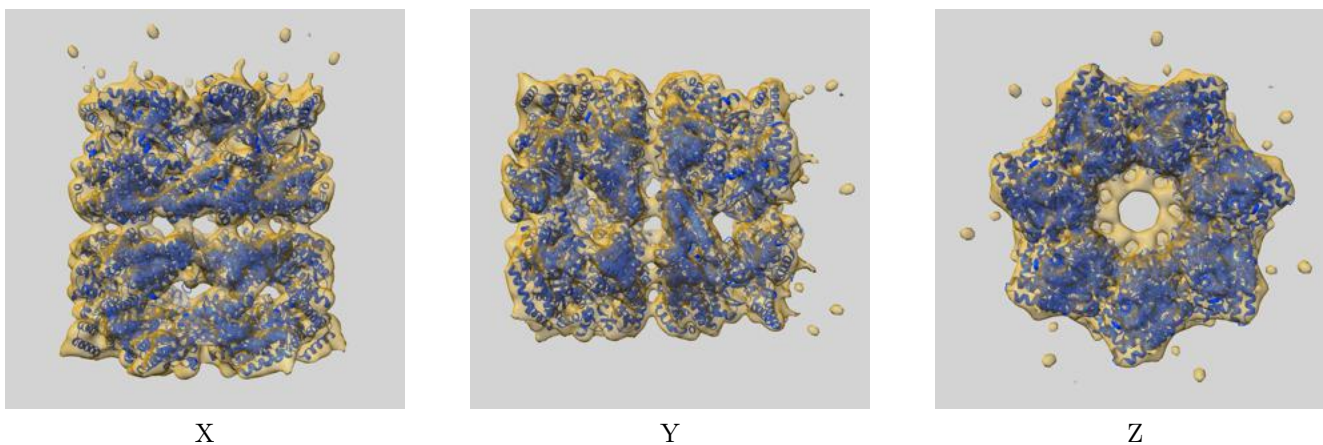

The images above show the 3D surface view of the map at the recommended contour level 0.2 at 50% transparency in yellow overlaid with a ribbon representation of the model coloured in blue. These images allow for the visual assessment of the quality of fit between the atomic model and the map.

## 9.2 Q-score mapped to coordinate model [\(i\)](#)

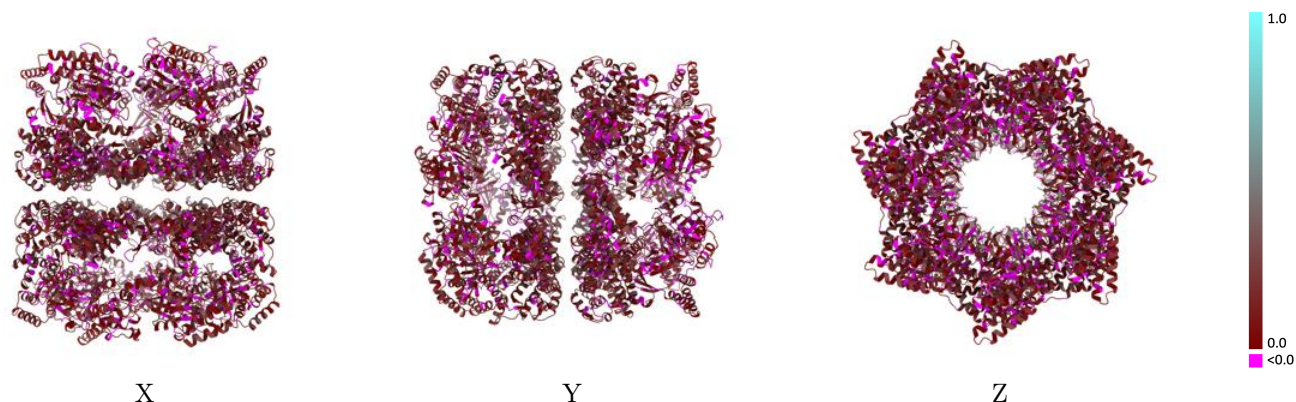

The images above show the model with each residue coloured according to its Q-score. This shows their resolvability in the map with higher Q-score values reflecting better resolvability. Please note: Q-score is calculating the resolvability of atoms, and thus high values are only expected at resolutions at which atoms can be resolved. Low Q-score values may therefore be expected for many entries.

## 9.3 Atom inclusion mapped to coordinate model [\(i\)](#)

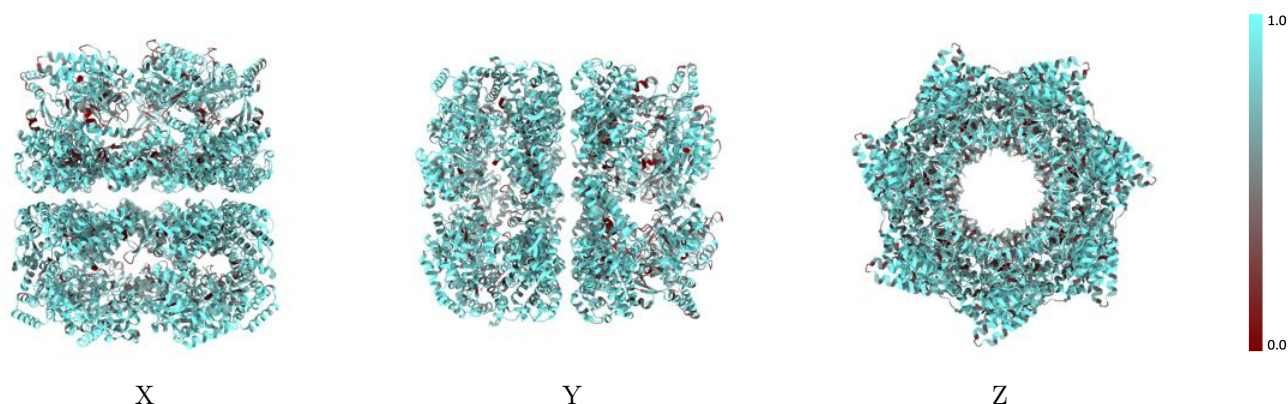

The images above show the model with each residue coloured according to its atom inclusion. This shows to what extent they are inside the map at the recommended contour level (0.2).



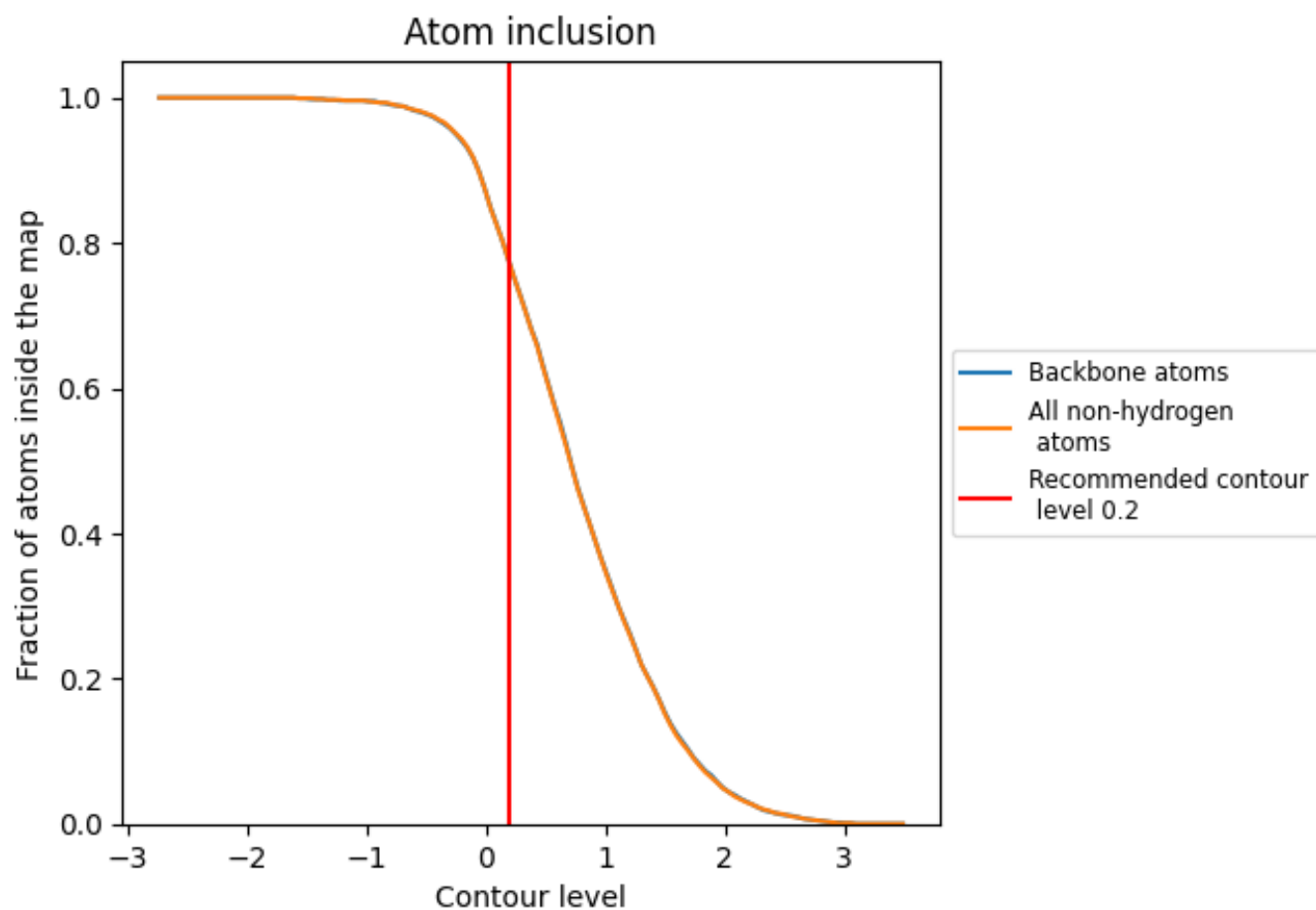



























## 9.4 Atom inclusion [i](#)



At the recommended contour level, 77% of all backbone atoms, 77% of all non-hydrogen atoms, are inside the map.

## 9.5 Map-model fit summary

The table lists the average atom inclusion at the recommended contour level (0.2) and Q-score for the entire model and for each chain.

Chain	Atom inclusion	Q-score
All	 0.7700	 0.1090
A	 0.7570	 0.1030
B	 0.7560	 0.1030
C	 0.7580	 0.1030
D	 0.7560	 0.1030
E	 0.7570	 0.1040
F	 0.7560	 0.1050
G	 0.7570	 0.1040
H	 0.7960	 0.1160
I	 0.7950	 0.1160
J	 0.7960	 0.1150
K	 0.7970	 0.1140
L	 0.7960	 0.1140
M	 0.7970	 0.1140
N	 0.7960	 0.1130

