



# wwPDB EM Validation Summary Report ⓘ

Nov 11, 2024 – 03:34 PM JST

PDB ID : 5ZZ8  
EMDB ID : EMD-6976  
Title : Structure of the Herpes simplex virus type 2 C-capsid with capsid-vertex-specific component  
Authors : Wang, J.L.; Yuan, S.; Zhu, D.J.; Tang, H.; Wang, N.; Chen, W.Y.; Gao, Q.; Li, Y.H.; Wang, J.Z.; Liu, H.R.; Zhang, X.Z.; Rao, Z.H.; Wang, X.X.  
Deposited on : 2018-05-31  
Resolution : 3.75 Å(reported)

This is a wwPDB EM Validation Summary Report for a publicly released PDB entry.

We welcome your comments at [validation@mail.wwpdb.org](mailto:validation@mail.wwpdb.org)

A user guide is available at

<https://www.wwpdb.org/validation/2017/EMValidationReportHelp>

with specific help available everywhere you see the ⓘ symbol.

The types of validation reports are described at

<http://www.wwpdb.org/validation/2017/FAQs#types>.



---

The following versions of software and data (see [references ⓘ](#)) were used in the production of this report:

EMDB validation analysis : 0.0.1.dev113  
MolProbity : 4.02b-467  
Percentile statistics : 20231227.v01 (using entries in the PDB archive December 27th 2023)  
MapQ : 1.9.13  
Ideal geometry (proteins) : Engh & Huber (2001)  
Ideal geometry (DNA, RNA) : Parkinson et al. (1996)  
Validation Pipeline (wwPDB-VP) : 2.39

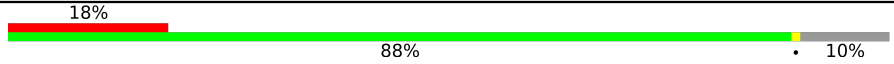
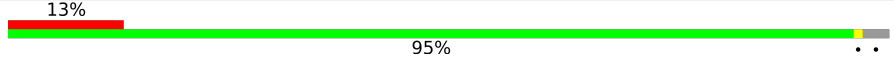
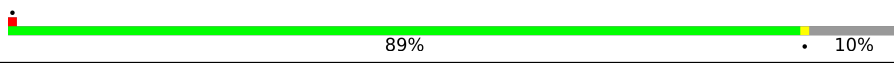
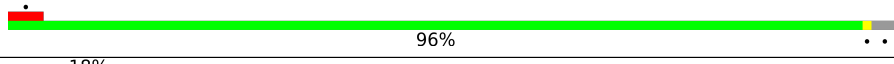
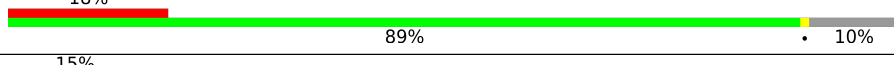
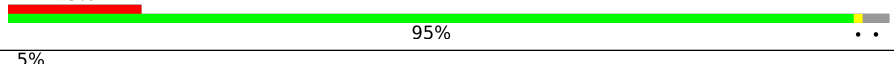
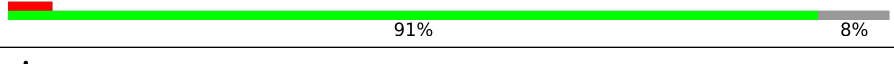
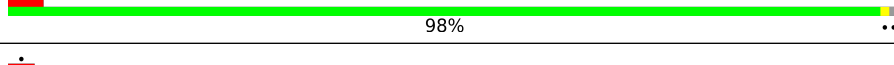
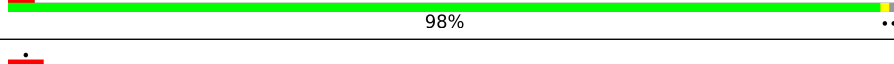
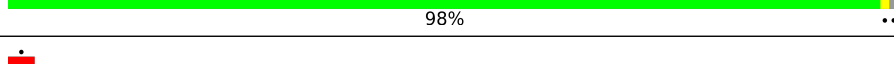
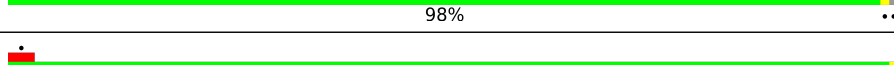
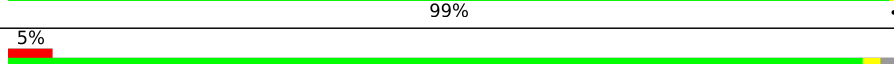
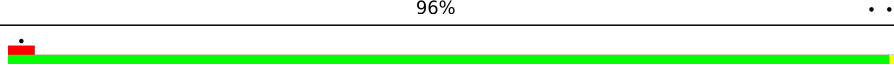
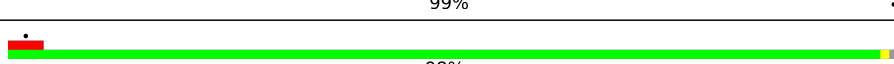
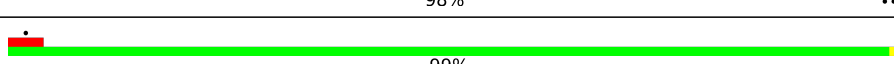
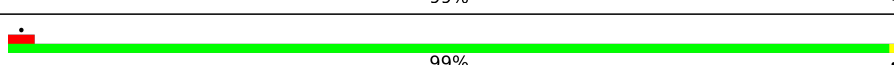
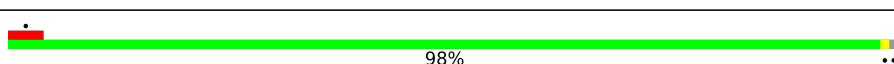
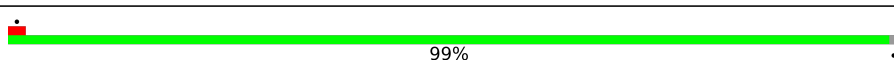
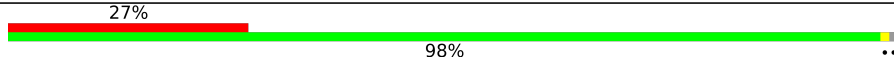
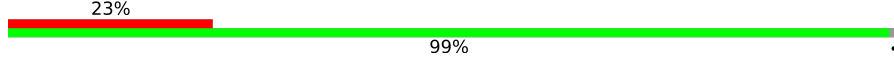
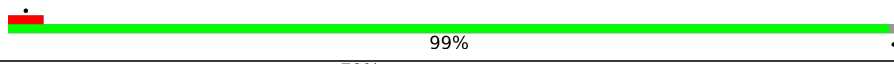
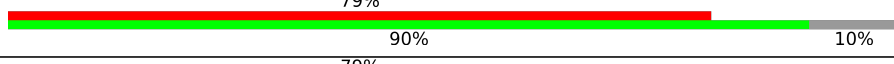
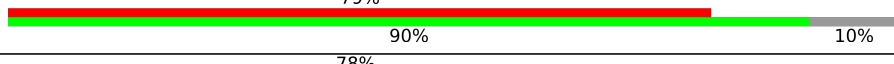
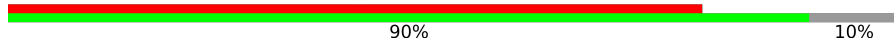

Continued from previous page...

Mol	Chain	Length	Quality of chain
2	U	318	
2	V	318	
2	X	318	
2	Y	318	
2	x	318	
2	y	318	
3	A	1374	
3	B	1374	
3	C	1374	
3	D	1374	
3	E	1374	
3	F	1374	
3	G	1374	
3	H	1374	
3	I	1374	
3	J	1374	
3	K	1374	
3	L	1374	
3	M	1374	
3	N	1374	
3	O	1374	
3	P	1374	
4	b	112	
4	c	112	
4	d	112	

Continued on next page...

Continued from previous page...

Mol	Chain	Length	Quality of chain
4	e	112	79% 90% 10%
4	f	112	79% 90% 10%
4	g	112	79% 90% 10%
4	h	112	71% 89% 10%
4	i	112	71% 90% 10%
4	j	112	70% 89% 10%
4	k	112	70% 89% 10%
4	l	112	72% 90% 10%
4	m	112	71% 90% 10%
4	n	112	79% 89% 10%
4	o	112	77% 89% 10%
4	p	112	74% 89% 10%
5	q	702	15% 78% 21%
6	r	585	16% 84%
6	s	585	14% 86%
7	t	3122	98%
7	u	3122	98%

## 2 Entry composition [i](#)

There are 7 unique types of molecules in this entry. The entry contains 218714 atoms, of which 0 are hydrogens and 0 are deuteriums.

In the tables below, the AltConf column contains the number of residues with at least one atom in alternate conformation and the Trace column contains the number of residues modelled with at most 2 atoms.

- Molecule 1 is a protein called VP19C.

Mol	Chain	Residues	Atoms					AltConf	Trace
			Total	C	N	O	S		
1	Q	350	2589	1620	493	461	15	0	0
1	T	350	2595	1623	496	461	15	0	0
1	W	350	2577	1613	490	459	15	0	0
1	1	350	2589	1620	493	461	15	0	0
1	w	350	2595	1623	496	461	15	0	0

- Molecule 2 is a protein called VP23.

Mol	Chain	Residues	Atoms					AltConf	Trace
			Total	C	N	O	S		
2	R	286	2102	1343	374	379	6	0	0
2	S	308	2337	1484	413	429	11	0	0
2	U	286	2102	1343	374	379	6	0	0
2	V	308	2337	1484	413	429	11	0	0
2	X	286	2102	1343	374	379	6	0	0
2	Y	308	2337	1484	413	429	11	0	0
2	3	286	2102	1343	374	379	6	0	0
2	2	308	2334	1481	413	429	11	0	0
2	x	286	2102	1343	374	379	6	0	0
2	y	308	2328	1478	410	429	11	0	0

- Molecule 3 is a protein called Major capsid protein.

Mol	Chain	Residues	Atoms					AltConf	Trace
3	I	1362	Total	C	N	O	S	0	0
			10418	6584	1873	1905	56		
3	J	1364	Total	C	N	O	S	0	0
			10408	6582	1863	1907	56		
3	K	1364	Total	C	N	O	S	0	0
			10414	6585	1866	1907	56		
3	L	1362	Total	C	N	O	S	0	0
			10422	6586	1873	1907	56		
3	M	1366	Total	C	N	O	S	0	0
			10449	6603	1877	1913	56		
3	A	1259	Total	C	N	O	S	0	0
			9646	6107	1725	1762	52		
3	H	1362	Total	C	N	O	S	0	0
			10416	6583	1873	1905	55		
3	N	1362	Total	C	N	O	S	0	0
			10397	6574	1868	1899	56		
3	O	1366	Total	C	N	O	S	0	0
			10417	6585	1877	1899	56		
3	P	1364	Total	C	N	O	S	0	0
			10407	6582	1866	1903	56		
3	B	1357	Total	C	N	O	S	0	0
			10349	6542	1854	1897	56		
3	C	1356	Total	C	N	O	S	0	0
			10355	6545	1857	1897	56		
3	D	1364	Total	C	N	O	S	0	0
			10413	6583	1872	1902	56		
3	E	1362	Total	C	N	O	S	0	0
			10405	6578	1870	1901	56		
3	F	1362	Total	C	N	O	S	0	0
			10392	6571	1862	1903	56		
3	G	1346	Total	C	N	O	S	0	0
			10261	6487	1845	1874	55		

- Molecule 4 is a protein called VP26.

Mol	Chain	Residues	Atoms					AltConf	Trace
4	h	101	Total	C	N	O	S	0	0
			773	489	143	138	3		
4	i	101	Total	C	N	O	S	0	0
			773	489	143	138	3		
4	j	101	Total	C	N	O	S	0	0
			773	489	143	138	3		

*Continued on next page...*

*Continued from previous page...*

Mol	Chain	Residues	Atoms					AltConf	Trace
4	k	101	Total	C	N	O	S	0	0
			773	489	143	138	3		
4	l	101	Total	C	N	O	S	0	0
			773	489	143	138	3		
4	m	101	Total	C	N	O	S	0	0
			773	489	143	138	3		
4	n	101	Total	C	N	O	S	0	0
			773	489	143	138	3		
4	o	101	Total	C	N	O	S	0	0
			773	489	143	138	3		
4	p	101	Total	C	N	O	S	0	0
			773	489	143	138	3		
4	b	101	Total	C	N	O	S	0	0
			773	489	143	138	3		
4	c	101	Total	C	N	O	S	0	0
			773	489	143	138	3		
4	d	101	Total	C	N	O	S	0	0
			773	489	143	138	3		
4	e	101	Total	C	N	O	S	0	0
			773	489	143	138	3		
4	f	101	Total	C	N	O	S	0	0
			773	489	143	138	3		
4	g	101	Total	C	N	O	S	0	0
			773	489	143	138	3		

- Molecule 5 is a protein called UL17.

Mol	Chain	Residues	Atoms					AltConf	Trace
5	q	554	Total	C	N	O	S	0	0
			4241	2700	774	749	18		

- Molecule 6 is a protein called UL25.

Mol	Chain	Residues	Atoms					AltConf	Trace
6	r	94	Total	C	N	O	S	0	0
			764	490	136	136	2		
6	s	80	Total	C	N	O	S	0	0
			651	413	123	114	1		

- Molecule 7 is a protein called UL36.

Mol	Chain	Residues	Atoms					AltConf	Trace
			Total	C	N	O	S		
7	t	47	Total 383	234	87	60	2	0	0
7	u	47	Total 383	234	87	60	2	0	0



### 3 Residue-property plots [i](#)

These plots are drawn for all protein, RNA, DNA and oligosaccharide chains in the entry. The first graphic for a chain summarises the proportions of the various outlier classes displayed in the second graphic. The second graphic shows the sequence view annotated by issues in geometry and atom inclusion in map density. Residues are color-coded according to the number of geometric quality criteria for which they contain at least one outlier: green = 0, yellow = 1, orange = 2 and red = 3 or more. A red diamond above a residue indicates a poor fit to the EM map for this residue (all-atom inclusion < 40%). Stretches of 2 or more consecutive residues without any outlier are shown as a green connector. Residues present in the sample, but not in the model, are shown in grey.

- Molecule 1: VP19C

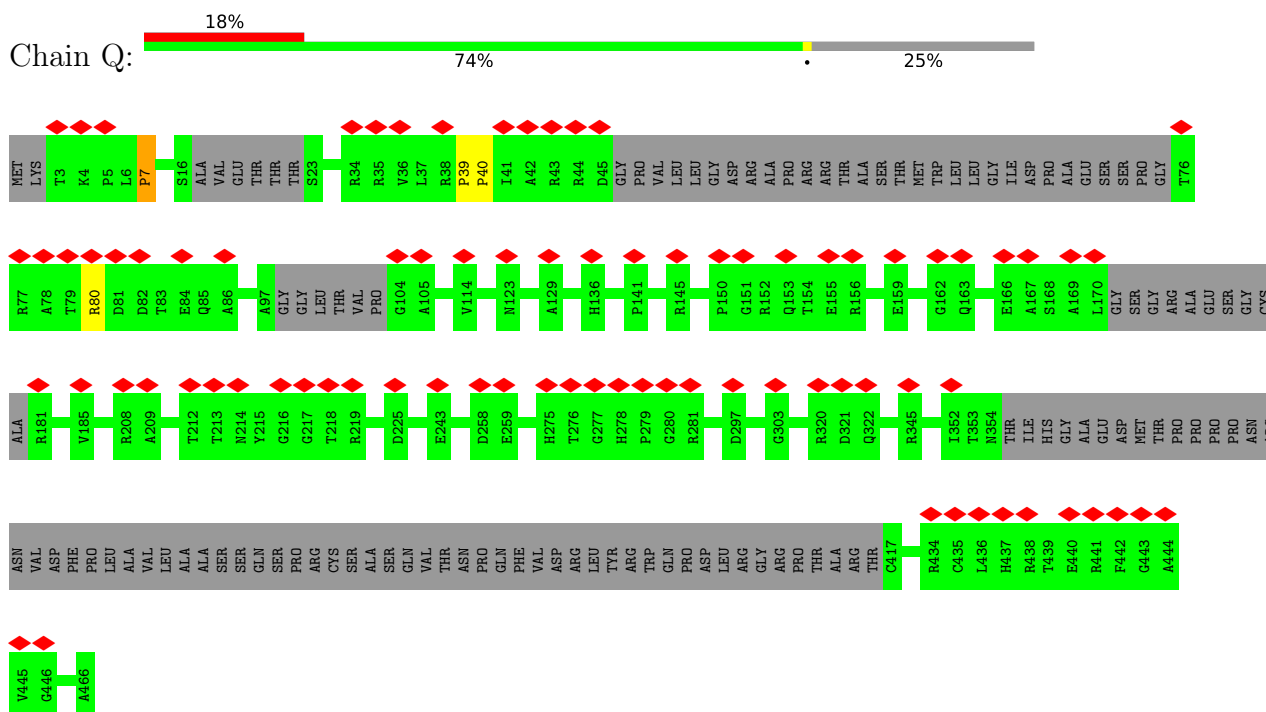

- Molecule 1: VP19C

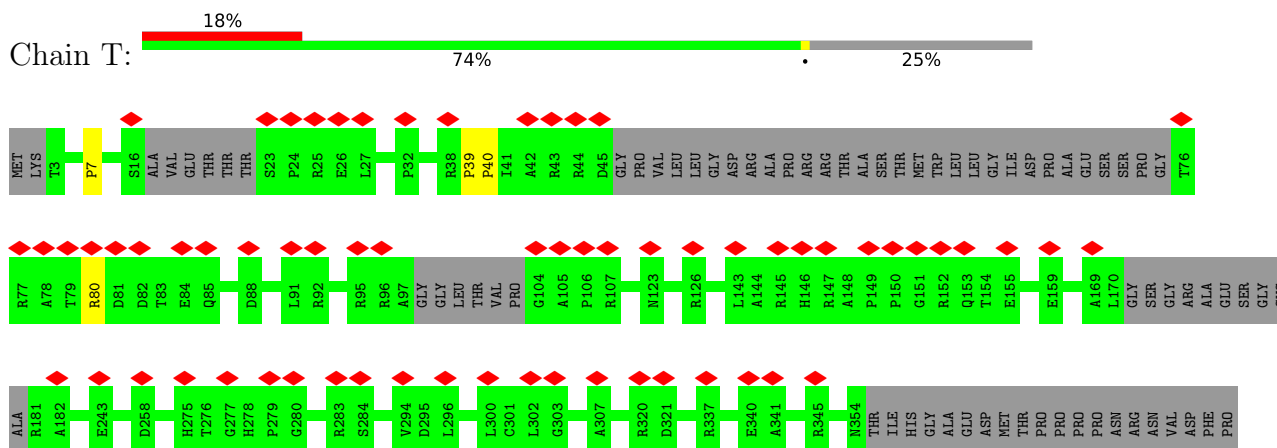

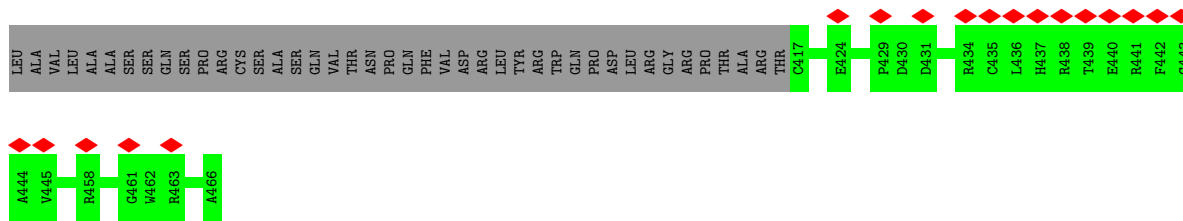

• Molecule 1: VP19C

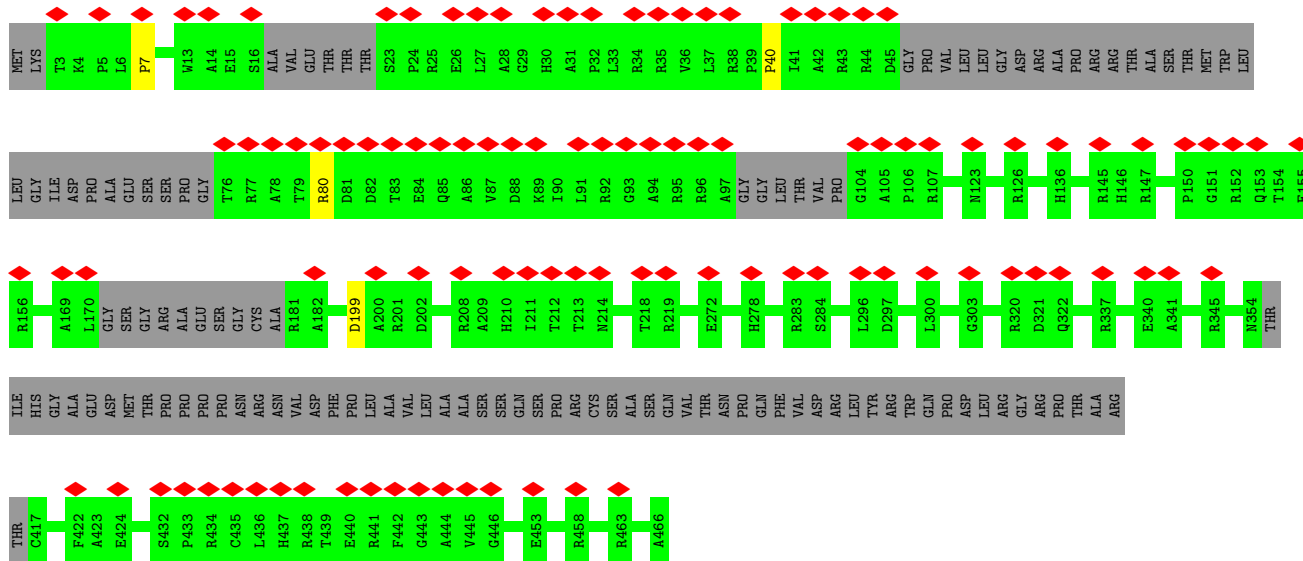
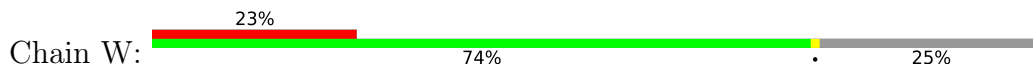

• Molecule 1: VP19C

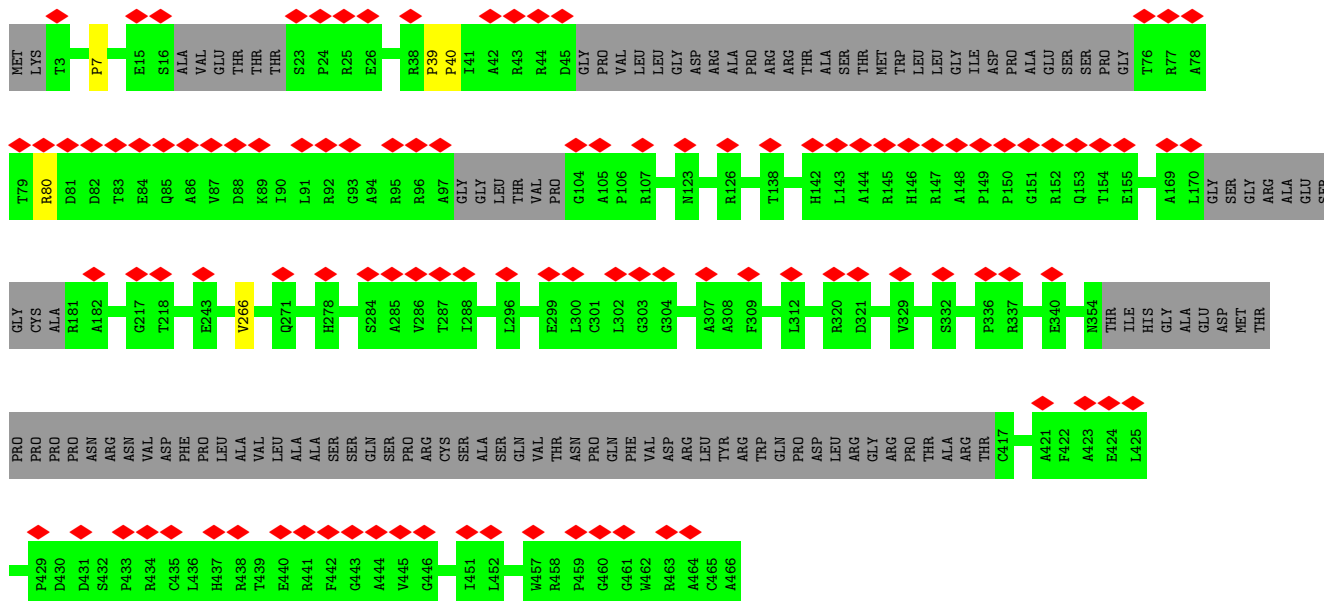

• Molecule 1: VP19C

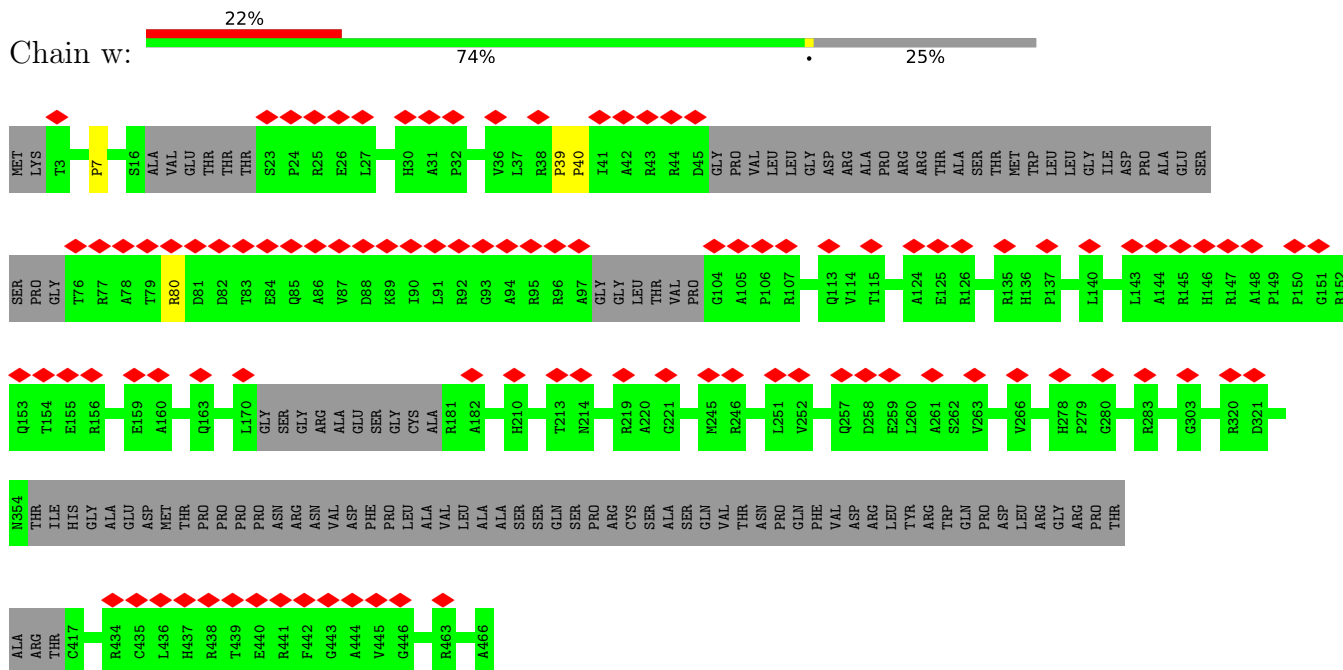

• Molecule 2: VP23

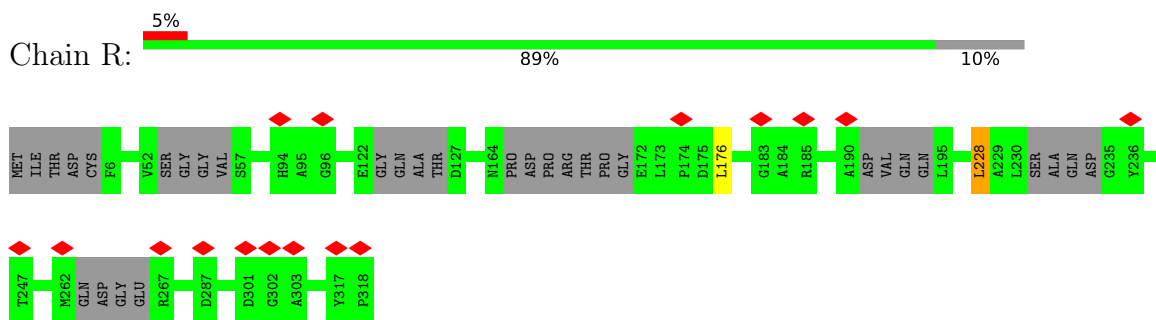

• Molecule 2: VP23

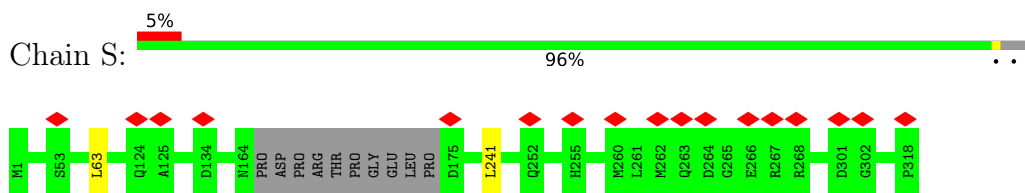

• Molecule 2: VP23

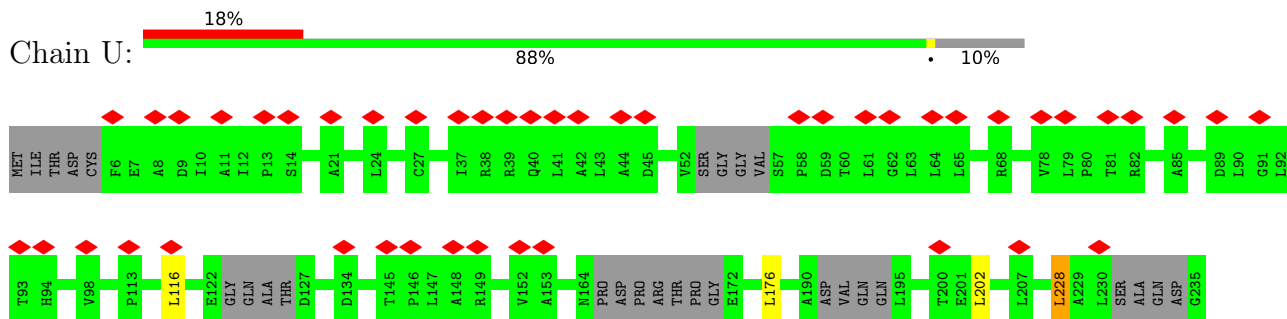

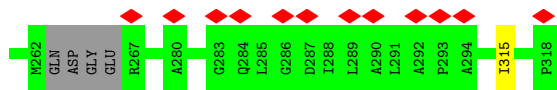

• Molecule 2: VP23

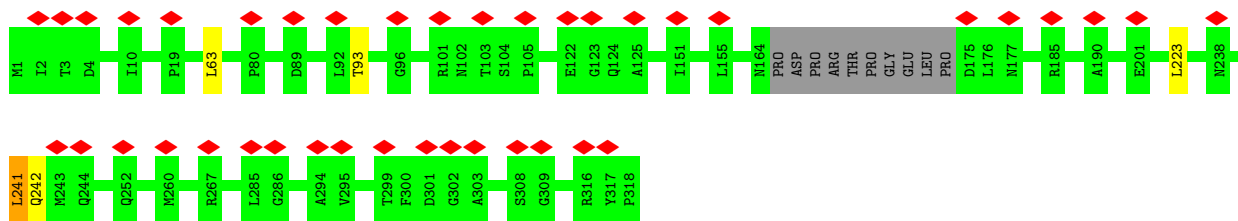

• Molecule 2: VP23

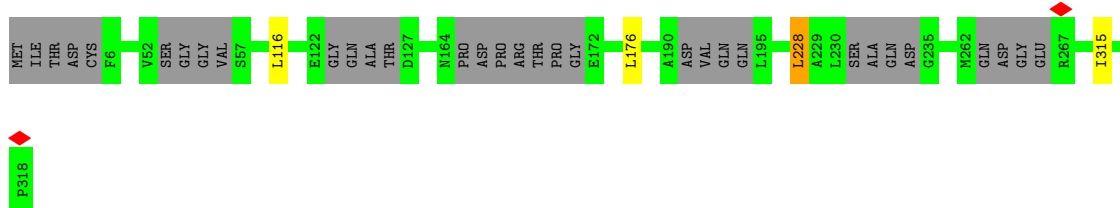
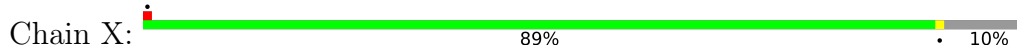

• Molecule 2: VP23

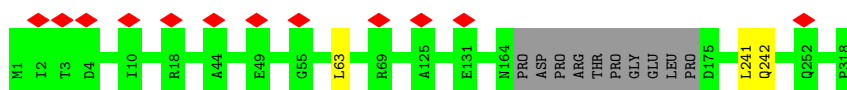

• Molecule 2: VP23

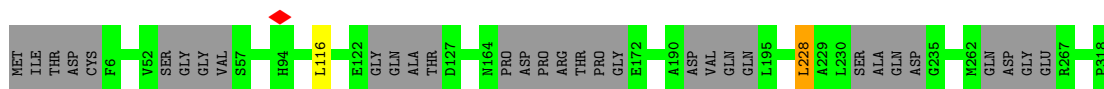
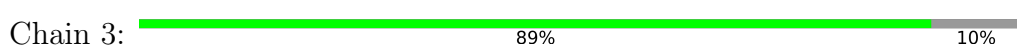

• Molecule 2: VP23

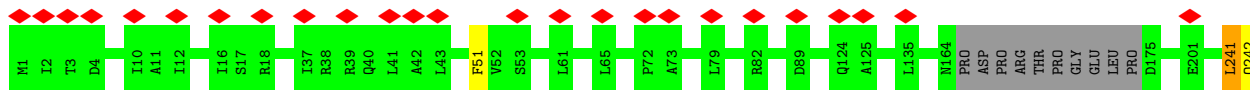

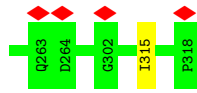

• Molecule 2: VP23

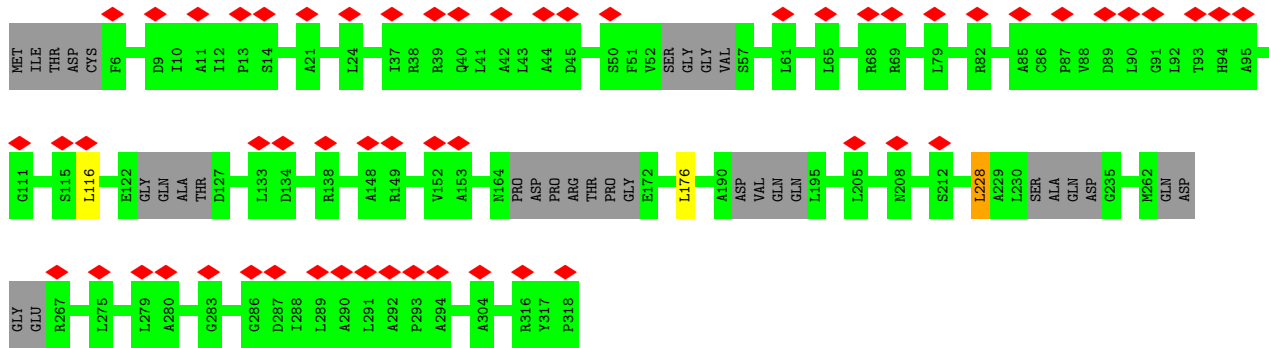
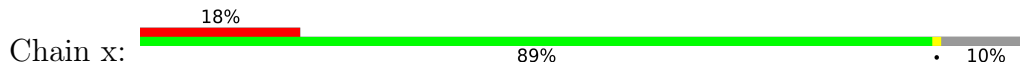

• Molecule 2: VP23

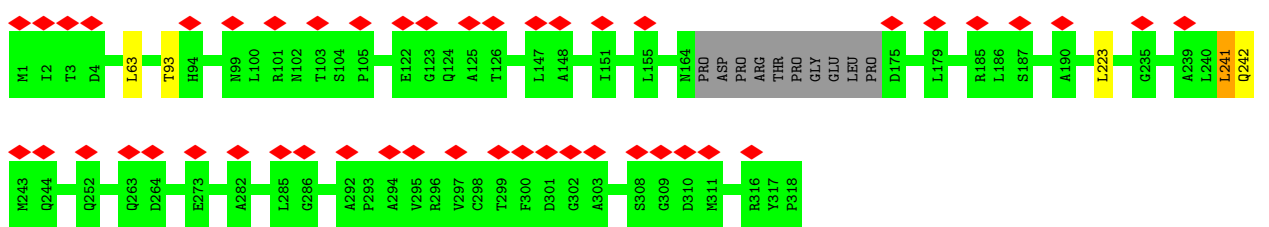

• Molecule 3: Major capsid protein

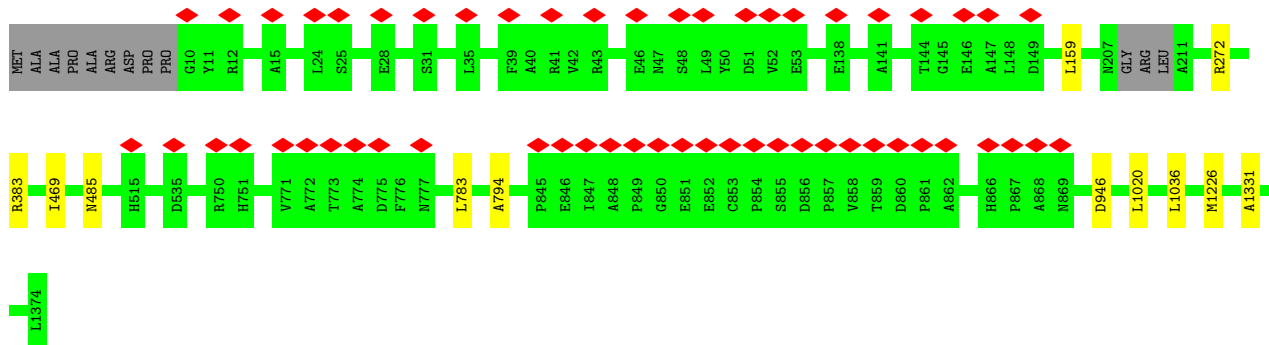

• Molecule 3: Major capsid protein



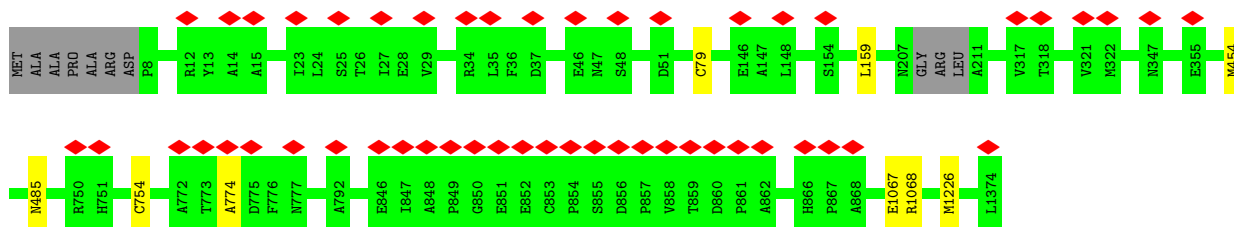

• Molecule 3: Major capsid protein

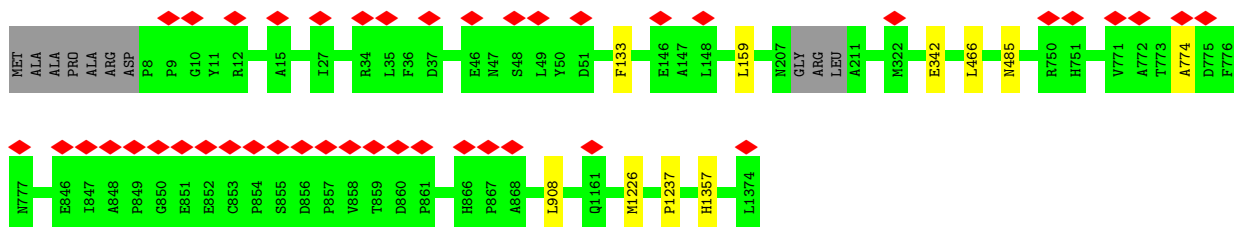

• Molecule 3: Major capsid protein



• Molecule 3: Major capsid protein

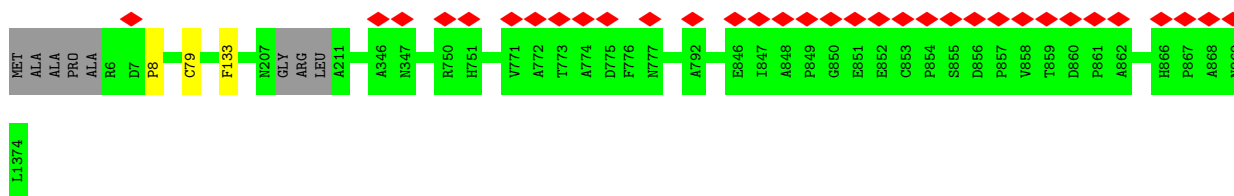

• Molecule 3: Major capsid protein

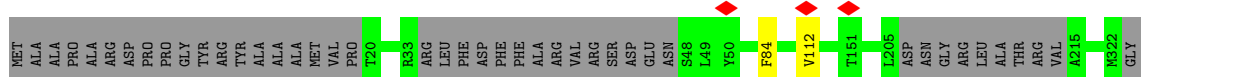

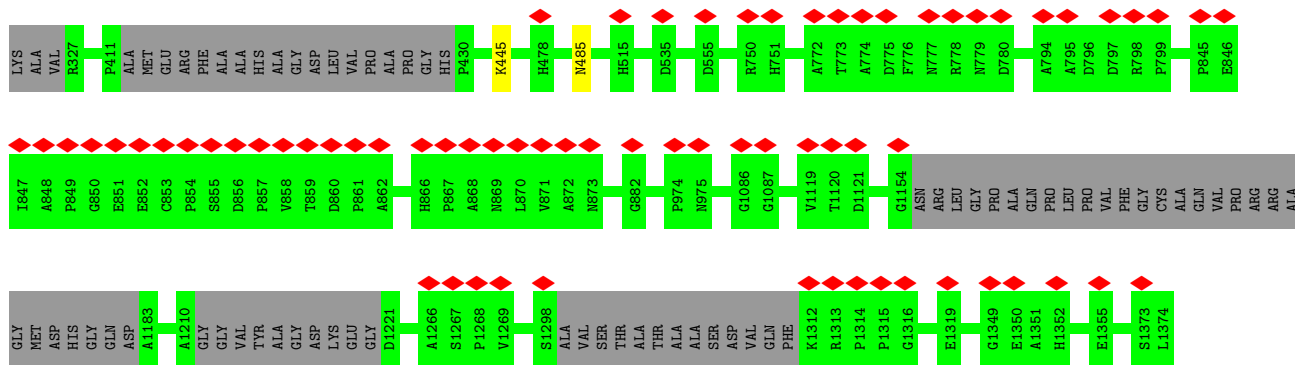

• Molecule 3: Major capsid protein

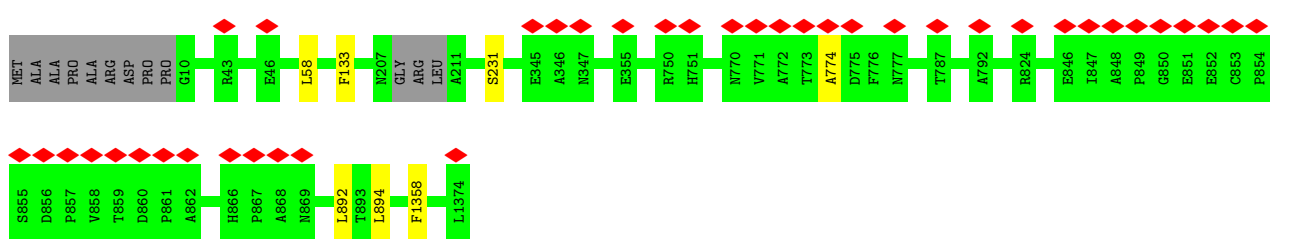

• Molecule 3: Major capsid protein

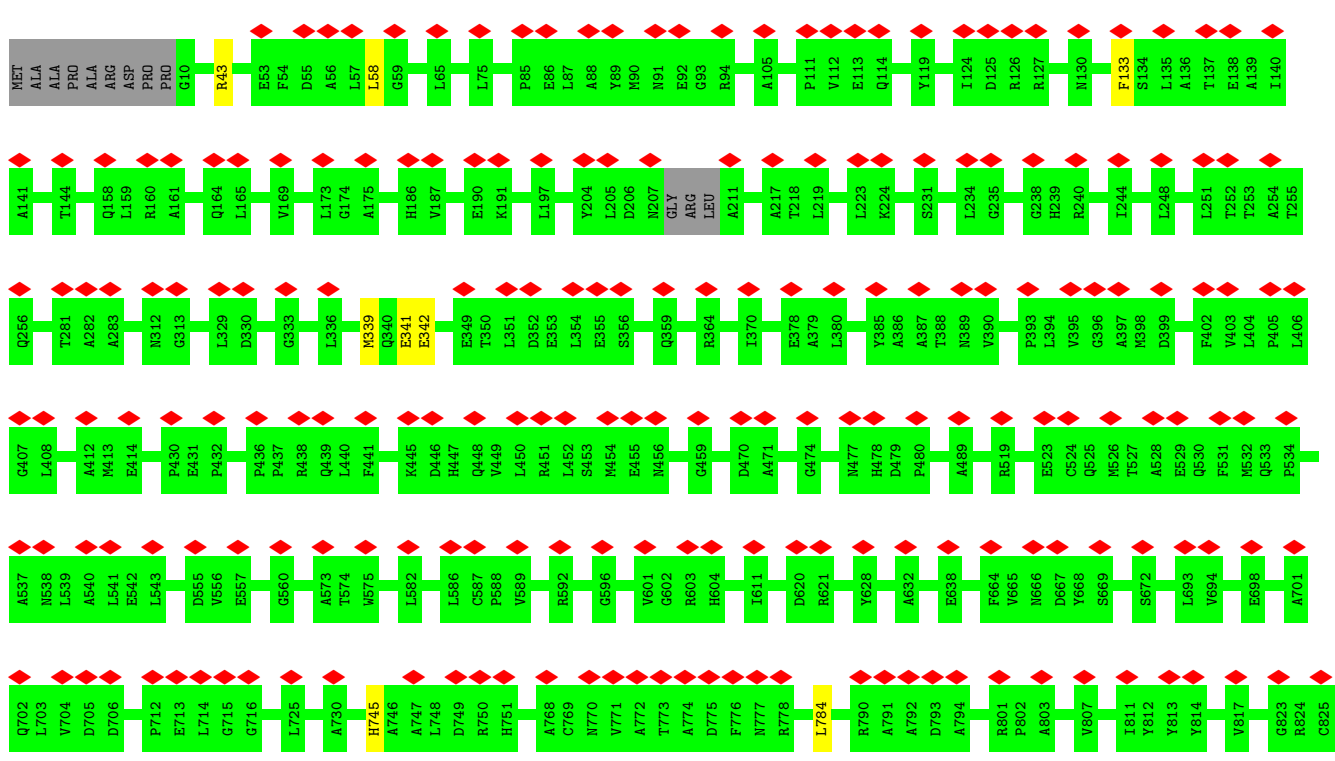







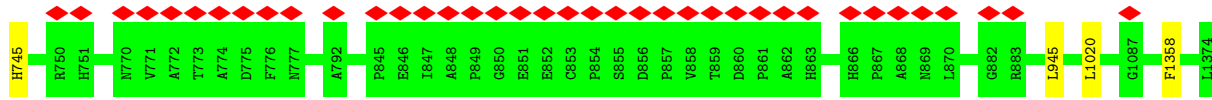

• Molecule 3: Major capsid protein

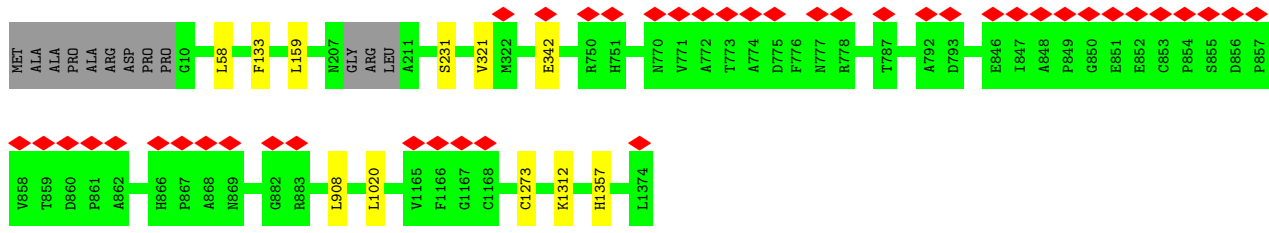

• Molecule 3: Major capsid protein

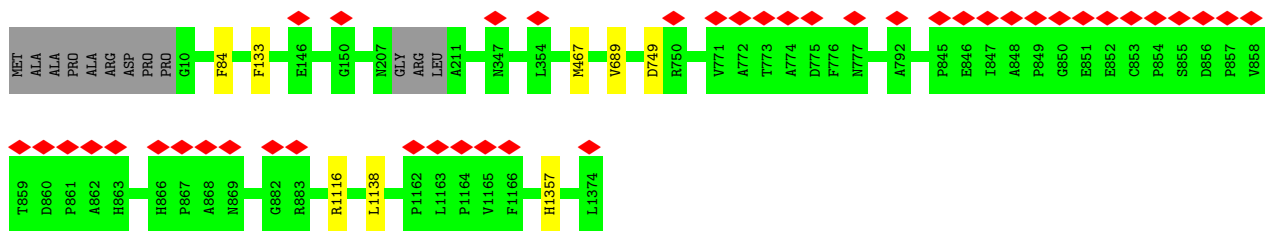

• Molecule 3: Major capsid protein

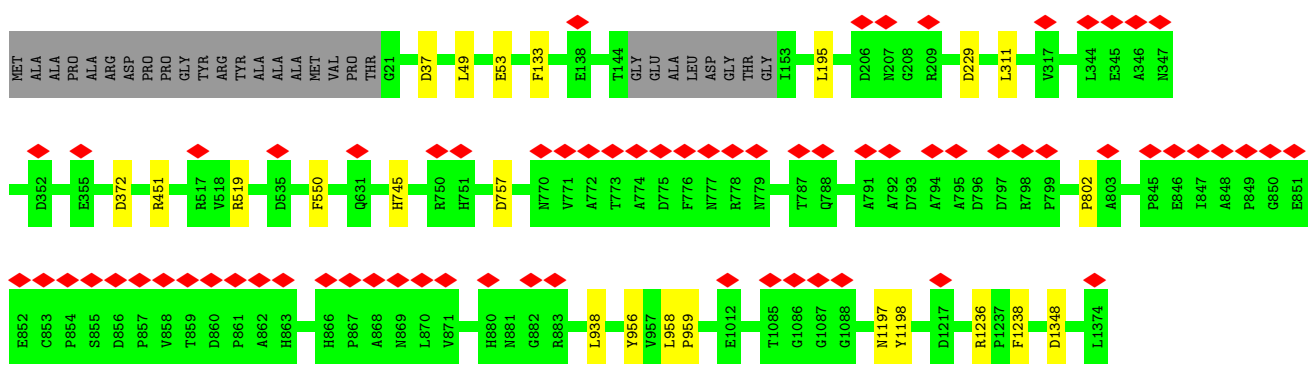

• Molecule 4: VP26

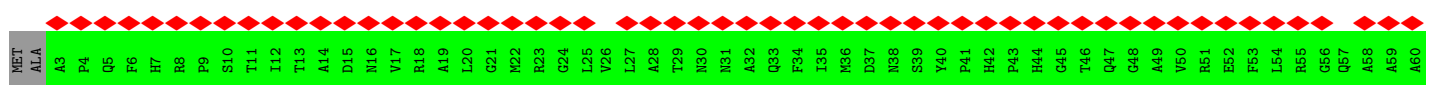
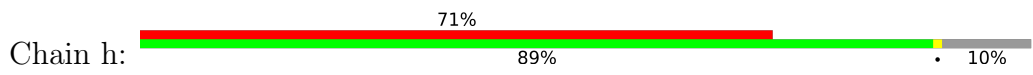



• Molecule 4: VP26

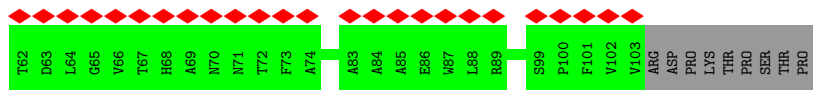
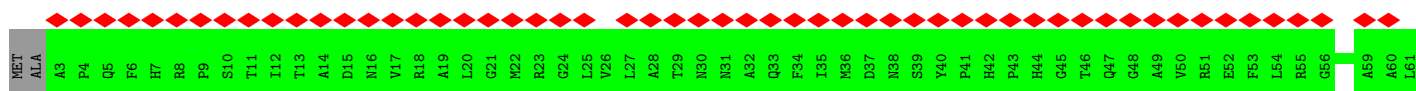
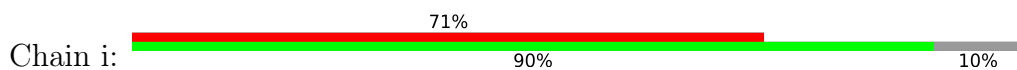

• Molecule 4: VP26

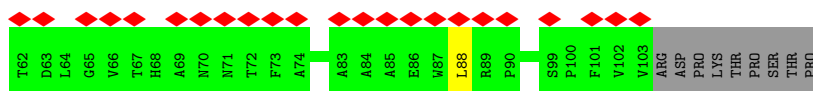
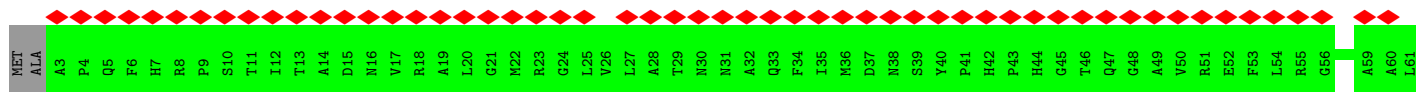
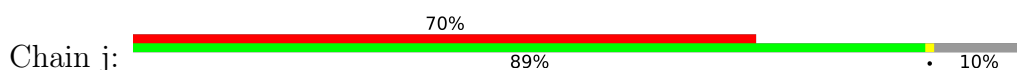

• Molecule 4: VP26

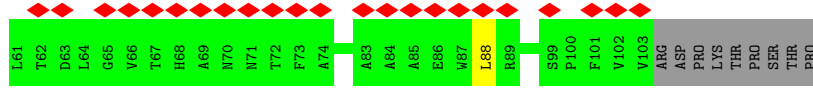
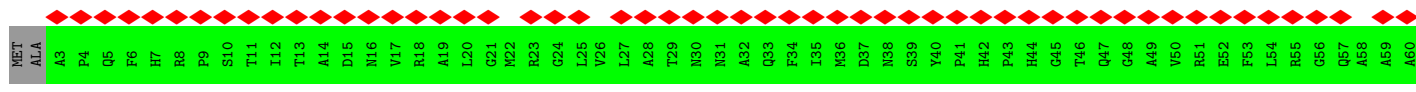
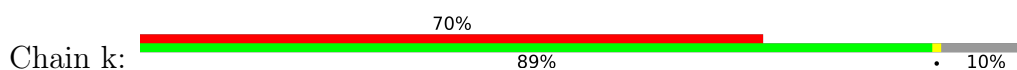

• Molecule 4: VP26

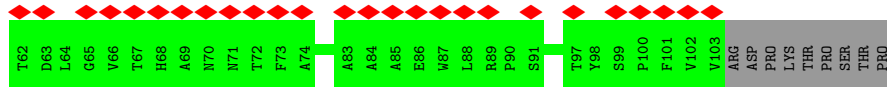
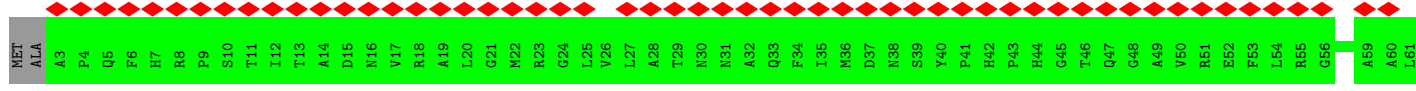
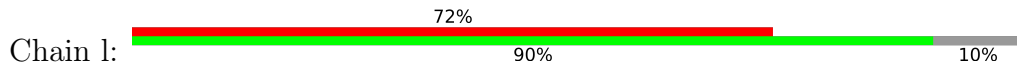

• Molecule 4: VP26

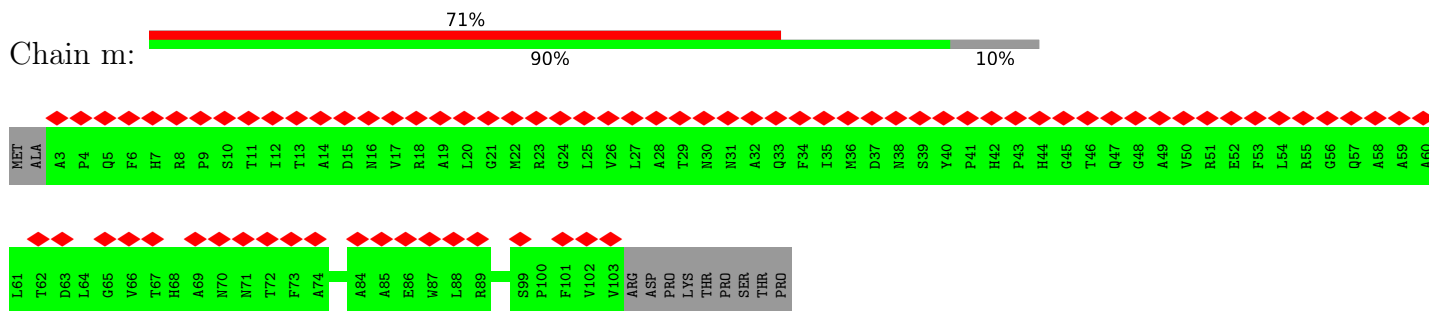

• Molecule 4: VP26

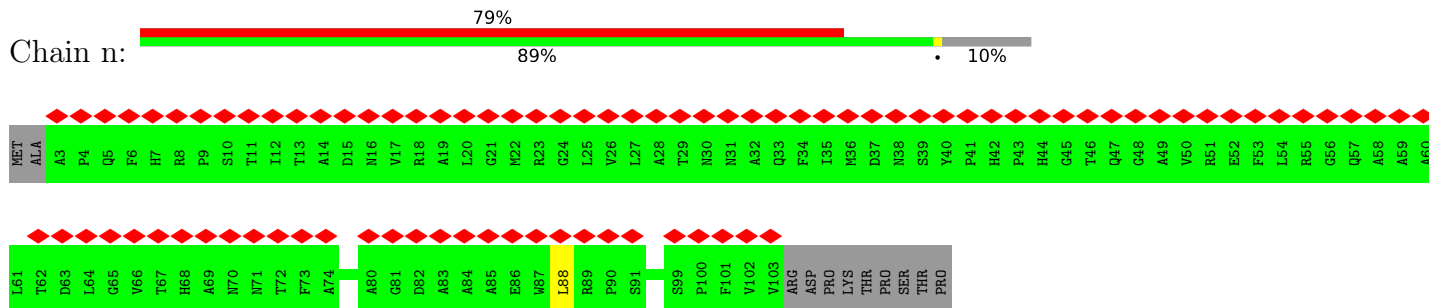

• Molecule 4: VP26

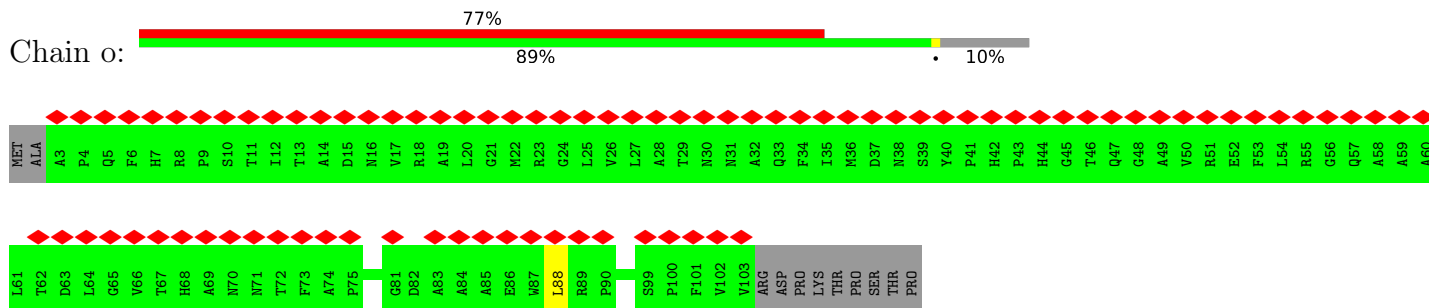

• Molecule 4: VP26

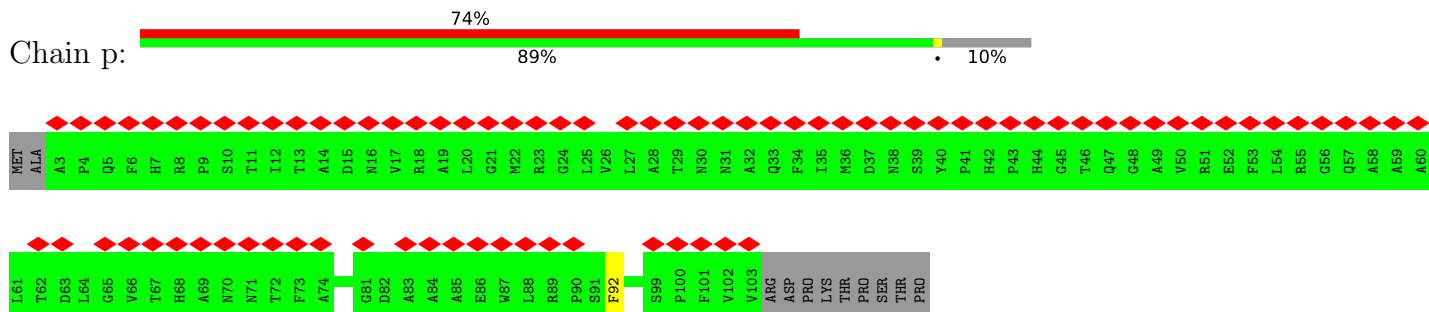

• Molecule 4: VP26

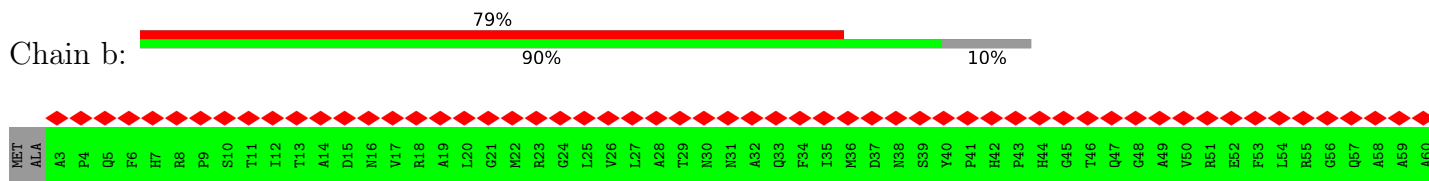

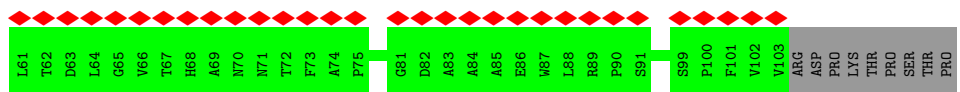

• Molecule 4: VP26

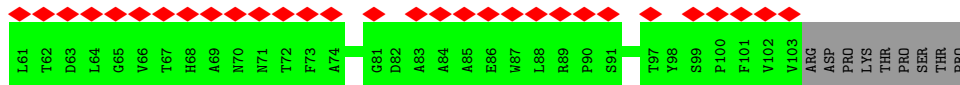
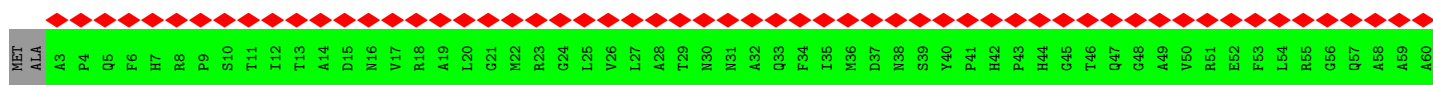
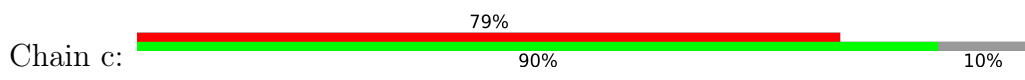

• Molecule 4: VP26

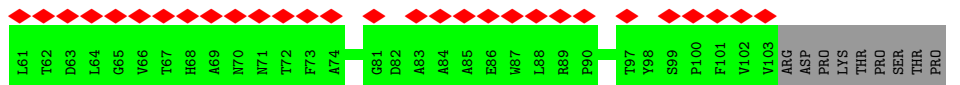
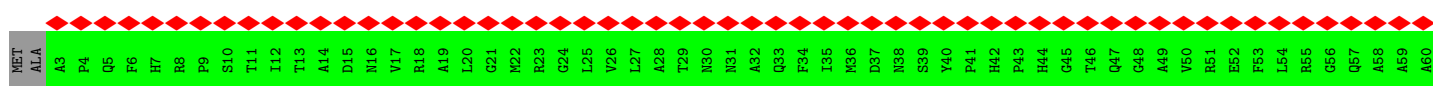
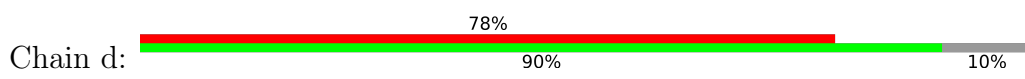

• Molecule 4: VP26

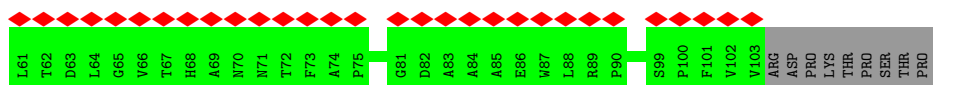
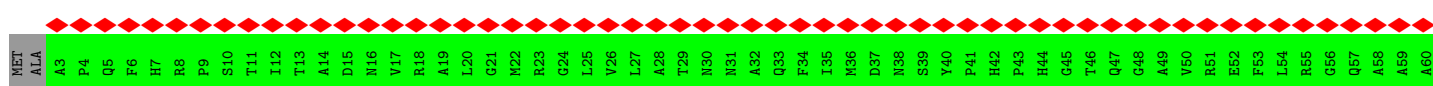
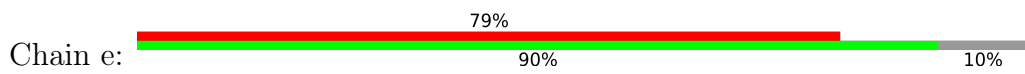

• Molecule 4: VP26

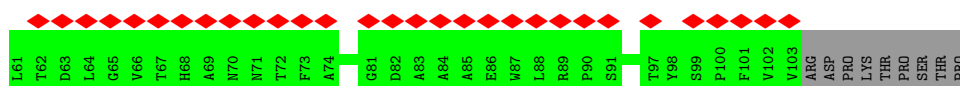
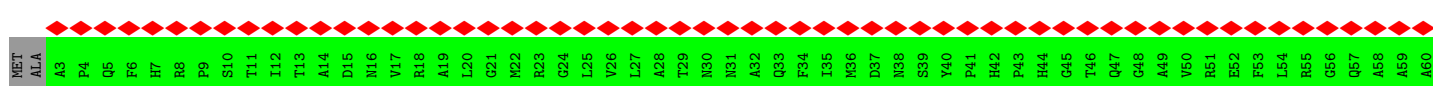
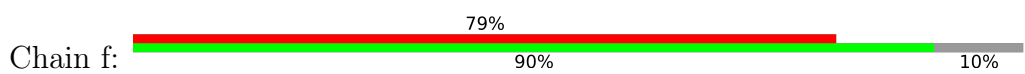

• Molecule 4: VP26

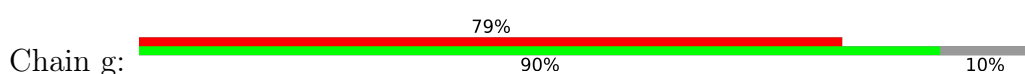

















THR  
LEU  
HIS  
ILE  
SER  
SER  
ASP  
GLU  
HIS  
SER  
ASP  
ALA  
ASP  
SER  
LEU  
ARG  
PHE  
SER  
SER  
SER  
ASP  
THR  
GLU  
ALA  
LEU  
ASP  
PRO  
LEU  
PRO  
PRO  
GLU  
PRO  
HIS  
LEU  
PRO  
PRO  
ALA  
ASP  
GLU  
PRO  
PRO  
GLY  
PRO  
LEU  
ALA  
ALA  
ASP  
HIS  
LEU  
GLN  
SER  
PRO  
HIS  
SER  
GLN  
PHE  
GLY  
PRO

LEU  
PRO  
VAL  
GLN  
ALA  
ASN  
ALA  
VAL  
LEU  
SER  
ARG  
ARG  
TYR  
VAL  
R3076  
S3076  
T3077  
L3121  
GLY



## 4 Experimental information

Property	Value	Source
EM reconstruction method	SINGLE PARTICLE	Depositor
Imposed symmetry	POINT, C1	Depositor
Number of particles used	56901	Depositor
Resolution determination method	FSC 0.143 CUT-OFF	Depositor
CTF correction method	NONE	Depositor
Microscope	FEI TITAN KRIOS	Depositor
Voltage (kV)	300	Depositor
Electron dose ( $e^-/\text{\AA}^2$ )	30	Depositor
Minimum defocus (nm)	Not provided	
Maximum defocus (nm)	Not provided	
Magnification	Not provided	
Image detector	GATAN K2 QUANTUM (4k x 4k)	Depositor
Maximum map value	16.874	Depositor
Minimum map value	-9.664	Depositor
Average map value	0.008	Depositor
Map value standard deviation	0.739	Depositor
Recommended contour level	1	Depositor
Map size ( $\text{\AA}$ )	1656.0, 1656.0, 1656.0	wwPDB
Map dimensions	1200, 1200, 1200	wwPDB
Map angles ( $^\circ$ )	90.0, 90.0, 90.0	wwPDB
Pixel spacing ( $\text{\AA}$ )	1.38, 1.38, 1.38	Depositor

## 5 Model quality

### 5.1 Standard geometry

The Z score for a bond length (or angle) is the number of standard deviations the observed value is removed from the expected value. A bond length (or angle) with  $|Z| > 5$  is considered an outlier worth inspection. RMSZ is the root-mean-square of all Z scores of the bond lengths (or angles).

Mol	Chain	Bond lengths		Bond angles	
		RMSZ	# Z  >5	RMSZ	# Z  >5
1	1	0.42	0/2641	0.58	1/3594 (0.0%)
1	Q	0.34	0/2641	0.54	1/3594 (0.0%)
1	T	0.34	0/2647	0.56	1/3601 (0.0%)
1	W	0.34	0/2629	0.55	1/3579 (0.0%)
1	w	0.31	0/2647	0.53	1/3601 (0.0%)
2	2	0.52	0/2374	0.68	0/3247
2	3	0.48	0/2134	0.68	1/2921 (0.0%)
2	R	0.33	0/2134	0.61	2/2921 (0.1%)
2	S	0.33	0/2377	0.59	1/3251 (0.0%)
2	U	0.37	0/2134	0.65	3/2921 (0.1%)
2	V	0.35	0/2377	0.61	2/3251 (0.1%)
2	X	0.43	0/2134	0.67	2/2921 (0.1%)
2	Y	0.42	0/2377	0.63	1/3251 (0.0%)
2	x	0.35	0/2134	0.62	2/2921 (0.1%)
2	y	0.35	0/2368	0.59	2/3240 (0.1%)
3	A	0.46	1/9879 (0.0%)	0.54	0/13481
3	B	0.72	2/10603 (0.0%)	0.66	2/14473 (0.0%)
3	C	0.72	1/10610 (0.0%)	0.67	3/14483 (0.0%)
3	D	0.71	0/10672	0.69	8/14569 (0.1%)
3	E	0.73	2/10663 (0.0%)	0.71	3/14556 (0.0%)
3	F	0.71	1/10649 (0.0%)	0.69	1/14539 (0.0%)
3	G	0.41	0/10514	0.64	9/14356 (0.1%)
3	H	0.55	0/10674	0.62	3/14570 (0.0%)
3	I	0.58	1/10676 (0.0%)	0.64	5/14572 (0.0%)
3	J	0.58	0/10668	0.63	1/14567 (0.0%)
3	K	0.57	0/10674	0.63	3/14574 (0.0%)
3	L	0.59	1/10680 (0.0%)	0.62	1/14577 (0.0%)
3	M	0.53	0/10709	0.61	0/14619
3	N	0.54	0/10654	0.60	1/14544 (0.0%)
3	O	0.53	1/10676 (0.0%)	0.59	0/14577
3	P	0.61	3/10667 (0.0%)	0.63	1/14565 (0.0%)
4	b	0.31	0/795	0.48	0/1084
4	c	0.31	0/795	0.48	0/1084
4	d	0.31	0/795	0.48	0/1084

Mol	Chain	Bond lengths		Bond angles	
		RMSZ	# Z  >5	RMSZ	# Z  >5
4	e	0.31	0/795	0.48	0/1084
4	f	0.31	0/795	0.48	0/1084
4	g	0.31	0/795	0.48	0/1084
4	h	0.29	0/795	0.52	0/1084
4	i	0.30	0/795	0.51	0/1084
4	j	0.29	0/795	0.53	1/1084 (0.1%)
4	k	0.29	0/795	0.52	1/1084 (0.1%)
4	l	0.31	0/795	0.54	0/1084
4	m	0.30	0/795	0.55	0/1084
4	n	0.28	0/795	0.50	1/1084 (0.1%)
4	o	0.29	0/795	0.51	1/1084 (0.1%)
4	p	0.30	0/795	0.51	0/1084
5	q	0.32	0/4350	0.48	0/5934
6	r	0.27	0/786	0.43	0/1074
6	s	0.30	0/667	0.44	0/908
7	t	0.23	0/385	0.38	0/514
7	u	0.26	0/385	0.40	0/514
All	All	0.55	13/223914 (0.0%)	0.62	66/305640 (0.0%)

Chiral center outliers are detected by calculating the chiral volume of a chiral center and verifying if the center is modelled as a planar moiety or with the opposite hand. A planarity outlier is detected by checking planarity of atoms in a peptide group, atoms in a mainchain group or atoms of a sidechain that are expected to be planar.

Mol	Chain	#Chirality outliers	#Planarity outliers
1	1	0	2
1	Q	0	3
1	T	0	2
1	W	0	2
1	w	0	2
2	2	0	1
2	S	0	1
2	U	0	1
2	V	0	1
2	X	0	1
2	Y	0	1
2	y	0	1
3	A	0	1
3	B	0	3
3	C	0	3
3	D	0	2
3	E	0	3

*Continued on next page...*



*Continued from previous page...*

Mol	Chain	#Chirality outliers	#Planarity outliers
3	F	0	4
3	G	0	1
3	H	0	1
3	I	0	4
3	J	0	3
3	K	0	3
3	L	0	2
3	M	0	2
3	N	0	5
3	O	0	1
3	P	0	2
4	h	0	1
4	p	0	1
5	q	0	2
All	All	0	62

The worst 5 of 13 bond length outliers are listed below:

Mol	Chain	Res	Type	Atoms	Z	Observed(Å)	Ideal(Å)
3	B	485	ASN	C-N	-21.55	0.93	1.34
3	C	485	ASN	C-N	-19.15	0.97	1.34
3	P	485	ASN	C-N	-18.89	0.98	1.34
3	L	485	ASN	C-N	-18.76	0.98	1.34
3	F	1116	ARG	C-N	-9.69	1.11	1.34

The worst 5 of 66 bond angle outliers are listed below:

Mol	Chain	Res	Type	Atoms	Z	Observed(°)	Ideal(°)
2	R	228	LEU	CA-CB-CG	9.51	137.16	115.30
3	D	43	ARG	N-CA-C	-8.90	86.97	111.00
3	K	1237	PRO	CA-N-CD	-8.51	99.59	111.50
2	U	228	LEU	CA-CB-CG	8.46	134.76	115.30
3	G	802	PRO	CA-N-CD	-8.27	99.93	111.50

There are no chirality outliers.

5 of 62 planarity outliers are listed below:

Mol	Chain	Res	Type	Group
1	Q	40	PRO	Peptide
1	Q	7	PRO	Peptide
1	Q	80	ARG	Peptide

*Continued on next page...*

*Continued from previous page...*

Mol	Chain	Res	Type	Group
2	S	241	LEU	Peptide
1	T	40	PRO	Peptide

## 5.2 Too-close contacts [i](#)

Due to software issues we are unable to calculate clashes - this section is therefore empty.

## 5.3 Torsion angles [i](#)

### 5.3.1 Protein backbone [i](#)

In the following table, the Percentiles column shows the percent Ramachandran outliers of the chain as a percentile score with respect to all PDB entries followed by that with respect to all EM entries.

The Analysed column shows the number of residues for which the backbone conformation was analysed, and the total number of residues.

Mol	Chain	Analysed	Favoured	Allowed	Outliers	Percentiles	
1	1	338/466 (72%)	314 (93%)	23 (7%)	1 (0%)	37	68
1	Q	338/466 (72%)	315 (93%)	22 (6%)	1 (0%)	37	68
1	T	338/466 (72%)	311 (92%)	26 (8%)	1 (0%)	37	68
1	W	338/466 (72%)	312 (92%)	25 (7%)	1 (0%)	37	68
1	w	338/466 (72%)	314 (93%)	23 (7%)	1 (0%)	37	68
2	2	304/318 (96%)	279 (92%)	23 (8%)	2 (1%)	19	52
2	3	272/318 (86%)	254 (93%)	18 (7%)	0	100	100
2	R	272/318 (86%)	252 (93%)	20 (7%)	0	100	100
2	S	304/318 (96%)	278 (91%)	26 (9%)	0	100	100
2	U	272/318 (86%)	248 (91%)	24 (9%)	0	100	100
2	V	304/318 (96%)	280 (92%)	22 (7%)	2 (1%)	19	52
2	X	272/318 (86%)	254 (93%)	18 (7%)	0	100	100
2	Y	304/318 (96%)	280 (92%)	23 (8%)	1 (0%)	37	68
2	x	272/318 (86%)	253 (93%)	19 (7%)	0	100	100
2	y	304/318 (96%)	282 (93%)	20 (7%)	2 (1%)	19	52
3	A	1243/1374 (90%)	1163 (94%)	79 (6%)	1 (0%)	48	79
3	B	1353/1374 (98%)	1264 (93%)	88 (6%)	1 (0%)	48	79

*Continued on next page...*

Continued from previous page...

Mol	Chain	Analysed	Favoured	Allowed	Outliers	Percentiles	
3	C	1348/1374 (98%)	1247 (92%)	99 (7%)	2 (0%)	48	79
3	D	1360/1374 (99%)	1262 (93%)	96 (7%)	2 (0%)	48	79
3	E	1358/1374 (99%)	1243 (92%)	112 (8%)	3 (0%)	44	73
3	F	1358/1374 (99%)	1254 (92%)	103 (8%)	1 (0%)	48	79
3	G	1342/1374 (98%)	1251 (93%)	89 (7%)	2 (0%)	48	79
3	H	1358/1374 (99%)	1254 (92%)	101 (7%)	3 (0%)	44	73
3	I	1358/1374 (99%)	1232 (91%)	122 (9%)	4 (0%)	37	68
3	J	1360/1374 (99%)	1246 (92%)	110 (8%)	4 (0%)	37	68
3	K	1360/1374 (99%)	1241 (91%)	115 (8%)	4 (0%)	37	68
3	L	1358/1374 (99%)	1245 (92%)	109 (8%)	4 (0%)	37	68
3	M	1362/1374 (99%)	1244 (91%)	117 (9%)	1 (0%)	48	79
3	N	1358/1374 (99%)	1240 (91%)	116 (8%)	2 (0%)	48	79
3	O	1362/1374 (99%)	1250 (92%)	108 (8%)	4 (0%)	37	68
3	P	1360/1374 (99%)	1231 (90%)	129 (10%)	0	100	100
4	b	99/112 (88%)	95 (96%)	4 (4%)	0	100	100
4	c	99/112 (88%)	95 (96%)	4 (4%)	0	100	100
4	d	99/112 (88%)	95 (96%)	4 (4%)	0	100	100
4	e	99/112 (88%)	95 (96%)	4 (4%)	0	100	100
4	f	99/112 (88%)	95 (96%)	4 (4%)	0	100	100
4	g	99/112 (88%)	95 (96%)	4 (4%)	0	100	100
4	h	99/112 (88%)	97 (98%)	2 (2%)	0	100	100
4	i	99/112 (88%)	95 (96%)	4 (4%)	0	100	100
4	j	99/112 (88%)	94 (95%)	5 (5%)	0	100	100
4	k	99/112 (88%)	98 (99%)	1 (1%)	0	100	100
4	l	99/112 (88%)	96 (97%)	3 (3%)	0	100	100
4	m	99/112 (88%)	95 (96%)	4 (4%)	0	100	100
4	n	99/112 (88%)	96 (97%)	3 (3%)	0	100	100
4	o	99/112 (88%)	97 (98%)	2 (2%)	0	100	100
4	p	99/112 (88%)	95 (96%)	4 (4%)	0	100	100
5	q	540/702 (77%)	515 (95%)	24 (4%)	1 (0%)	44	73
6	r	92/585 (16%)	84 (91%)	8 (9%)	0	100	100

Continued on next page...

Continued from previous page...

Mol	Chain	Analysed	Favoured	Allowed	Outliers	Percentiles	
6	s	78/585 (13%)	73 (94%)	5 (6%)	0	100	100
7	t	45/3122 (1%)	43 (96%)	2 (4%)	0	100	100
7	u	45/3122 (1%)	43 (96%)	2 (4%)	0	100	100
All	All	28453/37290 (76%)	26284 (92%)	2118 (7%)	51 (0%)	45	73

5 of 51 Ramachandran outliers are listed below:

Mol	Chain	Res	Type
1	1	7	PRO
1	w	7	PRO
3	I	485	ASN
1	Q	7	PRO
1	T	7	PRO

### 5.3.2 Protein sidechains [i](#)

In the following table, the Percentiles column shows the percent sidechain outliers of the chain as a percentile score with respect to all PDB entries followed by that with respect to all EM entries.

The Analysed column shows the number of residues for which the sidechain conformation was analysed, and the total number of residues.

Mol	Chain	Analysed	Rotameric	Outliers	Percentiles	
1	1	246/365 (67%)	245 (100%)	1 (0%)	89	93
1	Q	246/365 (67%)	246 (100%)	0	100	100
1	T	247/365 (68%)	247 (100%)	0	100	100
1	W	243/365 (67%)	243 (100%)	0	100	100
1	w	247/365 (68%)	247 (100%)	0	100	100
2	2	254/264 (96%)	252 (99%)	2 (1%)	79	85
2	3	214/264 (81%)	212 (99%)	2 (1%)	75	84
2	R	214/264 (81%)	213 (100%)	1 (0%)	86	92
2	S	255/264 (97%)	255 (100%)	0	100	100
2	U	214/264 (81%)	212 (99%)	2 (1%)	75	84
2	V	255/264 (97%)	254 (100%)	1 (0%)	89	93
2	X	214/264 (81%)	212 (99%)	2 (1%)	75	84
2	Y	255/264 (97%)	255 (100%)	0	100	100

Continued on next page...

*Continued from previous page...*

Mol	Chain	Analysed	Rotameric	Outliers	Percentiles	
2	x	214/264 (81%)	212 (99%)	2 (1%)	75	84
2	y	253/264 (96%)	252 (100%)	1 (0%)	89	93
3	A	997/1080 (92%)	996 (100%)	1 (0%)	92	96
3	B	1060/1080 (98%)	1059 (100%)	1 (0%)	92	96
3	C	1063/1080 (98%)	1062 (100%)	1 (0%)	92	96
3	D	1069/1080 (99%)	1068 (100%)	1 (0%)	92	96
3	E	1068/1080 (99%)	1068 (100%)	0	100	100
3	F	1066/1080 (99%)	1065 (100%)	1 (0%)	92	96
3	G	1053/1080 (98%)	1042 (99%)	11 (1%)	73	82
3	H	1070/1080 (99%)	1070 (100%)	0	100	100
3	I	1071/1080 (99%)	1071 (100%)	0	100	100
3	J	1069/1080 (99%)	1068 (100%)	1 (0%)	92	96
3	K	1070/1080 (99%)	1070 (100%)	0	100	100
3	L	1072/1080 (99%)	1071 (100%)	1 (0%)	92	96
3	M	1075/1080 (100%)	1075 (100%)	0	100	100
3	N	1066/1080 (99%)	1064 (100%)	2 (0%)	92	95
3	O	1067/1080 (99%)	1067 (100%)	0	100	100
3	P	1068/1080 (99%)	1068 (100%)	0	100	100
4	b	78/88 (89%)	78 (100%)	0	100	100
4	c	78/88 (89%)	78 (100%)	0	100	100
4	d	78/88 (89%)	78 (100%)	0	100	100
4	e	78/88 (89%)	78 (100%)	0	100	100
4	f	78/88 (89%)	78 (100%)	0	100	100
4	g	78/88 (89%)	78 (100%)	0	100	100
4	h	78/88 (89%)	78 (100%)	0	100	100
4	i	78/88 (89%)	78 (100%)	0	100	100
4	j	78/88 (89%)	78 (100%)	0	100	100
4	k	78/88 (89%)	78 (100%)	0	100	100
4	l	78/88 (89%)	78 (100%)	0	100	100
4	m	78/88 (89%)	78 (100%)	0	100	100
4	n	78/88 (89%)	78 (100%)	0	100	100

*Continued on next page...*

Continued from previous page...

Mol	Chain	Analysed	Rotameric	Outliers	Percentiles	
4	o	78/88 (89%)	78 (100%)	0	100	100
4	p	78/88 (89%)	78 (100%)	0	100	100
5	q	427/529 (81%)	427 (100%)	0	100	100
6	r	77/450 (17%)	77 (100%)	0	100	100
6	s	65/450 (14%)	65 (100%)	0	100	100
7	t	41/2370 (2%)	41 (100%)	0	100	100
7	u	41/2370 (2%)	41 (100%)	0	100	100
All	All	22396/29234 (77%)	22362 (100%)	34 (0%)	91	95

5 of 34 residues with a non-rotameric sidechain are listed below:

Mol	Chain	Res	Type
3	G	550	PHE
3	G	745	HIS
3	G	1197	ASN
2	x	228	LEU
2	x	116	LEU

Sometimes sidechains can be flipped to improve hydrogen bonding and reduce clashes. 5 of 473 such sidechains are listed below:

Mol	Chain	Res	Type
3	N	463	HIS
3	G	266	HIS
3	P	724	HIS
6	s	90	GLN
3	E	899	HIS

### 5.3.3 RNA [i](#)

There are no RNA molecules in this entry.

## 5.4 Non-standard residues in protein, DNA, RNA chains [i](#)

There are no non-standard protein/DNA/RNA residues in this entry.

## 5.5 Carbohydrates [i](#)

There are no oligosaccharides in this entry.

## 5.6 Ligand geometry [i](#)

There are no ligands in this entry.

## 5.7 Other polymers [i](#)

There are no such residues in this entry.

## 5.8 Polymer linkage issues [i](#)

The following chains have linkage breaks:

Mol	Chain	Number of breaks
3	E	1
3	F	1
3	L	1
3	P	1
3	C	1
3	B	1

The worst 5 of 6 chain breaks are listed below:

Model	Chain	Residue-1	Atom-1	Residue-2	Atom-2	Distance (Å)
1	E	1312:LYS	C	1313:ARG	N	1.16
1	F	1116:ARG	C	1117:ASN	N	1.11
1	L	485:ASN	C	486:PRO	N	0.98
1	P	485:ASN	C	486:PRO	N	0.98
1	C	485:ASN	C	486:PRO	N	0.97

## 6 Map visualisation [i](#)

This section contains visualisations of the EMDB entry EMD-6976. These allow visual inspection of the internal detail of the map and identification of artifacts.

No raw map or half-maps were deposited for this entry and therefore no images, graphs, etc. pertaining to the raw map can be shown.

### 6.1 Orthogonal projections [i](#)

#### 6.1.1 Primary map

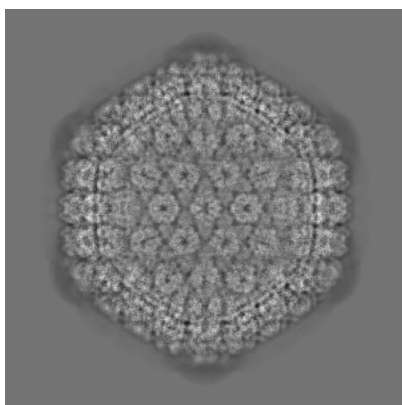

X

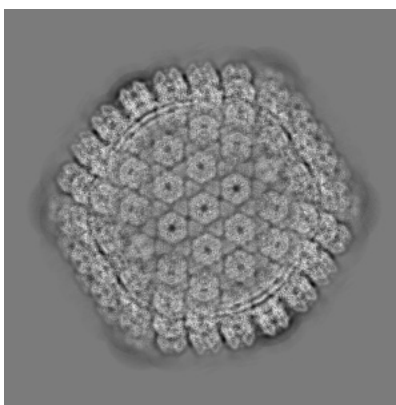

Y

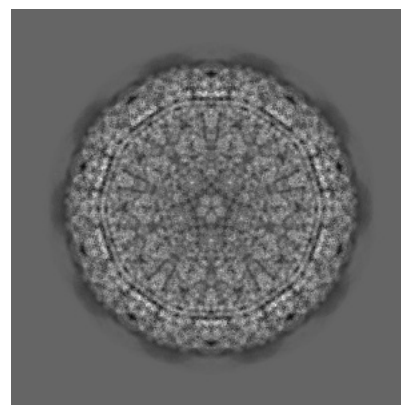

Z

The images above show the map projected in three orthogonal directions.

### 6.2 Central slices [i](#)

#### 6.2.1 Primary map



X Index: 600

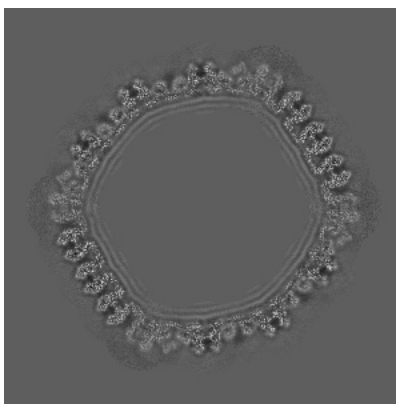

Y Index: 600

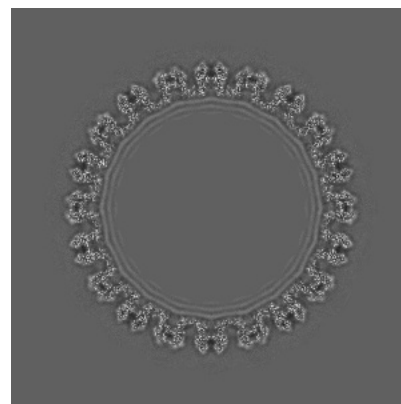

Z Index: 600



The images above show central slices of the map in three orthogonal directions.

## 6.3 Largest variance slices [i](#)

### 6.3.1 Primary map

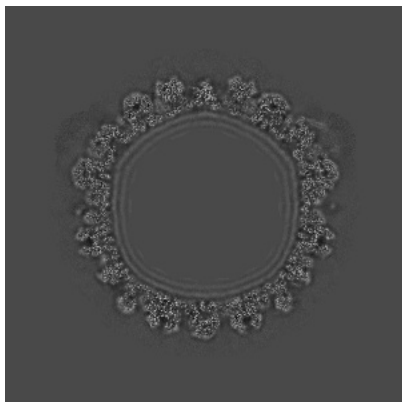

X Index: 775

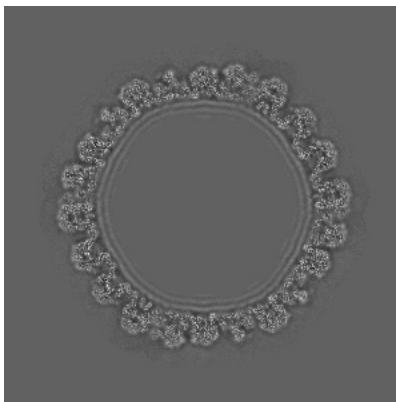

Y Index: 502

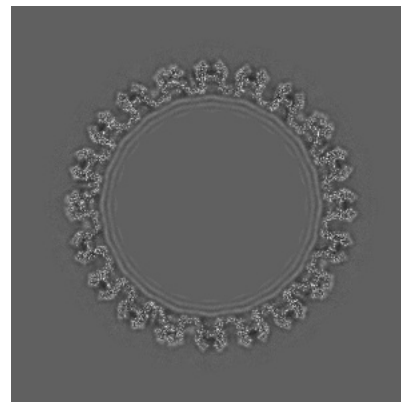

Z Index: 595

The images above show the largest variance slices of the map in three orthogonal directions.

## 6.4 Orthogonal standard-deviation projections (False-color) [i](#)

### 6.4.1 Primary map

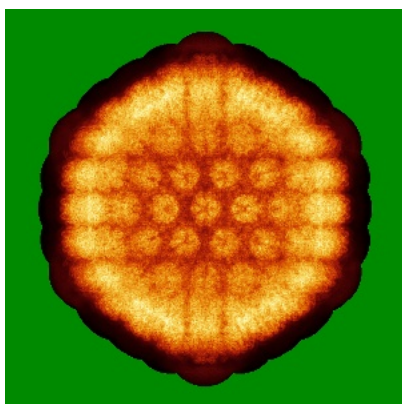

X

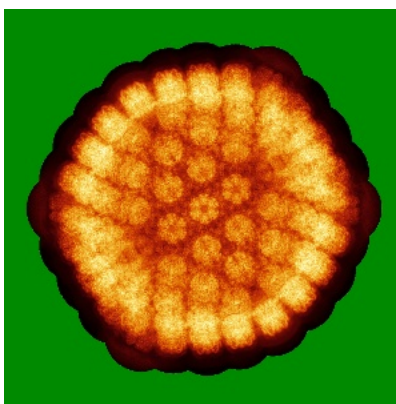

Y

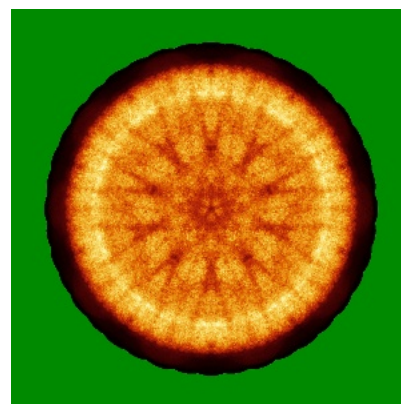

Z

The images above show the map standard deviation projections with false color in three orthogonal directions. Minimum values are shown in green, max in blue, and dark to light orange shades represent small to large values respectively.

## 6.5 Orthogonal surface views [i](#)

### 6.5.1 Primary map



X



Y



Z

The images above show the 3D surface view of the map at the recommended contour level 1.0. These images, in conjunction with the slice images, may facilitate assessment of whether an appropriate contour level has been provided.

## 6.6 Mask visualisation [i](#)

This section was not generated. No masks/segmentation were deposited.

## 7 Map analysis [i](#)

This section contains the results of statistical analysis of the map.

### 7.1 Map-value distribution [i](#)

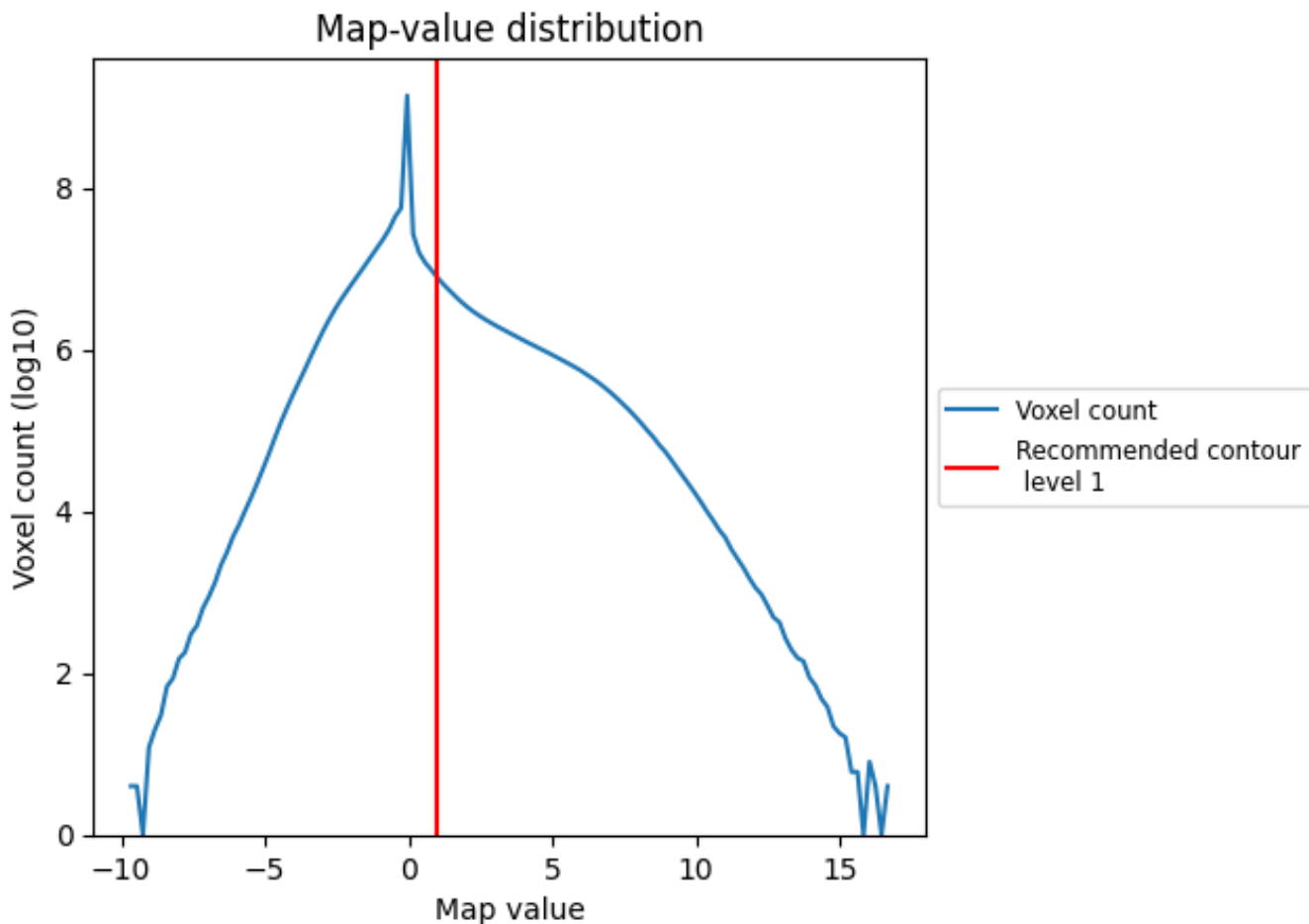

The map-value distribution is plotted in 128 intervals along the x-axis. The y-axis is logarithmic. A spike in this graph at zero usually indicates that the volume has been masked.

## 7.2 Volume estimate [\(i\)](#)

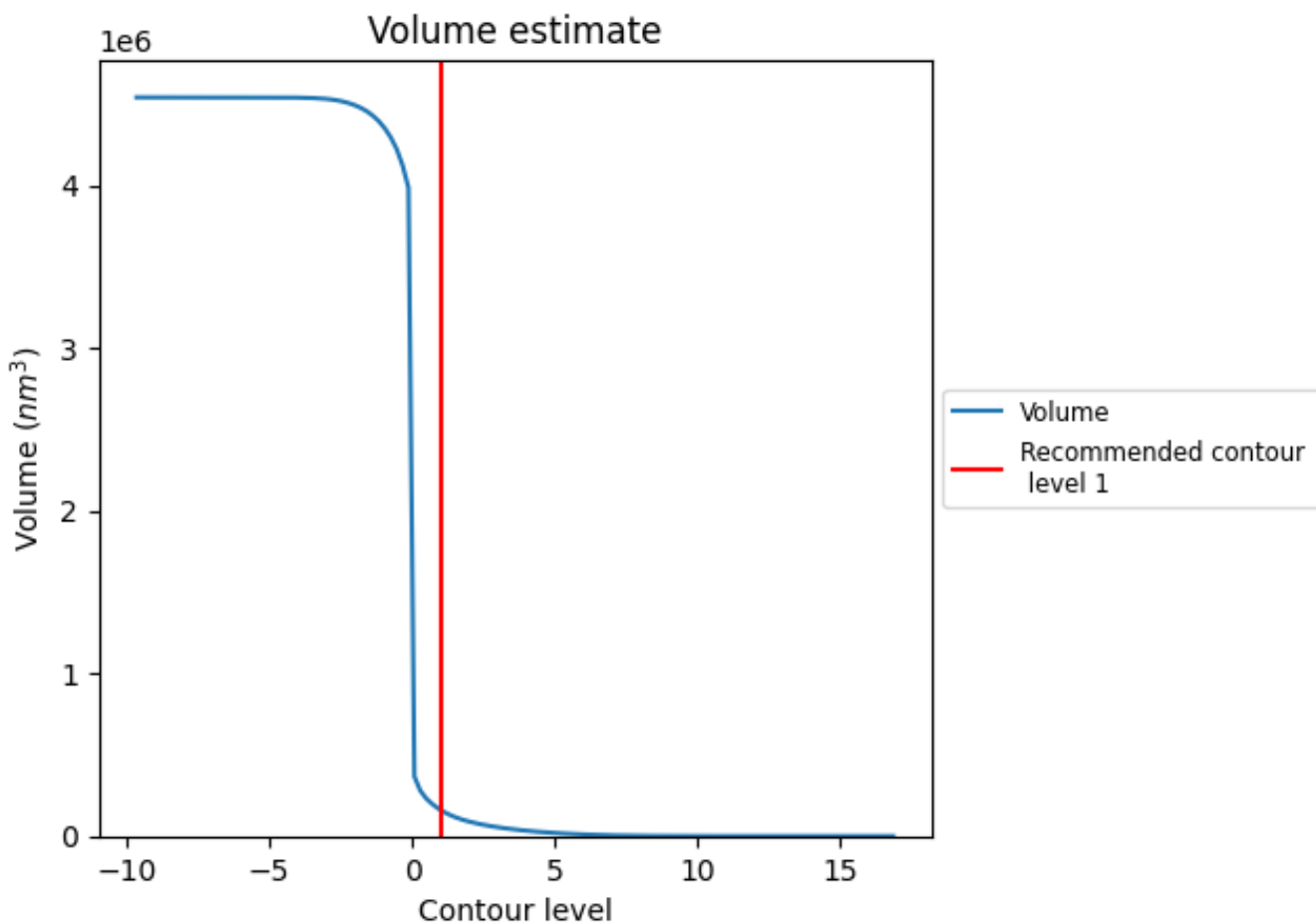

The volume at the recommended contour level is 160951 nm<sup>3</sup>; this corresponds to an approximate mass of 145391 kDa.

The volume estimate graph shows how the enclosed volume varies with the contour level. The recommended contour level is shown as a vertical line and the intersection between the line and the curve gives the volume of the enclosed surface at the given level.

### 7.3 Rotationally averaged power spectrum i

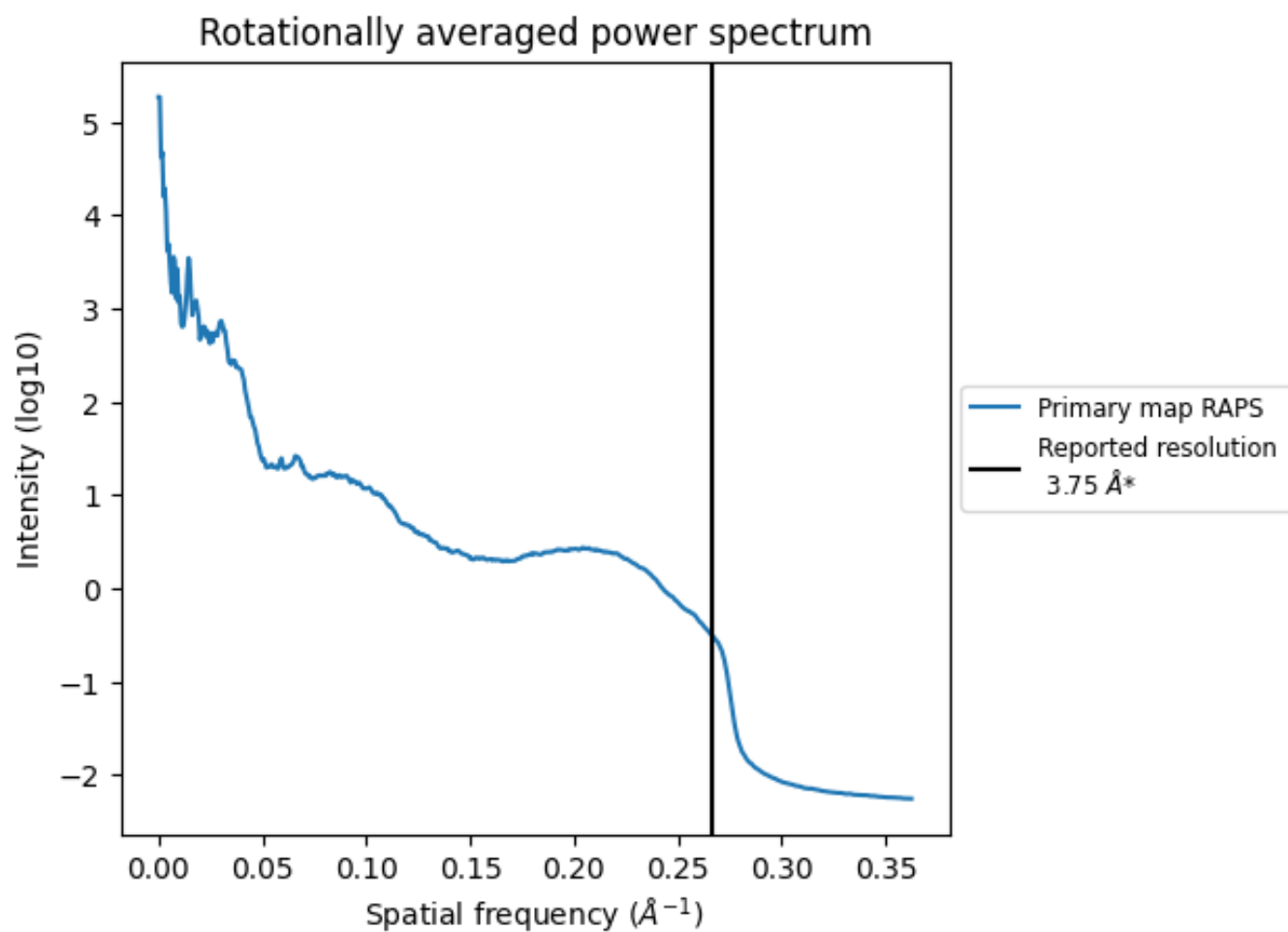

\*Reported resolution corresponds to spatial frequency of 0.267 Å<sup>-1</sup>

## 8 Fourier-Shell correlation

This section was not generated. No FSC curve or half-maps provided.

## 9 Map-model fit [i](#)

This section contains information regarding the fit between EMDB map EMD-6976 and PDB model 5ZZ8. Per-residue inclusion information can be found in section 3 on page 9.

### 9.1 Map-model overlays

#### 9.1.1 Map-model overlay [i](#)

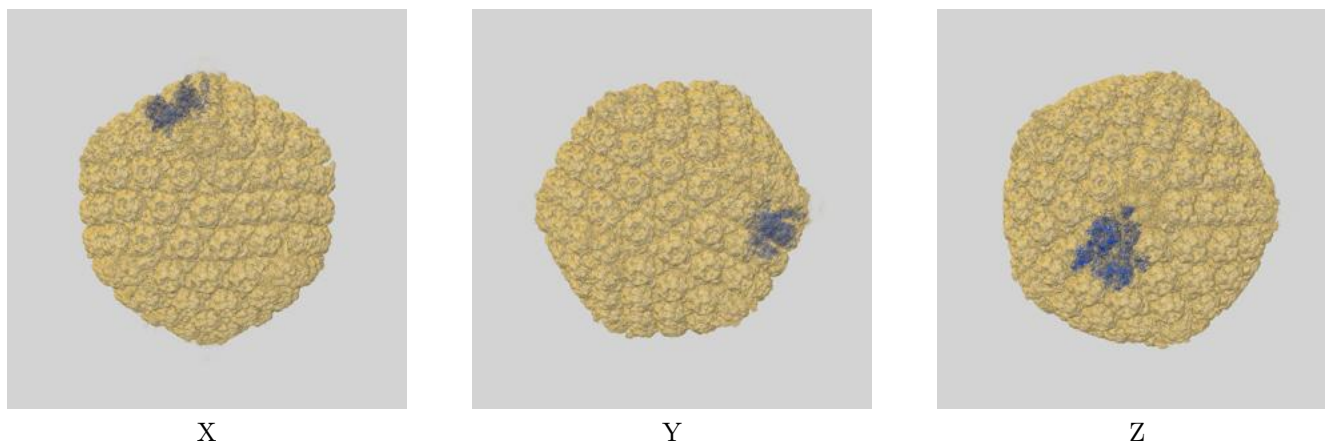

#### 9.1.2 Map-model assembly overlay [i](#)

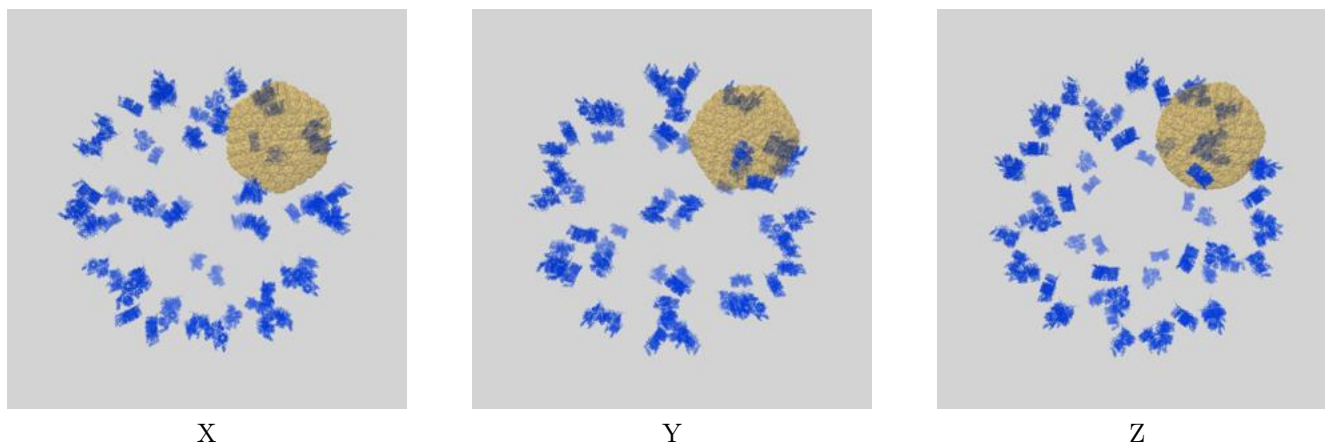

The images above show the 3D surface view of the map at the recommended contour level 1.0 at 50% transparency in yellow overlaid with a ribbon representation of the model coloured in blue. These images allow for the visual assessment of the quality of fit between the atomic model and the map.

## 9.2 Q-score mapped to coordinate model [i](#)

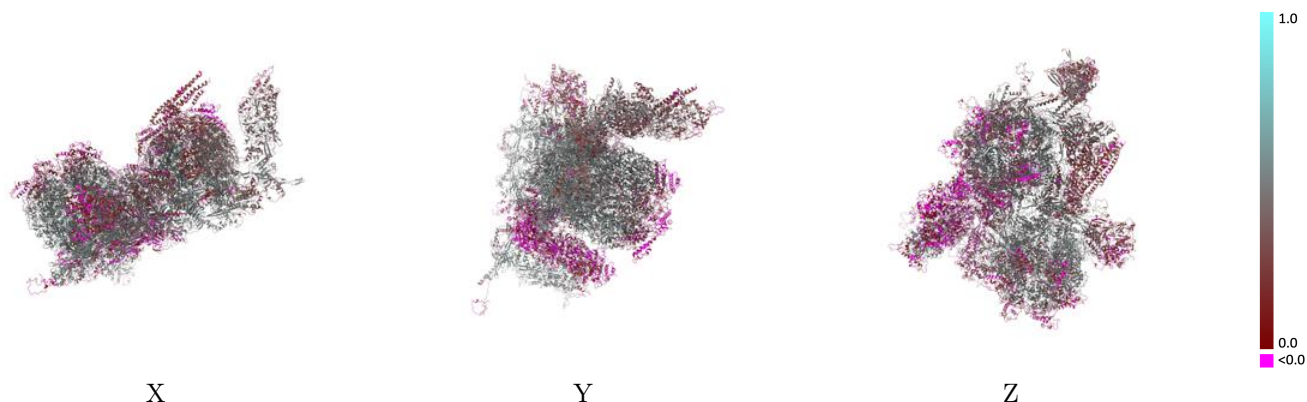

The images above show the model with each residue coloured according to its Q-score. This shows their resolvability in the map with higher Q-score values reflecting better resolvability. Please note: Q-score is calculating the resolvability of atoms, and thus high values are only expected at resolutions at which atoms can be resolved. Low Q-score values may therefore be expected for many entries.

## 9.3 Atom inclusion mapped to coordinate model [i](#)

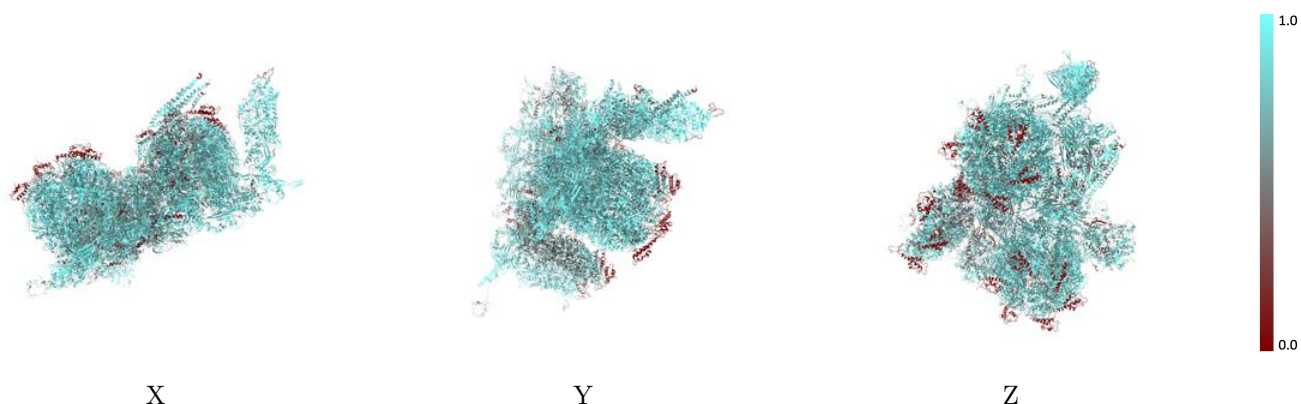

The images above show the model with each residue coloured according to its atom inclusion. This shows to what extent they are inside the map at the recommended contour level (1).





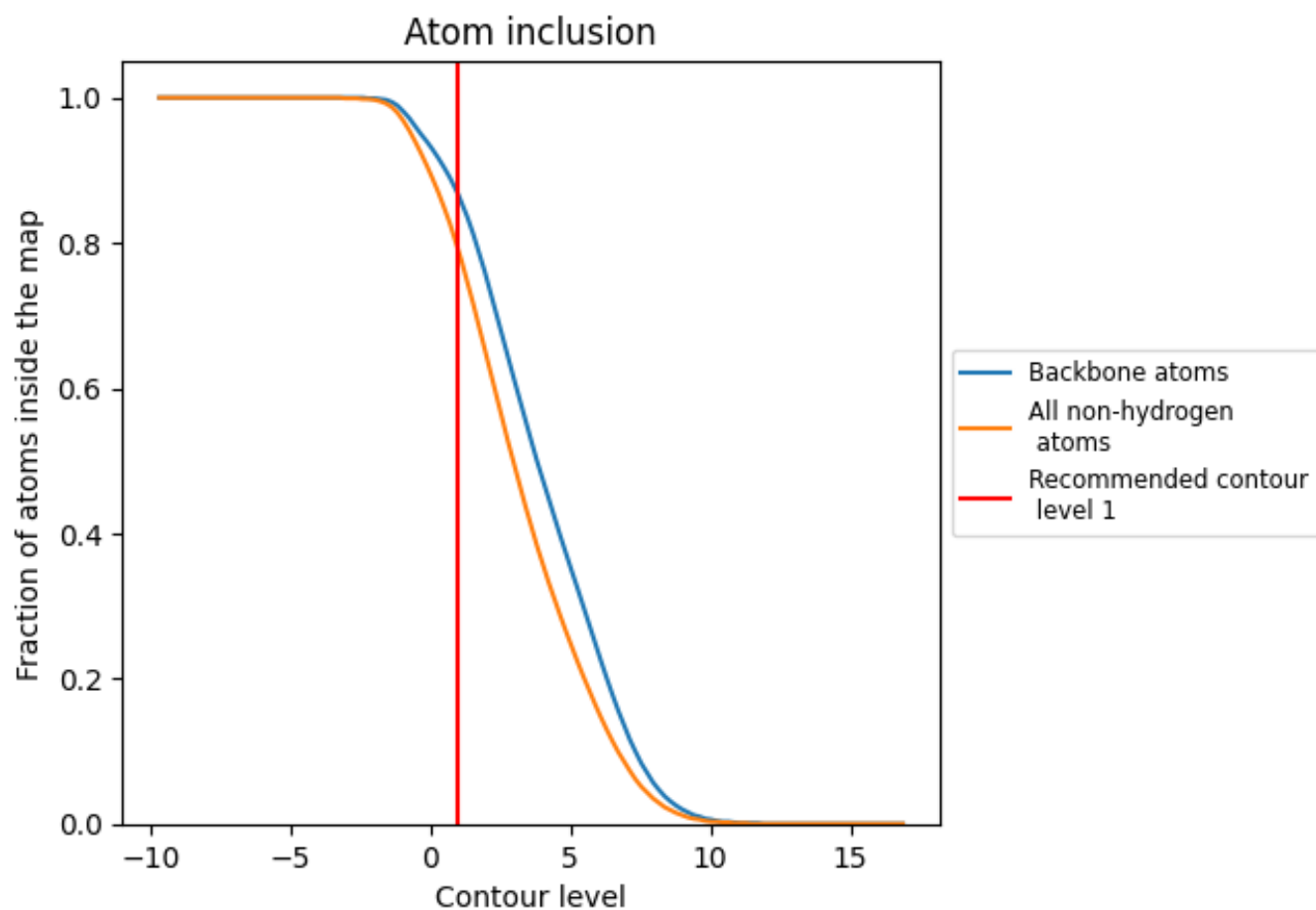



































































## 9.4 Atom inclusion [i](#)



At the recommended contour level, 87% of all backbone atoms, 79% of all non-hydrogen atoms, are inside the map.

## 9.5 Map-model fit summary



































The table lists the average atom inclusion at the recommended contour level (1) and Q-score for the entire model and for each chain.

Chain	Atom inclusion	Q-score
All	 0.7910	 0.3500
1	 0.6180	 0.1710
2	 0.7910	 0.3110
3	 0.8980	 0.4270
A	 0.8460	 0.3780
B	 0.8810	 0.4450
C	 0.9040	 0.4570
D	 0.8840	 0.4460
E	 0.8840	 0.4510
F	 0.8990	 0.4480
G	 0.8300	 0.3650
H	 0.8950	 0.4480
I	 0.8940	 0.4440
J	 0.8920	 0.4470
K	 0.8890	 0.4450
L	 0.8840	 0.4400
M	 0.9030	 0.4530
N	 0.6140	 0.0620
O	 0.6470	 0.0930
P	 0.8940	 0.4520
Q	 0.6400	 0.2530
R	 0.8020	 0.3460
S	 0.8050	 0.3830
T	 0.6450	 0.2260
U	 0.7140	 0.1450
V	 0.6880	 0.1630
W	 0.6000	 0.2500
X	 0.8970	 0.4290
Y	 0.8290	 0.3740
b	 0.1180	 0.0060
c	 0.1340	 -0.0140
d	 0.1380	 -0.0000
e	 0.1310	 -0.0240
f	 0.1310	 -0.0100
g	 0.1200	 0.0070



*Continued on next page...*

*Continued from previous page...*

Chain	Atom inclusion	Q-score
h	 0.1920	 0.0870
i	 0.2090	 0.0920
j	 0.2250	 0.1070
k	 0.2090	 0.0860
l	 0.1940	 0.1280
m	 0.2200	 0.1180
n	 0.1430	 -0.0060
o	 0.1570	 0.0230
p	 0.1790	 0.1130
q	 0.6840	 0.2560
r	 0.6540	 0.1910
s	 0.6770	 0.2030
t	 0.7300	 0.2140
u	 0.8600	 0.2120
w	 0.6040	 0.1840
x	 0.6980	 0.1760
y	 0.7180	 0.2490