



wwPDB EM Validation Summary Report ⓘ

Apr 13, 2023 – 05:11 am BST

PDB ID : 7Z49
EMDB ID : EMD-14488
Title : The capsid of bacteriophage SU10.
Authors : Siborova, M.; Fuzik, T.; Prochazkova, M.; Novacek, J.; Plevka, P.
Deposited on : 2022-03-03
Resolution : 4.20 Å(reported)

This is a wwPDB EM Validation Summary Report for a publicly released PDB entry.

We welcome your comments at validation@mail.wwpdb.org

A user guide is available at

<https://www.wwpdb.org/validation/2017/EMValidationReportHelp>

with specific help available everywhere you see the ⓘ symbol.

The types of validation reports are described at

<http://www.wwpdb.org/validation/2017/FAQs#types>.

The following versions of software and data (see [references ⓘ](#)) were used in the production of this report:

EMDB validation analysis : 0.0.1.dev50
MolProbity : 4.02b-467
Percentile statistics : 20191225.v01 (using entries in the PDB archive December 25th 2019)
MapQ : 1.9.9
Ideal geometry (proteins) : Engh & Huber (2001)
Ideal geometry (DNA, RNA) : Parkinson et al. (1996)
Validation Pipeline (wwPDB-VP) : 2.32.2

1 Overall quality at a glance i

The following experimental techniques were used to determine the structure:

ELECTRON MICROSCOPY

The reported resolution of this entry is 4.20 Å.

Percentile scores (ranging between 0-100) for global validation metrics of the entry are shown in the following graphic. The table shows the number of entries on which the scores are based.

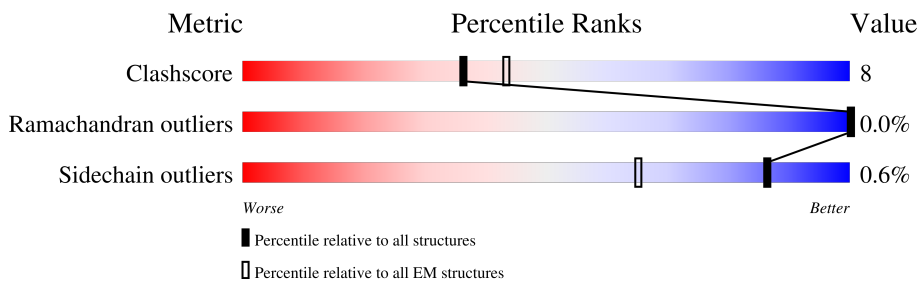

Metric	Whole archive (#Entries)	EM structures (#Entries)
Clashscore	158937	4297
Ramachandran outliers	154571	4023
Sidechain outliers	154315	3826

The table below summarises the geometric issues observed across the polymeric chains and their fit to the map. The red, orange, yellow and green segments of the bar indicate the fraction of residues that contain outliers for ≥ 3 , 2, 1 and 0 types of geometric quality criteria respectively. A grey segment represents the fraction of residues that are not modelled. The numeric value for each fraction is indicated below the corresponding segment, with a dot representing fractions $\leq 5\%$. The upper red bar (where present) indicates the fraction of residues that have poor fit to the EM map (all-atom inclusion $< 40\%$). The numeric value is given above the bar.

Mol	Chain	Length	Quality of chain
1	AA	352	<div style="display: flex; justify-content: space-between; align-items: center;"> 41% <div style="width: 100%; height: 15px; background: linear-gradient(to right, red 41%, orange 41%, yellow 86%, green 86%, grey 100%);"></div> 12% .. </div>
1	AB	352	<div style="display: flex; justify-content: space-between; align-items: center;"> 41% <div style="width: 100%; height: 15px; background: linear-gradient(to right, red 41%, orange 41%, yellow 88%, green 88%, grey 100%);"></div> 10% . </div>
1	AC	352	<div style="display: flex; justify-content: space-between; align-items: center;"> 42% <div style="width: 100%; height: 15px; background: linear-gradient(to right, red 42%, orange 42%, yellow 83%, green 83%, grey 100%);"></div> 14% . </div>
1	AD	352	<div style="display: flex; justify-content: space-between; align-items: center;"> 43% <div style="width: 100%; height: 15px; background: linear-gradient(to right, red 43%, orange 43%, yellow 87%, green 87%, grey 100%);"></div> 11% . </div>
1	AE	352	<div style="display: flex; justify-content: space-between; align-items: center;"> 45% <div style="width: 100%; height: 15px; background: linear-gradient(to right, red 45%, orange 45%, yellow 87%, green 87%, grey 100%);"></div> 11% . </div>
1	AF	352	<div style="display: flex; justify-content: space-between; align-items: center;"> 41% <div style="width: 100%; height: 15px; background: linear-gradient(to right, red 41%, orange 41%, yellow 86%, green 86%, grey 100%);"></div> 12% . </div>
1	AG	352	<div style="display: flex; justify-content: space-between; align-items: center;"> 38% <div style="width: 100%; height: 15px; background: linear-gradient(to right, red 38%, orange 38%, yellow 86%, green 86%, grey 100%);"></div> 13% .. </div>
1	AH	352	<div style="display: flex; justify-content: space-between; align-items: center;"> 43% <div style="width: 100%; height: 15px; background: linear-gradient(to right, red 43%, orange 43%, yellow 89%, green 89%, grey 100%);"></div> 10% . </div>

Continued on next page...

Continued from previous page...

Mol	Chain	Length	Quality of chain
1	AI	352	42% 89% 9%
1	AJ	352	38% 88% 10%
1	AK	352	39% 81% 17%
1	AL	352	40% 90% 9%
1	AM	352	39% 76% 21%
1	AN	352	43% 87% 11%
1	AO	352	39% 84% 14%
1	AP	352	40% 72% 26%
1	AQ	352	44% 86% 13%
1	AR	352	45% 86% 12%
1	AS	352	40% 80% 18%
1	AT	352	45% 87% 11%
1	AU	352	43% 86% 12%
1	AV	352	40% 86% 13%
1	AW	352	40% 82% 17%
1	AX	352	40% 88% 10%
1	AY	352	36% 87% 11%
1	AZ	352	31% 88% 11%
1	BA	352	39% 83% 15%
1	BB	352	36% 86% 12%
1	BC	352	32% 88% 11%
1	BD	352	30% 88% 11%
1	BE	352	41% 85% 14%
1	BF	352	35% 86% 13%
1	BG	352	36% 89% 9%

Continued on next page...

Continued from previous page...

Mol	Chain	Length	Quality of chain
1	BH	352	41% 88% 10%
1	BI	352	21% 72% 26%
1	BJ	352	35% 89% 9%
1	BK	352	41% 78% 20%
1	BL	352	34% 86% 12%
1	BM	352	40% 83% 14%
1	BN	352	44% 78% 20%
1	BO	352	29% 86% 13%
1	BP	352	38% 85% 13%
1	BQ	352	43% 86% 13%
1	BR	352	32% 86% 12%
1	BS	352	33% 87% 11%
1	BT	352	38% 86% 12%
1	BU	352	31% 80% 19%
1	BV	352	29% 87% 11%
1	BW	352	22% 82% 16%
1	BX	352	29% 79% 20%
1	BY	352	25% 81% 17%
1	BZ	352	29% 84% 14%
1	CA	352	32% 80% 17%
1	CB	352	35% 84% 14%
1	CC	352	22% 86% 12%
1	CD	352	38% 82% 15%
1	CE	352	32% 80% 18%
1	CF	352	40% 84% 14%

Continued on next page...

Continued from previous page...

Mol	Chain	Length	Quality of chain
1	CG	352	41% 82% 16%
1	CH	352	36% 88% 10%
1	CI	352	24% 86% 12%
1	CJ	352	37% 87% 12%
1	CK	352	42% 83% 16%
1	CL	352	39% 79% 18%
1	CM	352	20% 85% 13%
1	CN	352	39% 78% 19%
1	CO	352	39% 81% 16%
1	CP	352	39% 84% 14%
1	CQ	352	30% 81% 17%
1	CR	352	36% 82% 16%
1	CS	352	38% 72% 26%
1	CT	352	36% 85% 13%
1	CU	352	37% 79% 19%
1	CV	352	32% 84% 15%
1	CW	352	41% 78% 20%
1	CX	352	38% 90% 9%
1	CY	352	32% 83% 16%
1	CZ	352	41% 77% 22%
1	DA	352	36% 82% 16%
1	DB	352	34% 82% 17%
1	DC	352	32% 84% 14%
1	DD	352	34% 72% 25%
1	DE	352	32% 84% 14%

Continued on next page...

Continued from previous page...

Mol	Chain	Length	Quality of chain
1	DF	352	
1	DG	352	
1	DH	352	
1	DI	352	
1	DJ	352	
1	DK	352	
1	DL	352	
1	DM	352	
1	DN	352	
1	DO	352	
1	DP	352	
1	DQ	352	

2 Entry composition [i](#)

There is only 1 type of molecule in this entry. The entry contains 254241 atoms, of which 0 are hydrogens and 0 are deuteriums.

In the tables below, the AltConf column contains the number of residues with at least one atom in alternate conformation and the Trace column contains the number of residues modelled with at most 2 atoms.

- Molecule 1 is a protein called Major head protein.

Mol	Chain	Residues	Atoms					AltConf	Trace
			Total	C	N	O	S		
1	AA	347	2685	1684	470	521	10	0	0
1	AB	347	2685	1684	470	521	10	0	0
1	AC	344	2663	1671	466	516	10	0	0
1	AD	347	2685	1684	470	521	10	0	0
1	AE	346	2677	1680	468	519	10	0	0
1	AF	346	2676	1678	468	520	10	0	0
1	AG	347	2685	1684	470	521	10	0	0
1	AH	347	2685	1684	470	521	10	0	0
1	AI	347	2685	1684	470	521	10	0	0
1	AJ	347	2685	1684	470	521	10	0	0
1	AK	347	2685	1684	470	521	10	0	0
1	AL	347	2685	1684	470	521	10	0	0
1	AM	344	2663	1671	466	516	10	0	0
1	AN	344	2663	1671	466	516	10	0	0
1	AO	344	2663	1671	466	516	10	0	0
1	AP	347	2685	1684	470	521	10	0	0
1	AQ	347	2685	1684	470	521	10	0	0

Continued on next page...

Continued from previous page...

Mol	Chain	Residues	Atoms					AltConf	Trace
			Total	C	N	O	S		
1	AR	347	2685	1684	470	521	10	0	0
1	AS	346	2677	1680	468	519	10	0	0
1	AT	346	2677	1680	468	519	10	0	0
1	AU	346	2677	1680	468	519	10	0	0
1	AV	346	2676	1678	468	520	10	0	0
1	AW	346	2676	1678	468	520	10	0	0
1	AX	346	2676	1678	468	520	10	0	0
1	AY	347	2685	1684	470	521	10	0	0
1	AZ	347	2685	1684	470	521	10	0	0
1	BA	344	2663	1671	466	516	10	0	0
1	BB	347	2685	1684	470	521	10	0	0
1	BC	346	2677	1680	468	519	10	0	0
1	BD	346	2676	1678	468	520	10	0	0
1	BE	347	2685	1684	470	521	10	0	0
1	BF	347	2685	1684	470	521	10	0	0
1	BG	347	2685	1684	470	521	10	0	0
1	BH	347	2685	1684	470	521	10	0	0
1	BI	347	2685	1684	470	521	10	0	0
1	BJ	347	2685	1684	470	521	10	0	0
1	BK	344	2663	1671	466	516	10	0	0
1	BL	344	2663	1671	466	516	10	0	0

Continued on next page...

Continued from previous page...

Mol	Chain	Residues	Atoms					AltConf	Trace
1	BM	344	Total	C	N	O	S	0	0
			2663	1671	466	516	10		
1	BN	347	Total	C	N	O	S	0	0
			2685	1684	470	521	10		
1	BO	347	Total	C	N	O	S	0	0
			2685	1684	470	521	10		
1	BP	347	Total	C	N	O	S	0	0
			2685	1684	470	521	10		
1	BQ	346	Total	C	N	O	S	0	0
			2677	1680	468	519	10		
1	BR	346	Total	C	N	O	S	0	0
			2677	1680	468	519	10		
1	BS	346	Total	C	N	O	S	0	0
			2677	1680	468	519	10		
1	BT	346	Total	C	N	O	S	0	0
			2676	1678	468	520	10		
1	BU	346	Total	C	N	O	S	0	0
			2676	1678	468	520	10		
1	BV	346	Total	C	N	O	S	0	0
			2676	1678	468	520	10		
1	BW	345	Total	C	N	O	S	0	0
			2672	1676	467	519	10		
1	BX	346	Total	C	N	O	S	0	0
			2677	1680	468	519	10		
1	BY	347	Total	C	N	O	S	0	0
			2685	1684	470	521	10		
1	BZ	345	Total	C	N	O	S	0	0
			2670	1675	467	518	10		
1	CA	346	Total	C	N	O	S	0	0
			2677	1680	468	519	10		
1	CB	346	Total	C	N	O	S	0	0
			2676	1678	468	520	10		
1	CC	347	Total	C	N	O	S	0	0
			2685	1684	470	521	10		
1	CD	343	Total	C	N	O	S	0	0
			2657	1668	465	514	10		
1	CE	346	Total	C	N	O	S	0	0
			2676	1678	468	520	10		
1	CF	342	Total	C	N	O	S	0	0
			2644	1656	464	514	10		
1	CG	347	Total	C	N	O	S	0	0
			2685	1684	470	521	10		

Continued on next page...

Continued from previous page...

Mol	Chain	Residues	Atoms					AltConf	Trace
1	CH	347	Total	C	N	O	S	0	0
			2685	1684	470	521	10		
1	CI	346	Total	C	N	O	S	0	0
			2676	1678	468	520	10		
1	CJ	347	Total	C	N	O	S	0	0
			2685	1684	470	521	10		
1	CK	347	Total	C	N	O	S	0	0
			2685	1684	470	521	10		
1	CL	343	Total	C	N	O	S	0	0
			2654	1665	464	515	10		
1	CM	346	Total	C	N	O	S	0	0
			2676	1678	468	520	10		
1	CN	342	Total	C	N	O	S	0	0
			2644	1656	464	514	10		
1	CO	341	Total	C	N	O	S	0	0
			2637	1651	463	513	10		
1	CP	345	Total	C	N	O	S	0	0
			2668	1674	466	518	10		
1	CQ	346	Total	C	N	O	S	0	0
			2676	1678	468	520	10		
1	CR	345	Total	C	N	O	S	0	0
			2670	1675	467	518	10		
1	CS	347	Total	C	N	O	S	0	0
			2685	1684	470	521	10		
1	CT	346	Total	C	N	O	S	0	0
			2677	1680	468	519	10		
1	CU	346	Total	C	N	O	S	0	0
			2676	1678	468	520	10		
1	CV	347	Total	C	N	O	S	0	0
			2685	1684	470	521	10		
1	CW	346	Total	C	N	O	S	0	0
			2677	1680	468	519	10		
1	CX	346	Total	C	N	O	S	0	0
			2676	1678	468	520	10		
1	CY	347	Total	C	N	O	S	0	0
			2685	1684	470	521	10		
1	CZ	347	Total	C	N	O	S	0	0
			2685	1684	470	521	10		
1	DA	346	Total	C	N	O	S	0	0
			2677	1680	468	519	10		
1	DB	347	Total	C	N	O	S	0	0
			2685	1684	470	521	10		

Continued on next page...

Continued from previous page...

Mol	Chain	Residues	Atoms					AltConf	Trace
1	DC	345	Total	C	N	O	S	0	0
			2670	1675	467	518	10		
1	DD	346	Total	C	N	O	S	0	0
			2677	1680	468	519	10		
1	DE	346	Total	C	N	O	S	0	0
			2676	1678	468	520	10		
1	DF	347	Total	C	N	O	S	0	0
			2685	1684	470	521	10		
1	DG	343	Total	C	N	O	S	0	0
			2657	1668	465	514	10		
1	DH	346	Total	C	N	O	S	0	0
			2676	1678	468	520	10		
1	DI	347	Total	C	N	O	S	0	0
			2685	1684	470	521	10		
1	DJ	346	Total	C	N	O	S	0	0
			2676	1678	468	520	10		
1	DK	343	Total	C	N	O	S	0	0
			2654	1665	464	515	10		
1	DL	346	Total	C	N	O	S	0	0
			2676	1678	468	520	10		
1	DM	345	Total	C	N	O	S	0	0
			2668	1674	466	518	10		
1	DN	346	Total	C	N	O	S	0	0
			2676	1678	468	520	10		
1	DO	346	Total	C	N	O	S	0	0
			2677	1680	468	519	10		
1	DP	346	Total	C	N	O	S	0	0
			2676	1678	468	520	10		
1	DQ	346	Total	C	N	O	S	0	0
			2676	1678	468	520	10		

3 Residue-property plots [i](#)

These plots are drawn for all protein, RNA, DNA and oligosaccharide chains in the entry. The first graphic for a chain summarises the proportions of the various outlier classes displayed in the second graphic. The second graphic shows the sequence view annotated by issues in geometry and atom inclusion in map density. Residues are color-coded according to the number of geometric quality criteria for which they contain at least one outlier: green = 0, yellow = 1, orange = 2 and red = 3 or more. A red diamond above a residue indicates a poor fit to the EM map for this residue (all-atom inclusion < 40%). Stretches of 2 or more consecutive residues without any outlier are shown as a green connector. Residues present in the sample, but not in the model, are shown in grey.

- Molecule 1: Major head protein

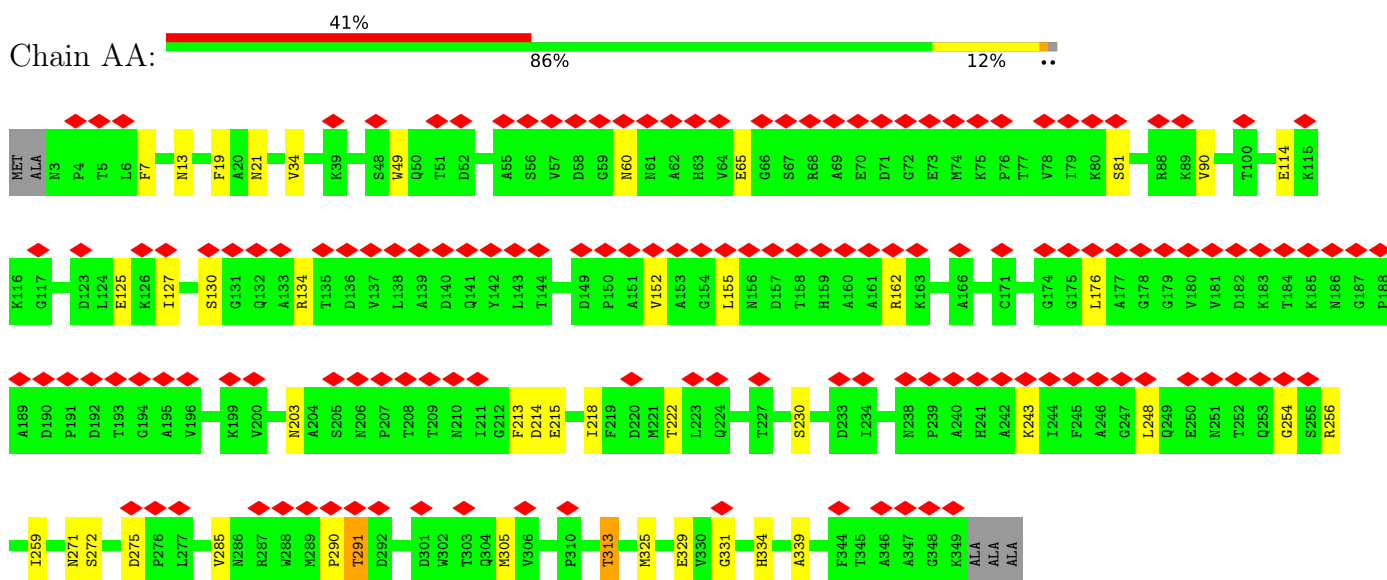

- Molecule 1: Major head protein

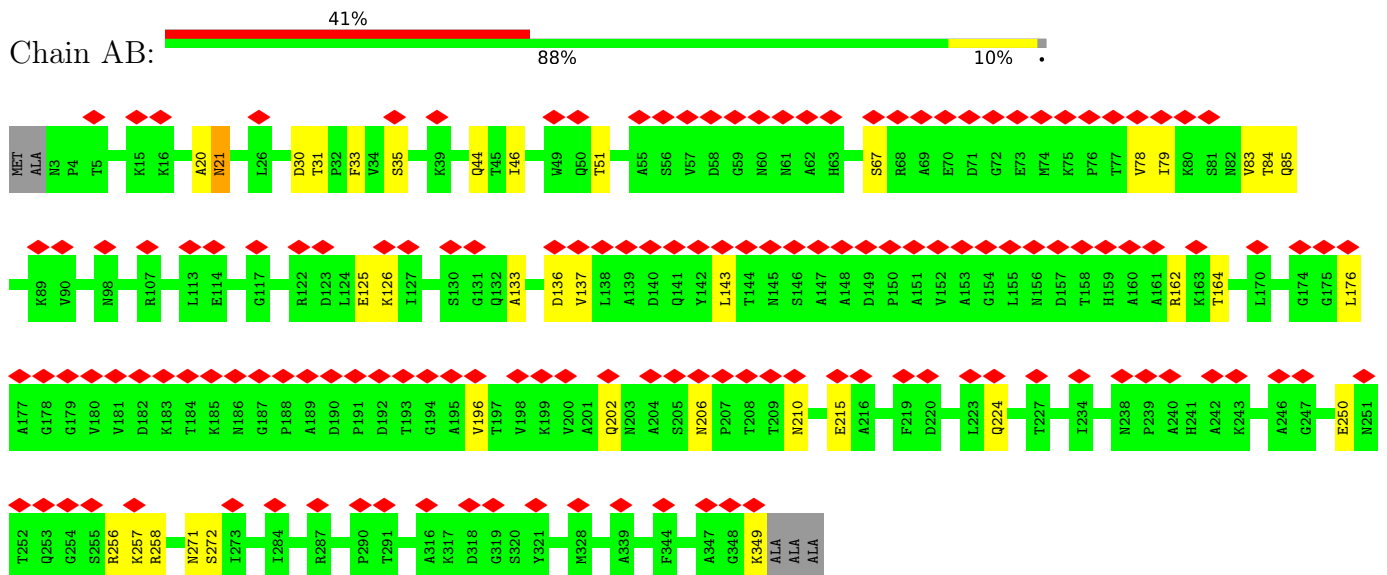

- Molecule 1: Major head protein

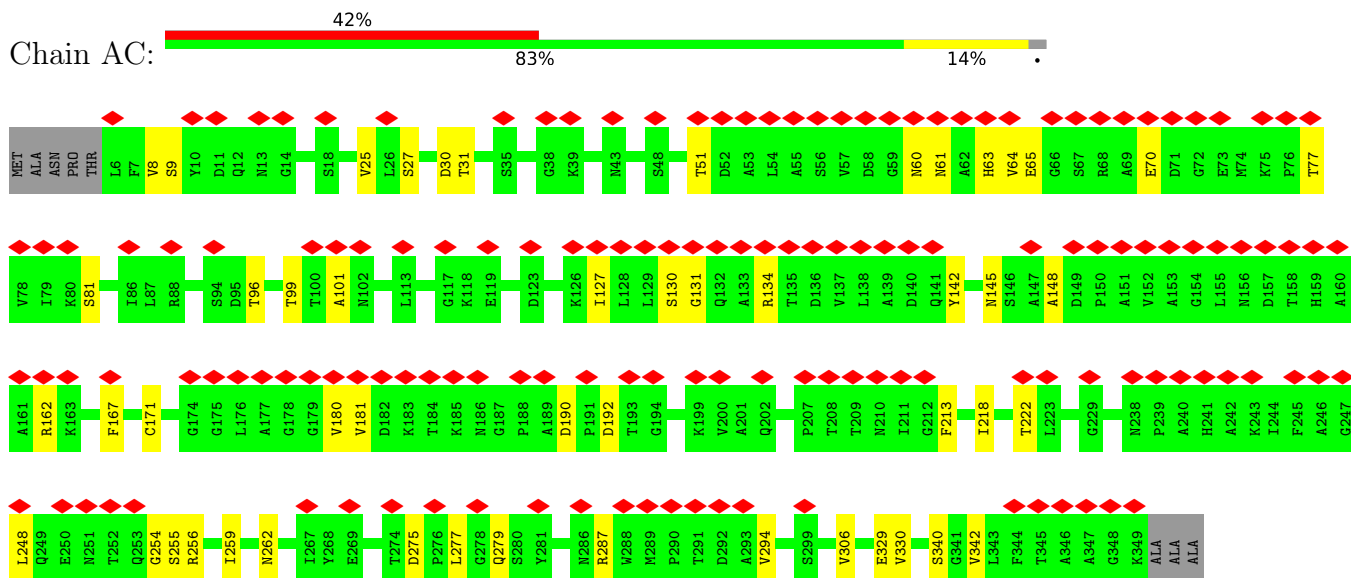

Molecule 1: Major head protein

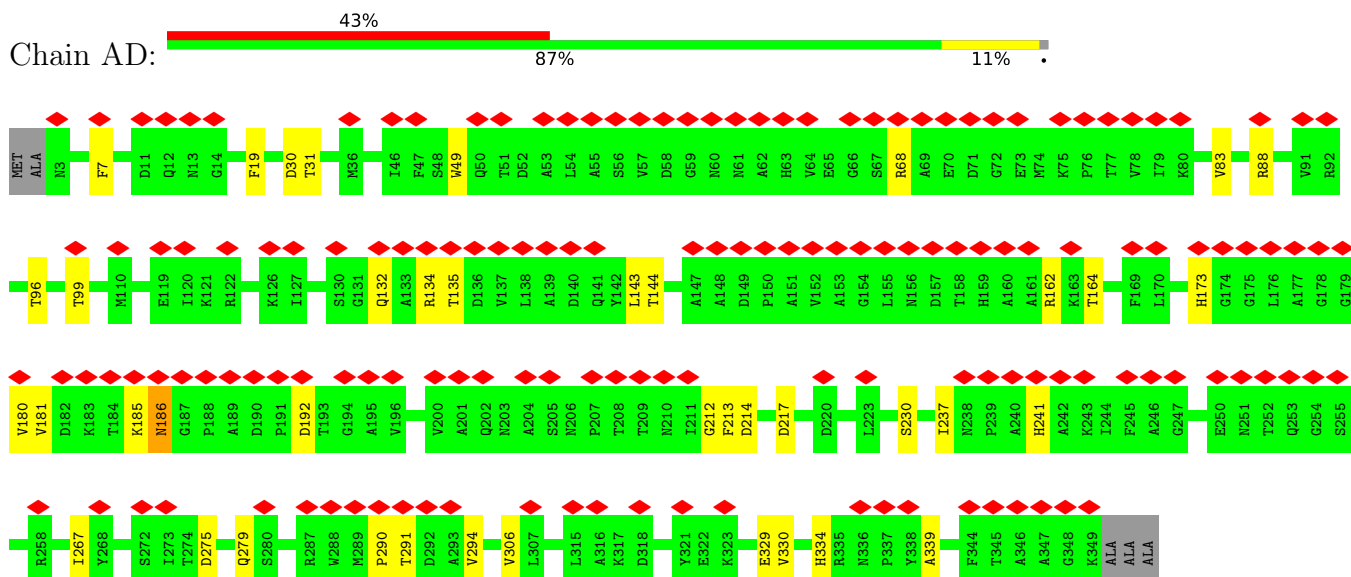

Molecule 1: Major head protein



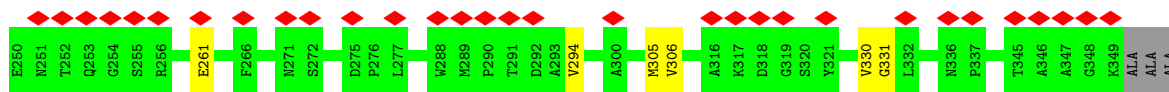

• Molecule 1: Major head protein

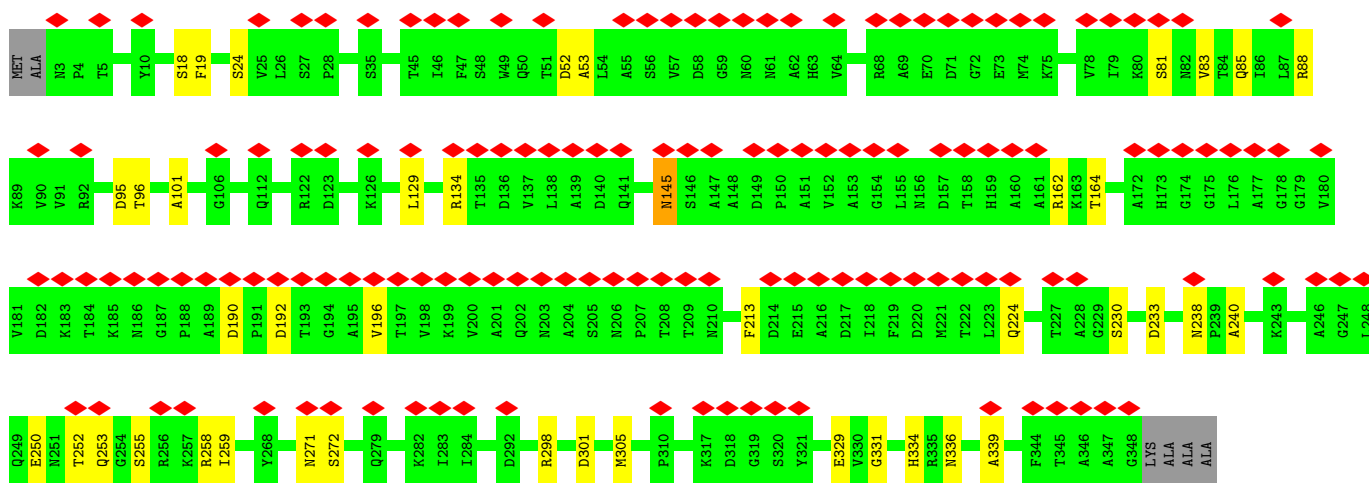
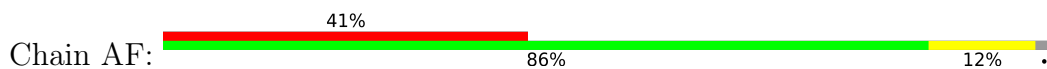

• Molecule 1: Major head protein

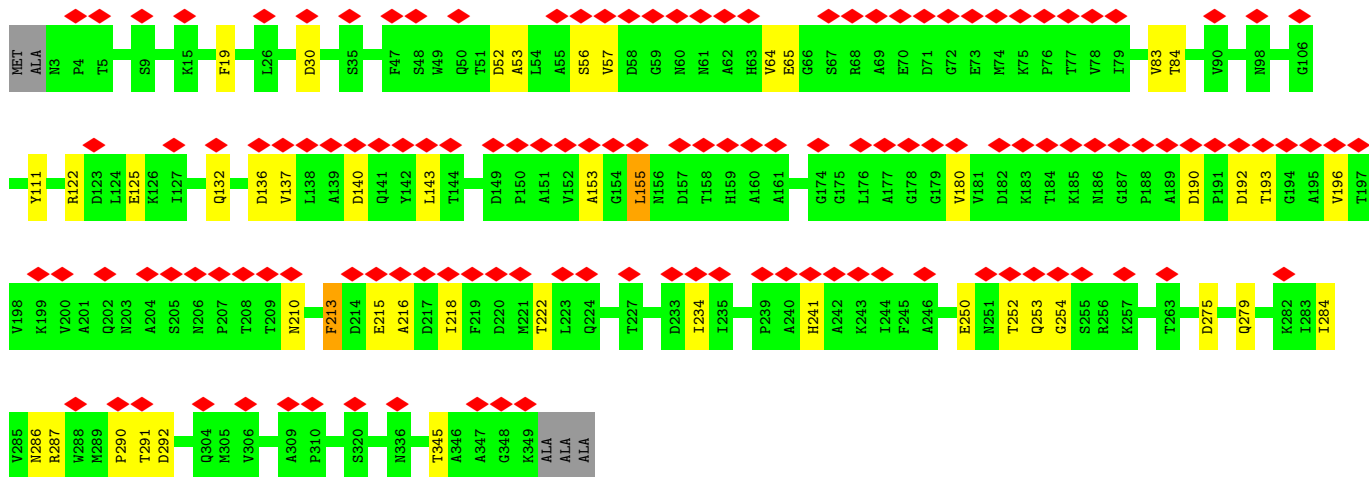
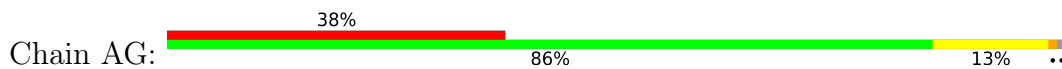

• Molecule 1: Major head protein

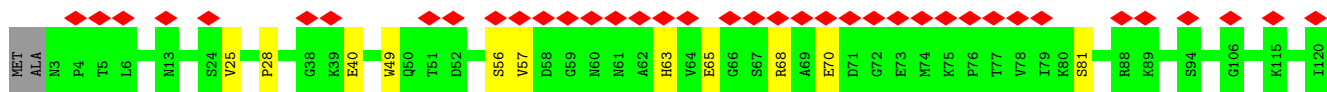
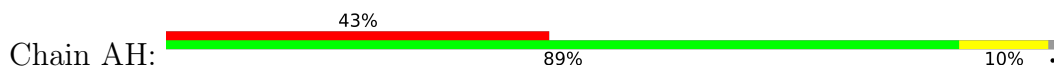

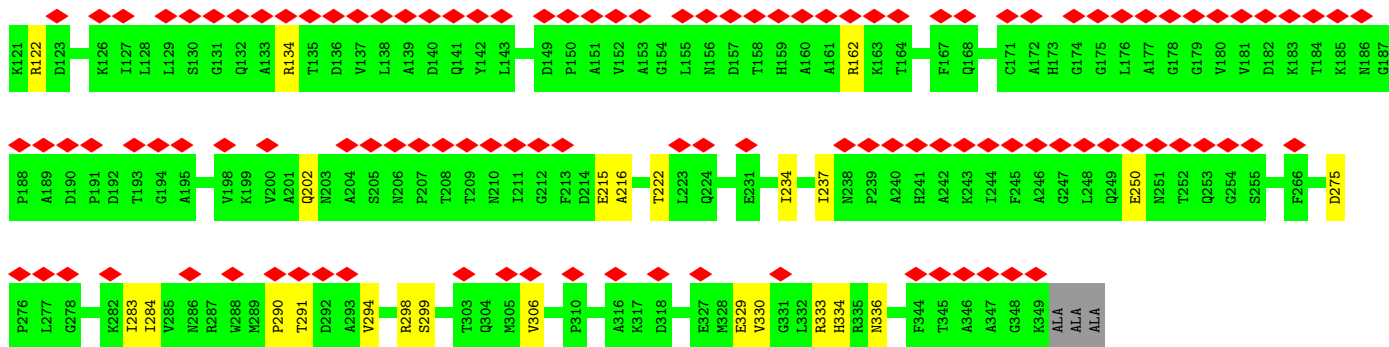

• Molecule 1: Major head protein

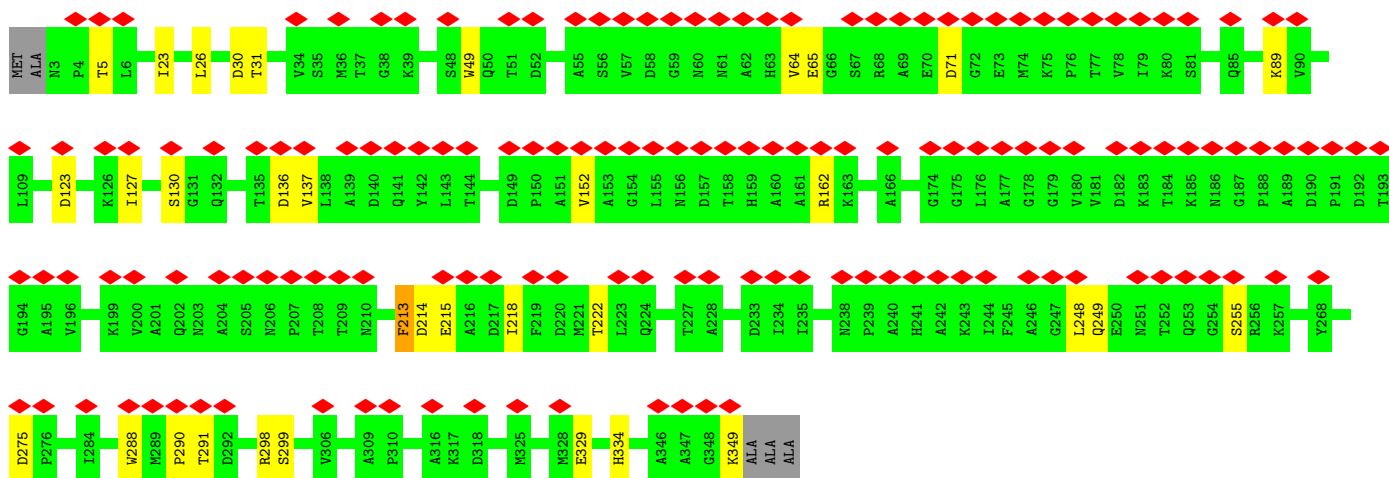
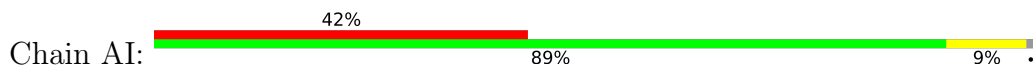

• Molecule 1: Major head protein

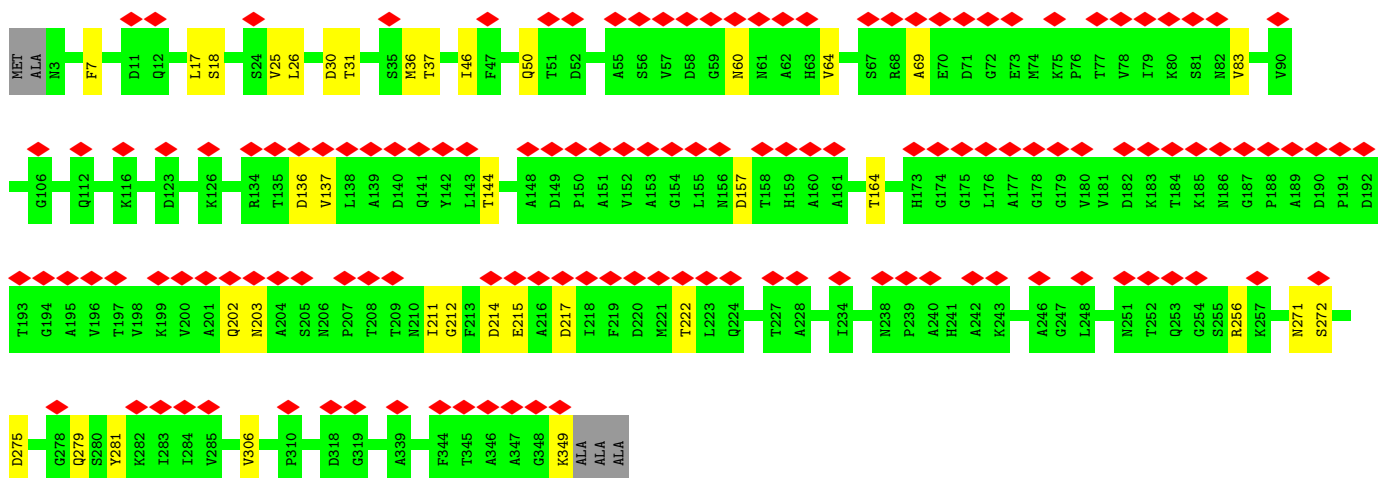
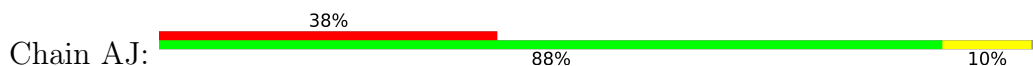

• Molecule 1: Major head protein

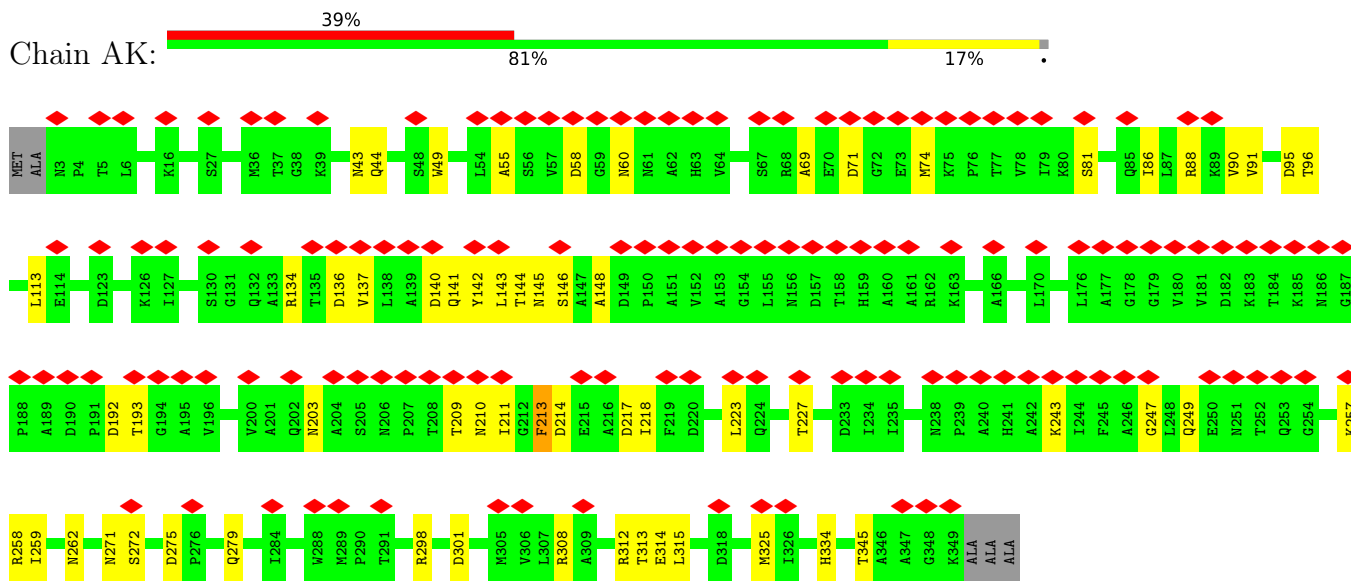

• Molecule 1: Major head protein

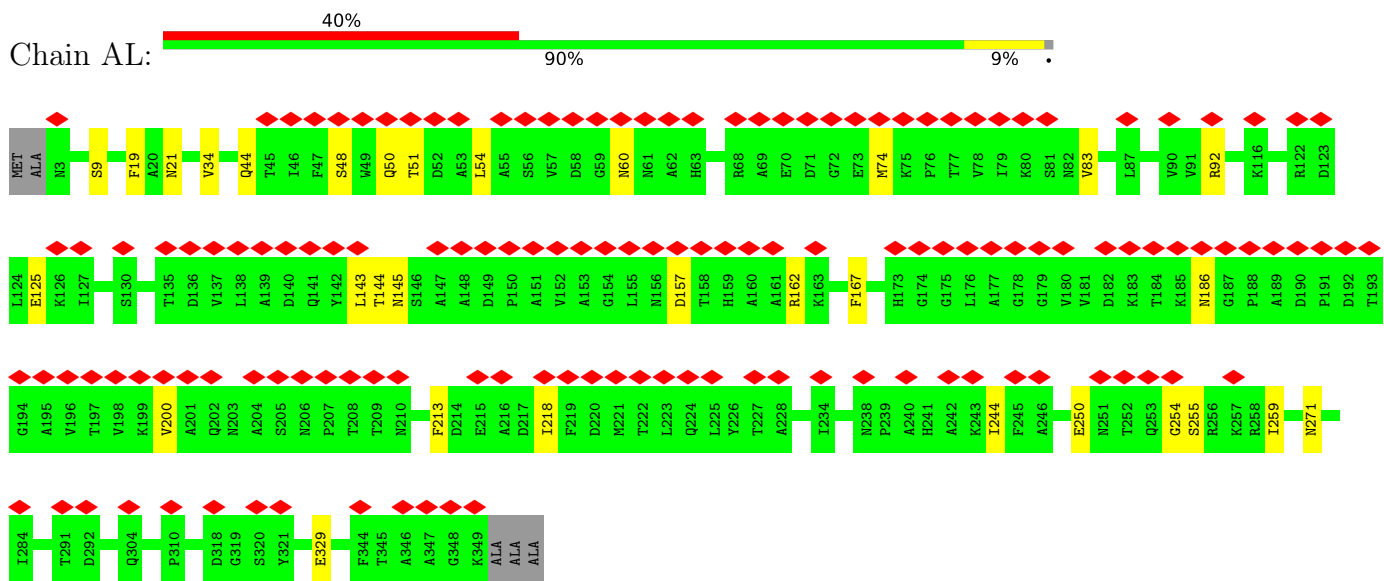

• Molecule 1: Major head protein

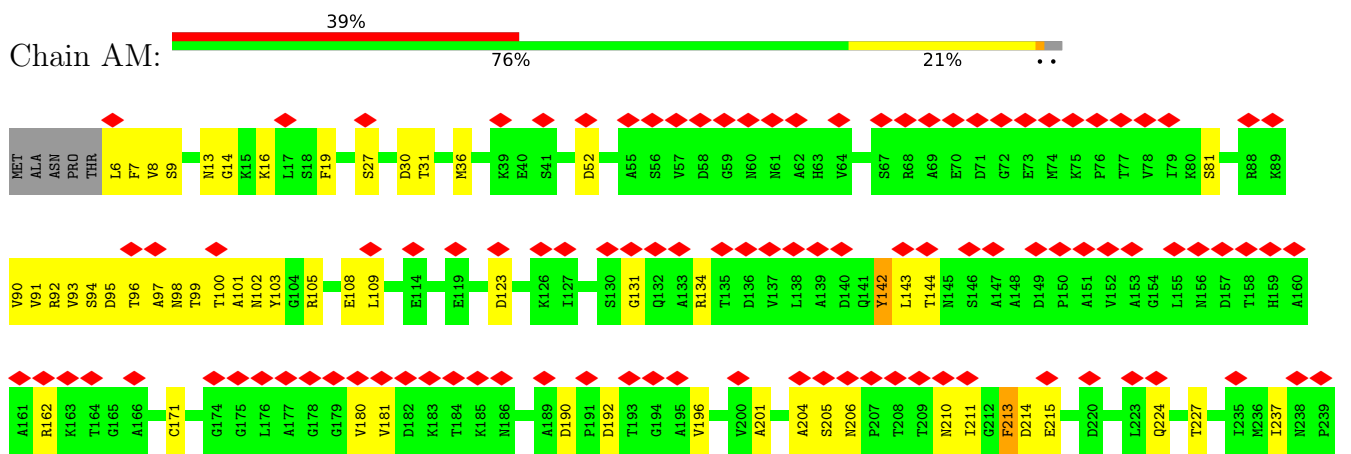

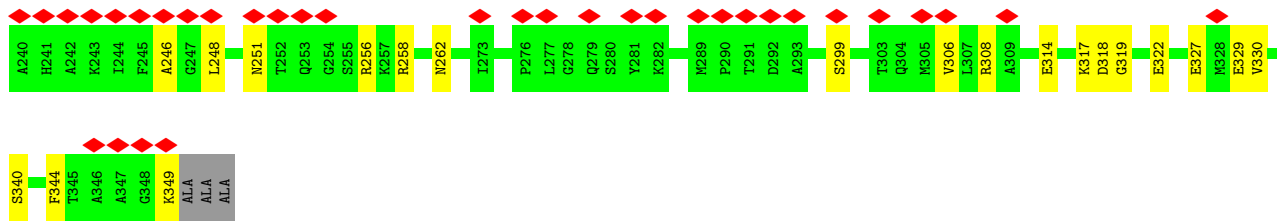

• Molecule 1: Major head protein

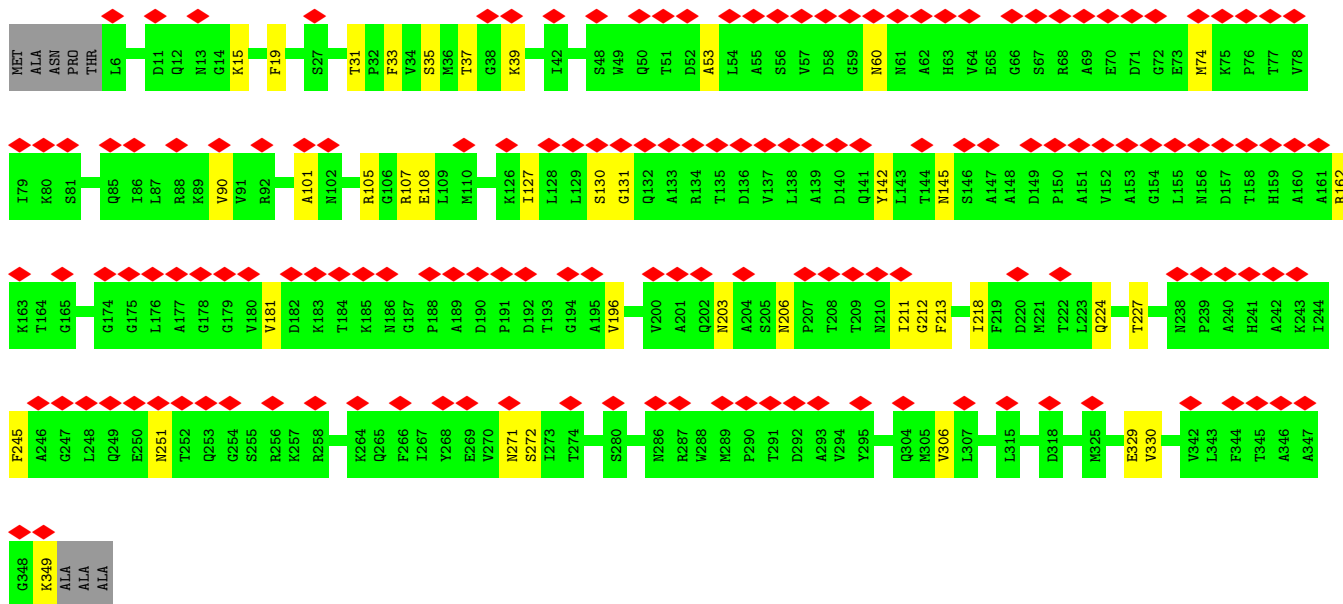
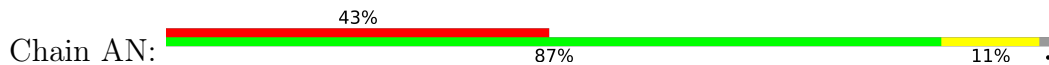

• Molecule 1: Major head protein

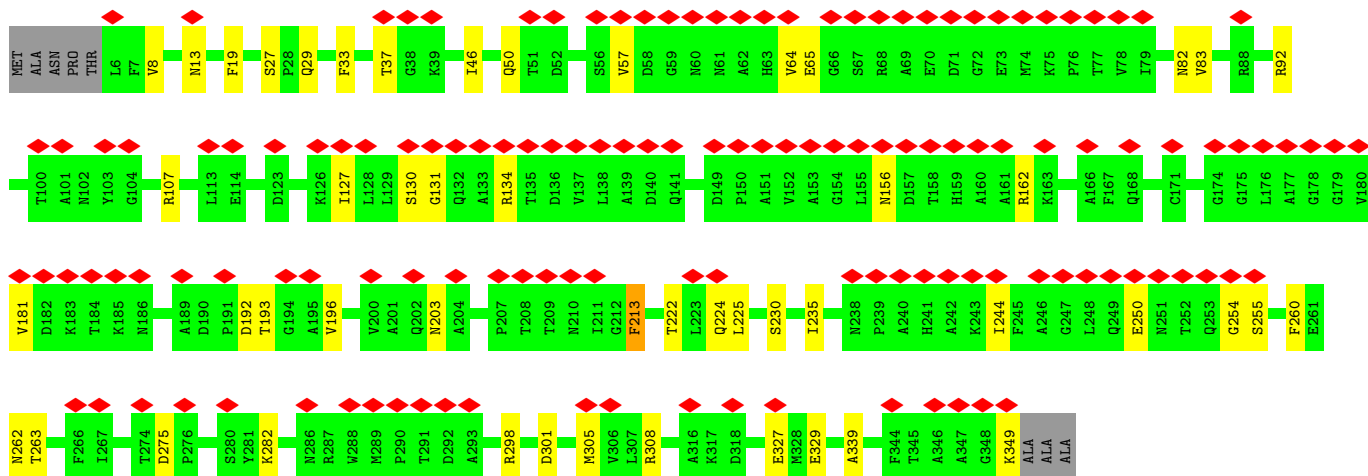
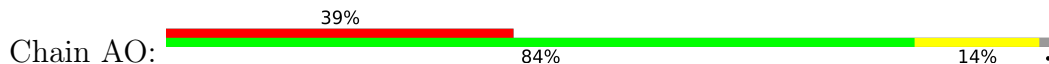

• Molecule 1: Major head protein

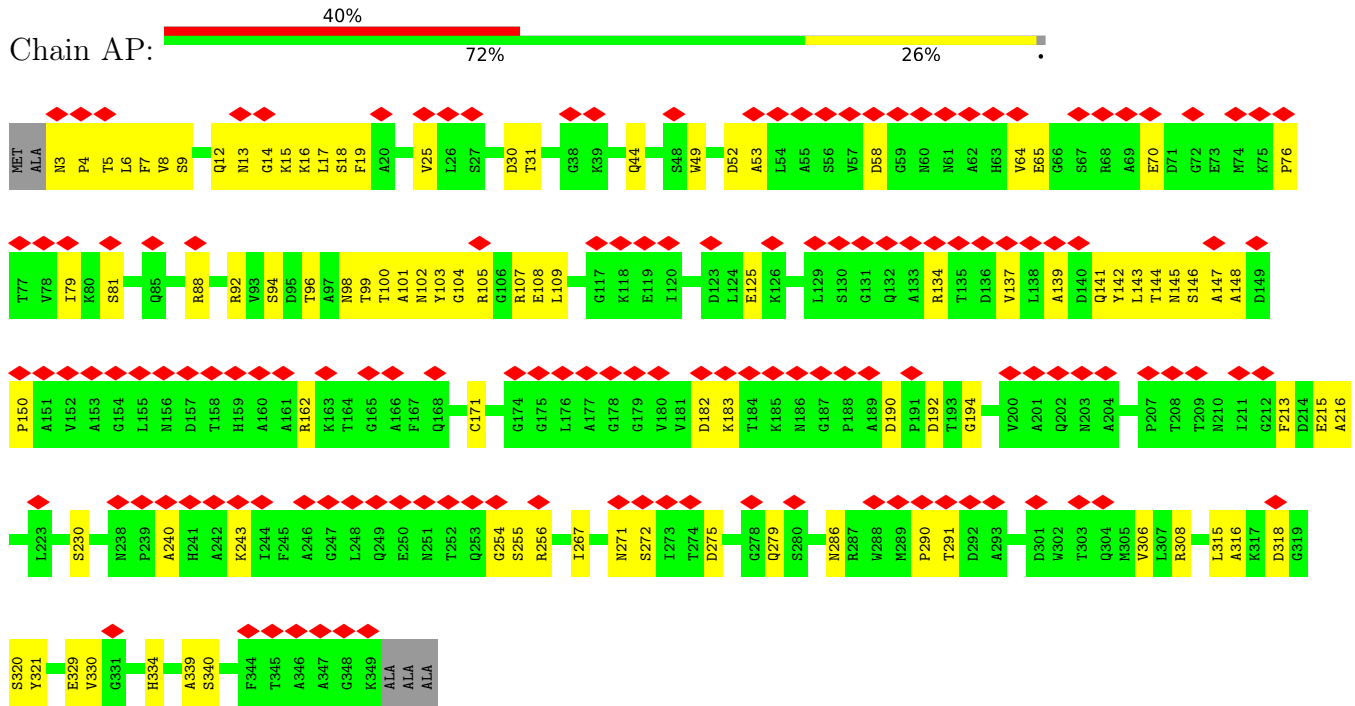

• Molecule 1: Major head protein

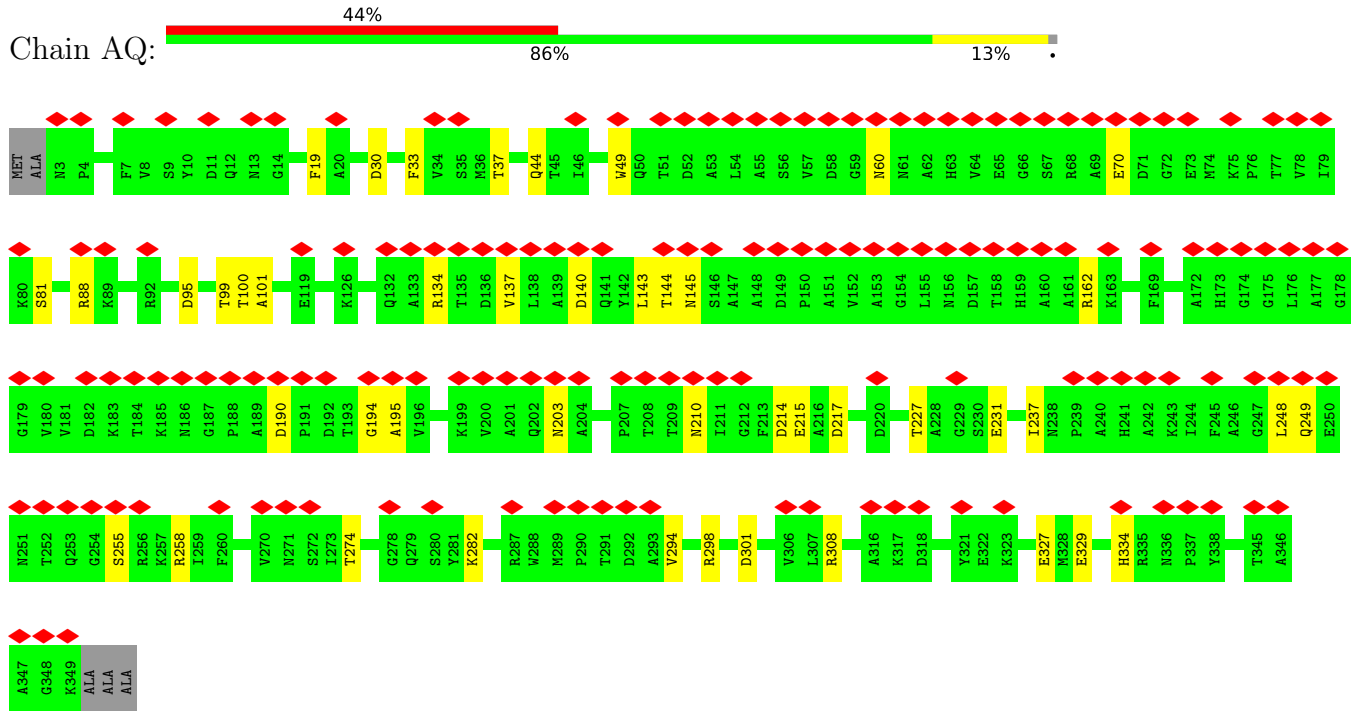

• Molecule 1: Major head protein

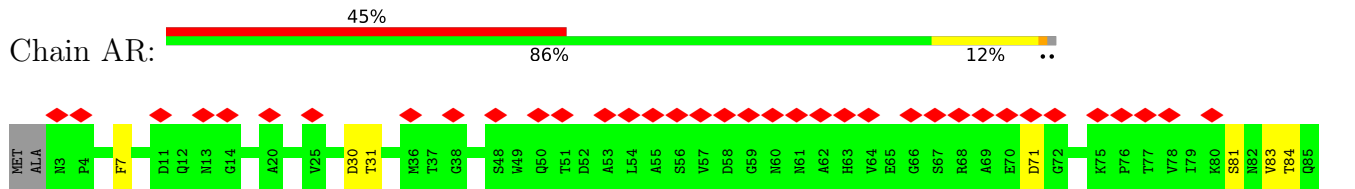

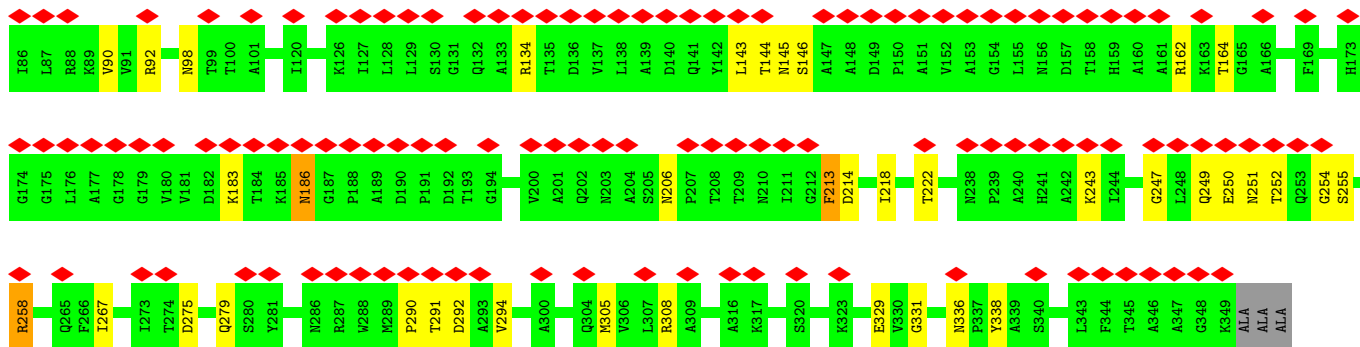

• Molecule 1: Major head protein

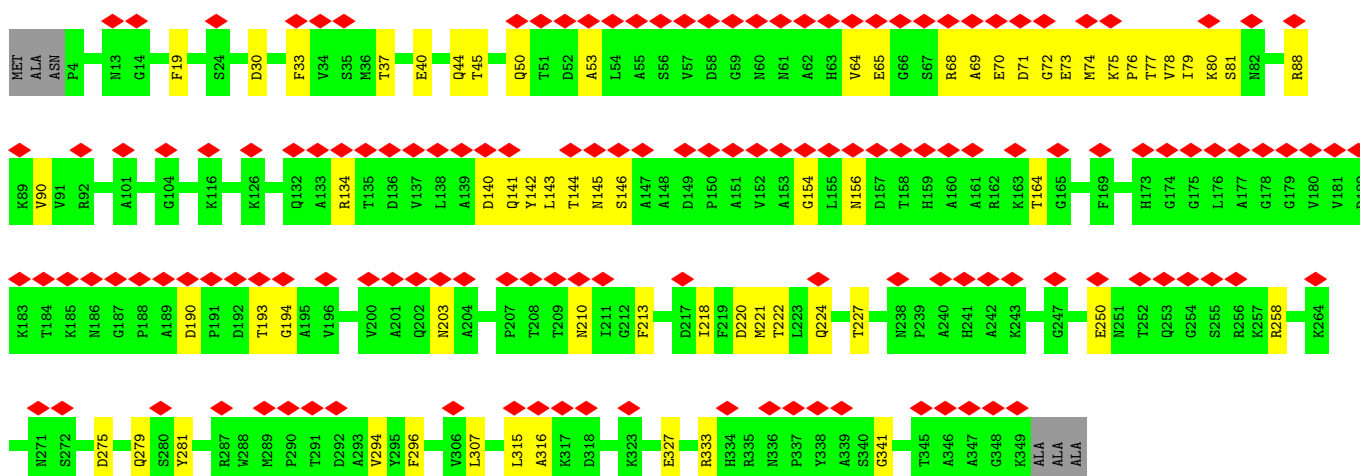
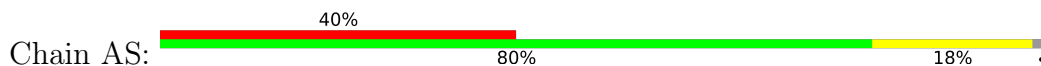

• Molecule 1: Major head protein

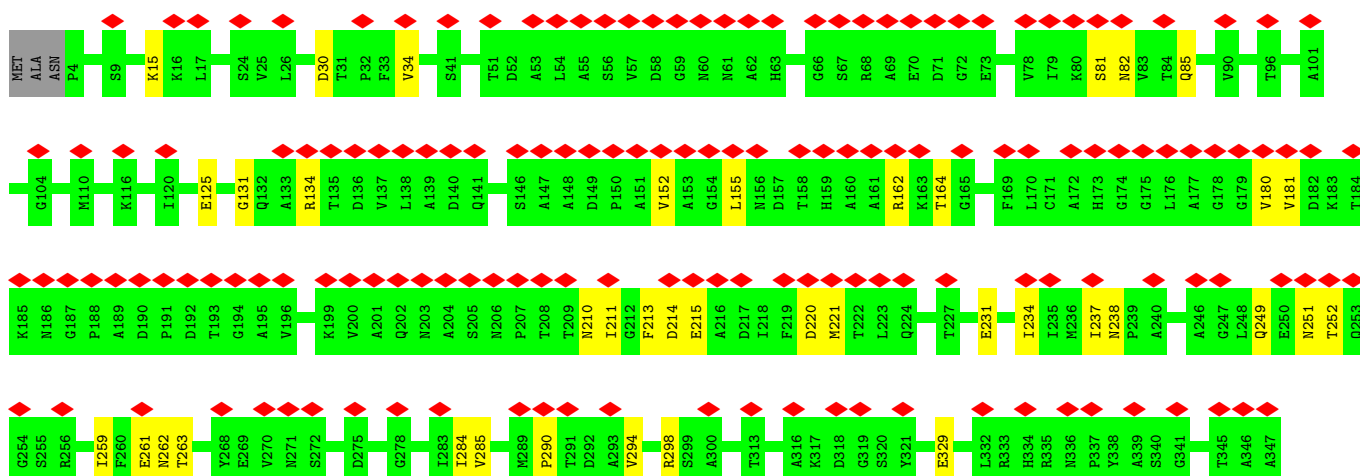
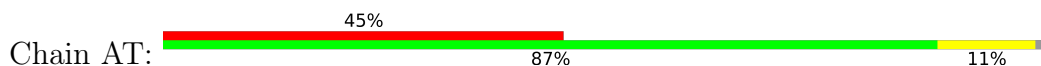

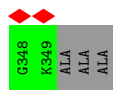

• Molecule 1: Major head protein

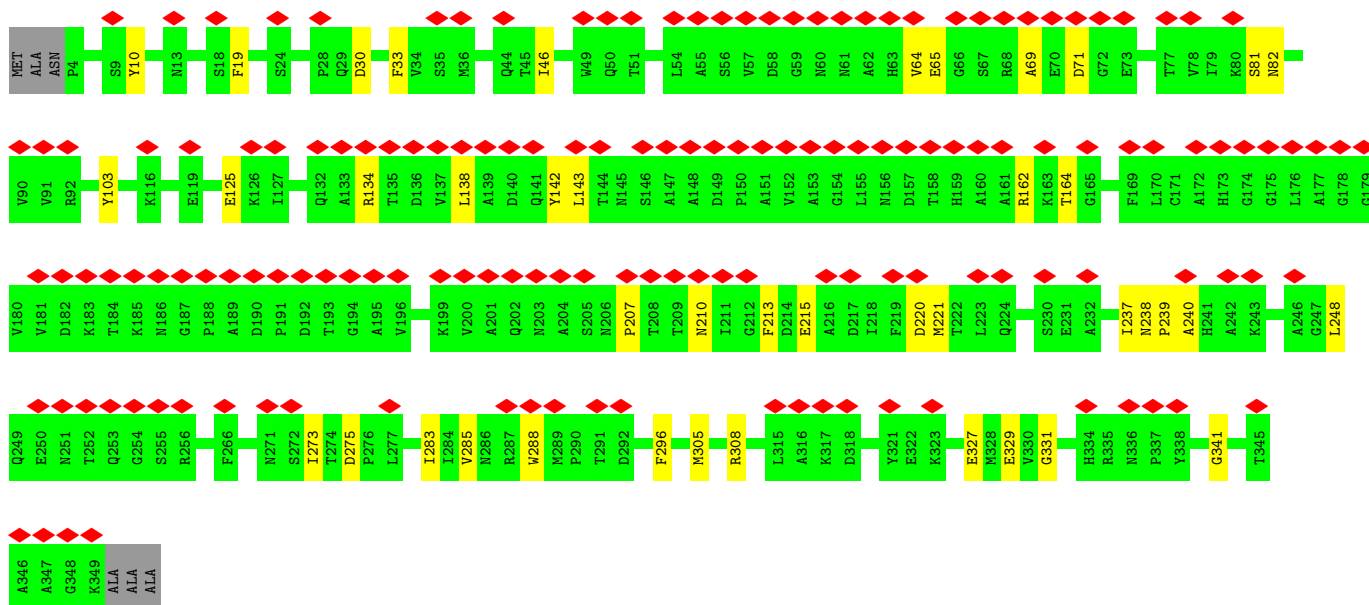
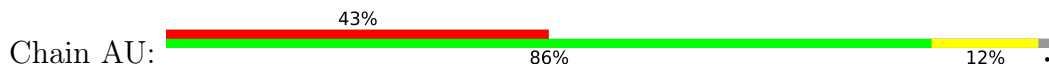

• Molecule 1: Major head protein

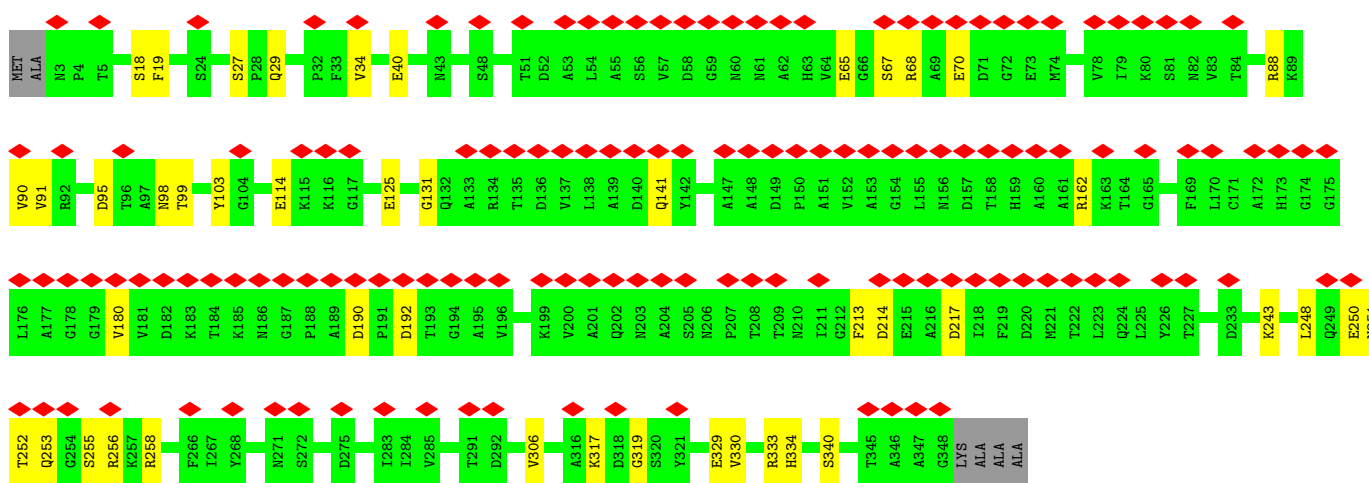
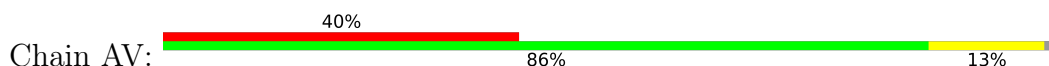

• Molecule 1: Major head protein

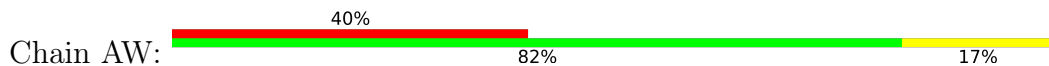

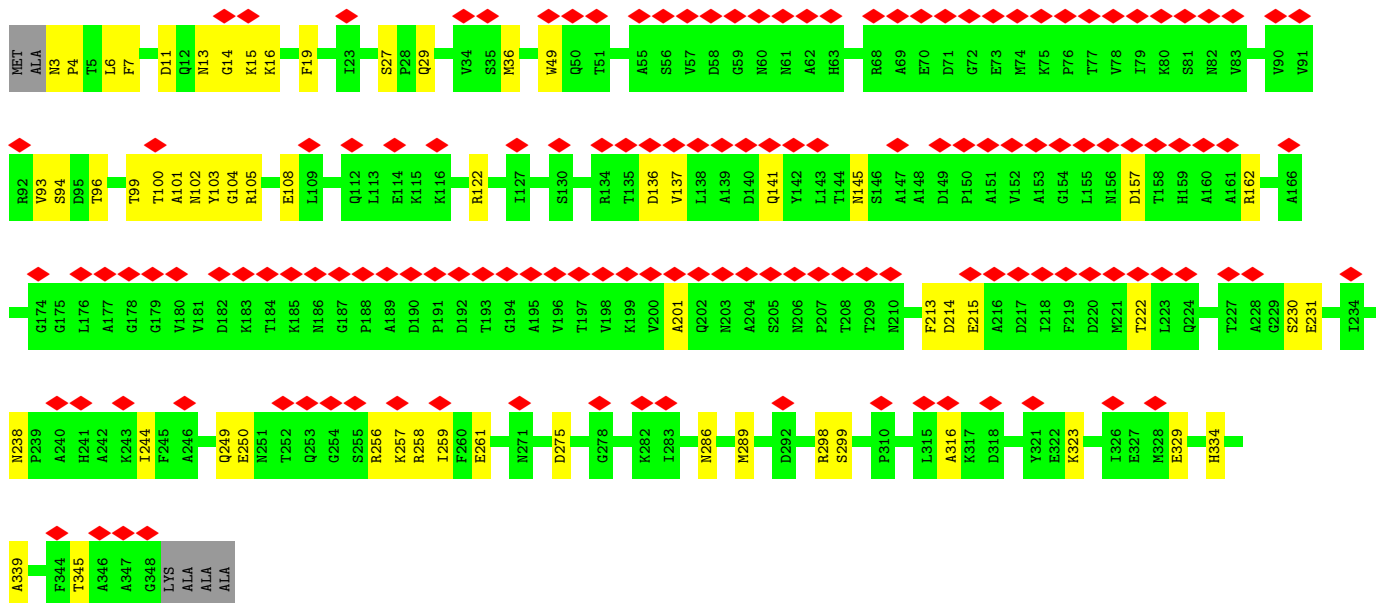

• Molecule 1: Major head protein

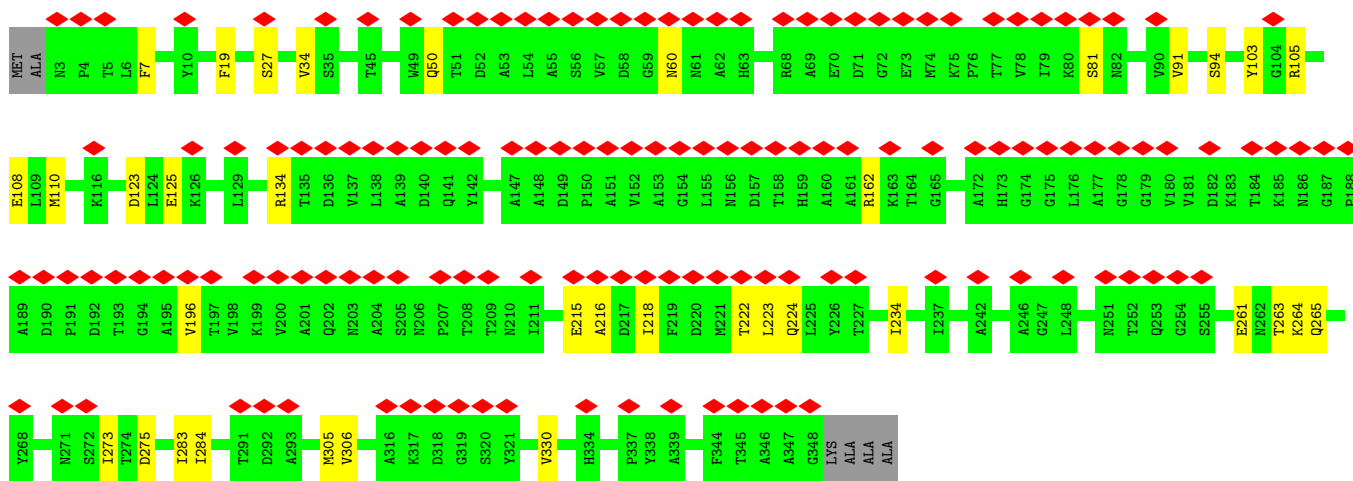
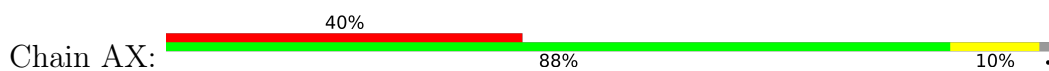

• Molecule 1: Major head protein

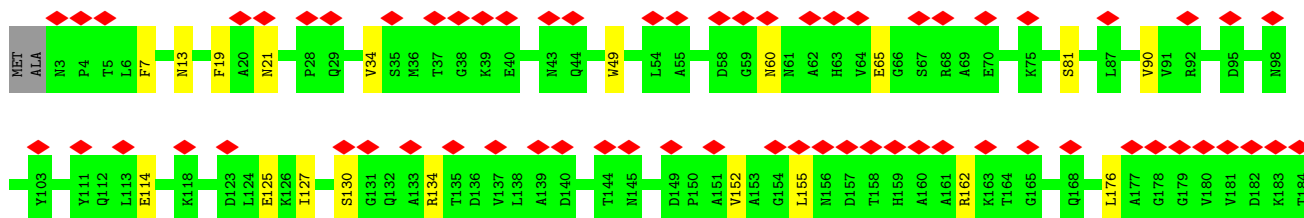
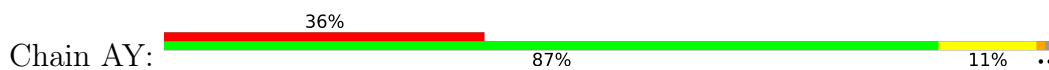

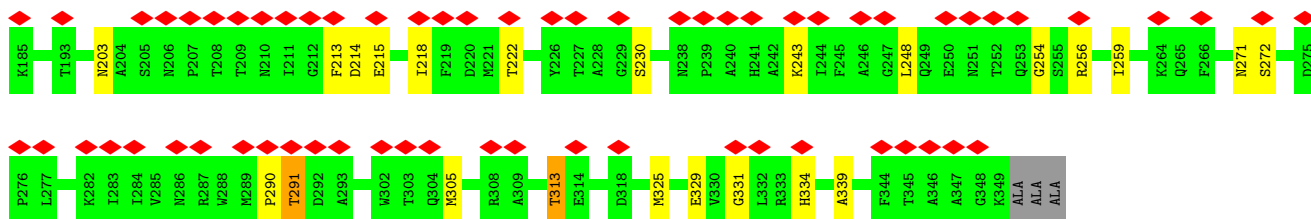

• Molecule 1: Major head protein

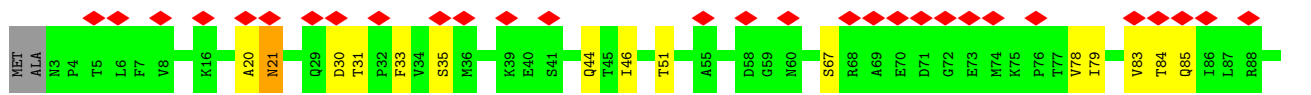
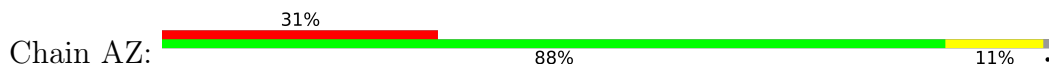

• Molecule 1: Major head protein

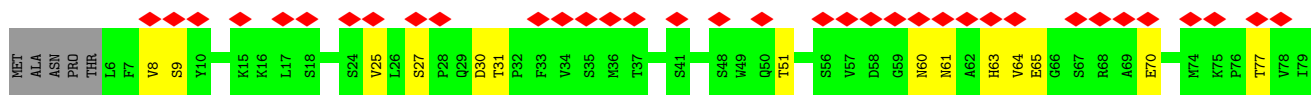
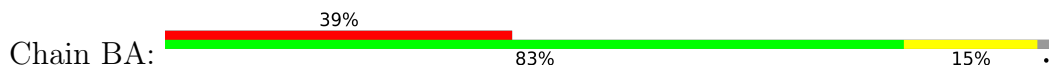

• Molecule 1: Major head protein

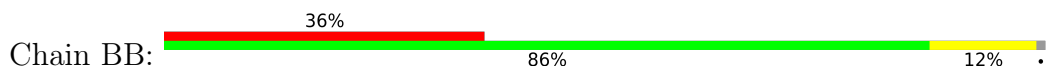

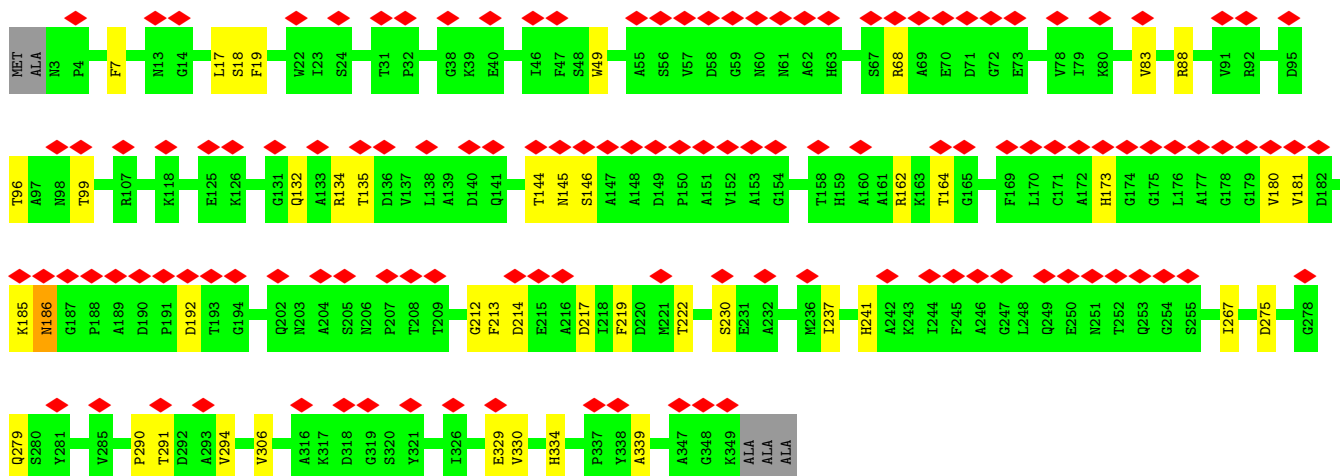

- Molecule 1: Major head protein

Chain BC: 32% 88% 11%

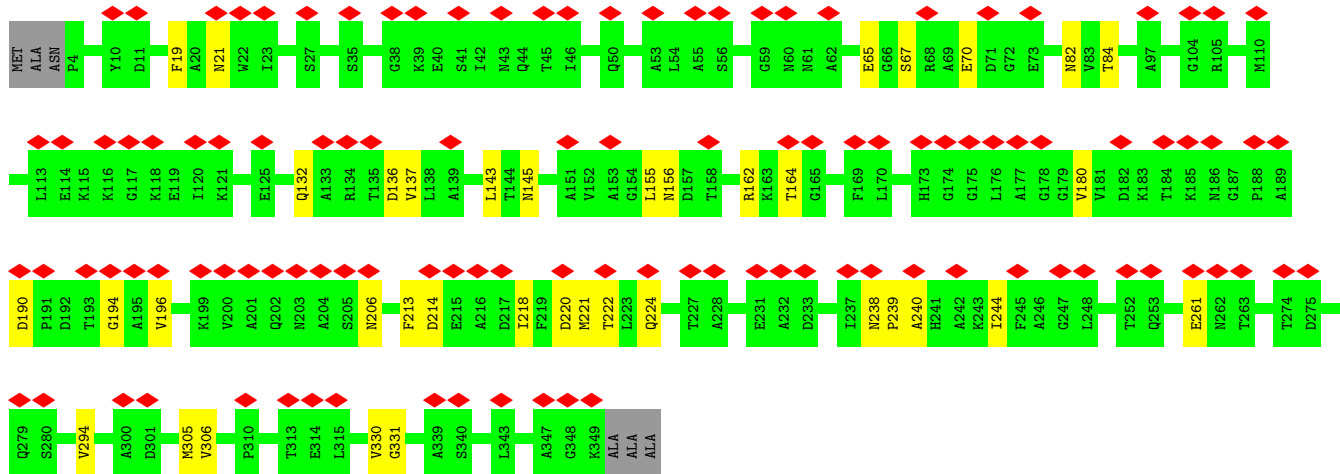

- Molecule 1: Major head protein

Chain BD: 30% 88% 11%

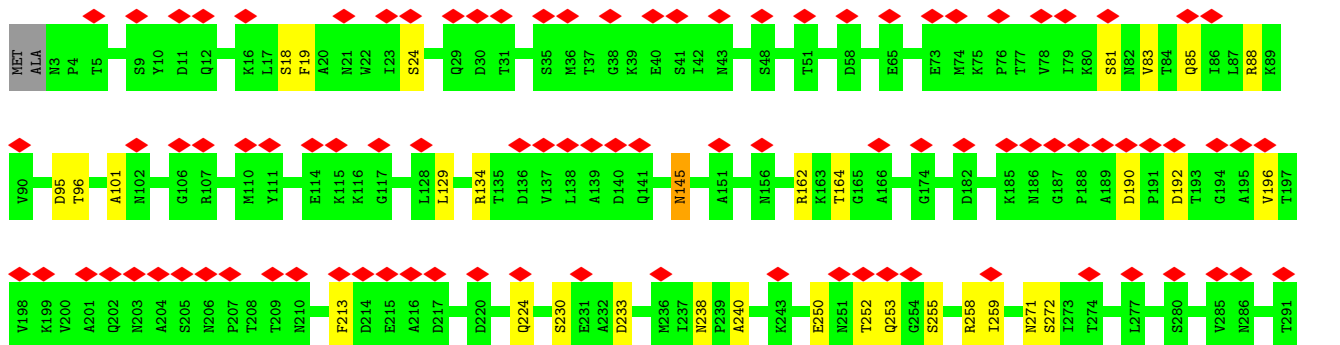

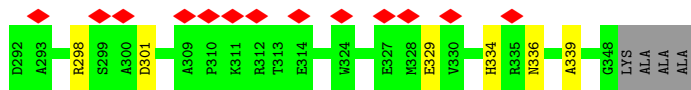

• Molecule 1: Major head protein

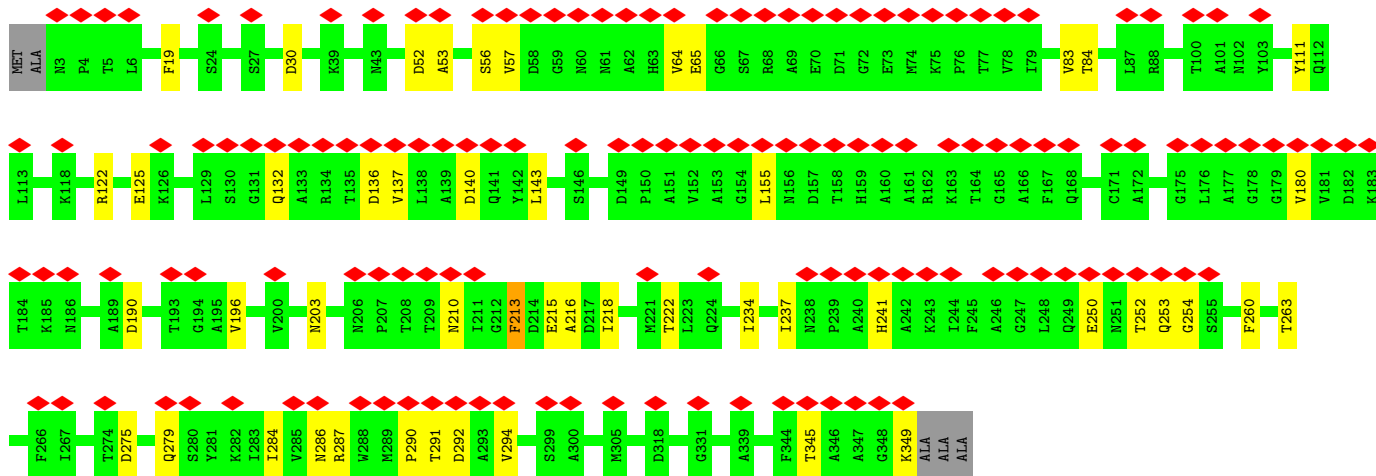
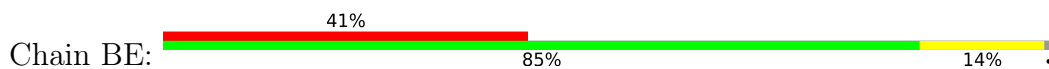

• Molecule 1: Major head protein

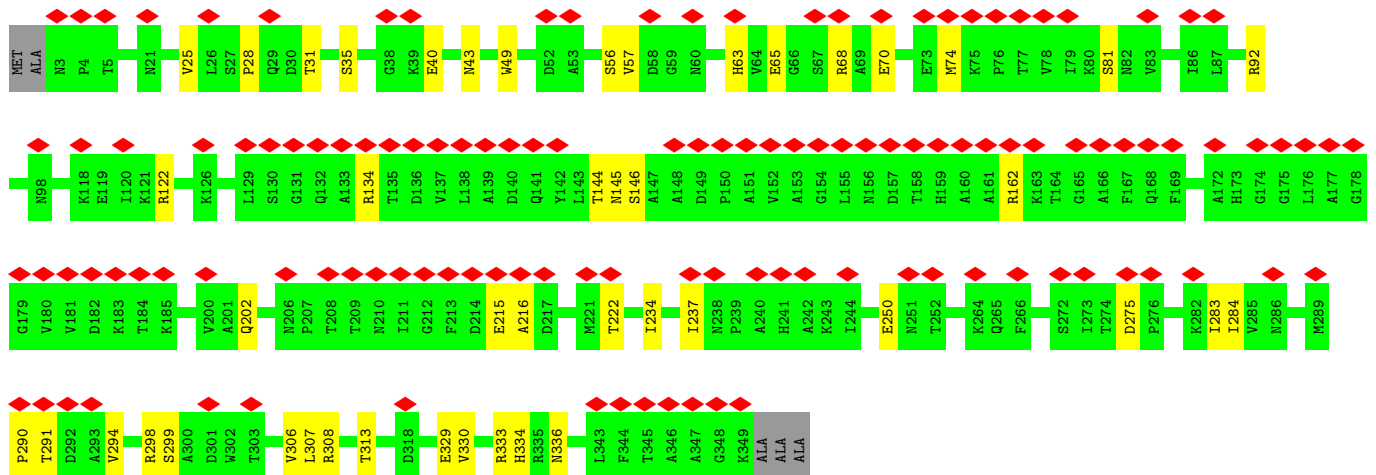
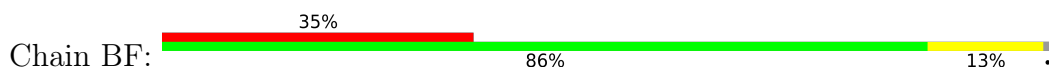

• Molecule 1: Major head protein

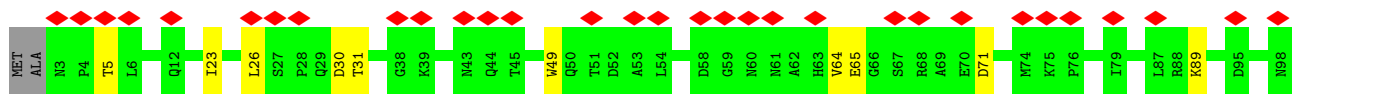
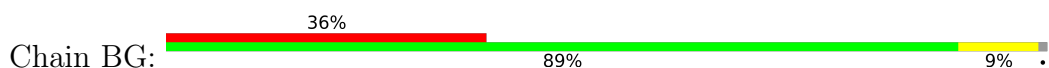

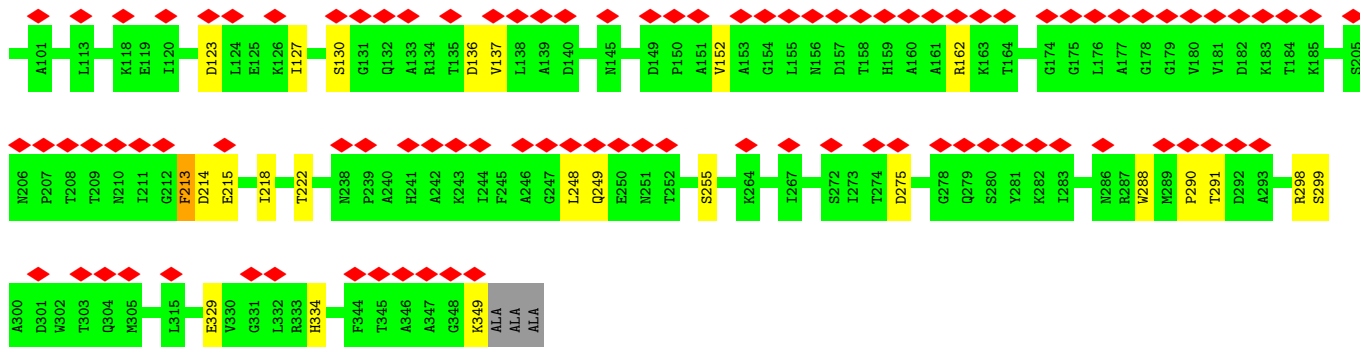

• Molecule 1: Major head protein

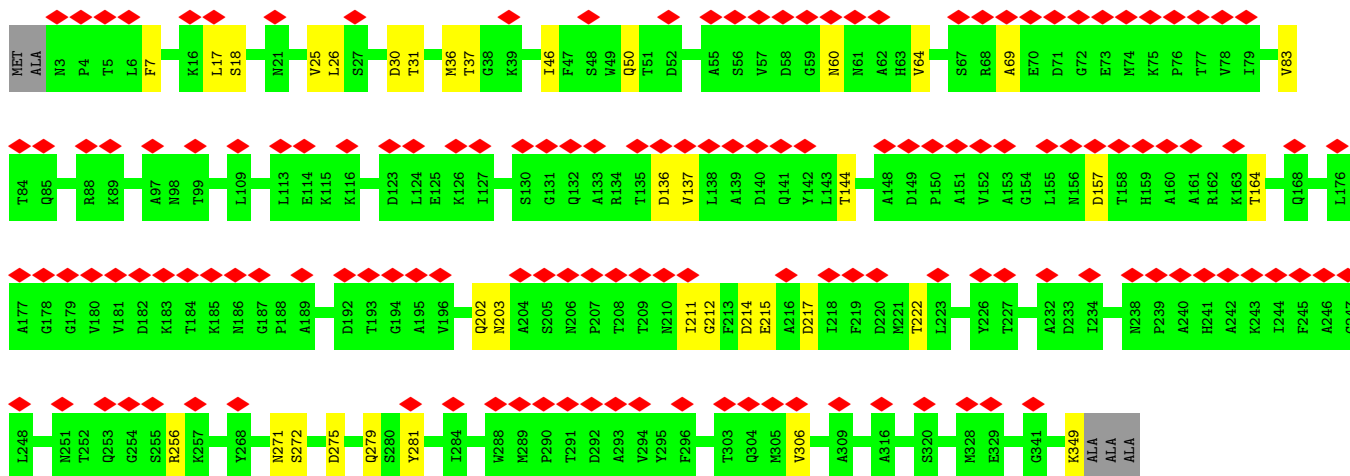
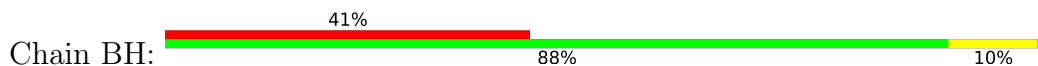

• Molecule 1: Major head protein

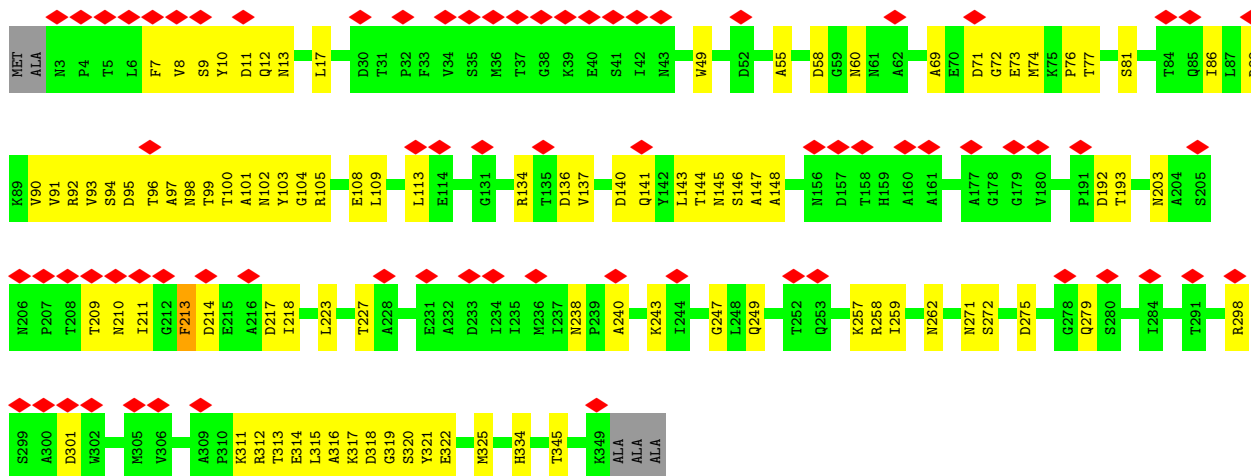

• Molecule 1: Major head protein

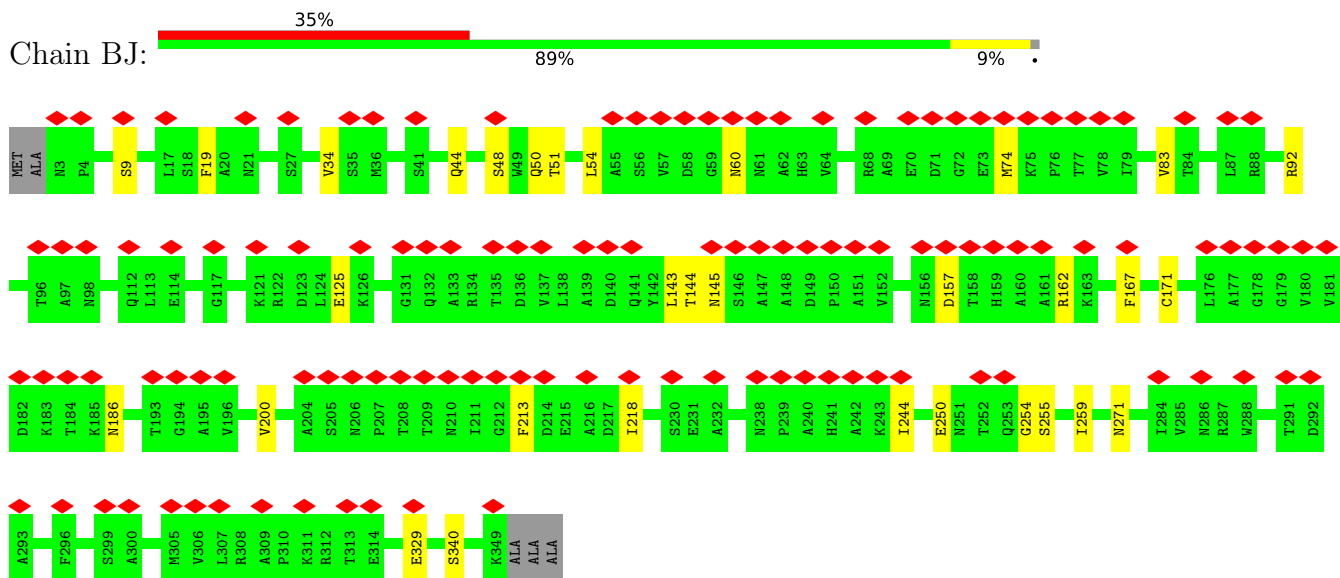

• Molecule 1: Major head protein

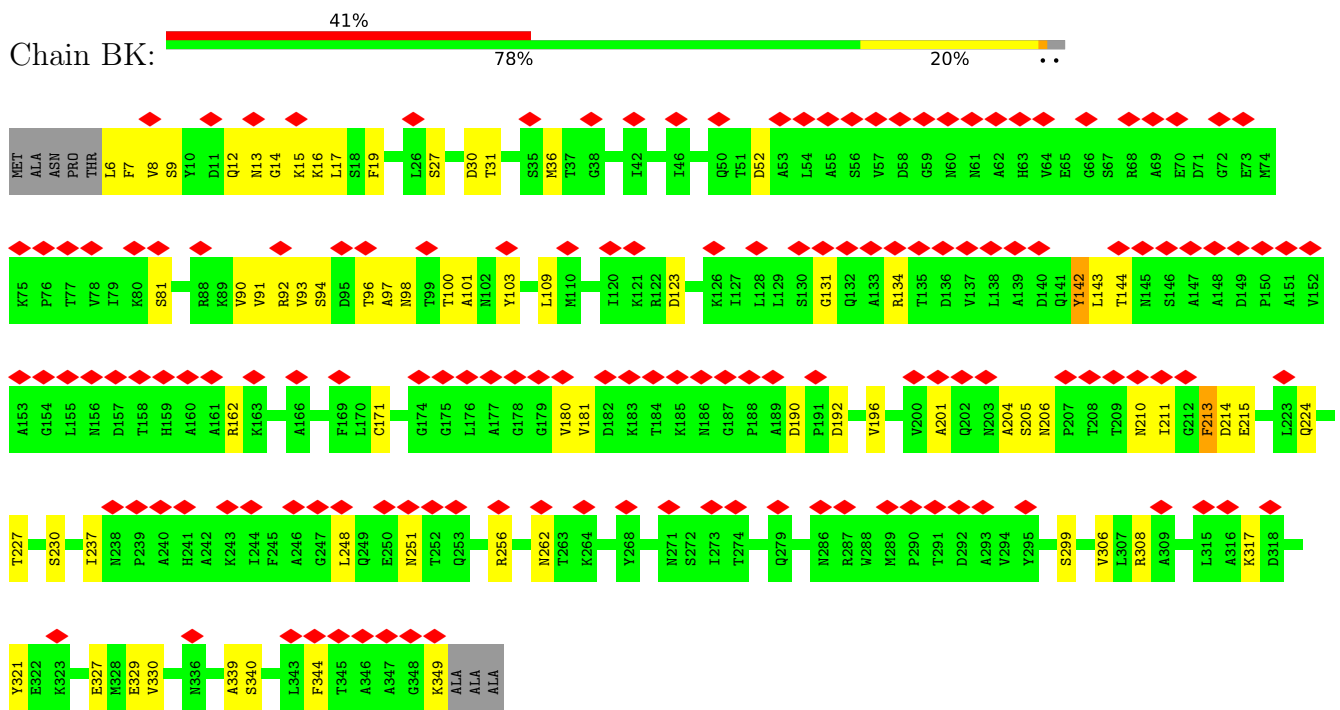

• Molecule 1: Major head protein

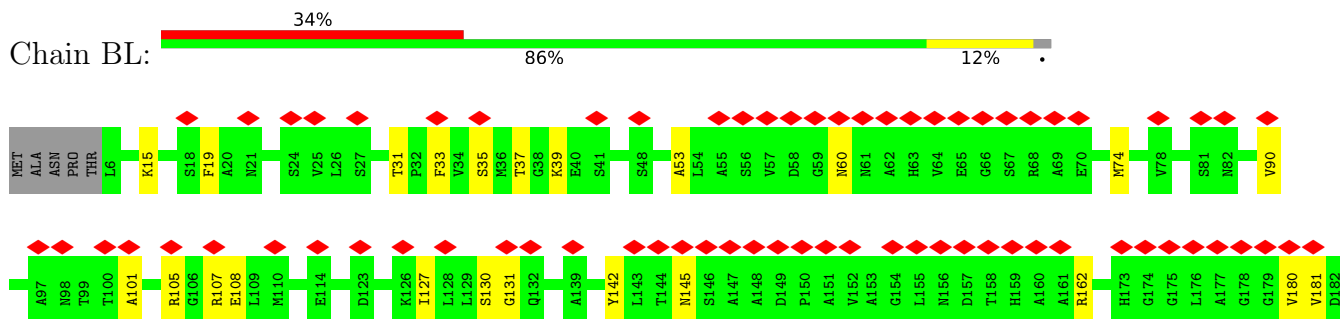

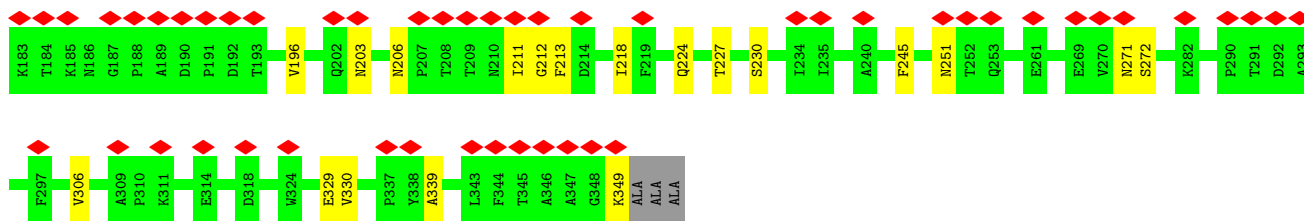

• Molecule 1: Major head protein

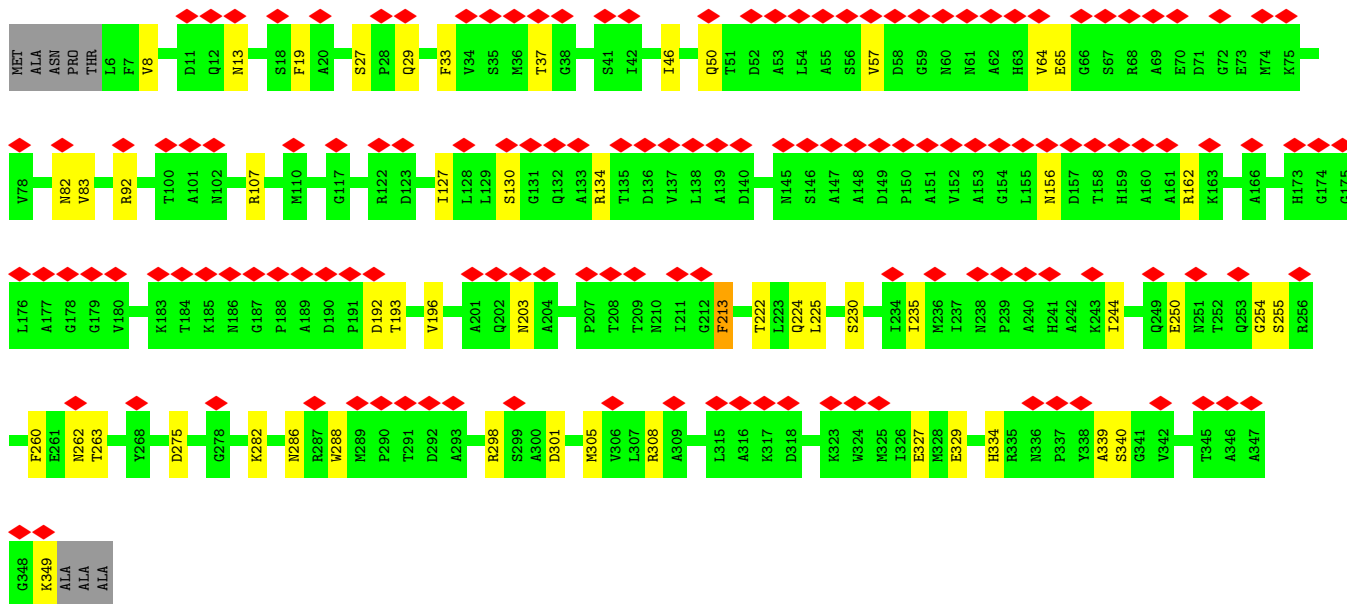
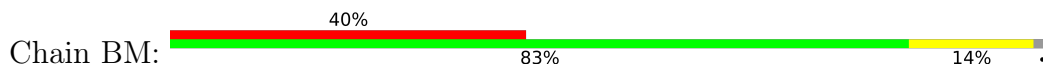

• Molecule 1: Major head protein

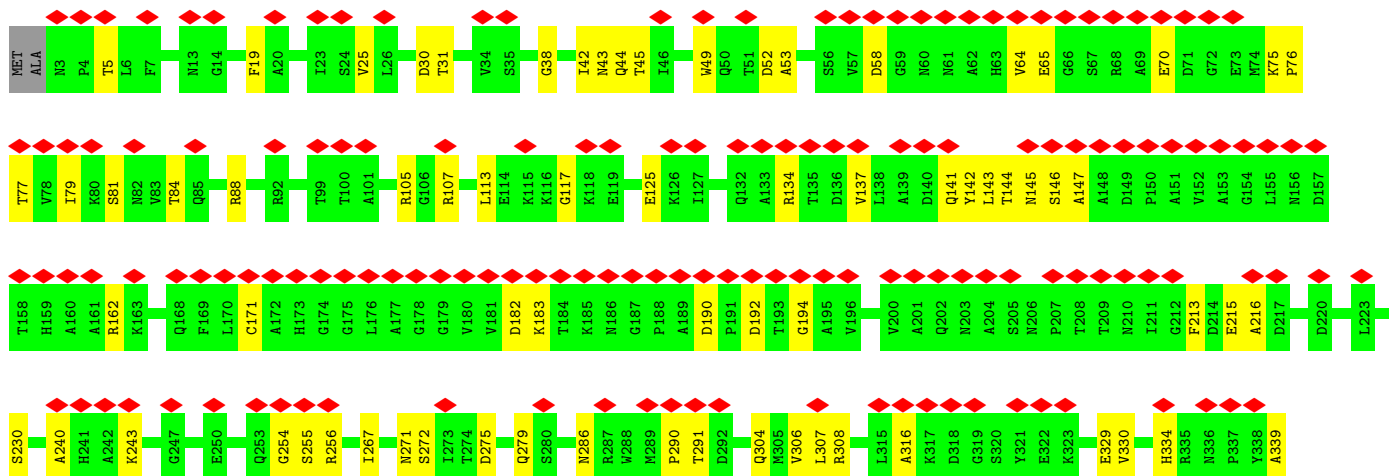
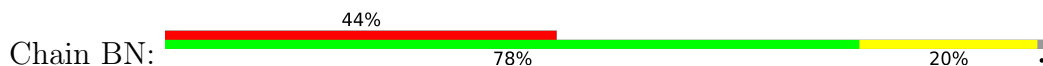

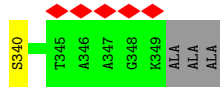

• Molecule 1: Major head protein

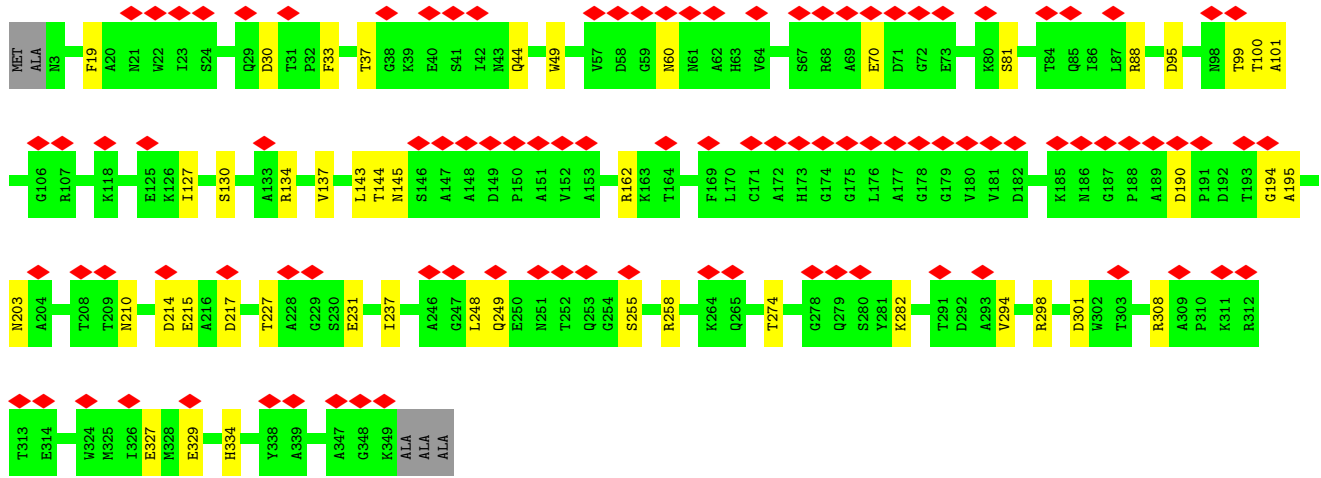
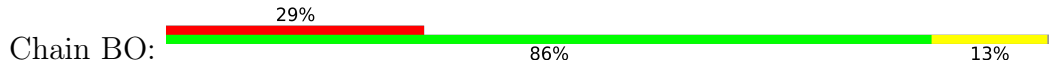

• Molecule 1: Major head protein

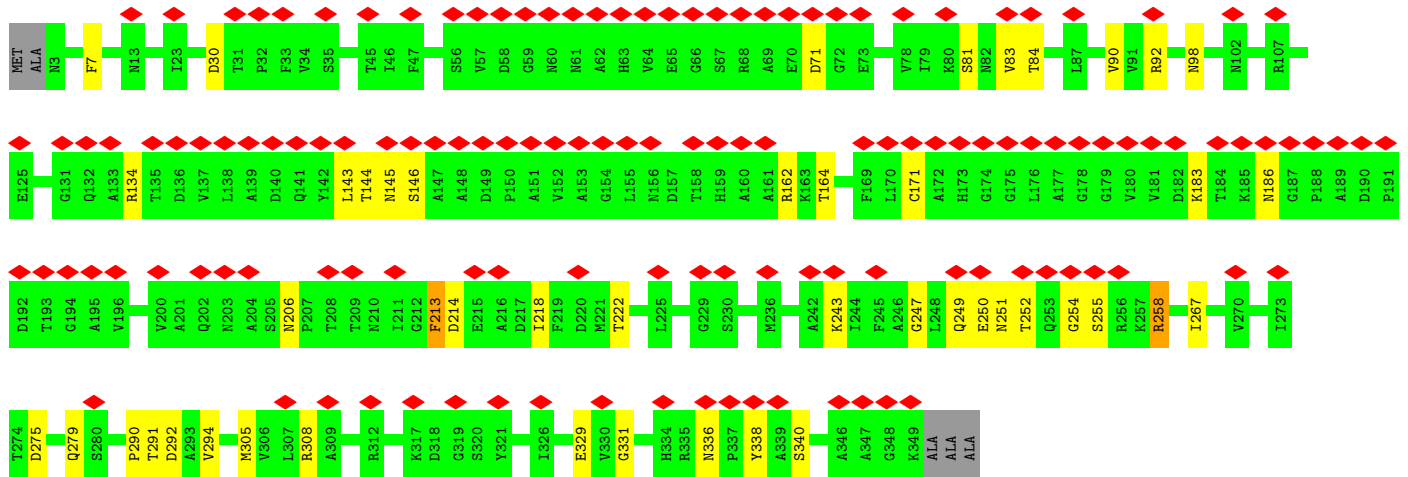
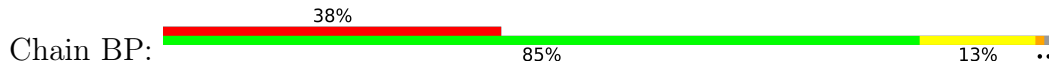

• Molecule 1: Major head protein

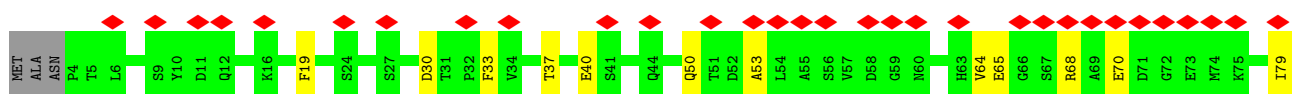
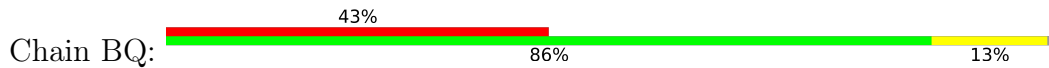



• Molecule 1: Major head protein

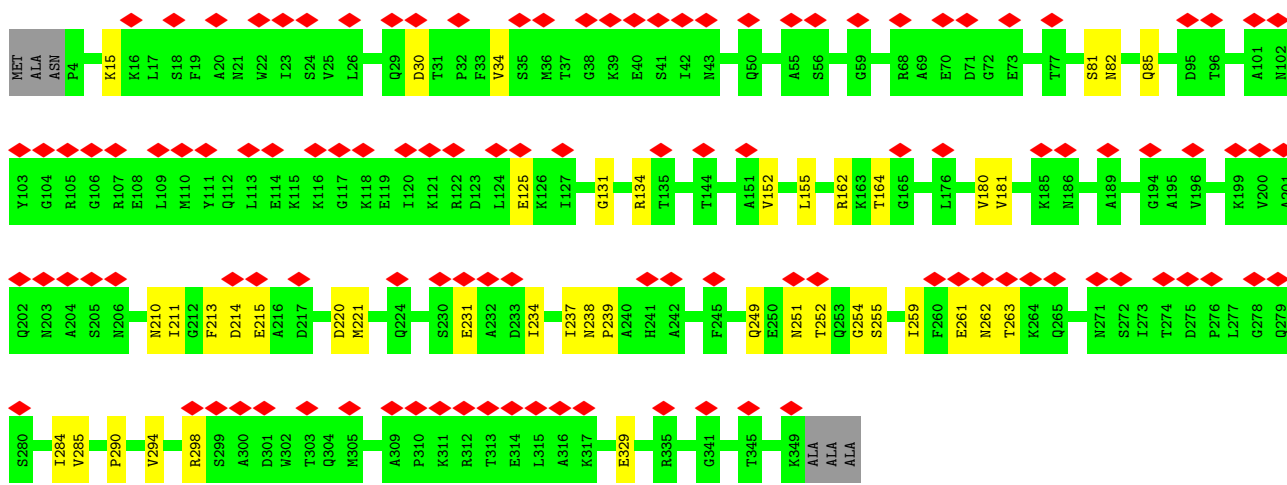
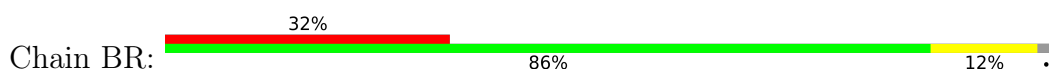

• Molecule 1: Major head protein

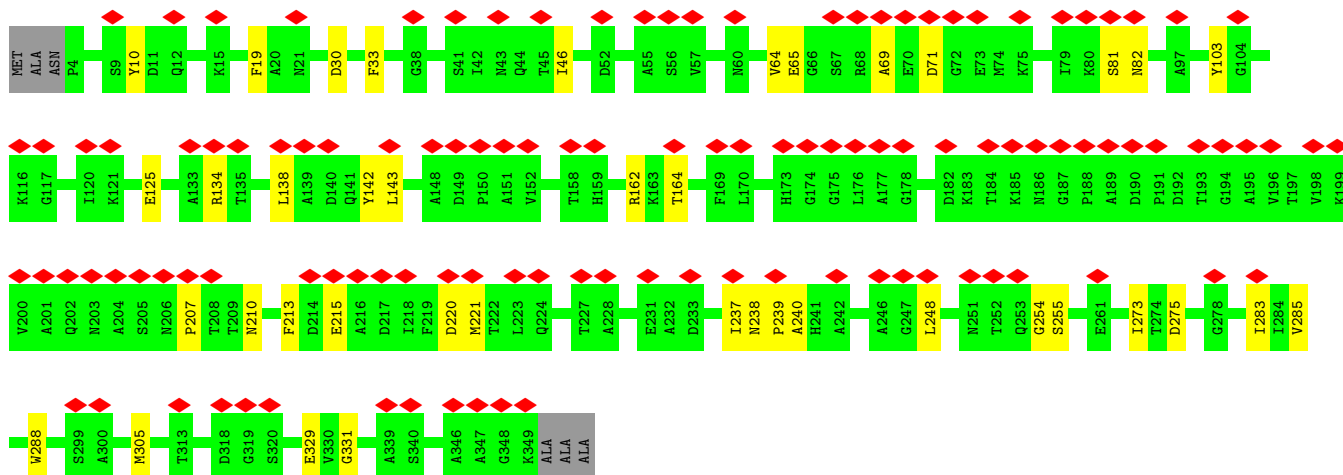
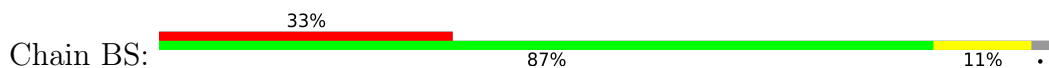

• Molecule 1: Major head protein

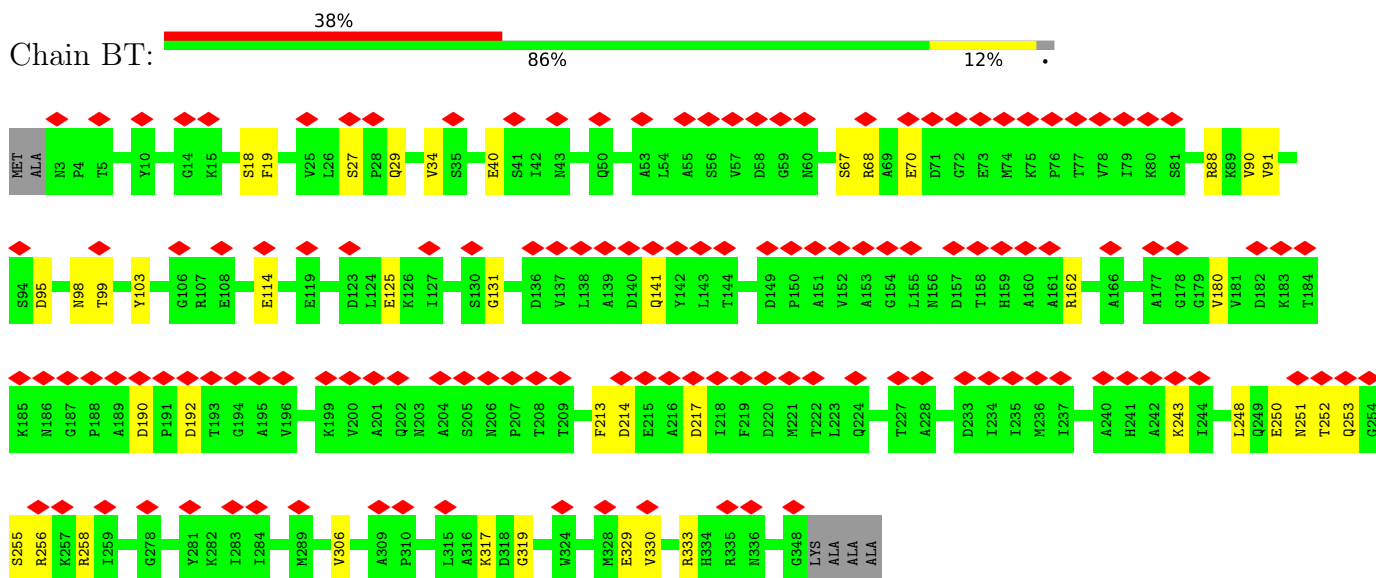

• Molecule 1: Major head protein

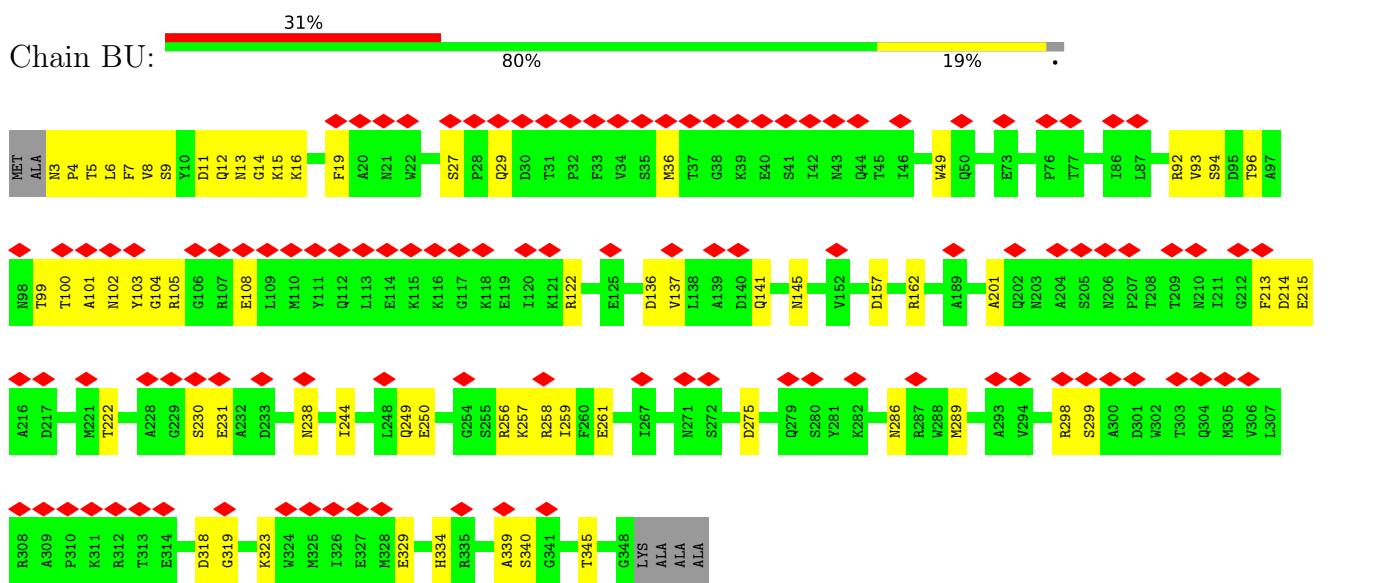

• Molecule 1: Major head protein

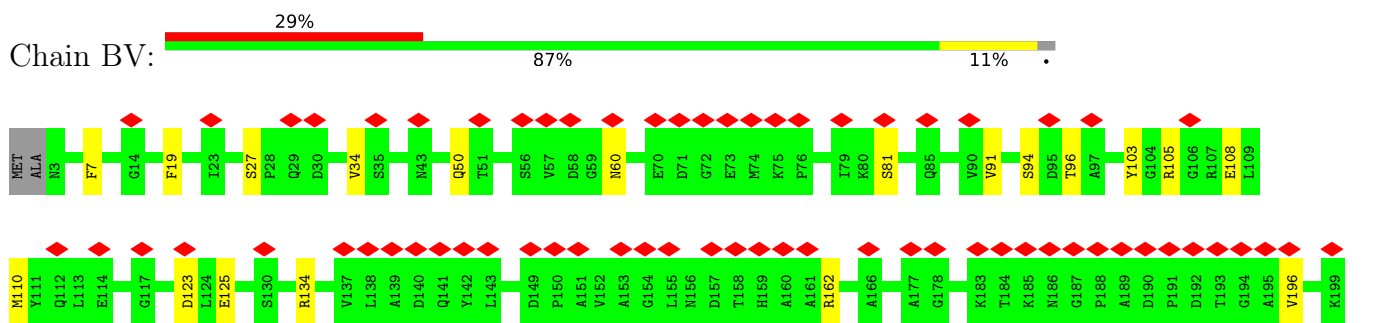

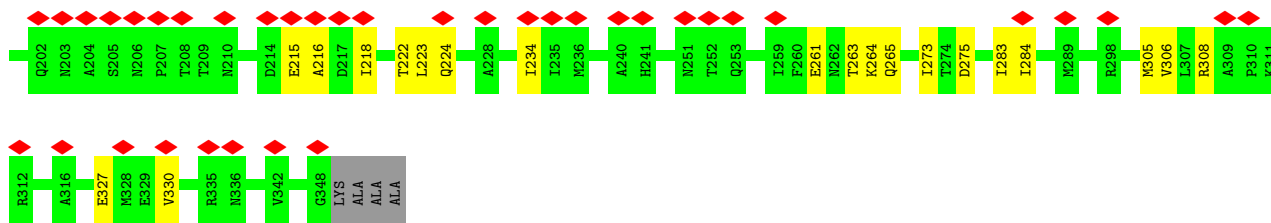

• Molecule 1: Major head protein

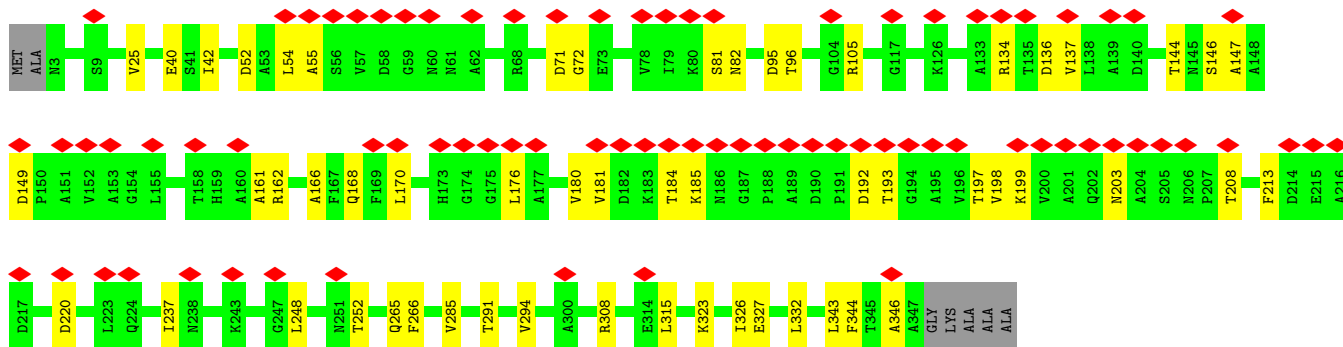
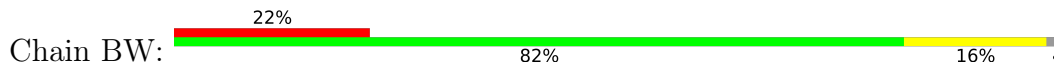

• Molecule 1: Major head protein

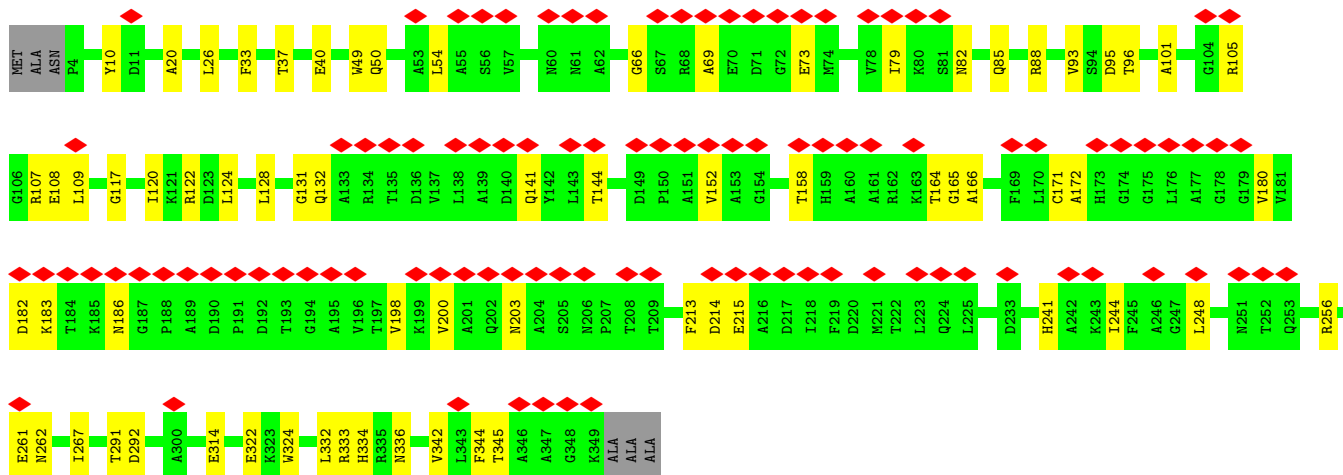
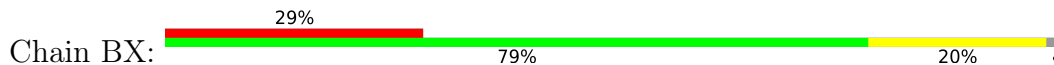

• Molecule 1: Major head protein

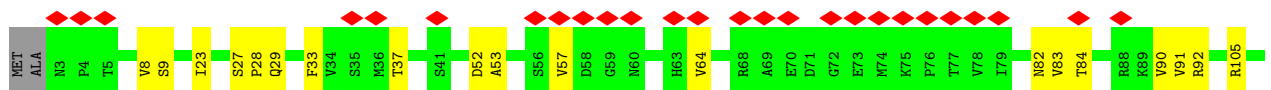
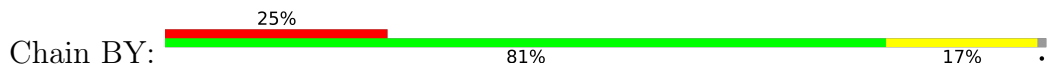

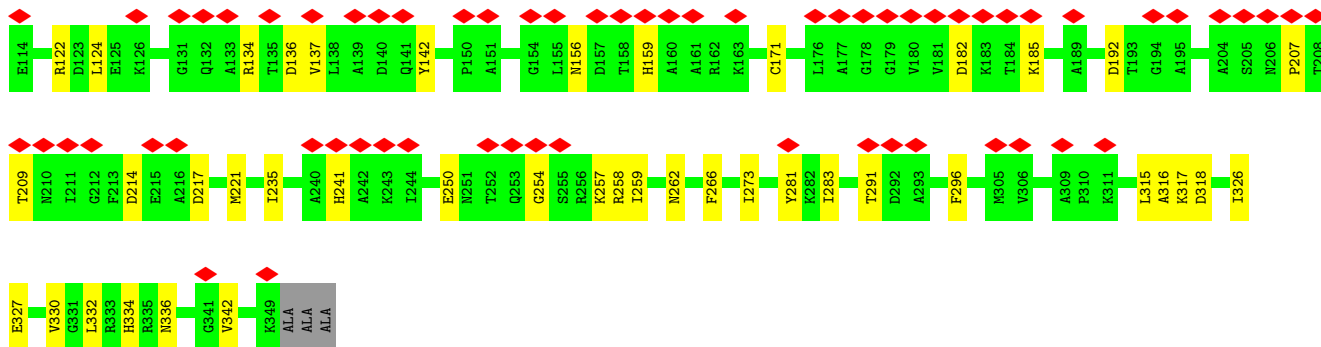

• Molecule 1: Major head protein

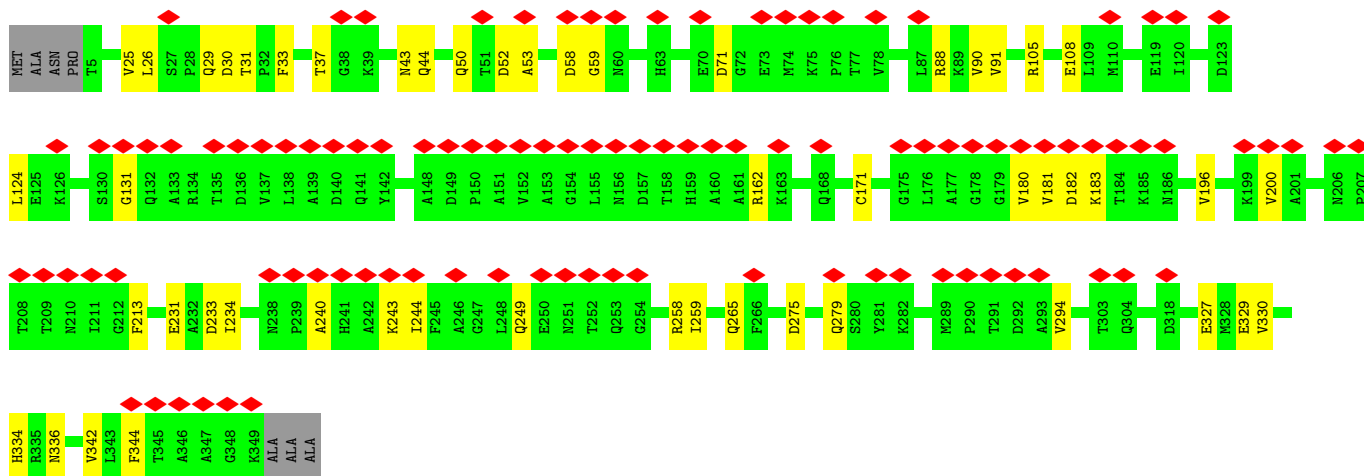
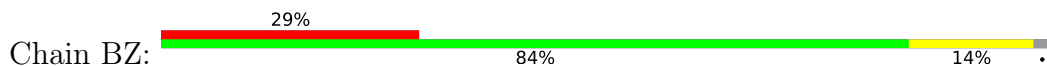

• Molecule 1: Major head protein

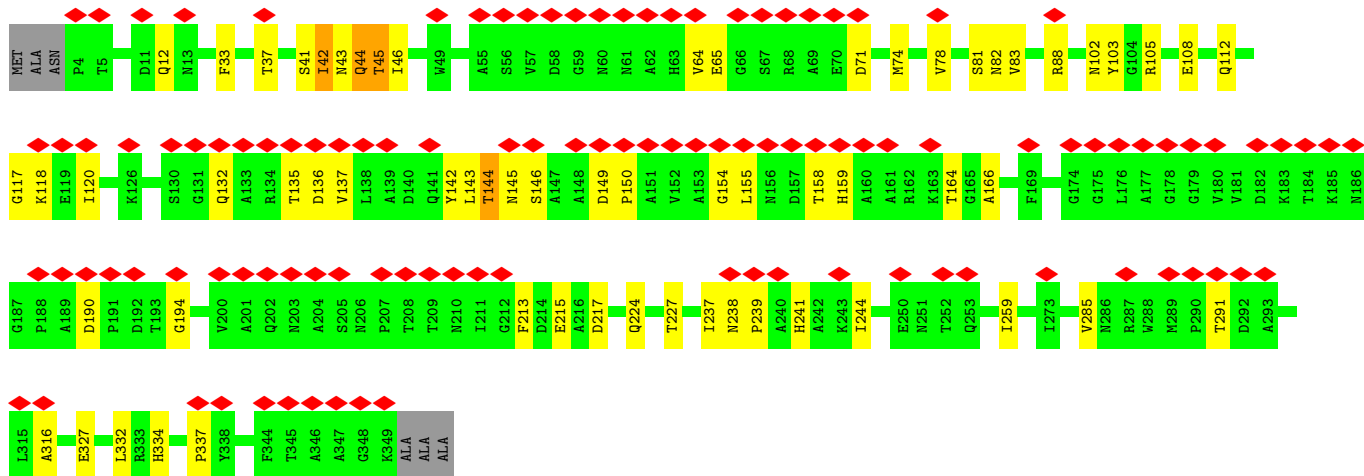
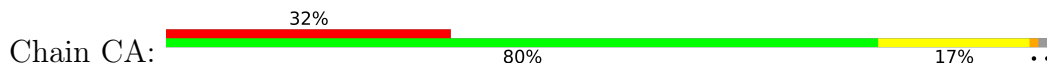

• Molecule 1: Major head protein

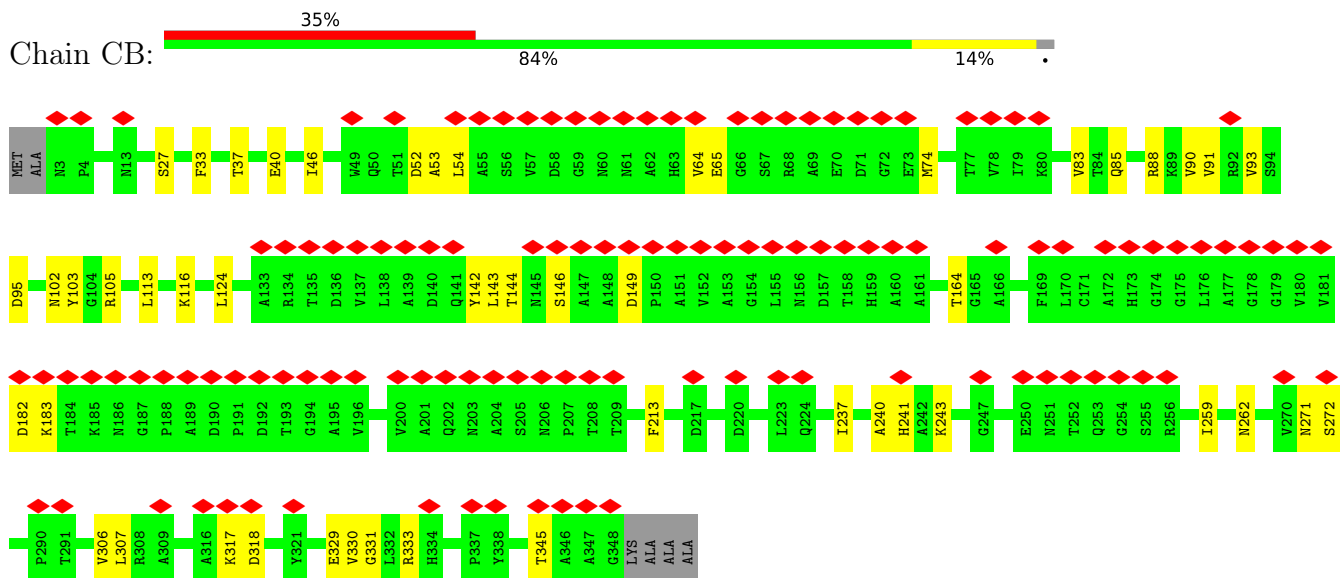

• Molecule 1: Major head protein

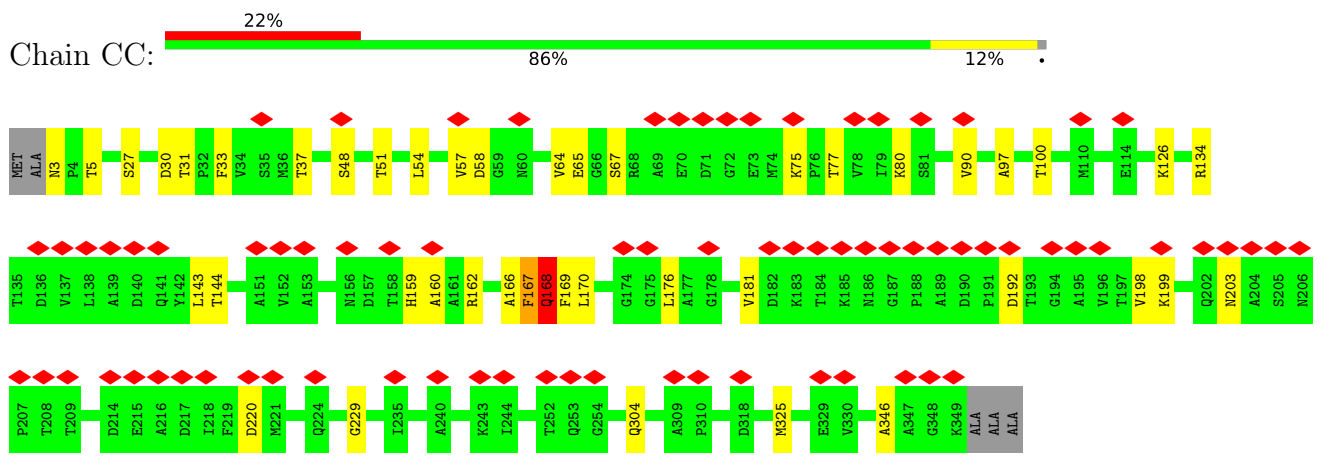

• Molecule 1: Major head protein

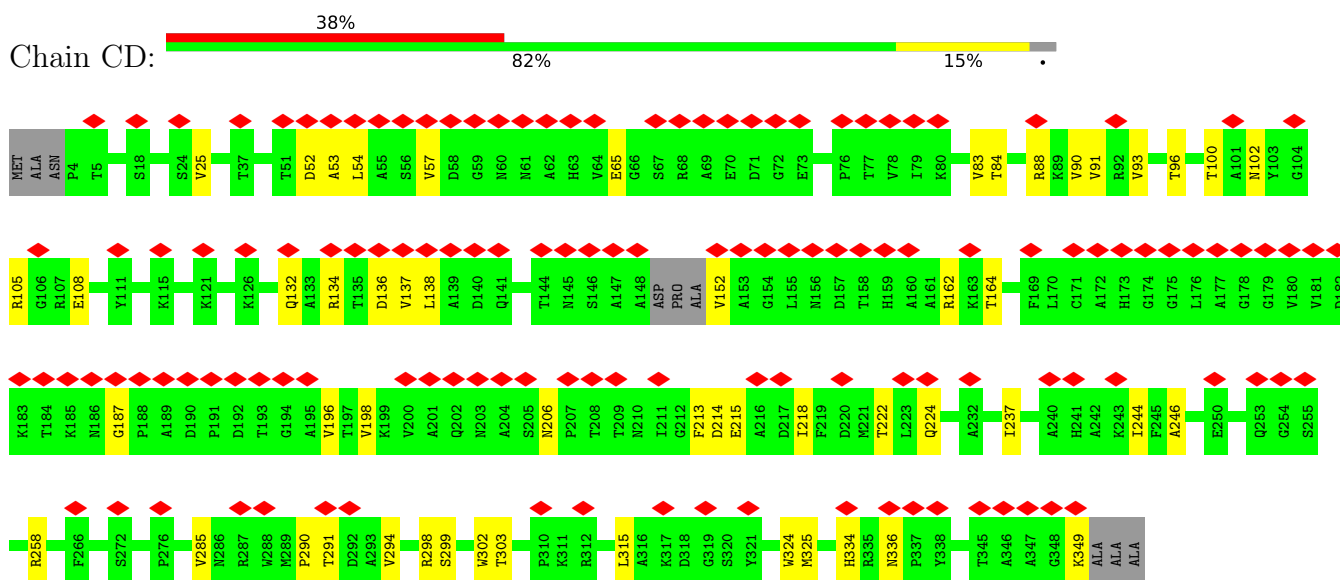

• Molecule 1: Major head protein

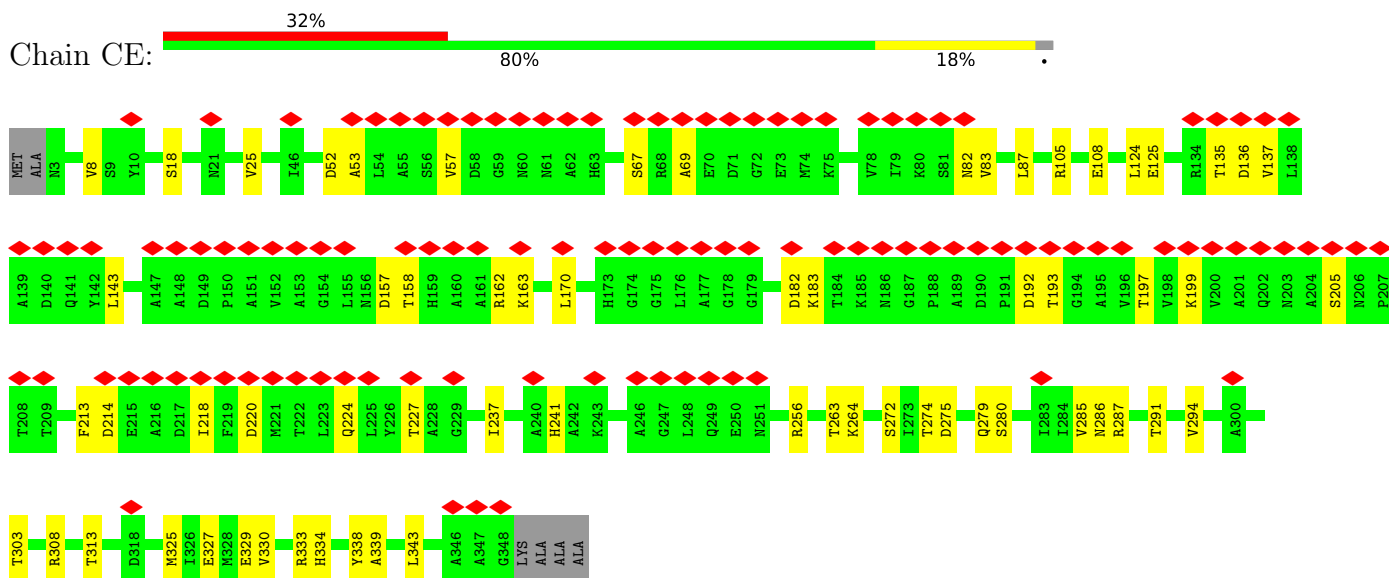

• Molecule 1: Major head protein

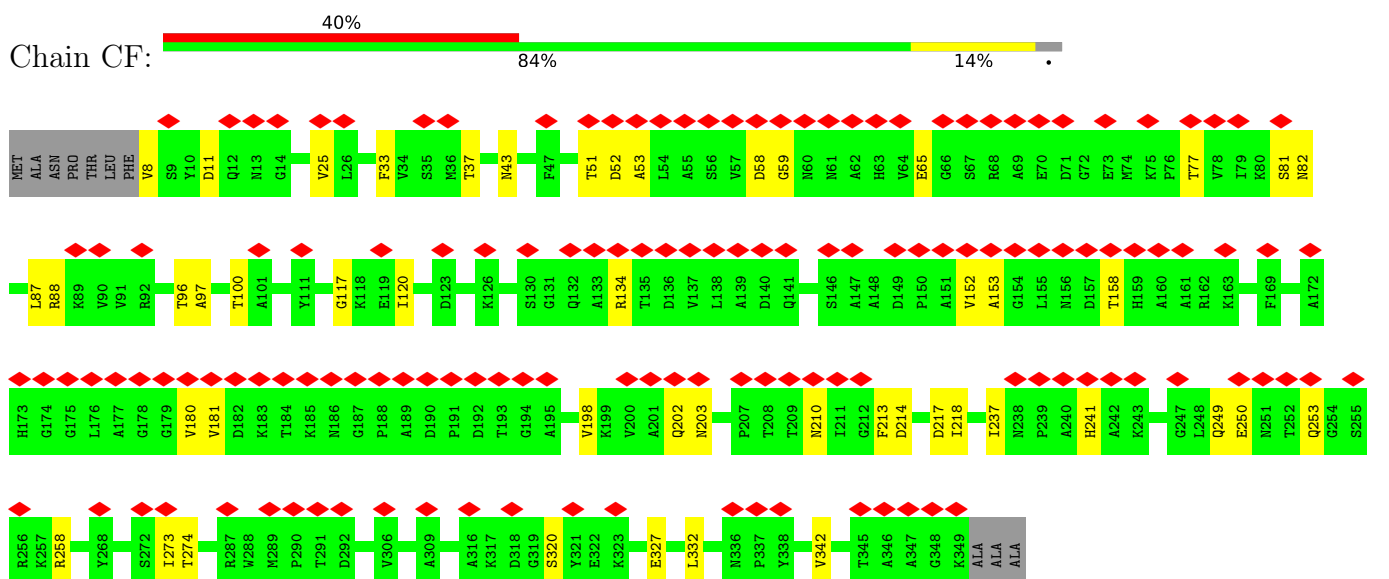

• Molecule 1: Major head protein

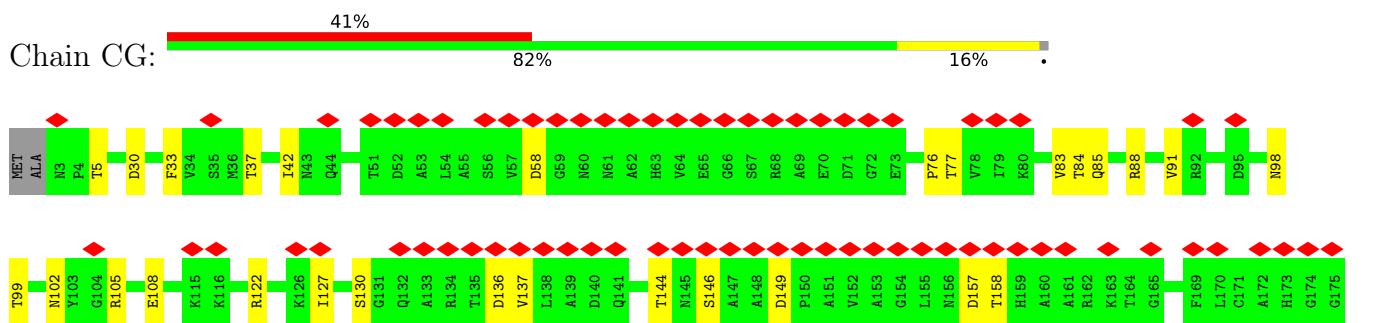

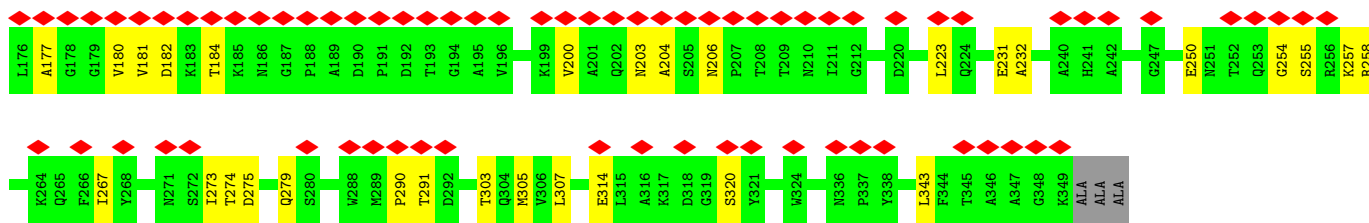

• Molecule 1: Major head protein

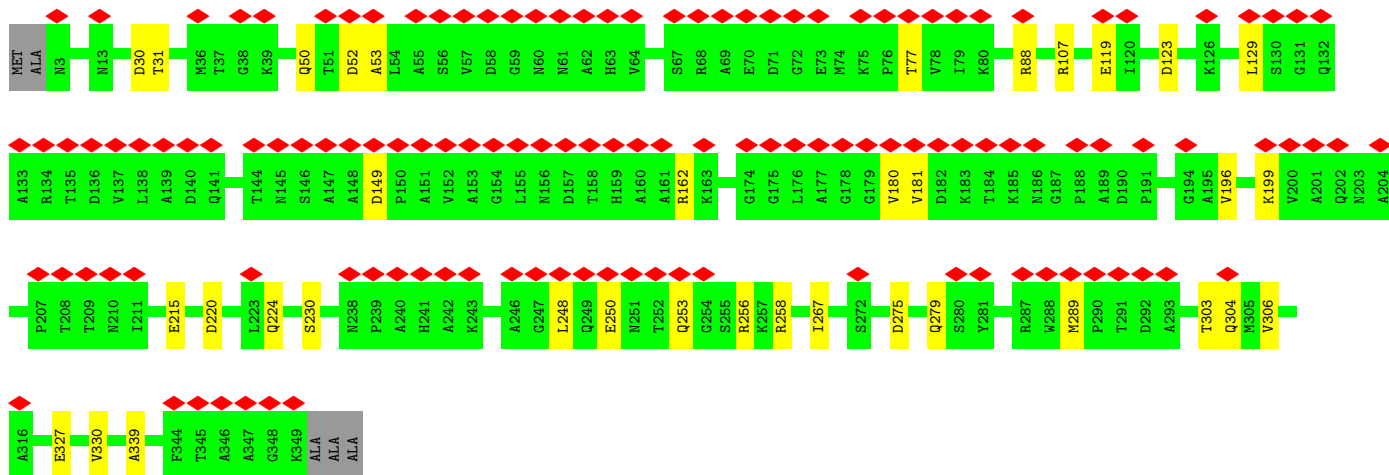
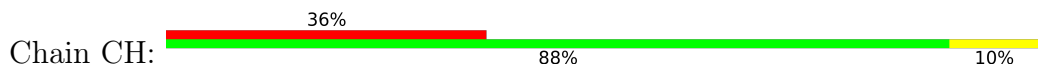

• Molecule 1: Major head protein

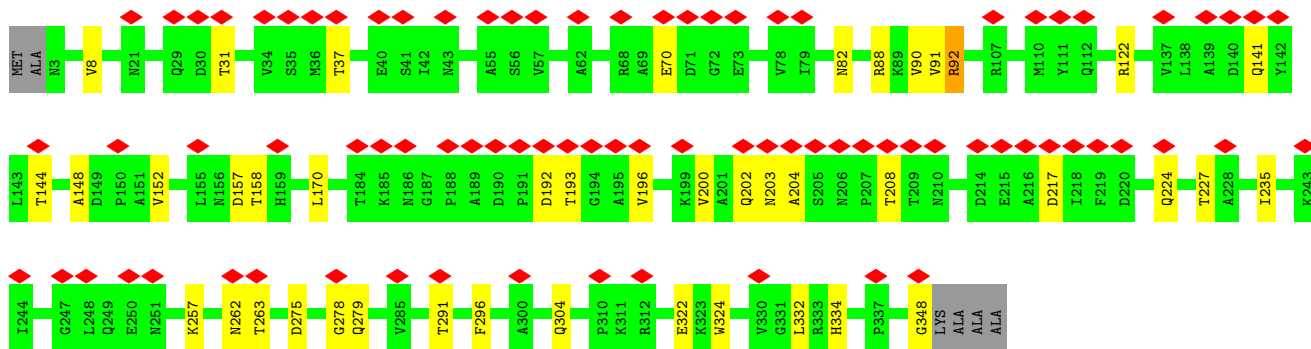
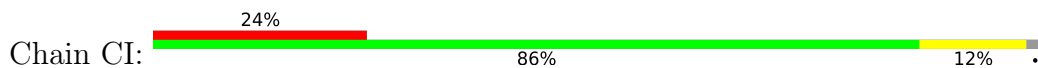

• Molecule 1: Major head protein

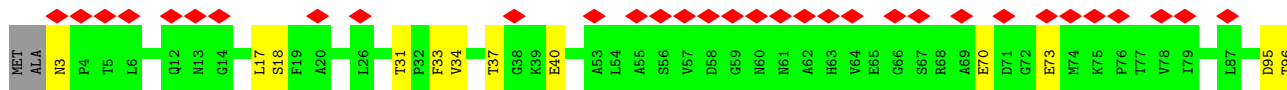
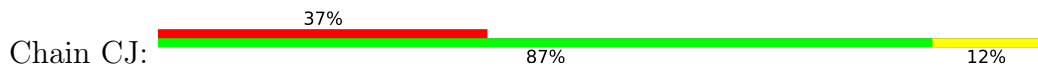

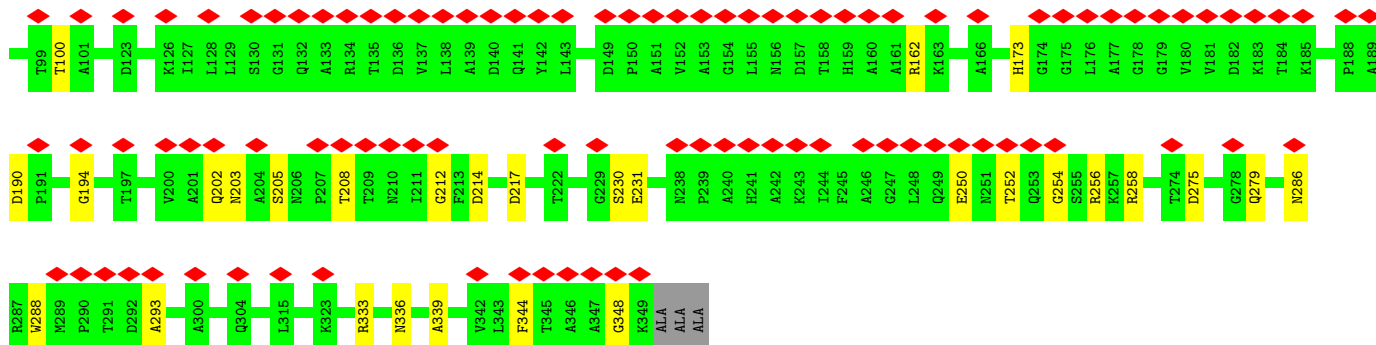

• Molecule 1: Major head protein

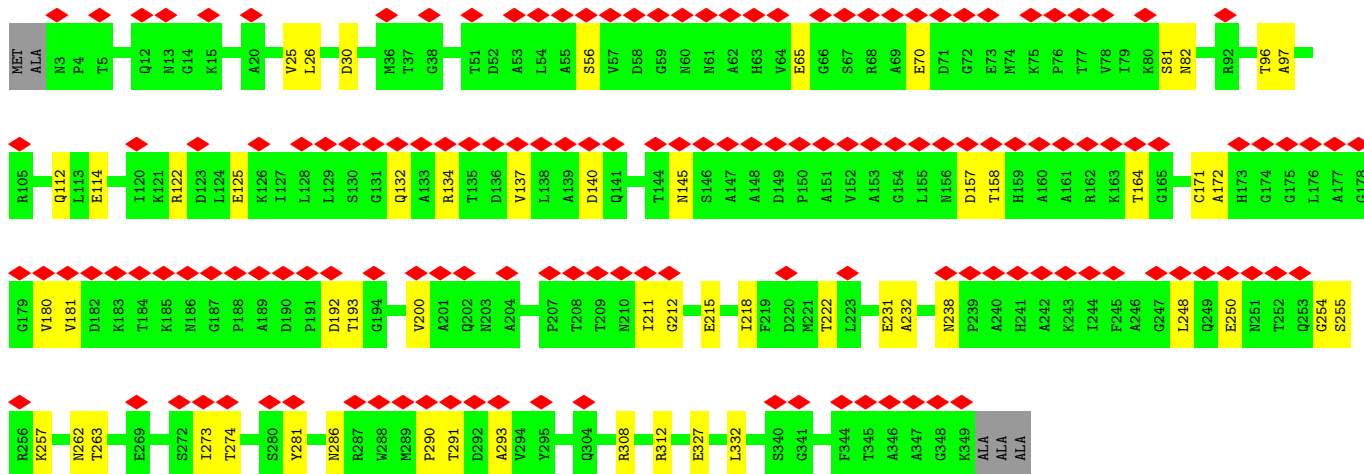
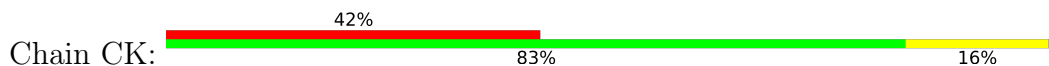

• Molecule 1: Major head protein

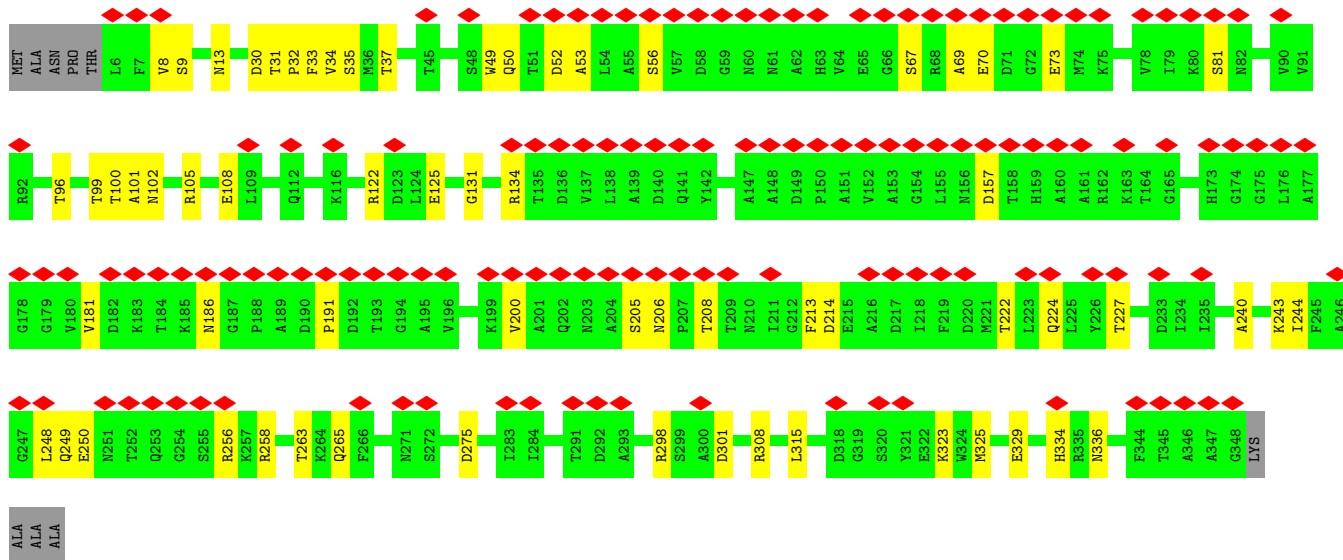
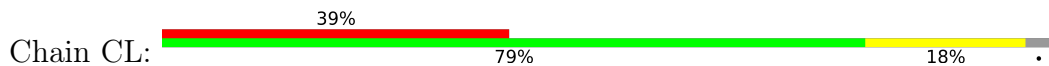

• Molecule 1: Major head protein

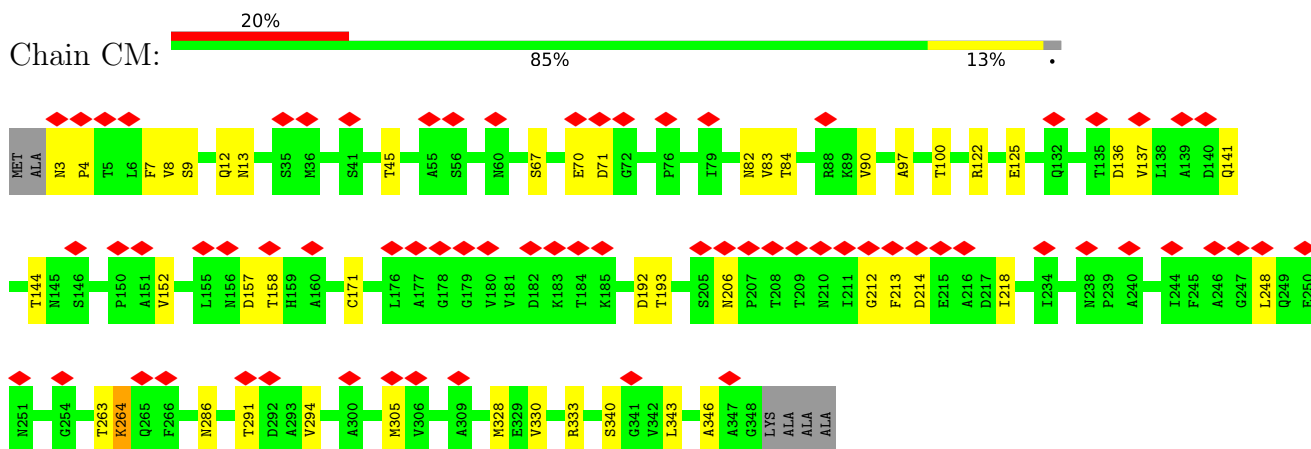

• Molecule 1: Major head protein

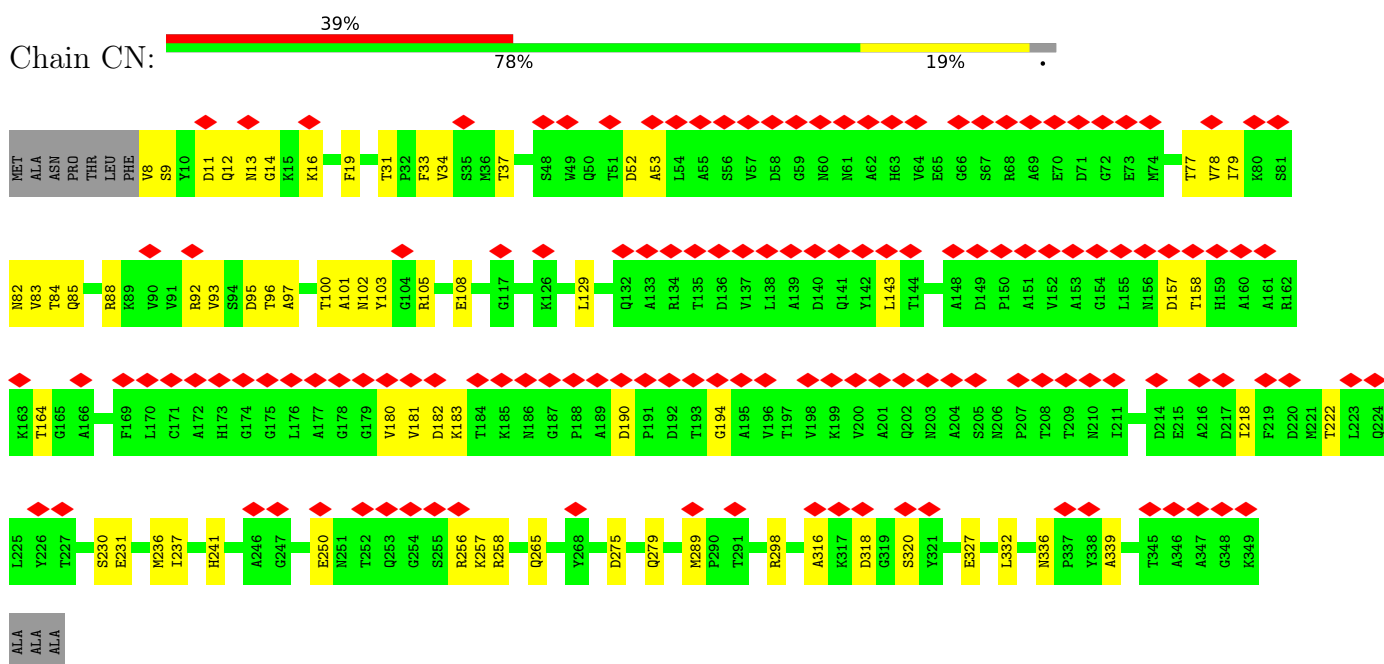

• Molecule 1: Major head protein

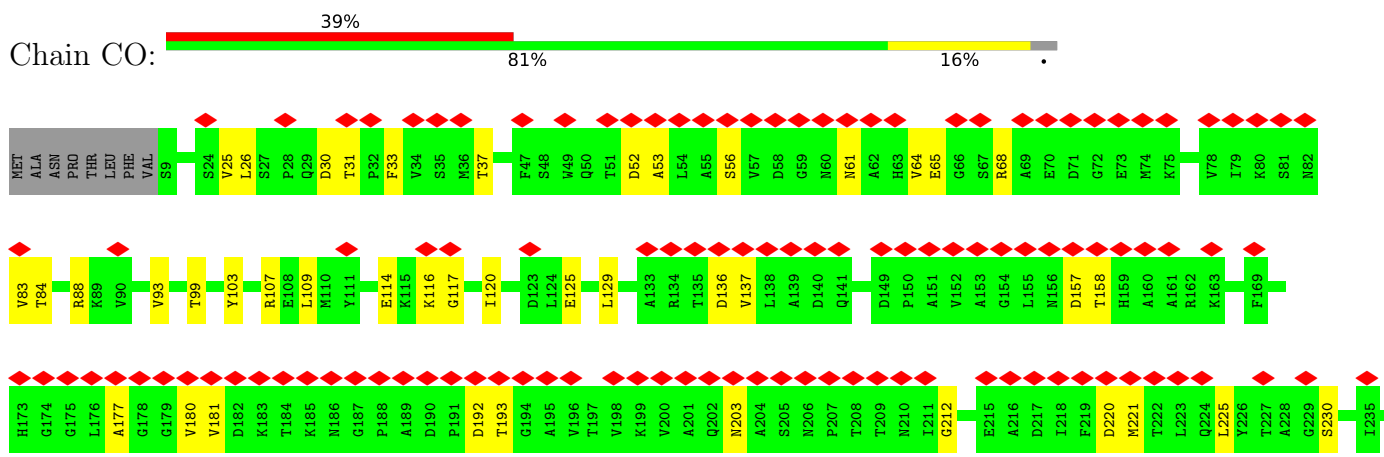

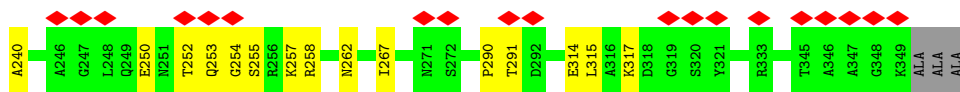

• Molecule 1: Major head protein

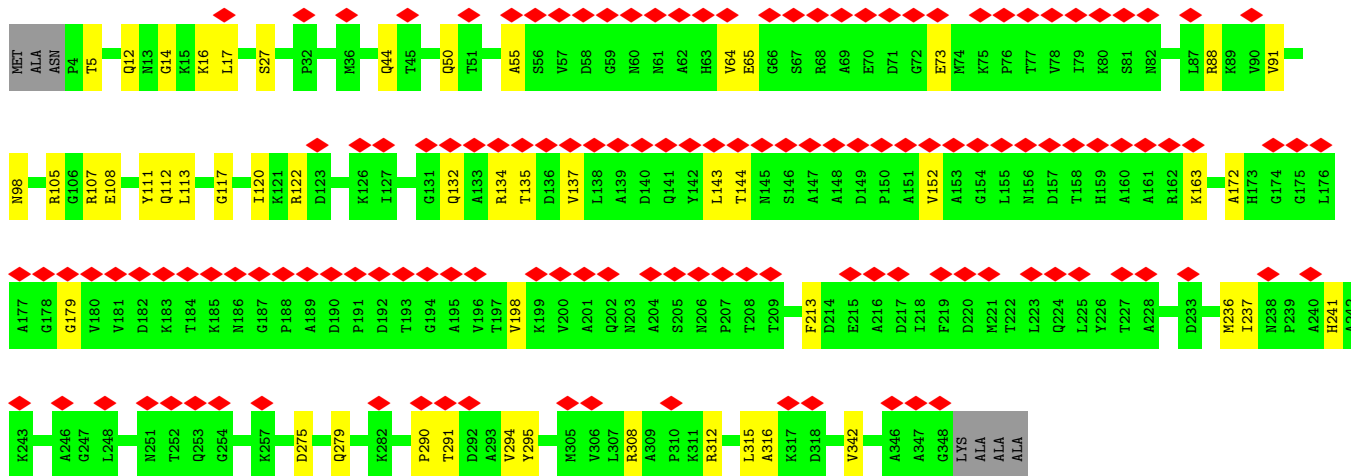
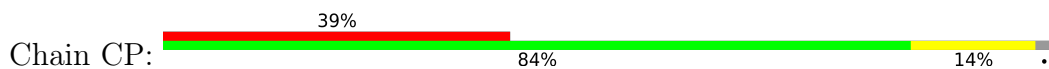

• Molecule 1: Major head protein

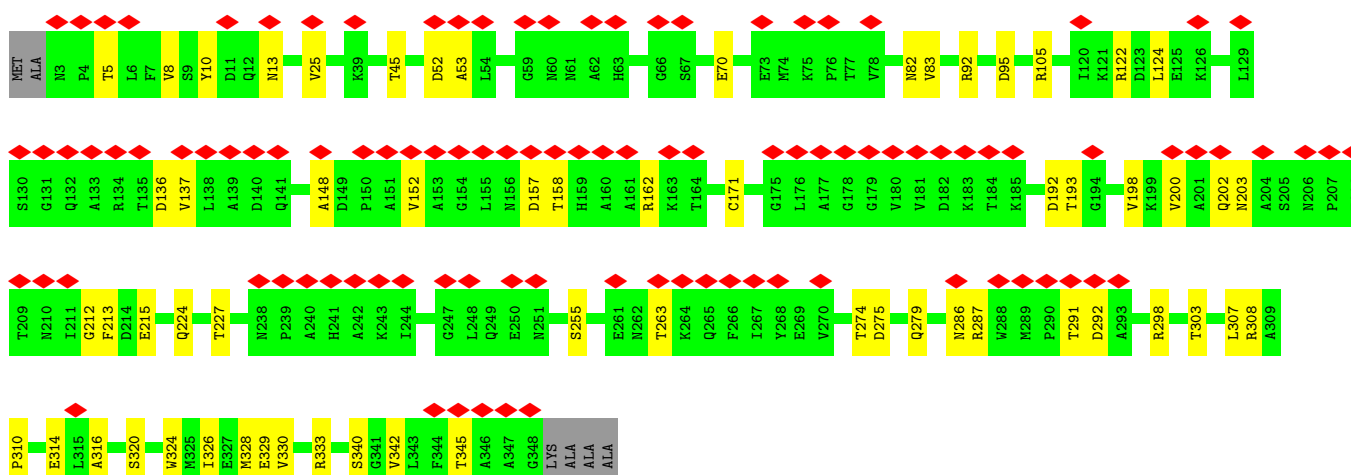
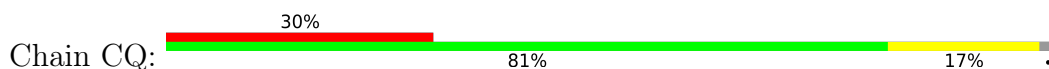

• Molecule 1: Major head protein

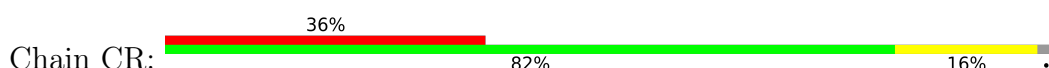

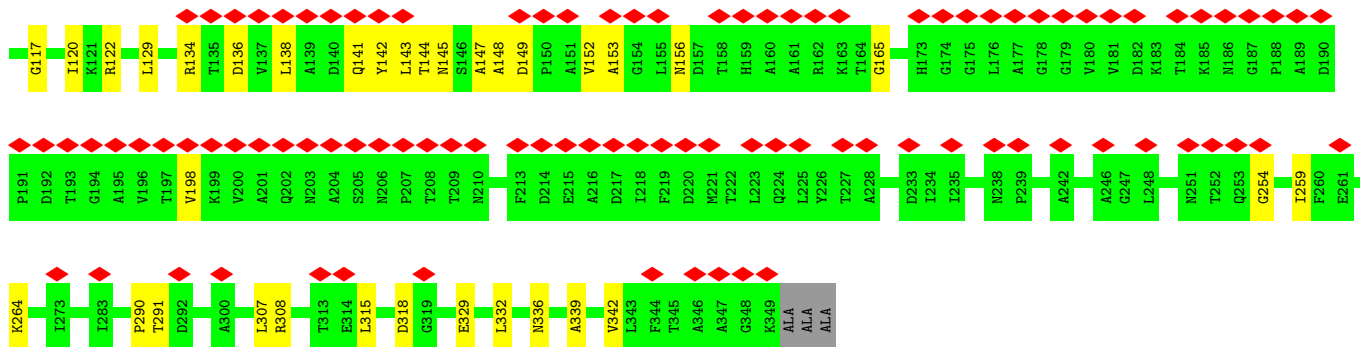

• Molecule 1: Major head protein

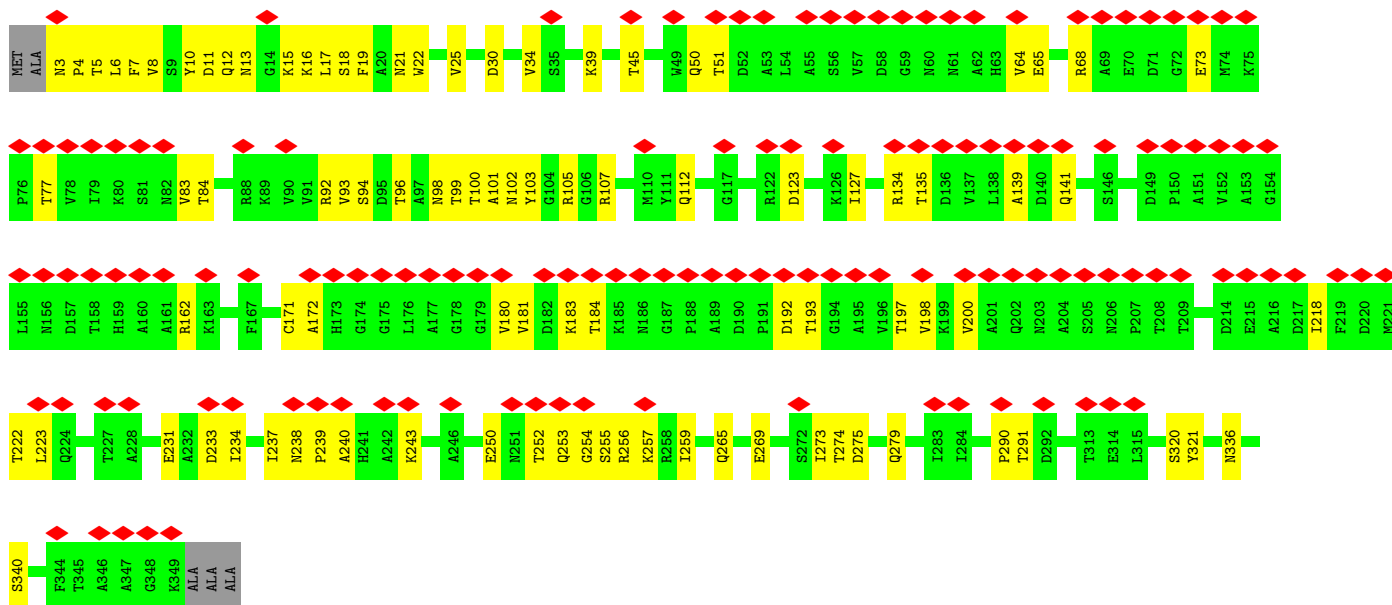
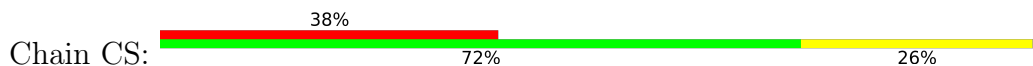

• Molecule 1: Major head protein

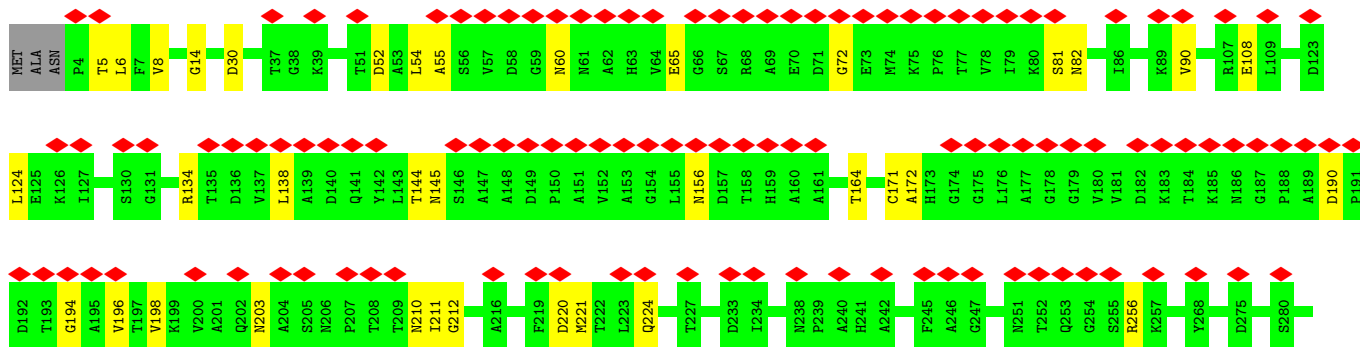
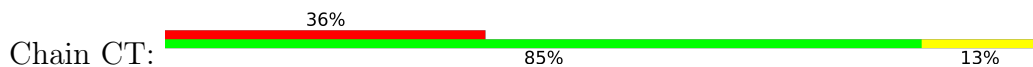

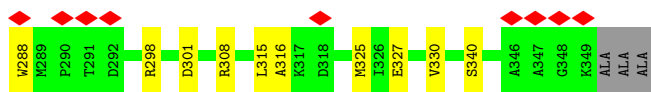

• Molecule 1: Major head protein

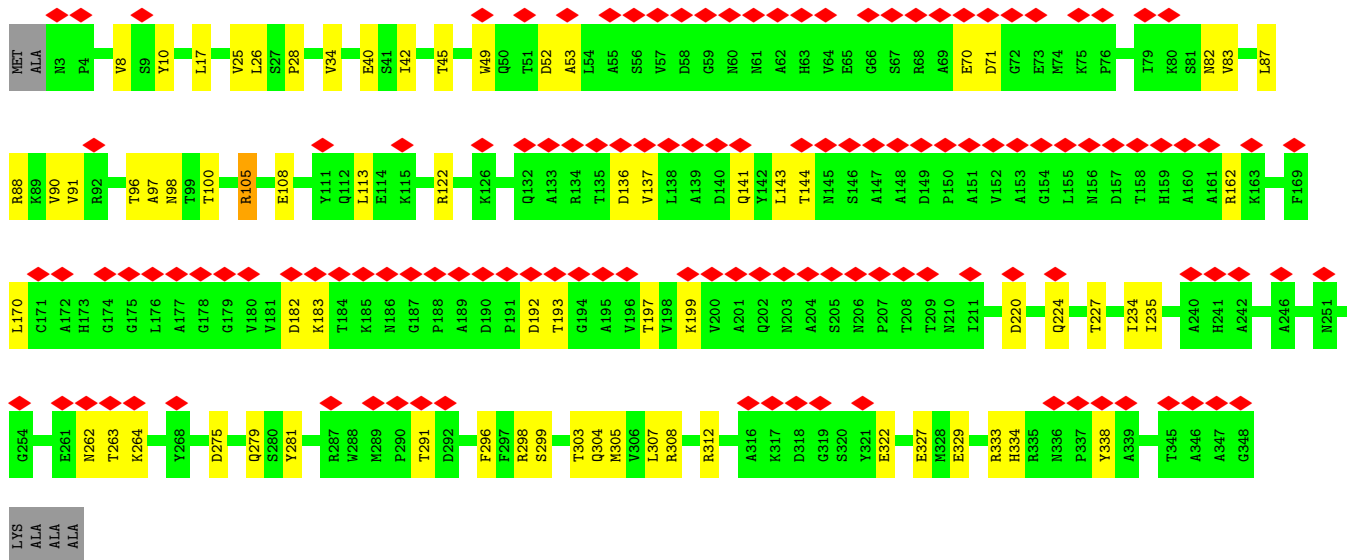
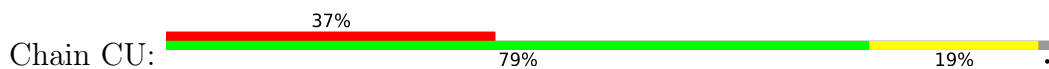

• Molecule 1: Major head protein

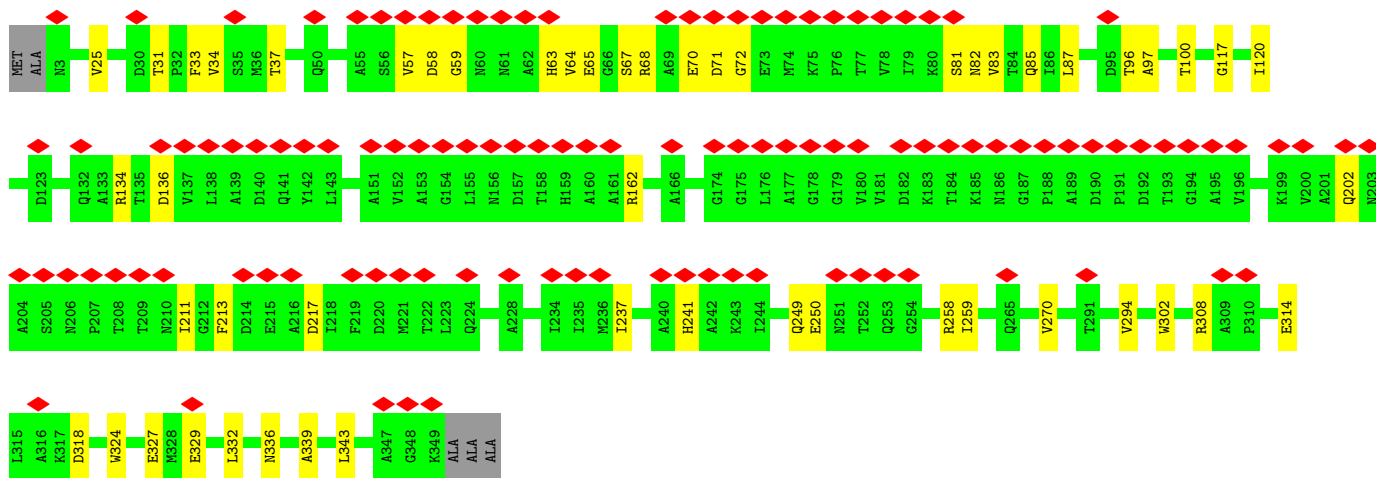
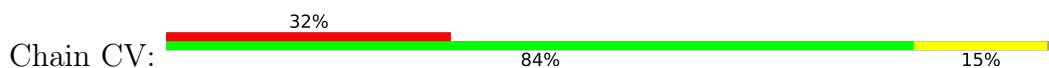

• Molecule 1: Major head protein

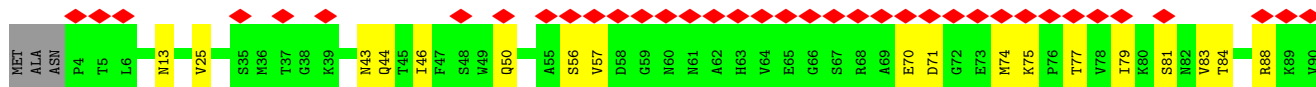
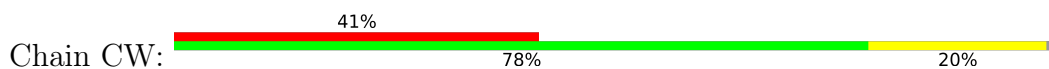

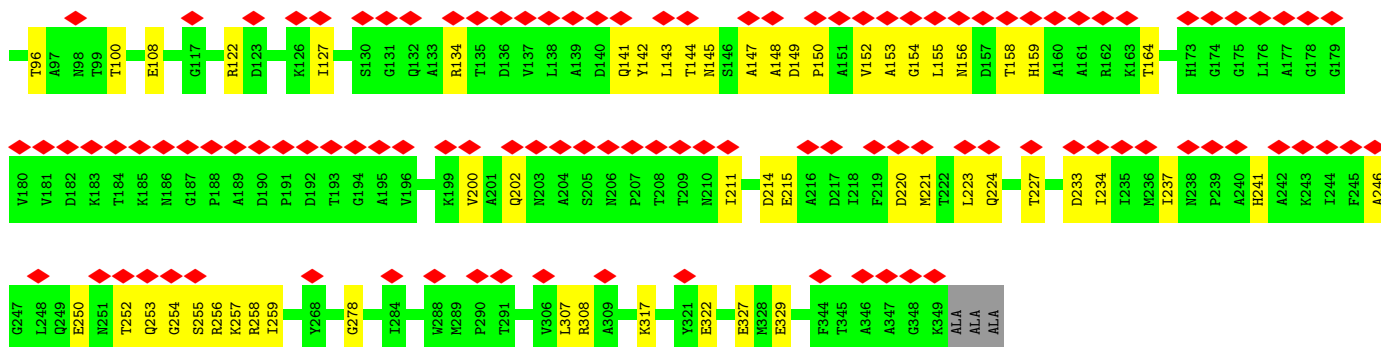

• Molecule 1: Major head protein

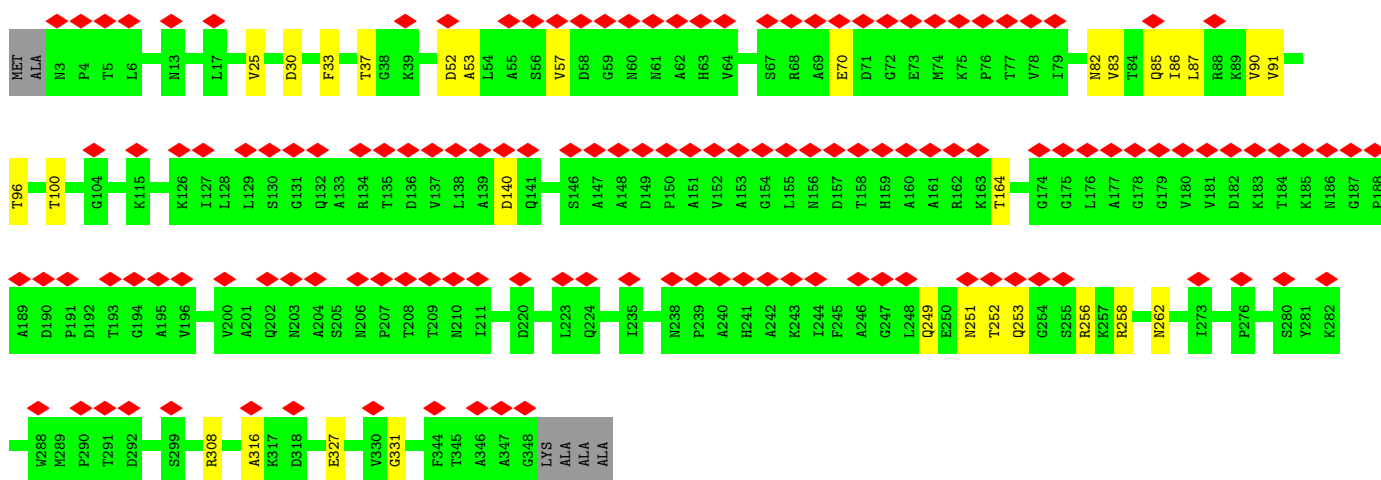
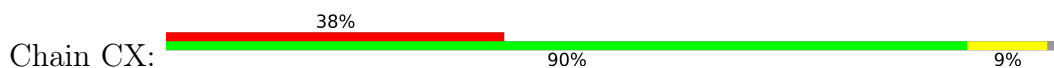

• Molecule 1: Major head protein

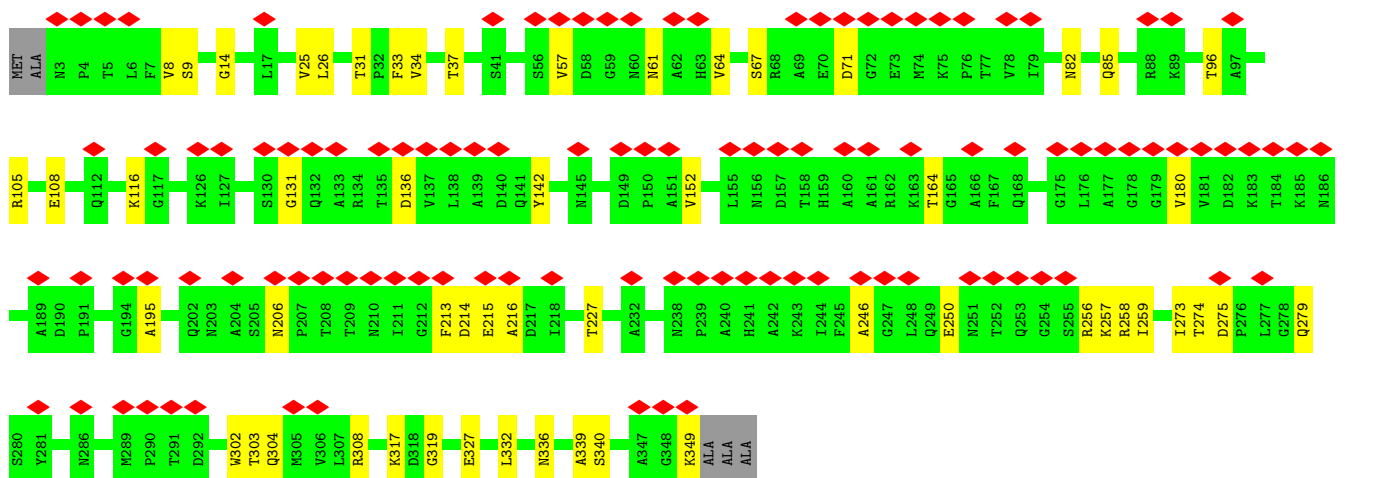
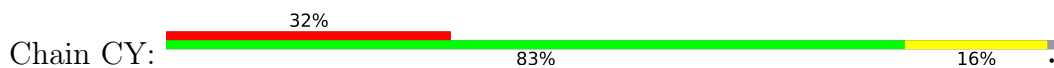

• Molecule 1: Major head protein

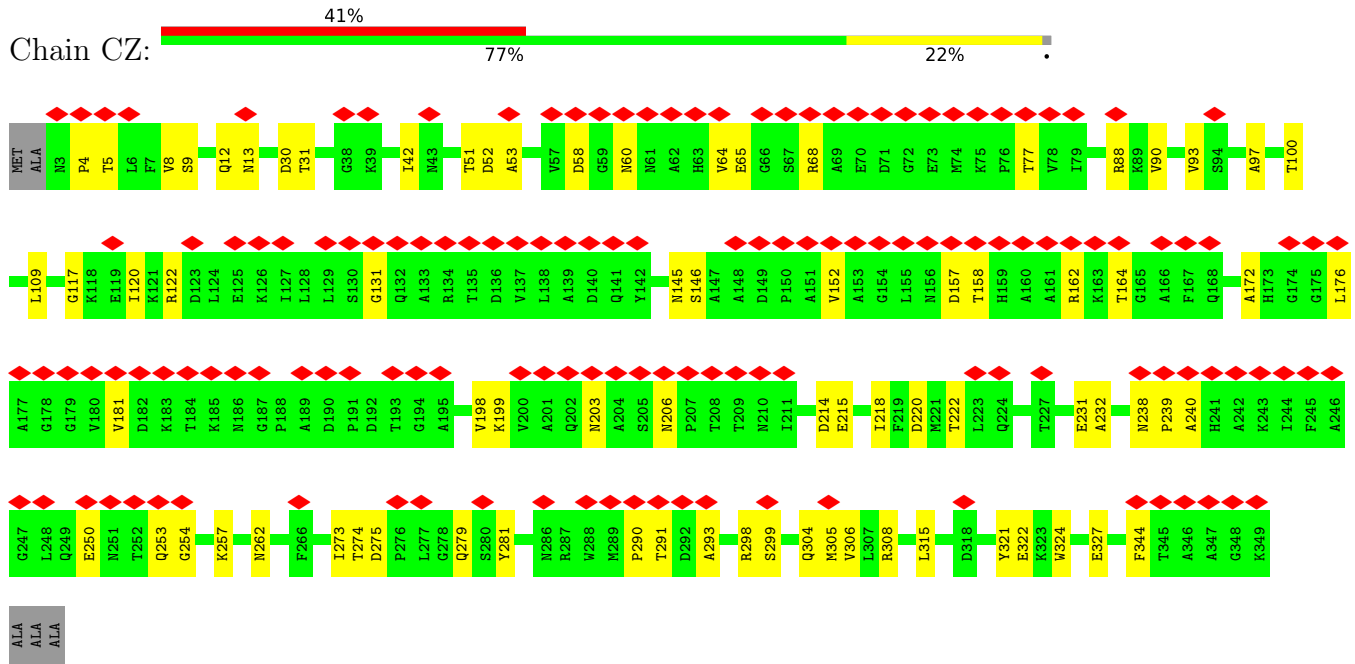

• Molecule 1: Major head protein

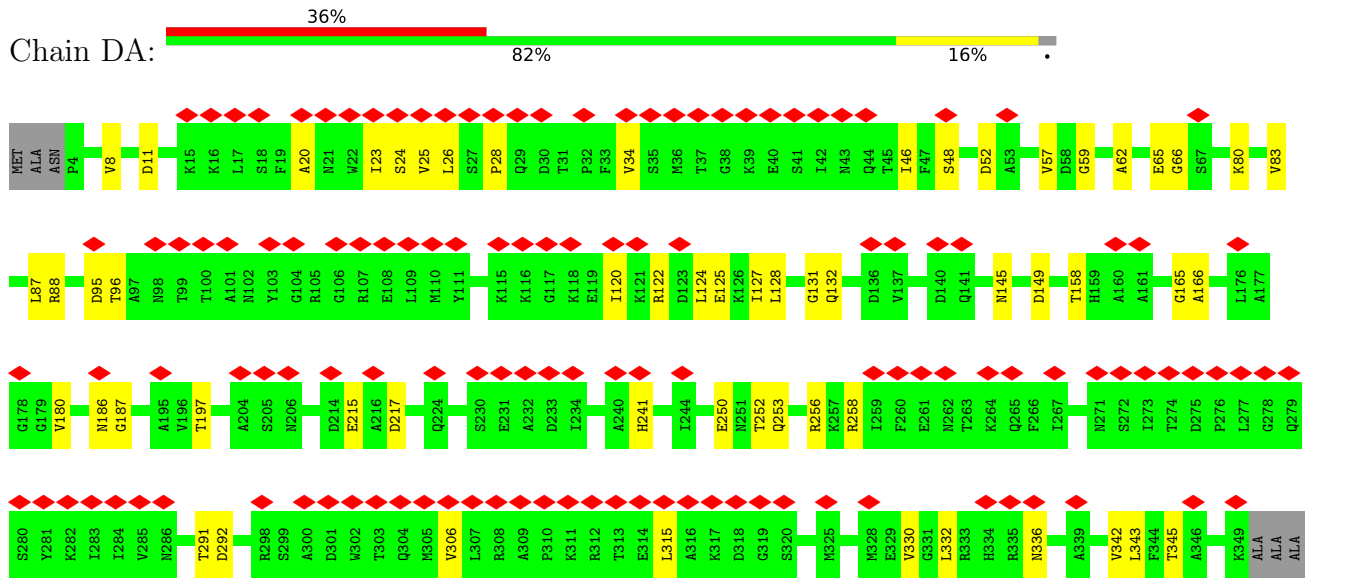

• Molecule 1: Major head protein

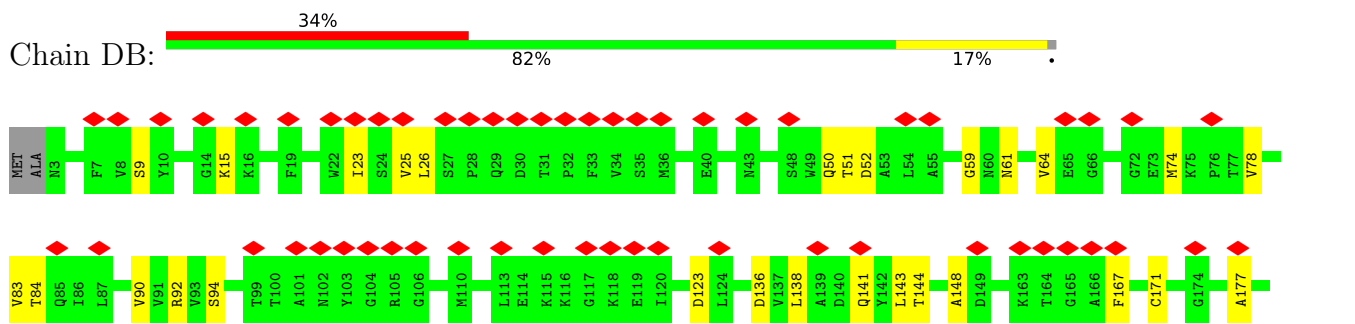

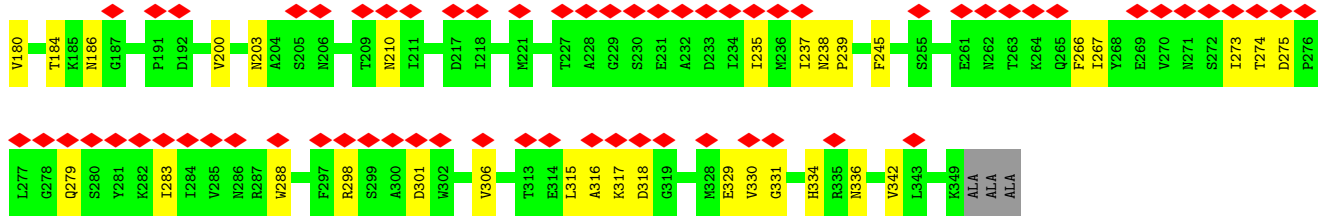

• Molecule 1: Major head protein

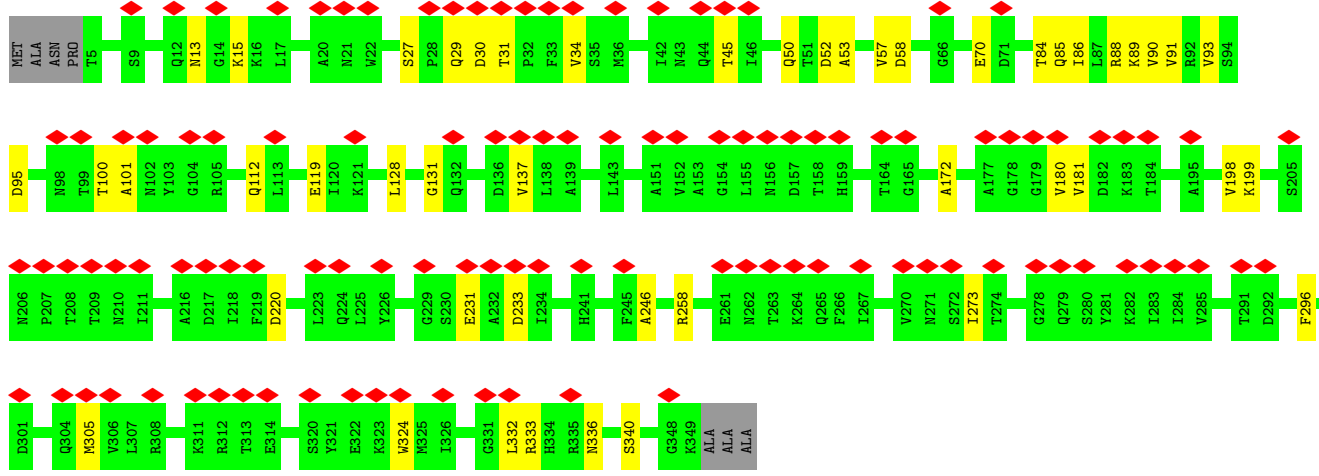
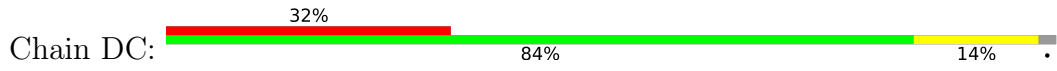

• Molecule 1: Major head protein

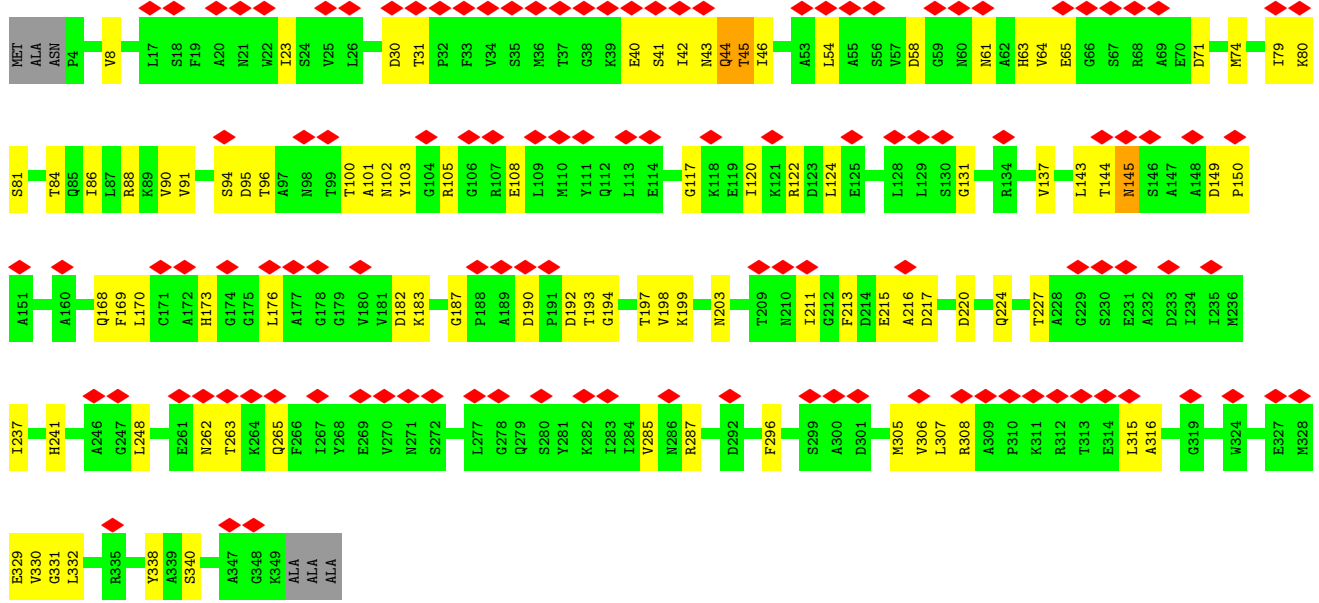
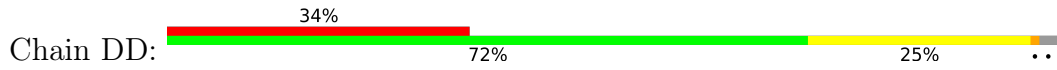

• Molecule 1: Major head protein

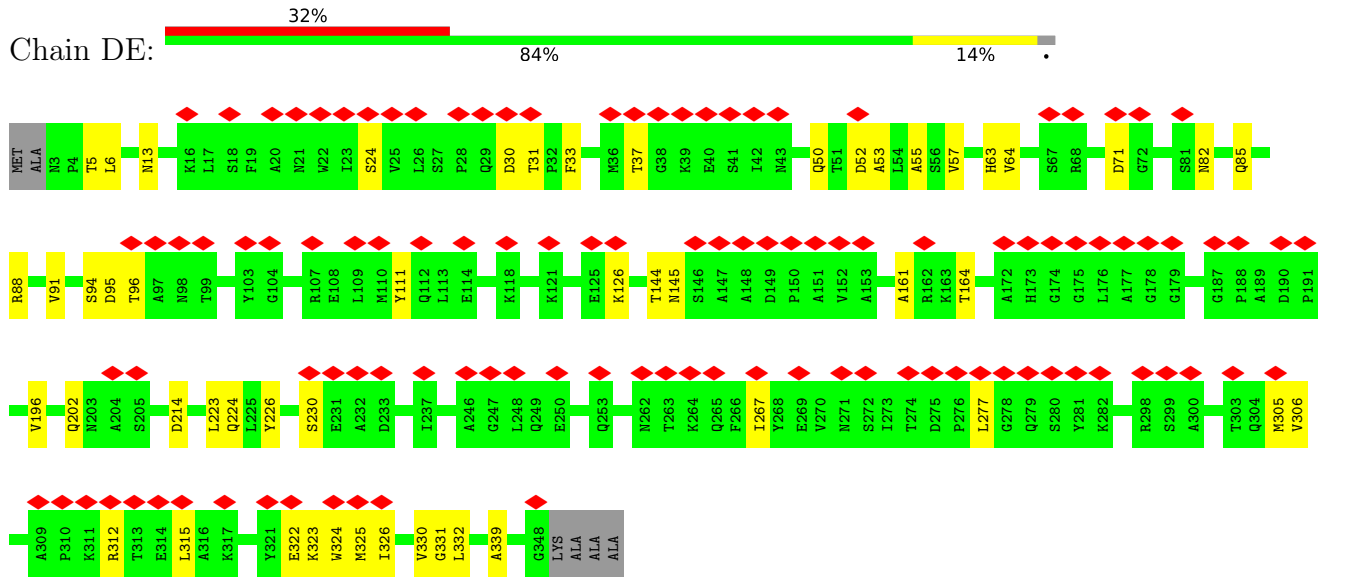

• Molecule 1: Major head protein

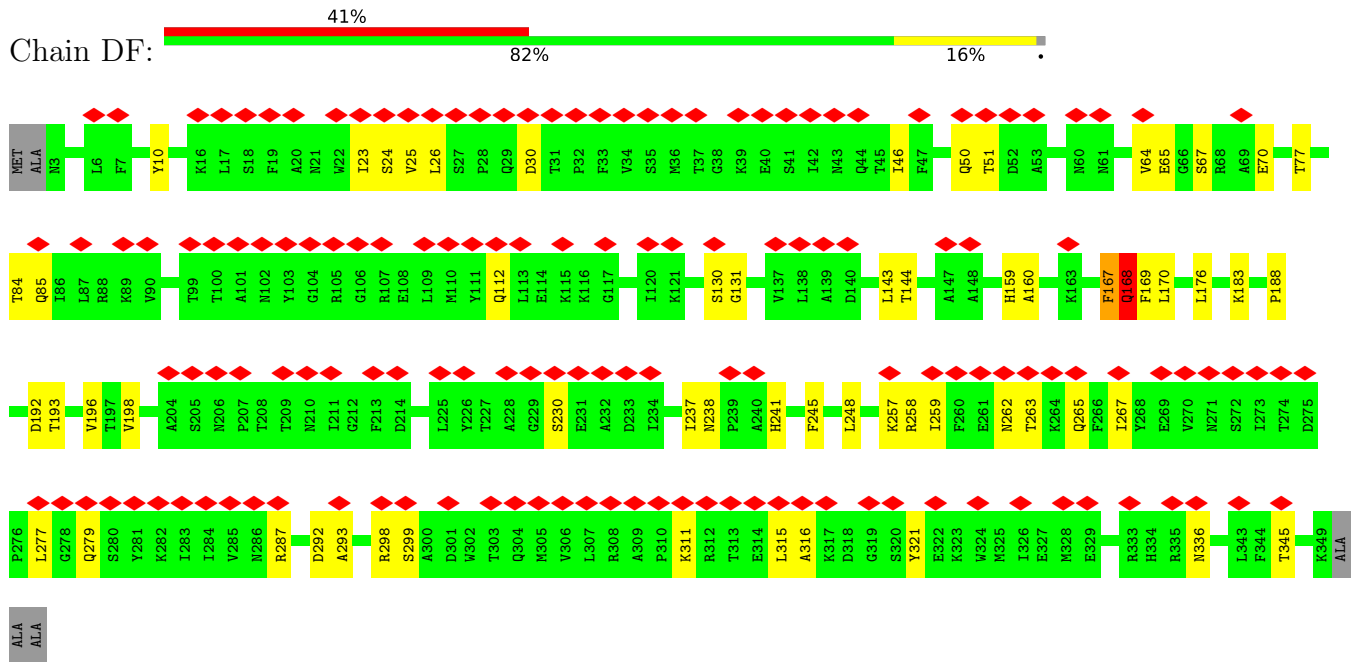

• Molecule 1: Major head protein

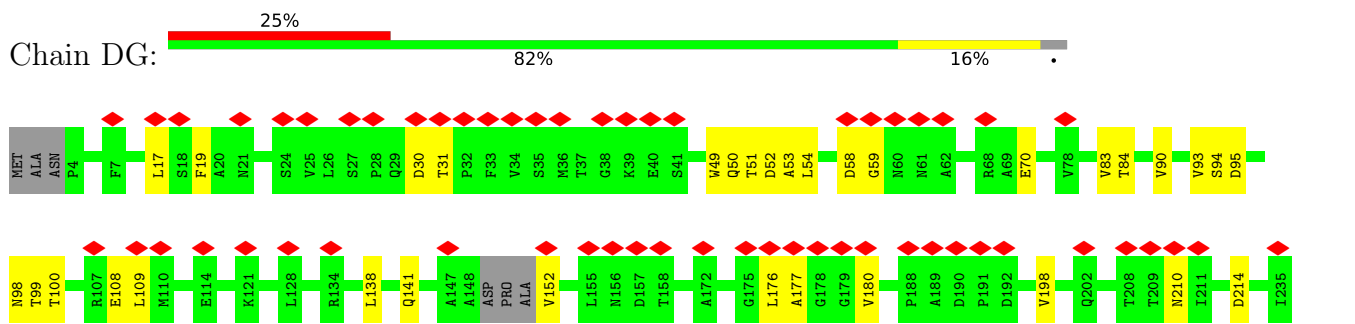

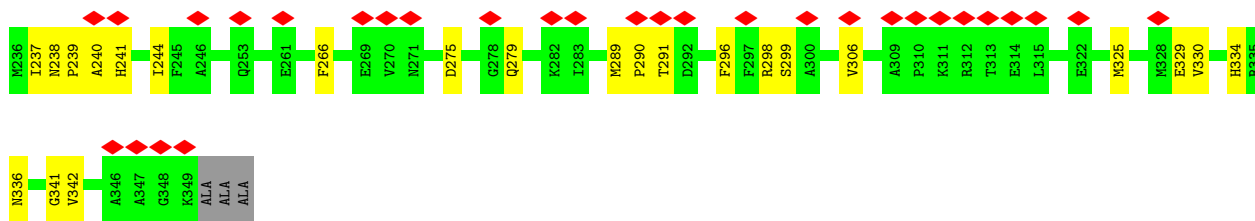

• Molecule 1: Major head protein

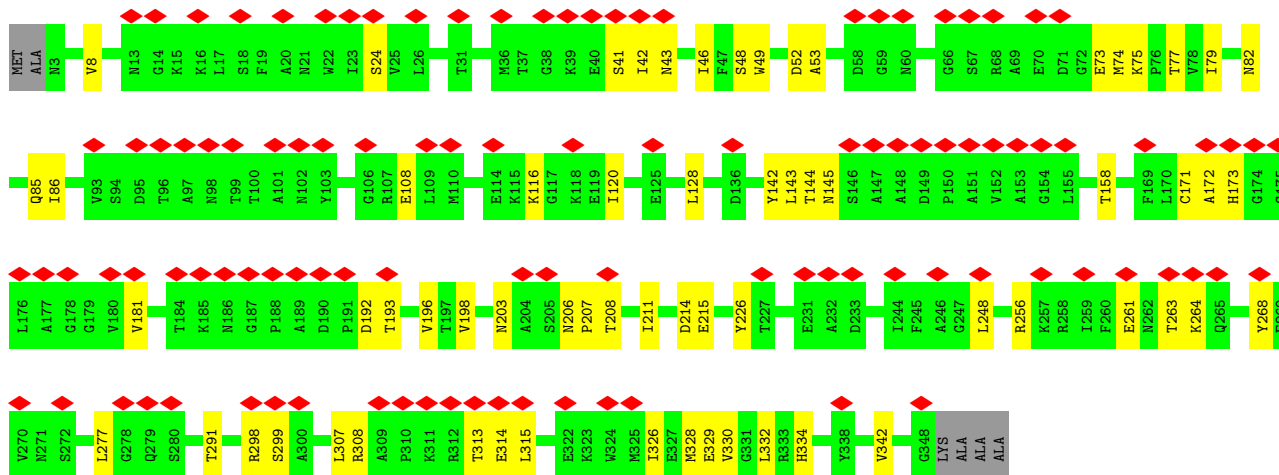
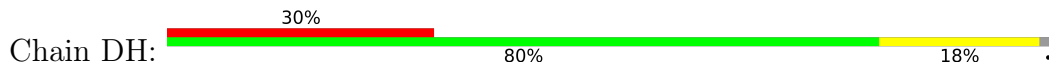

• Molecule 1: Major head protein

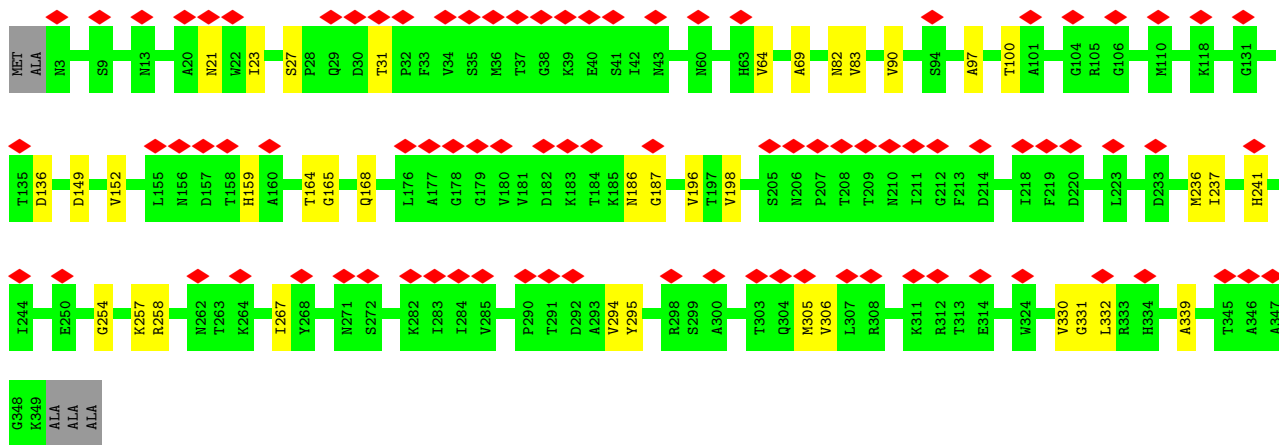
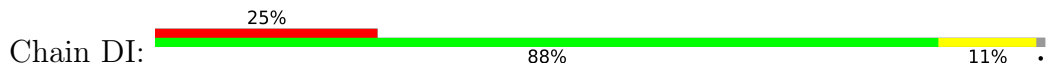

• Molecule 1: Major head protein

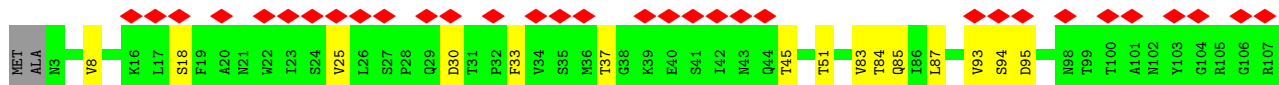
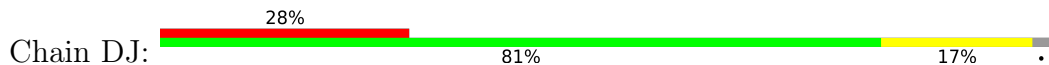

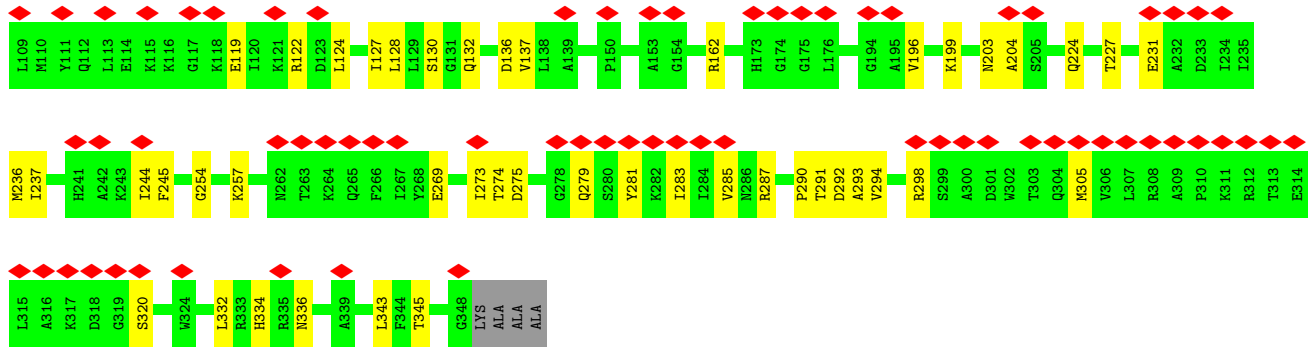

• Molecule 1: Major head protein

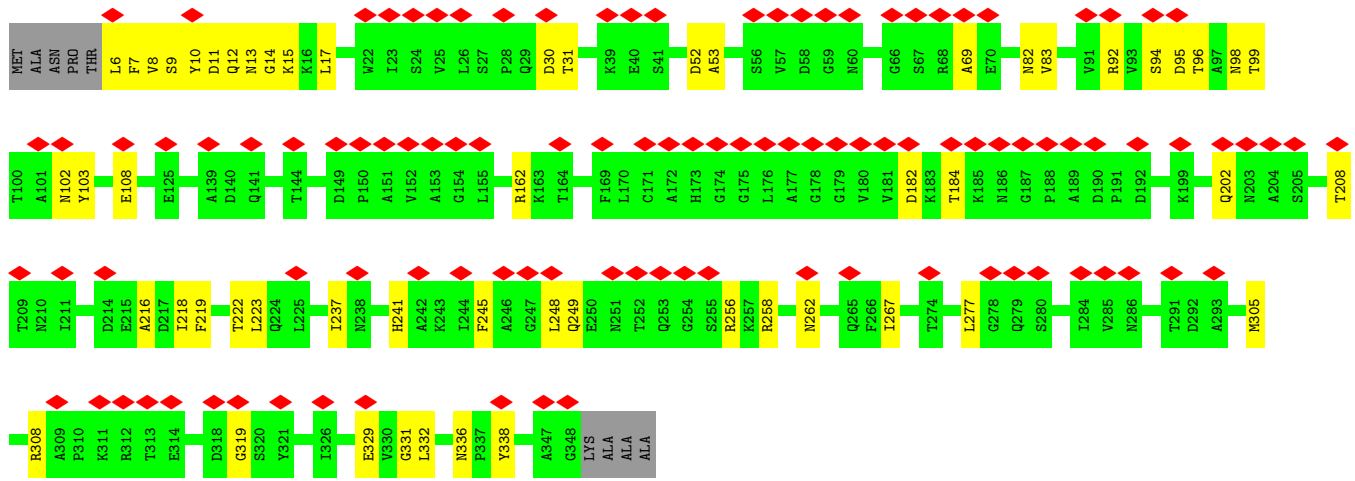
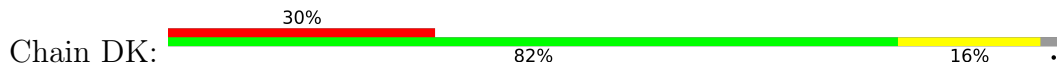

• Molecule 1: Major head protein

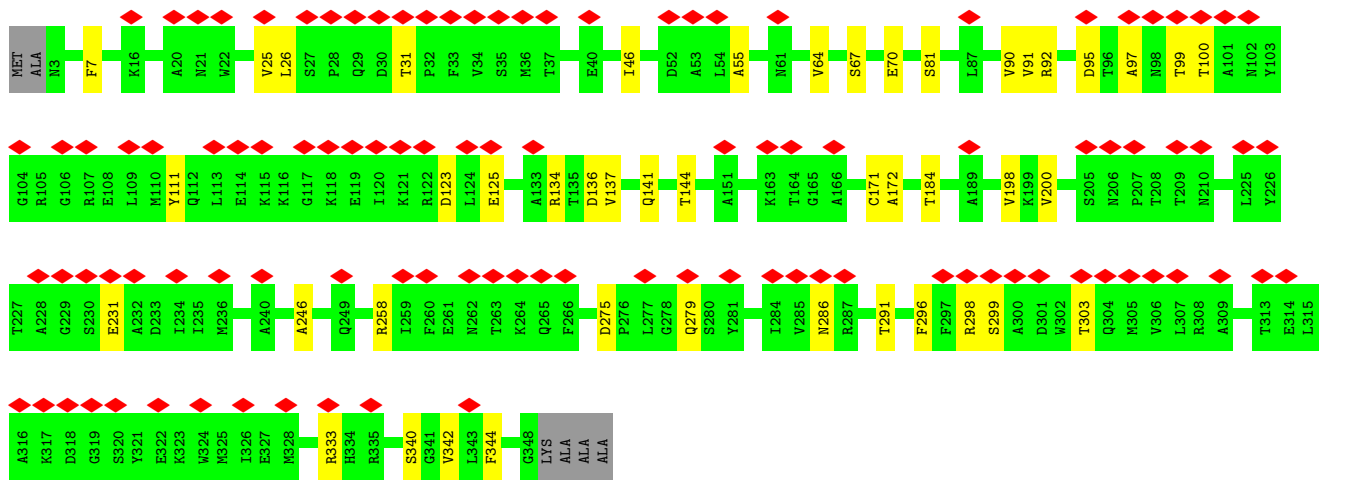
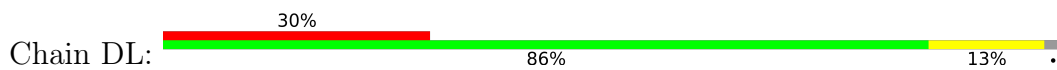

• Molecule 1: Major head protein

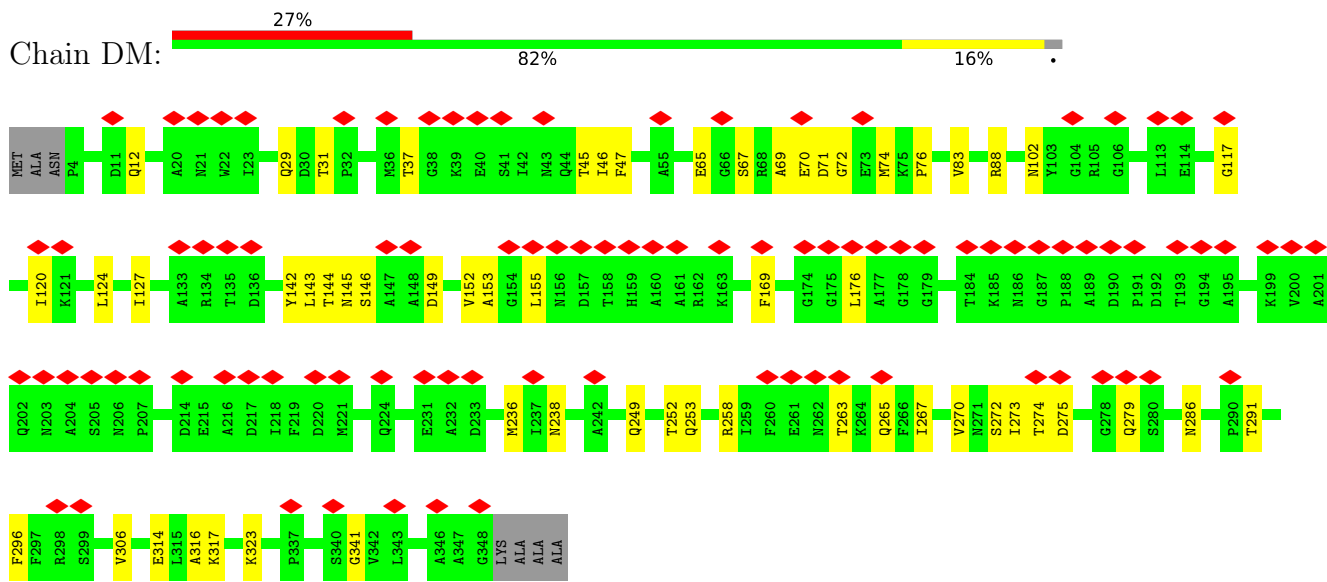

• Molecule 1: Major head protein

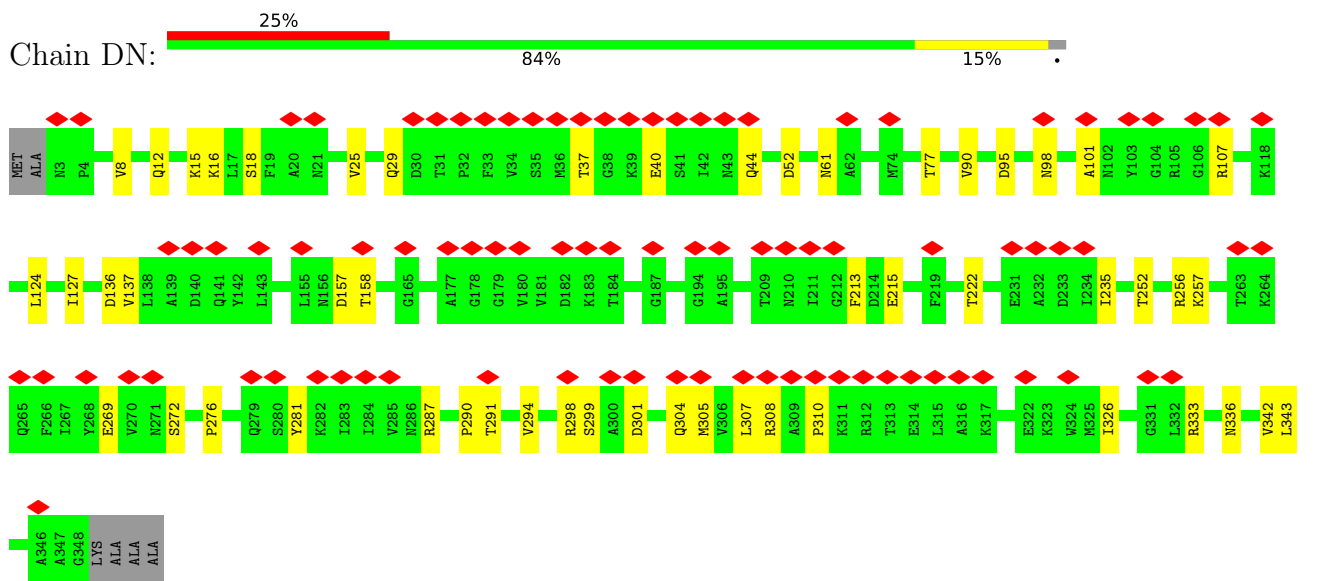

• Molecule 1: Major head protein

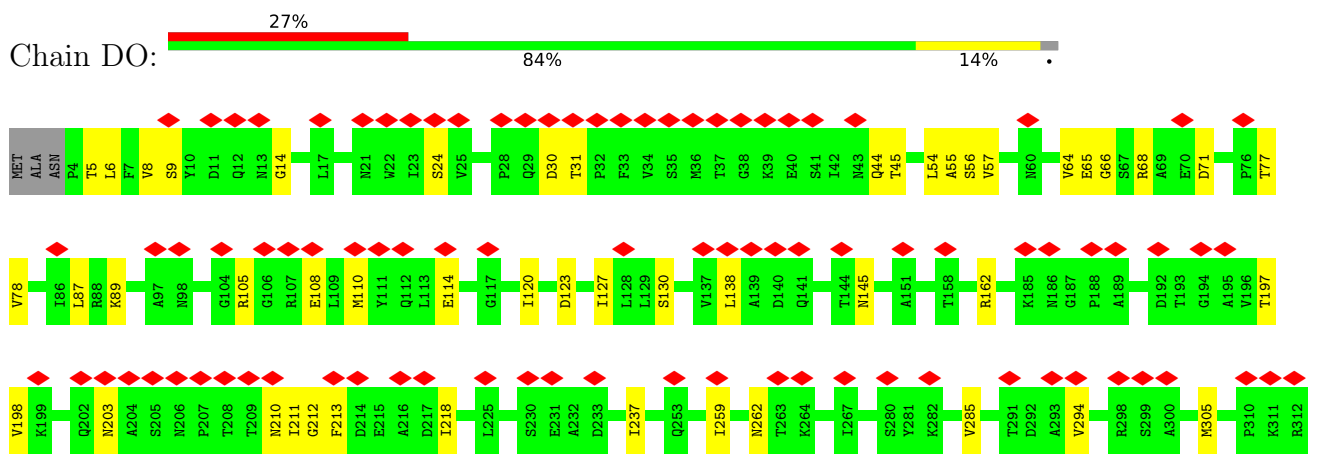

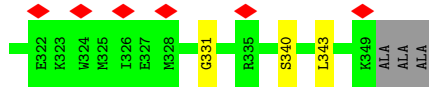

• Molecule 1: Major head protein

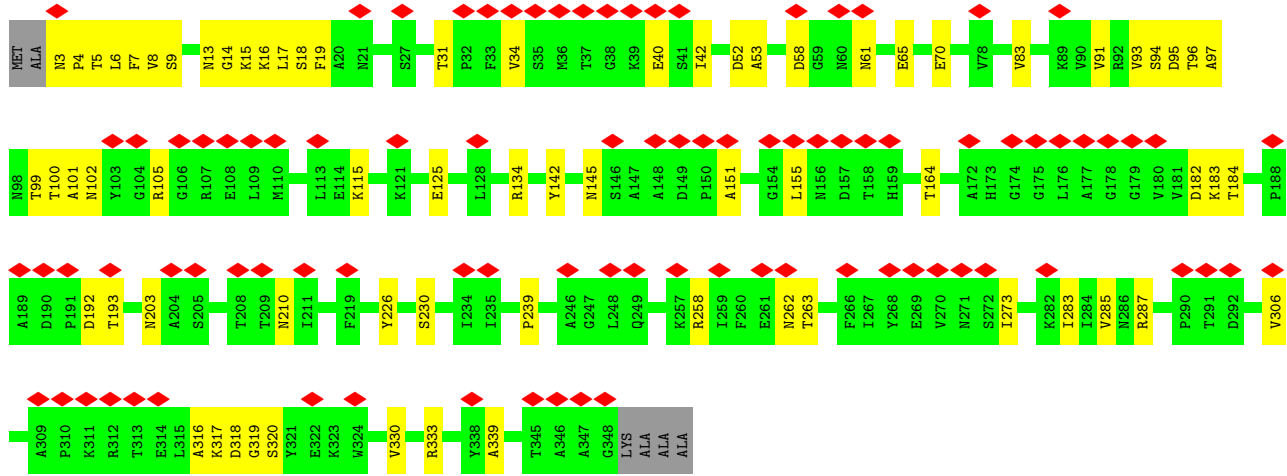
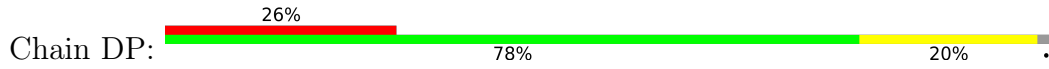

• Molecule 1: Major head protein

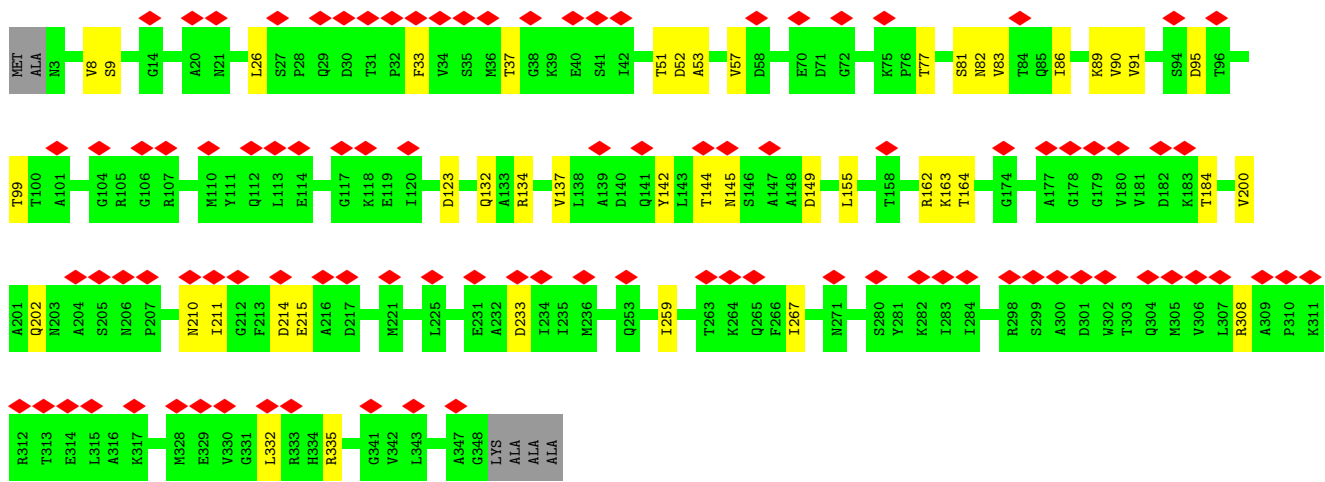
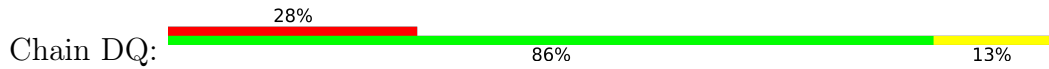

4 Experimental information

Property	Value	Source
EM reconstruction method	SINGLE PARTICLE	Depositor
Imposed symmetry	POINT, C5	Depositor
Number of particles used	9418	Depositor
Resolution determination method	FSC 0.143 CUT-OFF	Depositor
CTF correction method	PHASE FLIPPING AND AMPLITUDE CORRECTION	Depositor
Microscope	FEI TITAN KRIOS	Depositor
Voltage (kV)	300	Depositor
Electron dose ($e^-/\text{\AA}^2$)	49	Depositor
Minimum defocus (nm)	1200	Depositor
Maximum defocus (nm)	2700	Depositor
Magnification	59000	Depositor
Image detector	FEI FALCON II (4k x 4k)	Depositor
Maximum map value	0.130	Depositor
Minimum map value	-0.075	Depositor
Average map value	0.001	Depositor
Map value standard deviation	0.005	Depositor
Recommended contour level	0.02	Depositor
Map size (Å)	1788.48, 1788.48, 1788.48	wwPDB
Map dimensions	1296, 1296, 1296	wwPDB
Map angles (°)	90.0, 90.0, 90.0	wwPDB
Pixel spacing (Å)	1.38, 1.38, 1.38	Depositor

5 Model quality [i](#)

5.1 Standard geometry [i](#)

The Z score for a bond length (or angle) is the number of standard deviations the observed value is removed from the expected value. A bond length (or angle) with $|Z| > 5$ is considered an outlier worth inspection. RMSZ is the root-mean-square of all Z scores of the bond lengths (or angles).

Mol	Chain	Bond lengths		Bond angles	
		RMSZ	# Z >5	RMSZ	# Z >5
1	AA	0.25	0/2736	0.43	0/3706
1	AB	0.24	0/2736	0.41	0/3706
1	AC	0.25	0/2713	0.42	0/3673
1	AD	0.25	0/2736	0.43	0/3706
1	AE	0.24	0/2728	0.43	0/3694
1	AF	0.24	0/2727	0.41	0/3695
1	AG	0.24	0/2736	0.44	0/3706
1	AH	0.24	0/2736	0.43	0/3706
1	AI	0.25	0/2736	0.44	0/3706
1	AJ	0.24	0/2736	0.42	0/3706
1	AK	0.24	0/2736	0.42	0/3706
1	AL	0.25	0/2736	0.43	0/3706
1	AM	0.25	0/2713	0.43	0/3673
1	AN	0.24	0/2713	0.42	0/3673
1	AO	0.25	0/2713	0.42	0/3673
1	AP	0.24	0/2736	0.43	0/3706
1	AQ	0.25	0/2736	0.42	0/3706
1	AR	0.25	0/2736	0.42	0/3706
1	AS	0.24	0/2728	0.43	0/3694
1	AT	0.24	0/2728	0.44	0/3694
1	AU	0.24	0/2728	0.44	0/3694
1	AV	0.25	0/2727	0.42	0/3695
1	AW	0.24	0/2727	0.42	0/3695
1	AX	0.24	0/2727	0.41	0/3695
1	AY	0.25	0/2736	0.43	0/3706
1	AZ	0.24	0/2736	0.41	0/3706
1	BA	0.25	0/2713	0.42	0/3673
1	BB	0.25	0/2736	0.43	0/3706
1	BC	0.24	0/2728	0.43	0/3694
1	BD	0.24	0/2727	0.41	0/3695
1	BE	0.25	0/2736	0.44	0/3706
1	BF	0.24	0/2736	0.43	0/3706
1	BG	0.25	0/2736	0.44	0/3706
1	BH	0.24	0/2736	0.42	0/3706

Mol	Chain	Bond lengths		Bond angles	
		RMSZ	# Z >5	RMSZ	# Z >5
1	BI	0.24	0/2736	0.42	0/3706
1	BJ	0.25	0/2736	0.43	0/3706
1	BK	0.25	0/2713	0.43	0/3673
1	BL	0.24	0/2713	0.42	0/3673
1	BM	0.25	0/2713	0.42	0/3673
1	BN	0.24	0/2736	0.43	0/3706
1	BO	0.25	0/2736	0.42	0/3706
1	BP	0.25	0/2736	0.42	0/3706
1	BQ	0.24	0/2728	0.43	0/3694
1	BR	0.24	0/2728	0.44	0/3694
1	BS	0.24	0/2728	0.44	0/3694
1	BT	0.25	0/2727	0.42	0/3695
1	BU	0.24	0/2727	0.42	0/3695
1	BV	0.24	0/2727	0.42	0/3695
1	BW	0.25	0/2723	0.44	0/3690
1	BX	0.24	0/2728	0.44	0/3694
1	BY	0.25	0/2736	0.43	0/3706
1	BZ	0.25	0/2720	0.43	0/3683
1	CA	0.24	0/2728	0.45	0/3694
1	CB	0.25	0/2727	0.44	0/3695
1	CC	0.24	0/2736	0.46	0/3706
1	CD	0.25	0/2706	0.45	0/3661
1	CE	0.24	0/2727	0.44	0/3695
1	CF	0.24	0/2693	0.43	0/3646
1	CG	0.25	0/2736	0.45	0/3706
1	CH	0.24	0/2736	0.42	0/3706
1	CI	0.25	0/2727	0.45	0/3695
1	CJ	0.25	0/2736	0.44	0/3706
1	CK	0.24	0/2736	0.44	0/3706
1	CL	0.25	0/2704	0.43	0/3662
1	CM	0.25	0/2727	0.45	0/3695
1	CN	0.25	0/2693	0.44	0/3646
1	CO	0.25	0/2686	0.45	0/3636
1	CP	0.24	0/2719	0.43	0/3683
1	CQ	0.25	0/2727	0.44	0/3695
1	CR	0.25	0/2720	0.44	0/3683
1	CS	0.25	0/2736	0.43	0/3706
1	CT	0.24	0/2728	0.42	0/3694
1	CU	0.25	0/2727	0.45	0/3695
1	CV	0.24	0/2736	0.43	0/3706
1	CW	0.24	0/2728	0.45	0/3694
1	CX	0.25	0/2727	0.43	0/3695
1	CY	0.25	0/2736	0.44	0/3706

Mol	Chain	Bond lengths		Bond angles	
		RMSZ	# Z >5	RMSZ	# Z >5
1	CZ	0.25	0/2736	0.46	0/3706
1	DA	0.24	0/2728	0.44	0/3694
1	DB	0.25	0/2736	0.43	0/3706
1	DC	0.25	0/2720	0.44	0/3683
1	DD	0.25	0/2728	0.44	0/3694
1	DE	0.25	0/2727	0.44	0/3695
1	DF	0.25	0/2736	0.45	0/3706
1	DG	0.25	0/2706	0.45	0/3661
1	DH	0.25	0/2727	0.44	0/3695
1	DI	0.25	0/2736	0.43	0/3706
1	DJ	0.25	0/2727	0.45	0/3695
1	DK	0.25	0/2704	0.43	0/3662
1	DL	0.25	0/2727	0.44	0/3695
1	DM	0.24	0/2719	0.43	0/3683
1	DN	0.25	0/2727	0.44	0/3695
1	DO	0.25	0/2728	0.43	0/3694
1	DP	0.25	0/2727	0.44	0/3695
1	DQ	0.25	0/2727	0.42	0/3695
All	All	0.25	0/259063	0.43	0/350885

Chiral center outliers are detected by calculating the chiral volume of a chiral center and verifying if the center is modelled as a planar moiety or with the opposite hand. A planarity outlier is detected by checking planarity of atoms in a peptide group, atoms in a mainchain group or atoms of a sidechain that are expected to be planar.

Mol	Chain	#Chirality outliers	#Planarity outliers
1	AF	0	1
1	BD	0	1
1	CA	0	1
1	CC	0	2
1	DF	0	2
All	All	0	7

There are no bond length outliers.

There are no bond angle outliers.

There are no chirality outliers.

5 of 7 planarity outliers are listed below:

Mol	Chain	Res	Type	Group
1	AF	213	PHE	Peptide
1	BD	213	PHE	Peptide

Continued on next page...

Continued from previous page...

Mol	Chain	Res	Type	Group
1	CA	144	THR	Peptide
1	CC	167	PHE	Peptide
1	CC	168	GLN	Peptide

5.2 Too-close contacts [i](#)

In the following table, the Non-H and H(model) columns list the number of non-hydrogen atoms and hydrogen atoms in the chain respectively. The H(added) column lists the number of hydrogen atoms added and optimized by MolProbity. The Clashes column lists the number of clashes within the asymmetric unit, whereas Symm-Clashes lists symmetry-related clashes.

Mol	Chain	Non-H	H(model)	H(added)	Clashes	Symm-Clashes
1	AA	2685	0	2651	29	0
1	AB	2685	0	2651	24	0
1	AC	2663	0	2631	33	0
1	AD	2685	0	2651	26	0
1	AE	2677	0	2646	25	0
1	AF	2676	0	2638	26	0
1	AG	2685	0	2651	27	0
1	AH	2685	0	2651	28	0
1	AI	2685	0	2651	23	0
1	AJ	2685	0	2651	23	0
1	AK	2685	0	2645	86	0
1	AL	2685	0	2651	23	0
1	AM	2663	0	2625	164	0
1	AN	2663	0	2631	26	0
1	AO	2663	0	2631	32	0
1	AP	2685	0	2627	376	0
1	AQ	2685	0	2651	26	0
1	AR	2685	0	2651	30	0
1	AS	2677	0	2642	166	0
1	AT	2677	0	2646	25	0
1	AU	2677	0	2646	26	0
1	AV	2676	0	2638	33	0
1	AW	2676	0	2619	213	0
1	AX	2676	0	2638	22	0
1	AY	2685	0	2651	27	0
1	AZ	2685	0	2651	26	0
1	BA	2663	0	2631	34	0
1	BB	2685	0	2651	27	0
1	BC	2677	0	2646	24	0
1	BD	2676	0	2638	23	0

Continued on next page...

Continued from previous page...

Mol	Chain	Non-H	H(model)	H(added)	Clashes	Symm-Clashes
1	BE	2685	0	2651	28	0
1	BF	2685	0	2651	54	0
1	BG	2685	0	2651	24	0
1	BH	2685	0	2651	23	0
1	BI	2685	0	2631	450	0
1	BJ	2685	0	2651	22	0
1	BK	2663	0	2622	168	0
1	BL	2663	0	2631	29	0
1	BM	2663	0	2631	31	0
1	BN	2685	0	2642	144	0
1	BO	2685	0	2651	26	0
1	BP	2685	0	2651	29	0
1	BQ	2677	0	2646	31	0
1	BR	2677	0	2646	27	0
1	BS	2677	0	2646	25	0
1	BT	2676	0	2638	29	0
1	BU	2676	0	2623	270	0
1	BV	2676	0	2638	24	0
1	BW	2672	0	2635	40	0
1	BX	2677	0	2646	53	0
1	BY	2685	0	2651	41	0
1	BZ	2670	0	2638	34	0
1	CA	2677	0	2646	45	0
1	CB	2676	0	2638	40	0
1	CC	2685	0	2651	33	0
1	CD	2657	0	2629	39	0
1	CE	2676	0	2638	44	0
1	CF	2644	0	2611	34	0
1	CG	2685	0	2651	38	0
1	CH	2685	0	2651	22	0
1	CI	2676	0	2638	28	0
1	CJ	2685	0	2651	26	0
1	CK	2685	0	2651	41	0
1	CL	2654	0	2618	41	0
1	CM	2676	0	2638	31	0
1	CN	2644	0	2608	115	0
1	CO	2637	0	2602	39	0
1	CP	2668	0	2633	37	0
1	CQ	2676	0	2638	43	0
1	CR	2670	0	2631	138	0
1	CS	2685	0	2641	281	0
1	CT	2677	0	2646	34	0

Continued on next page...

Continued from previous page...

Mol	Chain	Non-H	H(model)	H(added)	Clashes	Symm-Clashes
1	CU	2676	0	2638	48	0
1	CV	2685	0	2647	48	0
1	CW	2677	0	2629	173	0
1	CX	2676	0	2638	22	0
1	CY	2685	0	2651	37	0
1	CZ	2685	0	2647	94	0
1	DA	2677	0	2646	36	0
1	DB	2685	0	2651	45	0
1	DC	2670	0	2638	42	0
1	DD	2677	0	2646	68	0
1	DE	2676	0	2638	42	0
1	DF	2685	0	2651	44	0
1	DG	2657	0	2629	37	0
1	DH	2676	0	2634	181	0
1	DI	2685	0	2651	28	0
1	DJ	2676	0	2638	38	0
1	DK	2654	0	2605	216	0
1	DL	2676	0	2638	30	0
1	DM	2668	0	2633	111	0
1	DN	2676	0	2638	38	0
1	DO	2677	0	2642	52	0
1	DP	2676	0	2624	292	0
1	DQ	2676	0	2638	30	0
All	All	254241	0	250802	4251	0

The all-atom clashscore is defined as the number of clashes found per 1000 atoms (including hydrogen atoms). The all-atom clashscore for this structure is 8.

The worst 5 of 4251 close contacts within the same asymmetric unit are listed below, sorted by their clash magnitude.

Atom-1	Atom-2	Interatomic distance (Å)	Clash overlap (Å)
1:AP:96:THR:CG2	1:CZ:65:GLU:H	1.04	1.65
1:BU:14:GLY:CA	1:DP:102:ASN:HD21	1.08	1.65
1:AW:16:LYS:HG3	1:BK:103:TYR:CD2	1.21	1.62
1:BI:92:ARG:CZ	1:DK:6:LEU:HD23	1.16	1.62
1:AP:79:ILE:HD13	1:CR:147:ALA:CB	1.16	1.61

There are no symmetry-related clashes.

5.3 Torsion angles

5.3.1 Protein backbone

In the following table, the Percentiles column shows the percent Ramachandran outliers of the chain as a percentile score with respect to all PDB entries followed by that with respect to all EM entries.

The Analysed column shows the number of residues for which the backbone conformation was analysed, and the total number of residues.

Mol	Chain	Analysed	Favoured	Allowed	Outliers	Percentiles	
1	AA	345/352 (98%)	327 (95%)	18 (5%)	0	100	100
1	AB	345/352 (98%)	319 (92%)	26 (8%)	0	100	100
1	AC	342/352 (97%)	320 (94%)	22 (6%)	0	100	100
1	AD	345/352 (98%)	321 (93%)	24 (7%)	0	100	100
1	AE	344/352 (98%)	308 (90%)	36 (10%)	0	100	100
1	AF	344/352 (98%)	318 (92%)	26 (8%)	0	100	100
1	AG	345/352 (98%)	314 (91%)	31 (9%)	0	100	100
1	AH	345/352 (98%)	319 (92%)	26 (8%)	0	100	100
1	AI	345/352 (98%)	324 (94%)	21 (6%)	0	100	100
1	AJ	345/352 (98%)	313 (91%)	32 (9%)	0	100	100
1	AK	345/352 (98%)	317 (92%)	28 (8%)	0	100	100
1	AL	345/352 (98%)	313 (91%)	32 (9%)	0	100	100
1	AM	342/352 (97%)	319 (93%)	22 (6%)	1 (0%)	41	76
1	AN	342/352 (97%)	311 (91%)	31 (9%)	0	100	100
1	AO	342/352 (97%)	315 (92%)	27 (8%)	0	100	100
1	AP	345/352 (98%)	319 (92%)	26 (8%)	0	100	100
1	AQ	345/352 (98%)	321 (93%)	24 (7%)	0	100	100
1	AR	345/352 (98%)	323 (94%)	22 (6%)	0	100	100
1	AS	344/352 (98%)	316 (92%)	28 (8%)	0	100	100
1	AT	344/352 (98%)	309 (90%)	35 (10%)	0	100	100
1	AU	344/352 (98%)	300 (87%)	44 (13%)	0	100	100
1	AV	344/352 (98%)	320 (93%)	24 (7%)	0	100	100
1	AW	344/352 (98%)	321 (93%)	23 (7%)	0	100	100
1	AX	344/352 (98%)	321 (93%)	23 (7%)	0	100	100
1	AY	345/352 (98%)	327 (95%)	18 (5%)	0	100	100

Continued on next page...

Continued from previous page...

Mol	Chain	Analysed	Favoured	Allowed	Outliers	Percentiles	
1	AZ	345/352 (98%)	318 (92%)	27 (8%)	0	100	100
1	BA	342/352 (97%)	320 (94%)	22 (6%)	0	100	100
1	BB	345/352 (98%)	320 (93%)	25 (7%)	0	100	100
1	BC	344/352 (98%)	308 (90%)	36 (10%)	0	100	100
1	BD	344/352 (98%)	318 (92%)	26 (8%)	0	100	100
1	BE	345/352 (98%)	314 (91%)	31 (9%)	0	100	100
1	BF	345/352 (98%)	319 (92%)	26 (8%)	0	100	100
1	BG	345/352 (98%)	323 (94%)	22 (6%)	0	100	100
1	BH	345/352 (98%)	314 (91%)	31 (9%)	0	100	100
1	BI	345/352 (98%)	317 (92%)	28 (8%)	0	100	100
1	BJ	345/352 (98%)	313 (91%)	32 (9%)	0	100	100
1	BK	342/352 (97%)	319 (93%)	22 (6%)	1 (0%)	41	76
1	BL	342/352 (97%)	311 (91%)	31 (9%)	0	100	100
1	BM	342/352 (97%)	315 (92%)	27 (8%)	0	100	100
1	BN	345/352 (98%)	318 (92%)	27 (8%)	0	100	100
1	BO	345/352 (98%)	321 (93%)	24 (7%)	0	100	100
1	BP	345/352 (98%)	323 (94%)	22 (6%)	0	100	100
1	BQ	344/352 (98%)	316 (92%)	28 (8%)	0	100	100
1	BR	344/352 (98%)	308 (90%)	36 (10%)	0	100	100
1	BS	344/352 (98%)	302 (88%)	42 (12%)	0	100	100
1	BT	344/352 (98%)	320 (93%)	24 (7%)	0	100	100
1	BU	344/352 (98%)	319 (93%)	25 (7%)	0	100	100
1	BV	344/352 (98%)	321 (93%)	23 (7%)	0	100	100
1	BW	343/352 (97%)	285 (83%)	58 (17%)	0	100	100
1	BX	344/352 (98%)	284 (83%)	59 (17%)	1 (0%)	41	76
1	BY	345/352 (98%)	309 (90%)	36 (10%)	0	100	100
1	BZ	343/352 (97%)	307 (90%)	36 (10%)	0	100	100
1	CA	344/352 (98%)	275 (80%)	65 (19%)	4 (1%)	13	50
1	CB	344/352 (98%)	298 (87%)	46 (13%)	0	100	100
1	CC	345/352 (98%)	288 (84%)	56 (16%)	1 (0%)	41	76
1	CD	339/352 (96%)	305 (90%)	34 (10%)	0	100	100

Continued on next page...

Continued from previous page...

Mol	Chain	Analysed	Favoured	Allowed	Outliers	Percentiles	
1	CE	344/352 (98%)	322 (94%)	22 (6%)	0	100	100
1	CF	340/352 (97%)	306 (90%)	34 (10%)	0	100	100
1	CG	345/352 (98%)	276 (80%)	68 (20%)	1 (0%)	41	76
1	CH	345/352 (98%)	314 (91%)	31 (9%)	0	100	100
1	CI	344/352 (98%)	318 (92%)	26 (8%)	0	100	100
1	CJ	345/352 (98%)	315 (91%)	30 (9%)	0	100	100
1	CK	345/352 (98%)	264 (76%)	81 (24%)	0	100	100
1	CL	341/352 (97%)	294 (86%)	47 (14%)	0	100	100
1	CM	344/352 (98%)	324 (94%)	20 (6%)	0	100	100
1	CN	340/352 (97%)	310 (91%)	30 (9%)	0	100	100
1	CO	339/352 (96%)	286 (84%)	53 (16%)	0	100	100
1	CP	343/352 (97%)	306 (89%)	37 (11%)	0	100	100
1	CQ	344/352 (98%)	313 (91%)	31 (9%)	0	100	100
1	CR	343/352 (97%)	307 (90%)	36 (10%)	0	100	100
1	CS	345/352 (98%)	298 (86%)	47 (14%)	0	100	100
1	CT	344/352 (98%)	312 (91%)	32 (9%)	0	100	100
1	CU	344/352 (98%)	319 (93%)	25 (7%)	0	100	100
1	CV	345/352 (98%)	323 (94%)	22 (6%)	0	100	100
1	CW	344/352 (98%)	284 (83%)	60 (17%)	0	100	100
1	CX	344/352 (98%)	328 (95%)	16 (5%)	0	100	100
1	CY	345/352 (98%)	311 (90%)	34 (10%)	0	100	100
1	CZ	345/352 (98%)	285 (83%)	60 (17%)	0	100	100
1	DA	344/352 (98%)	288 (84%)	54 (16%)	2 (1%)	25	64
1	DB	345/352 (98%)	317 (92%)	28 (8%)	0	100	100
1	DC	343/352 (97%)	307 (90%)	36 (10%)	0	100	100
1	DD	344/352 (98%)	290 (84%)	51 (15%)	3 (1%)	17	56
1	DE	344/352 (98%)	302 (88%)	42 (12%)	0	100	100
1	DF	345/352 (98%)	286 (83%)	58 (17%)	1 (0%)	41	76
1	DG	339/352 (96%)	302 (89%)	37 (11%)	0	100	100
1	DH	344/352 (98%)	316 (92%)	28 (8%)	0	100	100
1	DI	345/352 (98%)	313 (91%)	32 (9%)	0	100	100

Continued on next page...

Continued from previous page...

Mol	Chain	Analysed	Favoured	Allowed	Outliers	Percentiles	
1	DJ	344/352 (98%)	322 (94%)	22 (6%)	0	100	100
1	DK	341/352 (97%)	303 (89%)	38 (11%)	0	100	100
1	DL	344/352 (98%)	324 (94%)	20 (6%)	0	100	100
1	DM	343/352 (97%)	312 (91%)	31 (9%)	0	100	100
1	DN	344/352 (98%)	326 (95%)	18 (5%)	0	100	100
1	DO	344/352 (98%)	316 (92%)	28 (8%)	0	100	100
1	DP	344/352 (98%)	327 (95%)	17 (5%)	0	100	100
1	DQ	344/352 (98%)	319 (93%)	25 (7%)	0	100	100
All	All	32666/33440 (98%)	29548 (90%)	3103 (10%)	15 (0%)	100	100

5 of 15 Ramachandran outliers are listed below:

Mol	Chain	Res	Type
1	CA	44	GLN
1	CC	168	GLN
1	DD	45	THR
1	DD	145	ASN
1	AM	142	TYR

5.3.2 Protein sidechains [i](#)

In the following table, the Percentiles column shows the percent sidechain outliers of the chain as a percentile score with respect to all PDB entries followed by that with respect to all EM entries.

The Analysed column shows the number of residues for which the sidechain conformation was analysed, and the total number of residues.

Mol	Chain	Analysed	Rotameric	Outliers	Percentiles	
1	AA	286/287 (100%)	279 (98%)	7 (2%)	49	69
1	AB	286/287 (100%)	284 (99%)	2 (1%)	84	90
1	AC	283/287 (99%)	282 (100%)	1 (0%)	91	94
1	AD	286/287 (100%)	281 (98%)	5 (2%)	60	78
1	AE	285/287 (99%)	282 (99%)	3 (1%)	73	84
1	AF	285/287 (99%)	282 (99%)	3 (1%)	73	84
1	AG	286/287 (100%)	282 (99%)	4 (1%)	67	80
1	AH	286/287 (100%)	285 (100%)	1 (0%)	92	95

Continued on next page...

Continued from previous page...

Mol	Chain	Analysed	Rotameric	Outliers	Percentiles	
1	AI	286/287 (100%)	283 (99%)	3 (1%)	76	86
1	AJ	286/287 (100%)	284 (99%)	2 (1%)	84	90
1	AK	286/287 (100%)	282 (99%)	4 (1%)	67	80
1	AL	286/287 (100%)	281 (98%)	5 (2%)	60	78
1	AM	283/287 (99%)	280 (99%)	3 (1%)	73	84
1	AN	283/287 (99%)	281 (99%)	2 (1%)	84	90
1	AO	283/287 (99%)	278 (98%)	5 (2%)	59	76
1	AP	286/287 (100%)	284 (99%)	2 (1%)	84	90
1	AQ	286/287 (100%)	280 (98%)	6 (2%)	53	71
1	AR	286/287 (100%)	281 (98%)	5 (2%)	60	78
1	AS	285/287 (99%)	282 (99%)	3 (1%)	73	84
1	AT	285/287 (99%)	285 (100%)	0	100	100
1	AU	285/287 (99%)	280 (98%)	5 (2%)	59	76
1	AV	285/287 (99%)	282 (99%)	3 (1%)	73	84
1	AW	285/287 (99%)	284 (100%)	1 (0%)	91	94
1	AX	285/287 (99%)	281 (99%)	4 (1%)	67	80
1	AY	286/287 (100%)	279 (98%)	7 (2%)	49	69
1	AZ	286/287 (100%)	284 (99%)	2 (1%)	84	90
1	BA	283/287 (99%)	282 (100%)	1 (0%)	91	94
1	BB	286/287 (100%)	281 (98%)	5 (2%)	60	78
1	BC	285/287 (99%)	282 (99%)	3 (1%)	73	84
1	BD	285/287 (99%)	282 (99%)	3 (1%)	73	84
1	BE	286/287 (100%)	282 (99%)	4 (1%)	67	80
1	BF	286/287 (100%)	285 (100%)	1 (0%)	92	95
1	BG	286/287 (100%)	283 (99%)	3 (1%)	76	86
1	BH	286/287 (100%)	284 (99%)	2 (1%)	84	90
1	BI	286/287 (100%)	282 (99%)	4 (1%)	67	80
1	BJ	286/287 (100%)	281 (98%)	5 (2%)	60	78
1	BK	283/287 (99%)	280 (99%)	3 (1%)	73	84
1	BL	283/287 (99%)	281 (99%)	2 (1%)	84	90
1	BM	283/287 (99%)	278 (98%)	5 (2%)	59	76

Continued on next page...

Continued from previous page...

Mol	Chain	Analysed	Rotameric	Outliers	Percentiles	
1	BN	286/287 (100%)	284 (99%)	2 (1%)	84	90
1	BO	286/287 (100%)	281 (98%)	5 (2%)	60	78
1	BP	286/287 (100%)	281 (98%)	5 (2%)	60	78
1	BQ	285/287 (99%)	282 (99%)	3 (1%)	73	84
1	BR	285/287 (99%)	285 (100%)	0	100	100
1	BS	285/287 (99%)	280 (98%)	5 (2%)	59	76
1	BT	285/287 (99%)	282 (99%)	3 (1%)	73	84
1	BU	285/287 (99%)	284 (100%)	1 (0%)	91	94
1	BV	285/287 (99%)	281 (99%)	4 (1%)	67	80
1	BW	285/287 (99%)	284 (100%)	1 (0%)	91	94
1	BX	285/287 (99%)	284 (100%)	1 (0%)	91	94
1	BY	286/287 (100%)	286 (100%)	0	100	100
1	BZ	284/287 (99%)	284 (100%)	0	100	100
1	CA	285/287 (99%)	285 (100%)	0	100	100
1	CB	285/287 (99%)	285 (100%)	0	100	100
1	CC	286/287 (100%)	286 (100%)	0	100	100
1	CD	283/287 (99%)	283 (100%)	0	100	100
1	CE	285/287 (99%)	285 (100%)	0	100	100
1	CF	281/287 (98%)	281 (100%)	0	100	100
1	CG	286/287 (100%)	286 (100%)	0	100	100
1	CH	286/287 (100%)	284 (99%)	2 (1%)	84	90
1	CI	285/287 (99%)	283 (99%)	2 (1%)	84	90
1	CJ	286/287 (100%)	286 (100%)	0	100	100
1	CK	286/287 (100%)	286 (100%)	0	100	100
1	CL	282/287 (98%)	282 (100%)	0	100	100
1	CM	285/287 (99%)	283 (99%)	2 (1%)	84	90
1	CN	281/287 (98%)	281 (100%)	0	100	100
1	CO	280/287 (98%)	279 (100%)	1 (0%)	91	94
1	CP	284/287 (99%)	284 (100%)	0	100	100
1	CQ	285/287 (99%)	283 (99%)	2 (1%)	84	90
1	CR	284/287 (99%)	283 (100%)	1 (0%)	91	94

Continued on next page...

Continued from previous page...

Mol	Chain	Analysed	Rotameric	Outliers	Percentiles	
1	CS	286/287 (100%)	285 (100%)	1 (0%)	92	95
1	CT	285/287 (99%)	284 (100%)	1 (0%)	91	94
1	CU	285/287 (99%)	283 (99%)	2 (1%)	84	90
1	CV	286/287 (100%)	286 (100%)	0	100	100
1	CW	285/287 (99%)	285 (100%)	0	100	100
1	CX	285/287 (99%)	285 (100%)	0	100	100
1	CY	286/287 (100%)	286 (100%)	0	100	100
1	CZ	286/287 (100%)	286 (100%)	0	100	100
1	DA	285/287 (99%)	285 (100%)	0	100	100
1	DB	286/287 (100%)	286 (100%)	0	100	100
1	DC	284/287 (99%)	284 (100%)	0	100	100
1	DD	285/287 (99%)	285 (100%)	0	100	100
1	DE	285/287 (99%)	284 (100%)	1 (0%)	91	94
1	DF	286/287 (100%)	285 (100%)	1 (0%)	92	95
1	DG	283/287 (99%)	283 (100%)	0	100	100
1	DH	285/287 (99%)	285 (100%)	0	100	100
1	DI	286/287 (100%)	286 (100%)	0	100	100
1	DJ	285/287 (99%)	285 (100%)	0	100	100
1	DK	282/287 (98%)	282 (100%)	0	100	100
1	DL	285/287 (99%)	285 (100%)	0	100	100
1	DM	284/287 (99%)	284 (100%)	0	100	100
1	DN	285/287 (99%)	285 (100%)	0	100	100
1	DO	285/287 (99%)	285 (100%)	0	100	100
1	DP	285/287 (99%)	285 (100%)	0	100	100
1	DQ	285/287 (99%)	285 (100%)	0	100	100
All	All	27068/27265 (99%)	26893 (99%)	175 (1%)	86	92

5 of 175 residues with a non-rotameric sidechain are listed below:

Mol	Chain	Res	Type
1	BJ	60	ASN
1	BQ	275	ASP
1	BK	19	PHE

Continued on next page...

Continued from previous page...

Mol	Chain	Res	Type
1	BN	213	PHE
1	BT	141	GLN

Sometimes sidechains can be flipped to improve hydrogen bonding and reduce clashes. 5 of 169 such sidechains are listed below:

Mol	Chain	Res	Type
1	DD	63	HIS
1	DJ	265	GLN
1	DD	334	HIS
1	DG	210	ASN
1	DL	132	GLN

5.3.3 RNA [i](#)

There are no RNA molecules in this entry.

5.4 Non-standard residues in protein, DNA, RNA chains [i](#)

There are no non-standard protein/DNA/RNA residues in this entry.

5.5 Carbohydrates [i](#)

There are no monosaccharides in this entry.

5.6 Ligand geometry [i](#)

There are no ligands in this entry.

5.7 Other polymers [i](#)

There are no such residues in this entry.

5.8 Polymer linkage issues [i](#)

There are no chain breaks in this entry.

6 Map visualisation [i](#)

This section contains visualisations of the EMDB entry EMD-14488. These allow visual inspection of the internal detail of the map and identification of artifacts.

Images derived from a raw map, generated by summing the deposited half-maps, are presented below the corresponding image components of the primary map to allow further visual inspection and comparison with those of the primary map.

6.1 Orthogonal projections [i](#)

6.1.1 Primary map

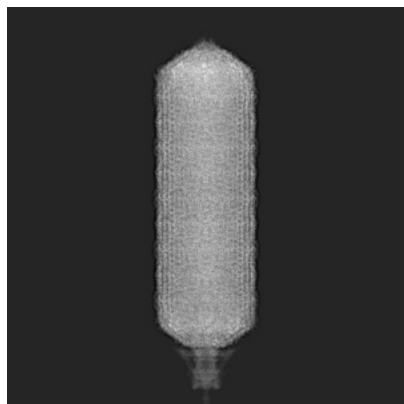

X

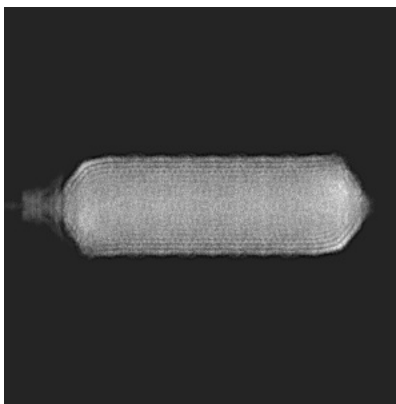

Y

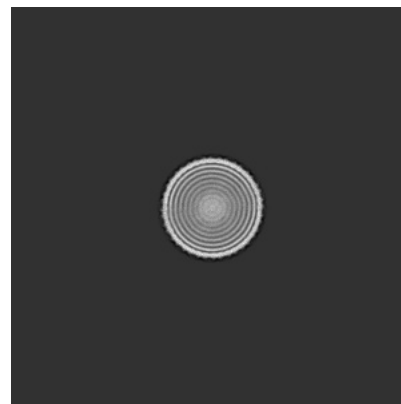

Z

6.1.2 Raw map

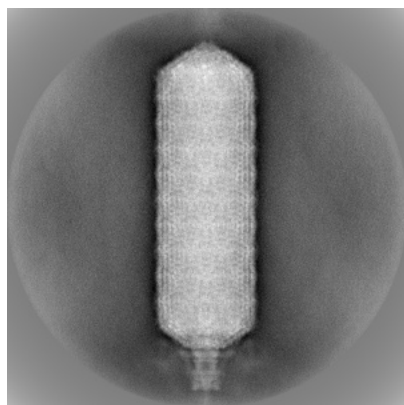

X

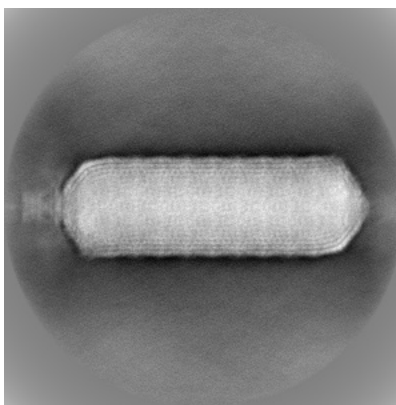

Y

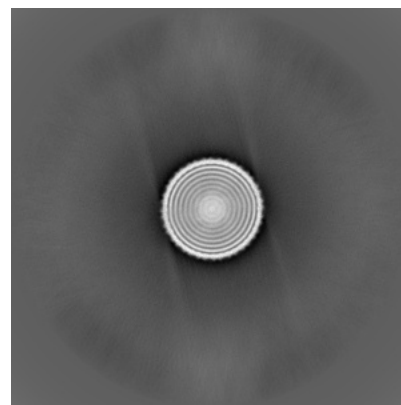

Z

The images above show the map projected in three orthogonal directions.

6.2 Central slices [i](#)

6.2.1 Primary map

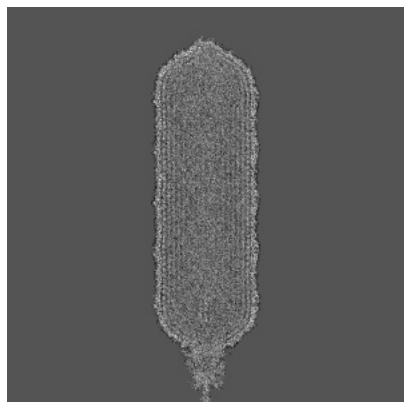

X Index: 648

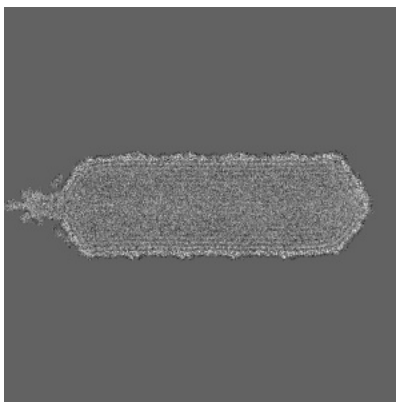

Y Index: 648

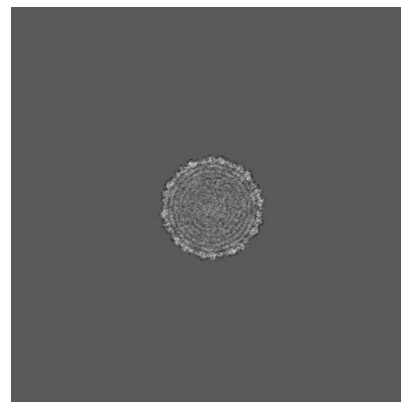

Z Index: 648

6.2.2 Raw map

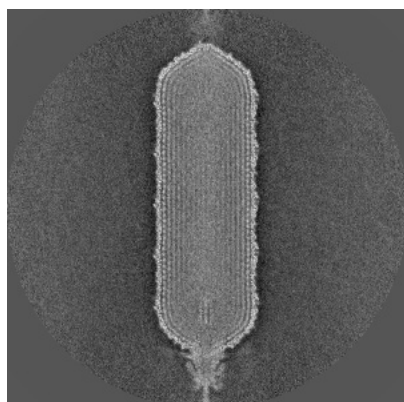

X Index: 648

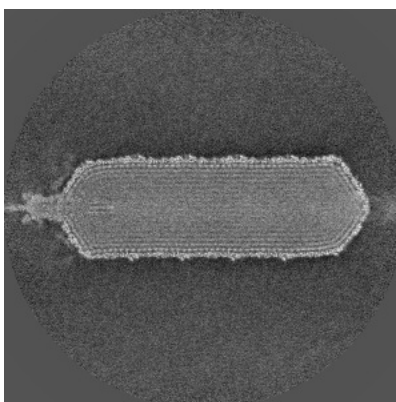

Y Index: 648

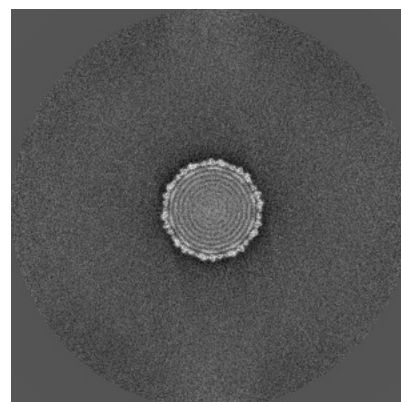

Z Index: 648

The images above show central slices of the map in three orthogonal directions.

6.3 Largest variance slices [i](#)

6.3.1 Primary map

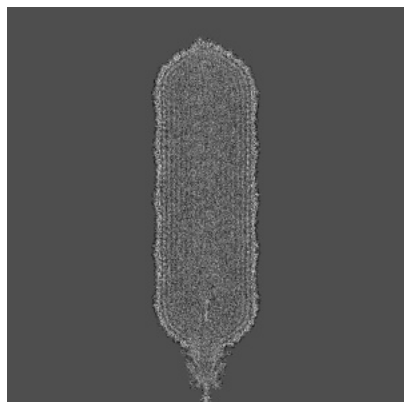

X Index: 651

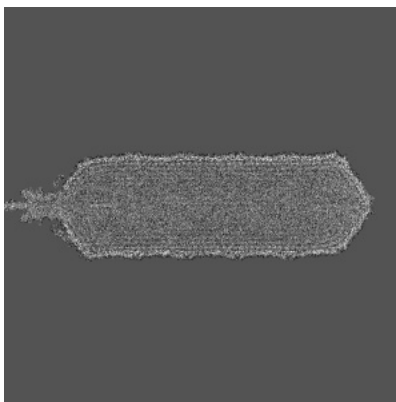

Y Index: 644

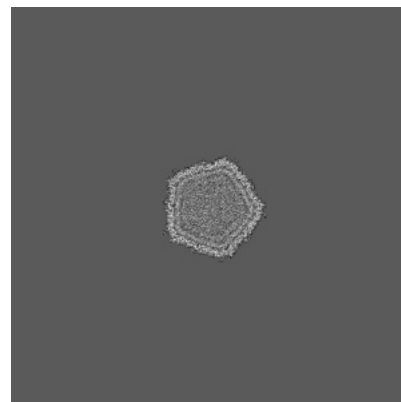

Z Index: 1085

6.3.2 Raw map

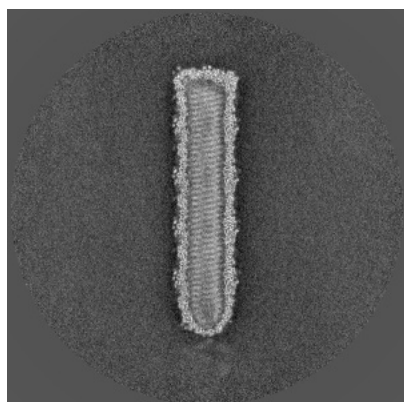

X Index: 519

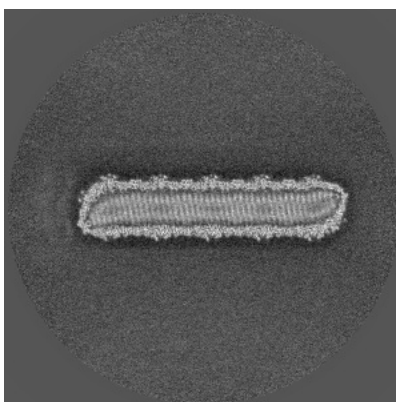

Y Index: 511

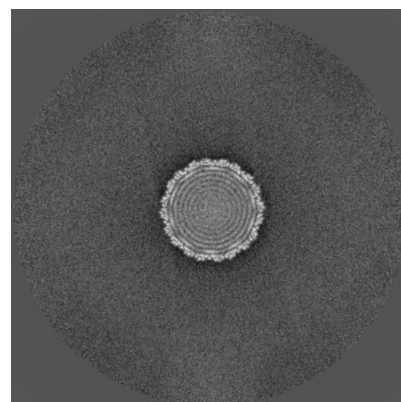

Z Index: 757

The images above show the largest variance slices of the map in three orthogonal directions.

6.4 Orthogonal standard-deviation projections (False-color) [i](#)

6.4.1 Primary map

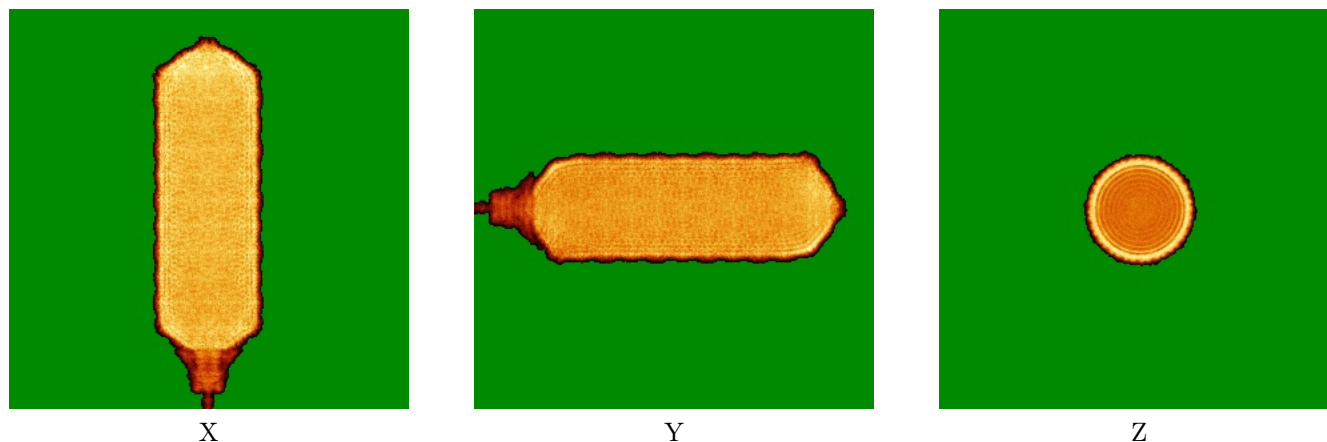

6.4.2 Raw map

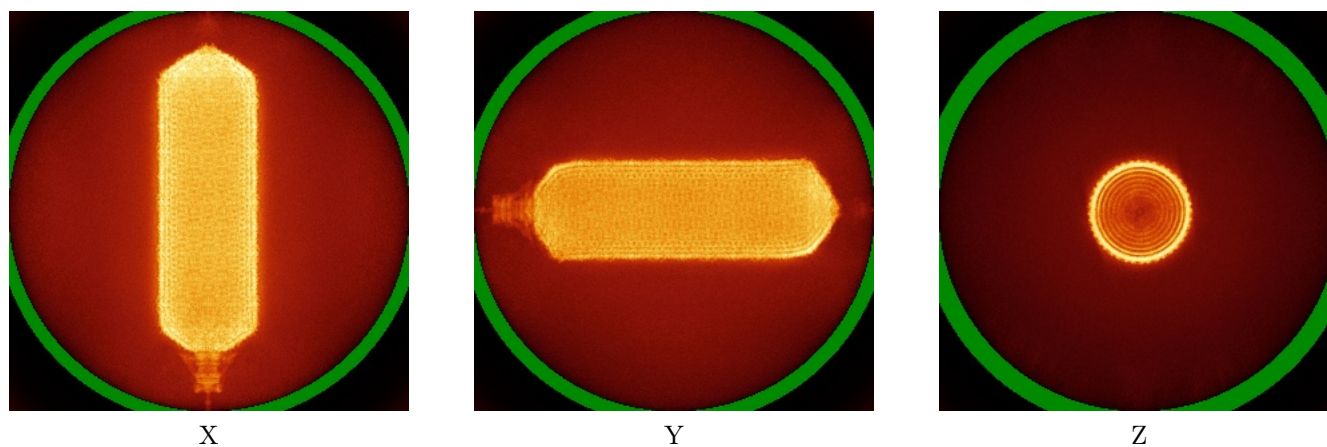

The images above show the map standard deviation projections with false color in three orthogonal directions. Minimum values are shown in green, max in blue, and dark to light orange shades represent small to large values respectively.

6.5 Orthogonal surface views [i](#)

6.5.1 Primary map

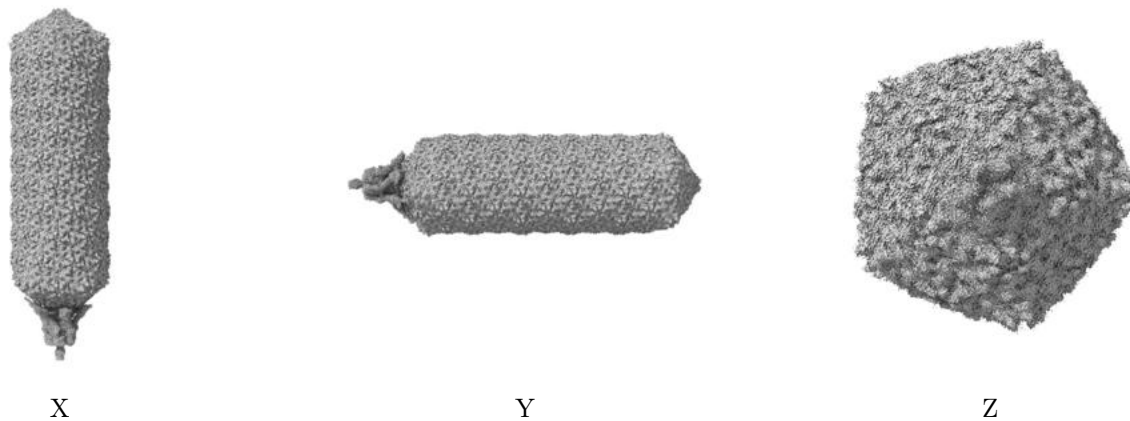

The images above show the 3D surface view of the map at the recommended contour level 0.02. These images, in conjunction with the slice images, may facilitate assessment of whether an appropriate contour level has been provided.

6.5.2 Raw map

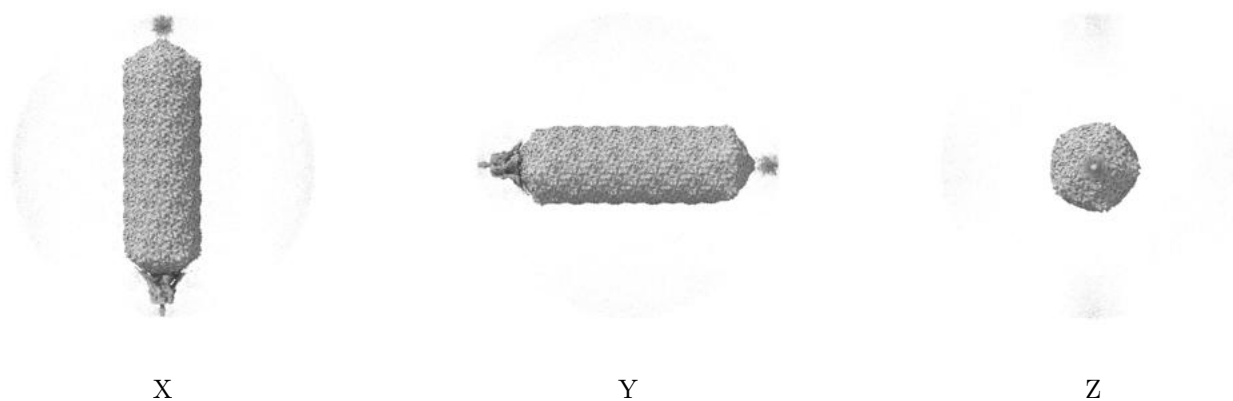

These images show the 3D surface of the raw map. The raw map's contour level was selected so that its surface encloses the same volume as the primary map does at its recommended contour level.

6.6 Mask visualisation [i](#)

This section was not generated. No masks/segmentation were deposited.

7 Map analysis [i](#)

This section contains the results of statistical analysis of the map.

7.1 Map-value distribution [i](#)

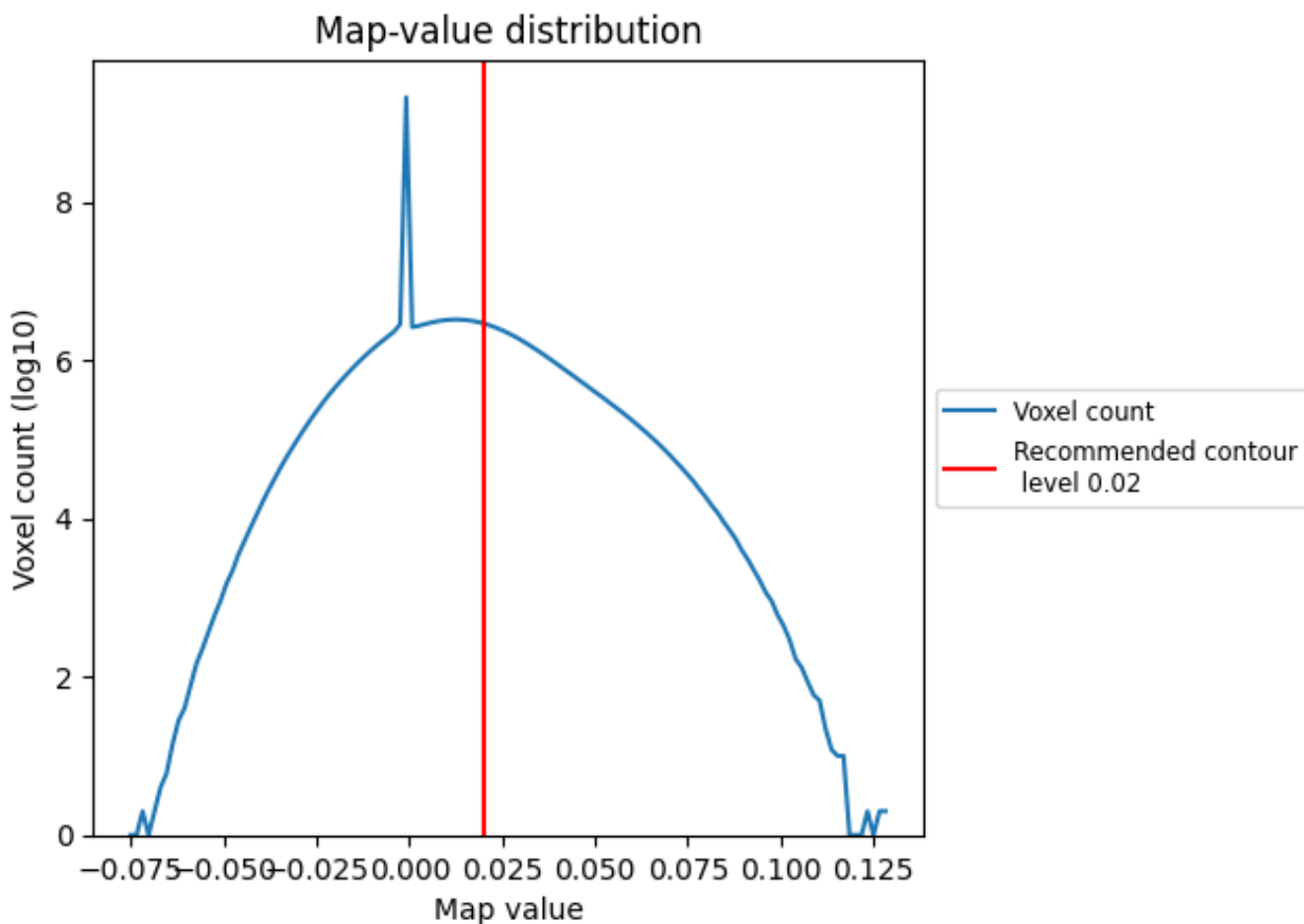

The map-value distribution is plotted in 128 intervals along the x-axis. The y-axis is logarithmic. A spike in this graph at zero usually indicates that the volume has been masked.

7.2 Volume estimate [i](#)

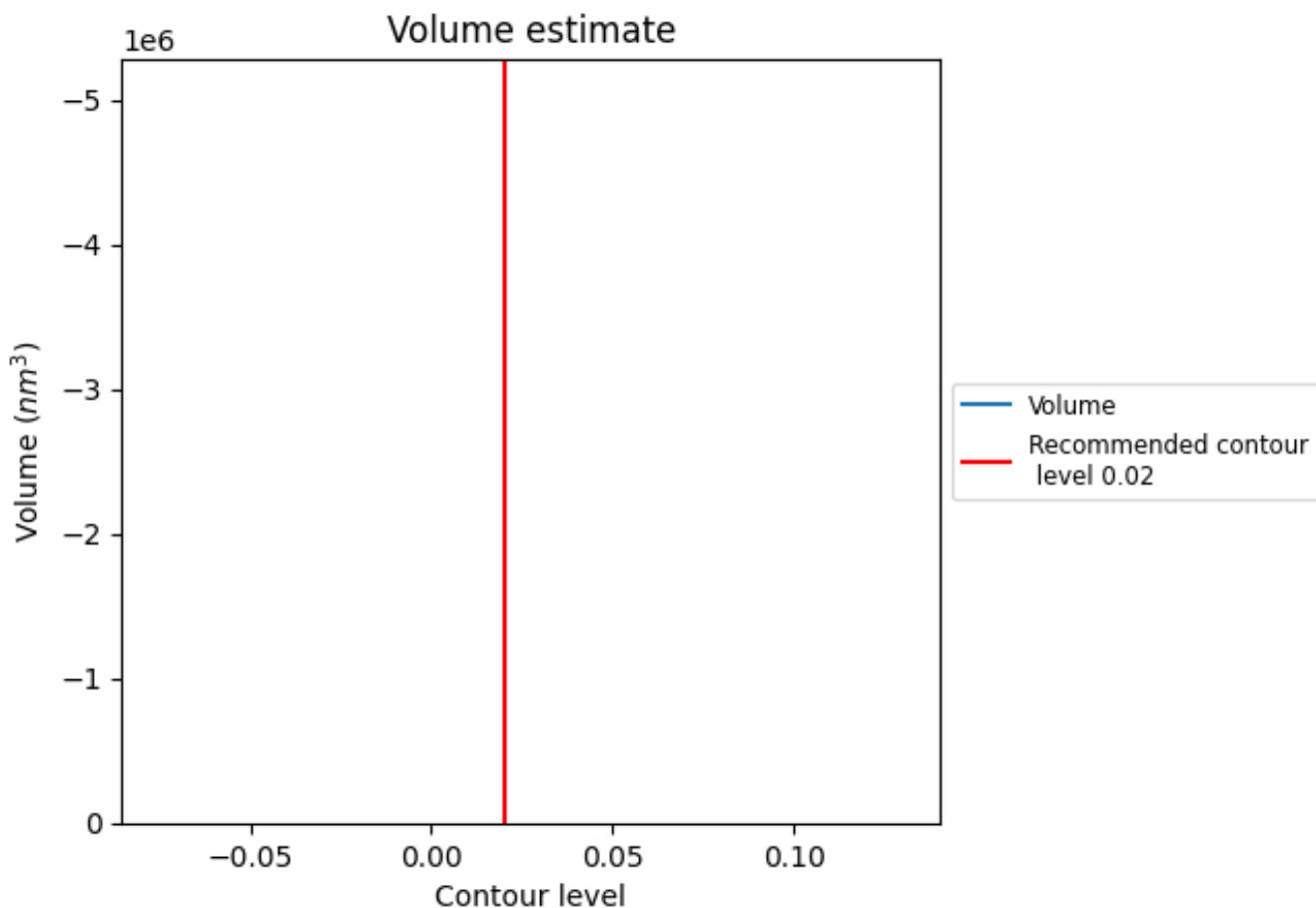

The volume at the recommended contour level is -11206573 nm^3 ; this corresponds to an approximate mass of -10123190 kDa .

The volume estimate graph shows how the enclosed volume varies with the contour level. The recommended contour level is shown as a vertical line and the intersection between the line and the curve gives the volume of the enclosed surface at the given level.

7.3 Rotationally averaged power spectrum i

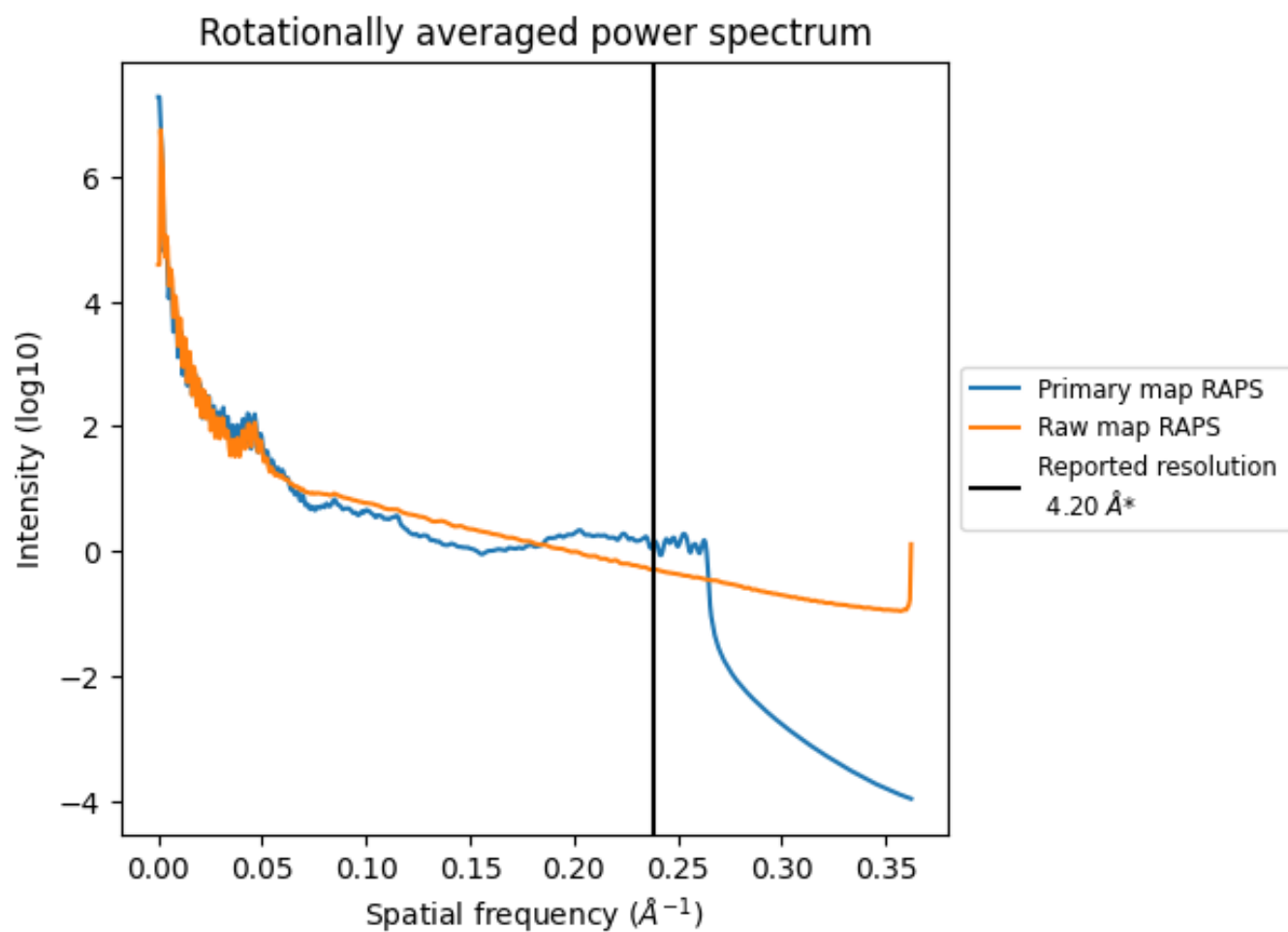

*Reported resolution corresponds to spatial frequency of 0.238 Å⁻¹

8 Fourier-Shell correlation [i](#)

Fourier-Shell Correlation (FSC) is the most commonly used method to estimate the resolution of single-particle and subtomogram-averaged maps. The shape of the curve depends on the imposed symmetry, mask and whether or not the two 3D reconstructions used were processed from a common reference. The reported resolution is shown as a black line. A curve is displayed for the half-bit criterion in addition to lines showing the 0.143 gold standard cut-off and 0.5 cut-off.

8.1 FSC [i](#)

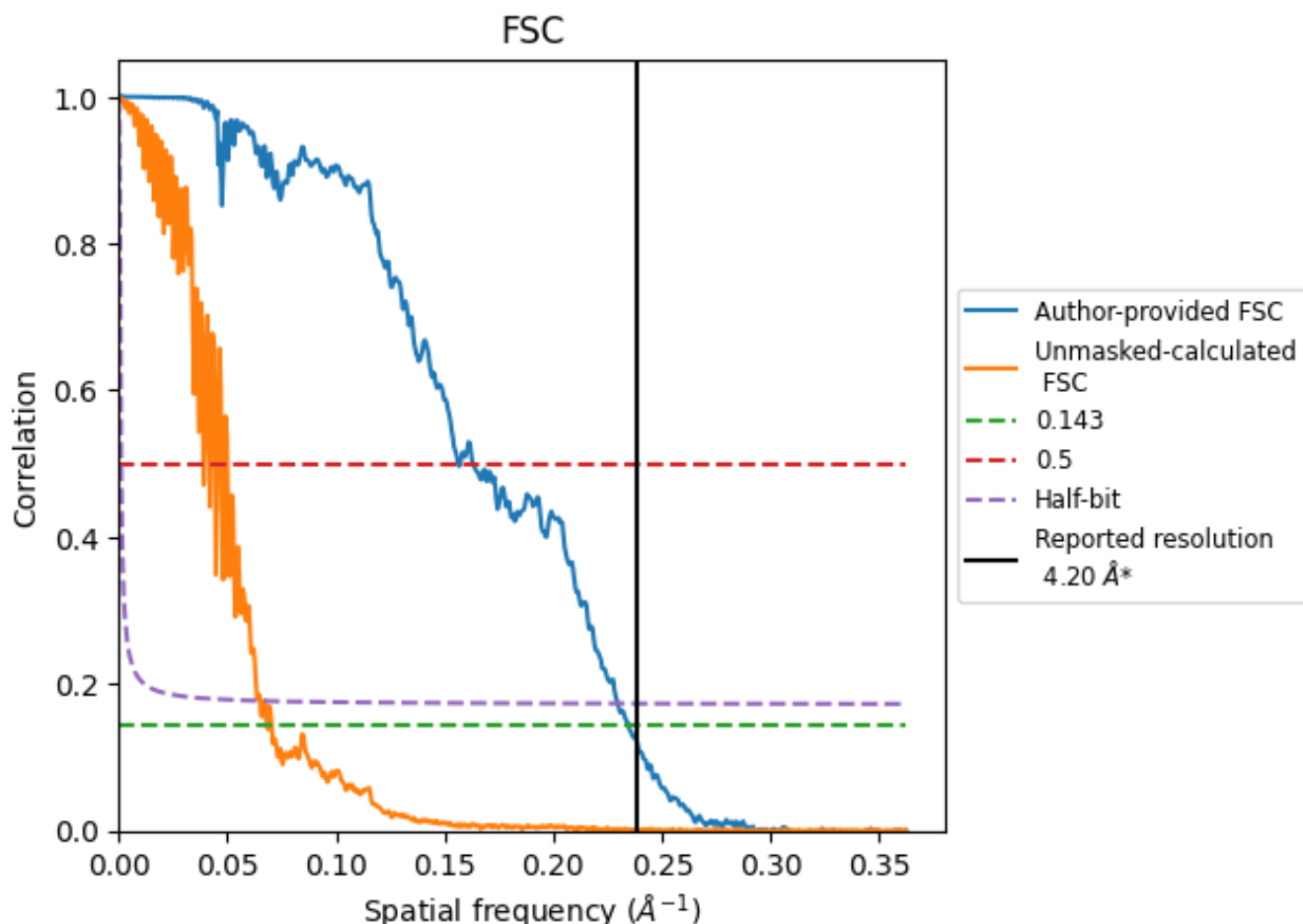

*Reported resolution corresponds to spatial frequency of 0.238 Å⁻¹

8.2 Resolution estimates [i](#)

Resolution estimate (Å)	Estimation criterion (FSC cut-off)		
	0.143	0.5	Half-bit
Reported by author	4.20	-	-
Author-provided FSC curve	4.26	6.40	4.35
Unmasked-calculated*	14.66	25.64	15.38

*Resolution estimate based on FSC curve calculated by comparison of deposited half-maps. The value from deposited half-maps intersecting FSC 0.143 CUT-OFF 14.66 differs from the reported value 4.2 by more than 10 %

9 Map-model fit [i](#)

This section contains information regarding the fit between EMDB map EMD-14488 and PDB model 7Z49. Per-residue inclusion information can be found in section 3 on page 12.

9.1 Map-model overlays

9.1.1 Map-model overlay [i](#)

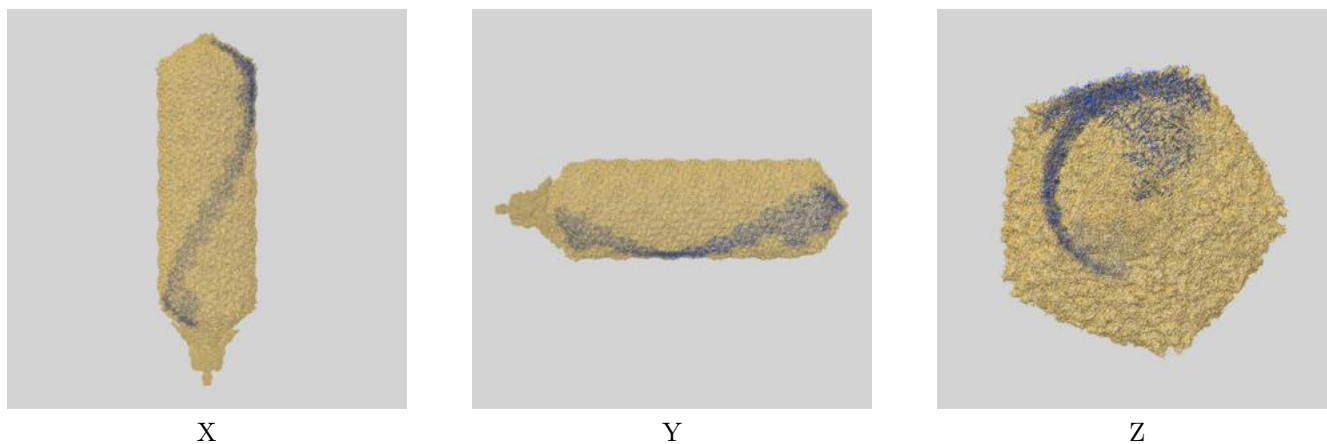

9.1.2 Map-model assembly overlay [i](#)

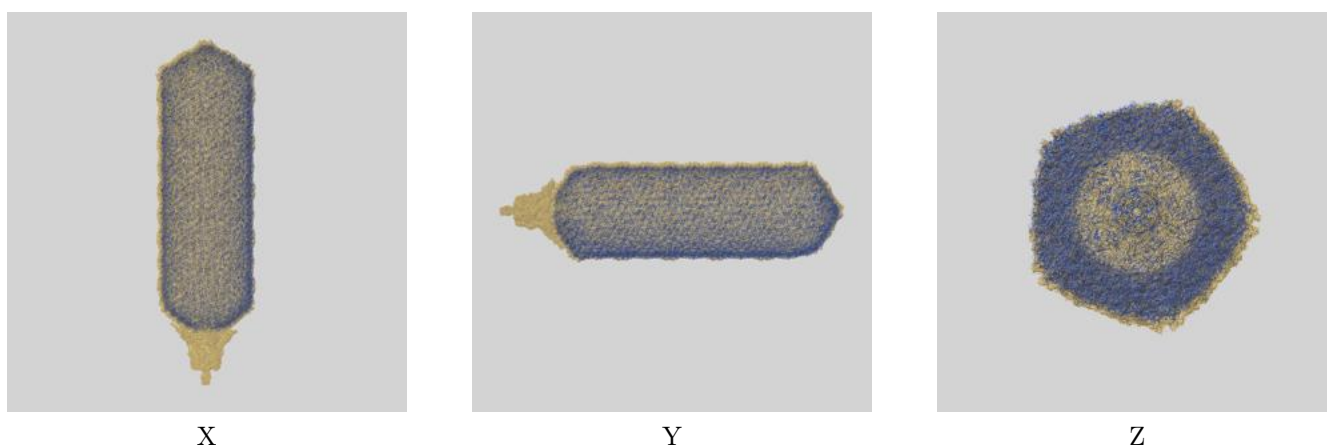

The images above show the 3D surface view of the map at the recommended contour level 0.02 at 50% transparency in yellow overlaid with a ribbon representation of the model coloured in blue. These images allow for the visual assessment of the quality of fit between the atomic model and the map.

9.2 Q-score mapped to coordinate model [i](#)

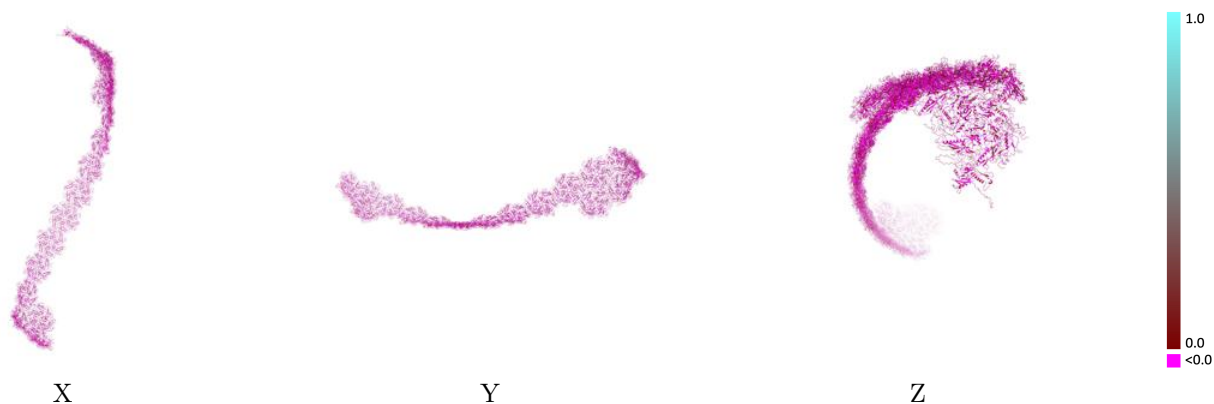

The images above show the model with each residue coloured according to its Q-score. This shows their resolvability in the map with higher Q-score values reflecting better resolvability. Please note: Q-score is calculating the resolvability of atoms, and thus high values are only expected at resolutions at which atoms can be resolved. Low Q-score values may therefore be expected for many entries.

9.3 Atom inclusion mapped to coordinate model [i](#)

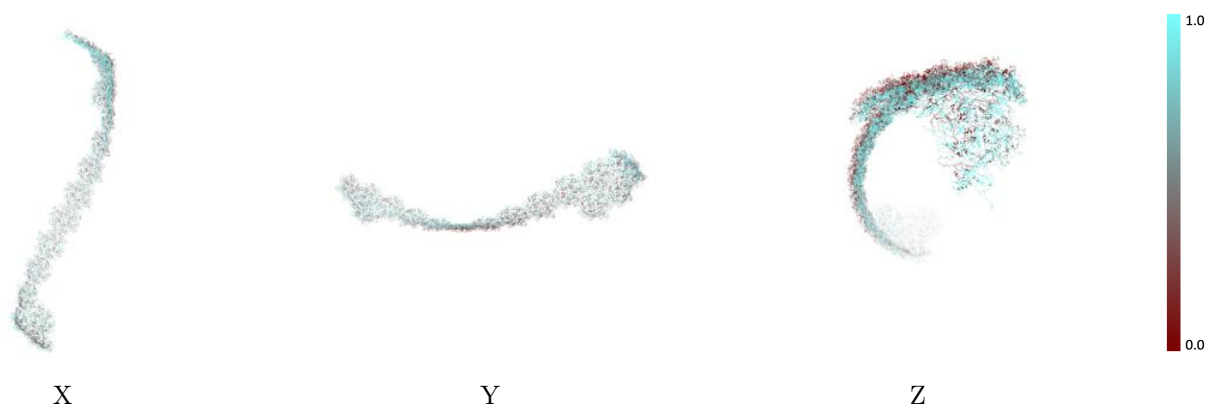

The images above show the model with each residue coloured according to its atom inclusion. This shows to what extent they are inside the map at the recommended contour level (0.02).



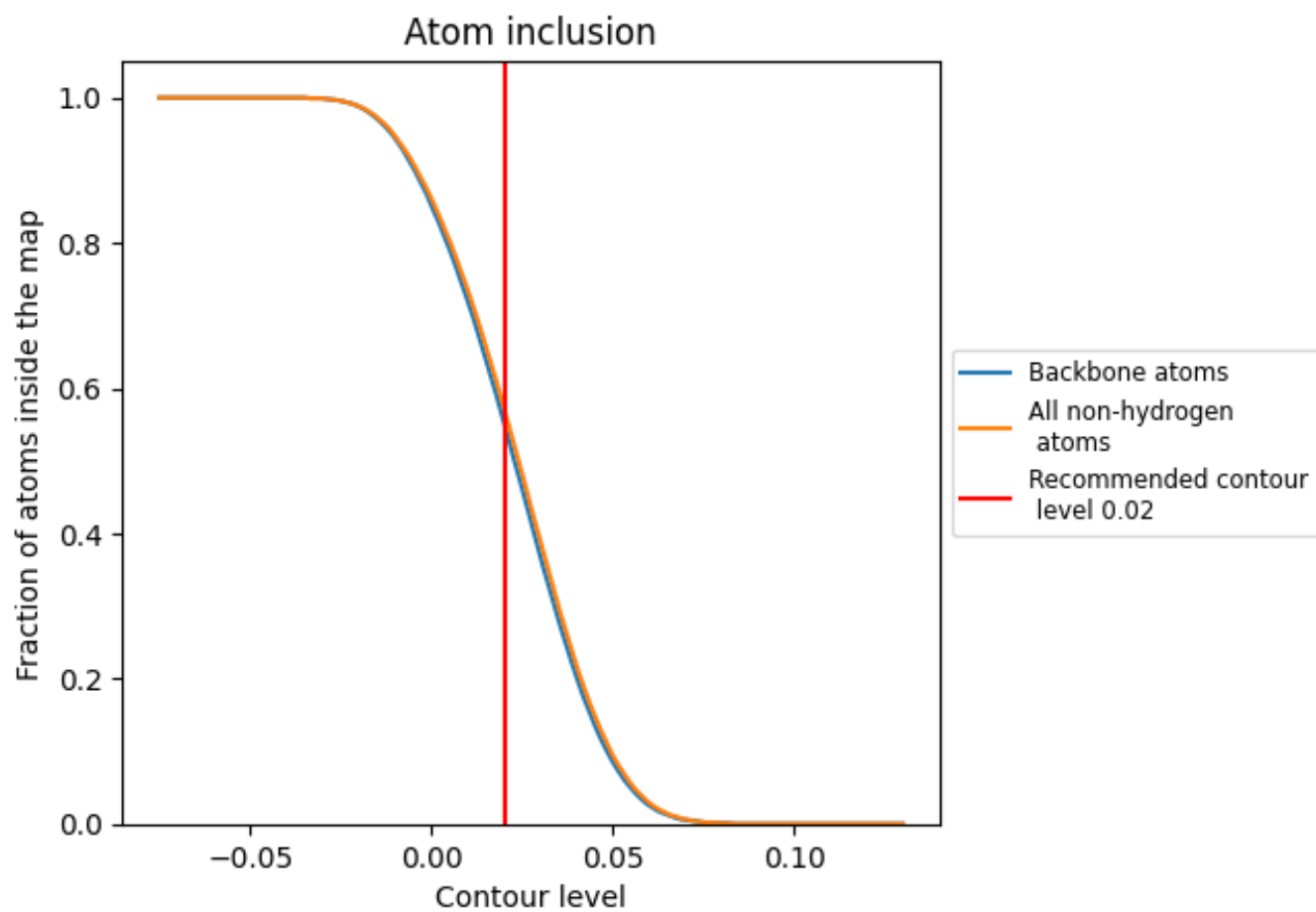



































































9.4 Atom inclusion [i](#)



At the recommended contour level, 55% of all backbone atoms, 57% of all non-hydrogen atoms, are inside the map.

9.5 Map-model fit summary





















































































The table lists the average atom inclusion at the recommended contour level (0.02) and Q-score for the entire model and for each chain.

Chain	Atom inclusion	Q-score
All	 0.5720	 -0.0070
AA	 0.5240	 -0.0060
AB	 0.5190	 -0.0150
AC	 0.5150	 -0.0170
AD	 0.4920	 -0.0130
AE	 0.4760	 -0.0230
AF	 0.5050	 -0.0110
AG	 0.5680	 -0.0120
AH	 0.5080	 -0.0190
AI	 0.5220	 -0.0230
AJ	 0.5550	 -0.0040
AK	 0.5200	 -0.0020
AL	 0.5250	 -0.0140
AM	 0.5560	 -0.0160
AN	 0.4960	 -0.0070
AO	 0.5180	 -0.0210
AP	 0.5250	 -0.0010
AQ	 0.4840	 -0.0120
AR	 0.4990	 -0.0080
AS	 0.5300	 -0.0020
AT	 0.4930	 -0.0240
AU	 0.5040	 -0.0090
AV	 0.5310	 -0.0140
AW	 0.5130	 -0.0090
AX	 0.5340	 -0.0090
AY	 0.5410	 0.0010
AZ	 0.5990	 -0.0100
BA	 0.5300	 0.0060
BB	 0.5550	 -0.0030
BC	 0.6090	 -0.0030
BD	 0.6120	 -0.0160
BE	 0.5210	 -0.0100
BF	 0.5660	 -0.0030
BG	 0.5530	 0.0040
BH	 0.5120	 -0.0150









































Continued on next page...

Continued from previous page...

Chain	Atom inclusion	Q-score
BI	 0.6880	 0.0030
BJ	 0.5710	 -0.0160
BK	 0.4970	 -0.0070
BL	 0.5700	 0.0160
BM	 0.5140	 -0.0080
BN	 0.4790	 -0.0010
BO	 0.6040	 0.0060
BP	 0.5370	 -0.0000
BQ	 0.4920	 -0.0190
BR	 0.5920	 -0.0110
BS	 0.5860	 0.0090
BT	 0.5440	 0.0030
BU	 0.6000	 -0.0180
BV	 0.5980	 -0.0120
BW	 0.7110	 0.0030
BX	 0.6520	 -0.0060
BY	 0.6930	 -0.0120
BZ	 0.6610	 -0.0200
CA	 0.6160	 0.0030
CB	 0.6080	 0.0020
CC	 0.7110	 -0.0010
CD	 0.5670	 -0.0090
CE	 0.6340	 -0.0190
CF	 0.5400	 -0.0140
CG	 0.5540	 -0.0120
CH	 0.5750	 -0.0150
CI	 0.6890	 -0.0230
CJ	 0.5920	 0.0040
CK	 0.5450	 -0.0090
CL	 0.5380	 -0.0100
CM	 0.7350	 -0.0060
CN	 0.5220	 -0.0150
CO	 0.5460	 -0.0150
CP	 0.5510	 0.0090
CQ	 0.6450	 0.0150
CR	 0.5680	 0.0000
CS	 0.5300	 0.0070
CT	 0.5880	 -0.0140
CU	 0.6000	 -0.0060
CV	 0.6070	 -0.0100
CW	 0.5240	 -0.0240
CX	 0.5770	 -0.0230

Continued on next page...

Continued from previous page...

Chain	Atom inclusion	Q-score
CY	 0.6220	 -0.0080
CZ	 0.5540	 -0.0070
DA	 0.5640	 -0.0020
DB	 0.5730	 -0.0290
DC	 0.5870	 -0.0060
DD	 0.5780	 -0.0130
DE	 0.5900	 -0.0110
DF	 0.5010	 -0.0240
DG	 0.6510	 -0.0110
DH	 0.6360	 -0.0060
DI	 0.6320	 0.0100
DJ	 0.6310	 -0.0150
DK	 0.5860	 0.0050
DL	 0.6080	 -0.0020
DM	 0.6470	 0.0280
DN	 0.6650	 0.0030
DO	 0.6270	 -0.0040
DP	 0.6600	 -0.0040
DQ	 0.6590	 0.0150