



# Full wwPDB X-ray Structure Validation Report ⓘ

Nov 22, 2023 – 11:40 AM JST

PDB ID : 7WG3  
Title : Structural basis of interleukin-17B receptor in complex with a neutralizing antibody D9 for guiding humanization and affinity maturation for cancer therapy  
Authors : Lee, W.H.; Chen, X.R.; Liu, I.J.; Lee, J.H.; Hu, C.M.; Wu, H.C.; Wang, S.K.; Lee, W.H.; Ma, C.  
Deposited on : 2021-12-28  
Resolution : 2.19 Å(reported)

This is a Full wwPDB X-ray Structure Validation Report for a publicly released PDB entry.

We welcome your comments at [validation@mail.wwpdb.org](mailto:validation@mail.wwpdb.org)

A user guide is available at

<https://www.wwpdb.org/validation/2017/XrayValidationReportHelp>

with specific help available everywhere you see the ⓘ symbol.

The types of validation reports are described at

<http://www.wwpdb.org/validation/2017/FAQs#types>.

---

The following versions of software and data (see [references ⓘ](#)) were used in the production of this report:

MolProbity : 4.02b-467  
Mogul : 1.8.5 (274361), CSD as541be (2020)  
Xtriage (Phenix) : 1.13  
EDS : 2.36  
Percentile statistics : 20191225.v01 (using entries in the PDB archive December 25th 2019)  
Refmac : 5.8.0158  
CCP4 : 7.0.044 (Gargrove)  
Ideal geometry (proteins) : Engh & Huber (2001)  
Ideal geometry (DNA, RNA) : Parkinson et al. (1996)  
Validation Pipeline (wwPDB-VP) : 2.36

# 1 Overall quality at a glance

The following experimental techniques were used to determine the structure:

*X-RAY DIFFRACTION*

The reported resolution of this entry is 2.19 Å.

Percentile scores (ranging between 0-100) for global validation metrics of the entry are shown in the following graphic. The table shows the number of entries on which the scores are based.

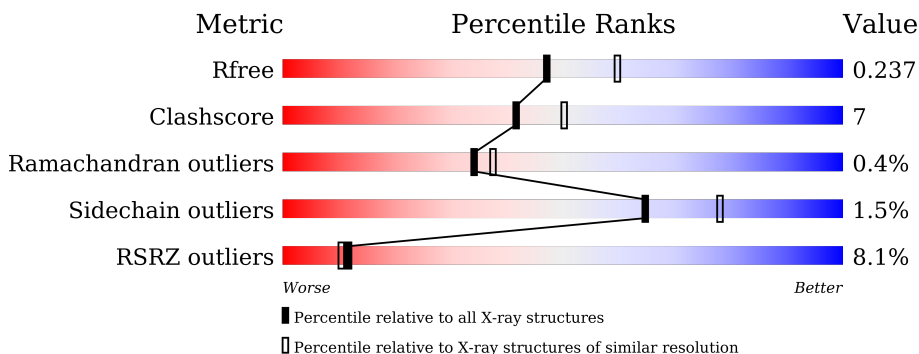

Metric	Whole archive (#Entries)	Similar resolution (#Entries, resolution range(Å))
$R_{free}$	130704	4898 (2.20-2.20)
Clashscore	141614	5594 (2.20-2.20)
Ramachandran outliers	138981	5503 (2.20-2.20)
Sidechain outliers	138945	5504 (2.20-2.20)
RSRZ outliers	127900	4800 (2.20-2.20)

The table below summarises the geometric issues observed across the polymeric chains and their fit to the electron density. The red, orange, yellow and green segments of the lower bar indicate the fraction of residues that contain outliers for  $\geq 3$ , 2, 1 and 0 types of geometric quality criteria respectively. A grey segment represents the fraction of residues that are not modelled. The numeric value for each fraction is indicated below the corresponding segment, with a dot representing fractions  $\leq 5\%$ . The upper red bar (where present) indicates the fraction of residues that have poor fit to the electron density. The numeric value is given above the bar.

Mol	Chain	Length	Quality of chain
1	A	213	
1	B	213	
1	C	213	
1	D	213	
2	E	220	
2	F	220	

*Continued on next page...*

Continued from previous page...

Mol	Chain	Length	Quality of chain
2	G	220	
2	H	220	
3	I	255	
3	J	255	
3	K	255	
3	L	255	
4	M	6	
5	N	5	

The following table lists non-polymeric compounds, carbohydrate monomers and non-standard residues in protein, DNA, RNA chains that are outliers for geometric or electron-density-fit criteria:

Mol	Type	Chain	Res	Chirality	Geometry	Clashes	Electron density
4	MAN	M	5	-	-	-	X
5	MAN	N	4	-	-	-	X
5	MAN	N	5	-	-	-	X
6	NAG	L	304	-	-	-	X

## 2 Entry composition [i](#)

There are 7 unique types of molecules in this entry. The entry contains 21987 atoms, of which 0 are hydrogens and 0 are deuteriums.

In the tables below, the ZeroOcc column contains the number of atoms modelled with zero occupancy, the AltConf column contains the number of residues with at least one atom in alternate conformation and the Trace column contains the number of residues modelled with at most 2 atoms.

- Molecule 1 is a protein called Light chain of D9 Fab.

Mol	Chain	Residues	Atoms					ZeroOcc	AltConf	Trace
			Total	C	N	O	S			
1	A	213	Total 1638	C 1024	N 270	O 336	S 8	0	1	0
1	B	213	Total 1622	C 1016	N 268	O 330	S 8	0	1	0
1	C	213	Total 1624	C 1016	N 268	O 333	S 7	0	0	0
1	D	213	Total 1624	C 1017	N 269	O 331	S 7	0	0	0

- Molecule 2 is a protein called Heavy chain of D9 Fab.

Mol	Chain	Residues	Atoms					ZeroOcc	AltConf	Trace
			Total	C	N	O	S			
2	E	220	Total 1633	C 1029	N 270	O 328	S 6	0	1	0
2	F	220	Total 1644	C 1036	N 269	O 334	S 5	0	0	0
2	G	220	Total 1628	C 1028	N 265	O 330	S 5	0	0	0
2	H	220	Total 1635	C 1031	N 266	O 332	S 6	0	0	0

- Molecule 3 is a protein called IL17RB protein.

Mol	Chain	Residues	Atoms					ZeroOcc	AltConf	Trace
			Total	C	N	O	S			
3	I	248	Total 1905	C 1198	N 329	O 362	S 16	0	0	0
3	J	245	Total 1883	C 1188	N 322	O 357	S 16	0	0	0
3	K	251	Total 1927	C 1210	N 333	O 368	S 16	0	0	0
3	L	236	Total 1800	C 1140	N 305	O 339	S 16	0	1	0

- Molecule 4 is an oligosaccharide called alpha-D-mannopyranose-(1-6)-alpha-D-mannopyranose-(1-6)-[alpha-D-mannopyranose-(1-3)]beta-D-mannopyranose-(1-4)-2-acetamido-2-deoxy-beta-D-glucopyranose-(1-4)-2-acetamido-2-deoxy-beta-D-glucopyranose.

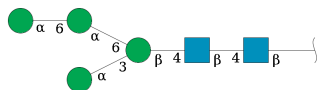

Mol	Chain	Residues	Atoms				ZeroOcc	AltConf	Trace
			Total	C	N	O			
4	M	6	72	40	2	30	0	0	0

- Molecule 5 is an oligosaccharide called alpha-D-mannopyranose-(1-3)-[alpha-D-mannopyranose-(1-6)]beta-D-mannopyranose-(1-4)-2-acetamido-2-deoxy-beta-D-glucopyranose-(1-4)-2-acetamido-2-deoxy-beta-D-glucopyranose.

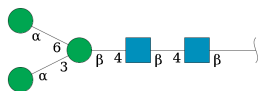

Mol	Chain	Residues	Atoms				ZeroOcc	AltConf	Trace
			Total	C	N	O			
5	N	5	61	34	2	25	0	0	0

- Molecule 6 is 2-acetamido-2-deoxy-beta-D-glucopyranose (three-letter code: NAG) (formula: C<sub>8</sub>H<sub>15</sub>NO<sub>6</sub>).

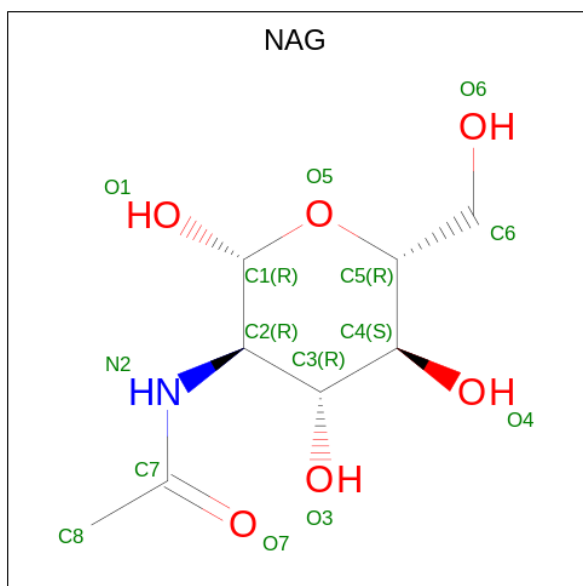

Mol	Chain	Residues	Atoms				ZeroOcc	AltConf
6	I	1	Total	C	N	O	0	0
			14	8	1	5		
6	I	1	Total	C	N	O	0	0
			14	8	1	5		
6	I	1	Total	C	N	O	0	0
			14	8	1	5		
6	J	1	Total	C	N	O	0	0
			14	8	1	5		
6	J	1	Total	C	N	O	0	0
			14	8	1	5		
6	J	1	Total	C	N	O	0	0
			14	8	1	5		
6	J	1	Total	C	N	O	0	0
			14	8	1	5		
6	K	1	Total	C	N	O	0	0
			14	8	1	5		
6	K	1	Total	C	N	O	0	0
			14	8	1	5		
6	K	1	Total	C	N	O	0	0
			14	8	1	5		
6	K	1	Total	C	N	O	0	0
			14	8	1	5		
6	L	1	Total	C	N	O	0	0
			14	8	1	5		
6	L	1	Total	C	N	O	0	0
			14	8	1	5		
6	L	1	Total	C	N	O	0	0
			14	8	1	5		
6	L	1	Total	C	N	O	0	0
			14	8	1	5		

- Molecule 7 is water.

Mol	Chain	Residues	Atoms		ZeroOcc	AltConf
7	A	139	Total	O	0	0
			139	139		
7	B	83	Total	O	0	0
			83	83		

*Continued on next page...*

*Continued from previous page...*

Mol	Chain	Residues	Atoms		ZeroOcc	AltConf
7	C	145	Total 145	O 145	0	0
7	D	118	Total 118	O 118	0	0
7	E	90	Total 90	O 90	0	0
7	F	98	Total 98	O 98	0	0
7	G	111	Total 111	O 111	0	0
7	H	66	Total 66	O 66	0	0
7	I	62	Total 62	O 62	0	0
7	J	30	Total 30	O 30	0	0
7	K	62	Total 62	O 62	0	0
7	L	35	Total 35	O 35	0	0

### 3 Residue-property plots [i](#)

These plots are drawn for all protein, RNA, DNA and oligosaccharide chains in the entry. The first graphic for a chain summarises the proportions of the various outlier classes displayed in the second graphic. The second graphic shows the sequence view annotated by issues in geometry and electron density. Residues are color-coded according to the number of geometric quality criteria for which they contain at least one outlier: green = 0, yellow = 1, orange = 2 and red = 3 or more. A red dot above a residue indicates a poor fit to the electron density ( $RSRZ > 2$ ). Stretches of 2 or more consecutive residues without any outlier are shown as a green connector. Residues present in the sample, but not in the model, are shown in grey.

- Molecule 1: Light chain of D9 Fab

Chain A:  91% 8%



- Molecule 1: Light chain of D9 Fab

Chain B:  5% 87% 12%



- Molecule 1: Light chain of D9 Fab

Chain C:  95% 5%



- Molecule 1: Light chain of D9 Fab

Chain D:  87% 13%

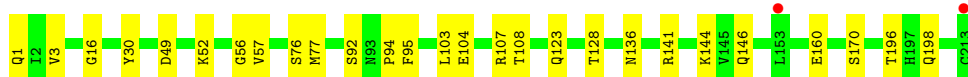

- Molecule 2: Heavy chain of D9 Fab

Chain E:  3% 85% 15%





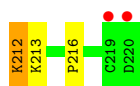

- Molecule 2: Heavy chain of D9 Fab



- Molecule 2: Heavy chain of D9 Fab

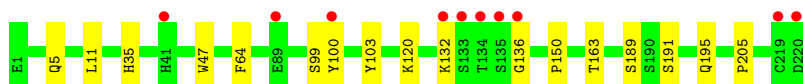

- Molecule 2: Heavy chain of D9 Fab

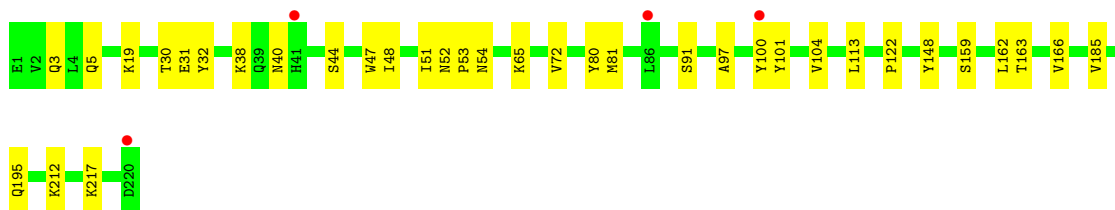
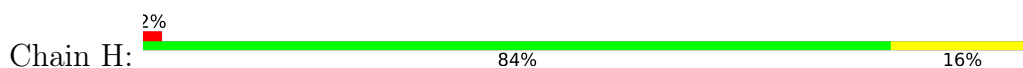

- Molecule 3: IL17RB protein

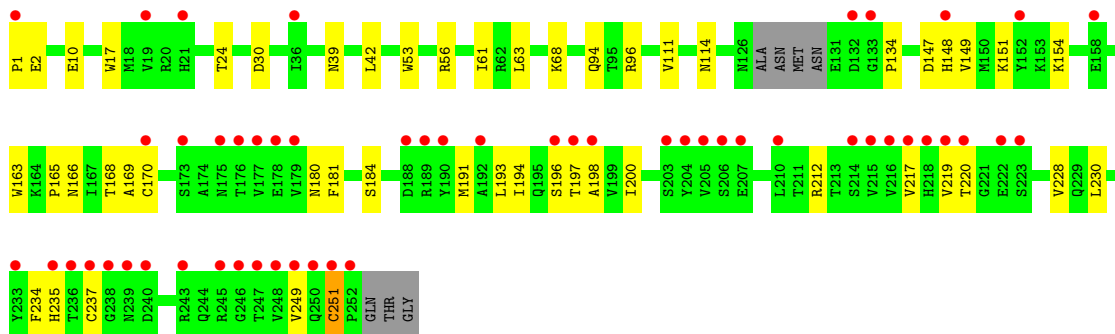
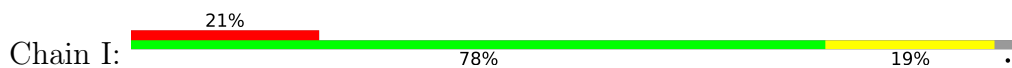

- Molecule 3: IL17RB protein

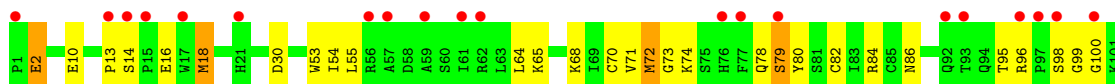

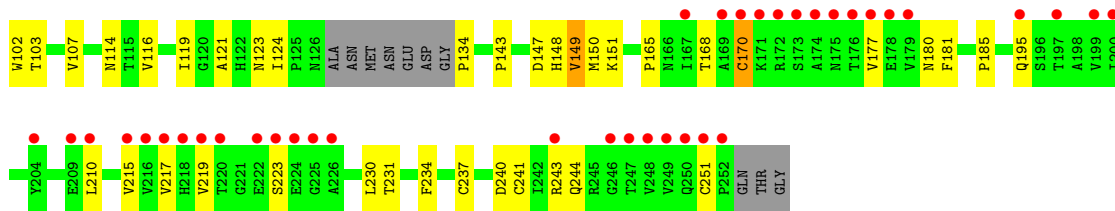

• Molecule 3: IL17RB protein

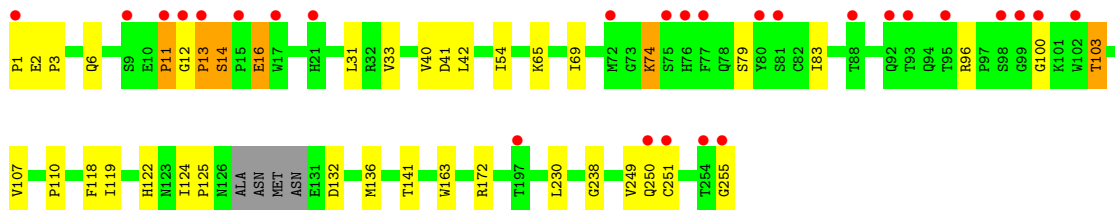
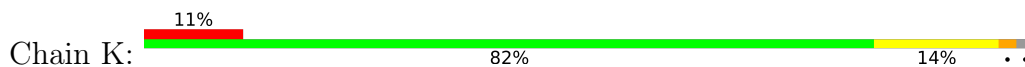

• Molecule 3: IL17RB protein

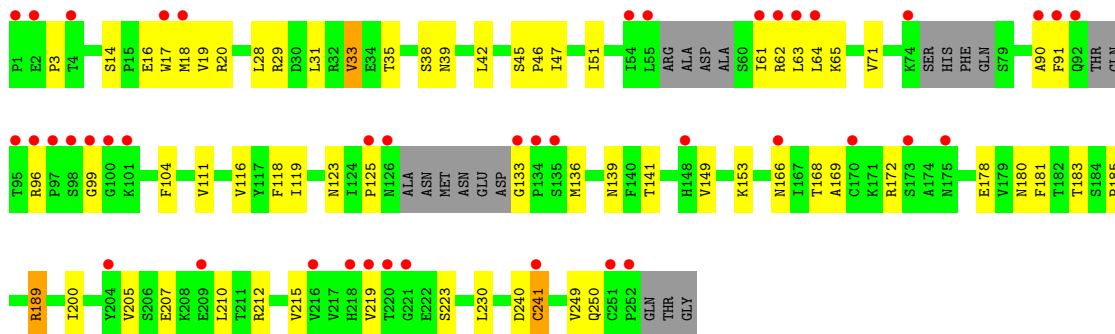

• Molecule 4: alpha-D-mannopyranose-(1-6)-alpha-D-mannopyranose-(1-6)-[alpha-D-mannopyranose-(1-3)]beta-D-mannopyranose-(1-4)-2-acetamido-2-deoxy-beta-D-glucopyranose-(1-4)-2-acetamido-2-deoxy-beta-D-glucopyranose

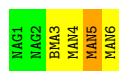

• Molecule 5: alpha-D-mannopyranose-(1-3)-[alpha-D-mannopyranose-(1-6)]beta-D-mannopyranose-(1-4)-2-acetamido-2-deoxy-beta-D-glucopyranose-(1-4)-2-acetamido-2-deoxy-beta-D-glucopyranose



## 4 Data and refinement statistics

Property	Value	Source
Space group	P 1 21 1	Depositor
Cell constants a, b, c, $\alpha$ , $\beta$ , $\gamma$	70.02Å 195.03Å 98.84Å 90.00° 98.13° 90.00°	Depositor
Resolution (Å)	38.03 – 2.19 38.03 – 2.19	Depositor EDS
% Data completeness (in resolution range)	100.0 (38.03-2.19) 100.0 (38.03-2.19)	Depositor EDS
$R_{merge}$	0.06	Depositor
$R_{sym}$	(Not available)	Depositor
$\langle I/\sigma(I) \rangle$ <sup>1</sup>	1.67 (at 2.20Å)	Xtrriage
Refinement program	PHENIX 1.19.2_4158	Depositor
R, $R_{free}$	0.193 , 0.238 0.193 , 0.237	Depositor DCC
$R_{free}$ test set	6853 reflections (5.11%)	wwPDB-VP
Wilson B-factor (Å <sup>2</sup> )	36.4	Xtrriage
Anisotropy	0.257	Xtrriage
Bulk solvent $k_{sol}$ (e/Å <sup>3</sup> ), $B_{sol}$ (Å <sup>2</sup> )	0.31 , 47.8	EDS
L-test for twinning <sup>2</sup>	$\langle  L  \rangle = 0.49$ , $\langle L^2 \rangle = 0.32$	Xtrriage
Estimated twinning fraction	No twinning to report.	Xtrriage
$F_o, F_c$ correlation	0.95	EDS
Total number of atoms	21987	wwPDB-VP
Average B, all atoms (Å <sup>2</sup> )	46.0	wwPDB-VP

Xtrriage's analysis on translational NCS is as follows: *The largest off-origin peak in the Patterson function is 4.03% of the height of the origin peak. No significant pseudotranslation is detected.*

<sup>1</sup>Intensities estimated from amplitudes.

<sup>2</sup>Theoretical values of  $\langle |L| \rangle$ ,  $\langle L^2 \rangle$  for acentric reflections are 0.5, 0.333 respectively for untwinned datasets, and 0.375, 0.2 for perfectly twinned datasets.

## 5 Model quality [i](#)

### 5.1 Standard geometry [i](#)

Bond lengths and bond angles in the following residue types are not validated in this section: MAN, NAG, BMA

The Z score for a bond length (or angle) is the number of standard deviations the observed value is removed from the expected value. A bond length (or angle) with  $|Z| > 5$  is considered an outlier worth inspection. RMSZ is the root-mean-square of all Z scores of the bond lengths (or angles).

Mol	Chain	Bond lengths		Bond angles	
		RMSZ	# Z  >5	RMSZ	# Z  >5
1	A	0.49	0/1676	0.66	0/2276
1	B	0.42	0/1660	0.63	0/2256
1	C	0.50	0/1662	0.67	0/2259
1	D	0.47	0/1662	0.64	0/2258
2	E	0.43	0/1674	0.65	0/2285
2	F	0.44	0/1686	0.67	1/2301 (0.0%)
2	G	0.43	0/1670	0.64	0/2282
2	H	0.42	0/1677	0.65	0/2290
3	I	0.41	0/1949	0.69	2/2654 (0.1%)
3	J	0.49	2/1927 (0.1%)	0.66	0/2623
3	K	0.41	0/1970	0.70	0/2679
3	L	0.40	0/1838	0.69	1/2497 (0.0%)
All	All	0.44	2/21051 (0.0%)	0.66	4/28660 (0.0%)

All (2) bond length outliers are listed below:

Mol	Chain	Res	Type	Atoms	Z	Observed(Å)	Ideal(Å)
3	J	170	CYS	CB-SG	-11.37	1.62	1.82
3	J	251	CYS	CB-SG	-6.36	1.71	1.82

All (4) bond angle outliers are listed below:

Mol	Chain	Res	Type	Atoms	Z	Observed(°)	Ideal(°)
3	L	189	ARG	NE-CZ-NH1	7.70	124.15	120.30
2	F	181	LEU	CA-CB-CG	7.35	132.21	115.30
3	I	154	LYS	CD-CE-NZ	-5.50	99.06	111.70
3	I	63	LEU	CB-CG-CD2	-5.48	101.68	111.00

There are no chirality outliers.

There are no planarity outliers.

## 5.2 Too-close contacts

In the following table, the Non-H and H(model) columns list the number of non-hydrogen atoms and hydrogen atoms in the chain respectively. The H(added) column lists the number of hydrogen atoms added and optimized by MolProbity. The Clashes column lists the number of clashes within the asymmetric unit, whereas Symm-Clashes lists symmetry-related clashes.

Mol	Chain	Non-H	H(model)	H(added)	Clashes	Symm-Clashes
1	A	1638	0	1569	17	0
1	B	1622	0	1549	22	0
1	C	1624	0	1550	8	0
1	D	1624	0	1557	18	0
2	E	1633	0	1567	29	0
2	F	1644	0	1575	17	0
2	G	1628	0	1543	14	0
2	H	1635	0	1563	29	0
3	I	1905	0	1853	32	0
3	J	1883	0	1843	50	0
3	K	1927	0	1888	22	0
3	L	1800	0	1762	45	1
4	M	72	0	61	3	0
5	N	61	0	52	2	0
6	I	56	0	52	2	1
6	J	56	0	52	1	0
6	K	70	0	65	0	0
6	L	70	0	65	3	0
7	A	139	0	0	8	0
7	B	83	0	0	6	1
7	C	145	0	0	3	0
7	D	118	0	0	4	1
7	E	90	0	0	7	1
7	F	98	0	0	7	1
7	G	111	0	0	4	0
7	H	66	0	0	10	0
7	I	62	0	0	3	0
7	J	30	0	0	4	0
7	K	62	0	0	4	0
7	L	35	0	0	3	0
All	All	21987	0	20166	286	3

The all-atom clashscore is defined as the number of clashes found per 1000 atoms (including hydrogen atoms). The all-atom clashscore for this structure is 7.

All (286) close contacts within the same asymmetric unit are listed below, sorted by their clash magnitude.

Atom-1	Atom-2	Interatomic distance (Å)	Clash overlap (Å)
2:E:41:HIS:ND1	7:E:301:HOH:O	1.98	0.97
2:H:54:ASN:HD21	3:L:116:VAL:HG11	1.29	0.96
2:H:195:GLN:O	7:H:301:HOH:O	1.85	0.95
1:A:141:ARG:HD3	7:A:307:HOH:O	1.65	0.94
2:H:212:LYS:NZ	7:H:304:HOH:O	2.03	0.90
2:F:73:ASP:OD2	7:F:301:HOH:O	1.90	0.89
2:F:220:ASP:OD2	7:F:302:HOH:O	1.90	0.88
1:A:107:ARG:NH1	1:A:108:THR:O	2.08	0.87
3:K:110:PRO:O	7:K:401:HOH:O	1.92	0.87
2:H:65:LYS:O	7:H:302:HOH:O	1.93	0.86
7:A:317:HOH:O	2:E:44:SER:HB2	1.74	0.86
3:I:1:PRO:HG3	4:M:5:MAN:H3	1.58	0.84
3:J:241:CYS:O	3:J:243:ARG:NH1	2.14	0.81
2:G:191:SER:HB2	2:G:195:GLN:HG3	1.63	0.80
1:D:160:GLU:OE2	7:D:303:HOH:O	2.00	0.80
3:L:65:LYS:HG2	3:L:125:PRO:HD3	1.63	0.79
3:J:54:ILE:HG12	3:J:103:THR:HG22	1.62	0.79
2:H:54:ASN:ND2	3:L:116:VAL:HG11	1.98	0.78
3:K:1:PRO:HB3	3:K:96:ARG:HD3	1.66	0.77
3:I:148:HIS:HA	3:I:151:LYS:HD3	1.66	0.76
1:D:107:ARG:NH1	1:D:108:THR:O	2.19	0.76
3:I:24:THR:HG1	6:I:302:NAG:HO3	1.30	0.75
1:A:213:CYS:SG	7:A:393:HOH:O	2.45	0.75
3:K:74:LYS:HD2	3:K:118:PHE:HB2	1.67	0.75
2:G:132:LYS:O	7:G:302:HOH:O	2.04	0.75
2:G:64:PHE:O	7:G:301:HOH:O	2.04	0.75
1:D:104:GLU:OE2	1:D:141:ARG:NH2	2.20	0.74
2:G:11:LEU:HD21	2:G:150:PRO:HG3	1.68	0.74
3:J:10:GLU:OE1	3:J:84:ARG:HB2	1.87	0.74
1:D:52:LYS:NZ	7:D:302:HOH:O	1.93	0.74
3:K:255:GLY:O	7:K:402:HOH:O	2.05	0.74
2:F:84:ARG:NH2	7:F:304:HOH:O	2.19	0.73
1:B:107:ARG:NH1	1:B:108:THR:O	2.22	0.73
3:L:118:PHE:HA	3:L:139:ASN:OD1	1.89	0.71
1:C:207:SER:O	7:C:301:HOH:O	2.07	0.71
1:B:108:THR:OG1	7:B:301:HOH:O	2.08	0.71
3:J:219:VAL:HG21	3:J:223:SER:HB3	1.72	0.71
1:B:198:GLN:NE2	7:B:305:HOH:O	2.22	0.71
3:J:99:GLY:O	7:J:401:HOH:O	2.09	0.70
1:A:52:LYS:NZ	7:A:302:HOH:O	2.15	0.70
2:E:191:SER:HB2	2:E:195:GLN:HG3	1.72	0.70
7:F:304:HOH:O	2:G:5:GLN:HG3	1.92	0.69

*Continued on next page...*

*Continued from previous page...*

Atom-1	Atom-2	Interatomic distance (Å)	Clash overlap (Å)
3:J:68:LYS:HE3	3:J:82:CYS:HB3	1.72	0.69
2:H:91:SER:O	7:H:305:HOH:O	2.10	0.69
2:E:179:TYR:OH	7:E:302:HOH:O	2.11	0.69
3:L:71:VAL:HG22	3:L:119:ILE:HG12	1.76	0.68
3:J:84:ARG:NH1	3:J:86:ASN:OD1	2.27	0.67
1:B:79:ALA:HA	1:B:105:ILE:HD13	1.75	0.67
1:B:95:PHE:HB3	2:F:47:TRP:CD2	2.30	0.66
2:H:52:ASN:ND2	6:L:303:NAG:O6	2.28	0.66
3:K:11:PRO:C	3:K:13:PRO:HD3	2.15	0.66
3:J:114:ASN:OD1	7:J:402:HOH:O	2.13	0.66
3:K:54:ILE:HG22	3:K:103:THR:HG23	1.79	0.65
3:L:189:ARG:HG3	3:L:189:ARG:HH11	1.62	0.65
3:J:165:PRO:HG3	3:J:244:GLN:HG3	1.79	0.64
3:J:231:THR:HG23	3:J:243:ARG:HE	1.61	0.64
3:L:111:VAL:O	3:L:153:LYS:NZ	2.30	0.64
2:G:100:TYR:HD2	2:G:103:TYR:HH	1.45	0.64
3:L:64:LEU:HD11	3:L:123:ASN:HB3	1.79	0.64
2:F:100:TYR:CE1	6:J:302:NAG:H5	2.33	0.64
1:A:95:PHE:HB3	2:E:47:TRP:CD2	2.33	0.64
1:A:160:GLU:OE1	7:A:301:HOH:O	2.14	0.63
4:M:3:BMA:H61	4:M:5:MAN:H2	1.79	0.63
1:B:144:LYS:HB3	1:B:196:THR:HB	1.79	0.63
2:H:3:GLN:OE1	2:H:5:GLN:NE2	2.24	0.63
3:K:12:GLY:N	3:K:13:PRO:HD3	2.14	0.62
3:J:231:THR:HA	3:J:243:ARG:HG3	1.81	0.62
3:L:166:ASN:O	3:L:212:ARG:NH2	2.31	0.62
2:F:11:LEU:HD22	2:F:119:THR:HG23	1.81	0.62
3:I:163:TRP:CZ2	3:I:165:PRO:HB3	2.35	0.62
3:J:55:LEU:HB2	3:J:102:TRP:HB2	1.81	0.62
1:D:95:PHE:HB3	2:H:47:TRP:CD2	2.35	0.61
1:C:95:PHE:HB3	2:G:47:TRP:CD2	2.36	0.61
2:H:100:TYR:HA	7:H:303:HOH:O	2.00	0.61
1:A:60:ARG:NH1	1:A:81:ASP:OD1	2.34	0.61
3:L:219:VAL:HG11	3:L:223:SER:HB3	1.83	0.61
1:B:52:LYS:NZ	7:B:310:HOH:O	2.26	0.60
3:K:238:GLY:O	7:K:403:HOH:O	2.16	0.60
3:J:13:PRO:O	3:J:80:TYR:OH	2.12	0.60
3:K:33:VAL:HG21	3:K:119:ILE:HD12	1.84	0.59
1:B:11:MET:HE1	1:B:21:MET:HB3	1.83	0.59
3:L:19:VAL:HG13	6:L:303:NAG:H62	1.85	0.59
3:J:65:LYS:HE3	3:J:124:ILE:HG22	1.84	0.59

*Continued on next page...*

*Continued from previous page...*

Atom-1	Atom-2	Interatomic distance (Å)	Clash overlap (Å)
1:C:78:GLU:OE2	7:C:302:HOH:O	2.17	0.58
3:I:39:ASN:HB3	3:I:42:LEU:HD13	1.85	0.58
3:J:2:GLU:HG2	3:J:96:ARG:HH11	1.68	0.58
2:G:35:HIS:CD2	2:G:99:SER:HB3	2.40	0.57
3:I:1:PRO:HB3	3:I:96:ARG:HH22	1.68	0.57
3:K:31:LEU:HB2	3:K:136:MET:HB3	1.85	0.57
2:E:12:VAL:CG1	2:E:16:ALA:HB3	2.34	0.57
3:L:20:ARG:HD3	3:L:133:GLY:N	2.19	0.57
1:A:160:GLU:OE2	7:A:303:HOH:O	2.17	0.57
2:H:166:VAL:HG22	2:H:185:VAL:HG12	1.86	0.57
1:B:42:SER:O	7:B:303:HOH:O	2.17	0.57
2:F:76:SER:N	7:F:301:HOH:O	2.02	0.57
3:L:64:LEU:HD12	3:L:125:PRO:HD2	1.87	0.57
1:D:1:GLN:HB2	1:D:94:PRO:HD2	1.86	0.56
3:I:170:CYS:HB2	6:I:304:NAG:H83	1.87	0.56
3:I:166:ASN:O	3:I:212:ARG:NH2	2.22	0.56
3:J:18:MET:HA	3:J:134:PRO:HG3	1.86	0.56
3:J:74:LYS:O	3:J:116:VAL:HG12	2.05	0.56
3:J:143:PRO:HG2	3:J:150:MET:HG3	1.88	0.56
1:D:16:GLY:N	1:D:77:MET:O	2.31	0.56
2:E:91:SER:HA	2:E:113:LEU:O	2.05	0.55
3:J:231:THR:HG23	3:J:243:ARG:NE	2.21	0.55
2:F:73:ASP:OD2	2:F:76:SER:OG	2.23	0.55
3:J:143:PRO:HB2	3:J:147:ASP:HB2	1.89	0.55
3:J:68:LYS:HE2	3:J:70:CYS:SG	2.47	0.55
3:L:35:THR:HG22	3:L:149:VAL:HG11	1.89	0.54
3:L:39:ASN:HB2	3:L:45:SER:HB2	1.89	0.54
1:B:166:ASP:OD2	7:B:304:HOH:O	2.19	0.54
2:E:195:GLN:OE1	7:E:305:HOH:O	2.18	0.54
2:E:7:SER:O	7:E:306:HOH:O	2.19	0.54
2:G:11:LEU:HD11	2:G:205:PRO:HB3	1.90	0.53
3:K:6:GLN:NE2	7:K:406:HOH:O	2.32	0.53
1:D:77:MET:SD	1:D:103:LEU:HD21	2.49	0.53
2:E:12:VAL:HG13	2:E:16:ALA:HB3	1.90	0.53
2:E:135:SER:C	2:E:137:GLY:H	2.12	0.53
3:L:38:SER:OG	3:L:46:PRO:HG2	2.09	0.52
1:B:148:LYS:HG3	1:B:153:LEU:HA	1.91	0.52
3:J:195:GLN:NE2	7:J:404:HOH:O	2.42	0.52
3:K:2:GLU:HB2	3:K:3:PRO:HD3	1.91	0.52
3:L:61:ILE:HA	7:L:420:HOH:O	2.09	0.52
1:B:212:GLU:O	1:B:213:CYS:HB3	2.10	0.51

*Continued on next page...*



*Continued from previous page...*

Atom-1	Atom-2	Interatomic distance (Å)	Clash overlap (Å)
2:G:120:LYS:NZ	7:G:309:HOH:O	2.42	0.51
3:L:33:VAL:HG23	3:L:51:ILE:HG12	1.91	0.51
1:A:95:PHE:HB3	2:E:47:TRP:CE2	2.45	0.51
1:B:122:GLU:HA	1:B:125[B]:LYS:HE3	1.93	0.51
3:K:14:SER:C	3:K:16:GLU:H	2.14	0.51
3:L:64:LEU:CD1	3:L:123:ASN:HB3	2.40	0.51
2:H:30:THR:HA	2:H:53:PRO:HG2	1.93	0.51
3:I:196:SER:C	3:I:198:ALA:H	2.14	0.51
2:E:131:SER:HA	2:E:134:THR:HG23	1.94	0.50
3:L:168:THR:OG1	3:L:180:ASN:HB2	2.12	0.50
2:E:131:SER:HB3	2:E:216:PRO:HB3	1.94	0.50
3:L:205:VAL:HG21	3:L:215:VAL:HG21	1.93	0.50
3:L:241:CYS:HB2	7:L:406:HOH:O	2.11	0.50
3:I:169:ALA:CB	3:I:228:VAL:HG21	2.41	0.50
2:E:82:GLU:OE1	7:E:304:HOH:O	2.18	0.50
2:F:67:LYS:HE3	2:F:90:ASP:OD1	2.13	0.49
3:L:181:PHE:CG	3:L:230:LEU:HD21	2.47	0.49
2:H:97:ALA:HB1	2:H:104:VAL:CG1	2.42	0.49
3:K:65:LYS:HE2	3:K:125:PRO:HD3	1.93	0.49
3:J:219:VAL:HG21	3:J:223:SER:CB	2.40	0.49
2:H:44:SER:HB2	7:H:345:HOH:O	2.12	0.49
3:I:30:ASP:OD2	3:I:56:ARG:HD3	2.12	0.49
1:B:15:PRO:HG3	1:B:105:ILE:HD11	1.94	0.49
2:H:159:SER:OG	7:H:306:HOH:O	2.20	0.49
2:H:32:TYR:CE2	2:H:100:TYR:HB2	2.48	0.48
2:H:162:LEU:O	7:H:307:HOH:O	2.20	0.48
3:J:71:VAL:HG22	3:J:119:ILE:HG12	1.95	0.48
2:H:97:ALA:HB1	2:H:104:VAL:HG11	1.94	0.48
2:H:122:PRO:HB3	2:H:148:TYR:HB3	1.95	0.48
3:I:234:PHE:HB2	3:I:237:CYS:SG	2.54	0.48
3:J:14:SER:OG	3:J:16:GLU:OE1	2.17	0.48
3:J:68:LYS:O	3:J:121:ALA:HA	2.13	0.48
2:F:146:LYS:HB2	2:F:146:LYS:HE3	1.60	0.48
3:K:33:VAL:HG21	3:K:119:ILE:CD1	2.43	0.48
3:L:39:ASN:HB2	3:L:45:SER:CB	2.44	0.48
1:A:33:HIS:CG	2:E:103:TYR:HB3	2.49	0.47
2:E:101:TYR:N	7:E:303:HOH:O	2.46	0.47
3:L:168:THR:HB	6:L:305:NAG:H81	1.96	0.47
3:J:73:GLY:O	3:J:78:GLN:HA	2.14	0.47
3:J:148:HIS:NE2	3:J:149:VAL:HG23	2.29	0.47
1:D:107:ARG:HD2	1:D:170:SER:HB2	1.96	0.47

*Continued on next page...*

*Continued from previous page...*

Atom-1	Atom-2	Interatomic distance (Å)	Clash overlap (Å)
2:F:122:PRO:HD2	2:F:208:THR:HG21	1.96	0.47
3:I:1:PRO:HG3	4:M:5:MAN:C3	2.37	0.47
3:I:147:ASP:OD1	3:I:149:VAL:HG12	2.15	0.47
3:L:249:VAL:HG12	3:L:250:GLN:N	2.30	0.47
1:C:11:MET:HB2	3:L:99:GLY:HA2	1.96	0.47
3:J:168:THR:OG1	3:J:180:ASN:HB2	2.15	0.46
3:J:2:GLU:HG2	3:J:96:ARG:NH1	2.30	0.46
2:H:51:ILE:HD13	2:H:72:VAL:HG13	1.97	0.46
2:H:31:GLU:HG2	3:L:141:THR:H	1.81	0.46
2:F:101:TYR:N	7:F:306:HOH:O	2.36	0.46
3:J:74:LYS:NZ	3:J:74:LYS:HB3	2.31	0.46
2:E:67[B]:LYS:HB2	2:E:67[B]:LYS:HE3	1.78	0.46
3:I:17:TRP:CZ3	3:I:134:PRO:HB3	2.50	0.46
2:H:38:LYS:HB2	2:H:48:ILE:HD11	1.98	0.46
3:I:200:ILE:O	3:I:220:THR:HG23	2.16	0.46
3:J:95:THR:HB	3:J:100:GLY:O	2.16	0.46
3:K:69:ILE:HD12	3:K:83:ILE:HD11	1.98	0.45
1:A:141:ARG:NH1	7:A:307:HOH:O	2.30	0.45
1:A:77:MET:SD	1:A:103:LEU:HD21	2.57	0.45
2:G:100:TYR:HD2	2:G:103:TYR:OH	1.97	0.45
2:H:91:SER:HA	2:H:113:LEU:O	2.16	0.45
3:I:200:ILE:O	3:I:219:VAL:HA	2.16	0.45
3:K:41:ASP:OD1	3:K:42:LEU:HG	2.16	0.45
3:L:47:ILE:HG22	3:L:111:VAL:HB	1.98	0.45
1:A:107:ARG:HD2	1:A:170:SER:HB2	1.99	0.45
1:A:122:GLU:OE2	2:E:212:LYS:NZ	2.41	0.45
3:J:107:VAL:HG21	5:N:1:NAG:H82	1.98	0.45
1:B:125[A]:LYS:HB3	1:B:125[A]:LYS:HE2	1.86	0.45
1:C:162:VAL:HG22	1:C:174:LEU:HD12	1.99	0.45
3:I:61:ILE:HG21	3:I:94:GLN:HA	1.99	0.45
3:I:163:TRP:CD1	3:I:184:SER:HB2	2.51	0.45
3:J:96:ARG:HG2	3:J:98:SER:H	1.82	0.45
2:E:68:ALA:HA	2:E:82:GLU:O	2.17	0.45
2:E:149:PHE:CG	2:H:163:THR:HG21	2.52	0.45
2:H:101:TYR:N	7:H:303:HOH:O	1.94	0.45
1:D:144:LYS:HB3	1:D:196:THR:HB	1.99	0.44
2:E:51:ILE:HD13	2:E:72:VAL:HG13	1.98	0.44
3:I:10:GLU:HG2	3:I:68:LYS:HE2	1.99	0.44
1:A:210:ARG:NH1	7:A:304:HOH:O	2.19	0.44
1:D:16:GLY:HA2	1:D:76:SER:OG	2.17	0.44
2:E:196:THR:HG23	2:E:213:LYS:HE3	1.98	0.44

*Continued on next page...*

*Continued from previous page...*

Atom-1	Atom-2	Interatomic distance (Å)	Clash overlap (Å)
1:B:8:PRO:HD2	1:B:11:MET:HE2	1.99	0.44
3:I:147:ASP:HB2	7:I:429:HOH:O	2.17	0.44
3:L:249:VAL:HG12	3:L:250:GLN:H	1.82	0.44
2:F:88:SER:HB2	2:G:163:THR:HG21	2.00	0.44
3:L:185:PRO:HB3	3:L:210:LEU:HD11	1.98	0.44
1:C:123:GLN:HG2	1:C:128:THR:O	2.18	0.44
3:J:240:ASP:HA	3:J:243:ARG:HH12	1.81	0.44
3:K:163:TRP:CH2	3:K:230:LEU:HD13	2.52	0.44
1:D:56:GLY:CA	2:E:62:GLN:HG3	2.48	0.43
1:D:144:LYS:HE3	1:D:146:GLN:HG3	1.99	0.43
1:B:141:ARG:NH1	7:B:317:HOH:O	2.51	0.43
2:E:172:VAL:HG23	7:E:336:HOH:O	2.17	0.43
2:G:132:LYS:C	7:G:302:HOH:O	2.51	0.43
3:I:191:MET:HE3	3:I:193:LEU:HB2	2.00	0.43
3:J:96:ARG:NH2	3:J:98:SER:OG	2.51	0.43
1:C:1:GLN:N	1:C:93:ASN:O	2.50	0.43
1:D:198:GLN:NE2	7:D:306:HOH:O	2.26	0.43
3:K:132:ASP:OD1	3:K:132:ASP:N	2.51	0.43
3:J:243:ARG:NH2	7:J:409:HOH:O	2.51	0.43
1:A:104:GLU:OE2	1:A:141:ARG:NH2	2.52	0.43
3:J:74:LYS:HG2	3:J:78:GLN:HG2	1.99	0.43
1:D:49:ASP:OD1	3:L:29:ARG:NH2	2.48	0.43
2:H:81:MET:HB3	2:H:81:MET:HE2	1.87	0.43
3:I:168:THR:OG1	3:I:180:ASN:HB2	2.19	0.42
3:J:181:PHE:CD1	3:J:230:LEU:HD21	2.54	0.42
3:K:172:ARG:HH12	3:K:251:CYS:HB2	1.83	0.42
1:D:123:GLN:HG2	1:D:128:THR:O	2.18	0.42
3:I:114:ASN:OD1	7:I:402:HOH:O	2.21	0.42
2:H:40:ASN:ND2	7:H:315:HOH:O	2.52	0.42
3:I:196:SER:O	3:I:198:ALA:N	2.49	0.42
2:E:126:PRO:HD3	2:E:212:LYS:HE3	2.00	0.42
2:H:19:LYS:HE2	2:H:80:TYR:CB	2.50	0.42
3:L:31:LEU:HB2	3:L:136:MET:HB3	2.02	0.42
3:L:63:LEU:HD22	3:L:90:ALA:HB1	2.01	0.42
3:J:18:MET:HA	3:J:134:PRO:CG	2.48	0.42
2:F:29:PHE:CE2	2:F:53:PRO:HB3	2.54	0.42
2:G:136:GLY:O	2:G:189:SER:OG	2.24	0.42
3:I:163:TRP:CE2	3:I:165:PRO:HB3	2.55	0.42
3:J:64:LEU:HD13	3:J:123:ASN:HB3	2.01	0.42
3:L:16:GLU:N	3:L:16:GLU:OE1	2.53	0.42
5:N:2:NAG:O3	5:N:5:MAN:H5	2.20	0.42

*Continued on next page...*

Continued from previous page...

Atom-1	Atom-2	Interatomic distance (Å)	Clash overlap (Å)
3:J:148:HIS:HA	3:J:151:LYS:HD3	2.01	0.42
3:L:3:PRO:O	3:L:104:PHE:HE2	2.02	0.42
3:L:200:ILE:O	3:L:219:VAL:HA	2.20	0.42
1:A:106:LYS:HA	1:A:139:TYR:OH	2.20	0.41
1:C:160:GLU:OE1	7:C:303:HOH:O	2.21	0.41
3:I:2:GLU:OE1	7:I:403:HOH:O	2.22	0.41
3:L:17:TRP:CE2	3:L:18:MET:HG3	2.55	0.41
3:L:63:LEU:HD21	3:L:91:PHE:O	2.20	0.41
2:E:122:PRO:HB3	2:E:148:TYR:HB3	2.03	0.41
3:J:231:THR:CG2	3:J:243:ARG:HE	2.32	0.41
3:K:249:VAL:HG12	3:K:250:GLN:N	2.35	0.41
3:L:42:LEU:HD13	3:L:42:LEU:HA	1.82	0.41
1:B:11:MET:CE	1:B:21:MET:HB3	2.50	0.41
1:B:185:TYR:HA	1:B:191:TYR:OH	2.21	0.41
3:J:30:ASP:O	3:J:53:TRP:HA	2.21	0.41
1:D:30:TYR:HE2	3:L:28:LEU:HD23	1.85	0.41
2:E:129:PRO:HG3	2:E:192:LEU:HD22	2.03	0.41
3:L:169:ALA:HA	3:L:178:GLU:O	2.21	0.41
1:D:57:VAL:O	7:D:305:HOH:O	2.22	0.41
3:I:230:LEU:HD12	3:I:230:LEU:HA	1.93	0.41
3:J:13:PRO:HD3	3:J:68:LYS:HZ3	1.85	0.41
3:K:14:SER:HB3	3:K:16:GLU:HG2	2.03	0.41
2:E:149:PHE:CD1	2:H:163:THR:HG21	2.56	0.41
3:I:194:ILE:CG1	3:I:217:VAL:HG11	2.51	0.41
3:L:96:ARG:HG2	7:L:424:HOH:O	2.20	0.41
3:I:1:PRO:HB3	3:I:96:ARG:HH12	1.85	0.41
3:J:185:PRO:HD3	3:J:210:LEU:HD23	2.03	0.41
3:J:234:PHE:HB2	3:J:237:CYS:SG	2.61	0.41
2:F:179:TYR:OH	7:F:303:HOH:O	2.11	0.40
1:B:95:PHE:HB3	2:F:47:TRP:CE2	2.56	0.40
3:I:181:PHE:CG	3:I:230:LEU:HD21	2.56	0.40
3:I:30:ASP:O	3:I:53:TRP:HA	2.22	0.40
3:J:64:LEU:CD1	3:J:123:ASN:HB3	2.50	0.40
3:J:72:MET:HA	3:J:79:SER:O	2.22	0.40
3:J:177:VAL:HB	3:J:217:VAL:HG13	2.04	0.40
3:L:172:ARG:HD3	3:L:172:ARG:HA	1.87	0.40
1:B:33:HIS:CG	2:F:103:TYR:HB3	2.57	0.40
1:B:12:SER:HA	1:B:104:GLU:O	2.21	0.40
3:L:183:THR:HG21	3:L:207:GLU:HG2	2.03	0.40

All (3) symmetry-related close contacts are listed below. The label for Atom-2 includes the symmetry operator and encoded unit-cell translations to be applied.

Atom-1	Atom-2	Interatomic distance (Å)	Clash overlap (Å)
7:B:371:HOH:O	7:E:385:HOH:O[2_656]	1.85	0.35
3:L:240:ASP:OD1	6:I:304:NAG:O6[1_455]	2.03	0.17
7:D:370:HOH:O	7:F:396:HOH:O[2_545]	2.10	0.10

### 5.3 Torsion angles [i](#)

#### 5.3.1 Protein backbone [i](#)

In the following table, the Percentiles column shows the percent Ramachandran outliers of the chain as a percentile score with respect to all X-ray entries followed by that with respect to entries of similar resolution.

The Analysed column shows the number of residues for which the backbone conformation was analysed, and the total number of residues.

Mol	Chain	Analysed	Favoured	Allowed	Outliers	Percentiles	
1	A	212/213 (100%)	208 (98%)	4 (2%)	0	100	100
1	B	212/213 (100%)	208 (98%)	4 (2%)	0	100	100
1	C	211/213 (99%)	207 (98%)	4 (2%)	0	100	100
1	D	211/213 (99%)	205 (97%)	6 (3%)	0	100	100
2	E	219/220 (100%)	207 (94%)	12 (6%)	0	100	100
2	F	218/220 (99%)	211 (97%)	7 (3%)	0	100	100
2	G	218/220 (99%)	212 (97%)	6 (3%)	0	100	100
2	H	218/220 (99%)	211 (97%)	7 (3%)	0	100	100
3	I	244/255 (96%)	229 (94%)	12 (5%)	3 (1%)	13	10
3	J	241/255 (94%)	230 (95%)	11 (5%)	0	100	100
3	K	247/255 (97%)	226 (92%)	16 (6%)	5 (2%)	7	4
3	L	227/255 (89%)	210 (92%)	15 (7%)	2 (1%)	17	16
All	All	2678/2752 (97%)	2564 (96%)	104 (4%)	10 (0%)	34	37

All (10) Ramachandran outliers are listed below:

Mol	Chain	Res	Type
3	I	197	THR
3	K	11	PRO
3	K	13	PRO
3	L	62	ARG
3	I	235	HIS

*Continued on next page...*

*Continued from previous page...*

Mol	Chain	Res	Type
3	K	79	SER
3	I	251	CYS
3	K	74	LYS
3	K	100	GLY
3	L	14	SER

### 5.3.2 Protein sidechains [i](#)

In the following table, the Percentiles column shows the percent sidechain outliers of the chain as a percentile score with respect to all X-ray entries followed by that with respect to entries of similar resolution.

The Analysed column shows the number of residues for which the sidechain conformation was analysed, and the total number of residues.

Mol	Chain	Analysed	Rotameric	Outliers	Percentiles
1	A	186/186 (100%)	184 (99%)	2 (1%)	73 85
1	B	182/186 (98%)	180 (99%)	2 (1%)	73 85
1	C	183/186 (98%)	183 (100%)	0	100 100
1	D	183/186 (98%)	180 (98%)	3 (2%)	62 76
2	E	180/186 (97%)	178 (99%)	2 (1%)	73 85
2	F	183/186 (98%)	179 (98%)	4 (2%)	52 65
2	G	178/186 (96%)	178 (100%)	0	100 100
2	H	182/186 (98%)	181 (100%)	1 (0%)	88 94
3	I	215/224 (96%)	212 (99%)	3 (1%)	67 80
3	J	214/224 (96%)	207 (97%)	7 (3%)	38 49
3	K	219/224 (98%)	211 (96%)	8 (4%)	34 43
3	L	203/224 (91%)	201 (99%)	2 (1%)	76 86
All	All	2308/2384 (97%)	2274 (98%)	34 (2%)	65 78

All (34) residues with a non-rotameric sidechain are listed below:

Mol	Chain	Res	Type
1	A	1	GLN
1	A	60	ARG
1	B	105	ILE
1	B	213	CYS
1	D	3	VAL

*Continued on next page...*

*Continued from previous page...*

Mol	Chain	Res	Type
1	D	92	SER
1	D	136	ASN
2	E	134	THR
2	E	212	LYS
2	F	13	LYS
2	F	72	VAL
2	F	208	THR
2	F	220	ASP
2	H	217	LYS
3	I	111	VAL
3	I	249	VAL
3	I	251	CYS
3	J	2	GLU
3	J	18	MET
3	J	72	MET
3	J	79	SER
3	J	149	VAL
3	J	170	CYS
3	J	215	VAL
3	K	14	SER
3	K	16	GLU
3	K	40	VAL
3	K	103	THR
3	K	107	VAL
3	K	122	HIS
3	K	124	ILE
3	K	141	THR
3	L	33	VAL
3	L	241	CYS

Sometimes sidechains can be flipped to improve hydrogen bonding and reduce clashes. All (1) such sidechains are listed below:

Mol	Chain	Res	Type
2	H	54	ASN

### 5.3.3 RNA [i](#)

There are no RNA molecules in this entry.

## 5.4 Non-standard residues in protein, DNA, RNA chains [i](#)

There are no non-standard protein/DNA/RNA residues in this entry.

## 5.5 Carbohydrates [i](#)

11 monosaccharides are modelled in this entry.

In the following table, the Counts columns list the number of bonds (or angles) for which Mogul statistics could be retrieved, the number of bonds (or angles) that are observed in the model and the number of bonds (or angles) that are defined in the Chemical Component Dictionary. The Link column lists molecule types, if any, to which the group is linked. The Z score for a bond length (or angle) is the number of standard deviations the observed value is removed from the expected value. A bond length (or angle) with  $|Z| > 2$  is considered an outlier worth inspection. RMSZ is the root-mean-square of all Z scores of the bond lengths (or angles).

Mol	Type	Chain	Res	Link	Bond lengths			Bond angles		
					Counts	RMSZ	# Z  > 2	Counts	RMSZ	# Z  > 2
4	NAG	M	1	4,3	14,14,15	0.43	0	17,19,21	0.71	0
4	NAG	M	2	4	14,14,15	0.37	0	17,19,21	0.52	0
4	BMA	M	3	4	11,11,12	0.75	0	15,15,17	0.99	0
4	MAN	M	4	4	11,11,12	1.25	2 (18%)	15,15,17	0.99	1 (6%)
4	MAN	M	5	4	11,11,12	1.19	1 (9%)	15,15,17	1.22	1 (6%)
4	MAN	M	6	4	11,11,12	1.21	2 (18%)	15,15,17	0.85	1 (6%)
5	NAG	N	1	3,5	14,14,15	0.58	1 (7%)	17,19,21	0.40	0
5	NAG	N	2	5	14,14,15	0.26	0	17,19,21	0.47	0
5	BMA	N	3	5	11,11,12	0.94	0	15,15,17	1.77	3 (20%)
5	MAN	N	4	5	11,11,12	0.83	0	15,15,17	1.45	1 (6%)
5	MAN	N	5	5	11,11,12	1.20	1 (9%)	15,15,17	1.42	2 (13%)

In the following table, the Chirals column lists the number of chiral outliers, the number of chiral centers analysed, the number of these observed in the model and the number defined in the Chemical Component Dictionary. Similar counts are reported in the Torsion and Rings columns. '-' means no outliers of that kind were identified.

Mol	Type	Chain	Res	Link	Chirals	Torsions	Rings
4	NAG	M	1	4,3	-	0/6/23/26	0/1/1/1
4	NAG	M	2	4	-	0/6/23/26	0/1/1/1
4	BMA	M	3	4	-	1/2/19/22	0/1/1/1
4	MAN	M	4	4	-	0/2/19/22	0/1/1/1
4	MAN	M	5	4	-	2/2/19/22	0/1/1/1
4	MAN	M	6	4	-	0/2/19/22	0/1/1/1
5	NAG	N	1	3,5	-	0/6/23/26	0/1/1/1

*Continued on next page...*



Continued from previous page...

Mol	Type	Chain	Res	Link	Chirals	Torsions	Rings
5	NAG	N	2	5	-	2/6/23/26	0/1/1/1
5	BMA	N	3	5	-	1/2/19/22	0/1/1/1
5	MAN	N	4	5	-	1/2/19/22	0/1/1/1
5	MAN	N	5	5	-	1/2/19/22	0/1/1/1

All (7) bond length outliers are listed below:

Mol	Chain	Res	Type	Atoms	Z	Observed(Å)	Ideal(Å)
4	M	4	MAN	O5-C1	-2.83	1.39	1.43
4	M	5	MAN	O5-C1	-2.47	1.39	1.43
4	M	6	MAN	O5-C1	-2.47	1.39	1.43
5	N	5	MAN	O5-C5	2.26	1.48	1.43
4	M	6	MAN	C2-C3	2.14	1.55	1.52
5	N	1	NAG	O5-C1	-2.09	1.40	1.43
4	M	4	MAN	C2-C3	2.02	1.55	1.52

All (9) bond angle outliers are listed below:

Mol	Chain	Res	Type	Atoms	Z	Observed(°)	Ideal(°)
5	N	4	MAN	C1-O5-C5	4.82	118.73	112.19
5	N	3	BMA	C1-C2-C3	-4.44	104.21	109.67
5	N	5	MAN	C1-O5-C5	3.99	117.59	112.19
5	N	5	MAN	O2-C2-C3	-3.02	104.10	110.14
4	M	5	MAN	C2-C3-C4	2.70	115.57	110.89
5	N	3	BMA	C3-C4-C5	-2.48	105.81	110.24
4	M	4	MAN	O2-C2-C3	-2.21	105.71	110.14
5	N	3	BMA	O2-C2-C3	-2.08	105.98	110.14
4	M	6	MAN	O2-C2-C3	-2.03	106.07	110.14

There are no chirality outliers.

All (8) torsion outliers are listed below:

Mol	Chain	Res	Type	Atoms
4	M	5	MAN	O5-C5-C6-O6
4	M	5	MAN	C4-C5-C6-O6
5	N	2	NAG	O5-C5-C6-O6
5	N	4	MAN	O5-C5-C6-O6
4	M	3	BMA	C4-C5-C6-O6
5	N	3	BMA	C4-C5-C6-O6
5	N	2	NAG	C4-C5-C6-O6
5	N	5	MAN	C4-C5-C6-O6

There are no ring outliers.

5 monomers are involved in 5 short contacts:

Mol	Chain	Res	Type	Clashes	Symm-Clashes
5	N	1	NAG	1	0
4	M	3	BMA	1	0
5	N	2	NAG	1	0
5	N	5	MAN	1	0
4	M	5	MAN	3	0

The following is a two-dimensional graphical depiction of Mogul quality analysis of bond lengths, bond angles, torsion angles, and ring geometry for oligosaccharide.

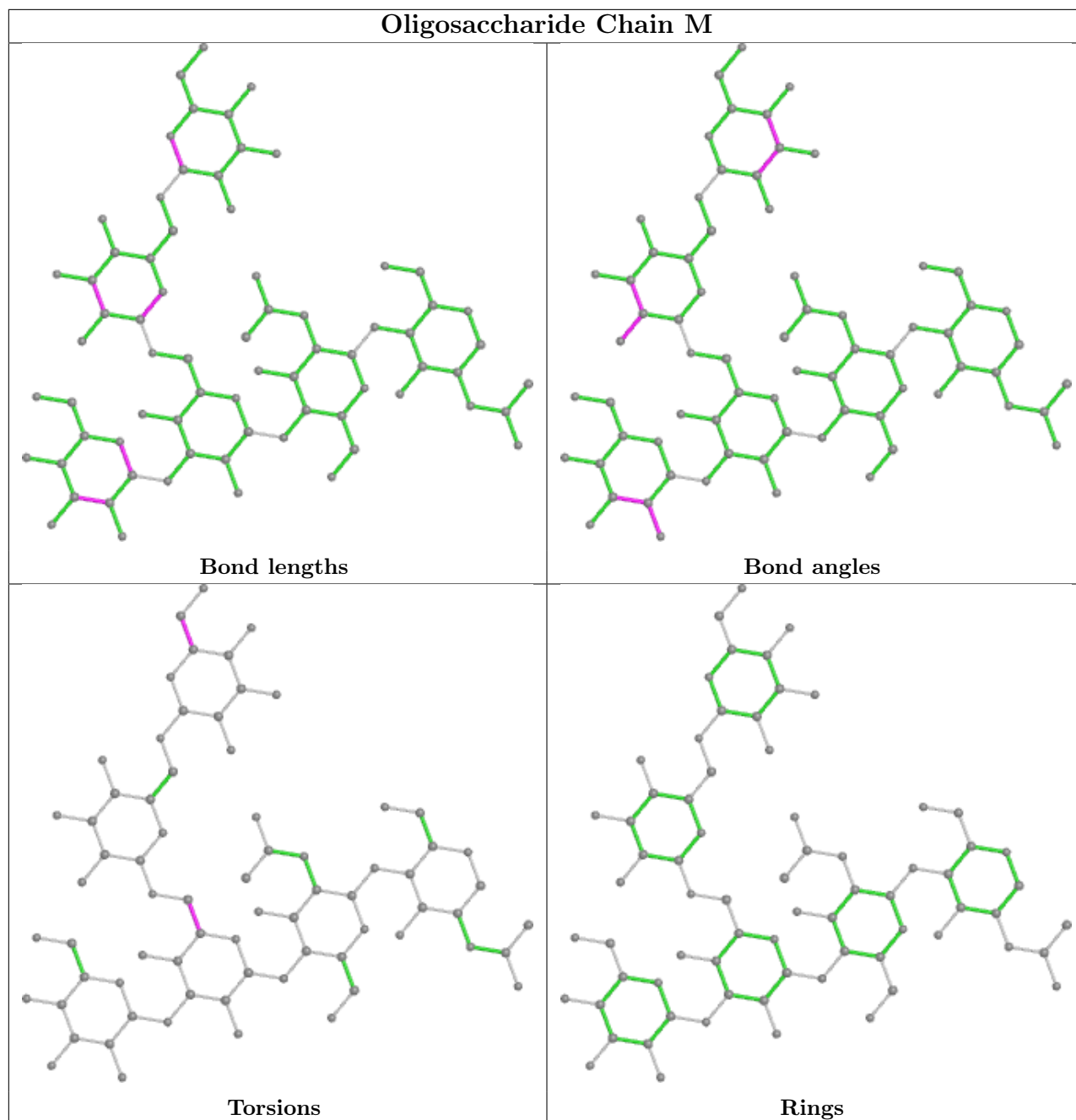

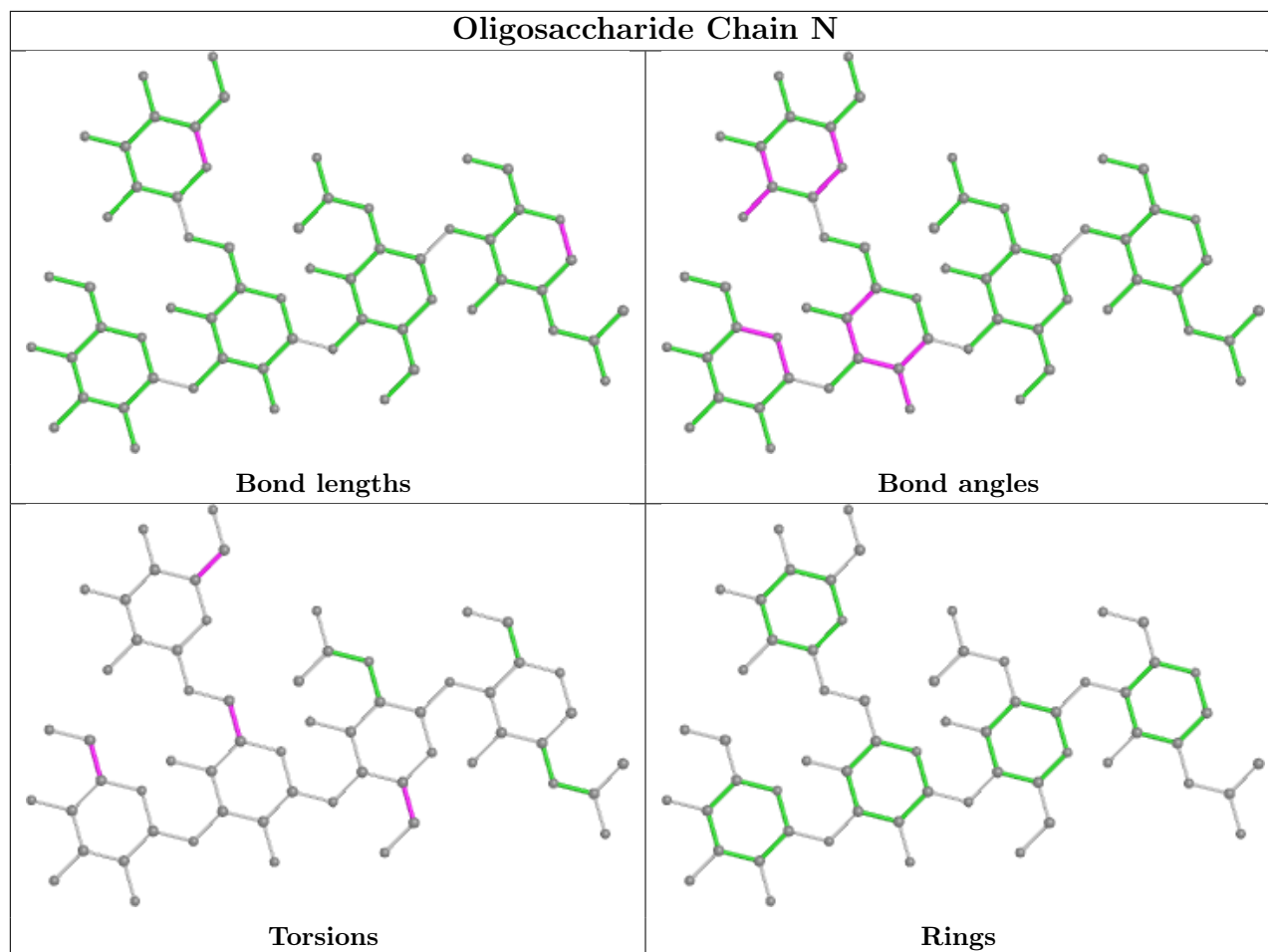

## 5.6 Ligand geometry [i](#)

18 ligands are modelled in this entry.

In the following table, the Counts columns list the number of bonds (or angles) for which Mogul statistics could be retrieved, the number of bonds (or angles) that are observed in the model and the number of bonds (or angles) that are defined in the Chemical Component Dictionary. The Link column lists molecule types, if any, to which the group is linked. The Z score for a bond length (or angle) is the number of standard deviations the observed value is removed from the expected value. A bond length (or angle) with  $|Z| > 2$  is considered an outlier worth inspection. RMSZ is the root-mean-square of all Z scores of the bond lengths (or angles).

Mol	Type	Chain	Res	Link	Bond lengths			Bond angles		
					Counts	RMSZ	# $ Z  > 2$	Counts	RMSZ	# $ Z  > 2$
6	NAG	K	303	3	14,14,15	0.55	0	17,19,21	0.50	0
6	NAG	J	303	3	14,14,15	0.51	0	17,19,21	0.54	0
6	NAG	J	302	3	14,14,15	0.49	0	17,19,21	0.42	0
6	NAG	L	301	3	14,14,15	0.65	1 (7%)	17,19,21	0.80	1 (5%)
6	NAG	I	301	3	14,14,15	0.52	0	17,19,21	0.47	0
6	NAG	K	305	3	14,14,15	0.32	0	17,19,21	0.61	0

Mol	Type	Chain	Res	Link	Bond lengths			Bond angles		
					Counts	RMSZ	# Z  > 2	Counts	RMSZ	# Z  > 2
6	NAG	K	304	3	14,14,15	0.46	0	17,19,21	0.45	0
6	NAG	L	303	3	14,14,15	0.76	1 (7%)	17,19,21	0.80	1 (5%)
6	NAG	L	304	3	14,14,15	0.40	0	17,19,21	0.57	0
6	NAG	I	303	3	14,14,15	0.37	0	17,19,21	0.49	0
6	NAG	I	304	3	14,14,15	0.53	0	17,19,21	0.53	0
6	NAG	L	305	3	14,14,15	0.52	0	17,19,21	0.41	0
6	NAG	I	302	3	14,14,15	0.30	0	17,19,21	0.58	0
6	NAG	J	301	3	14,14,15	0.57	0	17,19,21	0.49	0
6	NAG	K	301	3	14,14,15	0.55	0	17,19,21	0.56	0
6	NAG	L	302	3	14,14,15	0.39	0	17,19,21	0.46	0
6	NAG	K	302	3	14,14,15	0.37	0	17,19,21	0.37	0
6	NAG	J	304	3	14,14,15	0.33	0	17,19,21	0.44	0

In the following table, the Chirals column lists the number of chiral outliers, the number of chiral centers analysed, the number of these observed in the model and the number defined in the Chemical Component Dictionary. Similar counts are reported in the Torsion and Rings columns. '-' means no outliers of that kind were identified.

Mol	Type	Chain	Res	Link	Chirals	Torsions	Rings
6	NAG	K	303	3	-	0/6/23/26	0/1/1/1
6	NAG	J	303	3	-	2/6/23/26	0/1/1/1
6	NAG	J	302	3	-	0/6/23/26	0/1/1/1
6	NAG	L	301	3	-	0/6/23/26	0/1/1/1
6	NAG	I	301	3	-	0/6/23/26	0/1/1/1
6	NAG	K	305	3	-	0/6/23/26	0/1/1/1
6	NAG	K	304	3	-	0/6/23/26	0/1/1/1
6	NAG	L	303	3	-	0/6/23/26	0/1/1/1
6	NAG	L	304	3	-	0/6/23/26	0/1/1/1
6	NAG	I	303	3	-	0/6/23/26	0/1/1/1
6	NAG	I	304	3	-	2/6/23/26	0/1/1/1
6	NAG	L	305	3	-	0/6/23/26	0/1/1/1
6	NAG	I	302	3	-	0/6/23/26	0/1/1/1
6	NAG	J	301	3	-	0/6/23/26	0/1/1/1
6	NAG	K	301	3	-	2/6/23/26	0/1/1/1
6	NAG	L	302	3	-	2/6/23/26	0/1/1/1
6	NAG	K	302	3	-	2/6/23/26	0/1/1/1
6	NAG	J	304	3	-	0/6/23/26	0/1/1/1

All (2) bond length outliers are listed below:

Mol	Chain	Res	Type	Atoms	Z	Observed(Å)	Ideal(Å)
6	L	303	NAG	O5-C1	-2.51	1.39	1.43
6	L	301	NAG	O5-C1	2.28	1.47	1.43

All (2) bond angle outliers are listed below:

Mol	Chain	Res	Type	Atoms	Z	Observed(°)	Ideal(°)
6	L	301	NAG	C1-O5-C5	2.62	115.75	112.19
6	L	303	NAG	C1-O5-C5	-2.25	109.14	112.19

There are no chirality outliers.

All (10) torsion outliers are listed below:

Mol	Chain	Res	Type	Atoms
6	K	301	NAG	C8-C7-N2-C2
6	K	301	NAG	O7-C7-N2-C2
6	K	302	NAG	O5-C5-C6-O6
6	K	302	NAG	C4-C5-C6-O6
6	L	302	NAG	O5-C5-C6-O6
6	L	302	NAG	C4-C5-C6-O6
6	I	304	NAG	O5-C5-C6-O6
6	I	304	NAG	C4-C5-C6-O6
6	J	303	NAG	C4-C5-C6-O6
6	J	303	NAG	O5-C5-C6-O6

There are no ring outliers.

5 monomers are involved in 7 short contacts:

Mol	Chain	Res	Type	Clashes	Symm-Clashes
6	J	302	NAG	1	0
6	L	303	NAG	2	0
6	I	304	NAG	1	1
6	L	305	NAG	1	0
6	I	302	NAG	1	0

## 5.7 Other polymers [\(i\)](#)

There are no such residues in this entry.

## 5.8 Polymer linkage issues [\(i\)](#)

There are no chain breaks in this entry.

## 6 Fit of model and data i

### 6.1 Protein, DNA and RNA chains i

In the following table, the column labelled ‘#RSRZ> 2’ contains the number (and percentage) of RSRZ outliers, followed by percent RSRZ outliers for the chain as percentile scores relative to all X-ray entries and entries of similar resolution. The OWAB column contains the minimum, median, 95<sup>th</sup> percentile and maximum values of the occupancy-weighted average B-factor per residue. The column labelled ‘Q< 0.9’ lists the number of (and percentage) of residues with an average occupancy less than 0.9.

Mol	Chain	Analysed	<RSRZ>	#RSRZ>2	OWAB(Å <sup>2</sup> )	Q<0.9
1	A	213/213 (100%)	0.08	1 (0%) 91 90	19, 31, 48, 67	0
1	B	213/213 (100%)	0.32	10 (4%) 31 30	21, 42, 66, 77	0
1	C	213/213 (100%)	0.04	1 (0%) 91 90	21, 31, 45, 73	0
1	D	213/213 (100%)	-0.07	2 (0%) 84 83	26, 36, 50, 64	0
2	E	220/220 (100%)	0.29	7 (3%) 47 45	23, 38, 68, 96	0
2	F	220/220 (100%)	0.19	3 (1%) 75 73	23, 38, 54, 77	0
2	G	220/220 (100%)	0.32	10 (4%) 33 32	25, 37, 67, 95	0
2	H	220/220 (100%)	0.24	4 (1%) 68 66	26, 41, 62, 80	0
3	I	248/255 (97%)	1.10	54 (21%) 0 0	22, 57, 95, 116	0
3	J	245/255 (96%)	1.26	58 (23%) 0 0	31, 61, 96, 117	0
3	K	251/255 (98%)	0.74	27 (10%) 5 5	25, 51, 86, 110	0
3	L	236/255 (92%)	1.07	42 (17%) 1 1	33, 60, 93, 111	0
All	All	2712/2752 (98%)	0.49	219 (8%) 12 10	19, 42, 84, 117	0

All (219) RSRZ outliers are listed below:

Mol	Chain	Res	Type	RSRZ
3	K	12	GLY	10.9
3	I	251	CYS	10.4
2	G	136	GLY	9.9
3	L	92	GLN	8.9
3	J	177	VAL	8.5
3	J	169	ALA	7.7
3	L	1	PRO	7.4
2	E	219	CYS	7.4
3	J	219	VAL	7.3
3	L	99	GLY	7.3
3	I	204	TYR	7.2

*Continued on next page...*

*Continued from previous page...*

<b>Mol</b>	<b>Chain</b>	<b>Res</b>	<b>Type</b>	<b>RSRZ</b>
3	J	217	VAL	6.9
3	L	91	PHE	6.7
3	K	100	GLY	6.5
3	J	57	ALA	6.2
3	I	1	PRO	6.2
2	G	135	SER	6.2
3	J	226	ALA	6.1
3	K	75	SER	6.0
3	J	174	ALA	6.0
3	L	100	GLY	5.9
3	L	55	LEU	5.8
3	I	220	THR	5.7
2	G	133	SER	5.7
3	I	247	THR	5.7
3	J	172	ARG	5.6
3	L	64	LEU	5.5
3	I	215	VAL	5.5
3	J	167	ILE	5.5
3	J	98	SER	5.4
3	J	246	GLY	5.4
2	E	131	SER	5.3
3	L	61	ILE	5.2
3	L	63	LEU	5.1
3	K	76	HIS	5.0
3	L	101	LYS	5.0
3	I	239	ASN	4.9
3	L	98	SER	4.9
3	L	90	ALA	4.8
3	L	97	PRO	4.8
3	J	252	PRO	4.7
3	J	170	CYS	4.7
3	K	98	SER	4.5
3	J	1	PRO	4.5
3	J	225	GLY	4.5
3	J	195	GLN	4.5
3	L	204[A]	TYR	4.4
3	I	219	VAL	4.4
3	I	250	GLN	4.4
3	L	18	MET	4.4
3	I	235	HIS	4.4
3	I	21	HIS	4.3
3	L	95	THR	4.3

*Continued on next page...*



*Continued from previous page...*

<b>Mol</b>	<b>Chain</b>	<b>Res</b>	<b>Type</b>	<b>RSRZ</b>
3	I	198	ALA	4.2
2	G	219	CYS	4.2
3	K	13	PRO	4.2
3	K	80	TYR	4.2
2	G	100	TYR	4.2
3	J	216	VAL	4.1
3	I	197	THR	4.1
3	I	218	HIS	4.1
2	E	135	SER	4.1
3	J	224	GLU	4.0
2	E	134	THR	4.0
3	J	179	VAL	4.0
3	L	2	GLU	4.0
3	L	62	ARG	4.0
3	K	1	PRO	3.9
3	L	252	PRO	3.8
3	L	96	ARG	3.8
3	K	15	PRO	3.8
3	I	173	SER	3.8
3	L	54	ILE	3.8
3	J	251	CYS	3.8
3	J	220	THR	3.7
3	K	81	SER	3.7
3	J	215	VAL	3.7
2	G	134	THR	3.7
3	J	204	TYR	3.7
2	H	86	LEU	3.7
3	I	236	THR	3.6
3	L	251	CYS	3.5
3	K	77	PHE	3.5
3	L	241	CYS	3.4
2	G	220	ASP	3.4
3	J	197	THR	3.4
2	H	100	TYR	3.4
3	I	203	SER	3.4
3	I	249	VAL	3.4
3	I	133	GLY	3.3
3	K	251	CYS	3.3
3	K	11	PRO	3.3
3	L	126	ASN	3.3
3	J	176	THR	3.3
3	J	247	THR	3.3

*Continued on next page...*

*Continued from previous page...*

<b>Mol</b>	<b>Chain</b>	<b>Res</b>	<b>Type</b>	<b>RSRZ</b>
3	I	206	SER	3.3
3	J	223	SER	3.3
3	L	74	LYS	3.3
3	L	135	SER	3.3
1	B	198	GLN	3.2
3	I	216	VAL	3.2
3	J	76	HIS	3.2
3	J	209	GLU	3.2
3	L	125	PRO	3.2
2	E	100	TYR	3.2
3	J	218	HIS	3.2
3	I	190	TYR	3.2
3	I	205	VAL	3.1
3	J	250	GLN	3.1
3	J	175	ASN	3.1
1	B	149	VAL	3.1
2	H	41	HIS	3.1
2	F	218	SER	3.1
3	I	19	VAL	3.1
2	G	41	HIS	3.0
3	I	192	ALA	3.0
3	I	233	TYR	3.0
3	I	148	HIS	3.0
3	J	56	ARG	3.0
1	B	213	CYS	3.0
3	I	248	VAL	2.9
3	K	21	HIS	2.9
3	L	220	THR	2.9
3	K	250	GLN	2.9
3	I	189	ARG	2.9
3	I	223	SER	2.9
3	J	97	PRO	2.9
3	I	152	TYR	2.9
3	I	214	SER	2.8
3	J	100	GLY	2.7
2	F	84	ARG	2.7
3	K	92	GLN	2.7
3	I	238	GLY	2.7
3	J	199	VAL	2.7
3	J	243	ARG	2.7
3	J	249	VAL	2.7
3	I	196	SER	2.7

*Continued on next page...*

*Continued from previous page...*

<b>Mol</b>	<b>Chain</b>	<b>Res</b>	<b>Type</b>	<b>RSRZ</b>
3	J	13	PRO	2.7
3	L	175	ASN	2.7
1	B	212	GLU	2.6
3	J	15	PRO	2.6
3	J	59	ALA	2.6
3	I	217	VAL	2.6
3	L	209	GLU	2.6
3	L	133	GLY	2.6
1	B	190	VAL	2.6
3	I	175	ASN	2.6
3	L	216	VAL	2.6
3	I	176	THR	2.6
3	L	173	SER	2.6
3	L	148	HIS	2.6
3	J	17	TRP	2.6
3	I	246	GLY	2.5
3	I	132	ASP	2.5
3	J	77	PHE	2.5
3	J	92	GLN	2.5
3	K	72	MET	2.5
3	J	61	ILE	2.5
2	H	220	ASP	2.5
3	J	93	THR	2.4
3	K	93	THR	2.4
3	I	177	VAL	2.4
3	K	17	TRP	2.4
3	L	166	ASN	2.4
3	J	62	ARG	2.4
1	A	1	GLN	2.4
3	J	178	GLU	2.4
3	J	21	HIS	2.4
1	B	105	ILE	2.4
3	J	14	SER	2.4
3	J	210	LEU	2.3
3	I	179	VAL	2.3
3	J	248	VAL	2.3
3	I	245	ARG	2.3
3	I	252	PRO	2.3
1	B	151	ASN	2.3
1	B	191	TYR	2.3
1	C	1	GLN	2.3
3	I	243	ARG	2.3

*Continued on next page...*

*Continued from previous page...*

<b>Mol</b>	<b>Chain</b>	<b>Res</b>	<b>Type</b>	<b>RSRZ</b>
3	J	173	SER	2.3
3	K	99	GLY	2.3
3	I	36	ILE	2.3
3	J	200	ILE	2.3
1	B	153	LEU	2.3
3	I	207	GLU	2.3
3	K	88	THR	2.3
3	K	95	THR	2.3
3	K	255	GLY	2.3
3	I	222	GLU	2.3
3	I	240	ASP	2.3
3	I	170	CYS	2.3
1	B	202	SER	2.3
3	I	178	GLU	2.2
3	J	79	SER	2.2
3	L	17	TRP	2.2
3	K	254	THR	2.2
3	J	96	ARG	2.2
2	F	220	ASP	2.2
3	K	197	THR	2.2
2	G	89	GLU	2.1
2	E	136	GLY	2.1
3	K	9	SER	2.1
3	K	102	TRP	2.1
3	L	134	PRO	2.1
3	L	170	CYS	2.1
2	E	220	ASP	2.1
3	I	188	ASP	2.1
3	J	171	LYS	2.1
3	L	4	THR	2.1
3	L	221	GLY	2.1
3	L	219	VAL	2.1
1	D	213	CYS	2.1
3	I	237	CYS	2.1
1	D	153	LEU	2.0
3	I	210	LEU	2.0
2	G	132	LYS	2.0
3	L	218	HIS	2.0
3	I	158	GLU	2.0
3	J	222	GLU	2.0

## 6.2 Non-standard residues in protein, DNA, RNA chains [i](#)

There are no non-standard protein/DNA/RNA residues in this entry.

## 6.3 Carbohydrates [i](#)

In the following table, the Atoms column lists the number of modelled atoms in the group and the number defined in the chemical component dictionary. The B-factors column lists the minimum, median, 95<sup>th</sup> percentile and maximum values of B factors of atoms in the group. The column labelled 'Q< 0.9' lists the number of atoms with occupancy less than 0.9.

Mol	Type	Chain	Res	Atoms	RSCC	RSR	B-factors(Å <sup>2</sup> )	Q<0.9
5	MAN	N	4	11/12	0.44	0.44	98,105,111,114	0
4	MAN	M	5	11/12	0.52	0.51	85,101,105,109	0
5	MAN	N	5	11/12	0.61	0.42	82,89,97,99	0
4	MAN	M	6	11/12	0.68	0.33	102,107,109,109	0
4	MAN	M	4	11/12	0.70	0.29	77,81,91,94	0
4	BMA	M	3	11/12	0.73	0.26	89,93,101,106	0
5	BMA	N	3	11/12	0.76	0.26	84,86,95,101	0
5	NAG	N	2	14/15	0.82	0.30	76,83,90,90	0
4	NAG	M	2	14/15	0.85	0.19	55,67,79,89	0
5	NAG	N	1	14/15	0.91	0.17	62,69,78,81	0
4	NAG	M	1	14/15	0.93	0.12	38,44,51,57	0

The following is a graphical depiction of the model fit to experimental electron density for oligosaccharide. Each fit is shown from different orientation to approximate a three-dimensional view.

**Electron density around Chain M:**

$2mF_o-DF_c$  (at 0.7 rmsd) in gray  
 $mF_o-DF_c$  (at 3 rmsd) in purple (negative)  
and green (positive)

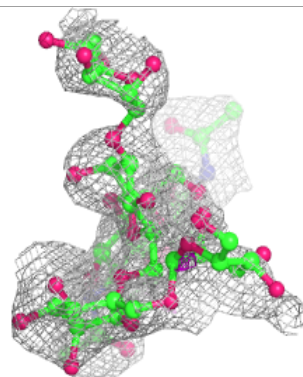
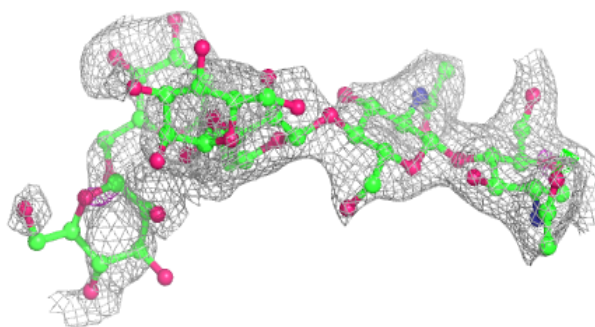
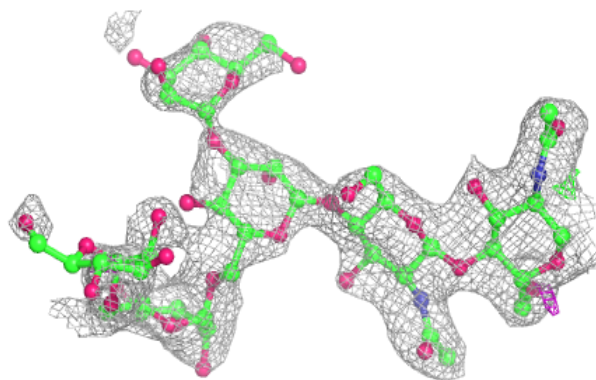

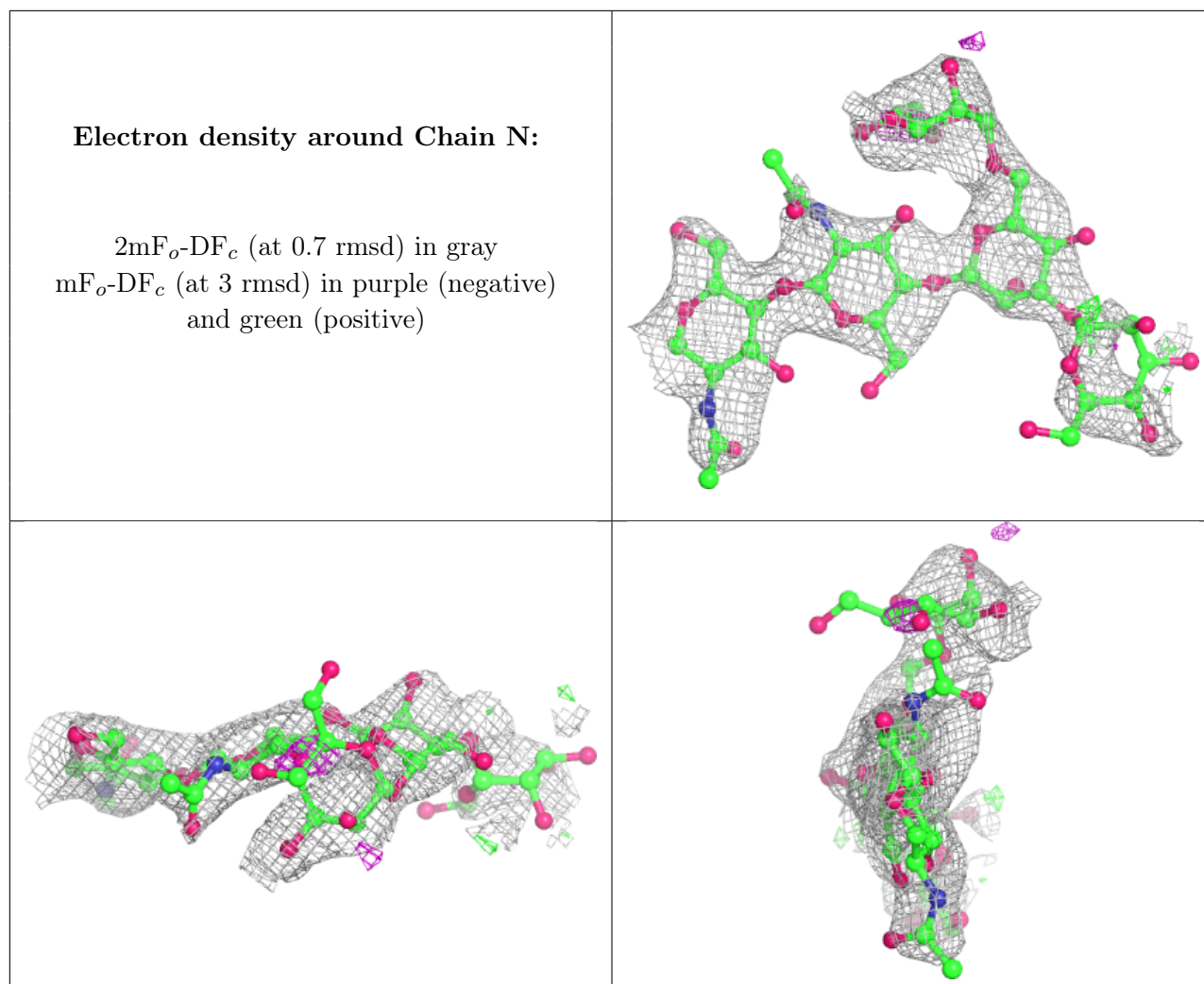

## 6.4 Ligands [i](#)

In the following table, the Atoms column lists the number of modelled atoms in the group and the number defined in the chemical component dictionary. The B-factors column lists the minimum, median, 95<sup>th</sup> percentile and maximum values of B factors of atoms in the group. The column labelled 'Q < 0.9' lists the number of atoms with occupancy less than 0.9.

Mol	Type	Chain	Res	Atoms	RSCC	RSR	B-factors(Å <sup>2</sup> )	Q < 0.9
6	NAG	I	302	14/15	0.65	0.34	52,70,74,74	0
6	NAG	L	304	14/15	0.66	0.40	69,89,94,94	0
6	NAG	L	303	14/15	0.72	0.24	64,76,85,87	0
6	NAG	K	303	14/15	0.73	0.29	44,67,73,73	0
6	NAG	J	304	14/15	0.77	0.27	81,93,96,96	0
6	NAG	K	304	14/15	0.78	0.19	63,71,77,77	0
6	NAG	I	304	14/15	0.78	0.30	80,85,93,94	0
6	NAG	J	303	14/15	0.78	0.29	92,98,100,102	0
6	NAG	L	305	14/15	0.80	0.27	65,71,82,87	0

*Continued on next page...*

*Continued from previous page...*

Mol	Type	Chain	Res	Atoms	RSCC	RSR	B-factors( $\text{\AA}^2$ )	Q<0.9
6	NAG	L	301	14/15	0.81	0.14	61,72,76,79	0
6	NAG	L	302	14/15	0.83	0.18	74,83,88,95	0
6	NAG	I	303	14/15	0.84	0.30	66,74,81,89	0
6	NAG	K	302	14/15	0.87	0.20	58,62,67,77	0
6	NAG	J	302	14/15	0.91	0.16	47,50,54,54	0
6	NAG	K	301	14/15	0.91	0.12	50,63,70,70	0
6	NAG	J	301	14/15	0.92	0.11	48,53,58,58	0
6	NAG	K	305	14/15	0.93	0.11	40,44,53,54	0
6	NAG	I	301	14/15	0.98	0.13	30,33,37,39	0

## 6.5 Other polymers [i](#)

There are no such residues in this entry.