



# wwPDB X-ray Structure Validation Summary Report

Sep 25, 2023 – 07:01 AM EDT

PDB ID : 5W1M  
Title : MACV GP1 CR1-07 Fab complex  
Authors : Raymond, D.D.; Clark, L.E.; Abraham, J.  
Deposited on : 2017-06-03  
Resolution : 3.91 Å(reported)

This is a wwPDB X-ray Structure Validation Summary Report for a publicly released PDB entry.

We welcome your comments at [validation@mail.wwpdb.org](mailto:validation@mail.wwpdb.org)

A user guide is available at

<https://www.wwpdb.org/validation/2017/XrayValidationReportHelp>

with specific help available everywhere you see the  symbol.

The types of validation reports are described at

<http://www.wwpdb.org/validation/2017/FAQs#types>.

---

The following versions of software and data (see [references](#) ) were used in the production of this report:

MolProbity : 4.02b-467  
Mogul : 1.8.5 (274361), CSD as541be (2020)  
Xtriage (Phenix) : 1.13  
EDS : 2.35.1  
Percentile statistics : 20191225.v01 (using entries in the PDB archive December 25th 2019)  
Refmac : 5.8.0158  
CCP4 : 7.0.044 (Gargrove)  
Ideal geometry (proteins) : Engh & Huber (2001)  
Ideal geometry (DNA, RNA) : Parkinson et al. (1996)  
Validation Pipeline (wwPDB-VP) : 2.35.1

# 1 Overall quality at a glance

The following experimental techniques were used to determine the structure:

*X-RAY DIFFRACTION*

The reported resolution of this entry is 3.91 Å.

Percentile scores (ranging between 0-100) for global validation metrics of the entry are shown in the following graphic. The table shows the number of entries on which the scores are based.

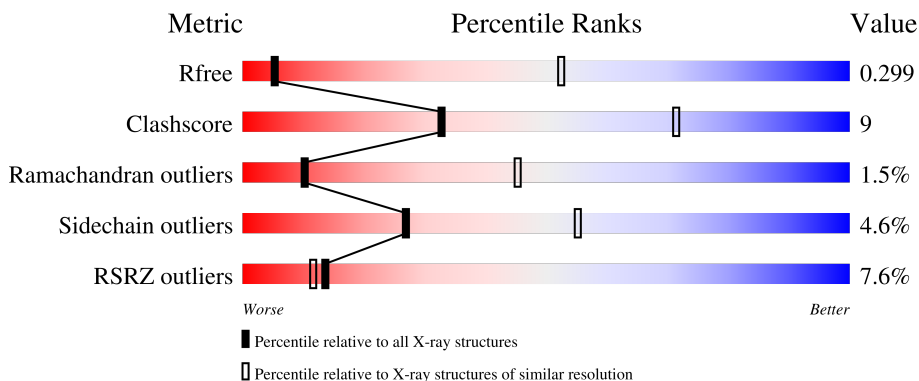

Metric	Whole archive (#Entries)	Similar resolution (#Entries, resolution range(Å))
$R_{free}$	130704	1019 (4.18-3.66)
Clashscore	141614	1016 (4.16-3.68)
Ramachandran outliers	138981	1039 (4.18-3.66)
Sidechain outliers	138945	1032 (4.18-3.66)
RSRZ outliers	127900	1002 (4.20-3.64)

The table below summarises the geometric issues observed across the polymeric chains and their fit to the electron density. The red, orange, yellow and green segments of the lower bar indicate the fraction of residues that contain outliers for  $\geq 3$ , 2, 1 and 0 types of geometric quality criteria respectively. A grey segment represents the fraction of residues that are not modelled. The numeric value for each fraction is indicated below the corresponding segment, with a dot representing fractions  $\leq 5\%$ . The upper red bar (where present) indicates the fraction of residues that have poor fit to the electron density. The numeric value is given above the bar.

Mol	Chain	Length	Quality of chain
1	A	221	
1	C	221	
1	E	221	
1	G	221	
2	B	226	

*Continued on next page...*

Continued from previous page...

Mol	Chain	Length	Quality of chain
2	D	226	
2	F	226	
2	H	226	
3	Q	152	
3	R	152	
3	S	152	
3	T	152	
4	I	2	
4	J	2	
5	K	3	

The following table lists non-polymeric compounds, carbohydrate monomers and non-standard residues in protein, DNA, RNA chains that are outliers for geometric or electron-density-fit criteria:

Mol	Type	Chain	Res	Chirality	Geometry	Clashes	Electron density
4	NAG	I	1	-	-	-	X

## 2 Entry composition [i](#)

There are 7 unique types of molecules in this entry. The entry contains 18425 atoms, of which 0 are hydrogens and 0 are deuteriums.

In the tables below, the ZeroOcc column contains the number of atoms modelled with zero occupancy, the AltConf column contains the number of residues with at least one atom in alternate conformation and the Trace column contains the number of residues modelled with at most 2 atoms.

- Molecule 1 is a protein called CR1-07 Fab light chain.

Mol	Chain	Residues	Atoms					ZeroOcc	AltConf	Trace
			Total	C	N	O	S			
1	A	221	Total 1708	C 1068	N 284	O 351	S 5	0	0	0
1	C	221	Total 1711	C 1070	N 284	O 352	S 5	0	1	0
1	E	221	Total 1708	C 1068	N 284	O 351	S 5	0	0	0
1	G	219	Total 1695	C 1061	N 282	O 347	S 5	0	0	0

- Molecule 2 is a protein called CR1-07 Fab heavy chain.

Mol	Chain	Residues	Atoms					ZeroOcc	AltConf	Trace
			Total	C	N	O	S			
2	B	218	Total 1658	C 1053	N 282	O 316	S 7	0	0	0
2	D	220	Total 1670	C 1059	N 284	O 319	S 8	0	0	0
2	F	218	Total 1658	C 1053	N 282	O 316	S 7	0	0	0
2	H	219	Total 1667	C 1058	N 283	O 319	S 7	0	1	0

- Molecule 3 is a protein called Pre-glycoprotein polyprotein GP complex.

Mol	Chain	Residues	Atoms					ZeroOcc	AltConf	Trace
			Total	C	N	O	S			
3	Q	151	Total 1209	C 761	N 209	O 225	S 14	0	0	0
3	R	152	Total 1218	C 766	N 211	O 227	S 14	0	0	0
3	S	151	Total 1209	C 761	N 209	O 225	S 14	0	0	0
3	T	149	Total 1194	C 752	N 206	O 223	S 13	0	0	0

- Molecule 4 is an oligosaccharide called 2-acetamido-2-deoxy-beta-D-glucopyranose-(1-4)-2-acetamido-2-deoxy-beta-D-glucopyranose.



Mol	Chain	Residues	Atoms				ZeroOcc	AltConf	Trace
			Total	C	N	O			
4	I	2	28	16	2	10	0	0	0
4	J	2	28	16	2	10	0	0	0

- Molecule 5 is an oligosaccharide called beta-D-mannopyranose-(1-4)-2-acetamido-2-deoxy-beta-D-glucopyranose-(1-4)-2-acetamido-2-deoxy-beta-D-glucopyranose.

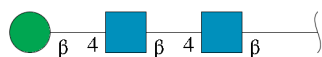

Mol	Chain	Residues	Atoms				ZeroOcc	AltConf	Trace
			Total	C	N	O			
5	K	3	39	22	2	15	0	0	0

- Molecule 6 is beta-D-mannopyranose (three-letter code: BMA) (formula: C<sub>6</sub>H<sub>12</sub>O<sub>6</sub>).

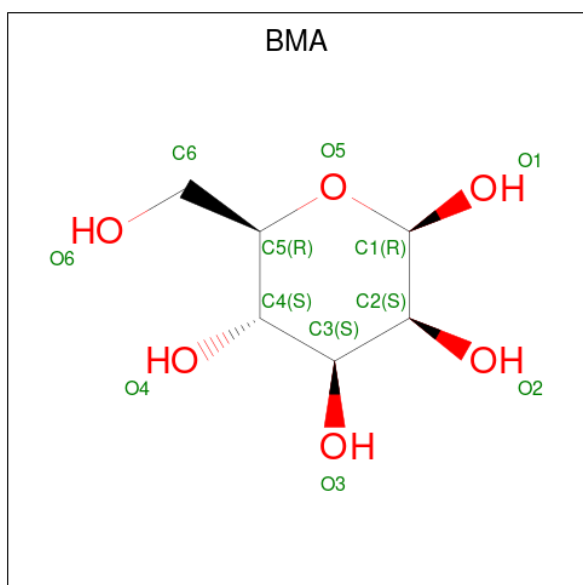

Mol	Chain	Residues	Atoms			ZeroOcc	AltConf
6	Q	1	Total	C	O	0	0
			11	6	5		

- Molecule 7 is 2-acetamido-2-deoxy-beta-D-glucopyranose (three-letter code: NAG) (formula:  $C_8H_{15}NO_6$ ).

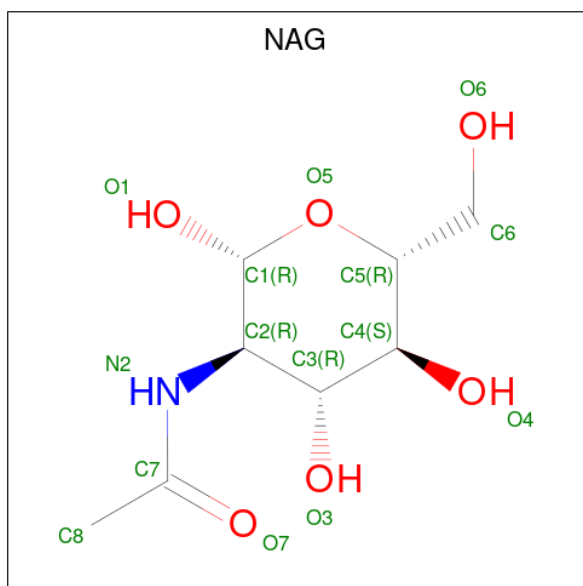

Mol	Chain	Residues	Atoms				ZeroOcc	AltConf
7	T	1	Total	C	N	O	0	0
			14	8	1	5		

### 3 Residue-property plots [i](#)

These plots are drawn for all protein, RNA, DNA and oligosaccharide chains in the entry. The first graphic for a chain summarises the proportions of the various outlier classes displayed in the second graphic. The second graphic shows the sequence view annotated by issues in geometry and electron density. Residues are color-coded according to the number of geometric quality criteria for which they contain at least one outlier: green = 0, yellow = 1, orange = 2 and red = 3 or more. A red dot above a residue indicates a poor fit to the electron density ( $RSRZ > 2$ ). Stretches of 2 or more consecutive residues without any outlier are shown as a green connector. Residues present in the sample, but not in the model, are shown in grey.

- Molecule 1: CR1-07 Fab light chain

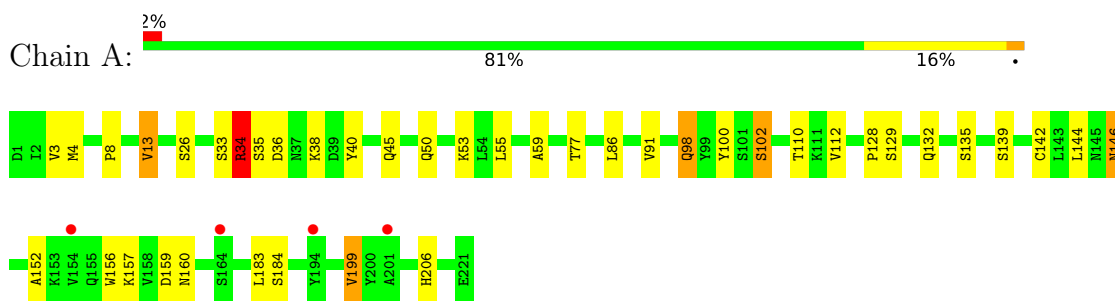

- Molecule 1: CR1-07 Fab light chain

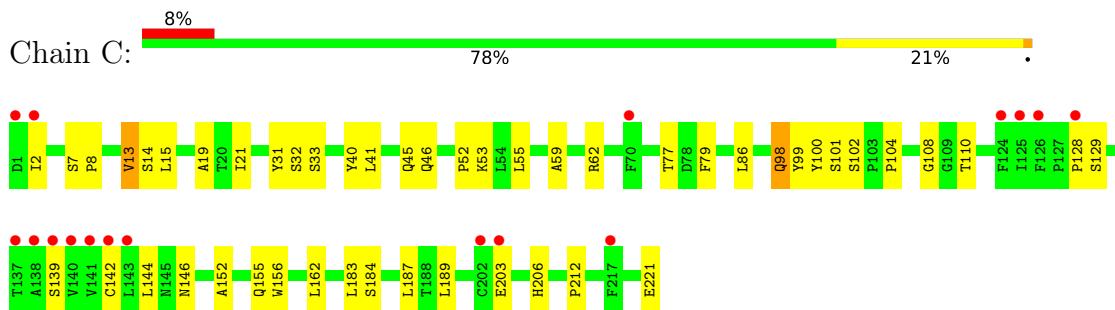

- Molecule 1: CR1-07 Fab light chain

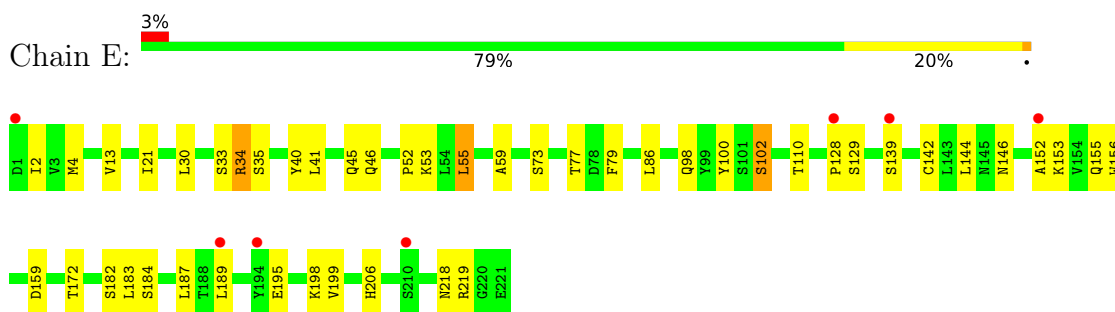

- Molecule 1: CR1-07 Fab light chain

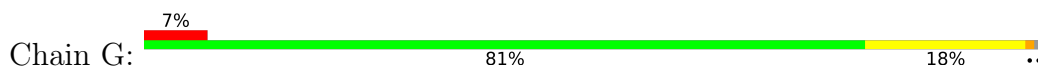

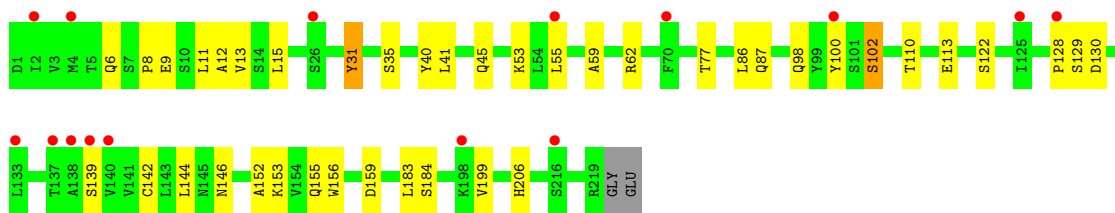

• Molecule 2: CR1-07 Fab heavy chain

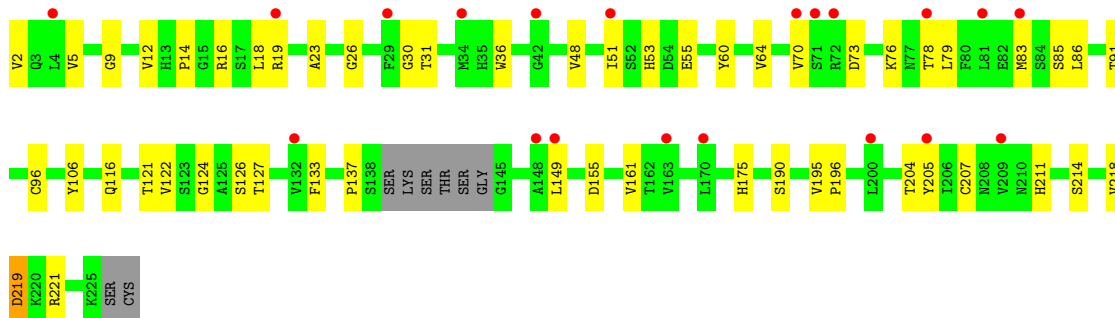
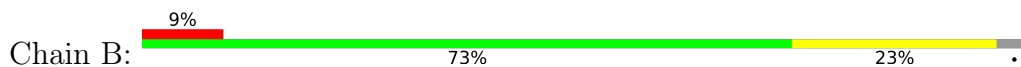

• Molecule 2: CR1-07 Fab heavy chain

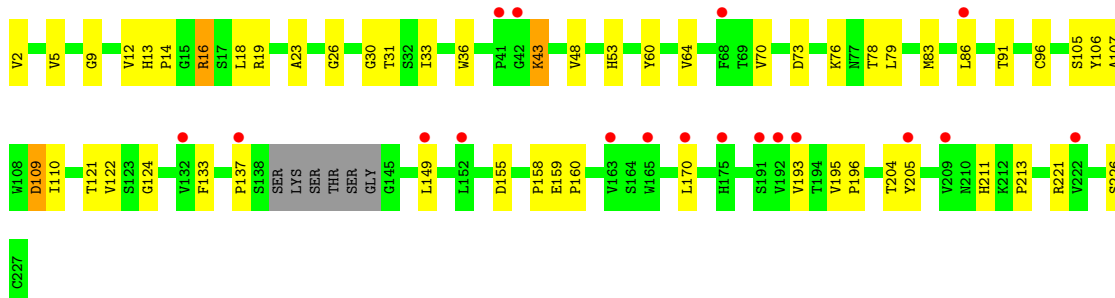
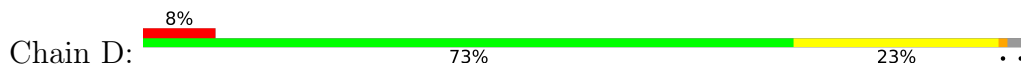

• Molecule 2: CR1-07 Fab heavy chain

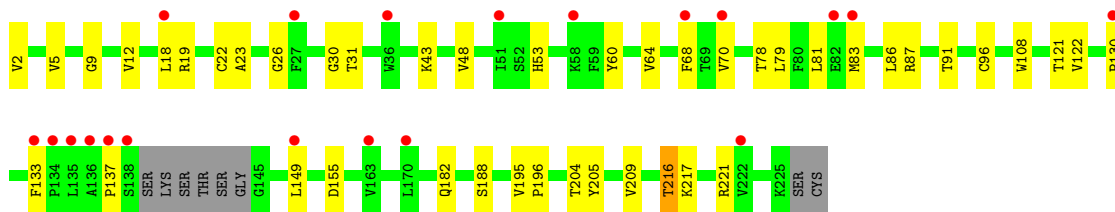
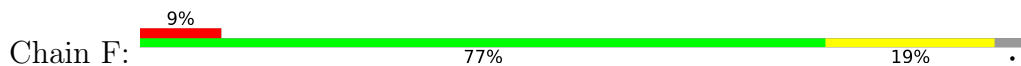

• Molecule 2: CR1-07 Fab heavy chain

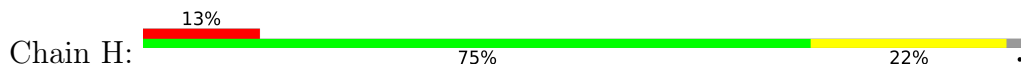



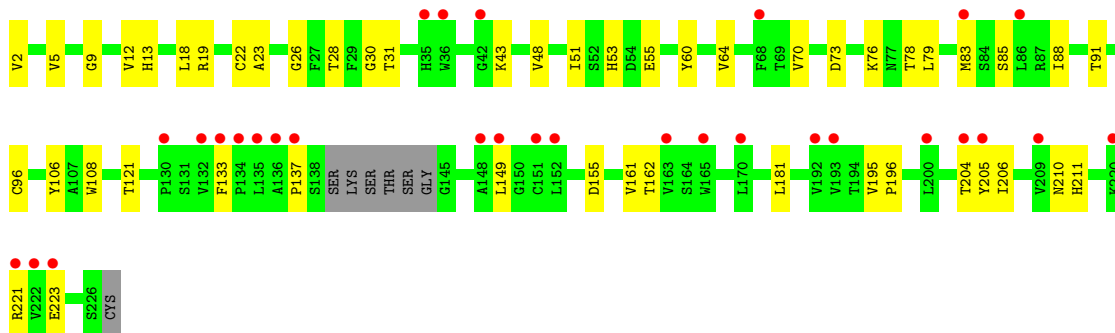

• Molecule 3: Pre-glycoprotein polyprotein GP complex

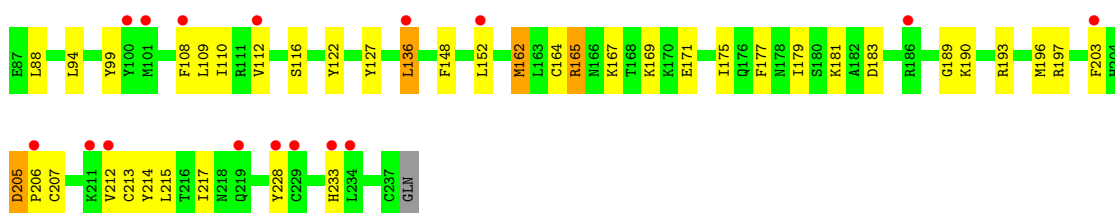

• Molecule 3: Pre-glycoprotein polyprotein GP complex

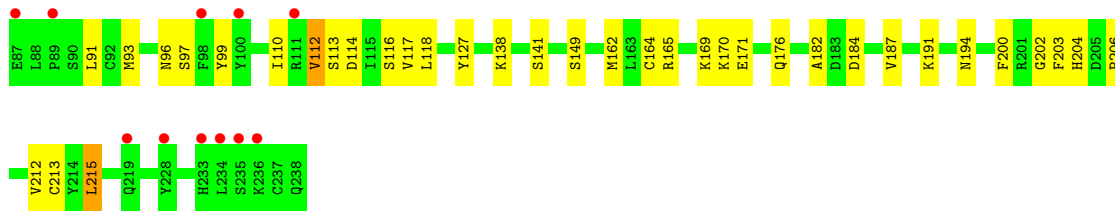
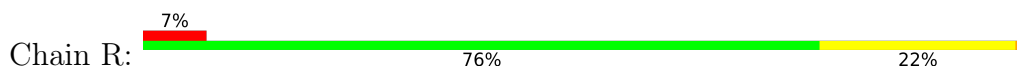

• Molecule 3: Pre-glycoprotein polyprotein GP complex

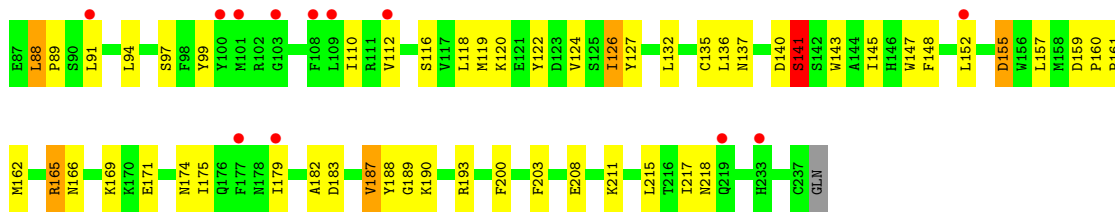

• Molecule 3: Pre-glycoprotein polyprotein GP complex





- Molecule 4: 2-acetamido-2-deoxy-beta-D-glucopyranose-(1-4)-2-acetamido-2-deoxy-beta-D-glucopyranose

Chain I: 100%

MAG1  
MAG2

- Molecule 4: 2-acetamido-2-deoxy-beta-D-glucopyranose-(1-4)-2-acetamido-2-deoxy-beta-D-glucopyranose

Chain J: 100%

MAG1  
MAG2

- Molecule 5: beta-D-mannopyranose-(1-4)-2-acetamido-2-deoxy-beta-D-glucopyranose-(1-4)-2-acetamido-2-deoxy-beta-D-glucopyranose

Chain K: 67% 33%

MAG1  
MAG2  
BMA3

## 4 Data and refinement statistics

Property	Value	Source
Space group	P 42 21 2	Depositor
Cell constants a, b, c, $\alpha$ , $\beta$ , $\gamma$	206.97Å 206.97Å 238.23Å 90.00° 90.00° 90.00°	Depositor
Resolution (Å)	49.12 – 3.91 49.12 – 3.91	Depositor EDS
% Data completeness (in resolution range)	98.6 (49.12-3.91) 98.6 (49.12-3.91)	Depositor EDS
$R_{merge}$	0.33	Depositor
$R_{sym}$	(Not available)	Depositor
$\langle I/\sigma(I) \rangle$ <sup>1</sup>	1.01 (at 3.88Å)	Xtrriage
Refinement program	BUSTER 2.10.3	Depositor
R, $R_{free}$	0.248 , 0.264 0.276 , 0.299	Depositor DCC
$R_{free}$ test set	2332 reflections (5.00%)	wwPDB-VP
Wilson B-factor (Å <sup>2</sup> )	183.6	Xtrriage
Anisotropy	0.321	Xtrriage
Bulk solvent $k_{sol}$ (e/Å <sup>3</sup> ), $B_{sol}$ (Å <sup>2</sup> )	0.33 , 53.5	EDS
L-test for twinning <sup>2</sup>	$\langle  L  \rangle = 0.41$ , $\langle L^2 \rangle = 0.24$	Xtrriage
Estimated twinning fraction	No twinning to report.	Xtrriage
$F_o, F_c$ correlation	0.91	EDS
Total number of atoms	18425	wwPDB-VP
Average B, all atoms (Å <sup>2</sup> )	33.0	wwPDB-VP

Xtrriage's analysis on translational NCS is as follows: *The largest off-origin peak in the Patterson function is 2.62% of the height of the origin peak. No significant pseudotranslation is detected.*

<sup>1</sup>Intensities estimated from amplitudes.

<sup>2</sup>Theoretical values of  $\langle |L| \rangle$ ,  $\langle L^2 \rangle$  for acentric reflections are 0.5, 0.333 respectively for untwinned datasets, and 0.375, 0.2 for perfectly twinned datasets.

## 5 Model quality [i](#)

### 5.1 Standard geometry [i](#)

Bond lengths and bond angles in the following residue types are not validated in this section: BMA, NAG

The Z score for a bond length (or angle) is the number of standard deviations the observed value is removed from the expected value. A bond length (or angle) with  $|Z| > 5$  is considered an outlier worth inspection. RMSZ is the root-mean-square of all Z scores of the bond lengths (or angles).

Mol	Chain	Bond lengths		Bond angles	
		RMSZ	# Z  >5	RMSZ	# Z  >5
1	A	0.51	0/1745	0.78	2/2369 (0.1%)
1	C	0.50	0/1751	0.74	0/2377
1	E	0.51	0/1745	0.74	0/2369
1	G	0.48	0/1732	0.72	0/2352
2	B	0.49	0/1702	0.75	0/2316
2	D	0.54	0/1714	0.78	0/2332
2	F	0.58	0/1702	0.77	0/2316
2	H	0.52	0/1714	0.75	0/2332
3	Q	0.67	0/1239	0.85	0/1670
3	R	0.77	0/1248	0.89	0/1682
3	S	0.81	0/1239	0.95	1/1670 (0.1%)
3	T	0.84	0/1224	0.99	2/1651 (0.1%)
All	All	0.59	0/18755	0.80	5/25436 (0.0%)

There are no bond length outliers.

All (5) bond angle outliers are listed below:

Mol	Chain	Res	Type	Atoms	Z	Observed(°)	Ideal(°)
3	T	174	ASN	C-N-CA	5.81	136.23	121.70
1	A	34	ARG	N-CA-C	-5.47	96.24	111.00
3	S	141	SER	N-CA-C	-5.43	96.33	111.00
1	A	34	ARG	C-N-CA	5.11	134.47	121.70
3	T	214	TYR	C-N-CA	5.09	134.41	121.70

There are no chirality outliers.

There are no planarity outliers.

## 5.2 Too-close contacts

In the following table, the Non-H and H(model) columns list the number of non-hydrogen atoms and hydrogen atoms in the chain respectively. The H(added) column lists the number of hydrogen atoms added and optimized by MolProbity. The Clashes column lists the number of clashes within the asymmetric unit, whereas Symm-Clashes lists symmetry-related clashes.

Mol	Chain	Non-H	H(model)	H(added)	Clashes	Symm-Clashes
1	A	1708	0	1650	25	0
1	C	1711	0	1655	27	0
1	E	1708	0	1650	22	0
1	G	1695	0	1641	19	0
2	B	1658	0	1619	31	0
2	D	1670	0	1629	35	0
2	F	1658	0	1619	35	0
2	H	1667	0	1629	25	0
3	Q	1209	0	1150	38	0
3	R	1218	0	1158	21	0
3	S	1209	0	1150	42	0
3	T	1194	0	1134	31	0
4	I	28	0	24	4	0
4	J	28	0	25	4	0
5	K	39	0	34	4	0
6	Q	11	0	10	1	0
7	T	14	0	13	0	0
All	All	18425	0	17790	316	0

The all-atom clashscore is defined as the number of clashes found per 1000 atoms (including hydrogen atoms). The all-atom clashscore for this structure is 9.

The worst 5 of 316 close contacts within the same asymmetric unit are listed below, sorted by their clash magnitude.

Atom-1	Atom-2	Interatomic distance (Å)	Clash overlap (Å)
3:Q:175:ILE:HG23	3:Q:217:ILE:HG23	1.39	1.04
3:Q:162:MET:HG2	3:Q:177:PHE:CE1	1.99	0.98
1:A:8:PRO:O	1:A:110:THR:HG22	1.62	0.97
3:R:99:TYR:HH	3:R:203:PHE:HD1	0.99	0.96
3:S:99:TYR:HH	3:S:203:PHE:HD1	0.99	0.95

There are no symmetry-related clashes.

## 5.3 Torsion angles [i](#)

### 5.3.1 Protein backbone [i](#)

In the following table, the Percentiles column shows the percent Ramachandran outliers of the chain as a percentile score with respect to all X-ray entries followed by that with respect to entries of similar resolution.

The Analysed column shows the number of residues for which the backbone conformation was analysed, and the total number of residues.

Mol	Chain	Analysed	Favoured	Allowed	Outliers	Percentiles	
1	A	219/221 (99%)	203 (93%)	12 (6%)	4 (2%)	8	41
1	C	220/221 (100%)	206 (94%)	11 (5%)	3 (1%)	11	46
1	E	219/221 (99%)	205 (94%)	9 (4%)	5 (2%)	6	37
1	G	217/221 (98%)	206 (95%)	8 (4%)	3 (1%)	11	46
2	B	214/226 (95%)	201 (94%)	11 (5%)	2 (1%)	17	54
2	D	216/226 (96%)	204 (94%)	8 (4%)	4 (2%)	8	40
2	F	214/226 (95%)	201 (94%)	9 (4%)	4 (2%)	8	40
2	H	216/226 (96%)	202 (94%)	12 (6%)	2 (1%)	17	54
3	Q	149/152 (98%)	132 (89%)	15 (10%)	2 (1%)	12	48
3	R	150/152 (99%)	132 (88%)	17 (11%)	1 (1%)	22	60
3	S	149/152 (98%)	128 (86%)	16 (11%)	5 (3%)	3	30
3	T	147/152 (97%)	131 (89%)	15 (10%)	1 (1%)	22	60
All	All	2330/2396 (97%)	2151 (92%)	143 (6%)	36 (2%)	10	45

5 of 36 Ramachandran outliers are listed below:

Mol	Chain	Res	Type
1	A	34	ARG
1	C	32	SER
3	S	183	ASP
1	A	35	SER
1	A	146	ASN

### 5.3.2 Protein sidechains [i](#)

In the following table, the Percentiles column shows the percent sidechain outliers of the chain as a percentile score with respect to all X-ray entries followed by that with respect to entries of similar resolution.

The Analysed column shows the number of residues for which the sidechain conformation was analysed, and the total number of residues.

Mol	Chain	Analysed	Rotameric	Outliers	Percentiles	
1	A	195/195 (100%)	188 (96%)	7 (4%)	35	61
1	C	196/195 (100%)	186 (95%)	10 (5%)	24	53
1	E	195/195 (100%)	187 (96%)	8 (4%)	30	57
1	G	194/195 (100%)	182 (94%)	12 (6%)	18	47
2	B	186/193 (96%)	180 (97%)	6 (3%)	39	63
2	D	188/193 (97%)	183 (97%)	5 (3%)	44	67
2	F	186/193 (96%)	182 (98%)	4 (2%)	52	71
2	H	188/193 (97%)	181 (96%)	7 (4%)	34	60
3	Q	136/137 (99%)	130 (96%)	6 (4%)	28	56
3	R	137/137 (100%)	126 (92%)	11 (8%)	12	41
3	S	136/137 (99%)	127 (93%)	9 (7%)	16	46
3	T	134/137 (98%)	124 (92%)	10 (8%)	13	42
All	All	2071/2100 (99%)	1976 (95%)	95 (5%)	27	55

5 of 95 residues with a non-rotameric sidechain are listed below:

Mol	Chain	Res	Type
2	H	88	ILE
3	R	164	CYS
3	Q	94	LEU
3	R	97	SER
3	R	215	LEU

Sometimes sidechains can be flipped to improve hydrogen bonding and reduce clashes. 5 of 23 such sidechains are listed below:

Mol	Chain	Res	Type
2	H	39	GLN
3	R	174	ASN
3	Q	233	HIS
3	R	219	GLN
1	E	145	ASN

### 5.3.3 RNA [i](#)

There are no RNA molecules in this entry.

## 5.4 Non-standard residues in protein, DNA, RNA chains [i](#)

There are no non-standard protein/DNA/RNA residues in this entry.

## 5.5 Carbohydrates [i](#)

7 monosaccharides are modelled in this entry.

In the following table, the Counts columns list the number of bonds (or angles) for which Mogul statistics could be retrieved, the number of bonds (or angles) that are observed in the model and the number of bonds (or angles) that are defined in the Chemical Component Dictionary. The Link column lists molecule types, if any, to which the group is linked. The Z score for a bond length (or angle) is the number of standard deviations the observed value is removed from the expected value. A bond length (or angle) with  $|Z| > 2$  is considered an outlier worth inspection. RMSZ is the root-mean-square of all Z scores of the bond lengths (or angles).

Mol	Type	Chain	Res	Link	Bond lengths			Bond angles		
					Counts	RMSZ	# Z  > 2	Counts	RMSZ	# Z  > 2
4	NAG	I	1	4,3	14,14,15	0.68	0	17,19,21	1.40	3 (17%)
4	NAG	I	2	4	14,14,15	1.12	1 (7%)	17,19,21	2.82	7 (41%)
4	NAG	J	1	4,3	14,14,15	0.57	0	17,19,21	1.37	2 (11%)
4	NAG	J	2	4	14,14,15	0.62	0	17,19,21	1.24	2 (11%)
5	NAG	K	1	5,3	14,14,15	0.44	0	17,19,21	1.69	3 (17%)
5	NAG	K	2	5	14,14,15	0.54	0	17,19,21	0.99	1 (5%)
5	BMA	K	3	5	11,11,12	0.62	0	15,15,17	1.13	2 (13%)

In the following table, the Chirals column lists the number of chiral outliers, the number of chiral centers analysed, the number of these observed in the model and the number defined in the Chemical Component Dictionary. Similar counts are reported in the Torsion and Rings columns. '-' means no outliers of that kind were identified.

Mol	Type	Chain	Res	Link	Chirals	Torsions	Rings
4	NAG	I	1	4,3	-	4/6/23/26	0/1/1/1
4	NAG	I	2	4	-	3/6/23/26	0/1/1/1
4	NAG	J	1	4,3	-	3/6/23/26	0/1/1/1
4	NAG	J	2	4	-	4/6/23/26	0/1/1/1
5	NAG	K	1	5,3	-	3/6/23/26	0/1/1/1
5	NAG	K	2	5	-	2/6/23/26	0/1/1/1
5	BMA	K	3	5	-	0/2/19/22	0/1/1/1

All (1) bond length outliers are listed below:



Mol	Chain	Res	Type	Atoms	Z	Observed(Å)	Ideal(Å)
4	I	2	NAG	O5-C1	2.10	1.47	1.43

The worst 5 of 20 bond angle outliers are listed below:

Mol	Chain	Res	Type	Atoms	Z	Observed(°)	Ideal(°)
4	I	2	NAG	O5-C1-C2	7.96	123.85	111.29
5	K	1	NAG	C2-N2-C7	4.83	129.79	122.90
4	I	2	NAG	O4-C4-C3	3.99	119.58	110.35
4	I	2	NAG	C1-C2-N2	3.65	116.73	110.49
4	I	2	NAG	O3-C3-C4	3.41	118.24	110.35

There are no chirality outliers.

5 of 19 torsion outliers are listed below:

Mol	Chain	Res	Type	Atoms
4	I	1	NAG	C3-C2-N2-C7
5	K	1	NAG	C3-C2-N2-C7
5	K	1	NAG	C8-C7-N2-C2
5	K	1	NAG	O7-C7-N2-C2
4	J	1	NAG	C8-C7-N2-C2

There are no ring outliers.

5 monomers are involved in 12 short contacts:

Mol	Chain	Res	Type	Clashes	Symm-Clashes
4	I	1	NAG	3	0
4	J	1	NAG	3	0
4	I	2	NAG	1	0
5	K	1	NAG	4	0
4	J	2	NAG	1	0

The following is a two-dimensional graphical depiction of Mogul quality analysis of bond lengths, bond angles, torsion angles, and ring geometry for oligosaccharide.

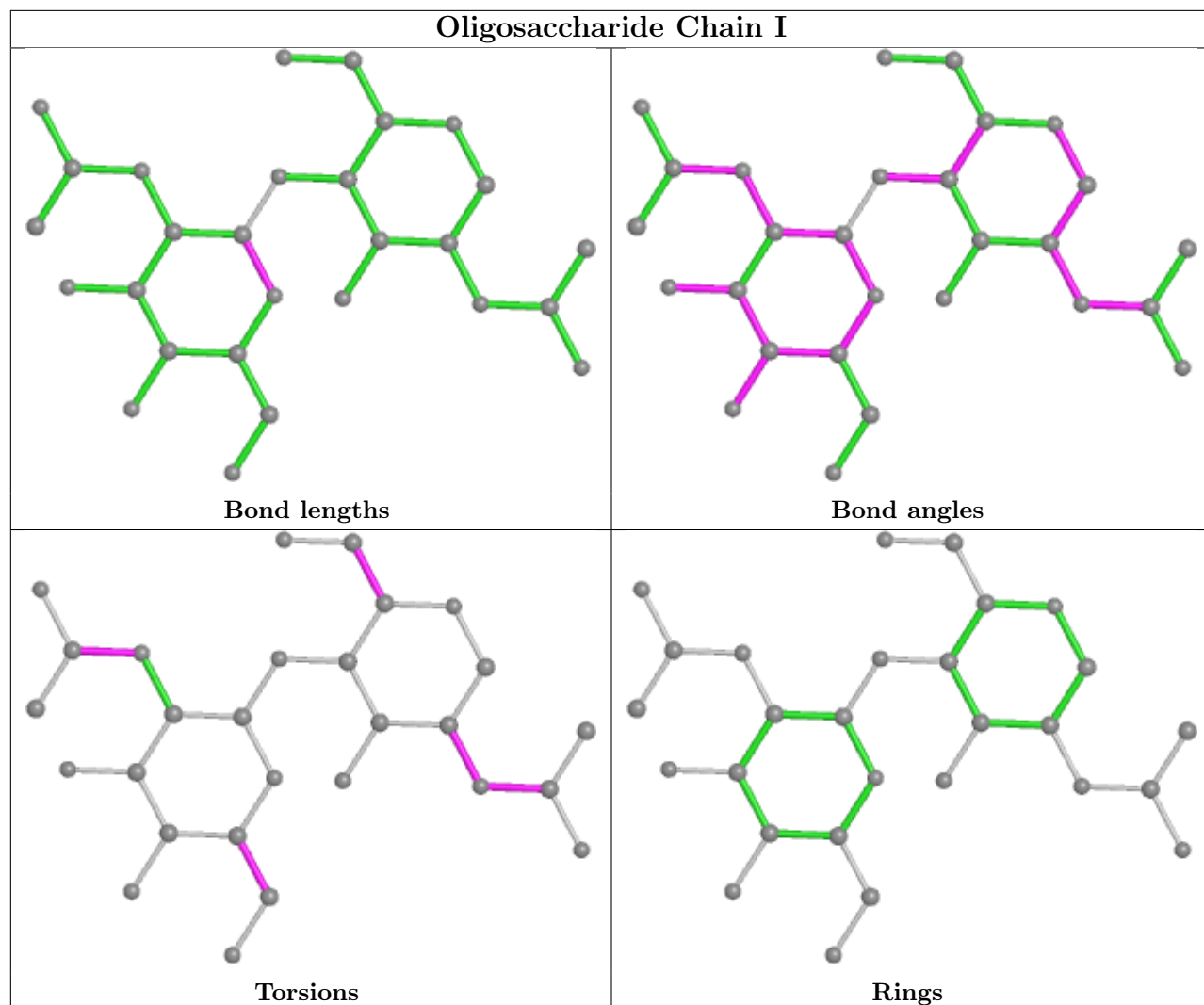

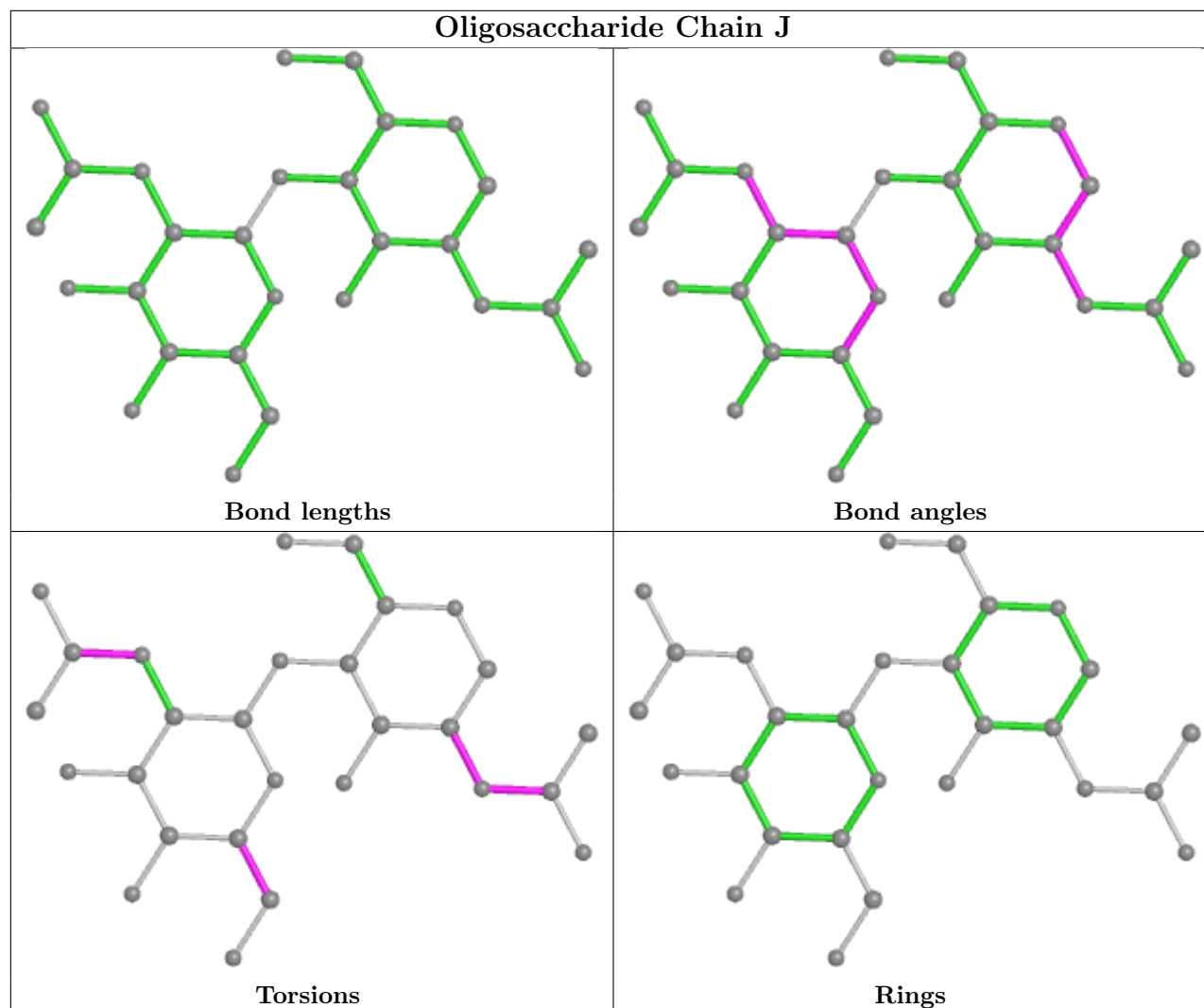

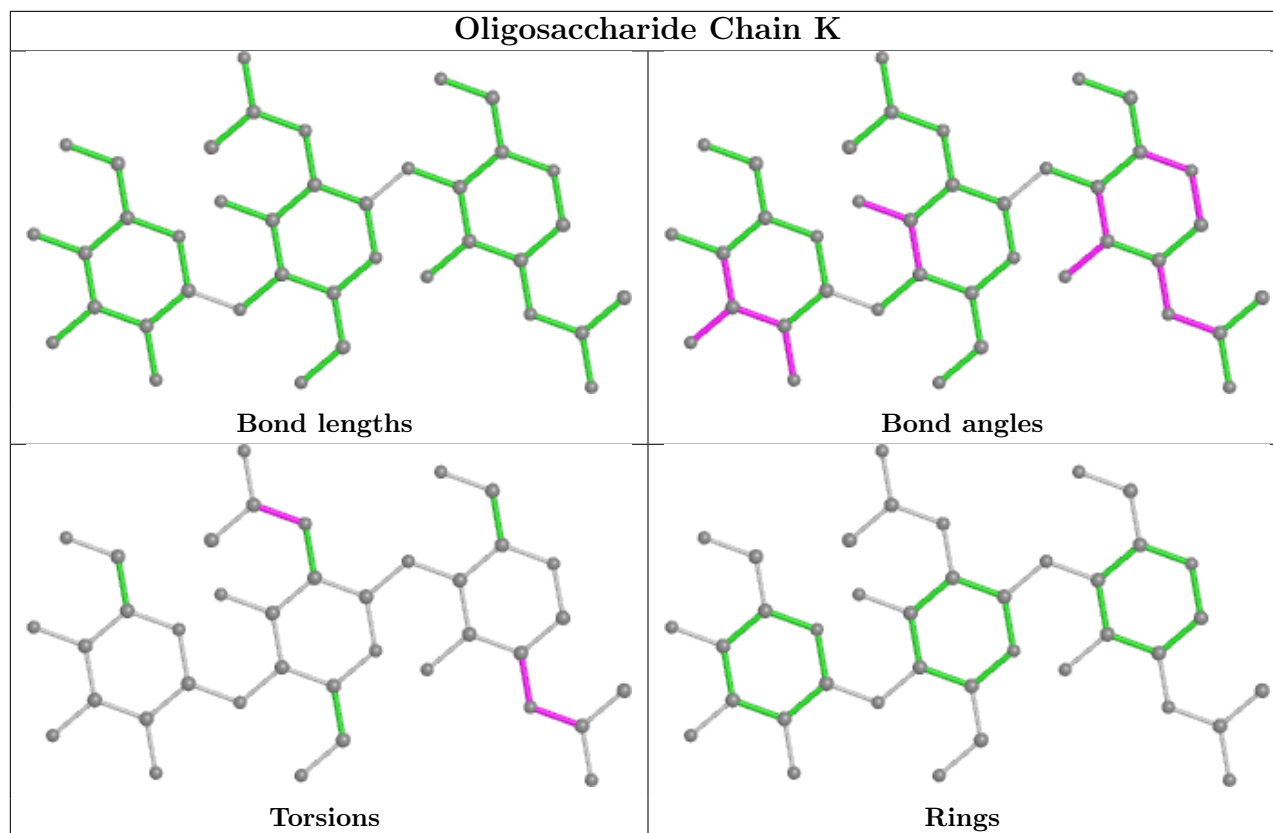

## 5.6 Ligand geometry [i](#)

2 ligands are modelled in this entry.

In the following table, the Counts columns list the number of bonds (or angles) for which Mogul statistics could be retrieved, the number of bonds (or angles) that are observed in the model and the number of bonds (or angles) that are defined in the Chemical Component Dictionary. The Link column lists molecule types, if any, to which the group is linked. The Z score for a bond length (or angle) is the number of standard deviations the observed value is removed from the expected value. A bond length (or angle) with  $|Z| > 2$  is considered an outlier worth inspection. RMSZ is the root-mean-square of all Z scores of the bond lengths (or angles).

Mol	Type	Chain	Res	Link	Bond lengths			Bond angles		
					Counts	RMSZ	$\# Z  > 2$	Counts	RMSZ	$\# Z  > 2$
7	NAG	T	301	3	14,14,15	0.55	0	17,19,21	1.47	3 (17%)
6	BMA	Q	303	-	11,11,12	1.62	3 (27%)	15,15,17	2.56	6 (40%)

In the following table, the Chirals column lists the number of chiral outliers, the number of chiral centers analysed, the number of these observed in the model and the number defined in the Chemical Component Dictionary. Similar counts are reported in the Torsion and Rings columns. '-' means no outliers of that kind were identified.

Mol	Type	Chain	Res	Link	Chirals	Torsions	Rings
7	NAG	T	301	3	-	4/6/23/26	0/1/1/1
6	BMA	Q	303	-	-	0/2/19/22	0/1/1/1

All (3) bond length outliers are listed below:

Mol	Chain	Res	Type	Atoms	Z	Observed(Å)	Ideal(Å)
6	Q	303	BMA	C1-C2	-4.07	1.42	1.52
6	Q	303	BMA	O5-C5	2.35	1.48	1.43
6	Q	303	BMA	O5-C1	-2.07	1.40	1.43

The worst 5 of 9 bond angle outliers are listed below:

Mol	Chain	Res	Type	Atoms	Z	Observed(°)	Ideal(°)
6	Q	303	BMA	O2-C2-C3	5.71	121.57	110.14
6	Q	303	BMA	O5-C1-C2	-4.23	104.24	110.77
7	T	301	NAG	C2-N2-C7	3.44	127.81	122.90
6	Q	303	BMA	C1-O5-C5	3.14	116.44	112.19
6	Q	303	BMA	O3-C3-C4	3.06	117.42	110.35

There are no chirality outliers.

All (4) torsion outliers are listed below:

Mol	Chain	Res	Type	Atoms
7	T	301	NAG	C3-C2-N2-C7
7	T	301	NAG	C8-C7-N2-C2
7	T	301	NAG	O7-C7-N2-C2
7	T	301	NAG	O5-C5-C6-O6

There are no ring outliers.

1 monomer is involved in 1 short contact:

Mol	Chain	Res	Type	Clashes	Symm-Clashes
6	Q	303	BMA	1	0

## 5.7 Other polymers [i](#)

There are no such residues in this entry.

## 5.8 Polymer linkage issues

There are no chain breaks in this entry.

## 6 Fit of model and data [i](#)

### 6.1 Protein, DNA and RNA chains [i](#)

In the following table, the column labelled ‘#RSRZ> 2’ contains the number (and percentage) of RSRZ outliers, followed by percent RSRZ outliers for the chain as percentile scores relative to all X-ray entries and entries of similar resolution. The OWAB column contains the minimum, median, 95<sup>th</sup> percentile and maximum values of the occupancy-weighted average B-factor per residue. The column labelled ‘Q< 0.9’ lists the number of (and percentage) of residues with an average occupancy less than 0.9.

Mol	Chain	Analysed	<RSRZ>	#RSRZ>2	OWAB(Å <sup>2</sup> )	Q<0.9
1	A	221/221 (100%)	0.30	4 (1%) 68 60	21, 34, 49, 60	0
1	C	221/221 (100%)	0.41	17 (7%) 13 11	21, 33, 49, 60	0
1	E	221/221 (100%)	0.34	7 (3%) 47 37	21, 33, 49, 60	0
1	G	219/221 (99%)	0.47	15 (6%) 17 14	21, 33, 49, 60	0
2	B	218/226 (96%)	0.58	20 (9%) 9 8	20, 34, 49, 76	0
2	D	220/226 (97%)	0.53	18 (8%) 11 10	20, 34, 49, 80	0
2	F	218/226 (96%)	0.58	20 (9%) 9 8	20, 34, 49, 76	0
2	H	219/226 (96%)	0.66	30 (13%) 3 3	20, 34, 49, 76	0
3	Q	151/152 (99%)	0.65	16 (10%) 6 6	38, 50, 60, 76	0
3	R	152/152 (100%)	0.40	11 (7%) 15 12	18, 24, 35, 49	0
3	S	151/152 (99%)	0.63	12 (7%) 12 11	12, 18, 30, 43	0
3	T	149/152 (98%)	0.45	10 (6%) 17 14	12, 18, 28, 43	0
All	All	2360/2396 (98%)	0.50	180 (7%) 13 11	12, 33, 52, 80	0

The worst 5 of 180 RSRZ outliers are listed below:

Mol	Chain	Res	Type	RSRZ
3	S	100	TYR	6.5
2	H	222	VAL	5.9
3	Q	100	TYR	5.9
3	Q	108	PHE	4.6
2	F	137	PRO	4.5

### 6.2 Non-standard residues in protein, DNA, RNA chains [i](#)

There are no non-standard protein/DNA/RNA residues in this entry.

### 6.3 Carbohydrates [i](#)

In the following table, the Atoms column lists the number of modelled atoms in the group and the number defined in the chemical component dictionary. The B-factors column lists the minimum, median, 95<sup>th</sup> percentile and maximum values of B factors of atoms in the group. The column labelled 'Q<0.9' lists the number of atoms with occupancy less than 0.9.

Mol	Type	Chain	Res	Atoms	RSCC	RSR	B-factors(Å <sup>2</sup> )	Q<0.9
4	NAG	I	1	14/15	0.64	0.46	30,30,30,30	0
4	NAG	I	2	14/15	0.70	0.37	30,30,30,30	0
4	NAG	J	2	14/15	0.75	0.25	30,30,30,30	0
4	NAG	J	1	14/15	0.88	0.24	30,30,30,30	0
5	BMA	K	3	11/12	0.88	0.12	30,30,30,30	0
5	NAG	K	2	14/15	0.89	0.21	30,30,30,30	0
5	NAG	K	1	14/15	0.90	0.27	30,30,30,30	0

The following is a graphical depiction of the model fit to experimental electron density for oligosaccharide. Each fit is shown from different orientation to approximate a three-dimensional view.

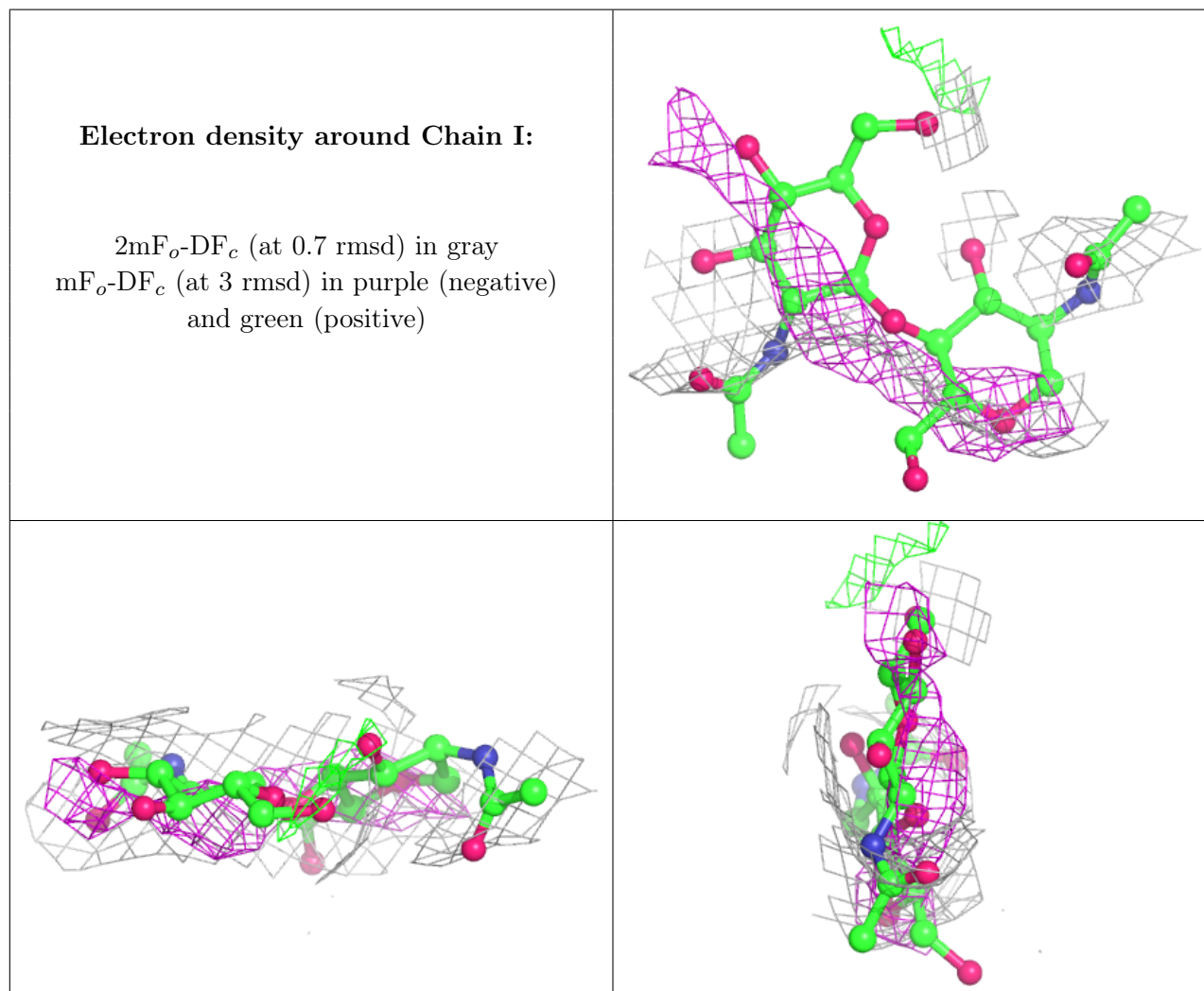



**Electron density around Chain J:**

$2mF_o-DF_c$  (at 0.7 rmsd) in gray  
 $mF_o-DF_c$  (at 3 rmsd) in purple (negative)  
and green (positive)

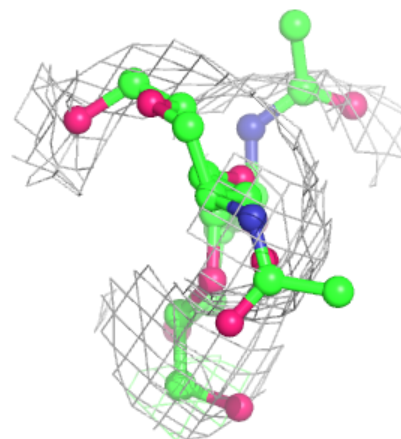
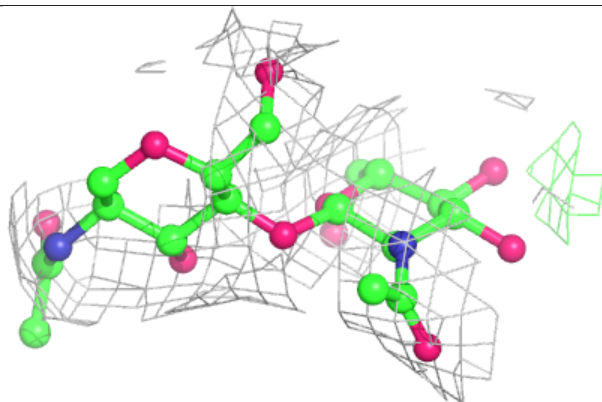
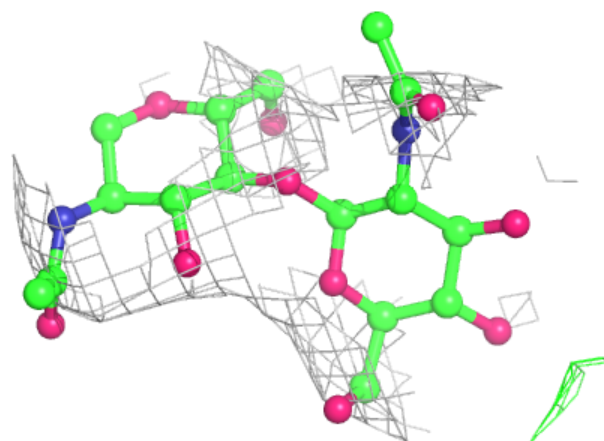
**Electron density around Chain K:**

$2mF_o-DF_c$  (at 0.7 rmsd) in gray  
 $mF_o-DF_c$  (at 3 rmsd) in purple (negative)  
and green (positive)

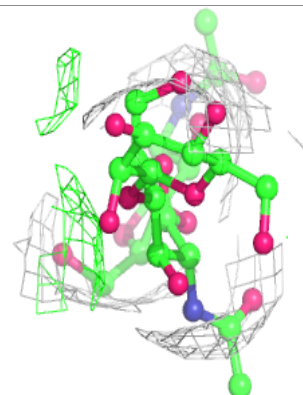
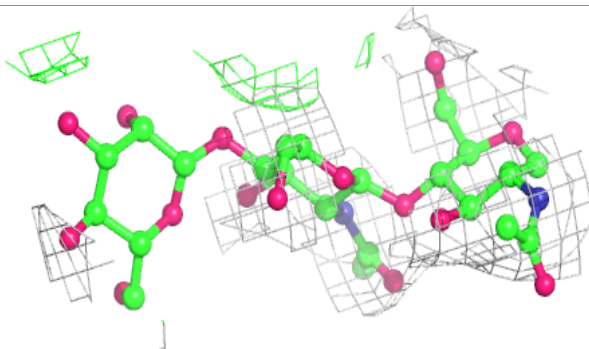
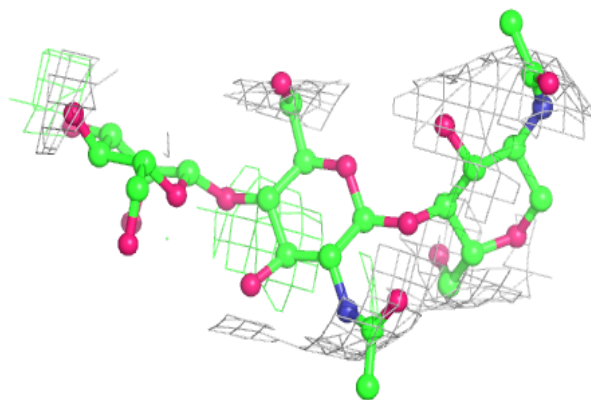

## 6.4 Ligands [i](#)

In the following table, the Atoms column lists the number of modelled atoms in the group and the number defined in the chemical component dictionary. The B-factors column lists the minimum, median, 95<sup>th</sup> percentile and maximum values of B factors of atoms in the group. The column labelled 'Q< 0.9' lists the number of atoms with occupancy less than 0.9.

Mol	Type	Chain	Res	Atoms	RSCC	RSR	B-factors(Å <sup>2</sup> )	Q<0.9
7	NAG	T	301	14/15	0.79	0.33	30,30,30,30	0
6	BMA	Q	303	11/12	0.87	0.29	30,30,30,30	0

## 6.5 Other polymers [i](#)

There are no such residues in this entry.