



wwPDB X-ray Structure Validation Summary Report ⓘ

Mar 13, 2024 – 06:15 PM EDT

PDB ID : 8V8J
Title : PI3Ka H1047R co-crystal structure with inhibitors in two cryptic pockets (compounds 4 and 5).
Authors : Gunn, R.J.; Lawson, J.D.
Deposited on : 2023-12-05
Resolution : 3.35 Å (reported)

This is a wwPDB X-ray Structure Validation Summary Report for a publicly released PDB entry.

We welcome your comments at validation@mail.wwpdb.org

A user guide is available at

<https://www.wwpdb.org/validation/2017/XrayValidationReportHelp>

with specific help available everywhere you see the ⓘ symbol.

The types of validation reports are described at

<http://www.wwpdb.org/validation/2017/FAQs#types>.

The following versions of software and data (see [references ⓘ](#)) were used in the production of this report:

MolProbity : 4.02b-467
Mogul : 1.8.5 (274361), CSD as541be (2020)
Xtriage (Phenix) : 1.13
EDS : 2.36
buster-report : 1.1.7 (2018)
Percentile statistics : 20191225.v01 (using entries in the PDB archive December 25th 2019)
Refmac : 5.8.0158
CCP4 : 7.0.044 (Gargrove)
Ideal geometry (proteins) : Engh & Huber (2001)
Ideal geometry (DNA, RNA) : Parkinson et al. (1996)
Validation Pipeline (wwPDB-VP) : 2.36

1 Overall quality at a glance

The following experimental techniques were used to determine the structure:

X-RAY DIFFRACTION

The reported resolution of this entry is 3.35 Å.

Percentile scores (ranging between 0-100) for global validation metrics of the entry are shown in the following graphic. The table shows the number of entries on which the scores are based.

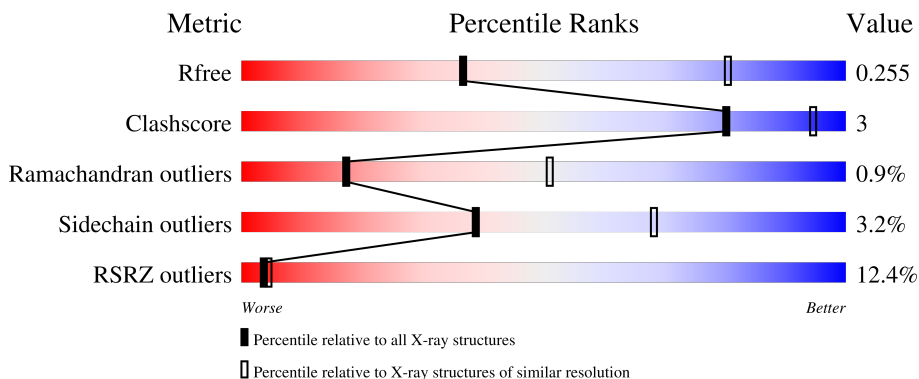

Metric	Whole archive (#Entries)	Similar resolution (#Entries, resolution range(Å))
R_{free}	130704	1558 (3.42-3.30)
Clashscore	141614	1627 (3.42-3.30)
Ramachandran outliers	138981	1599 (3.42-3.30)
Sidechain outliers	138945	1598 (3.42-3.30)
RSRZ outliers	127900	1507 (3.42-3.30)

The table below summarises the geometric issues observed across the polymeric chains and their fit to the electron density. The red, orange, yellow and green segments of the lower bar indicate the fraction of residues that contain outliers for ≥ 3 , 2, 1 and 0 types of geometric quality criteria respectively. A grey segment represents the fraction of residues that are not modelled. The numeric value for each fraction is indicated below the corresponding segment, with a dot representing fractions $\leq 5\%$. The upper red bar (where present) indicates the fraction of residues that have poor fit to the electron density. The numeric value is given above the bar.

Mol	Chain	Length	Quality of chain
1	A	1072	 4% (poor fit), 84% (0-3 outliers), 10% (1 outlier), 5% (2 outliers), 0% (3+ outliers)
1	C	1072	 5% (poor fit), 84% (0-3 outliers), 10% (1 outlier), 6% (2 outliers), 0% (3+ outliers)
2	B	279	 34% (poor fit), 77% (0-3 outliers), 8% (1 outlier), 14% (2 outliers), 0% (3+ outliers)
2	D	279	 44% (poor fit), 78% (0-3 outliers), 7% (1 outlier), 14% (2 outliers), 0% (3+ outliers)

2 Entry composition [i](#)

There are 5 unique types of molecules in this entry. The entry contains 20898 atoms, of which 0 are hydrogens and 0 are deuteriums.

In the tables below, the ZeroOcc column contains the number of atoms modelled with zero occupancy, the AltConf column contains the number of residues with at least one atom in alternate conformation and the Trace column contains the number of residues modelled with at most 2 atoms.

- Molecule 1 is a protein called Phosphatidylinositol 4,5-bisphosphate 3-kinase catalytic subunit alpha isoform.

Mol	Chain	Residues	Atoms					ZeroOcc	AltConf	Trace
			Total	C	N	O	S			
1	A	1017	8332	5336	1423	1504	69	0	0	0
1	C	1013	8296	5310	1418	1499	69	0	0	0

There are 10 discrepancies between the modelled and reference sequences:

Chain	Residue	Modelled	Actual	Comment	Reference
A	-3	ALA	-	expression tag	UNP P42336
A	-2	MET	-	expression tag	UNP P42336
A	-1	GLY	-	expression tag	UNP P42336
A	0	SER	-	expression tag	UNP P42336
A	1047	ARG	HIS	engineered mutation	UNP P42336
C	-3	ALA	-	expression tag	UNP P42336
C	-2	MET	-	expression tag	UNP P42336
C	-1	GLY	-	expression tag	UNP P42336
C	0	SER	-	expression tag	UNP P42336
C	1047	ARG	HIS	engineered mutation	UNP P42336

- Molecule 2 is a protein called Phosphatidylinositol 3-kinase regulatory subunit alpha.

Mol	Chain	Residues	Atoms					ZeroOcc	AltConf	Trace
			Total	C	N	O	S			
2	B	239	2042	1282	362	392	6	0	0	0
2	D	239	2042	1282	362	392	6	0	0	0

- Molecule 3 is 2-((1R)-1-[2-(4,4-dimethylpiperidin-1-yl)-3,6-dimethyl-4-oxo-4H-1-benzopyran-8-yl]ethyl)amino)benzoic acid (three-letter code: YO4) (formula: C₂₇H₃₂N₂O₄) (labeled as "Ligand of Interest" by depositor).

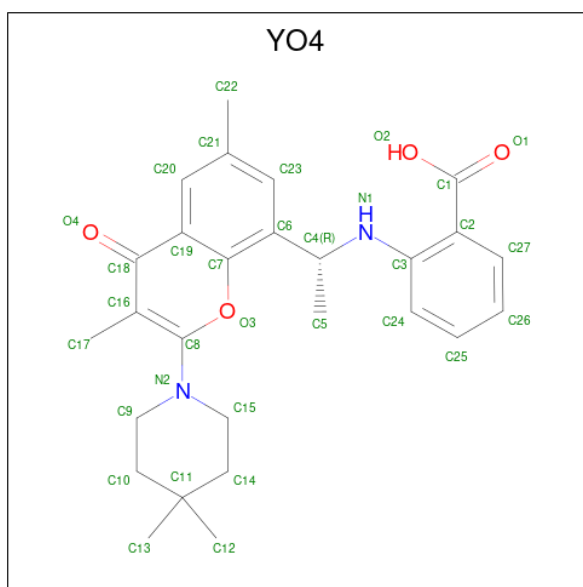

Mol	Chain	Residues	Atoms				ZeroOcc	AltConf
3	A	1	Total	C	N	O	0	0
			33	27	2	4		
3	C	1	Total	C	N	O	0	0
			33	27	2	4		

- Molecule 4 is N-{(3S)-3-(2-methylphenyl)-6-[(oxetan-3-yl)amino]-1-oxo-2,3-dihydro-1H-isoindol-4-yl}-1-benzothiophene-3-carboxamide (three-letter code: YOR) (formula: C₂₇H₂₃N₃O₃S) (labeled as "Ligand of Interest" by depositor).

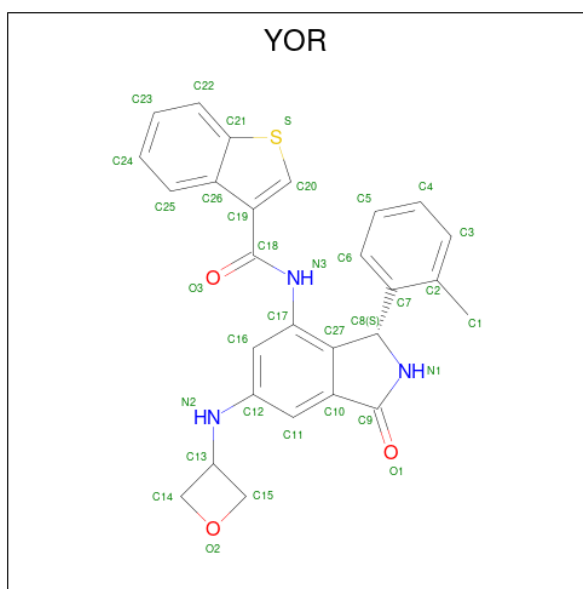

Mol	Chain	Residues	Atoms					ZeroOcc	AltConf
4	A	1	Total	C	N	O	S	0	0
			34	27	3	3	1		

Continued on next page...

Continued from previous page...

Mol	Chain	Residues	Atoms					ZeroOcc	AltConf
			Total	C	N	O	S		
4	C	1	34	27	3	3	1	0	0

- Molecule 5 is (2S)-N 1 -[(4P)-2-tert-butyl-4'-methyl[4,5'-bi-1,3-thiazol]-2'-yl]pyrrolidine-1, 2-dicarboxamide (three-letter code: YNZ) (formula: C₁₇H₂₃N₅O₂S₂) (labeled as "Ligand of Interest" by depositor).

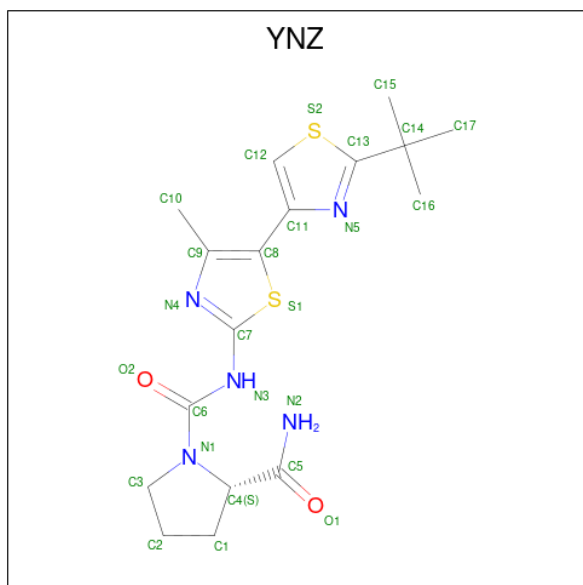

Mol	Chain	Residues	Atoms					ZeroOcc	AltConf
			Total	C	N	O	S		
5	A	1	26	17	5	2	2	0	0
5	C	1	26	17	5	2	2	0	0

3 Residue-property plots [i](#)

These plots are drawn for all protein, RNA, DNA and oligosaccharide chains in the entry. The first graphic for a chain summarises the proportions of the various outlier classes displayed in the second graphic. The second graphic shows the sequence view annotated by issues in geometry and electron density. Residues are color-coded according to the number of geometric quality criteria for which they contain at least one outlier: green = 0, yellow = 1, orange = 2 and red = 3 or more. A red dot above a residue indicates a poor fit to the electron density ($RSRZ > 2$). Stretches of 2 or more consecutive residues without any outlier are shown as a green connector. Residues present in the sample, but not in the model, are shown in grey.

- Molecule 1: Phosphatidylinositol 4,5-bisphosphate 3-kinase catalytic subunit alpha isoform

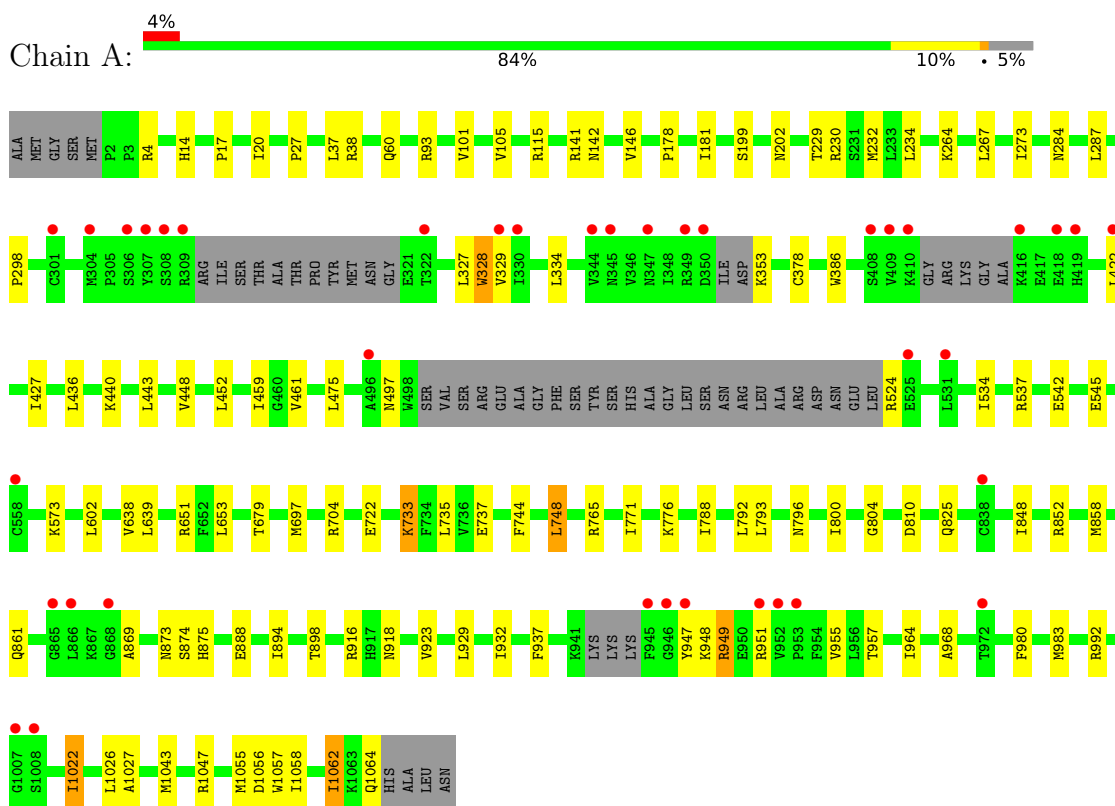

- Molecule 1: Phosphatidylinositol 4,5-bisphosphate 3-kinase catalytic subunit alpha isoform

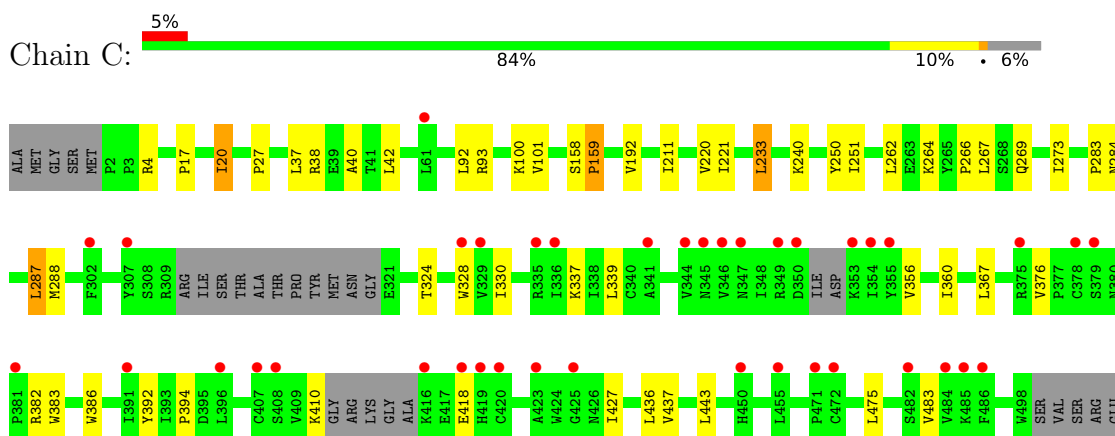

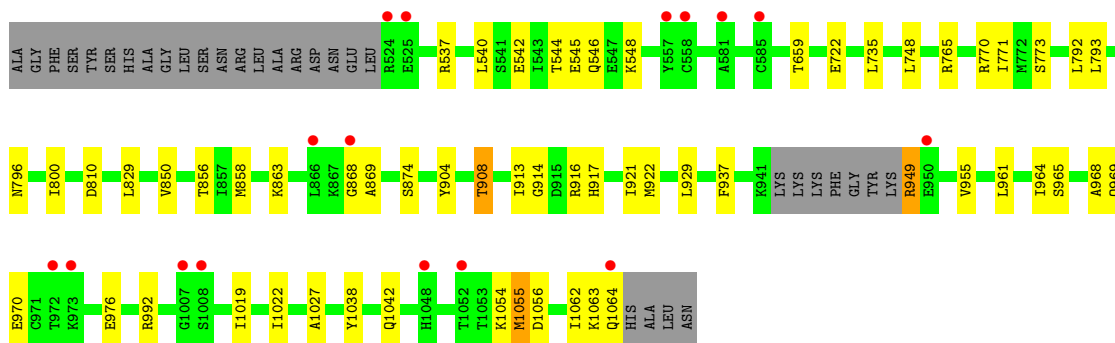

• Molecule 2: Phosphatidylinositol 3-kinase regulatory subunit alpha

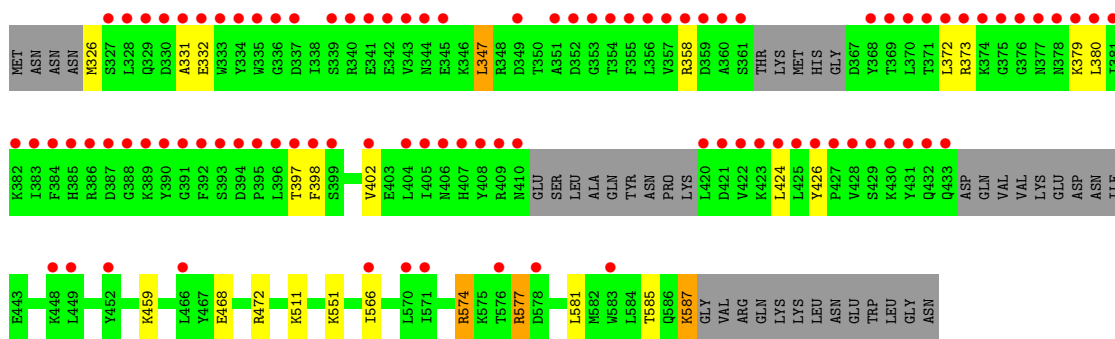
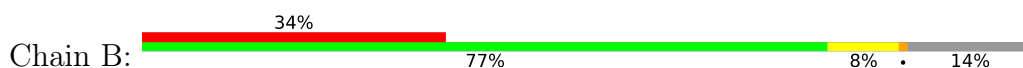

• Molecule 2: Phosphatidylinositol 3-kinase regulatory subunit alpha

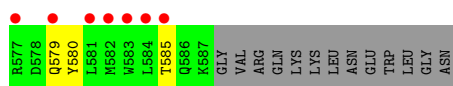
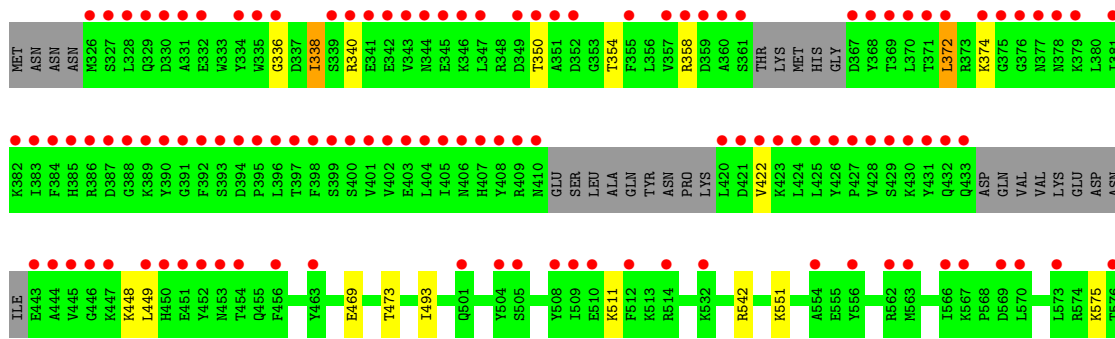
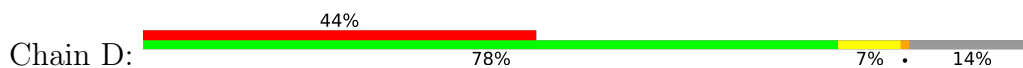

4 Data and refinement statistics

Property	Value	Source
Space group	C 1 2 1	Depositor
Cell constants a, b, c, α , β , γ	236.94Å 158.48Å 121.60Å 90.00° 112.83° 90.00°	Depositor
Resolution (Å)	43.47 – 3.35 43.47 – 3.35	Depositor EDS
% Data completeness (in resolution range)	99.9 (43.47-3.35) 99.9 (43.47-3.35)	Depositor EDS
R_{merge}	(Not available)	Depositor
R_{sym}	(Not available)	Depositor
$\langle I/\sigma(I) \rangle$ ¹	3.29 (at 3.32Å)	Xtrriage
Refinement program	PHENIX 1.20.1_4487	Depositor
R, R_{free}	0.209 , 0.251 0.209 , 0.255	Depositor DCC
R_{free} test set	2937 reflections (4.94%)	wwPDB-VP
Wilson B-factor (Å ²)	89.4	Xtrriage
Anisotropy	0.466	Xtrriage
Bulk solvent k_{sol} (e/Å ³), B_{sol} (Å ²)	0.31 , 59.2	EDS
L-test for twinning ²	$\langle L \rangle = 0.50$, $\langle L^2 \rangle = 0.34$	Xtrriage
Estimated twinning fraction	No twinning to report.	Xtrriage
F_o, F_c correlation	0.93	EDS
Total number of atoms	20898	wwPDB-VP
Average B, all atoms (Å ²)	116.0	wwPDB-VP

Xtrriage's analysis on translational NCS is as follows: *The largest off-origin peak in the Patterson function is 3.72% of the height of the origin peak. No significant pseudotranslation is detected.*

¹Intensities estimated from amplitudes.

²Theoretical values of $\langle |L| \rangle$, $\langle L^2 \rangle$ for acentric reflections are 0.5, 0.333 respectively for untwinned datasets, and 0.375, 0.2 for perfectly twinned datasets.

5 Model quality [i](#)

5.1 Standard geometry [i](#)

Bond lengths and bond angles in the following residue types are not validated in this section: YNZ, YO4, YOR

The Z score for a bond length (or angle) is the number of standard deviations the observed value is removed from the expected value. A bond length (or angle) with $|Z| > 5$ is considered an outlier worth inspection. RMSZ is the root-mean-square of all Z scores of the bond lengths (or angles).

Mol	Chain	Bond lengths		Bond angles	
		RMSZ	# Z >5	RMSZ	# Z >5
1	A	0.24	0/8521	0.47	0/11513
1	C	0.24	0/8483	0.47	0/11463
2	B	0.24	0/2074	0.54	0/2772
2	D	0.24	0/2074	0.52	0/2772
All	All	0.24	0/21152	0.48	0/28520

There are no bond length outliers.

There are no bond angle outliers.

There are no chirality outliers.

There are no planarity outliers.

5.2 Too-close contacts [i](#)

In the following table, the Non-H and H(model) columns list the number of non-hydrogen atoms and hydrogen atoms in the chain respectively. The H(added) column lists the number of hydrogen atoms added and optimized by MolProbity. The Clashes column lists the number of clashes within the asymmetric unit, whereas Symm-Clashes lists symmetry-related clashes.

Mol	Chain	Non-H	H(model)	H(added)	Clashes	Symm-Clashes
1	A	8332	0	8349	50	0
1	C	8296	0	8315	52	0
2	B	2042	0	2018	12	0
2	D	2042	0	2018	9	0
3	A	33	0	0	1	0
3	C	33	0	0	0	0
4	A	34	0	0	0	0
4	C	34	0	0	1	0
5	A	26	0	0	0	0

Continued on next page...

Continued from previous page...

Mol	Chain	Non-H	H(model)	H(added)	Clashes	Symm-Clashes
5	C	26	0	0	0	0
All	All	20898	0	20700	114	0

The all-atom clashscore is defined as the number of clashes found per 1000 atoms (including hydrogen atoms). The all-atom clashscore for this structure is 3.

The worst 5 of 114 close contacts within the same asymmetric unit are listed below, sorted by their clash magnitude.

Atom-1	Atom-2	Interatomic distance (Å)	Clash overlap (Å)
1:A:353:LYS:N	1:A:378:CYS:HG	1.77	0.81
1:A:765:ARG:NH1	1:A:796:ASN:OD1	2.26	0.69
1:C:1038:TYR:O	1:C:1042:GLN:NE2	2.26	0.68
1:A:461:VAL:HG11	1:A:679:THR:HB	1.78	0.66
1:C:968:ALA:O	1:C:970:GLU:N	2.29	0.65

There are no symmetry-related clashes.

5.3 Torsion angles [i](#)

5.3.1 Protein backbone [i](#)

In the following table, the Percentiles column shows the percent Ramachandran outliers of the chain as a percentile score with respect to all X-ray entries followed by that with respect to entries of similar resolution.

The Analysed column shows the number of residues for which the backbone conformation was analysed, and the total number of residues.

Mol	Chain	Analysed	Favoured	Allowed	Outliers	Percentiles	
1	A	1005/1072 (94%)	938 (93%)	59 (6%)	8 (1%)	19	53
1	C	1001/1072 (93%)	926 (92%)	66 (7%)	9 (1%)	17	51
2	B	231/279 (83%)	207 (90%)	21 (9%)	3 (1%)	12	42
2	D	231/279 (83%)	209 (90%)	20 (9%)	2 (1%)	17	51
All	All	2468/2702 (91%)	2280 (92%)	166 (7%)	22 (1%)	17	51

5 of 22 Ramachandran outliers are listed below:

Mol	Chain	Res	Type
1	A	722	GLU

Continued on next page...

Continued from previous page...

Mol	Chain	Res	Type
1	A	874	SER
1	C	722	GLU
1	C	874	SER
1	C	969	GLN

5.3.2 Protein sidechains [i](#)

In the following table, the Percentiles column shows the percent sidechain outliers of the chain as a percentile score with respect to all X-ray entries followed by that with respect to entries of similar resolution.

The Analysed column shows the number of residues for which the sidechain conformation was analysed, and the total number of residues.

Mol	Chain	Analysed	Rotameric	Outliers	Percentiles
1	A	934/976 (96%)	901 (96%)	33 (4%)	36 66
1	C	931/976 (95%)	905 (97%)	26 (3%)	43 71
2	B	223/259 (86%)	215 (96%)	8 (4%)	35 64
2	D	223/259 (86%)	215 (96%)	8 (4%)	35 64
All	All	2311/2470 (94%)	2236 (97%)	75 (3%)	39 68

5 of 75 residues with a non-rotameric sidechain are listed below:

Mol	Chain	Res	Type
1	C	863	LYS
2	D	551	LYS
1	C	929	LEU
1	C	1063	LYS
1	A	825	GLN

Sometimes sidechains can be flipped to improve hydrogen bonding and reduce clashes. All (2) such sidechains are listed below:

Mol	Chain	Res	Type
1	A	384	ASN
1	A	647	ASN

5.3.3 RNA [i](#)

There are no RNA molecules in this entry.

5.4 Non-standard residues in protein, DNA, RNA chains [i](#)

There are no non-standard protein/DNA/RNA residues in this entry.

5.5 Carbohydrates [i](#)

There are no monosaccharides in this entry.

5.6 Ligand geometry [i](#)

6 ligands are modelled in this entry.

In the following table, the Counts columns list the number of bonds (or angles) for which Mogul statistics could be retrieved, the number of bonds (or angles) that are observed in the model and the number of bonds (or angles) that are defined in the Chemical Component Dictionary. The Link column lists molecule types, if any, to which the group is linked. The Z score for a bond length (or angle) is the number of standard deviations the observed value is removed from the expected value. A bond length (or angle) with $|Z| > 2$ is considered an outlier worth inspection. RMSZ is the root-mean-square of all Z scores of the bond lengths (or angles).

Mol	Type	Chain	Res	Link	Bond lengths			Bond angles		
					Counts	RMSZ	# Z > 2	Counts	RMSZ	# Z > 2
3	YO4	C	1101	-	36,36,36	0.89	2 (5%)	47,54,54	1.83	8 (17%)
4	YOR	A	1102	-	35,39,39	1.42	3 (8%)	40,57,57	2.12	7 (17%)
4	YOR	C	1102	-	35,39,39	1.38	3 (8%)	40,57,57	2.18	7 (17%)
3	YO4	A	1101	-	36,36,36	0.93	2 (5%)	47,54,54	1.79	9 (19%)
5	YNZ	A	1103	-	21,28,28	1.17	2 (9%)	21,42,42	1.36	3 (14%)
5	YNZ	C	1103	-	21,28,28	1.15	1 (4%)	21,42,42	1.38	5 (23%)

In the following table, the Chirals column lists the number of chiral outliers, the number of chiral centers analysed, the number of these observed in the model and the number defined in the Chemical Component Dictionary. Similar counts are reported in the Torsion and Rings columns. '-' means no outliers of that kind were identified.

Mol	Type	Chain	Res	Link	Chirals	Torsions	Rings
3	YO4	C	1101	-	-	7/16/28/28	0/4/4/4
4	YOR	A	1102	-	-	5/14/34/34	0/6/6/6
4	YOR	C	1102	-	-	3/14/34/34	0/6/6/6
3	YO4	A	1101	-	-	7/16/28/28	0/4/4/4
5	YNZ	A	1103	-	-	2/13/32/32	0/3/3/3
5	YNZ	C	1103	-	-	5/13/32/32	0/3/3/3

The worst 5 of 13 bond length outliers are listed below:

Mol	Chain	Res	Type	Atoms	Z	Observed(Å)	Ideal(Å)
4	C	1102	YOR	C19-C26	5.27	1.47	1.42
4	A	1102	YOR	C19-C26	5.24	1.47	1.42
4	A	1102	YOR	C20-C19	-4.76	1.34	1.37
4	C	1102	YOR	C20-C19	-4.53	1.34	1.37
5	A	1103	YNZ	C12-S2	3.90	1.76	1.70

The worst 5 of 39 bond angle outliers are listed below:

Mol	Chain	Res	Type	Atoms	Z	Observed(°)	Ideal(°)
4	C	1102	YOR	C10-C9-N1	10.56	110.63	106.49
4	A	1102	YOR	C10-C9-N1	10.34	110.55	106.49
3	C	1101	YO4	O3-C7-C6	7.64	123.49	115.22
3	A	1101	YO4	O3-C7-C6	7.31	123.14	115.22
3	C	1101	YO4	O3-C8-N2	4.20	116.79	111.55

There are no chirality outliers.

5 of 29 torsion outliers are listed below:

Mol	Chain	Res	Type	Atoms
3	A	1101	YO4	C16-C8-N2-C9
3	A	1101	YO4	O3-C8-N2-C15
3	A	1101	YO4	O3-C8-N2-C9
3	C	1101	YO4	C16-C8-N2-C9
3	C	1101	YO4	O3-C8-N2-C15

There are no ring outliers.

2 monomers are involved in 2 short contacts:

Mol	Chain	Res	Type	Clashes	Symm-Clashes
4	C	1102	YOR	1	0
3	A	1101	YO4	1	0

The following is a two-dimensional graphical depiction of Mogul quality analysis of bond lengths, bond angles, torsion angles, and ring geometry for all instances of the Ligand of Interest. In addition, ligands with molecular weight > 250 and outliers as shown on the validation Tables will also be included. For torsion angles, if less than 5% of the Mogul distribution of torsion angles is within 10 degrees of the torsion angle in question, then that torsion angle is considered an outlier. Any bond that is central to one or more torsion angles identified as an outlier by Mogul will be highlighted in the graph. For rings, the root-mean-square deviation (RMSD) between the ring in question and similar rings identified by Mogul is calculated over all ring torsion angles. If the average RMSD is greater than 60 degrees and the minimal RMSD between the ring in question and

any Mogul-identified rings is also greater than 60 degrees, then that ring is considered an outlier. The outliers are highlighted in purple. The color gray indicates Mogul did not find sufficient equivalents in the CSD to analyse the geometry.

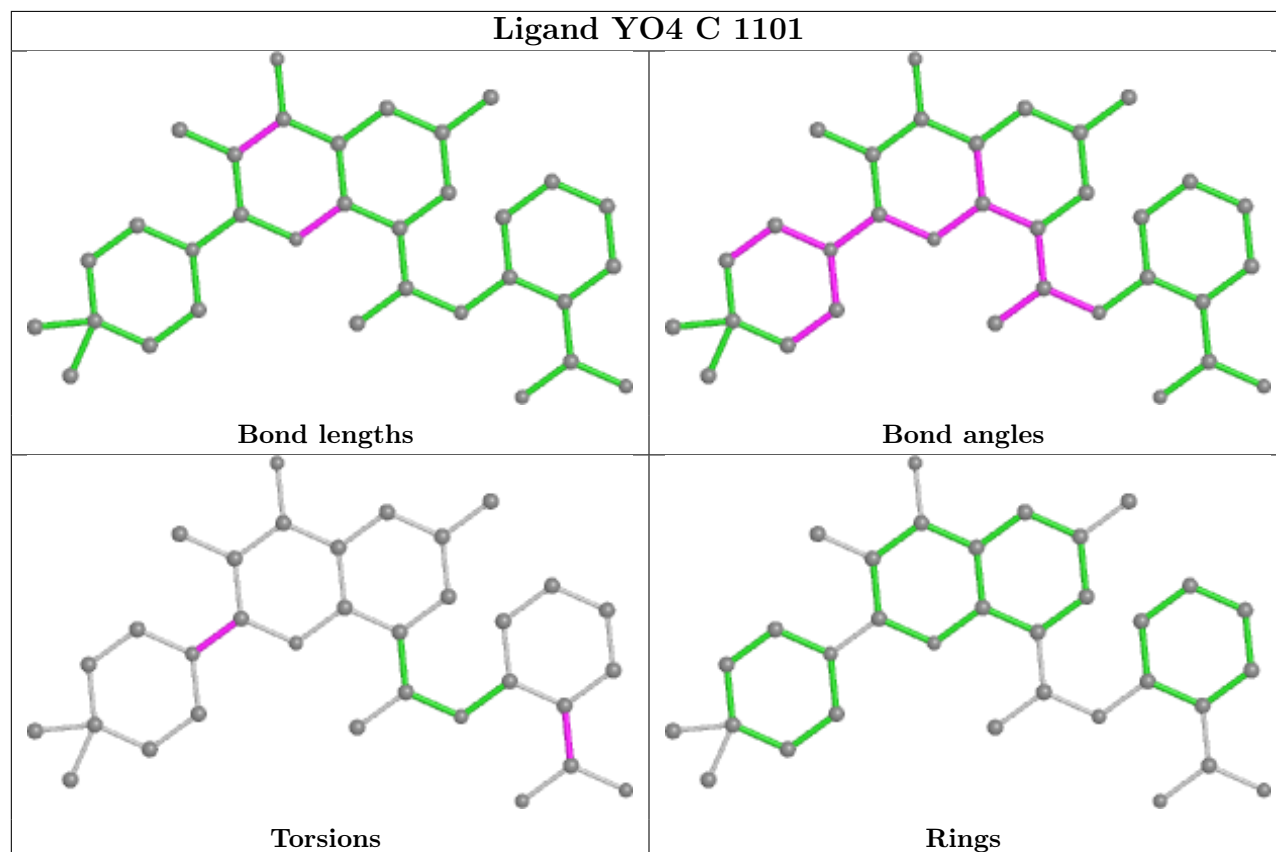

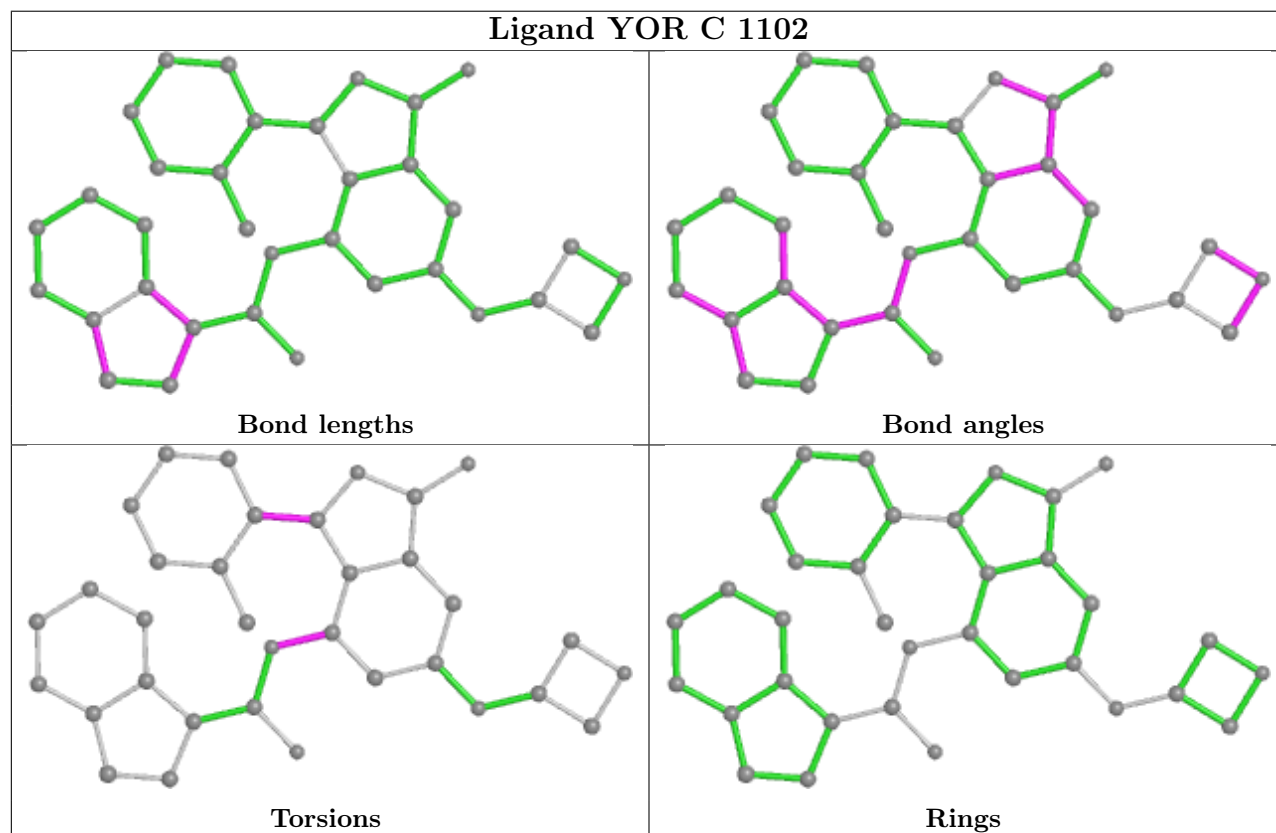
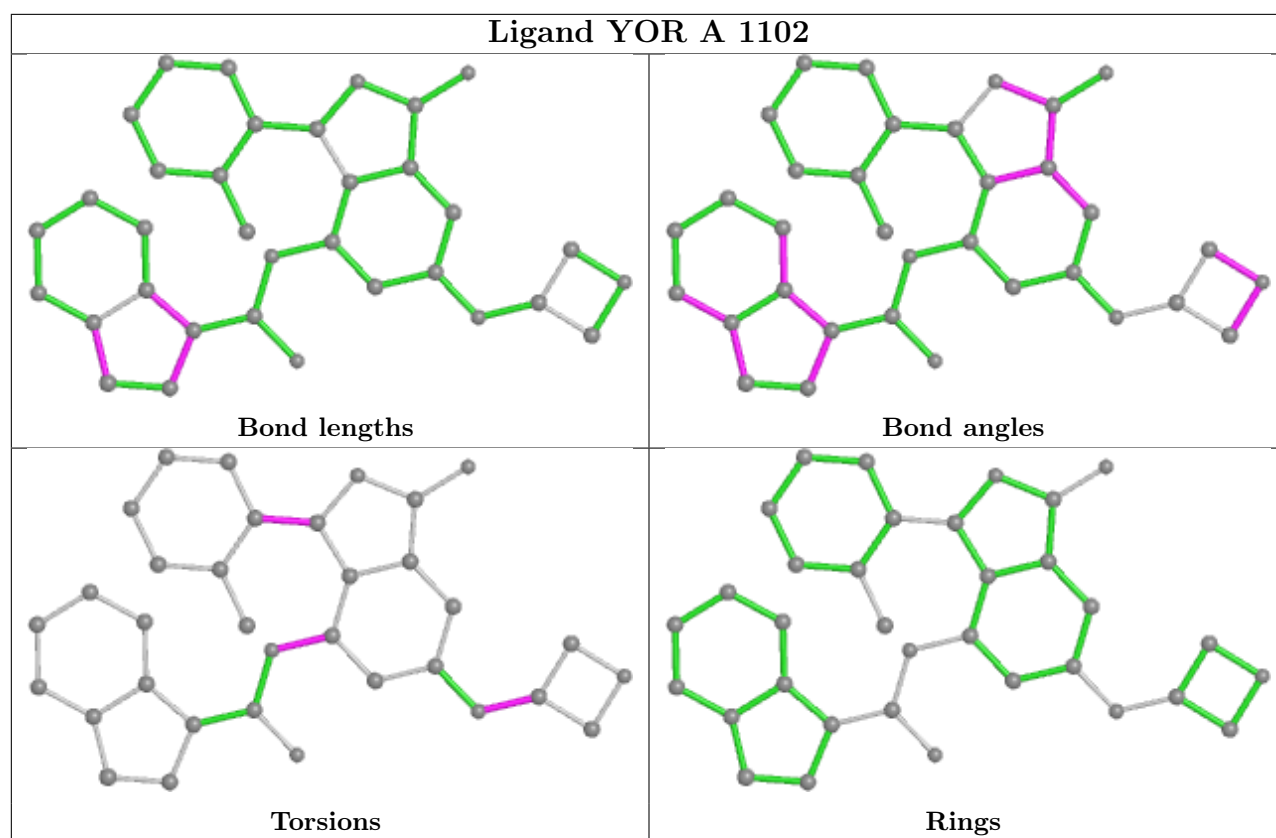

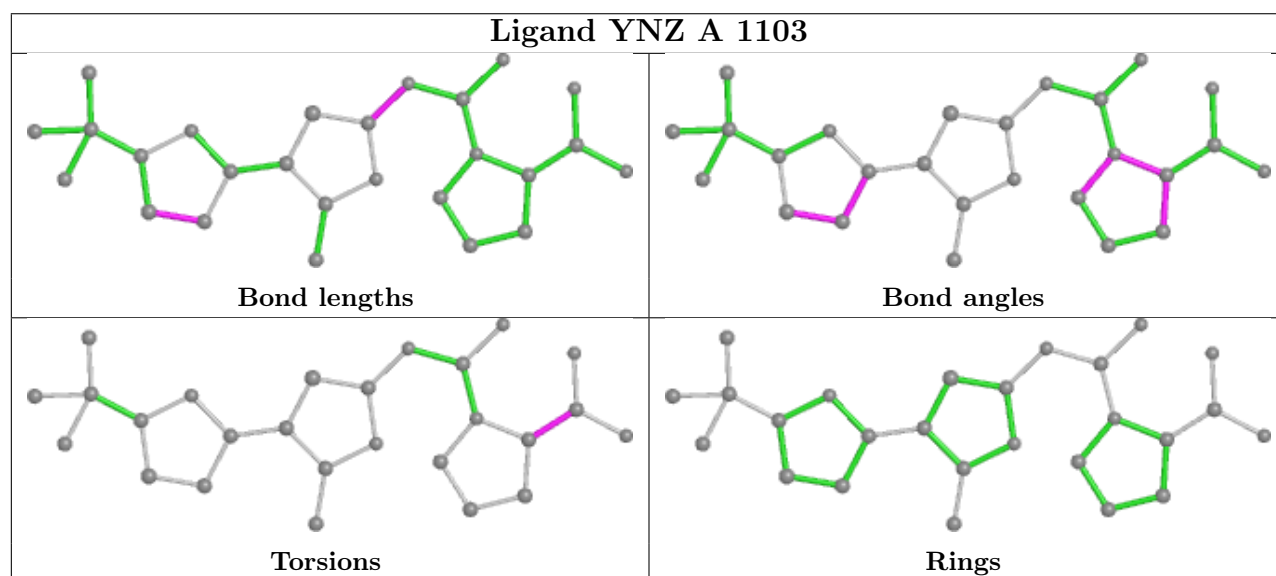
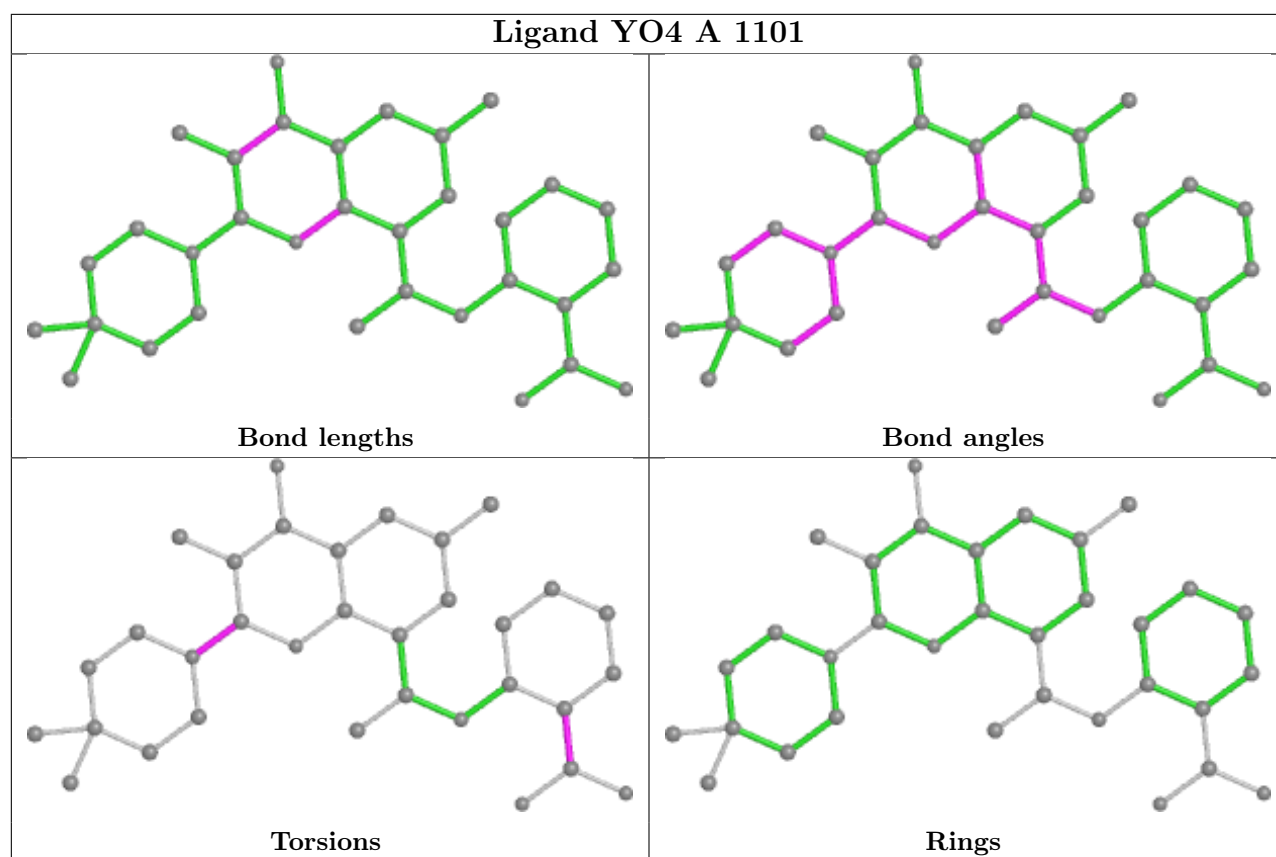

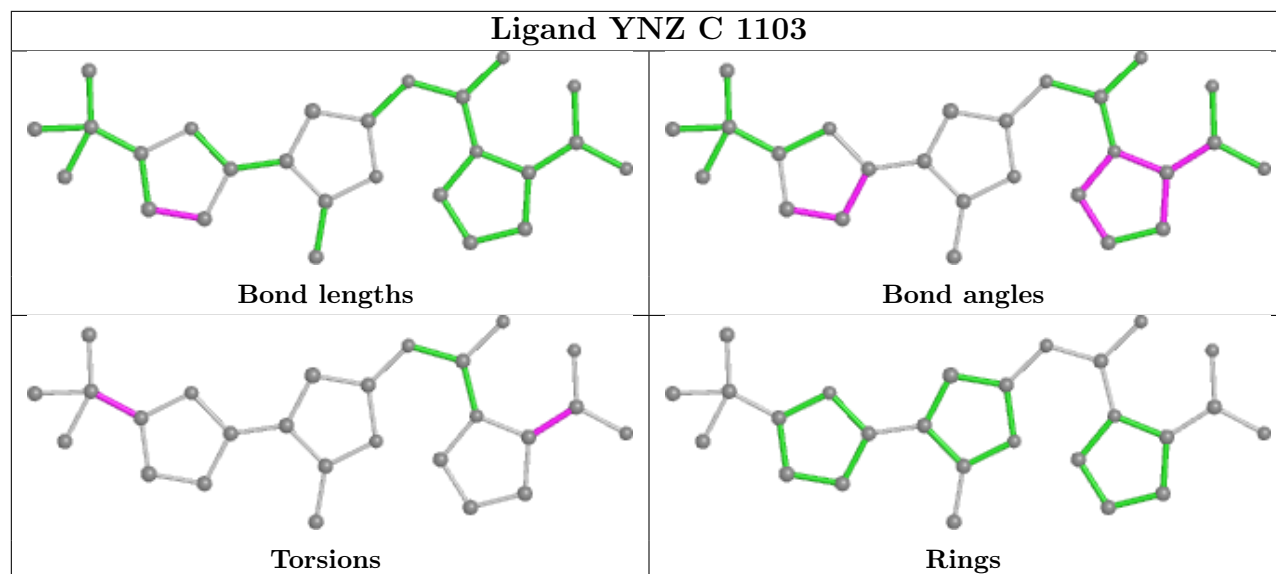

5.7 Other polymers [i](#)

There are no such residues in this entry.

5.8 Polymer linkage issues [i](#)

There are no chain breaks in this entry.

6 Fit of model and data [i](#)

6.1 Protein, DNA and RNA chains [i](#)

In the following table, the column labelled ‘#RSRZ > 2’ contains the number (and percentage) of RSRZ outliers, followed by percent RSRZ outliers for the chain as percentile scores relative to all X-ray entries and entries of similar resolution. The OWAB column contains the minimum, median, 95th percentile and maximum values of the occupancy-weighted average B-factor per residue. The column labelled ‘Q < 0.9’ lists the number of (and percentage) of residues with an average occupancy less than 0.9.

Mol	Chain	Analysed	<RSRZ>	#RSRZ>2	OWAB(Å ²)	Q<0.9
1	A	1017/1072 (94%)	0.24	38 (3%) 41 43	49, 86, 150, 258	0
1	C	1013/1072 (94%)	0.30	55 (5%) 25 28	50, 96, 181, 239	0
2	B	239/279 (85%)	2.12	94 (39%) 0 0	74, 147, 282, 329	0
2	D	239/279 (85%)	2.88	124 (51%) 0 0	100, 185, 310, 353	0
All	All	2508/2702 (92%)	0.69	311 (12%) 4 4	49, 100, 239, 353	0

The worst 5 of 311 RSRZ outliers are listed below:

Mol	Chain	Res	Type	RSRZ
2	B	372	LEU	14.3
2	D	399	SER	11.9
2	D	369	THR	11.5
2	D	335	TRP	10.7
2	D	351	ALA	10.0

6.2 Non-standard residues in protein, DNA, RNA chains [i](#)

There are no non-standard protein/DNA/RNA residues in this entry.

6.3 Carbohydrates [i](#)

There are no monosaccharides in this entry.

6.4 Ligands [i](#)

In the following table, the Atoms column lists the number of modelled atoms in the group and the number defined in the chemical component dictionary. The B-factors column lists the minimum, median, 95th percentile and maximum values of B factors of atoms in the group. The column labelled ‘Q < 0.9’ lists the number of atoms with occupancy less than 0.9.

Mol	Type	Chain	Res	Atoms	RSCC	RSR	B-factors(\AA^2)	Q<0.9
5	YNZ	A	1103	26/26	0.87	0.31	78,107,125,132	0
3	YO4	C	1101	33/33	0.94	0.30	75,96,112,125	0
3	YO4	A	1101	33/33	0.95	0.35	48,85,100,102	0
4	YOR	C	1102	34/34	0.96	0.24	63,91,113,117	0
4	YOR	A	1102	34/34	0.96	0.23	45,81,93,117	0
5	YNZ	C	1103	26/26	0.96	0.24	65,81,88,93	0

The following is a graphical depiction of the model fit to experimental electron density of all instances of the Ligand of Interest. In addition, ligands with molecular weight > 250 and outliers as shown on the geometry validation Tables will also be included. Each fit is shown from different orientation to approximate a three-dimensional view.

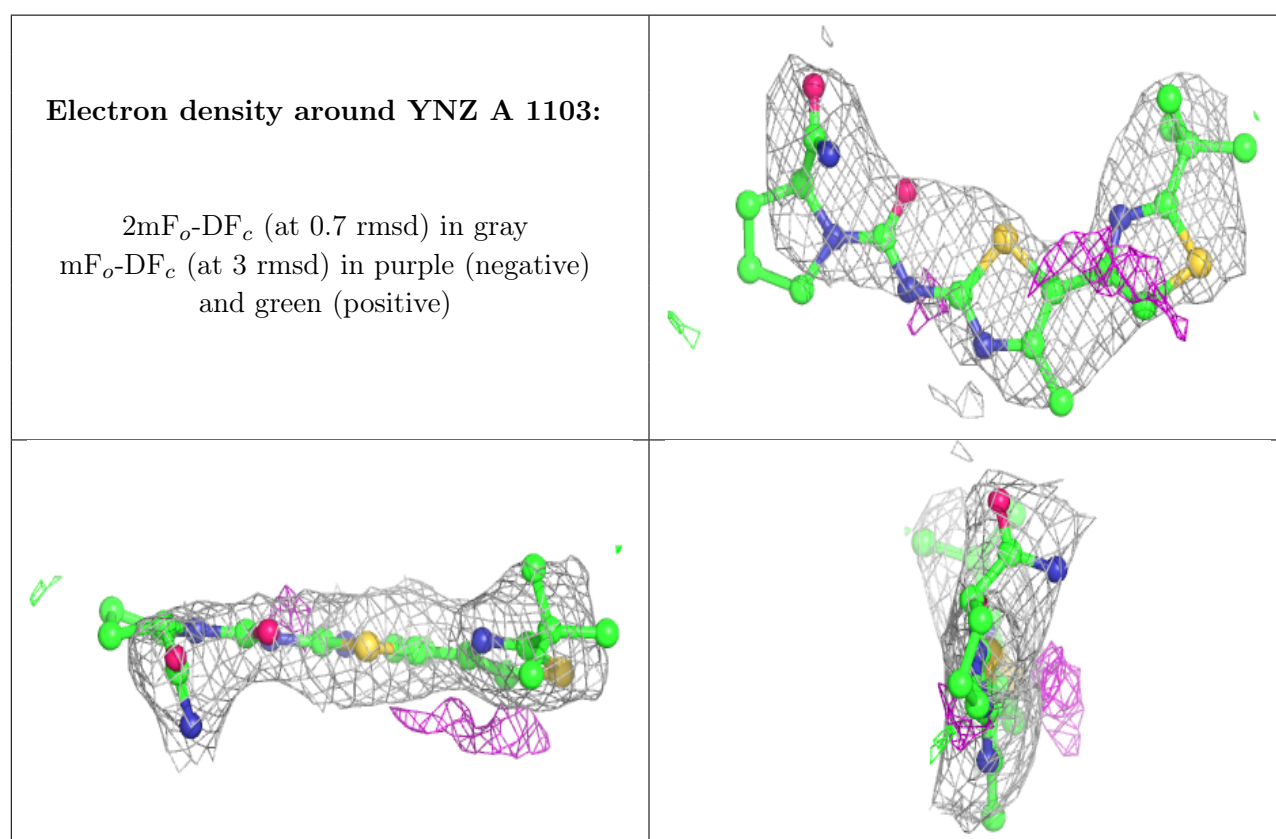

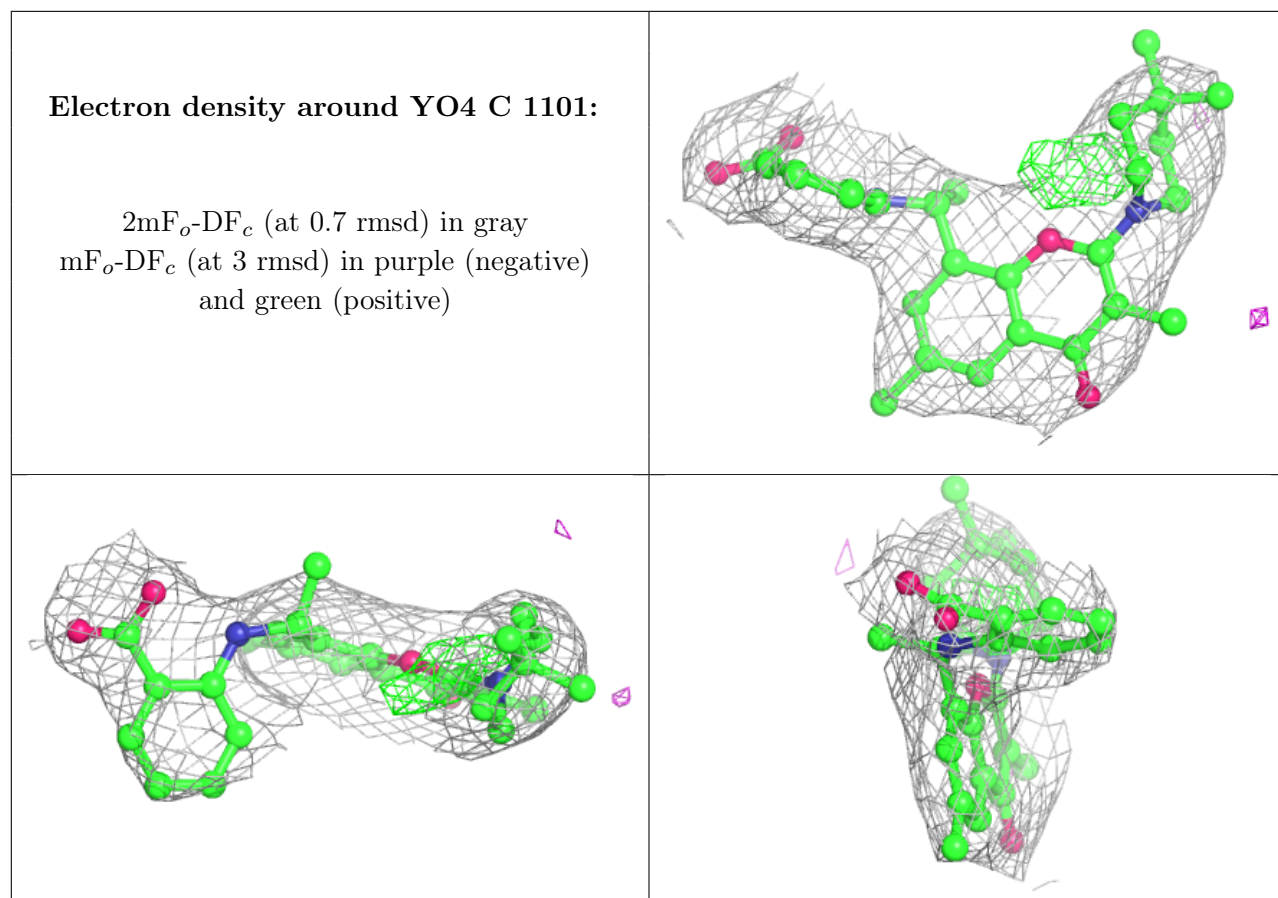

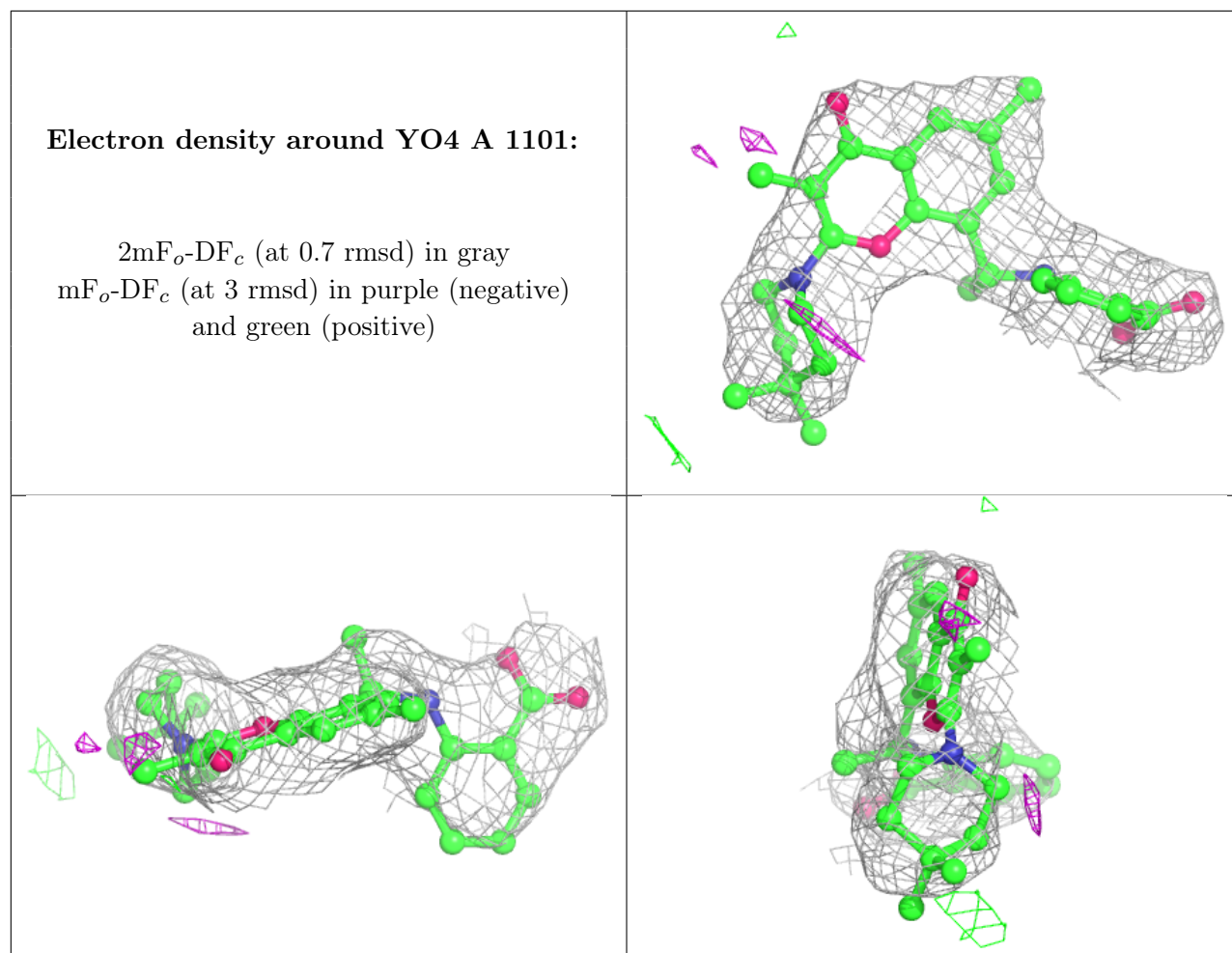

Electron density around YOR C 1102:

$2mF_o-DF_c$ (at 0.7 rmsd) in gray
 mF_o-DF_c (at 3 rmsd) in purple (negative)
and green (positive)

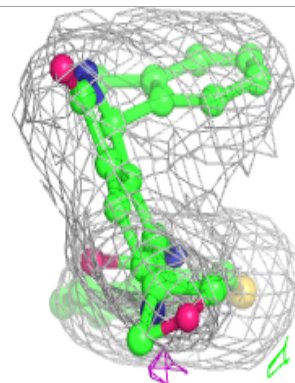
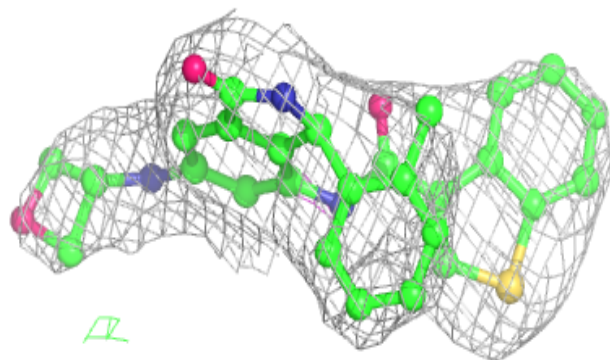
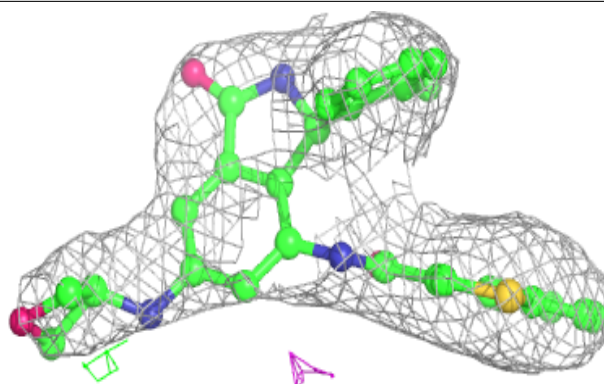
**Electron density around YOR A 1102:**

$2mF_o-DF_c$ (at 0.7 rmsd) in gray
 mF_o-DF_c (at 3 rmsd) in purple (negative)
and green (positive)

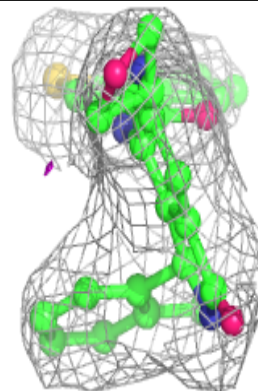
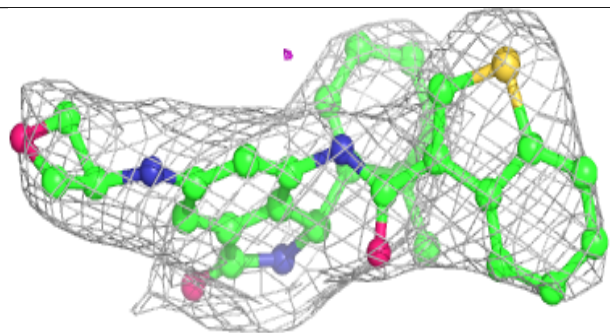
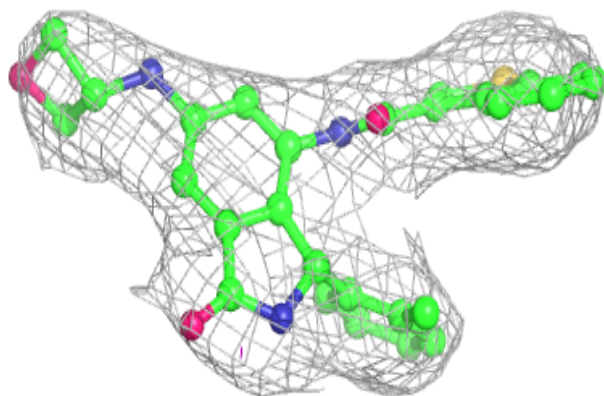

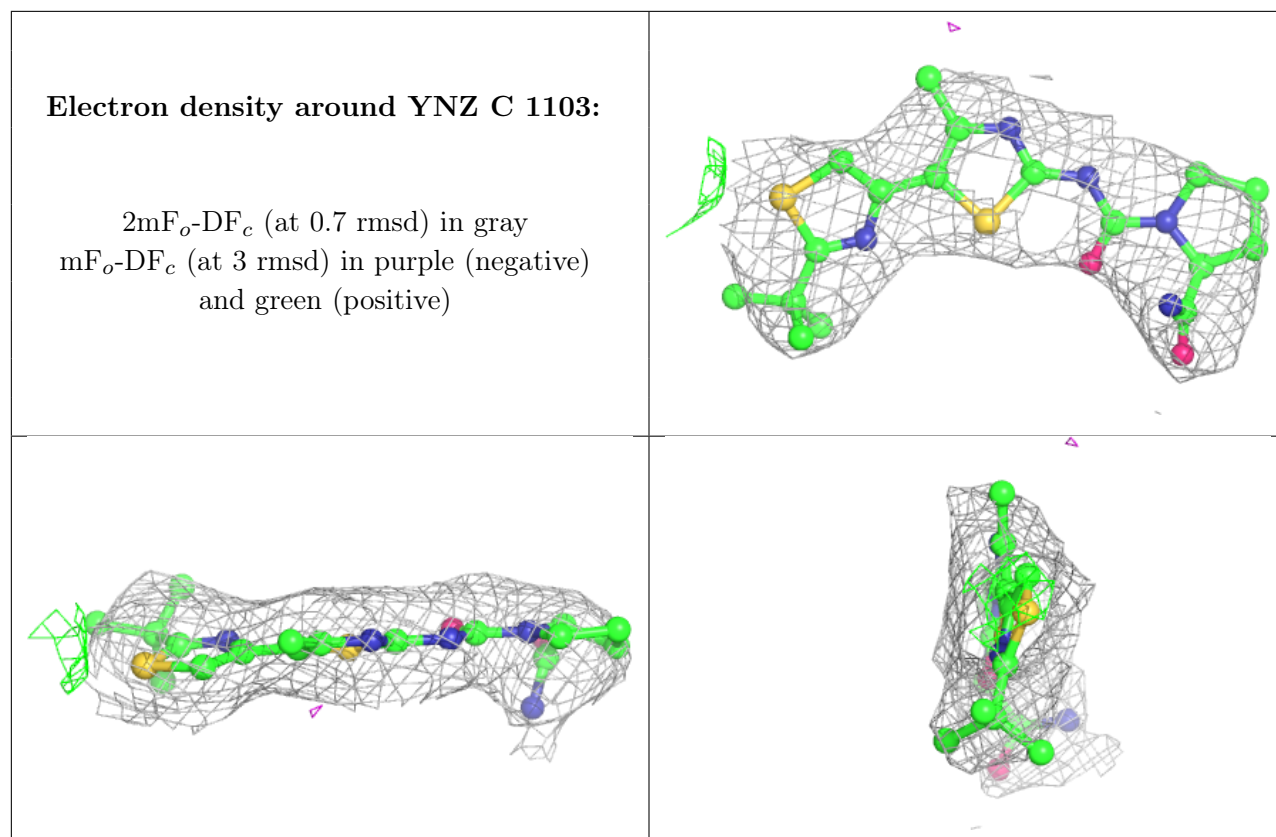

6.5 Other polymers [i](#)

There are no such residues in this entry.