



Full wwPDB X-ray Structure Validation Report

Dec 17, 2023 – 06:41 am GMT

PDB ID : 4UCX
Title : Structure of the T18G small subunit mutant of *D. fructosovorans* NiFe- hydrogenase
Authors : Abou-Hamdan, A.; Ceccaldi, P.; Lebrette, H.; Gutierrez-Sanz, O.; Richaud, P.; Cournac, L.; Guigliarelli, B.; deLacey, A.L.; Leger, C.; Volbeda, A.; Burlat, B.; Dementin, S.
Deposited on : 2014-12-05
Resolution : 1.95 Å (reported)

This is a Full wwPDB X-ray Structure Validation Report for a publicly released PDB entry.

We welcome your comments at validation@mail.wwpdb.org

A user guide is available at

<https://www.wwpdb.org/validation/2017/XrayValidationReportHelp>

with specific help available everywhere you see the  symbol.

The types of validation reports are described at

<http://www.wwpdb.org/validation/2017/FAQs#types>.

The following versions of software and data (see [references](#) ) were used in the production of this report:

MolProbity : 4.02b-467
Mogul : 1.8.4, CSD as541be (2020)
Xtriage (Phenix) : 1.13
EDS : 2.36
Percentile statistics : 20191225.v01 (using entries in the PDB archive December 25th 2019)
Refmac : 5.8.0158
CCP4 : 7.0.044 (Gargrove)
Ideal geometry (proteins) : Engh & Huber (2001)
Ideal geometry (DNA, RNA) : Parkinson et al. (1996)
Validation Pipeline (wwPDB-VP) : 2.36

1 Overall quality at a glance

The following experimental techniques were used to determine the structure:

X-RAY DIFFRACTION

The reported resolution of this entry is 1.95 Å.

Percentile scores (ranging between 0-100) for global validation metrics of the entry are shown in the following graphic. The table shows the number of entries on which the scores are based.

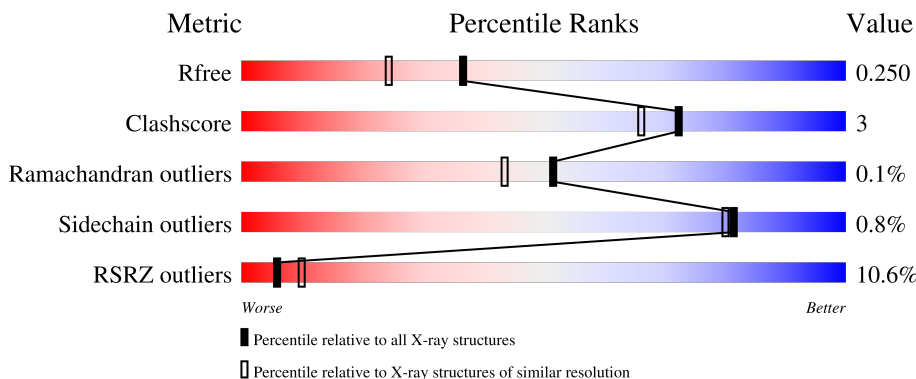

Metric	Whole archive (#Entries)	Similar resolution (#Entries, resolution range(Å))
R_{free}	130704	2580 (1.96-1.96)
Clashscore	141614	2705 (1.96-1.96)
Ramachandran outliers	138981	2678 (1.96-1.96)
Sidechain outliers	138945	2678 (1.96-1.96)
RSRZ outliers	127900	2539 (1.96-1.96)

The table below summarises the geometric issues observed across the polymeric chains and their fit to the electron density. The red, orange, yellow and green segments of the lower bar indicate the fraction of residues that contain outliers for ≥ 3 , 2, 1 and 0 types of geometric quality criteria respectively. A grey segment represents the fraction of residues that are not modelled. The numeric value for each fraction is indicated below the corresponding segment, with a dot representing fractions $\leq 5\%$. The upper red bar (where present) indicates the fraction of residues that have poor fit to the electron density. The numeric value is given above the bar.

Mol	Chain	Length	Quality of chain
1	A	264	 3% 92% 7%
1	B	264	 35% 88% 12%
1	C	264	 3% 91% 8%
2	Q	563	 3% 90% 6%

Continued on next page...

Continued from previous page...

Mol	Chain	Length	Quality of chain
2	R	563	
2	S	563	

The following table lists non-polymeric compounds, carbohydrate monomers and non-standard residues in protein, DNA, RNA chains that are outliers for geometric or electron-density-fit criteria:

Mol	Type	Chain	Res	Chirality	Geometry	Clashes	Electron density
5	GOL	A	1272	-	-	X	-

2 Entry composition i

There are 9 unique types of molecules in this entry. The entry contains 19169 atoms, of which 0 are hydrogens and 0 are deuteriums.

In the tables below, the ZeroOcc column contains the number of atoms modelled with zero occupancy, the AltConf column contains the number of residues with at least one atom in alternate conformation and the Trace column contains the number of residues modelled with at most 2 atoms.

- Molecule 1 is a protein called HYDROGENASE (NIFE) SMALL SUBUNIT HYDA.

Mol	Chain	Residues	Atoms					ZeroOcc	AltConf	Trace
			Total	C	N	O	S			
1	A	262	1968	1253	329	371	15	0	0	0
1	B	262	1968	1254	325	374	15	0	2	0
1	C	260	1954	1244	326	369	15	0	0	0

There are 3 discrepancies between the modelled and reference sequences:

Chain	Residue	Modelled	Actual	Comment	Reference
A	18	GLY	THR	engineered mutation	UNP P18187
B	18	GLY	THR	engineered mutation	UNP P18187
C	18	GLY	THR	engineered mutation	UNP P18187

- Molecule 2 is a protein called NICKEL-DEPENDENT HYDROGENASE LARGE SUB-UNIT.

Mol	Chain	Residues	Atoms					ZeroOcc	AltConf	Trace
			Total	C	N	O	S			
2	Q	544	4185	2670	722	771	22	0	7	0
2	R	545	4178	2664	724	768	22	0	3	0
2	S	544	4159	2650	718	769	22	0	2	0

There are 45 discrepancies between the modelled and reference sequences:

Chain	Residue	Modelled	Actual	Comment	Reference
Q	-13	ALA	-	expression tag	UNP P18188
Q	-12	SER	-	expression tag	UNP P18188
Q	-11	TRP	-	expression tag	UNP P18188
Q	-10	SER	-	expression tag	UNP P18188

Continued on next page...

Continued from previous page...

Chain	Residue	Modelled	Actual	Comment	Reference
Q	-9	HIS	-	expression tag	UNP P18188
Q	-8	PRO	-	expression tag	UNP P18188
Q	-7	GLN	-	expression tag	UNP P18188
Q	-6	PHE	-	expression tag	UNP P18188
Q	-5	GLU	-	expression tag	UNP P18188
Q	-4	LYS	-	expression tag	UNP P18188
Q	-3	GLY	-	expression tag	UNP P18188
Q	-2	ALA	-	expression tag	UNP P18188
Q	-1	SER	-	expression tag	UNP P18188
Q	0	GLY	-	expression tag	UNP P18188
Q	1	ALA	-	expression tag	UNP P18188
R	-13	ALA	-	expression tag	UNP P18188
R	-12	SER	-	expression tag	UNP P18188
R	-11	TRP	-	expression tag	UNP P18188
R	-10	SER	-	expression tag	UNP P18188
R	-9	HIS	-	expression tag	UNP P18188
R	-8	PRO	-	expression tag	UNP P18188
R	-7	GLN	-	expression tag	UNP P18188
R	-6	PHE	-	expression tag	UNP P18188
R	-5	GLU	-	expression tag	UNP P18188
R	-4	LYS	-	expression tag	UNP P18188
R	-3	GLY	-	expression tag	UNP P18188
R	-2	ALA	-	expression tag	UNP P18188
R	-1	SER	-	expression tag	UNP P18188
R	0	GLY	-	expression tag	UNP P18188
R	1	ALA	-	expression tag	UNP P18188
S	-13	ALA	-	expression tag	UNP P18188
S	-12	SER	-	expression tag	UNP P18188
S	-11	TRP	-	expression tag	UNP P18188
S	-10	SER	-	expression tag	UNP P18188
S	-9	HIS	-	expression tag	UNP P18188
S	-8	PRO	-	expression tag	UNP P18188
S	-7	GLN	-	expression tag	UNP P18188
S	-6	PHE	-	expression tag	UNP P18188
S	-5	GLU	-	expression tag	UNP P18188
S	-4	LYS	-	expression tag	UNP P18188
S	-3	GLY	-	expression tag	UNP P18188
S	-2	ALA	-	expression tag	UNP P18188
S	-1	SER	-	expression tag	UNP P18188
S	0	GLY	-	expression tag	UNP P18188
S	1	ALA	-	expression tag	UNP P18188

- Molecule 3 is IRON/SULFUR CLUSTER (three-letter code: SF4) (formula: Fe₄S₄).



Mol	Chain	Residues	Atoms	ZeroOcc	AltConf
3	A	1	Total Fe S 8 4 4	0	0
3	A	1	Total Fe S 8 4 4	0	0
3	B	1	Total Fe S 8 4 4	0	0
3	B	1	Total Fe S 8 4 4	0	0
3	C	1	Total Fe S 8 4 4	0	0
3	C	1	Total Fe S 8 4 4	0	0

- Molecule 4 is FE3-S4 CLUSTER (three-letter code: F3S) (formula: Fe₃S₄).

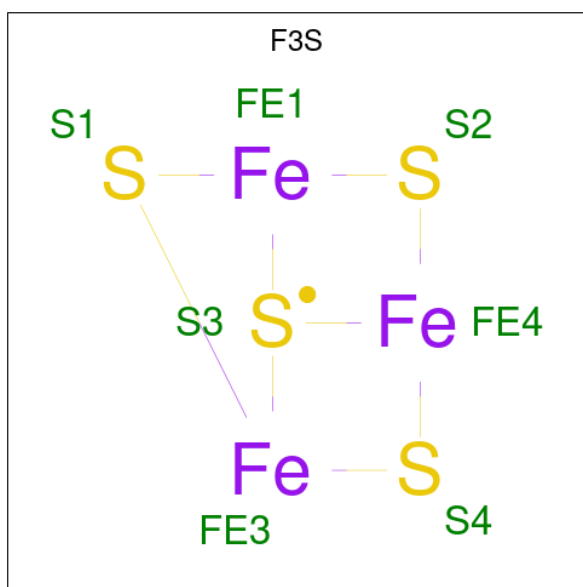

Mol	Chain	Residues	Atoms			ZeroOcc	AltConf
4	A	1	Total	Fe	S	0	0
			7	3	4		
4	B	1	Total	Fe	S	0	0
			7	3	4		
4	C	1	Total	Fe	S	0	0
			7	3	4		

- Molecule 5 is GLYCEROL (three-letter code: GOL) (formula: C₃H₈O₃).

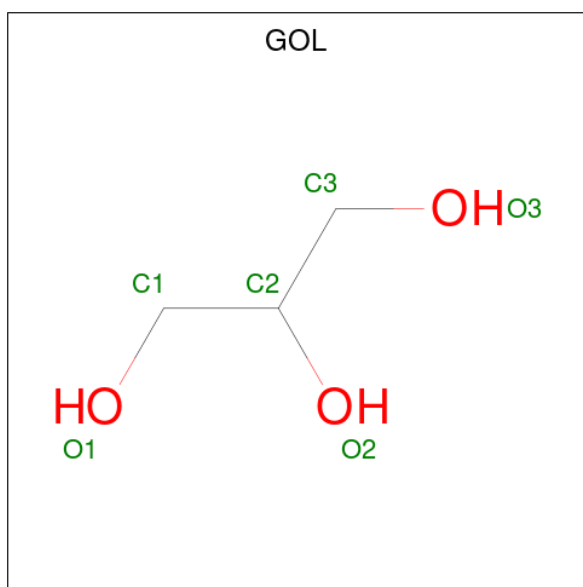

Mol	Chain	Residues	Atoms			ZeroOcc	AltConf
5	A	1	Total	C	O	0	0
			6	3	3		

Continued on next page...

Continued from previous page...

Mol	Chain	Residues	Atoms			ZeroOcc	AltConf
5	A	1	Total	C	O	0	0
			6	3	3		
5	A	1	Total	C	O	0	0
			6	3	3		
5	Q	1	Total	C	O	0	0
			6	3	3		
5	Q	1	Total	C	O	0	0
			6	3	3		
5	Q	1	Total	C	O	0	0
			6	3	3		
5	R	1	Total	C	O	0	0
			6	3	3		
5	S	1	Total	C	O	0	0
			6	3	3		
5	S	1	Total	C	O	0	0
			6	3	3		

- Molecule 6 is CARBONMONOXIDE-(DICYANO) IRON (three-letter code: FCO) (formula: C_3FeN_2O).

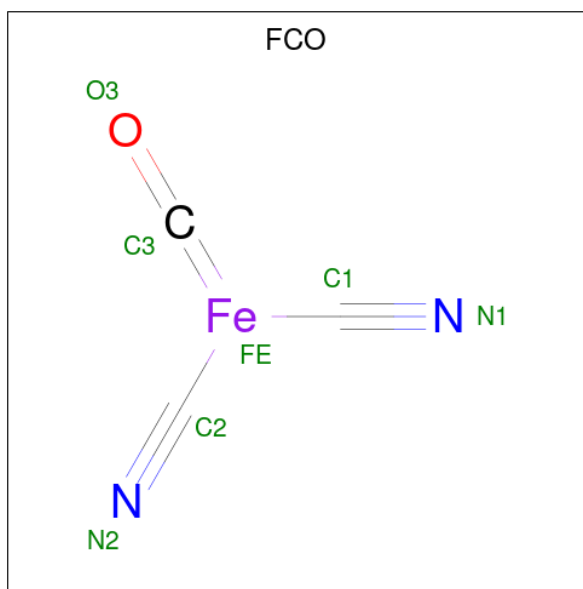

Mol	Chain	Residues	Atoms					ZeroOcc	AltConf
6	Q	1	Total	C	Fe	N	O	0	0
			7	3	1	2	1		
6	R	1	Total	C	Fe	N	O	0	0
			7	3	1	2	1		
6	S	1	Total	C	Fe	N	O	0	0
			7	3	1	2	1		

- Molecule 7 is NICKEL (II) ION (three-letter code: NI) (formula: Ni).

Mol	Chain	Residues	Atoms	ZeroOcc	AltConf
7	Q	1	Total Ni 1 1	0	0
7	R	1	Total Ni 1 1	0	0
7	S	1	Total Ni 1 1	0	0

- Molecule 8 is MAGNESIUM ION (three-letter code: MG) (formula: Mg).

Mol	Chain	Residues	Atoms	ZeroOcc	AltConf
8	Q	2	Total Mg 2 2	0	0
8	R	1	Total Mg 1 1	0	0
8	S	1	Total Mg 1 1	0	0

- Molecule 9 is water.

Mol	Chain	Residues	Atoms	ZeroOcc	AltConf
9	A	94	Total O 94 94	0	0
9	B	75	Total O 75 75	0	0
9	C	84	Total O 84 84	0	0
9	Q	129	Total O 129 129	0	0
9	R	112	Total O 112 112	0	0
9	S	112	Total O 112 112	0	0

3 Residue-property plots [i](#)

These plots are drawn for all protein, RNA, DNA and oligosaccharide chains in the entry. The first graphic for a chain summarises the proportions of the various outlier classes displayed in the second graphic. The second graphic shows the sequence view annotated by issues in geometry and electron density. Residues are color-coded according to the number of geometric quality criteria for which they contain at least one outlier: green = 0, yellow = 1, orange = 2 and red = 3 or more. A red dot above a residue indicates a poor fit to the electron density ($RSRZ > 2$). Stretches of 2 or more consecutive residues without any outlier are shown as a green connector. Residues present in the sample, but not in the model, are shown in grey.

- Molecule 1: HYDROGENASE (NIFE) SMALL SUBUNIT HYDA

Chain A: 



- Molecule 1: HYDROGENASE (NIFE) SMALL SUBUNIT HYDA

Chain B: 

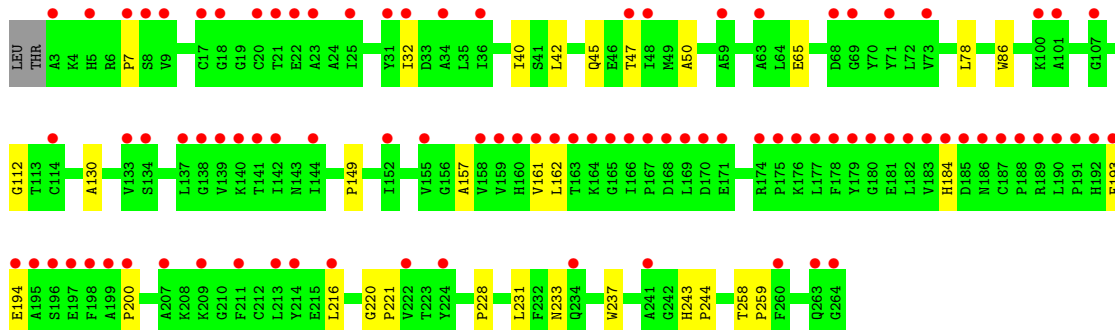

- Molecule 1: HYDROGENASE (NIFE) SMALL SUBUNIT HYDA

Chain C: 

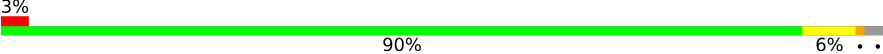

- Molecule 2: NICKEL-DEPENDENT HYDROGENASE LARGE SUBUNIT

Chain Q: 

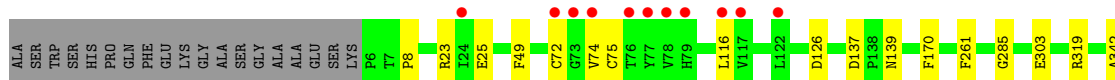



• Molecule 2: NICKEL-DEPENDENT HYDROGENASE LARGE SUBUNIT

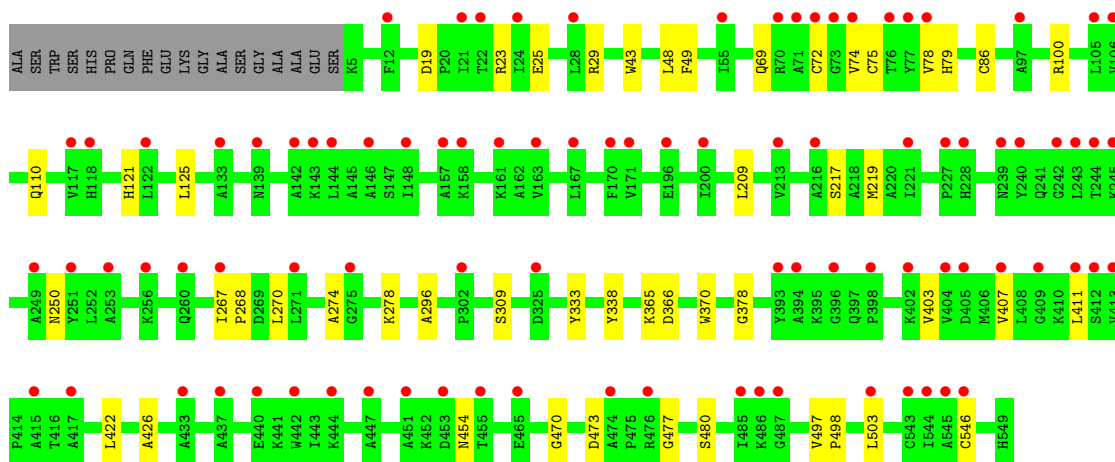
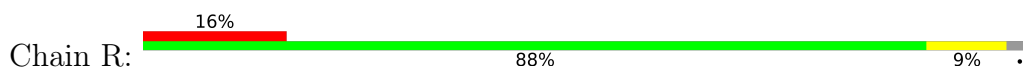

• Molecule 2: NICKEL-DEPENDENT HYDROGENASE LARGE SUBUNIT

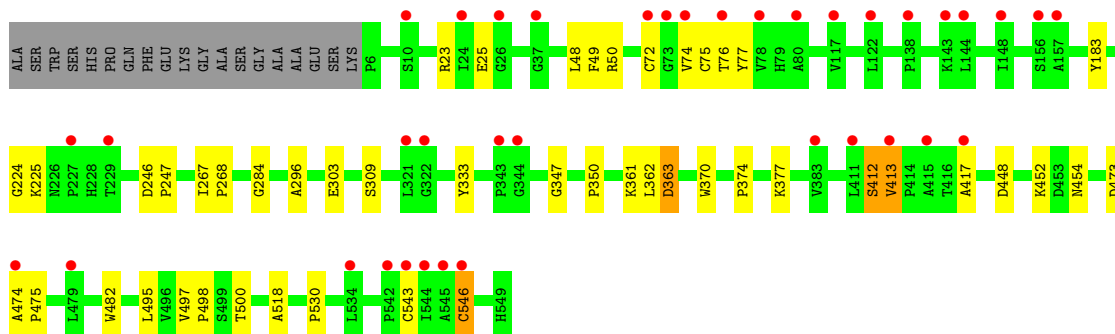
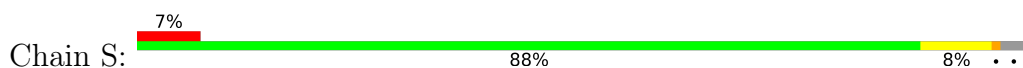

4 Data and refinement statistics i

Property	Value	Source
Space group	P 1 21 1	Depositor
Cell constants a, b, c, α , β , γ	62.60Å 99.27Å 182.08Å 90.00° 92.32° 90.00°	Depositor
Resolution (Å)	25.00 – 1.95 46.44 – 1.95	Depositor EDS
% Data completeness (in resolution range)	99.2 (25.00-1.95) 99.2 (46.44-1.95)	Depositor EDS
R_{merge}	0.04	Depositor
R_{sym}	(Not available)	Depositor
$\langle I/\sigma(I) \rangle$ ¹	3.45 (at 1.95Å)	Xtrriage
Refinement program	REFMAC 5.5.0109	Depositor
R, R_{free}	0.197 , 0.231 0.219 , 0.250	Depositor DCC
R_{free} test set	8070 reflections (5.02%)	wwPDB-VP
Wilson B-factor (Å ²)	25.5	Xtrriage
Anisotropy	0.870	Xtrriage
Bulk solvent k_{sol} (e/Å ³), B_{sol} (Å ²)	0.35 , 50.9	EDS
L-test for twinning ²	$\langle L \rangle = 0.46$, $\langle L^2 \rangle = 0.28$	Xtrriage
Estimated twinning fraction	0.036 for h,-k,-l	Xtrriage
F_o, F_c correlation	0.95	EDS
Total number of atoms	19169	wwPDB-VP
Average B, all atoms (Å ²)	40.0	wwPDB-VP

Xtrriage's analysis on translational NCS is as follows: *The largest off-origin peak in the Patterson function is 3.78% of the height of the origin peak. No significant pseudotranslation is detected.*

¹Intensities estimated from amplitudes.

²Theoretical values of $\langle |L| \rangle$, $\langle L^2 \rangle$ for acentric reflections are 0.5, 0.333 respectively for untwinned datasets, and 0.375, 0.2 for perfectly twinned datasets.

5 Model quality [i](#)

5.1 Standard geometry [i](#)

Bond lengths and bond angles in the following residue types are not validated in this section: SF4, FCO, CSX, F3S, GOL, NI, MG

The Z score for a bond length (or angle) is the number of standard deviations the observed value is removed from the expected value. A bond length (or angle) with $|Z| > 5$ is considered an outlier worth inspection. RMSZ is the root-mean-square of all Z scores of the bond lengths (or angles).

Mol	Chain	Bond lengths		Bond angles	
		RMSZ	# Z >5	RMSZ	# Z >5
1	A	0.71	1/2022 (0.0%)	0.71	0/2752
1	B	0.51	0/2031	0.57	0/2767
1	C	0.61	0/2008	0.63	0/2735
2	Q	0.65	0/4313	0.69	0/5854
2	R	0.58	1/4287 (0.0%)	0.63	0/5819
2	S	0.55	1/4264 (0.0%)	0.64	0/5791
All	All	0.60	3/18925 (0.0%)	0.65	0/25718

All (3) bond length outliers are listed below:

Mol	Chain	Res	Type	Atoms	Z	Observed(Å)	Ideal(Å)
2	R	86	CYS	CB-SG	-6.06	1.72	1.82
2	S	303	GLU	CB-CG	-5.73	1.41	1.52
1	A	22	GLU	CD-OE2	-5.01	1.20	1.25

There are no bond angle outliers.

There are no chirality outliers.

There are no planarity outliers.

5.2 Too-close contacts [i](#)

In the following table, the Non-H and H(model) columns list the number of non-hydrogen atoms and hydrogen atoms in the chain respectively. The H(added) column lists the number of hydrogen atoms added and optimized by MolProbity. The Clashes column lists the number of clashes within the asymmetric unit, whereas Symm-Clashes lists symmetry-related clashes.

Mol	Chain	Non-H	H(model)	H(added)	Clashes	Symm-Clashes
1	A	1968	0	1900	14	0
1	B	1968	0	1881	21	0

Continued on next page...

Continued from previous page...

Mol	Chain	Non-H	H(model)	H(added)	Clashes	Symm-Clashes
1	C	1954	0	1884	12	0
2	Q	4185	0	4161	24	0
2	R	4178	0	4152	30	0
2	S	4159	0	4101	33	0
3	A	16	0	0	0	0
3	B	16	0	0	0	0
3	C	16	0	0	0	0
4	A	7	0	0	0	0
4	B	7	0	0	0	0
4	C	7	0	0	1	0
5	A	18	0	24	6	0
5	Q	18	0	24	2	0
5	R	6	0	8	0	0
5	S	12	0	16	0	0
6	Q	7	0	0	0	0
6	R	7	0	0	0	0
6	S	7	0	0	1	0
7	Q	1	0	0	0	0
7	R	1	0	0	0	0
7	S	1	0	0	0	0
8	Q	2	0	0	0	0
8	R	1	0	0	0	0
8	S	1	0	0	0	0
9	A	94	0	0	1	0
9	B	75	0	0	0	0
9	C	84	0	0	0	0
9	Q	129	0	0	1	0
9	R	112	0	0	1	0
9	S	112	0	0	2	0
All	All	19169	0	18151	125	0

The all-atom clashscore is defined as the number of clashes found per 1000 atoms (including hydrogen atoms). The all-atom clashscore for this structure is 3.

All (125) close contacts within the same asymmetric unit are listed below, sorted by their clash magnitude.

Atom-1	Atom-2	Interatomic distance (Å)	Clash overlap (Å)
1:A:140:LYS:NZ	5:A:1272:GOL:H11	1.66	1.11
2:S:497:VAL:CG1	2:S:498:PRO:HD2	2.02	0.89
1:A:140:LYS:HZ1	5:A:1272:GOL:H11	1.38	0.88
1:A:140:LYS:HZ3	5:A:1272:GOL:H11	1.37	0.86

Continued on next page...

Continued from previous page...

Atom-1	Atom-2	Interatomic distance (Å)	Clash overlap (Å)
2:S:497:VAL:HG12	2:S:498:PRO:HD2	1.64	0.78
2:S:412:SER:O	2:S:413:VAL:HB	1.88	0.74
2:R:497:VAL:HG12	2:R:498:PRO:HD2	1.73	0.71
2:S:497:VAL:HG13	2:S:498:PRO:HD2	1.73	0.70
2:R:497:VAL:CG1	2:R:498:PRO:HD2	2.23	0.69
2:R:121:HIS:NE2	2:R:209:LEU:HG	2.12	0.65
2:S:48:LEU:HD21	2:S:50:ARG:HD2	1.80	0.64
1:A:171:GLU:H	1:A:171:GLU:CD	2.01	0.63
1:B:40:ILE:HG22	1:B:162:LEU:HD11	1.82	0.60
2:Q:303:GLU:CG	9:Q:2076:HOH:O	2.51	0.58
1:A:140:LYS:NZ	5:A:1272:GOL:C1	2.57	0.57
2:Q:25:GLU:HB2	2:Q:74:VAL:HG21	1.87	0.57
2:Q:285:GLY:HA3	5:Q:1563:GOL:H2	1.87	0.55
2:R:49:PHE:HB2	2:R:370:TRP:CD2	2.42	0.55
1:C:14:ASN:HD22	1:C:94:MET:HG2	1.72	0.55
1:C:47:THR:O	2:S:23:ARG:HA	2.07	0.55
2:S:374:PRO:CG	2:S:500:THR:HG22	2.37	0.55
2:S:448:ASP:O	2:S:452:LYS:HD3	2.08	0.54
1:B:157:ALA:O	1:B:161:VAL:HG23	2.08	0.54
2:Q:116[B]:LEU:HD11	2:Q:261:PHE:HE2	1.72	0.54
1:B:184:HIS:ND1	1:B:221:PRO:HG3	2.22	0.54
1:B:47:THR:O	2:R:23:ARG:HA	2.07	0.54
1:B:233:ASN:HB3	2:R:217:SER:HA	1.89	0.53
2:R:43:TRP:CZ2	2:R:365:LYS:HE2	2.44	0.53
2:R:477:GLY:O	2:R:498:PRO:HG3	2.09	0.53
1:B:184:HIS:HB2	1:B:221:PRO:HA	1.91	0.53
2:Q:116[B]:LEU:HD11	2:Q:261:PHE:CE2	2.44	0.53
2:S:267:ILE:HB	2:S:268:PRO:HD3	1.91	0.53
2:R:296:ALA:HA	2:R:309:SER:HA	1.91	0.53
1:C:42:LEU:HD21	1:C:45:GLN:HG3	1.91	0.52
2:R:267:ILE:HB	2:R:268:PRO:HD3	1.92	0.51
1:B:50:ALA:HB2	2:R:125:LEU:HD13	1.93	0.51
1:A:99:LYS:HE2	9:A:2045:HOH:O	2.11	0.50
1:B:228:PRO:HB3	1:B:237:TRP:CZ2	2.47	0.50
5:A:1273:GOL:H11	2:Q:170:PHE:HA	1.94	0.50
2:R:110:GLN:HB2	2:R:219:MET:HE3	1.94	0.50
2:R:274:ALA:HA	2:R:422[A]:LEU:HD11	1.94	0.49
2:Q:403:VAL:O	2:Q:406:MET:HB3	2.12	0.49
1:B:112:GLY:HA2	1:B:149:PRO:HD3	1.95	0.48
2:R:19:ASP:HB2	2:R:29:ARG:HG3	1.94	0.48
2:S:497:VAL:HG12	2:S:498:PRO:CD	2.37	0.48

Continued on next page...

Continued from previous page...

Atom-1	Atom-2	Interatomic distance (Å)	Clash overlap (Å)
1:A:237:TRP:CH2	1:A:239:VAL:HB	2.49	0.48
1:C:14:ASN:ND2	1:C:94:MET:HB3	2.29	0.48
4:C:1266:F3S:S2	2:S:225:LYS:HE2	2.54	0.48
2:R:110:GLN:HB2	2:R:219:MET:CE	2.44	0.48
2:S:75:CSX:N	2:S:75:CSX:OD	2.47	0.48
1:C:40:ILE:HG22	1:C:162:LEU:HD11	1.96	0.48
2:S:25:GLU:HB2	2:S:74:VAL:HG21	1.95	0.47
2:Q:137:ASP:OD1	2:Q:139:ASN:HB2	2.13	0.47
2:R:278:LYS:NZ	2:R:411:LEU:O	2.46	0.47
2:S:543:CYS:SG	2:S:546:CYS:HB2	2.54	0.47
2:S:72:CYS:HB3	2:S:75:CSX:OD	2.14	0.47
1:A:98:THR:HG22	1:A:137:LEU:HD11	1.96	0.47
2:S:49:PHE:HB2	2:S:370:TRP:CD2	2.50	0.47
2:S:495:LEU:HD12	2:S:495:LEU:N	2.29	0.47
1:B:78:LEU:O	1:B:130:ALA:HA	2.15	0.47
1:C:223:THR:OG1	1:C:247:GLY:HA2	2.15	0.47
1:B:193:PHE:HD2	1:B:194:GLU:HG3	1.80	0.46
1:A:47:THR:O	2:Q:23:ARG:HA	2.15	0.46
2:S:284:GLY:HA2	2:S:518:ALA:O	2.16	0.46
2:S:296:ALA:HA	2:S:309:SER:HA	1.96	0.46
2:Q:497:VAL:CG1	2:Q:498:PRO:HD2	2.45	0.46
2:S:361:LYS:HG3	2:S:362:LEU:O	2.16	0.46
2:S:246:ASP:HB2	2:S:247:PRO:HD3	1.98	0.46
2:S:377:LYS:NZ	9:S:2074:HOH:O	2.23	0.46
2:R:333:TYR:OH	2:R:378:GLY:HA2	2.16	0.45
2:Q:497:VAL:HG13	2:Q:498:PRO:HD2	1.98	0.45
2:Q:49:PHE:HB2	2:Q:370:TRP:CD2	2.52	0.45
1:B:184:HIS:CE1	1:B:221:PRO:HG3	2.52	0.45
1:B:32:ILE:HG21	2:R:209:LEU:HD22	1.97	0.45
2:S:350:PRO:HB2	2:S:482:TRP:CG	2.52	0.45
2:R:338:TYR:HA	2:R:366:ASP:O	2.16	0.45
1:B:7:PRO:HG2	1:B:162:LEU:HD13	1.98	0.44
2:S:413:VAL:HG22	2:S:417:ALA:CB	2.47	0.44
1:B:220:GLY:N	1:B:221:PRO:CD	2.80	0.44
1:B:243:HIS:CG	1:B:244:PRO:HD2	2.53	0.44
1:B:42:LEU:HD21	1:B:45:GLN:HG3	2.00	0.44
1:C:112:GLY:HA2	1:C:149:PRO:HD3	2.00	0.44
1:C:236:ASN:HB3	2:S:224:GLY:O	2.17	0.44
1:B:200:PRO:O	1:B:216:LEU:HD21	2.18	0.43
1:B:32:ILE:CG2	2:R:209:LEU:HD22	2.49	0.43
2:R:72:CYS:HB3	2:R:75:CSX:OD	2.17	0.43

Continued on next page...

Continued from previous page...

Atom-1	Atom-2	Interatomic distance (Å)	Clash overlap (Å)
2:R:75:CSX:O	2:R:78:VAL:HG22	2.18	0.43
2:R:470:GLY:O	2:R:480:SER:HA	2.19	0.43
1:A:137:LEU:HB2	1:A:139:VAL:HG22	2.00	0.43
1:A:24:ALA:O	1:A:27:THR:HG22	2.19	0.42
2:R:69:GLN:HA	2:R:79:HIS:HB2	2.02	0.42
1:C:24:ALA:O	1:C:27:THR:HG22	2.20	0.42
2:Q:319:ARG:HH12	5:Q:1563:GOL:H32	1.84	0.42
2:Q:544:ILE:N	2:Q:544:ILE:HD13	2.34	0.42
2:Q:8:PRO:HB2	2:Q:525:ALA:HB2	2.01	0.42
2:S:50:ARG:HD3	9:S:2015:HOH:O	2.19	0.42
2:Q:126:ASP:HB3	2:Q:535:ARG:HG2	2.01	0.42
1:C:145:PRO:HD2	1:C:179:TYR:CZ	2.55	0.42
2:S:183:TYR:CZ	2:S:530:PRO:HD2	2.55	0.42
1:B:258:THR:HA	1:B:259:PRO:C	2.39	0.41
2:Q:350:PRO:HB2	2:Q:482:TRP:CG	2.55	0.41
1:A:170:ASP:O	5:A:1272:GOL:H32	2.20	0.41
1:A:190:LEU:HB3	1:A:191:PRO:HD3	2.02	0.41
2:Q:401:LYS:HE3	2:Q:401:LYS:HB2	1.39	0.41
2:Q:397:GLN:HA	2:Q:398:PRO:HD3	1.86	0.41
2:Q:454:ASN:H	2:Q:454:ASN:HD22	1.68	0.41
2:R:497:VAL:HG11	2:R:546:CYS:HB3	2.03	0.41
2:S:497:VAL:CG1	2:S:498:PRO:CD	2.87	0.41
2:Q:342:ALA:HB1	2:Q:343:PRO:HD2	2.01	0.41
2:Q:503:LEU:HD23	2:Q:515:VAL:HG11	2.02	0.41
2:R:100:ARG:HD3	9:R:2038:HOH:O	2.20	0.41
2:S:76:THR:O	2:S:77:TYR:HB3	2.21	0.41
2:S:474:ALA:HB1	2:S:475:PRO:HD2	2.01	0.41
1:C:114:CYS:HA	1:C:119:GLY:HA3	2.03	0.41
2:Q:497:VAL:HG11	2:Q:546:CYS:HB3	2.02	0.41
2:R:25:GLU:HB2	2:R:74:VAL:HG21	2.03	0.41
2:S:75:CSX:CB	6:S:1550:FCO:C2	2.98	0.41
1:B:86:TRP:O	2:R:48:LEU:HA	2.22	0.40
1:C:98:THR:HG22	1:C:137:LEU:HD11	2.03	0.40
2:Q:72:CYS:HB3	2:Q:75:CSX:OD	2.21	0.40
2:R:270:LEU:HD21	2:R:426:ALA:HA	2.02	0.40
2:S:333:TYR:CD2	2:S:347:GLY:HA2	2.55	0.40
2:S:362:LEU:O	2:S:363[A]:ASP:HB3	2.22	0.40
1:A:118:GLY:HA3	1:A:122:LYS:HD2	2.04	0.40
2:R:403:VAL:O	2:R:407:VAL:HG23	2.22	0.40

There are no symmetry-related clashes.

5.3 Torsion angles [i](#)

5.3.1 Protein backbone [i](#)

In the following table, the Percentiles column shows the percent Ramachandran outliers of the chain as a percentile score with respect to all X-ray entries followed by that with respect to entries of similar resolution.

The Analysed column shows the number of residues for which the backbone conformation was analysed, and the total number of residues.

Mol	Chain	Analysed	Favoured	Allowed	Outliers	Percentiles	
1	A	260/264 (98%)	252 (97%)	8 (3%)	0	100	100
1	B	262/264 (99%)	250 (95%)	11 (4%)	1 (0%)	34	22
1	C	258/264 (98%)	248 (96%)	10 (4%)	0	100	100
2	Q	548/563 (97%)	532 (97%)	16 (3%)	0	100	100
2	R	545/563 (97%)	531 (97%)	14 (3%)	0	100	100
2	S	543/563 (96%)	522 (96%)	19 (4%)	2 (0%)	34	22
All	All	2416/2481 (97%)	2335 (97%)	78 (3%)	3 (0%)	51	43

All (3) Ramachandran outliers are listed below:

Mol	Chain	Res	Type
2	S	412	SER
2	S	413	VAL
1	B	231	LEU

5.3.2 Protein sidechains [i](#)

In the following table, the Percentiles column shows the percent sidechain outliers of the chain as a percentile score with respect to all X-ray entries followed by that with respect to entries of similar resolution.

The Analysed column shows the number of residues for which the sidechain conformation was analysed, and the total number of residues.

Mol	Chain	Analysed	Rotameric	Outliers	Percentiles	
1	A	206/209 (99%)	205 (100%)	1 (0%)	88	88
1	B	204/209 (98%)	203 (100%)	1 (0%)	88	88
1	C	205/209 (98%)	204 (100%)	1 (0%)	88	88
2	Q	438/447 (98%)	434 (99%)	4 (1%)	78	77

Continued on next page...

Continued from previous page...

Mol	Chain	Analysed	Rotameric	Outliers	Percentiles	
2	R	435/447 (97%)	431 (99%)	4 (1%)	78	77
2	S	429/447 (96%)	424 (99%)	5 (1%)	71	68
All	All	1917/1968 (97%)	1901 (99%)	16 (1%)	81	80

All (16) residues with a non-rotameric sidechain are listed below:

Mol	Chain	Res	Type
1	A	88	MET
1	B	65	GLU
1	C	88	MET
2	Q	401	LYS
2	Q	454	ASN
2	Q	473	ASP
2	Q	503	LEU
2	R	250	ASN
2	R	454	ASN
2	R	473	ASP
2	R	503	LEU
2	S	363[A]	ASP
2	S	363[B]	ASP
2	S	454	ASN
2	S	473	ASP
2	S	546	CYS

Sometimes sidechains can be flipped to improve hydrogen bonding and reduce clashes. All (7) such sidechains are listed below:

Mol	Chain	Res	Type
1	A	14	ASN
1	C	14	ASN
2	Q	454	ASN
2	Q	509	GLN
2	R	250	ASN
2	R	454	ASN
2	S	454	ASN

5.3.3 RNA ⓘ

There are no RNA molecules in this entry.

5.4 Non-standard residues in protein, DNA, RNA chains

3 non-standard protein/DNA/RNA residues are modelled in this entry.

In the following table, the Counts columns list the number of bonds (or angles) for which Mogul statistics could be retrieved, the number of bonds (or angles) that are observed in the model and the number of bonds (or angles) that are defined in the Chemical Component Dictionary. The Link column lists molecule types, if any, to which the group is linked. The Z score for a bond length (or angle) is the number of standard deviations the observed value is removed from the expected value. A bond length (or angle) with $|Z| > 2$ is considered an outlier worth inspection. RMSZ is the root-mean-square of all Z scores of the bond lengths (or angles).

Mol	Type	Chain	Res	Link	Bond lengths			Bond angles		
					Counts	RMSZ	# Z > 2	Counts	RMSZ	# Z > 2
2	CSX	S	75	2,7,6	3,6,7	0.70	0	1,6,8	1.12	0
2	CSX	Q	75	2,7,6	3,6,7	0.77	0	1,6,8	1.74	0
2	CSX	R	75	2,7,6	3,6,7	0.73	0	1,6,8	0.01	0

In the following table, the Chirals column lists the number of chiral outliers, the number of chiral centers analysed, the number of these observed in the model and the number defined in the Chemical Component Dictionary. Similar counts are reported in the Torsion and Rings columns. '-' means no outliers of that kind were identified.

Mol	Type	Chain	Res	Link	Chirals	Torsions	Rings
2	CSX	S	75	2,7,6	-	0/1/5/7	-
2	CSX	Q	75	2,7,6	-	0/1/5/7	-
2	CSX	R	75	2,7,6	-	0/1/5/7	-

There are no bond length outliers.

There are no bond angle outliers.

There are no chirality outliers.

There are no torsion outliers.

There are no ring outliers.

3 monomers are involved in 6 short contacts:

Mol	Chain	Res	Type	Clashes	Symm-Clashes
2	S	75	CSX	3	0
2	Q	75	CSX	1	0
2	R	75	CSX	2	0

5.5 Carbohydrates [i](#)

There are no monosaccharides in this entry.

5.6 Ligand geometry [i](#)

Of 28 ligands modelled in this entry, 7 are monoatomic - leaving 21 for Mogul analysis.

In the following table, the Counts columns list the number of bonds (or angles) for which Mogul statistics could be retrieved, the number of bonds (or angles) that are observed in the model and the number of bonds (or angles) that are defined in the Chemical Component Dictionary. The Link column lists molecule types, if any, to which the group is linked. The Z score for a bond length (or angle) is the number of standard deviations the observed value is removed from the expected value. A bond length (or angle) with $|Z| > 2$ is considered an outlier worth inspection. RMSZ is the root-mean-square of all Z scores of the bond lengths (or angles).

Mol	Type	Chain	Res	Link	Bond lengths			Bond angles		
					Counts	RMSZ	# Z > 2	Counts	RMSZ	# Z > 2
4	F3S	A	1266	1	0,9,9	-	-	-		
3	SF4	C	1265	1	0,12,12	-	-	-		
5	GOL	A	1271	-	5,5,5	0.31	0	5,5,5	1.02	0
5	GOL	A	1272	-	5,5,5	0.35	0	5,5,5	0.38	0
6	FCO	R	1550	9,2	0,6,6	-	-	-		
5	GOL	A	1273	-	5,5,5	0.36	0	5,5,5	0.93	0
3	SF4	B	1267	1	0,12,12	-	-	-		
5	GOL	S	1562	-	5,5,5	0.38	0	5,5,5	0.64	0
5	GOL	Q	1563	-	5,5,5	0.36	0	5,5,5	0.27	0
4	F3S	C	1266	1	0,9,9	-	-	-		
3	SF4	B	1265	1	0,12,12	-	-	-		
6	FCO	S	1550	9,2	0,6,6	-	-	-		
5	GOL	Q	1562	-	5,5,5	0.56	0	5,5,5	0.50	0
5	GOL	Q	1561	-	5,5,5	0.33	0	5,5,5	0.22	0
4	F3S	B	1266	1	0,9,9	-	-	-		
3	SF4	A	1267	1	0,12,12	-	-	-		
3	SF4	C	1267	1	0,12,12	-	-	-		
5	GOL	R	1563	-	5,5,5	0.33	0	5,5,5	0.18	0
5	GOL	S	1561	-	5,5,5	0.41	0	5,5,5	0.17	0
3	SF4	A	1265	1	0,12,12	-	-	-		
6	FCO	Q	1550	9,2	0,6,6	-	-	-		

In the following table, the Chirals column lists the number of chiral outliers, the number of chiral centers analysed, the number of these observed in the model and the number defined in the Chemical Component Dictionary. Similar counts are reported in the Torsion and Rings columns. '-' means no outliers of that kind were identified.

Mol	Type	Chain	Res	Link	Chirals	Torsions	Rings
4	F3S	A	1266	1	-	-	0/3/3/3
5	GOL	Q	1563	-	-	0/4/4/4	-
3	SF4	C	1265	1	-	-	0/6/5/5
5	GOL	Q	1562	-	-	0/4/4/4	-
5	GOL	Q	1561	-	-	0/4/4/4	-
5	GOL	A	1272	-	-	2/4/4/4	-
5	GOL	A	1271	-	-	1/4/4/4	-
3	SF4	A	1267	1	-	-	0/6/5/5
5	GOL	A	1273	-	-	2/4/4/4	-
3	SF4	C	1267	1	-	-	0/6/5/5
5	GOL	R	1563	-	-	0/4/4/4	-
4	F3S	C	1266	1	-	-	0/3/3/3
5	GOL	S	1561	-	-	0/4/4/4	-
3	SF4	A	1265	1	-	-	0/6/5/5
3	SF4	B	1265	1	-	-	0/6/5/5
3	SF4	B	1267	1	-	-	0/6/5/5
5	GOL	S	1562	-	-	2/4/4/4	-
4	F3S	B	1266	1	-	-	0/3/3/3

There are no bond length outliers.

There are no bond angle outliers.

There are no chirality outliers.

All (7) torsion outliers are listed below:

Mol	Chain	Res	Type	Atoms
5	A	1272	GOL	C1-C2-C3-O3
5	A	1273	GOL	O1-C1-C2-O2
5	A	1273	GOL	O1-C1-C2-C3
5	S	1562	GOL	O1-C1-C2-C3
5	A	1272	GOL	O2-C2-C3-O3
5	S	1562	GOL	O1-C1-C2-O2
5	A	1271	GOL	O1-C1-C2-C3

There are no ring outliers.

5 monomers are involved in 10 short contacts:

Mol	Chain	Res	Type	Clashes	Symm-Clashes
5	A	1272	GOL	5	0
5	A	1273	GOL	1	0
5	Q	1563	GOL	2	0
4	C	1266	F3S	1	0

Continued on next page...

Continued from previous page...

Mol	Chain	Res	Type	Clashes	Symm-Clashes
6	S	1550	FCO	1	0

5.7 Other polymers [i](#)

There are no such residues in this entry.

5.8 Polymer linkage issues [i](#)

There are no chain breaks in this entry.

6 Fit of model and data [i](#)

6.1 Protein, DNA and RNA chains [i](#)

In the following table, the column labelled ‘#RSRZ > 2’ contains the number (and percentage) of RSRZ outliers, followed by percent RSRZ outliers for the chain as percentile scores relative to all X-ray entries and entries of similar resolution. The OWAB column contains the minimum, median, 95th percentile and maximum values of the occupancy-weighted average B-factor per residue. The column labelled ‘Q < 0.9’ lists the number of (and percentage) of residues with an average occupancy less than 0.9.

Mol	Chain	Analysed	<RSRZ>	#RSRZ>2	OWAB(Å ²)	Q<0.9
1	A	262/264 (99%)	0.23	8 (3%) 49 58	18, 28, 43, 58	9 (3%)
1	B	262/264 (99%)	1.89	93 (35%) 0 0	35, 65, 104, 122	4 (1%)
1	C	260/264 (98%)	0.27	8 (3%) 49 58	24, 35, 52, 61	5 (1%)
2	Q	543/563 (96%)	0.26	19 (3%) 44 53	19, 30, 42, 54	9 (1%)
2	R	544/563 (96%)	0.99	91 (16%) 1 2	26, 44, 76, 97	11 (2%)
2	S	543/563 (96%)	0.55	37 (6%) 17 25	22, 41, 67, 83	9 (1%)
All	All	2414/2481 (97%)	0.67	256 (10%) 6 10	18, 37, 75, 122	47 (1%)

All (256) RSRZ outliers are listed below:

Mol	Chain	Res	Type	RSRZ
1	B	3	ALA	9.0
1	B	264	GLY	8.1
1	B	71	TYR	7.8
1	B	169	LEU	7.7
1	B	191	PRO	7.5
1	B	163	THR	7.3
1	B	142	ILE	7.1
1	B	180	GLY	7.1
1	B	179	TYR	6.4
1	B	198	PHE	6.3
1	B	162	LEU	6.1
1	B	177	LEU	6.1
2	R	74	VAL	5.8
2	R	148	ILE	5.7
2	R	163	VAL	5.7
1	B	166	ILE	5.6
2	R	437	ALA	5.6
1	B	140	LYS	5.5
1	B	211	PHE	5.4

Continued on next page...

Continued from previous page...

Mol	Chain	Res	Type	RSRZ
1	B	165	GLY	5.4
1	B	167	PRO	5.4
1	B	7	PRO	5.4
2	S	413	VAL	5.4
1	B	159	VAL	5.3
1	B	168	ASP	5.1
1	B	195	ALA	5.1
1	B	171	GLU	4.9
1	B	188	PRO	4.8
1	B	197	GLU	4.8
2	S	24	ILE	4.7
1	B	190	LEU	4.6
2	R	243	LEU	4.6
1	B	107	GLY	4.6
2	S	148	ILE	4.6
1	B	181	GLU	4.5
2	R	393	TYR	4.3
2	R	394	ALA	4.2
1	B	224	TYR	4.2
1	B	183	VAL	4.1
1	B	214	TYR	4.1
2	S	74	VAL	4.1
1	B	209	LYS	4.0
2	R	440	GLU	4.0
2	R	404	VAL	4.0
2	R	143	LYS	4.0
1	B	187	CYS	3.9
1	B	139	VAL	3.9
2	R	73	GLY	3.9
2	Q	24	ILE	3.9
2	R	451	ALA	3.9
1	B	178	PHE	3.9
2	S	78	VAL	3.8
1	B	160	HIS	3.8
2	R	260	GLN	3.8
1	C	17	CYS	3.7
2	S	143	LYS	3.7
2	R	24	ILE	3.7
1	B	193	PHE	3.7
2	R	415	ALA	3.7
2	R	249	ALA	3.7
2	R	409	GLY	3.6

Continued on next page...

Continued from previous page...

Mol	Chain	Res	Type	RSRZ
2	S	122	LEU	3.6
1	B	192	HIS	3.6
1	A	211	PHE	3.6
2	R	161	LYS	3.6
2	R	72	CYS	3.6
2	R	543	CYS	3.6
2	R	245	LYS	3.6
2	Q	78	VAL	3.5
1	C	48	ILE	3.5
2	R	442	TRP	3.5
2	R	455	THR	3.5
1	B	176	LYS	3.5
2	S	72	CYS	3.5
1	A	18	GLY	3.5
1	B	68	ASP	3.5
2	S	73	GLY	3.5
2	R	545	ALA	3.4
2	R	170	PHE	3.4
1	B	184	HIS	3.4
2	R	267	ILE	3.4
2	R	97	ALA	3.4
2	R	167	LEU	3.4
2	Q	72	CYS	3.4
2	R	76	THR	3.4
2	R	200	ILE	3.4
2	Q	546	CYS	3.3
1	B	194	GLU	3.3
2	Q	74	VAL	3.3
2	S	344	GLY	3.3
2	R	412	SER	3.3
2	R	485	ILE	3.3
2	R	544	ILE	3.3
1	B	158	VAL	3.3
1	B	182	LEU	3.3
1	B	25	ILE	3.3
1	B	20	CYS	3.3
1	B	47	THR	3.3
2	R	227	PRO	3.3
2	R	71	ALA	3.2
2	R	405	ASP	3.2
1	B	137	LEU	3.2
1	B	161	VAL	3.2

Continued on next page...

Continued from previous page...

Mol	Chain	Res	Type	RSRZ
2	R	444	LYS	3.2
1	B	175	PRO	3.2
1	B	18	GLY	3.2
2	S	544	ILE	3.2
2	Q	76	THR	3.2
2	R	407	VAL	3.2
2	R	417	ALA	3.1
2	S	157	ALA	3.1
2	R	244	THR	3.1
2	R	157	ALA	3.1
2	S	117	VAL	3.1
1	B	48	ILE	3.1
2	R	487	GLY	3.1
2	S	343	PRO	3.1
1	A	17	CYS	3.1
2	S	37	GLY	3.1
2	R	117	VAL	3.0
2	S	417	ALA	3.0
2	Q	542	PRO	3.0
2	R	139	ASN	3.0
1	A	48	ILE	3.0
1	B	164	LYS	3.0
1	B	170	ASP	3.0
2	S	10	SER	2.9
2	S	543	CYS	2.9
1	B	133	VAL	2.9
2	R	78	VAL	2.9
2	Q	122	LEU	2.9
2	S	411	LEU	2.9
1	B	196	SER	2.9
2	R	302	PRO	2.9
2	R	158	LYS	2.9
1	B	222	VAL	2.9
2	R	146	ALA	2.9
2	R	486	LYS	2.9
1	B	5	HIS	2.8
1	B	185	ASP	2.8
1	C	25	ILE	2.8
2	R	474	ALA	2.8
1	A	19	GLY	2.8
2	R	453	ASP	2.8
1	B	189	ARG	2.8

Continued on next page...

Continued from previous page...

Mol	Chain	Res	Type	RSRZ
2	R	228	HIS	2.8
1	B	134[A]	SER	2.8
2	R	465	GLU	2.8
2	R	396	GLY	2.7
2	R	105	LEU	2.7
2	R	546	CYS	2.7
1	B	22	GLU	2.7
1	B	100	LYS	2.7
2	Q	73	GLY	2.7
2	R	144	LEU	2.7
2	R	411	LEU	2.7
1	B	69	GLY	2.7
1	B	8	SER	2.7
2	R	256	LYS	2.7
2	R	240	TYR	2.6
2	R	133	ALA	2.6
1	B	36	ILE	2.6
2	S	542	PRO	2.6
1	B	23	ALA	2.6
1	C	19	GLY	2.6
2	R	55	ILE	2.6
1	C	21	THR	2.6
2	R	196	GLU	2.5
1	B	144	ILE	2.5
2	R	106	VAL	2.5
2	R	171	VAL	2.5
1	B	101	ALA	2.5
2	Q	545	ALA	2.5
2	R	77	TYR	2.5
1	B	21	THR	2.5
1	B	152	ILE	2.5
2	R	213	VAL	2.5
1	A	20	CYS	2.5
1	B	138	GLY	2.5
2	R	503	LEU	2.5
2	Q	452	LYS	2.5
2	S	156	SER	2.5
1	B	199	ALA	2.5
1	B	73	VAL	2.5
2	R	271	LEU	2.5
2	Q	543	CYS	2.5
2	R	122	LEU	2.4

Continued on next page...

Continued from previous page...

Mol	Chain	Res	Type	RSRZ
2	S	546	CYS	2.4
2	R	28	LEU	2.4
2	Q	79	HIS	2.4
1	B	17	CYS	2.4
1	B	234	GLN	2.4
2	R	21	ILE	2.4
1	B	174	ARG	2.4
2	Q	117	VAL	2.4
2	R	398	PRO	2.4
2	R	251	TYR	2.4
2	R	402	LYS	2.4
2	S	321	LEU	2.3
2	S	383	VAL	2.3
1	B	34	ALA	2.3
2	R	142	ALA	2.3
1	C	47	THR	2.3
2	R	275	GLY	2.3
2	S	80	ALA	2.3
1	A	4	LYS	2.3
1	B	32	ILE	2.3
1	B	59	ALA	2.3
2	R	216	ALA	2.3
2	S	474	ALA	2.3
1	B	213	LEU	2.3
1	B	9	VAL	2.2
2	S	76	THR	2.2
2	S	415	ALA	2.2
2	S	545	ALA	2.2
2	Q	499	SER	2.2
1	B	186	ASN	2.2
2	S	138	PRO	2.2
2	S	229	THR	2.2
2	Q	544	ILE	2.2
1	B	114	CYS	2.2
1	B	31	TYR	2.2
1	B	207	ALA	2.2
1	B	200	PRO	2.2
2	R	253	ALA	2.2
1	B	263	GLN	2.2
2	R	242	GLY	2.1
2	R	70	ARG	2.1
2	R	476	ARG	2.1

Continued on next page...

Continued from previous page...

Mol	Chain	Res	Type	RSRZ
2	R	325	ASP	2.1
2	S	26	GLY	2.1
1	B	141	THR	2.1
1	B	216	LEU	2.1
2	S	534	LEU	2.1
2	Q	77	TYR	2.1
2	R	22	THR	2.1
2	R	221	ILE	2.1
2	R	413	VAL	2.1
1	A	147	CYS	2.1
2	S	479	LEU	2.1
1	C	18	GLY	2.1
1	C	71	TYR	2.0
1	B	260	PHE	2.0
1	B	63	ALA	2.0
1	B	241	ALA	2.0
2	R	447	ALA	2.0
2	S	322	GLY	2.0
2	Q	448	ASP	2.0
2	R	118	HIS	2.0
1	B	155	VAL	2.0
2	R	12	PHE	2.0
2	R	433	ALA	2.0
2	S	227	PRO	2.0
2	Q	116[A]	LEU	2.0
2	R	239	ASN	2.0
2	S	144	LEU	2.0

6.2 Non-standard residues in protein, DNA, RNA chains [i](#)

In the following table, the Atoms column lists the number of modelled atoms in the group and the number defined in the chemical component dictionary. The B-factors column lists the minimum, median, 95th percentile and maximum values of B factors of atoms in the group. The column labelled 'Q< 0.9' lists the number of atoms with occupancy less than 0.9.

Mol	Type	Chain	Res	Atoms	RSCC	RSR	B-factors(Å ²)	Q<0.9
2	CSX	Q	75	7/8	0.96	0.18	21,22,25,25	1
2	CSX	S	75	7/8	0.96	0.21	22,24,27,28	1
2	CSX	R	75	7/8	0.98	0.21	31,32,35,36	1

6.3 Carbohydrates [i](#)

There are no monosaccharides in this entry.

6.4 Ligands [i](#)

In the following table, the Atoms column lists the number of modelled atoms in the group and the number defined in the chemical component dictionary. The B-factors column lists the minimum, median, 95th percentile and maximum values of B factors of atoms in the group. The column labelled 'Q< 0.9' lists the number of atoms with occupancy less than 0.9.

Mol	Type	Chain	Res	Atoms	RSCC	RSR	B-factors(\AA^2)	Q<0.9
5	GOL	S	1562	6/6	0.70	0.30	48,52,56,57	6
5	GOL	Q	1563	6/6	0.77	0.26	43,47,51,55	0
5	GOL	A	1272	6/6	0.83	0.21	45,47,49,50	0
5	GOL	A	1273	6/6	0.83	0.20	40,49,51,53	0
5	GOL	A	1271	6/6	0.85	0.29	45,50,52,53	0
4	F3S	B	1266	7/7	0.87	0.08	66,71,73,75	0
5	GOL	Q	1562	6/6	0.89	0.19	33,38,40,41	0
5	GOL	R	1563	6/6	0.90	0.16	44,49,50,51	0
3	SF4	B	1267	8/8	0.95	0.11	44,48,52,52	0
5	GOL	S	1561	6/6	0.95	0.09	33,38,41,42	0
5	GOL	Q	1561	6/6	0.95	0.14	37,40,41,41	0
8	MG	R	1553	1/1	0.95	0.05	28,28,28,28	0
7	NI	Q	1551	1/1	0.96	0.12	24,24,24,24	0
8	MG	Q	1559	1/1	0.96	0.06	47,47,47,47	0
3	SF4	B	1265	8/8	0.96	0.07	83,93,97,98	0
8	MG	S	1553	1/1	0.96	0.09	24,24,24,24	0
8	MG	Q	1553	1/1	0.97	0.10	26,26,26,26	0
3	SF4	A	1265	8/8	0.98	0.06	29,32,33,33	0
6	FCO	Q	1550	7/7	0.99	0.15	14,22,24,25	0
6	FCO	R	1550	7/7	0.99	0.14	26,30,30,37	0
6	FCO	S	1550	7/7	0.99	0.17	23,25,28,28	0
4	F3S	C	1266	7/7	0.99	0.09	20,25,27,29	0
7	NI	S	1551	1/1	0.99	0.12	28,28,28,28	0
3	SF4	C	1265	8/8	0.99	0.07	27,29,31,31	0
3	SF4	C	1267	8/8	0.99	0.12	24,27,28,29	0
4	F3S	A	1266	7/7	0.99	0.09	22,25,26,26	0
3	SF4	A	1267	8/8	0.99	0.12	20,21,24,25	0
7	NI	R	1551	1/1	1.00	0.14	34,34,34,34	0

6.5 Other polymers [i](#)

There are no such residues in this entry.