



# Full wwPDB X-ray Structure Validation Report ⓘ

Jun 15, 2020 – 07:39 am BST

PDB ID : 4UC1  
Title : High resolution crystal structure of translocator protein 18kDa (TSPO) from Rhodobacter sphaeroides (A139T Mutant) in C2 space group  
Authors : Li, F.; Liu, J.; Zheng, Y.; Garavito, R.M.; Ferguson-Miller, S.  
Deposited on : 2014-08-13  
Resolution : 1.80 Å(reported)

This is a Full wwPDB X-ray Structure Validation Report for a publicly released PDB entry.

We welcome your comments at [validation@mail.wwpdb.org](mailto:validation@mail.wwpdb.org)

A user guide is available at

<https://www.wwpdb.org/validation/2017/XrayValidationReportHelp>

with specific help available everywhere you see the ⓘ symbol.

---

The following versions of software and data (see [references ⓘ](#)) were used in the production of this report:

MolProbity : 4.02b-467  
Mogul : 1.8.5 (274361), CSD as541be (2020)  
Xtriage (Phenix) : 1.13  
EDS : 2.11  
buster-report : 1.1.7 (2018)  
Percentile statistics : 20191225.v01 (using entries in the PDB archive December 25th 2019)  
Refmac : 5.8.0158  
CCP4 : 7.0.044 (Gargrove)  
Ideal geometry (proteins) : Engh & Huber (2001)  
Ideal geometry (DNA, RNA) : Parkinson et al. (1996)  
Validation Pipeline (wwPDB-VP) : 2.11

# 1 Overall quality at a glance i

The following experimental techniques were used to determine the structure:

*X-RAY DIFFRACTION*

The reported resolution of this entry is 1.80 Å.

Percentile scores (ranging between 0-100) for global validation metrics of the entry are shown in the following graphic. The table shows the number of entries on which the scores are based.

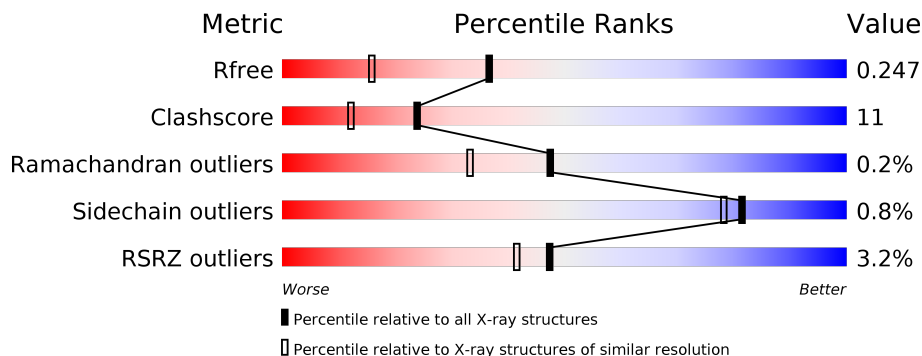

Metric	Whole archive (#Entries)	Similar resolution (#Entries, resolution range(Å))
$R_{free}$	130704	5950 (1.80-1.80)
Clashscore	141614	6793 (1.80-1.80)
Ramachandran outliers	138981	6697 (1.80-1.80)
Sidechain outliers	138945	6696 (1.80-1.80)
RSRZ outliers	127900	5850 (1.80-1.80)

The table below summarises the geometric issues observed across the polymeric chains and their fit to the electron density. The red, orange, yellow and green segments on the lower bar indicate the fraction of residues that contain outliers for  $\geq 3$ , 2, 1 and 0 types of geometric quality criteria respectively. A grey segment represents the fraction of residues that are not modelled. The numeric value for each fraction is indicated below the corresponding segment, with a dot representing fractions  $\leq 5\%$ . The upper red bar (where present) indicates the fraction of residues that have poor fit to the electron density. The numeric value is given above the bar.

Mol	Chain	Length	Quality of chain
1	A	157	<div style="display: flex; align-items: center;"> <div style="width: 2%; height: 10px; background-color: red; margin-right: 5px;"></div> <div style="width: 83%; height: 10px; background-color: green; margin-right: 5px;"></div> <div style="width: 17%; height: 10px; background-color: yellow; margin-right: 5px;"></div> </div>
1	B	157	<div style="display: flex; align-items: center;"> <div style="width: 2%; height: 10px; background-color: red; margin-right: 5px;"></div> <div style="width: 87%; height: 10px; background-color: green; margin-right: 5px;"></div> <div style="width: 12%; height: 10px; background-color: yellow; margin-right: 5px;"></div> <div style="width: 1%; height: 10px; background-color: grey; margin-right: 5px;"></div> </div>
1	C	157	<div style="display: flex; align-items: center;"> <div style="width: 6%; height: 10px; background-color: red; margin-right: 5px;"></div> <div style="width: 80%; height: 10px; background-color: green; margin-right: 5px;"></div> <div style="width: 15%; height: 10px; background-color: yellow; margin-right: 5px;"></div> <div style="width: 5%; height: 10px; background-color: grey; margin-right: 5px;"></div> </div>

The following table lists non-polymeric compounds, carbohydrate monomers and non-standard residues in protein, DNA, RNA chains that are outliers for geometric or electron-density-fit criteria:

Mol	Type	Chain	Res	Chirality	Geometry	Clashes	Electron density
3	PP9	A	207	-	-	X	X
4	Z0P	B	208	X	-	-	-

## 2 Entry composition i

There are 7 unique types of molecules in this entry. The entry contains 4330 atoms, of which 0 are hydrogens and 0 are deuteriums.

In the tables below, the ZeroOcc column contains the number of atoms modelled with zero occupancy, the AltConf column contains the number of residues with at least one atom in alternate conformation and the Trace column contains the number of residues modelled with at most 2 atoms.

- Molecule 1 is a protein called Translocator protein TspO.

Mol	Chain	Residues	Atoms					ZeroOcc	AltConf	Trace
			Total	C	N	O	S			
1	A	157	Total 1276	C 856	N 203	O 205	S 12	0	1	0
1	B	156	Total 1278	C 858	N 205	O 205	S 10	0	2	0
1	C	149	Total 1204	C 812	N 188	O 194	S 10	0	1	0

There are 3 discrepancies between the modelled and reference sequences:

Chain	Residue	Modelled	Actual	Comment	Reference
A	139	THR	ALA	engineered mutation	UNP Q9RFC8
B	139	THR	ALA	engineered mutation	UNP Q9RFC8
C	139	THR	ALA	engineered mutation	UNP Q9RFC8

- Molecule 2 is (2R)-2,3-dihydroxypropyl (9Z)-octadec-9-enoate (three-letter code: OLC) (formula: C<sub>21</sub>H<sub>40</sub>O<sub>4</sub>).

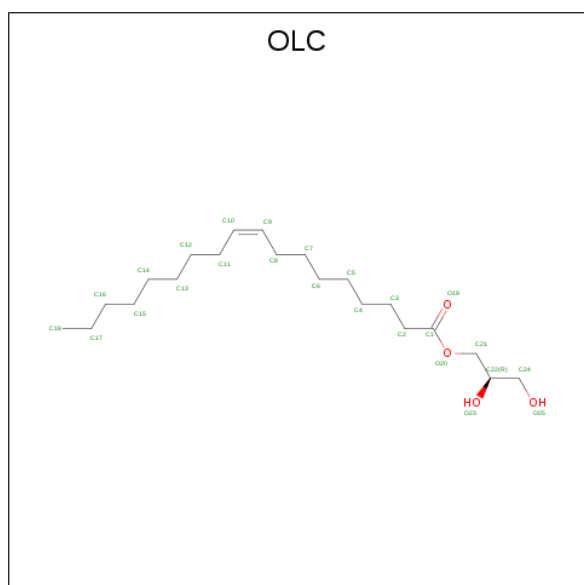

Mol	Chain	Residues	Atoms			ZeroOcc	AltConf
2	A	1	Total	C	O	0	0
			25	21	4		
2	A	1	Total	C	O	0	0
			25	21	4		
2	A	1	Total	C	O	0	0
			25	21	4		
2	A	1	Total	C	O	0	0
			17	13	4		
2	A	1	Total	C	O	0	0
			25	21	4		
2	B	1	Total	C	O	0	0
			25	21	4		
2	B	1	Total	C	O	0	0
			25	21	4		
2	B	1	Total	C	O	0	0
			25	21	4		
2	B	1	Total	C	O	0	0
			13	9	4		
2	B	1	Total	C	O	0	0
			25	21	4		
2	B	1	Total	C	O	0	0
			12	8	4		
2	B	1	Total	C	O	0	0
			12	8	4		
2	C	1	Total	C	O	0	0
			24	21	3		
2	C	1	Total	C	O	0	0
			25	21	4		
2	C	1	Total	C	O	0	0
			25	21	4		
2	C	1	Total	C	O	0	0
			25	21	4		

- Molecule 3 is PROTOPORPHYRIN IX (three-letter code: PP9) (formula:  $C_{34}H_{34}N_4O_4$ ).

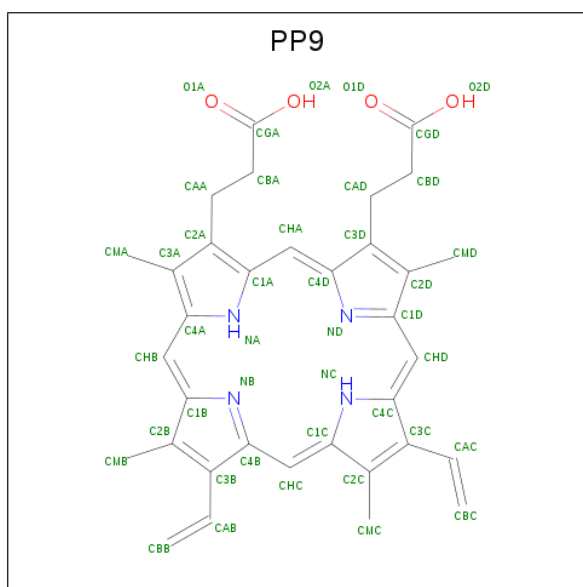

Mol	Chain	Residues	Atoms				ZeroOcc	AltConf
3	A	1	Total	C	N	O	0	0
			42	34	4	4		

- Molecule 4 is (2S)-1-(hexadecanoyloxy)-3-hydroxypropan-2-yl (11Z)-octadec-11-enoate (three-letter code: Z0P) (formula: C<sub>37</sub>H<sub>70</sub>O<sub>5</sub>).

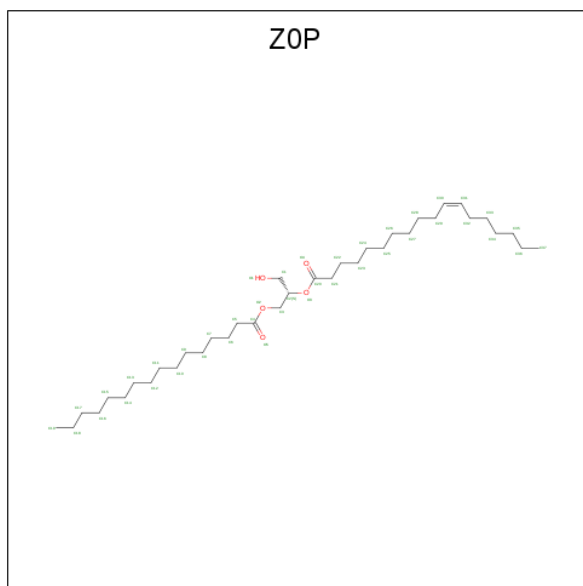

Mol	Chain	Residues	Atoms			ZeroOcc	AltConf
4	B	1	Total	C	O	0	0
			42	37	5		

- Molecule 5 is O-ACETALDEHYDYL-HEXAETHYLENE GLYCOL (three-letter code: P4C) (formula: C<sub>14</sub>H<sub>28</sub>O<sub>8</sub>).

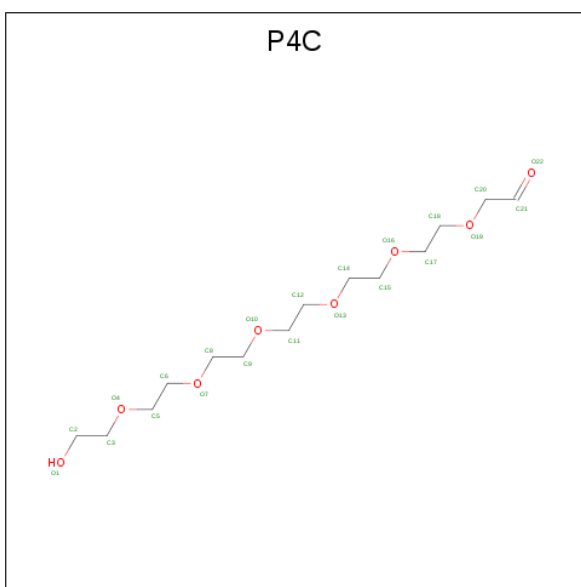

Mol	Chain	Residues	Atoms			ZeroOcc	AltConf
5	C	1	Total	C	O	0	0
			22	14	8		

- Molecule 6 is METHOXY-ETHOXYL (three-letter code: MOE) (formula:  $C_3H_7O_2$ ).

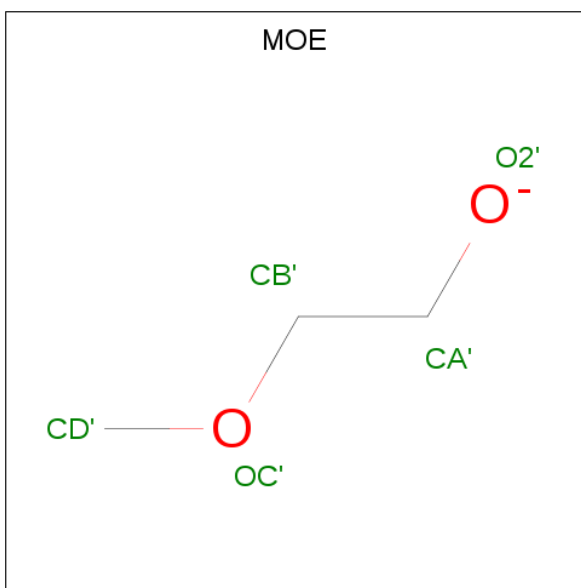

Mol	Chain	Residues	Atoms			ZeroOcc	AltConf
6	C	1	Total	C	O	0	0
			5	3	2		

- Molecule 7 is water.

<b>Mol</b>	<b>Chain</b>	<b>Residues</b>	<b>Atoms</b>		<b>ZeroOcc</b>	<b>AltConf</b>
7	A	34	Total 34	O 34	0	0
7	B	22	Total 22	O 22	0	0
7	C	27	Total 27	O 27	0	0



### 3 Residue-property plots [i](#)

These plots are drawn for all protein, RNA and DNA chains in the entry. The first graphic for a chain summarises the proportions of the various outlier classes displayed in the second graphic. The second graphic shows the sequence view annotated by issues in geometry and electron density. Residues are color-coded according to the number of geometric quality criteria for which they contain at least one outlier: green = 0, yellow = 1, orange = 2 and red = 3 or more. A red dot above a residue indicates a poor fit to the electron density ( $RSRZ > 2$ ). Stretches of 2 or more consecutive residues without any outlier are shown as a green connector. Residues present in the sample, but not in the model, are shown in grey.

- Molecule 1: Translocator protein TspO

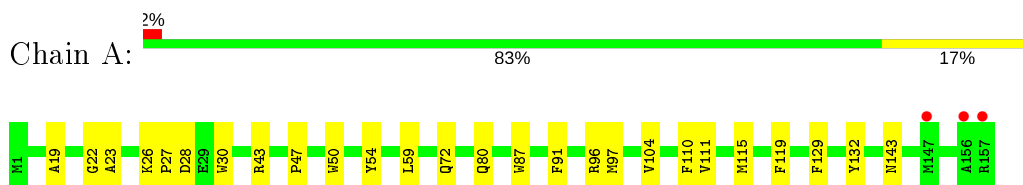

- Molecule 1: Translocator protein TspO

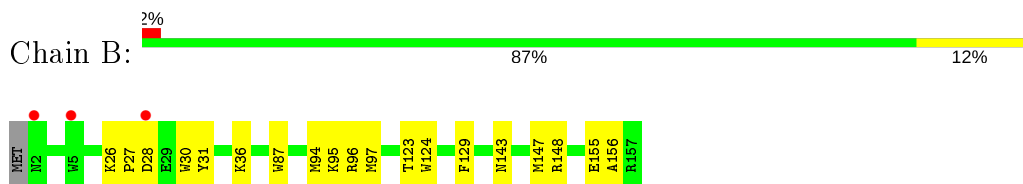

- Molecule 1: Translocator protein TspO

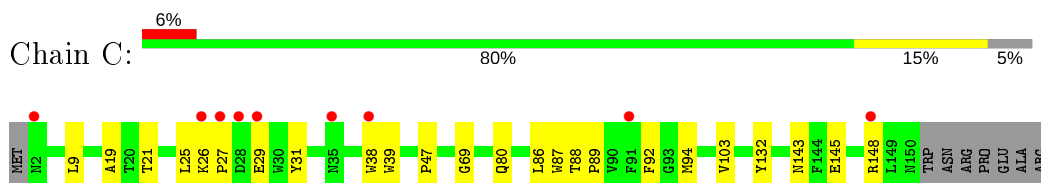

## 4 Data and refinement statistics

Property	Value	Source
Space group	C 1 2 1	Depositor
Cell constants a, b, c, $\alpha$ , $\beta$ , $\gamma$	58.63Å 99.54Å 95.21Å 90.00° 99.92° 90.00°	Depositor
Resolution (Å)	43.97 – 1.80 43.96 – 1.65	Depositor EDS
% Data completeness (in resolution range)	99.7 (43.97-1.80) 83.6 (43.96-1.65)	Depositor EDS
$R_{merge}$	0.09	Depositor
$R_{sym}$	(Not available)	Depositor
$\langle I/\sigma(I) \rangle$ <sup>1</sup>	0.17 (at 1.65Å)	Xtrriage
Refinement program	PHENIX (phenix.refine: 1.9_1692)	Depositor
R, $R_{free}$	0.201 , 0.247 0.204 , 0.247	Depositor DCC
$R_{free}$ test set	2000 reflections (3.10%)	wwPDB-VP
Wilson B-factor (Å <sup>2</sup> )	18.3	Xtrriage
Anisotropy	0.115	Xtrriage
Bulk solvent $k_{sol}$ (e/Å <sup>3</sup> ), $B_{sol}$ (Å <sup>2</sup> )	0.35 , 69.7	EDS
L-test for twinning <sup>2</sup>	$\langle  L  \rangle = 0.49$ , $\langle L^2 \rangle = 0.32$	Xtrriage
Estimated twinning fraction	No twinning to report.	Xtrriage
$F_o, F_c$ correlation	0.95	EDS
Total number of atoms	4330	wwPDB-VP
Average B, all atoms (Å <sup>2</sup> )	34.0	wwPDB-VP

Xtrriage's analysis on translational NCS is as follows: *The largest off-origin peak in the Patterson function is 13.87% of the height of the origin peak. No significant pseudotranslation is detected.*

<sup>1</sup>Intensities estimated from amplitudes.

<sup>2</sup>Theoretical values of  $\langle |L| \rangle$ ,  $\langle L^2 \rangle$  for acentric reflections are 0.5, 0.333 respectively for untwinned datasets, and 0.375, 0.2 for perfectly twinned datasets.

## 5 Model quality [i](#)

### 5.1 Standard geometry [i](#)

Bond lengths and bond angles in the following residue types are not validated in this section: Z0P, PP9, OLC, P4C, MOE

The Z score for a bond length (or angle) is the number of standard deviations the observed value is removed from the expected value. A bond length (or angle) with  $|Z| > 5$  is considered an outlier worth inspection. RMSZ is the root-mean-square of all Z scores of the bond lengths (or angles).

Mol	Chain	Bond lengths		Bond angles	
		RMSZ	# $ Z  > 5$	RMSZ	# $ Z  > 5$
1	A	0.53	1/1325 (0.1%)	0.51	0/1817
1	B	0.42	0/1327	0.50	0/1820
1	C	0.45	0/1250	0.52	0/1715
All	All	0.47	1/3902 (0.0%)	0.51	0/5352

All (1) bond length outliers are listed below:

Mol	Chain	Res	Type	Atoms	Z	Observed(Å)	Ideal(Å)
1	A	115	MET	CG-SD	5.04	1.94	1.81

There are no bond angle outliers.

There are no chirality outliers.

There are no planarity outliers.

### 5.2 Too-close contacts [i](#)

In the following table, the Non-H and H(model) columns list the number of non-hydrogen atoms and hydrogen atoms in the chain respectively. The H(added) column lists the number of hydrogen atoms added and optimized by MolProbity. The Clashes column lists the number of clashes within the asymmetric unit, whereas Symm-Clashes lists symmetry related clashes.

Mol	Chain	Non-H	H(model)	H(added)	Clashes	Symm-Clashes
1	A	1276	0	1251	40	0
1	B	1278	0	1256	18	0
1	C	1204	0	1183	23	0
2	A	142	0	222	9	0
2	B	137	0	201	6	0
2	C	99	0	158	9	0
3	A	42	0	32	31	0

*Continued on next page...*

*Continued from previous page...*

Mol	Chain	Non-H	H(model)	H(added)	Clashes	Symm-Clashes
4	B	42	0	70	1	0
5	C	22	0	28	2	0
6	C	5	0	7	2	0
7	A	34	0	0	1	0
7	B	22	0	0	0	0
7	C	27	0	0	2	0
All	All	4330	0	4408	96	0

The all-atom clashscore is defined as the number of clashes found per 1000 atoms (including hydrogen atoms). The all-atom clashscore for this structure is 11.

All (96) close contacts within the same asymmetric unit are listed below, sorted by their clash magnitude.

Atom-1	Atom-2	Interatomic distance (Å)	Clash overlap (Å)
1:C:69:GLY:H	6:C:206:MOE:HB'2	1.29	0.98
1:A:50:TRP:HE1	3:A:207:PP9:HBA1	1.36	0.91
1:A:43:ARG:HB3	3:A:207:PP9:HBB1	1.53	0.90
1:A:54:TYR:OH	3:A:207:PP9:HAD1	1.74	0.86
2:B:201:OLC:H10	2:B:202:OLC:H9	1.58	0.85
3:A:207:PP9:CAB	1:C:39:TRP:HB3	2.14	0.78
1:A:54:TYR:HH	3:A:207:PP9:HAD1	1.52	0.75
1:C:80:GLN:NE2	1:C:132:TYR:OH	2.21	0.74
1:A:87:TRP:HZ3	3:A:207:PP9:HAA2	1.53	0.73
1:A:50:TRP:NE1	3:A:207:PP9:HBA1	2.03	0.72
3:A:207:PP9:HAB	1:C:39:TRP:HB3	1.72	0.71
1:A:59:LEU:HD13	2:A:201:OLC:H4A	1.72	0.71
1:A:43:ARG:HB3	3:A:207:PP9:HMB1	1.74	0.70
1:C:29:GLU:OE1	1:C:31:TYR:OH	2.11	0.68
3:A:207:PP9:HMC2	1:C:39:TRP:NE1	2.10	0.66
1:A:26:LYS:NZ	1:B:96:ARG:NH1	2.42	0.66
3:A:207:PP9:HMB1	3:A:207:PP9:HBB1	1.77	0.64
1:A:26:LYS:HZ1	1:B:96:ARG:NH1	1.95	0.64
1:B:148:ARG:HG3	2:B:205:OLC:H24A	1.80	0.62
1:A:80:GLN:NE2	1:A:132:TYR:OH	2.32	0.62
1:A:54:TYR:OH	3:A:207:PP9:HMD1	1.99	0.62
1:A:72:GLN:HG2	2:B:202:OLC:H21	1.81	0.62
1:B:87:TRP:HE1	1:B:143:ASN:HD22	1.46	0.62
2:A:201:OLC:H7A	2:A:202:OLC:H6A	1.84	0.60
1:B:87:TRP:HE1	1:B:143:ASN:ND2	2.00	0.58
1:A:87:TRP:CZ3	3:A:207:PP9:HAA2	2.37	0.58
2:C:204:OLC:H11A	5:C:205:P4C:H52	1.85	0.57

*Continued on next page...*

*Continued from previous page...*

Atom-1	Atom-2	Interatomic distance (Å)	Clash overlap (Å)
3:A:207:PP9:HBD1	3:A:207:PP9:CHA	2.35	0.57
1:C:145:GLU:HG2	1:C:148:ARG:HH21	1.70	0.56
4:B:208:ZOP:H62	4:B:208:ZOP:H261	1.87	0.56
1:C:47:PRO:HB2	2:C:204:OLC:H12	1.87	0.55
1:C:25:LEU:HB3	1:C:26:LYS:HB2	1.88	0.55
1:A:87:TRP:HE1	1:A:143:ASN:HD22	1.53	0.55
1:A:28:ASP:OD2	1:A:30:TRP:HB3	2.07	0.55
1:A:87:TRP:HE1	1:A:143:ASN:ND2	2.07	0.53
1:A:91:PHE:CE2	1:A:97:MET:HG2	2.44	0.53
1:C:87:TRP:HE1	1:C:143:ASN:ND2	2.06	0.53
3:A:207:PP9:HMC2	1:C:39:TRP:CD1	2.44	0.52
1:A:26:LYS:NZ	1:B:96:ARG:HH12	2.05	0.52
1:B:97:MET:HE2	1:B:156:ALA:HA	1.91	0.52
1:A:54:TYR:CE2	3:A:207:PP9:HMD1	2.45	0.52
1:A:50:TRP:CD1	3:A:207:PP9:HBD2	2.45	0.52
1:A:27:PRO:HD3	1:C:38:TRP:CD2	2.44	0.51
1:A:87:TRP:CD1	1:A:104:VAL:HB	2.46	0.51
1:A:43:ARG:HE	3:A:207:PP9:HMB3	1.75	0.51
1:B:97:MET:CE	1:B:147:MET:HA	2.40	0.51
1:A:50:TRP:CE2	3:A:207:PP9:HBD2	2.47	0.50
1:C:69:GLY:N	6:C:206:MOE:HB'2	2.12	0.50
1:C:21:THR:HG21	1:C:88:THR:HG22	1.93	0.50
1:C:86:LEU:O	1:C:89:PRO:HD2	2.11	0.50
1:B:28:ASP:HB3	1:B:31:TYR:H	1.78	0.49
2:C:201:OLC:O25	7:C:314:HOH:O	2.15	0.48
2:A:203:OLC:H18	2:A:205:OLC:H21A	1.94	0.48
1:B:31:TYR:O	1:B:36:LYS:NZ	2.33	0.48
1:C:87:TRP:HB2	1:C:103:VAL:HG12	1.96	0.47
1:B:95[B]:LYS:O	1:B:155:GLU:HB2	2.14	0.47
1:A:22:GLY:HA3	3:A:207:PP9:ND	2.29	0.47
2:A:202:OLC:H13A	2:A:206:OLC:H17	1.96	0.47
1:C:19:ALA:HA	2:C:204:OLC:H3A	1.97	0.47
1:C:94:MET:O	7:C:315:HOH:O	2.20	0.47
2:A:201:OLC:H15A	2:A:202:OLC:H12	1.96	0.47
1:A:19:ALA:HA	3:A:207:PP9:CMD	2.46	0.46
3:A:207:PP9:NC	3:A:207:PP9:NB	2.64	0.46
1:A:26:LYS:HZ2	1:B:96:ARG:NH1	2.14	0.46
1:A:23:ALA:HB2	3:A:207:PP9:HAC	1.98	0.45
1:C:87:TRP:HE1	1:C:143:ASN:HD22	1.63	0.45
1:A:50:TRP:NE1	3:A:207:PP9:HBD2	2.32	0.45
2:A:206:OLC:H8	2:A:206:OLC:H11	1.74	0.45

*Continued on next page...*

Continued from previous page...

Atom-1	Atom-2	Interatomic distance (Å)	Clash overlap (Å)
1:A:19:ALA:HA	3:A:207:PP9:HMD3	1.99	0.44
1:A:43:ARG:CB	3:A:207:PP9:HMB1	2.45	0.44
1:B:123:THR:HG23	2:B:203:OLC:H22	2.00	0.44
1:B:30:TRP:NE1	1:B:95[A]:LYS:HE3	2.33	0.44
1:A:96:ARG:NE	7:A:301:HOH:O	2.26	0.44
1:B:94:MET:HE2	1:B:94:MET:HB3	1.79	0.44
2:C:204:OLC:H7A	2:C:204:OLC:H10	1.63	0.44
1:C:80:GLN:HE21	1:C:132:TYR:HH	1.62	0.43
2:A:201:OLC:H18B	2:A:206:OLC:H13A	2.00	0.43
1:B:124:TRP:CD1	2:B:207:OLC:H22	2.53	0.43
2:A:201:OLC:C18	2:A:206:OLC:H13A	2.48	0.43
1:A:80:GLN:HG2	1:A:111:VAL:HG22	2.00	0.43
1:A:110:PHE:HZ	2:B:202:OLC:H10	1.84	0.43
2:C:201:OLC:H10	2:C:201:OLC:H13A	1.70	0.43
1:C:88:THR:HB	1:C:89:PRO:HD3	2.01	0.43
2:C:202:OLC:H5	2:C:202:OLC:H2A	1.83	0.42
3:A:207:PP9:HMA2	3:A:207:PP9:O1A	2.20	0.42
1:C:9:LEU:HD23	1:C:9:LEU:HA	1.91	0.42
3:A:207:PP9:CHA	3:A:207:PP9:CBD	2.94	0.42
2:C:204:OLC:H13A	2:C:204:OLC:H16A	1.79	0.42
1:A:47:PRO:HG3	3:A:207:PP9:NC	2.35	0.42
1:B:27:PRO:HB3	1:B:31:TYR:CD2	2.55	0.41
1:C:92:PHE:CG	2:C:204:OLC:H22	2.55	0.41
1:A:23:ALA:HA	3:A:207:PP9:CMC	2.49	0.41
1:A:119:PHE:HB3	2:A:203:OLC:H24	2.02	0.41
1:A:54:TYR:CZ	3:A:207:PP9:HMD1	2.56	0.41
1:A:26:LYS:HZ2	1:B:96:ARG:HH12	1.66	0.40
5:C:205:P4C:H172	5:C:205:P4C:H142	1.87	0.40

There are no symmetry-related clashes.

## 5.3 Torsion angles [i](#)

### 5.3.1 Protein backbone [i](#)

In the following table, the Percentiles column shows the percent Ramachandran outliers of the chain as a percentile score with respect to all X-ray entries followed by that with respect to entries of similar resolution.

The Analysed column shows the number of residues for which the backbone conformation was analysed, and the total number of residues.

Mol	Chain	Analysed	Favoured	Allowed	Outliers	Percentiles	
1	A	156/157 (99%)	154 (99%)	2 (1%)	0	100	100
1	B	156/157 (99%)	152 (97%)	4 (3%)	0	100	100
1	C	148/157 (94%)	144 (97%)	3 (2%)	1 (1%)	22	10
All	All	460/471 (98%)	450 (98%)	9 (2%)	1 (0%)	47	33

All (1) Ramachandran outliers are listed below:

Mol	Chain	Res	Type
1	C	27	PRO

### 5.3.2 Protein sidechains [i](#)

In the following table, the Percentiles column shows the percent sidechain outliers of the chain as a percentile score with respect to all X-ray entries followed by that with respect to entries of similar resolution.

The Analysed column shows the number of residues for which the sidechain conformation was analysed, and the total number of residues.

Mol	Chain	Analysed	Rotameric	Outliers	Percentiles	
1	A	125/124 (101%)	124 (99%)	1 (1%)	81	78
1	B	125/124 (101%)	122 (98%)	3 (2%)	49	36
1	C	118/124 (95%)	118 (100%)	0	100	100
All	All	368/372 (99%)	364 (99%)	4 (1%)	81	68

All (4) residues with a non-rotameric sidechain are listed below:

Mol	Chain	Res	Type
1	A	129	PHE
1	B	26[A]	LYS
1	B	26[B]	LYS
1	B	129	PHE

Some sidechains can be flipped to improve hydrogen bonding and reduce clashes. All (6) such sidechains are listed below:

Mol	Chain	Res	Type
1	A	80	GLN
1	A	143	ASN
1	B	143	ASN

*Continued on next page...*

*Continued from previous page...*

Mol	Chain	Res	Type
1	C	80	GLN
1	C	84	ASN
1	C	143	ASN

### 5.3.3 RNA [i](#)

There are no RNA molecules in this entry.

### 5.4 Non-standard residues in protein, DNA, RNA chains [i](#)

There are no non-standard protein/DNA/RNA residues in this entry.

### 5.5 Carbohydrates [i](#)

There are no carbohydrates in this entry.

### 5.6 Ligand geometry [i](#)

21 ligands are modelled in this entry.

In the following table, the Counts columns list the number of bonds (or angles) for which Mogul statistics could be retrieved, the number of bonds (or angles) that are observed in the model and the number of bonds (or angles) that are defined in the Chemical Component Dictionary. The Link column lists molecule types, if any, to which the group is linked. The Z score for a bond length (or angle) is the number of standard deviations the observed value is removed from the expected value. A bond length (or angle) with  $|Z| > 2$  is considered an outlier worth inspection. RMSZ is the root-mean-square of all Z scores of the bond lengths (or angles).

Mol	Type	Chain	Res	Link	Bond lengths			Bond angles		
					Counts	RMSZ	$\# Z  > 2$	Counts	RMSZ	$\# Z  > 2$
2	OLC	A	201	-	24,24,24	0.69	1 (4%)	25,25,25	1.17	2 (8%)
2	OLC	A	206	-	24,24,24	0.70	1 (4%)	25,25,25	0.94	1 (4%)
2	OLC	A	205	-	16,16,24	0.89	1 (6%)	17,17,25	1.19	1 (5%)
2	OLC	B	201	-	24,24,24	0.68	1 (4%)	25,25,25	0.98	1 (4%)
6	MOE	C	206	-	4,4,4	0.42	0	3,3,3	0.40	0
5	P4C	C	205	-	21,21,21	0.41	0	20,20,20	0.91	1 (5%)
2	OLC	B	202	-	24,24,24	0.71	1 (4%)	25,25,25	1.02	1 (4%)
2	OLC	B	205	-	24,24,24	0.70	1 (4%)	25,25,25	0.95	2 (8%)
2	OLC	A	204	-	24,24,24	0.69	1 (4%)	25,25,25	0.92	1 (4%)



Mol	Type	Chain	Res	Link	Bond lengths			Bond angles		
					Counts	RMSZ	# Z  > 2	Counts	RMSZ	# Z  > 2
2	OLC	B	206	-	11,11,24	0.95	1 (9%)	12,12,25	0.95	1 (8%)
2	OLC	A	203	-	24,24,24	0.73	1 (4%)	25,25,25	0.95	2 (8%)
2	OLC	B	203	-	24,24,24	0.67	1 (4%)	25,25,25	1.03	1 (4%)
2	OLC	C	203	-	24,24,24	0.69	1 (4%)	25,25,25	0.94	2 (8%)
2	OLC	C	204	-	24,24,24	0.72	1 (4%)	25,25,25	0.96	1 (4%)
3	PP9	A	207	-	34,46,46	3.62	21 (61%)	33,68,68	3.95	15 (45%)
2	OLC	C	202	-	24,24,24	0.72	1 (4%)	25,25,25	0.91	1 (4%)
4	Z0P	B	208	-	41,41,41	1.31	4 (9%)	43,43,43	1.31	2 (4%)
2	OLC	B	204	-	12,12,24	0.94	1 (8%)	13,13,25	1.27	2 (15%)
2	OLC	B	207	-	11,11,24	0.95	1 (9%)	12,12,25	1.02	1 (8%)
2	OLC	A	202	-	24,24,24	0.68	1 (4%)	25,25,25	0.83	1 (4%)
2	OLC	C	201	-	23,23,24	0.65	1 (4%)	23,23,25	1.12	2 (8%)

In the following table, the Chirals column lists the number of chiral outliers, the number of chiral centers analysed, the number of these observed in the model and the number defined in the Chemical Component Dictionary. Similar counts are reported in the Torsion and Rings columns. '-' means no outliers of that kind were identified.

Mol	Type	Chain	Res	Link	Chirals	Torsions	Rings
2	OLC	A	201	-	-	9/24/24/24	-
2	OLC	A	206	-	-	13/24/24/24	-
2	OLC	C	204	-	-	9/24/24/24	-
2	OLC	A	205	-	-	4/16/16/24	-
2	OLC	B	201	-	-	6/24/24/24	-
6	MOE	C	206	-	-	1/2/2/2	-
5	P4C	C	205	-	-	6/18/19/19	-
4	Z0P	B	208	-	1/1/3/5	23/43/43/43	-
2	OLC	B	205	-	-	14/24/24/24	-
2	OLC	A	204	-	-	6/24/24/24	-
2	OLC	B	206	-	-	4/11/11/24	-
2	OLC	A	203	-	-	9/24/24/24	-
2	OLC	B	203	-	-	13/24/24/24	-
2	OLC	C	203	-	-	11/24/24/24	-
2	OLC	B	202	-	-	13/24/24/24	-
3	PP9	A	207	-	-	10/20/62/62	0/4/5/5
2	OLC	C	202	-	-	14/24/24/24	-

Continued on next page...

*Continued from previous page...*

Mol	Type	Chain	Res	Link	Chirals	Torsions	Rings
2	OLC	B	204	-	-	5/12/12/24	-
2	OLC	B	207	-	-	4/11/11/24	-
2	OLC	A	202	-	-	13/24/24/24	-
2	OLC	C	201	-	-	9/22/22/24	-

All (42) bond length outliers are listed below:

Mol	Chain	Res	Type	Atoms	Z	Observed(Å)	Ideal(Å)
3	A	207	PP9	CHC-C4B	11.91	1.45	1.35
3	A	207	PP9	CHD-C1D	8.95	1.42	1.35
3	A	207	PP9	CMB-C2B	-5.78	1.38	1.50
3	A	207	PP9	CMC-C2C	-4.69	1.41	1.51
3	A	207	PP9	C1B-C2B	-4.50	1.36	1.45
4	B	208	Z0P	C31-C30	4.43	1.57	1.31
3	A	207	PP9	CMD-C2D	-4.23	1.41	1.50
3	A	207	PP9	C4D-C3D	-3.73	1.39	1.45
3	A	207	PP9	CAD-C3D	-3.54	1.42	1.51
4	B	208	Z0P	O2-C4	3.37	1.43	1.33
3	A	207	PP9	C1D-C2D	-3.31	1.38	1.45
4	B	208	Z0P	O3-C20	3.15	1.43	1.34
3	A	207	PP9	C4D-ND	3.12	1.43	1.36
2	A	203	OLC	O20-C1	3.00	1.42	1.33
3	A	207	PP9	C3C-C2C	-2.96	1.36	1.40
3	A	207	PP9	CAA-C2A	-2.92	1.47	1.52
2	C	204	OLC	O20-C1	2.90	1.41	1.33
2	A	206	OLC	O20-C1	2.90	1.41	1.33
2	A	205	OLC	O20-C1	2.85	1.41	1.33
2	B	202	OLC	O20-C1	2.82	1.41	1.33
2	C	202	OLC	O20-C1	2.82	1.41	1.33
2	B	204	OLC	O20-C1	2.78	1.41	1.33
2	A	201	OLC	O20-C1	2.78	1.41	1.33
2	B	205	OLC	O20-C1	2.74	1.41	1.33
3	A	207	PP9	C4A-NA	-2.73	1.30	1.38
2	B	203	OLC	O20-C1	2.72	1.41	1.33
2	B	201	OLC	O20-C1	2.71	1.41	1.33
2	A	204	OLC	O20-C1	2.71	1.41	1.33
3	A	207	PP9	C1A-NA	-2.65	1.30	1.38
2	C	203	OLC	O20-C1	2.63	1.41	1.33
2	A	202	OLC	O20-C1	2.60	1.40	1.33
2	B	206	OLC	O20-C1	2.60	1.40	1.33
2	B	207	OLC	O20-C1	2.58	1.40	1.33

*Continued on next page...*

*Continued from previous page...*

Mol	Chain	Res	Type	Atoms	Z	Observed(Å)	Ideal(Å)
3	A	207	PP9	C4C-CHD	-2.58	1.31	1.41
2	C	201	OLC	O20-C1	2.57	1.40	1.33
3	A	207	PP9	CHA-C4D	-2.49	1.34	1.43
3	A	207	PP9	CHB-C1B	-2.43	1.34	1.43
3	A	207	PP9	CMA-C3A	-2.38	1.45	1.51
3	A	207	PP9	C4B-NB	-2.23	1.33	1.38
3	A	207	PP9	C1D-ND	-2.17	1.33	1.38
4	B	208	Z0P	O3-C2	-2.16	1.41	1.46
3	A	207	PP9	C1C-CHC	-2.11	1.32	1.41

All (41) bond angle outliers are listed below:

Mol	Chain	Res	Type	Atoms	Z	Observed(°)	Ideal(°)
3	A	207	PP9	C1C-CHC-C4B	-12.86	113.45	128.81
3	A	207	PP9	C4C-CHD-C1D	-12.21	114.23	128.81
3	A	207	PP9	CMC-C2C-C3C	6.09	136.08	124.68
3	A	207	PP9	CMB-C2B-C1B	-5.60	116.44	125.06
4	B	208	Z0P	O3-C20-C21	4.78	121.80	111.50
3	A	207	PP9	CBA-CAA-C2A	4.03	119.91	112.48
3	A	207	PP9	CAA-CBA-CGA	3.93	119.27	112.67
3	A	207	PP9	CMD-C2D-C3D	3.61	135.91	126.12
3	A	207	PP9	CMD-C2D-C1D	-3.59	119.54	125.06
3	A	207	PP9	CMB-C2B-C3B	3.49	136.84	128.30
2	A	201	OLC	O20-C1-C2	3.42	122.66	111.91
4	B	208	Z0P	O2-C4-C5	3.16	121.81	111.91
3	A	207	PP9	CAD-CBD-CGD	-3.06	107.54	112.67
3	A	207	PP9	C2D-C1D-ND	3.04	114.38	109.79
2	B	204	OLC	O20-C1-C2	3.02	121.39	111.91
2	B	202	OLC	O20-C1-C2	3.02	121.38	111.91
2	A	203	OLC	O20-C1-C2	3.01	121.34	111.91
3	A	207	PP9	CHB-C1B-C2B	-2.90	117.43	124.90
2	A	205	OLC	O20-C1-C2	2.85	120.84	111.91
2	C	201	OLC	O20-C1-C2	2.78	120.63	111.91
2	B	201	OLC	O20-C1-C2	2.75	120.55	111.91
2	B	205	OLC	O20-C1-O19	-2.71	116.74	123.59
2	A	204	OLC	O20-C1-C2	2.71	120.42	111.91
3	A	207	PP9	CHB-C1B-NB	2.68	130.54	124.93
2	C	202	OLC	O20-C1-C2	2.55	119.91	111.91
2	B	203	OLC	O20-C1-O19	-2.54	117.17	123.59
2	C	204	OLC	O20-C1-C2	2.50	119.74	111.91
2	C	203	OLC	O20-C1-C2	2.45	119.59	111.91
5	C	205	P4C	O22-C21-C20	-2.45	118.99	126.39

*Continued on next page...*

*Continued from previous page...*

Mol	Chain	Res	Type	Atoms	Z	Observed(°)	Ideal(°)
2	B	207	OLC	O20-C1-C2	2.43	119.52	111.91
3	A	207	PP9	CHD-C1D-ND	-2.35	125.57	128.83
2	A	201	OLC	O20-C1-O19	-2.29	117.82	123.59
3	A	207	PP9	CHD-C1D-C2D	-2.27	120.02	125.73
2	A	206	OLC	O20-C1-C2	2.25	118.97	111.91
2	A	202	OLC	O20-C1-C2	2.22	118.87	111.91
2	B	204	OLC	O20-C1-O19	-2.15	118.16	123.59
2	A	203	OLC	O20-C1-O19	-2.14	118.18	123.59
2	B	206	OLC	O20-C1-C2	2.09	118.48	111.91
2	C	201	OLC	C21-C22-C24	-2.08	109.43	113.95
2	C	203	OLC	O20-C1-O19	-2.05	118.41	123.59
2	B	205	OLC	O20-C1-C2	2.03	118.27	111.91

All (1) chirality outliers are listed below:

Mol	Chain	Res	Type	Atom
4	B	208	Z0P	C2

All (196) torsion outliers are listed below:

Mol	Chain	Res	Type	Atoms
2	A	201	OLC	O20-C21-C22-O23
2	A	206	OLC	O20-C21-C22-C24
3	A	207	PP9	ND-C4D-CHA-C1A
3	A	207	PP9	NB-C4B-CHC-C1C
3	A	207	PP9	NC-C4C-CHD-C1D
3	A	207	PP9	C3C-C4C-CHD-C1D
2	B	202	OLC	C21-C22-C24-O25
2	B	205	OLC	C21-C22-C24-O25
2	C	203	OLC	C21-C22-C24-O25
2	B	207	OLC	C21-C22-C24-O25
2	C	202	OLC	C21-C22-C24-O25
4	B	208	Z0P	O4-C20-O3-C2
2	C	201	OLC	C11-C10-C9-C8
2	B	203	OLC	O19-C1-O20-C21
2	B	203	OLC	C2-C1-O20-C21
4	B	208	Z0P	C21-C20-O3-C2
2	A	201	OLC	C11-C10-C9-C8
2	B	202	OLC	C11-C10-C9-C8
2	C	202	OLC	C11-C10-C9-C8
2	C	204	OLC	O20-C21-C22-O23
3	A	207	PP9	C3D-C4D-CHA-C1A

*Continued on next page...*

*Continued from previous page...*

Mol	Chain	Res	Type	Atoms
2	A	202	OLC	O20-C21-C22-C24
2	A	206	OLC	O20-C21-C22-O23
2	C	203	OLC	C1-C2-C3-C4
4	B	208	Z0P	C5-C4-O2-C3
3	A	207	PP9	ND-C1D-CHD-C4C
2	B	204	OLC	C1-C2-C3-C4
2	C	201	OLC	C1-C2-C3-C4
5	C	205	P4C	O4-C5-C6-O7
4	B	208	Z0P	C4-C5-C6-C7
5	C	205	P4C	O7-C8-C9-O10
3	A	207	PP9	C4D-C3D-CAD-CBD
4	B	208	Z0P	O5-C4-O2-C3
2	B	206	OLC	O20-C21-C22-O23
2	C	202	OLC	O20-C21-C22-O23
2	A	202	OLC	O20-C21-C22-O23
2	B	203	OLC	C2-C3-C4-C5
2	A	201	OLC	C3-C4-C5-C6
2	C	201	OLC	C13-C14-C15-C16
3	A	207	PP9	C2D-C3D-CAD-CBD
2	A	201	OLC	O20-C21-C22-C24
2	B	206	OLC	O20-C21-C22-C24
2	A	201	OLC	C2-C3-C4-C5
2	C	203	OLC	C2-C3-C4-C5
2	C	203	OLC	C14-C15-C16-C17
2	A	202	OLC	C11-C12-C13-C14
2	A	203	OLC	C11-C10-C9-C8
2	C	203	OLC	C11-C10-C9-C8
5	C	205	P4C	O16-C17-C18-O19
2	B	204	OLC	C2-C3-C4-C5
4	B	208	Z0P	C10-C11-C12-C13
2	B	205	OLC	C5-C6-C7-C8
2	B	205	OLC	C13-C14-C15-C16
2	B	205	OLC	C4-C5-C6-C7
2	C	203	OLC	C13-C14-C15-C16
4	B	208	Z0P	C11-C12-C13-C14
2	C	203	OLC	C12-C13-C14-C15
2	B	203	OLC	C21-C22-C24-O25
2	A	206	OLC	C6-C7-C8-C9
2	C	202	OLC	C10-C11-C12-C13
4	B	208	Z0P	C25-C26-C27-C28
2	A	202	OLC	C13-C14-C15-C16
4	B	208	Z0P	C24-C25-C26-C27

*Continued on next page...*

*Continued from previous page...*

Mol	Chain	Res	Type	Atoms
4	B	208	Z0P	C6-C7-C8-C9
2	A	206	OLC	C5-C6-C7-C8
2	B	205	OLC	C11-C10-C9-C8
4	B	208	Z0P	C21-C22-C23-C24
2	B	202	OLC	O23-C22-C24-O25
2	B	205	OLC	O23-C22-C24-O25
2	B	203	OLC	O23-C22-C24-O25
2	C	203	OLC	O23-C22-C24-O25
2	B	207	OLC	O23-C22-C24-O25
2	B	202	OLC	C13-C14-C15-C16
2	A	203	OLC	C6-C7-C8-C9
4	B	208	Z0P	C33-C34-C35-C36
2	B	201	OLC	C4-C5-C6-C7
2	A	202	OLC	C3-C4-C5-C6
2	A	205	OLC	C1-C2-C3-C4
2	A	202	OLC	C5-C6-C7-C8
2	C	201	OLC	C11-C12-C13-C14
2	A	206	OLC	C10-C11-C12-C13
4	B	208	Z0P	C31-C32-C33-C34
2	B	206	OLC	C2-C1-O20-C21
2	A	202	OLC	C14-C15-C16-C17
2	A	202	OLC	C1-C2-C3-C4
2	C	202	OLC	O20-C21-C22-C24
2	A	201	OLC	C1-C2-C3-C4
3	A	207	PP9	C3B-C4B-CHC-C1C
3	A	207	PP9	C2D-C1D-CHD-C4C
2	C	202	OLC	C6-C7-C8-C9
2	B	201	OLC	C14-C15-C16-C17
2	B	207	OLC	C2-C1-O20-C21
2	A	205	OLC	O20-C21-C22-O23
2	B	202	OLC	C5-C6-C7-C8
2	C	202	OLC	C3-C4-C5-C6
6	C	206	MOE	O2'-CA'-CB'-OC'
2	A	206	OLC	C11-C10-C9-C8
2	B	203	OLC	C11-C10-C9-C8
2	B	201	OLC	C13-C14-C15-C16
2	B	203	OLC	C4-C5-C6-C7
2	A	206	OLC	C3-C4-C5-C6
2	C	202	OLC	C5-C6-C7-C8
2	C	202	OLC	O23-C22-C24-O25
2	A	204	OLC	C5-C6-C7-C8
2	B	202	OLC	C2-C1-O20-C21

*Continued on next page...*

*Continued from previous page...*

Mol	Chain	Res	Type	Atoms
2	C	204	OLC	C7-C8-C9-C10
2	C	203	OLC	C2-C1-O20-C21
2	B	202	OLC	O19-C1-O20-C21
2	A	204	OLC	O19-C1-O20-C21
2	A	204	OLC	C7-C8-C9-C10
2	C	202	OLC	C2-C1-O20-C21
2	A	201	OLC	C11-C12-C13-C14
2	C	202	OLC	C14-C15-C16-C17
2	A	204	OLC	C2-C1-O20-C21
2	B	202	OLC	C12-C13-C14-C15
2	C	201	OLC	C2-C3-C4-C5
2	A	204	OLC	C9-C10-C11-C12
4	B	208	Z0P	C34-C35-C36-C37
2	A	203	OLC	C11-C12-C13-C14
2	A	202	OLC	C2-C3-C4-C5
2	C	202	OLC	C12-C13-C14-C15
2	B	203	OLC	C14-C15-C16-C17
2	B	201	OLC	C5-C6-C7-C8
2	C	204	OLC	O23-C22-C24-O25
2	A	206	OLC	C12-C13-C14-C15
2	B	202	OLC	C2-C3-C4-C5
4	B	208	Z0P	O3-C2-C3-O2
4	B	208	Z0P	O1-C1-C2-C3
2	B	202	OLC	C6-C7-C8-C9
4	B	208	Z0P	C7-C8-C9-C10
2	A	206	OLC	C4-C5-C6-C7
4	B	208	Z0P	O1-C1-C2-O3
2	A	202	OLC	C2-C1-O20-C21
4	B	208	Z0P	C1-C2-C3-O2
2	C	201	OLC	C2-C1-O20-C21
2	C	201	OLC	O20-C21-C22-C24
5	C	205	P4C	C2-C3-O4-C5
2	A	206	OLC	O19-C1-O20-C21
2	B	205	OLC	O19-C1-O20-C21
2	B	201	OLC	C6-C7-C8-C9
2	A	202	OLC	C15-C16-C17-C18
2	A	205	OLC	C4-C5-C6-C7
2	B	202	OLC	C4-C5-C6-C7
2	B	203	OLC	C12-C13-C14-C15
2	C	204	OLC	O20-C21-C22-C24
2	B	205	OLC	C10-C11-C12-C13
2	B	206	OLC	C2-C3-C4-C5

*Continued on next page...*

*Continued from previous page...*

Mol	Chain	Res	Type	Atoms
2	A	201	OLC	C5-C6-C7-C8
2	A	203	OLC	C12-C13-C14-C15
2	B	202	OLC	O20-C21-C22-O23
2	A	203	OLC	C13-C14-C15-C16
2	B	204	OLC	C3-C4-C5-C6
2	B	203	OLC	C7-C8-C9-C10
2	B	205	OLC	C2-C3-C4-C5
2	C	202	OLC	C7-C8-C9-C10
2	A	206	OLC	C11-C12-C13-C14
2	C	204	OLC	C9-C10-C11-C12
2	B	205	OLC	C15-C16-C17-C18
2	A	203	OLC	C2-C1-O20-C21
2	C	201	OLC	C21-C22-C24-O25
2	B	207	OLC	O19-C1-O20-C21
2	C	201	OLC	O19-C1-O20-C21
2	C	204	OLC	C15-C16-C17-C18
4	B	208	Z0P	C16-C17-C18-C19
5	C	205	P4C	C5-C6-O7-C8
2	C	203	OLC	C11-C12-C13-C14
4	B	208	Z0P	C32-C33-C34-C35
2	B	202	OLC	C10-C11-C12-C13
2	B	205	OLC	C7-C8-C9-C10
2	C	202	OLC	C2-C3-C4-C5
2	C	204	OLC	C21-C22-C24-O25
5	C	205	P4C	C9-C8-O7-C6
2	A	201	OLC	C7-C8-C9-C10
2	A	203	OLC	C7-C8-C9-C10
2	A	203	OLC	C10-C11-C12-C13
2	A	204	OLC	C15-C16-C17-C18
2	C	204	OLC	C4-C5-C6-C7
2	A	206	OLC	O20-C1-C2-C3
2	B	203	OLC	C6-C7-C8-C9
2	B	205	OLC	C9-C10-C11-C12
2	A	202	OLC	C9-C10-C11-C12
2	B	203	OLC	O20-C21-C22-C24
2	B	201	OLC	C7-C8-C9-C10
2	A	206	OLC	O19-C1-C2-C3
2	B	204	OLC	O19-C1-C2-C3
2	A	202	OLC	C4-C5-C6-C7
2	A	205	OLC	C5-C6-C7-C8
2	B	205	OLC	O19-C1-C2-C3
2	C	204	OLC	C1-C2-C3-C4

*Continued on next page...*



*Continued from previous page...*

Mol	Chain	Res	Type	Atoms
2	B	204	OLC	O20-C1-C2-C3
4	B	208	Z0P	C20-C21-C22-C23
2	A	203	OLC	O23-C22-C24-O25
4	B	208	Z0P	C14-C15-C16-C17
2	C	203	OLC	C15-C16-C17-C18
2	B	203	OLC	O19-C1-C2-C3
2	B	205	OLC	O20-C1-C2-C3

There are no ring outliers.

17 monomers are involved in 59 short contacts:

Mol	Chain	Res	Type	Clashes	Symm-Clashes
2	A	201	OLC	5	0
2	A	206	OLC	4	0
2	A	205	OLC	1	0
2	B	201	OLC	1	0
6	C	206	MOE	2	0
5	C	205	P4C	2	0
2	B	202	OLC	3	0
2	B	205	OLC	1	0
2	A	203	OLC	2	0
2	B	203	OLC	1	0
2	C	204	OLC	6	0
3	A	207	PP9	31	0
2	C	202	OLC	1	0
4	B	208	Z0P	1	0
2	B	207	OLC	1	0
2	A	202	OLC	3	0
2	C	201	OLC	2	0

The following is a two-dimensional graphical depiction of Mogul quality analysis of bond lengths, bond angles, torsion angles, and ring geometry for all instances of the Ligand of Interest. In addition, ligands with molecular weight > 250 and outliers as shown on the validation Tables will also be included. For torsion angles, if less than 5% of the Mogul distribution of torsion angles is within 10 degrees of the torsion angle in question, then that torsion angle is considered an outlier. Any bond that is central to one or more torsion angles identified as an outlier by Mogul will be highlighted in the graph. For rings, the root-mean-square deviation (RMSD) between the ring in question and similar rings identified by Mogul is calculated over all ring torsion angles. If the average RMSD is greater than 60 degrees and the minimal RMSD between the ring in question and any Mogul-identified rings is also greater than 60 degrees, then that ring is considered an outlier. The outliers are highlighted in purple. The color gray indicates Mogul did not find sufficient equivalents in the CSD to analyse the geometry.

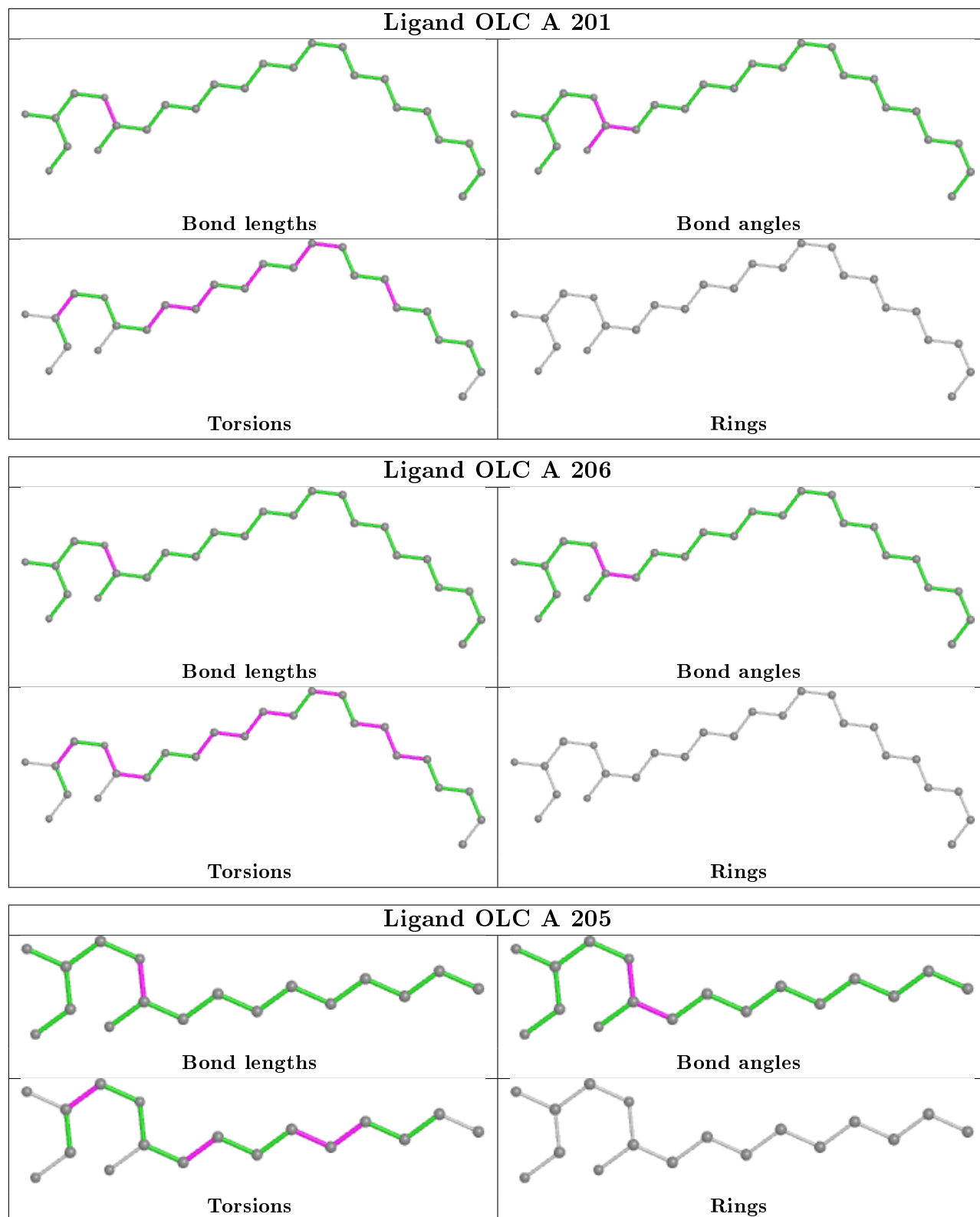

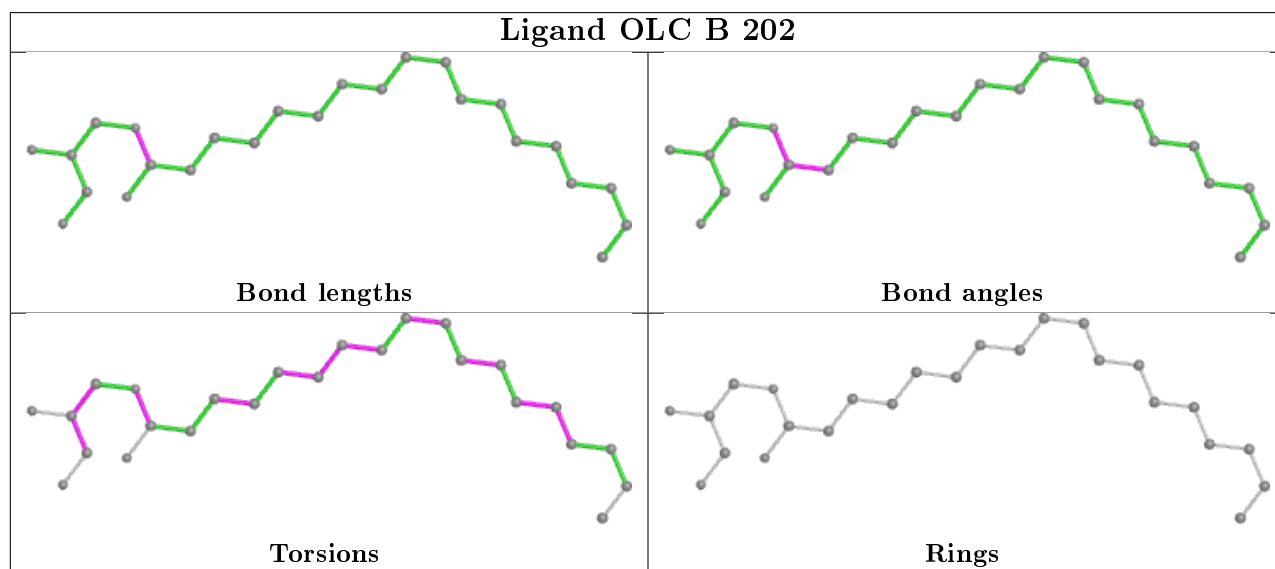
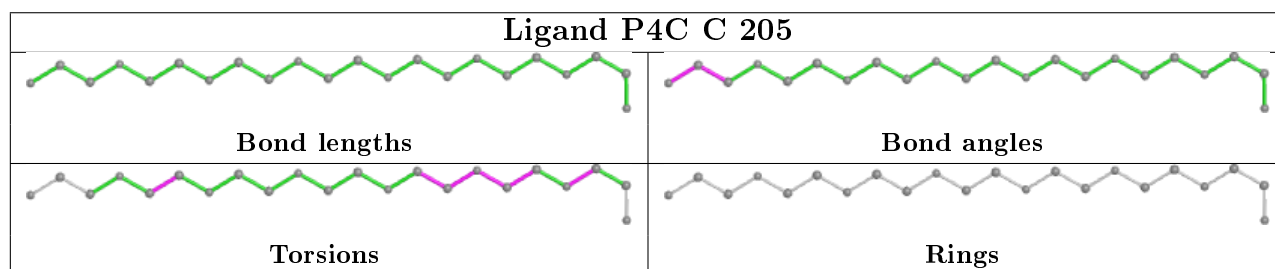
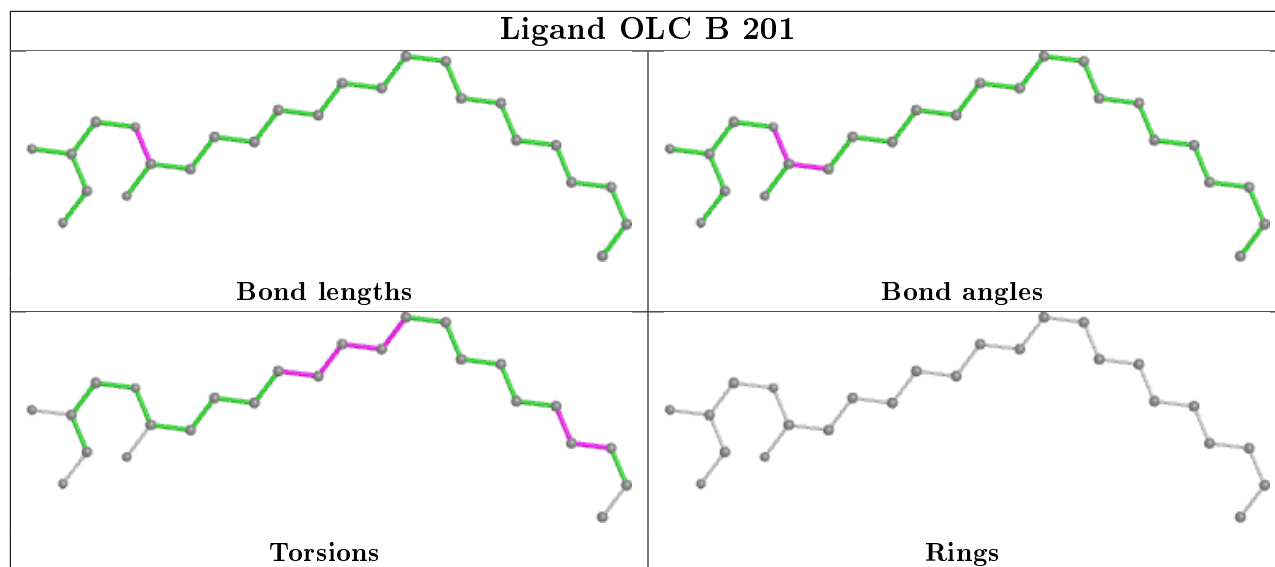

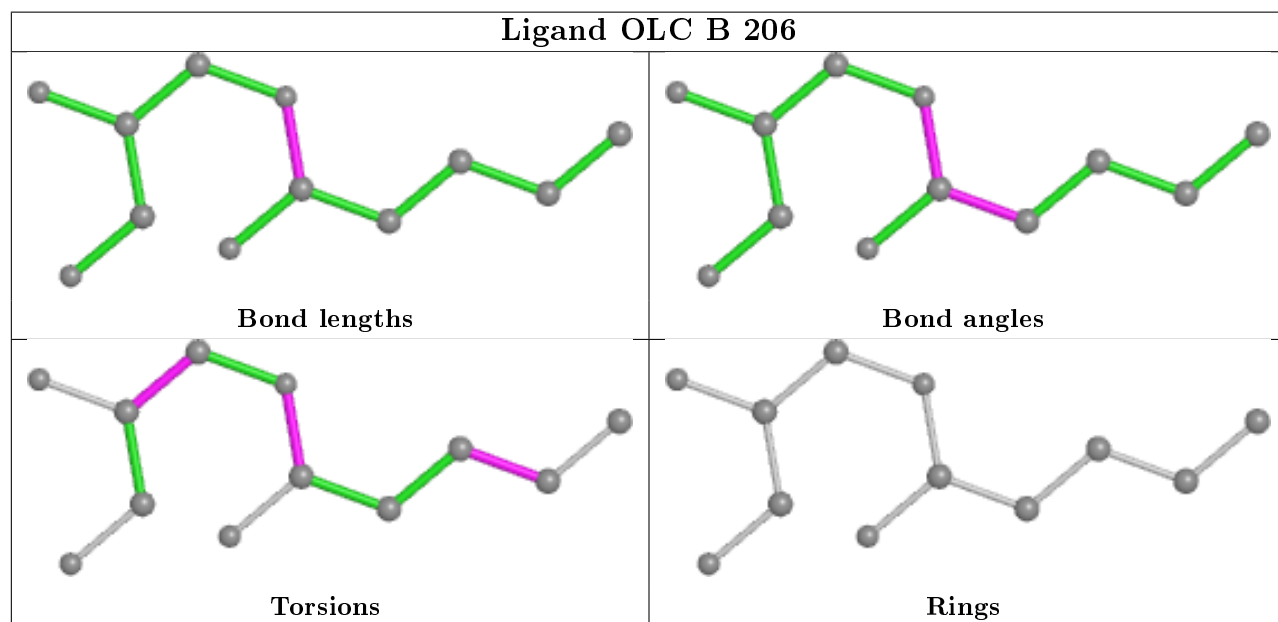
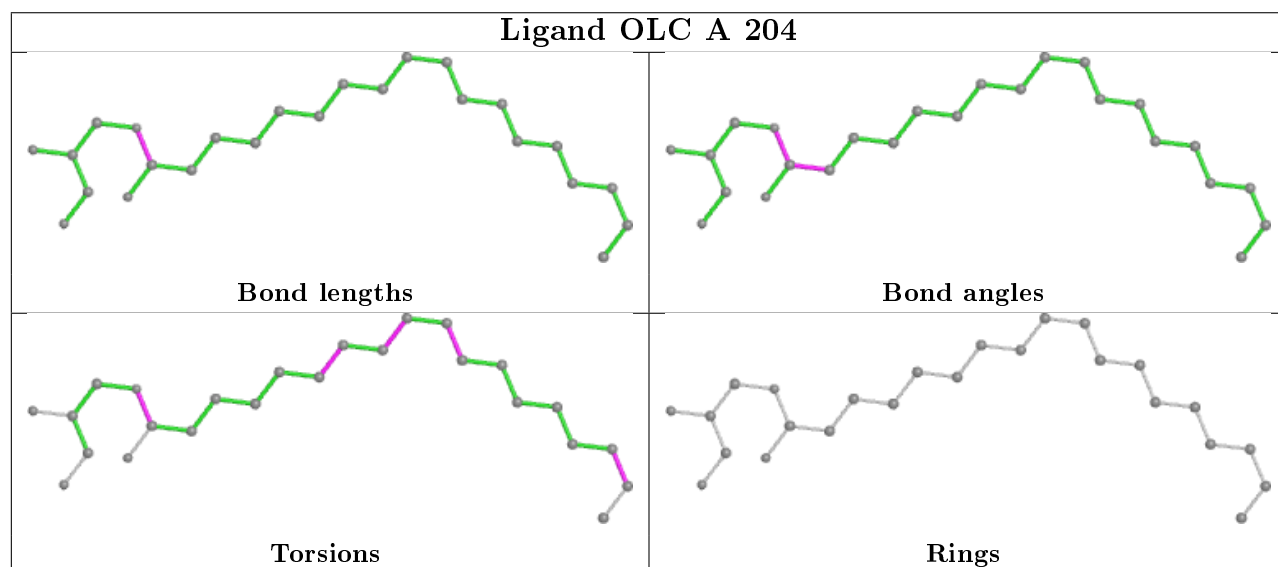
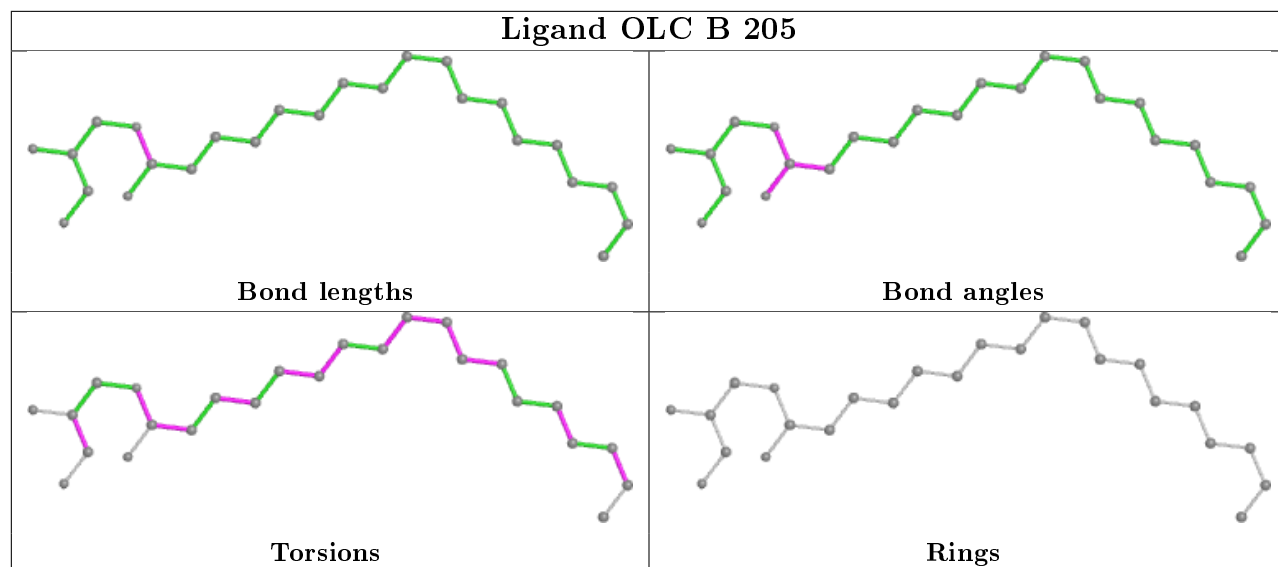

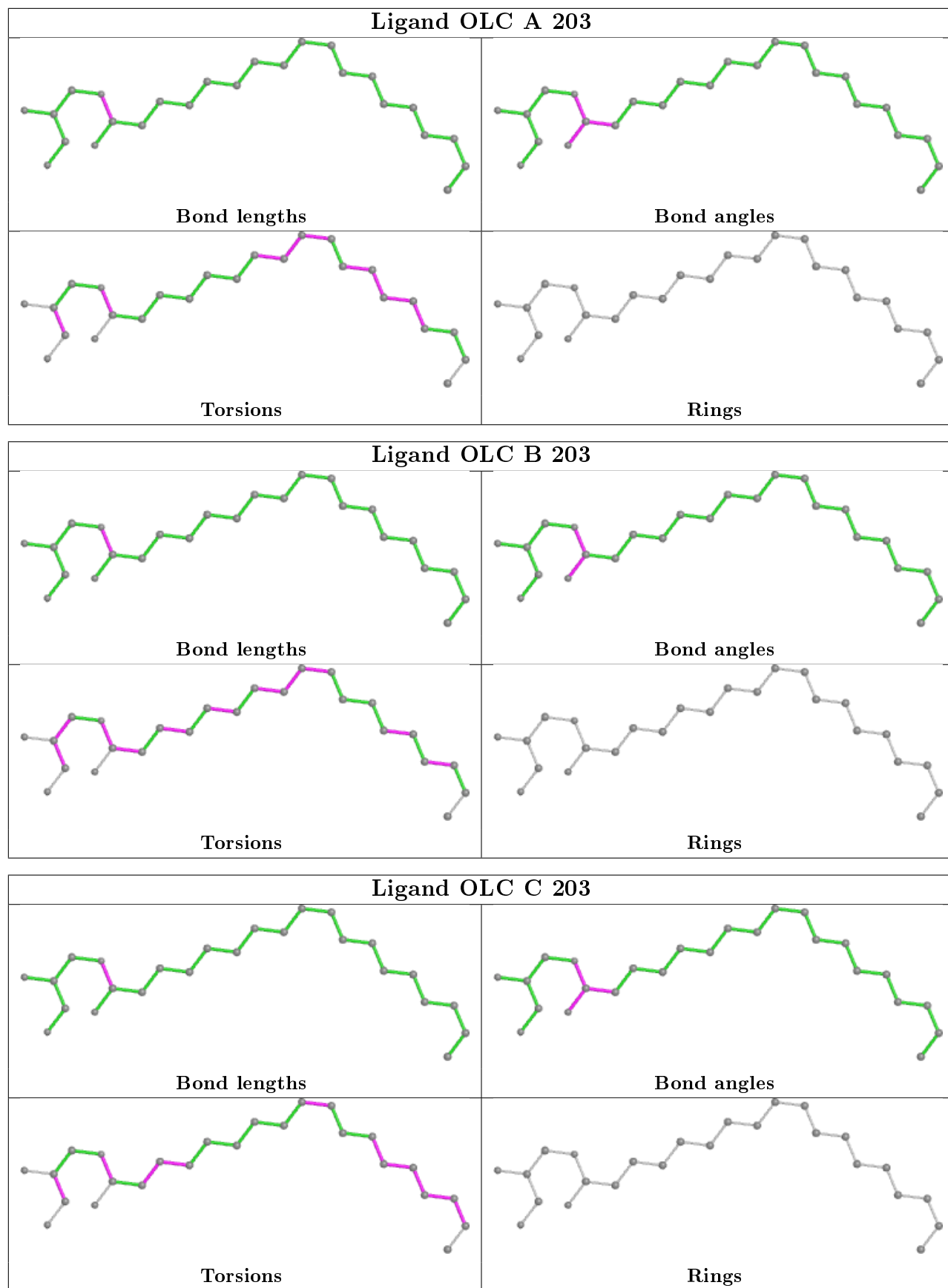

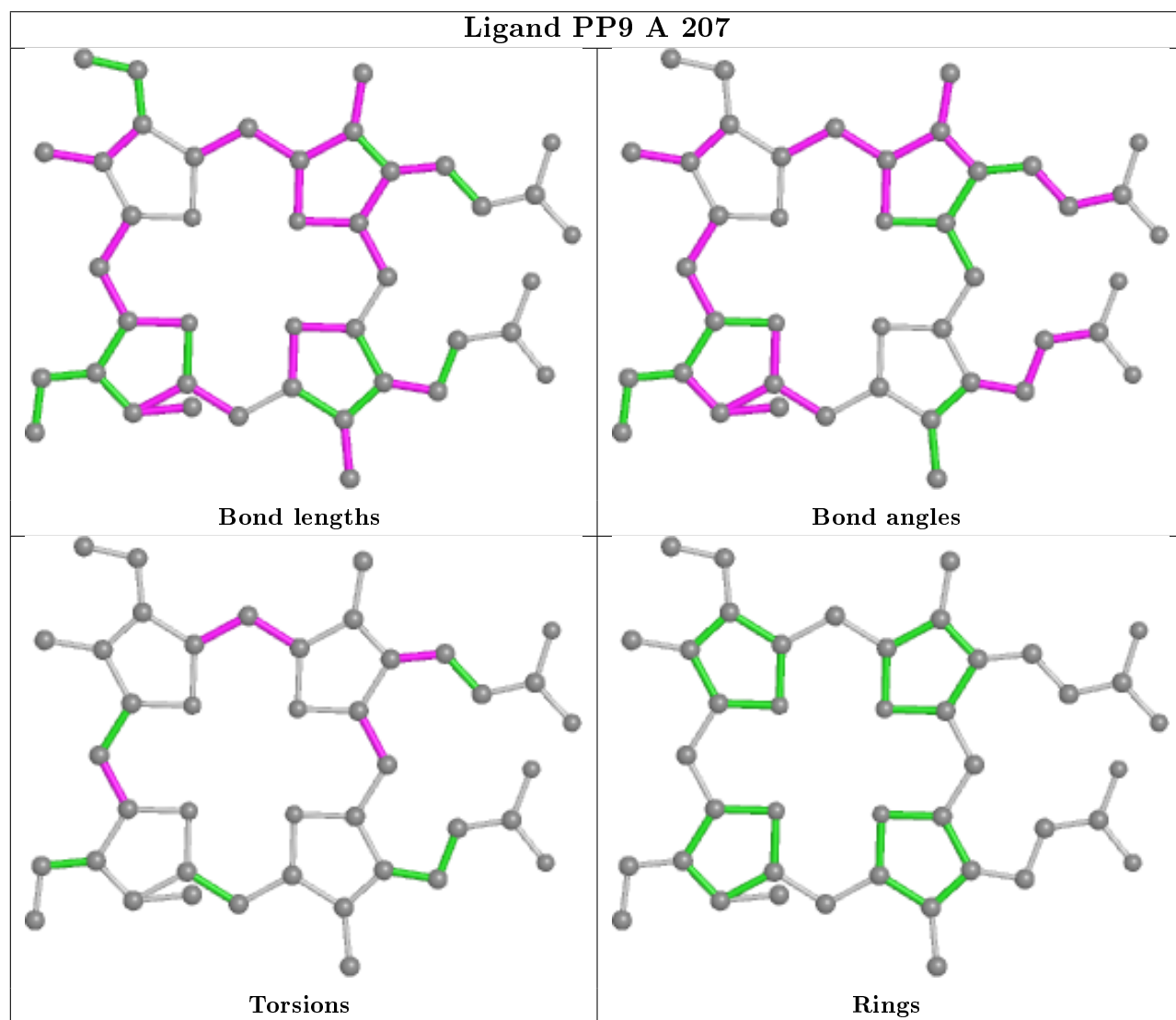
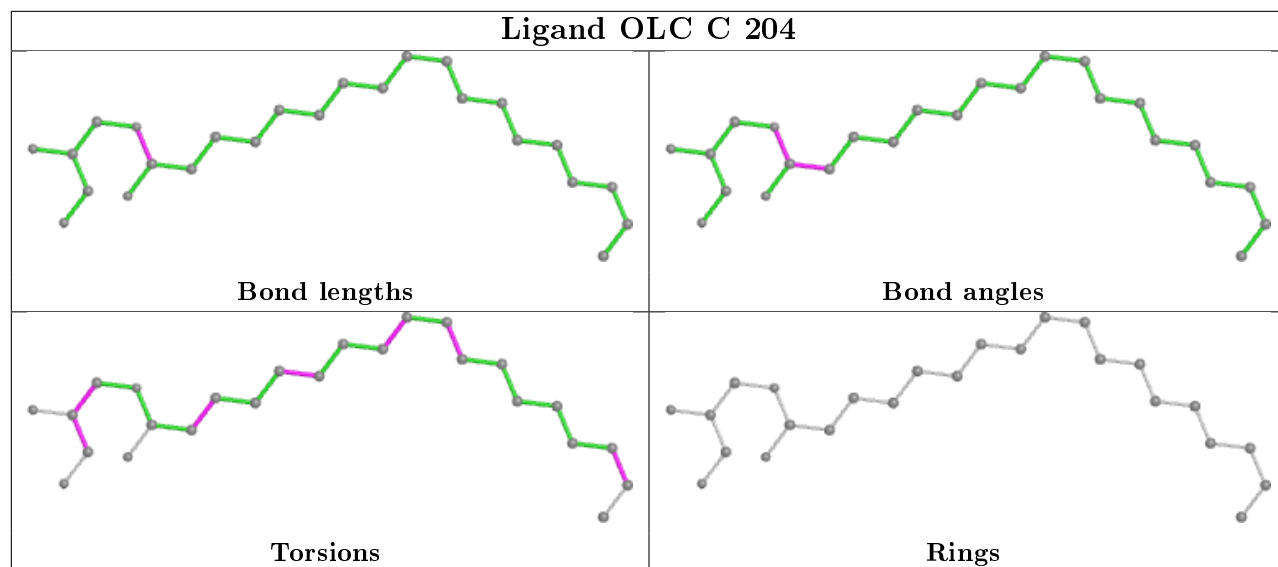

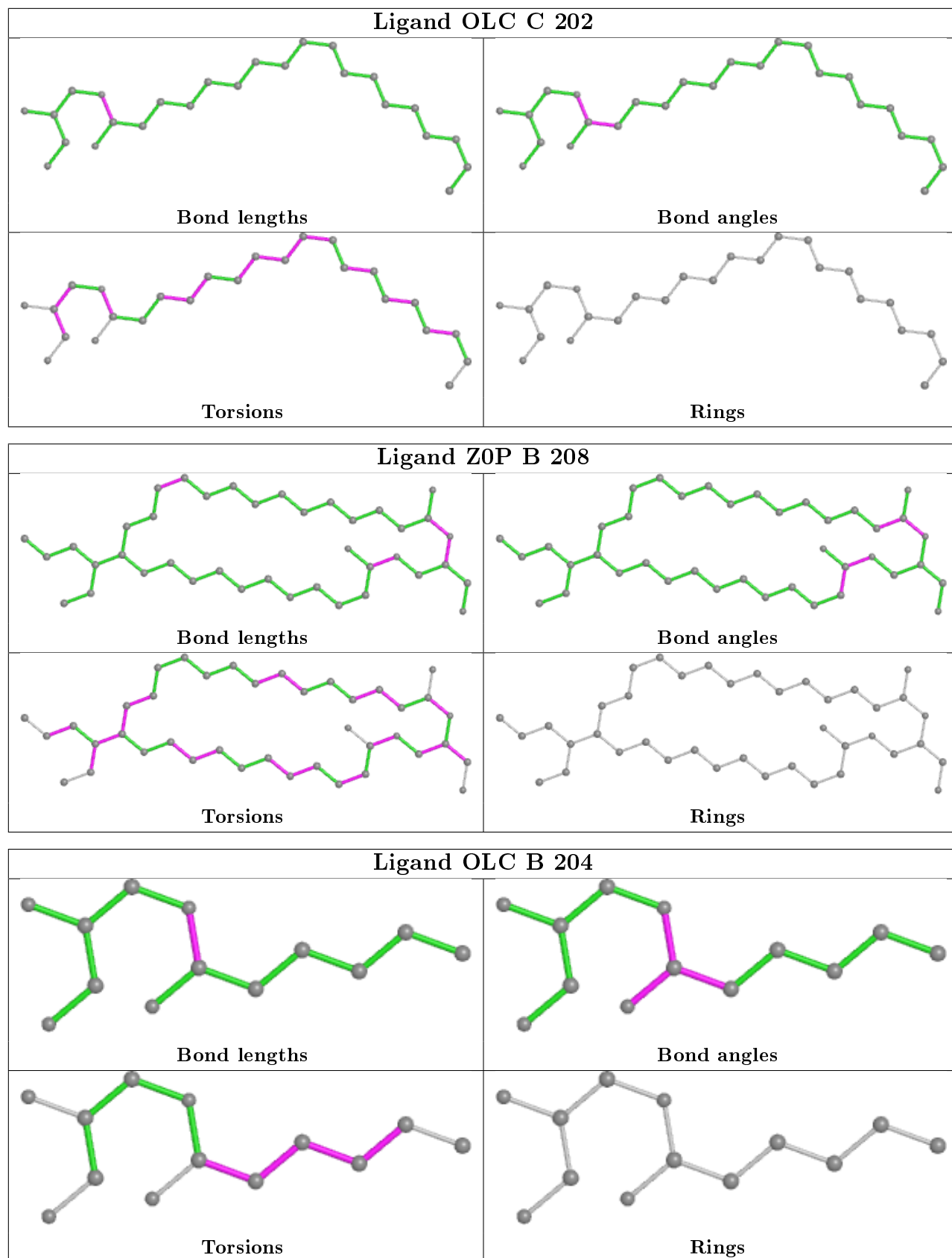

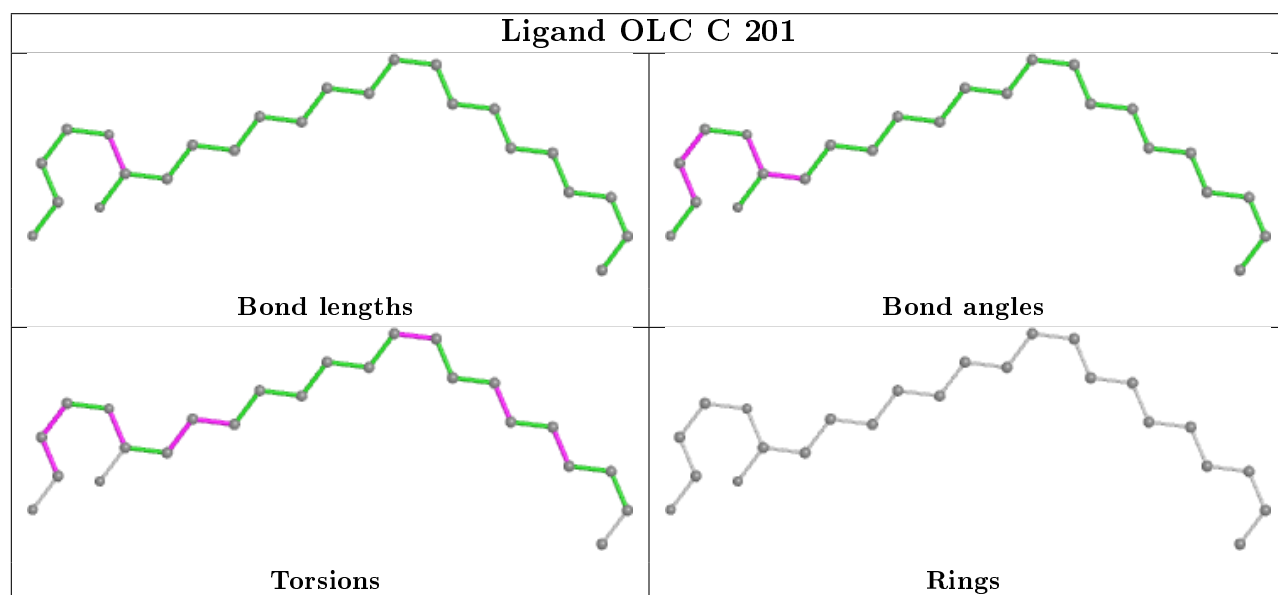
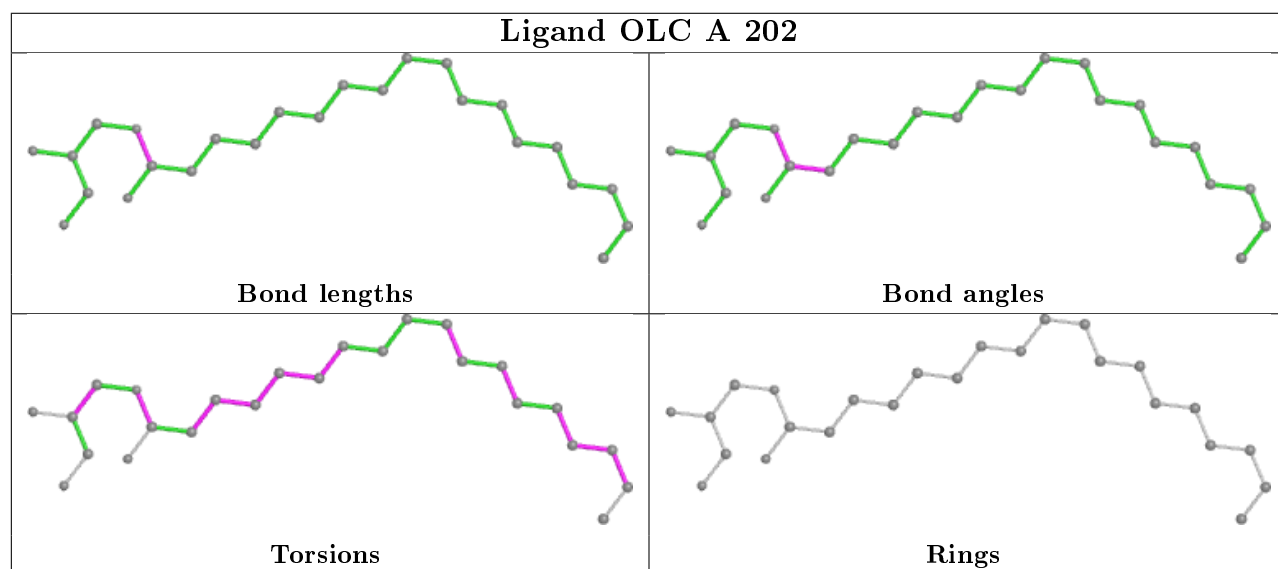
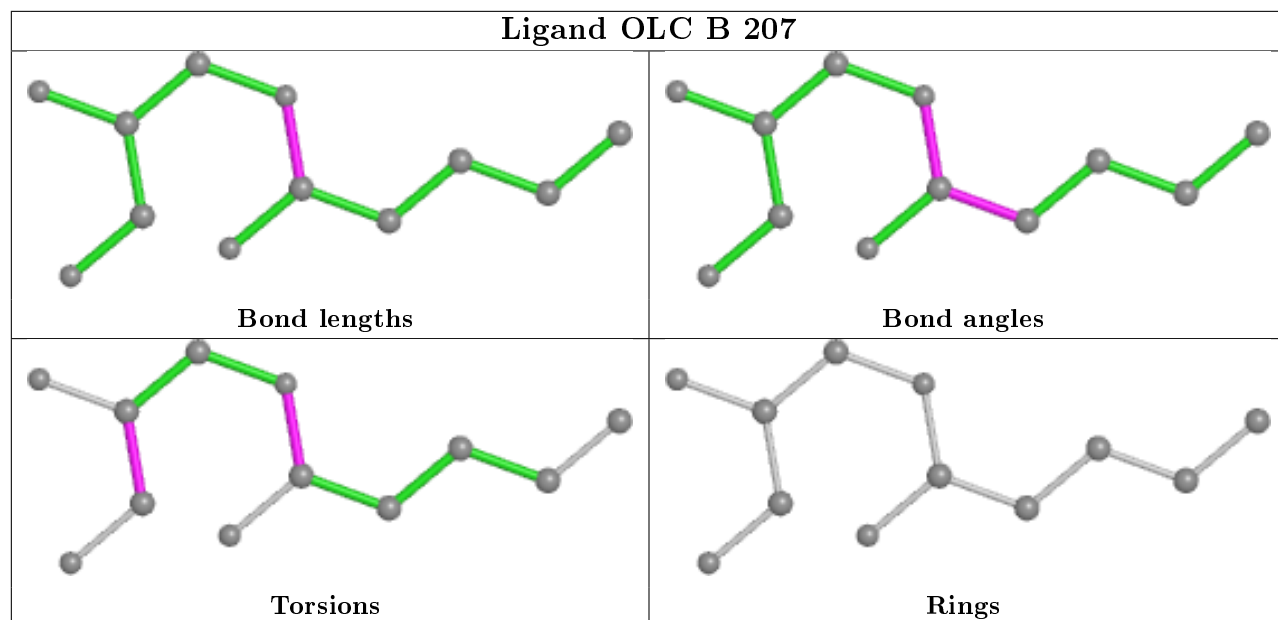



## 5.7 Other polymers

There are no such residues in this entry.

## 5.8 Polymer linkage issues

There are no chain breaks in this entry.

## 6 Fit of model and data [i](#)

### 6.1 Protein, DNA and RNA chains [i](#)

In the following table, the column labelled ‘#RSRZ> 2’ contains the number (and percentage) of RSRZ outliers, followed by percent RSRZ outliers for the chain as percentile scores relative to all X-ray entries and entries of similar resolution. The OWAB column contains the minimum, median, 95<sup>th</sup> percentile and maximum values of the occupancy-weighted average B-factor per residue. The column labelled ‘Q< 0.9’ lists the number of (and percentage) of residues with an average occupancy less than 0.9.

Mol	Chain	Analysed	<RSRZ>	#RSRZ>2	OWAB(Å <sup>2</sup> )	Q<0.9
1	A	157/157 (100%)	-0.21	3 (1%) 66 63	19, 25, 43, 68	0
1	B	156/157 (99%)	-0.41	3 (1%) 66 63	18, 30, 47, 60	0
1	C	149/157 (94%)	-0.03	9 (6%) 21 17	19, 30, 55, 74	0
All	All	462/471 (98%)	-0.22	15 (3%) 47 41	18, 28, 50, 74	0

All (15) RSRZ outliers are listed below:

Mol	Chain	Res	Type	RSRZ
1	C	27	PRO	4.7
1	A	156	ALA	4.1
1	A	157	ARG	3.9
1	C	91	PHE	3.5
1	B	2	ASN	3.4
1	C	26	LYS	3.4
1	B	28	ASP	3.0
1	C	28	ASP	3.0
1	C	2	ASN	2.9
1	C	29	GLU	2.7
1	C	35	ASN	2.5
1	C	148	ARG	2.5
1	C	38	TRP	2.4
1	B	5	TRP	2.1
1	A	147[A]	MET	2.1

### 6.2 Non-standard residues in protein, DNA, RNA chains [i](#)

There are no non-standard protein/DNA/RNA residues in this entry.

## 6.3 Carbohydrates [i](#)

There are no carbohydrates in this entry.

## 6.4 Ligands [i](#)

In the following table, the Atoms column lists the number of modelled atoms in the group and the number defined in the chemical component dictionary. The B-factors column lists the minimum, median, 95<sup>th</sup> percentile and maximum values of B factors of atoms in the group. The column labelled 'Q< 0.9' lists the number of atoms with occupancy less than 0.9.

Mol	Type	Chain	Res	Atoms	RSCC	RSR	B-factors(Å <sup>2</sup> )	Q<0.9
2	OLC	A	203	25/25	0.52	0.30	37,48,61,66	0
2	OLC	A	206	25/25	0.59	0.24	48,55,73,75	0
4	Z0P	B	208	42/42	0.59	0.23	29,44,61,66	0
2	OLC	A	205	17/25	0.60	0.20	34,45,64,68	0
2	OLC	B	201	25/25	0.64	0.28	36,53,72,80	0
2	OLC	A	204	25/25	0.65	0.17	43,53,64,70	0
2	OLC	B	202	25/25	0.66	0.22	39,46,56,69	0
2	OLC	B	207	12/25	0.67	0.27	56,64,71,73	0
2	OLC	C	202	25/25	0.68	0.23	36,47,59,68	0
3	PP9	A	207	42/42	0.68	0.47	20,38,45,48	42
2	OLC	C	204	25/25	0.69	0.21	45,52,57,58	0
2	OLC	B	204	13/25	0.69	0.27	59,64,68,70	0
2	OLC	B	203	25/25	0.70	0.24	40,52,58,61	0
2	OLC	A	202	25/25	0.71	0.28	44,53,58,66	0
2	OLC	B	205	25/25	0.73	0.28	40,52,58,64	0
2	OLC	C	203	25/25	0.73	0.23	37,48,62,64	0
2	OLC	C	201	24/25	0.82	0.14	36,45,58,59	0
2	OLC	A	201	25/25	0.83	0.18	27,42,51,54	0
5	P4C	C	205	22/22	0.84	0.17	41,51,59,64	0
2	OLC	B	206	12/25	0.84	0.24	33,47,58,59	0
6	MOE	C	206	5/5	0.86	0.16	32,36,45,48	0

The following is a graphical depiction of the model fit to experimental electron density of all instances of the Ligand of Interest. In addition, ligands with molecular weight > 250 and outliers as shown on the geometry validation Tables will also be included. Each fit is shown from different orientation to approximate a three-dimensional view.

**Electron density around OLC A 203:**

$2mF_o-DF_c$  (at 0.7 rmsd) in gray  
 $mF_o-DF_c$  (at 3 rmsd) in purple (negative)  
and green (positive)

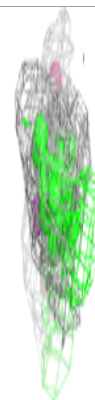
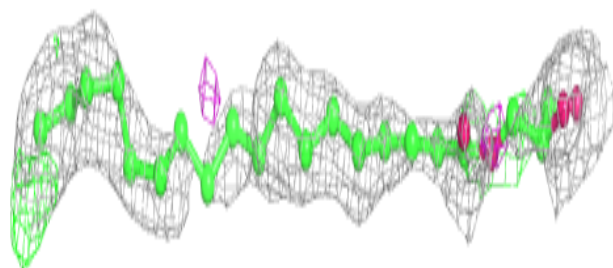
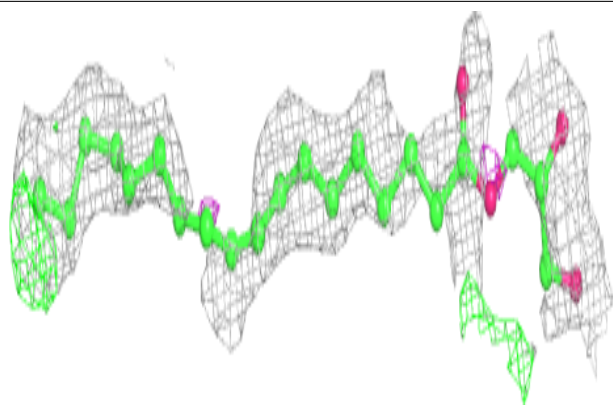
**Electron density around OLC A 206:**

$2mF_o-DF_c$  (at 0.7 rmsd) in gray  
 $mF_o-DF_c$  (at 3 rmsd) in purple (negative)  
and green (positive)

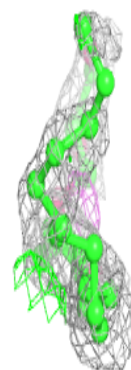
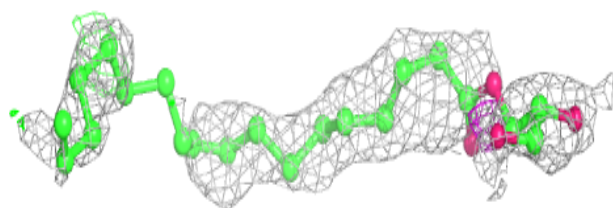
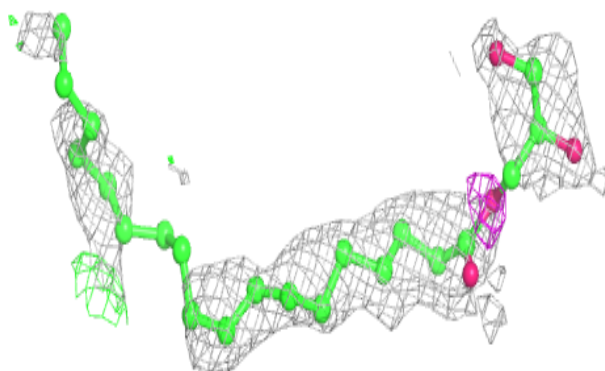

**Electron density around ZOP B 208:**

$2mF_o-DF_c$  (at 0.7 rmsd) in gray  
 $mF_o-DF_c$  (at 3 rmsd) in purple (negative)  
and green (positive)

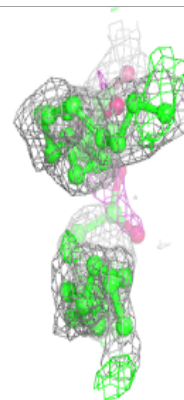
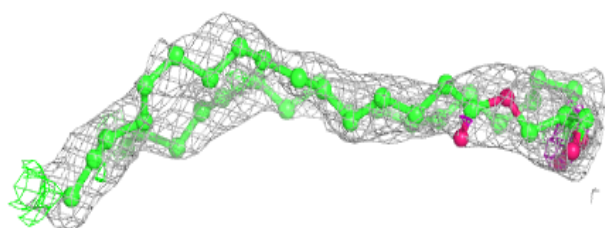
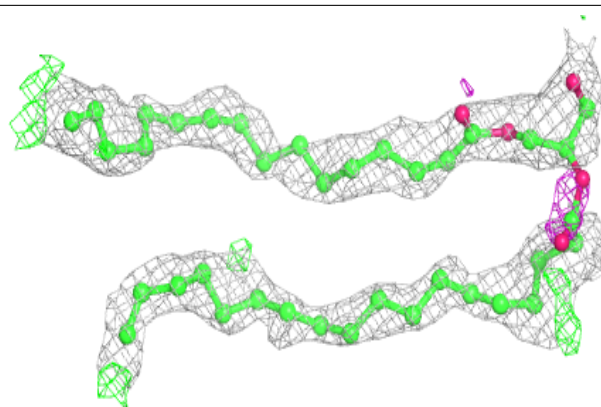
**Electron density around OLC A 205:**

$2mF_o-DF_c$  (at 0.7 rmsd) in gray  
 $mF_o-DF_c$  (at 3 rmsd) in purple (negative)  
and green (positive)

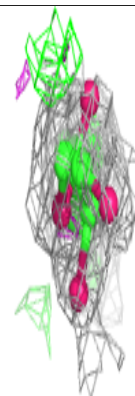
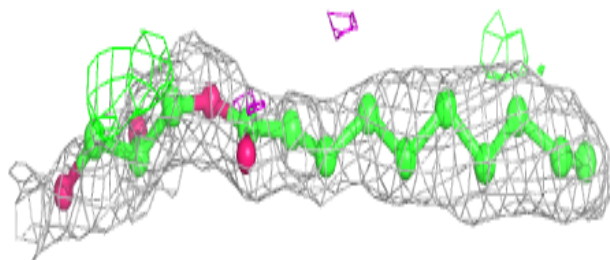
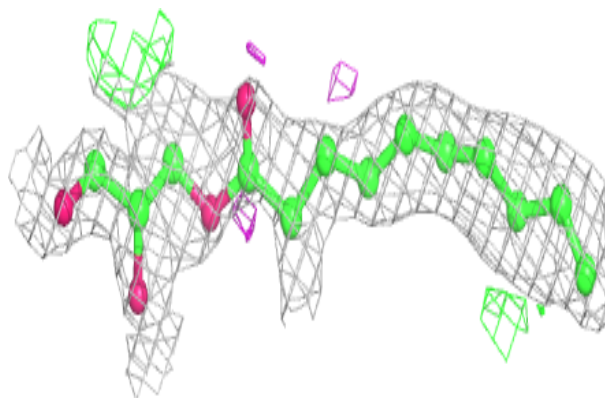

**Electron density around OLC B 201:**

$2mF_o-DF_c$  (at 0.7 rmsd) in gray  
 $mF_o-DF_c$  (at 3 rmsd) in purple (negative)  
and green (positive)

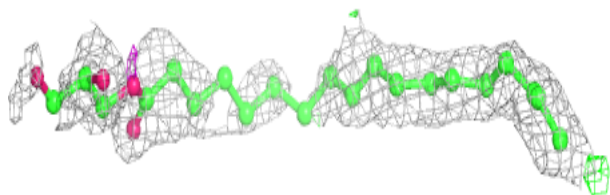
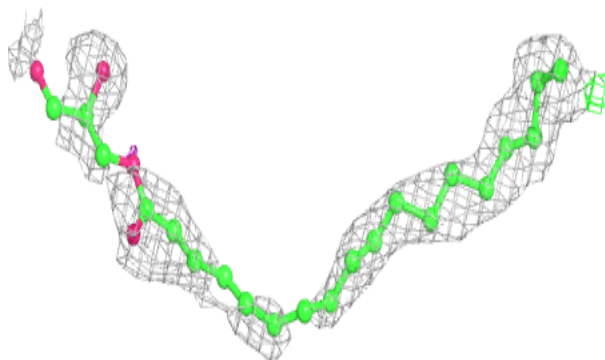
**Electron density around OLC A 204:**

$2mF_o-DF_c$  (at 0.7 rmsd) in gray  
 $mF_o-DF_c$  (at 3 rmsd) in purple (negative)  
and green (positive)

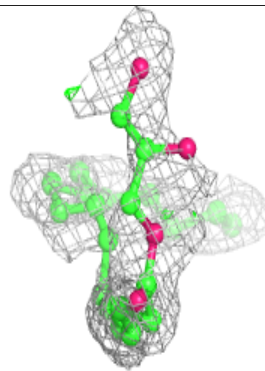
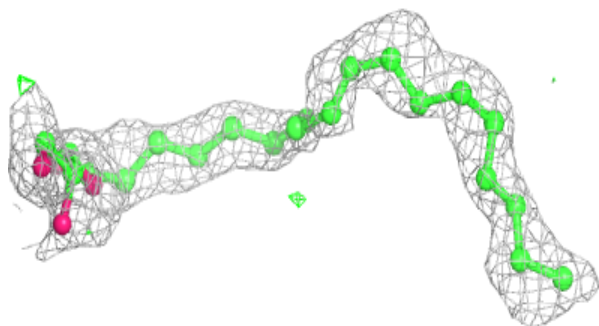
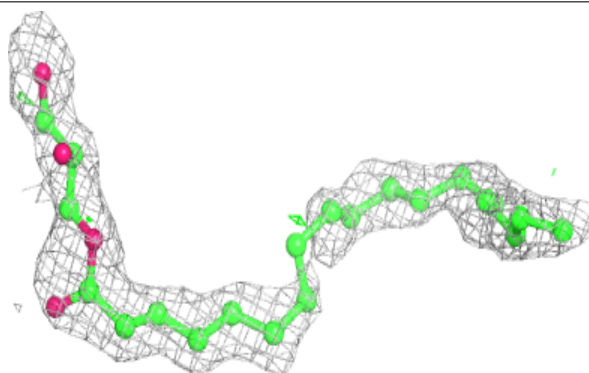

**Electron density around OLC B 202:**

$2mF_o-DF_c$  (at 0.7 rmsd) in gray  
 $mF_o-DF_c$  (at 3 rmsd) in purple (negative)  
and green (positive)

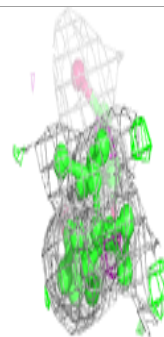
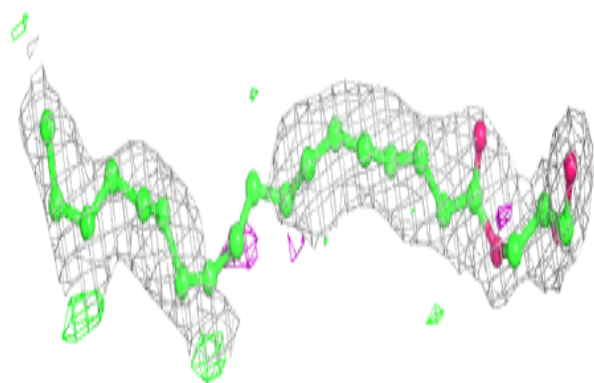
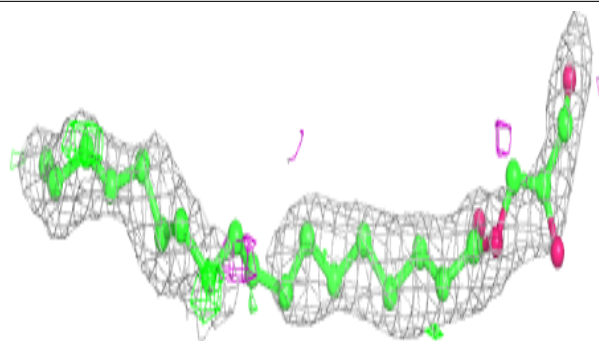
**Electron density around OLC B 207:**

$2mF_o-DF_c$  (at 0.7 rmsd) in gray  
 $mF_o-DF_c$  (at 3 rmsd) in purple (negative)  
and green (positive)

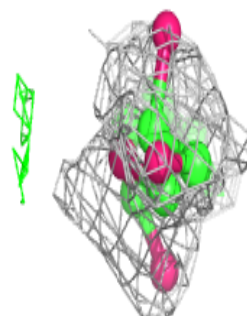
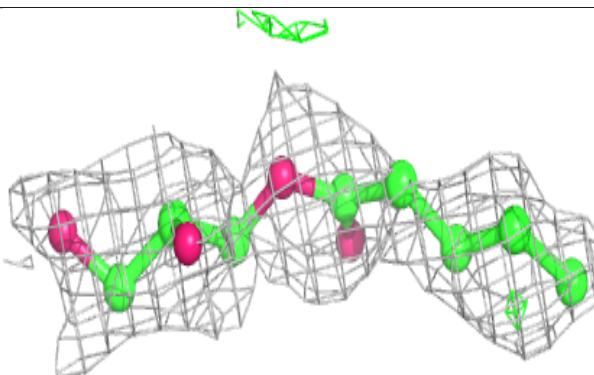
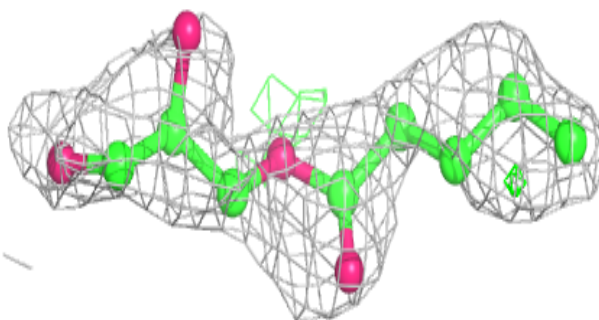

**Electron density around OLC C 202:**

$2mF_o-DF_c$  (at 0.7 rmsd) in gray  
 $mF_o-DF_c$  (at 3 rmsd) in purple (negative)  
and green (positive)

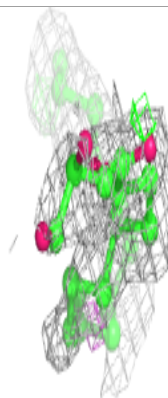
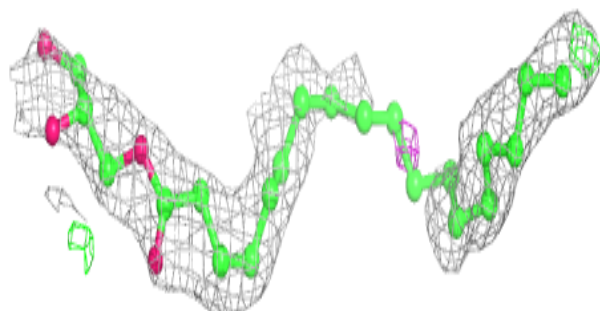
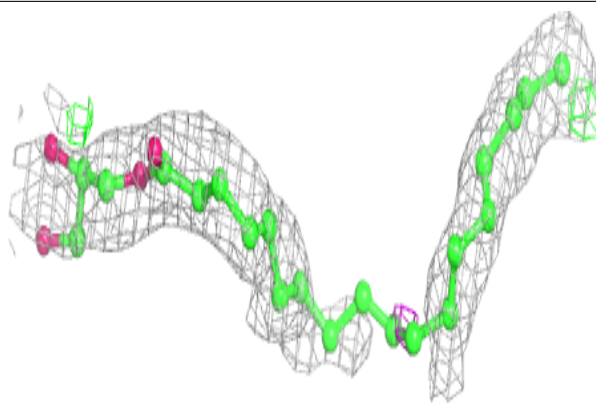



**Electron density around PP9 A 207:**

$2mF_o-DF_c$  (at 0.7 rmsd) in gray  
 $mF_o-DF_c$  (at 3 rmsd) in purple (negative)  
and green (positive)

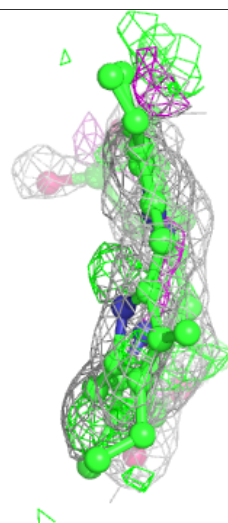
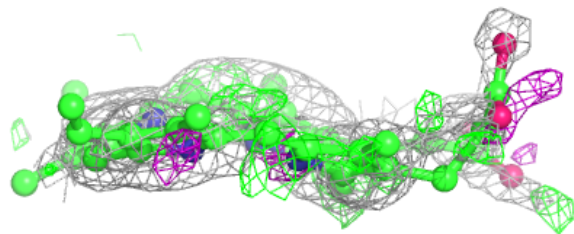
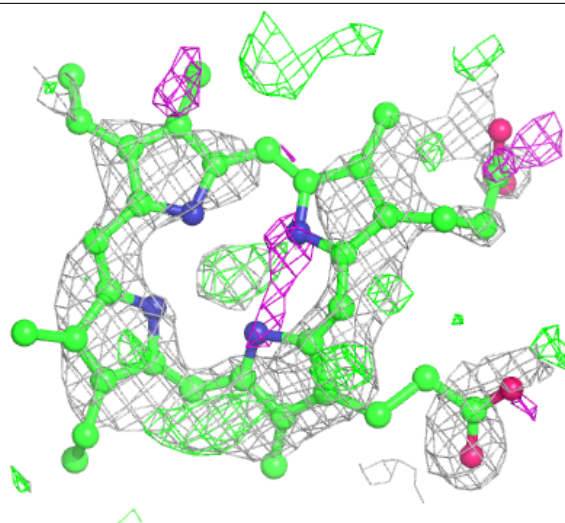

**Electron density around OLC C 204:**

$2mF_o-DF_c$  (at 0.7 rmsd) in gray  
 $mF_o-DF_c$  (at 3 rmsd) in purple (negative)  
and green (positive)

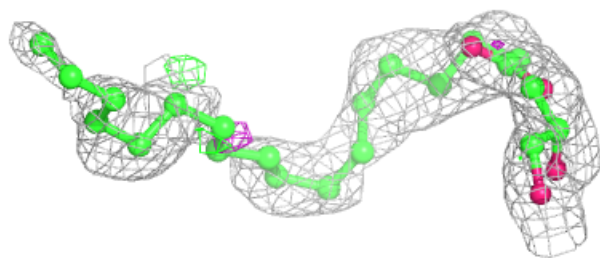
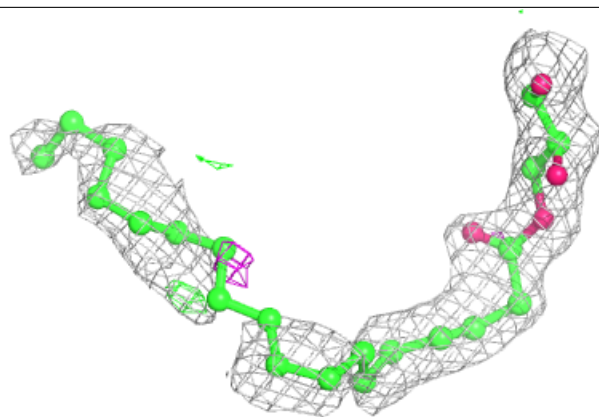
**Electron density around OLC B 204:**

$2mF_o-DF_c$  (at 0.7 rmsd) in gray  
 $mF_o-DF_c$  (at 3 rmsd) in purple (negative)  
and green (positive)

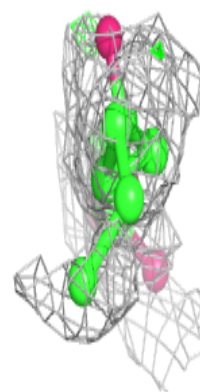
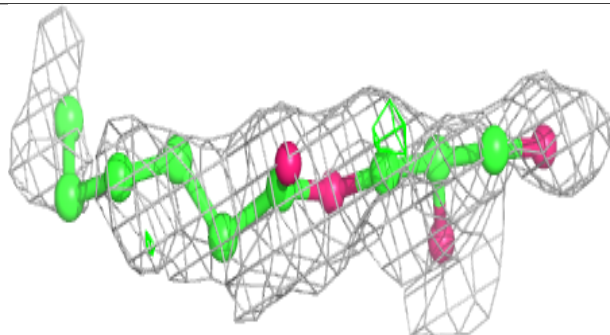
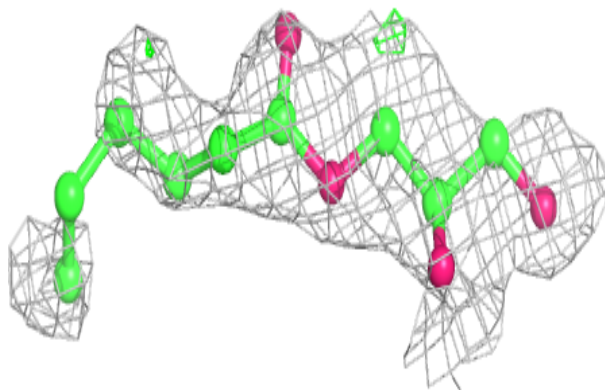

**Electron density around OLC B 203:**

$2mF_o-DF_c$  (at 0.7 rmsd) in gray  
 $mF_o-DF_c$  (at 3 rmsd) in purple (negative)  
and green (positive)

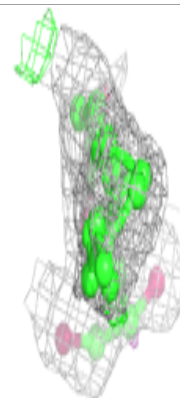
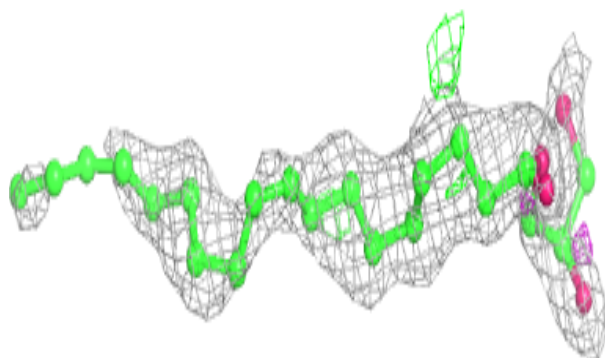
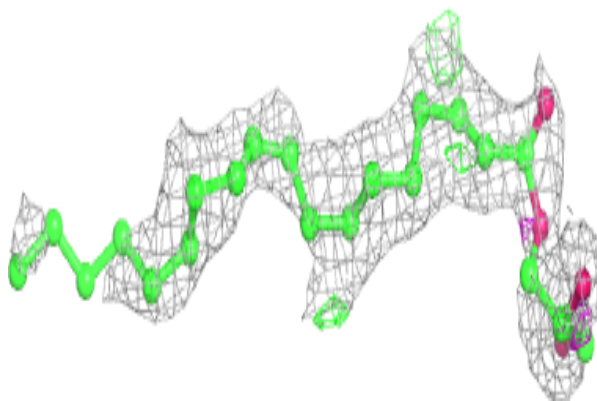
**Electron density around OLC A 202:**

$2mF_o-DF_c$  (at 0.7 rmsd) in gray  
 $mF_o-DF_c$  (at 3 rmsd) in purple (negative)  
and green (positive)

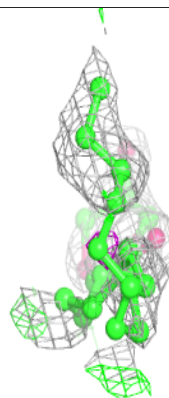
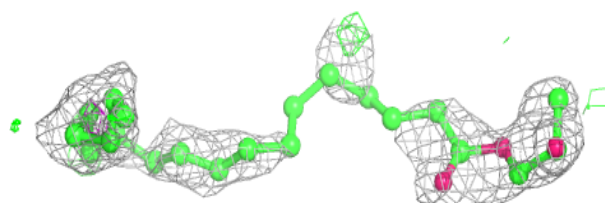
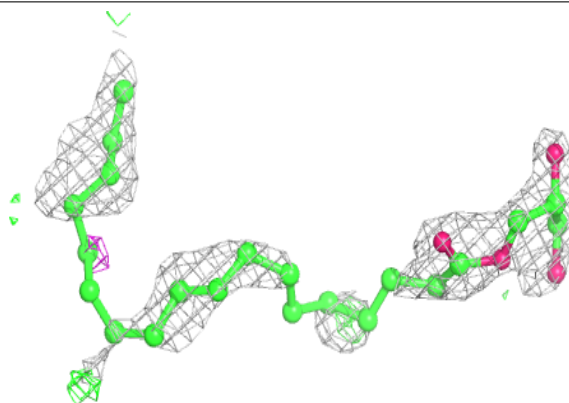

**Electron density around OLC B 205:**

$2mF_o-DF_c$  (at 0.7 rmsd) in gray  
 $mF_o-DF_c$  (at 3 rmsd) in purple (negative)  
and green (positive)

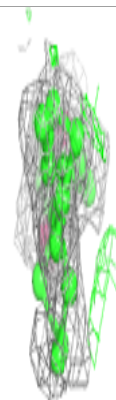
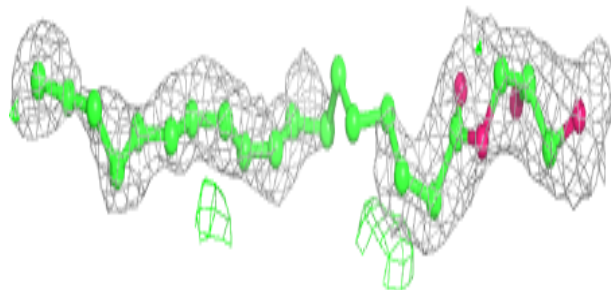
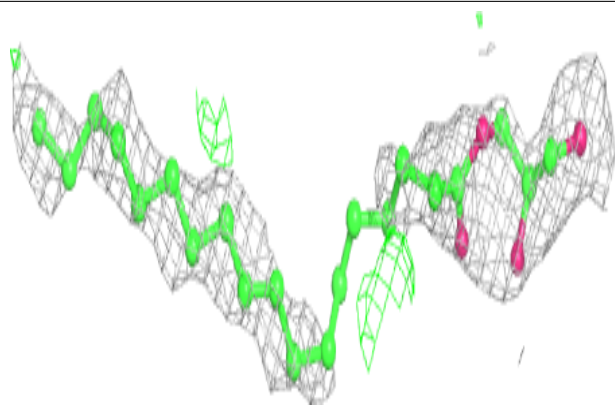
**Electron density around OLC C 203:**

$2mF_o-DF_c$  (at 0.7 rmsd) in gray  
 $mF_o-DF_c$  (at 3 rmsd) in purple (negative)  
and green (positive)

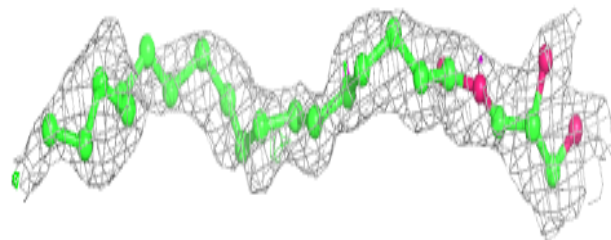
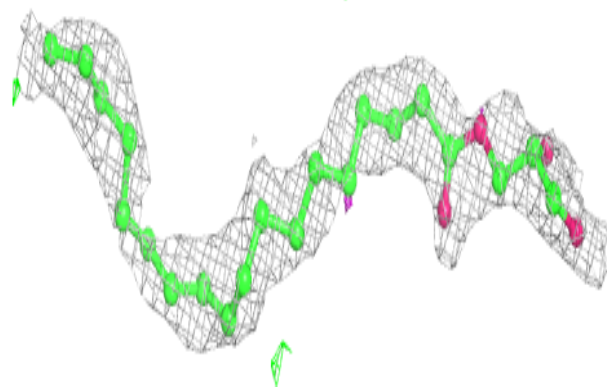

**Electron density around OLC C 201:**

$2mF_o-DF_c$  (at 0.7 rmsd) in gray  
 $mF_o-DF_c$  (at 3 rmsd) in purple (negative)  
and green (positive)

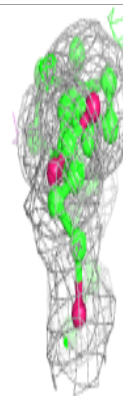
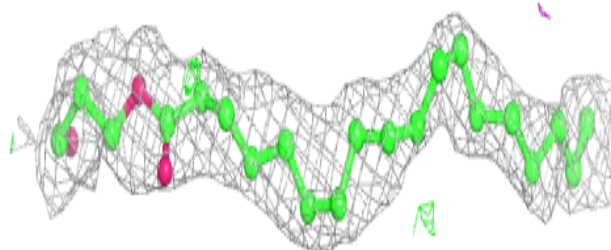
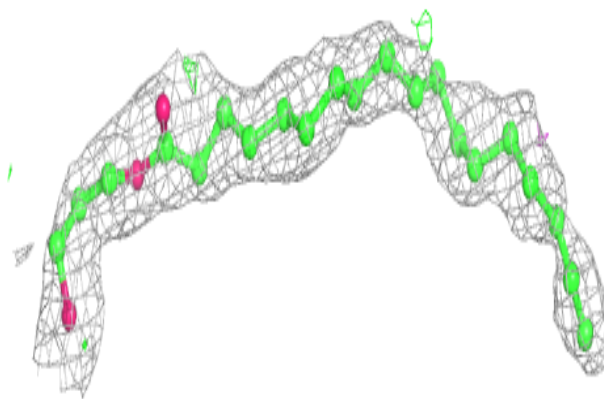
**Electron density around OLC A 201:**

$2mF_o-DF_c$  (at 0.7 rmsd) in gray  
 $mF_o-DF_c$  (at 3 rmsd) in purple (negative)  
and green (positive)

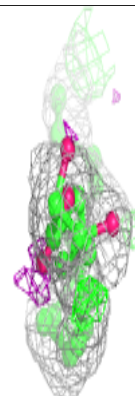
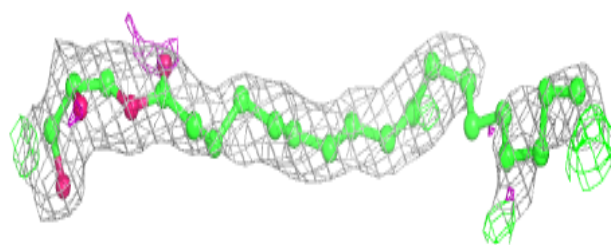
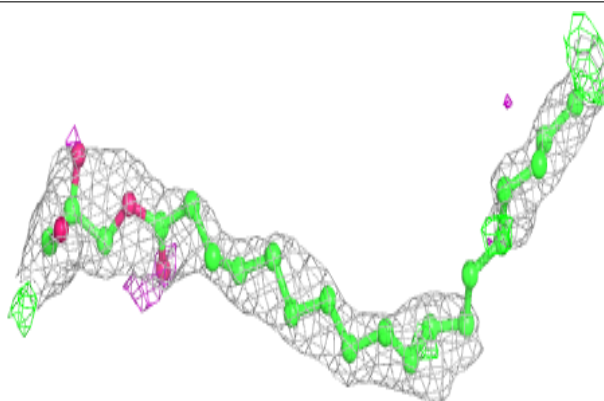

**Electron density around P4C C 205:**

$2mF_o-DF_c$  (at 0.7 rmsd) in gray  
 $mF_o-DF_c$  (at 3 rmsd) in purple (negative)  
and green (positive)

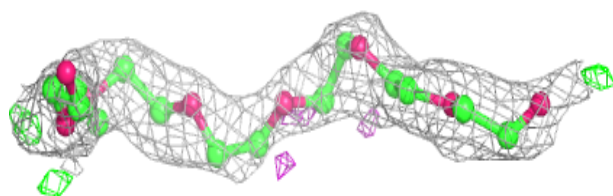
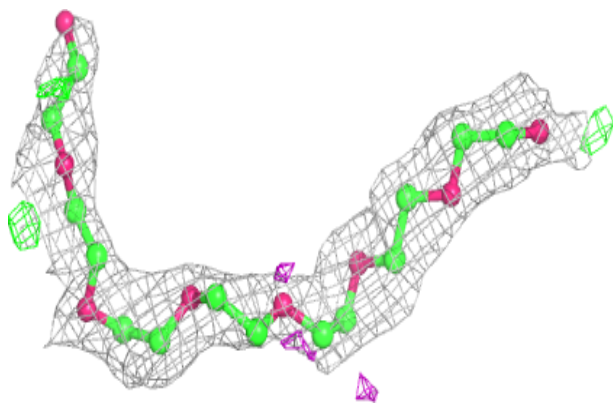
**Electron density around OLC B 206:**

$2mF_o-DF_c$  (at 0.7 rmsd) in gray  
 $mF_o-DF_c$  (at 3 rmsd) in purple (negative)  
and green (positive)

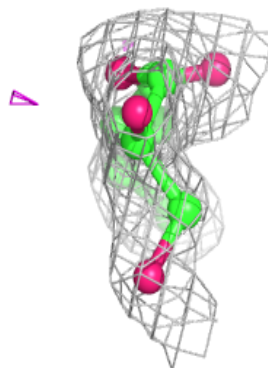
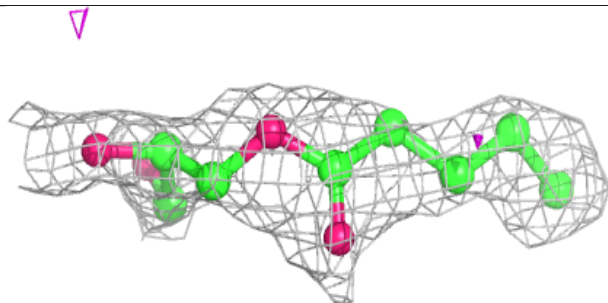
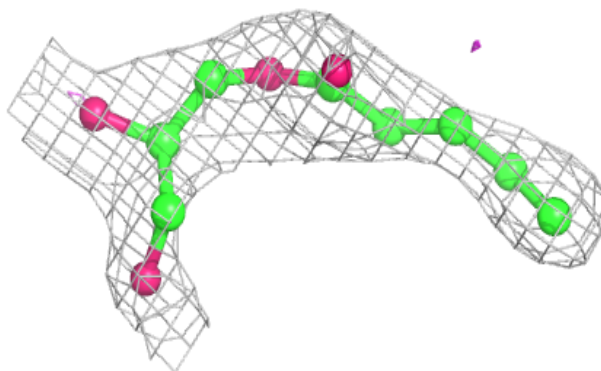

## 6.5 Other polymers

There are no such residues in this entry.