



wwPDB EM Validation Summary Report ⓘ

Oct 20, 2024 – 04:44 PM EDT

PDB ID : 7TFN
EMDB ID : EMD-25877
Title : Cryo-EM structure of CD4bs antibody Ab1303 in complex with HIV-1 Env trimer BG505 SOSIP.664
Authors : Yang, Z.; Bjorkman, P.J.
Deposited on : 2022-01-06
Resolution : 4.00 Å(reported)

This is a wwPDB EM Validation Summary Report for a publicly released PDB entry.

We welcome your comments at validation@mail.wwpdb.org

A user guide is available at

<https://www.wwpdb.org/validation/2017/EMValidationReportHelp>

with specific help available everywhere you see the ⓘ symbol.

The types of validation reports are described at

<http://www.wwpdb.org/validation/2017/FAQs#types>.

The following versions of software and data (see [references ⓘ](#)) were used in the production of this report:

EMDB validation analysis : 0.0.1.dev113
Mogul : 2022.3.0, CSD as543be (2022)
MolProbity : 4.02b-467
Percentile statistics : 20231227.v01 (using entries in the PDB archive December 27th 2023)
MapQ : 1.9.13
Ideal geometry (proteins) : Engh & Huber (2001)
Ideal geometry (DNA, RNA) : Parkinson et al. (1996)
Validation Pipeline (wwPDB-VP) : 2.39

1 Overall quality at a glance i

The following experimental techniques were used to determine the structure:

ELECTRON MICROSCOPY

The reported resolution of this entry is 4.00 Å.

Percentile scores (ranging between 0-100) for global validation metrics of the entry are shown in the following graphic. The table shows the number of entries on which the scores are based.

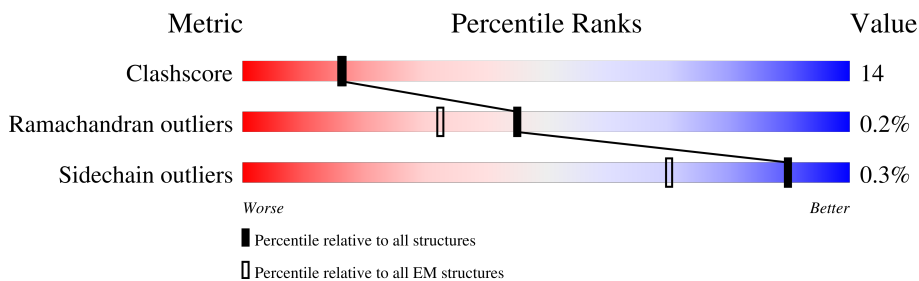













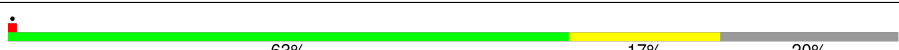
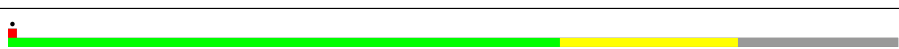

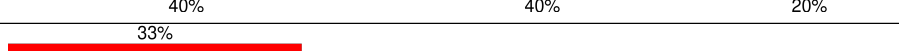
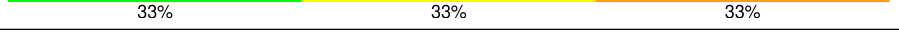
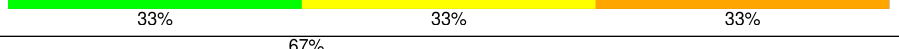
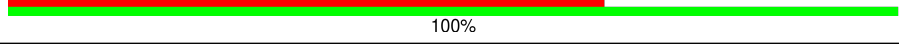
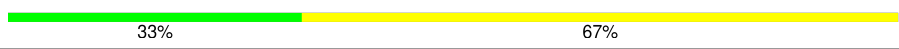
Metric	Whole archive (#Entries)	EM structures (#Entries)
Clashscore	210492	15764
Ramachandran outliers	207382	16835
Sidechain outliers	206894	16415

The table below summarises the geometric issues observed across the polymeric chains and their fit to the map. The red, orange, yellow and green segments of the bar indicate the fraction of residues that contain outliers for ≥ 3 , 2, 1 and 0 types of geometric quality criteria respectively. A grey segment represents the fraction of residues that are not modelled. The numeric value for each fraction is indicated below the corresponding segment, with a dot representing fractions $\leq 5\%$. The upper red bar (where present) indicates the fraction of residues that have poor fit to the EM map (all-atom inclusion $< 40\%$). The numeric value is given above the bar.

Mol	Chain	Length	Quality of chain
1	A	481	
1	B	481	
1	C	481	
2	H	235	
2	I	235	
2	P	235	
3	J	217	
3	L	217	

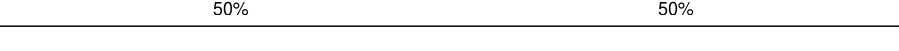
Continued on next page...

Continued from previous page...

Mol	Chain	Length	Quality of chain
3	Q	217	
4	X	153	
4	Y	153	
4	Z	153	
5	D	5	
6	E	3	
6	O	3	
6	b	3	
6	c	3	
7	F	2	
7	N	2	
7	R	2	
7	T	2	
7	V	2	
7	a	2	
8	G	4	
9	M	4	
9	S	4	
9	U	4	
9	W	4	

2 Entry composition i

There are 11 unique types of molecules in this entry. The entry contains 18692 atoms, of which 0 are hydrogens and 0 are deuteriums.

In the tables below, the AltConf column contains the number of residues with at least one atom in alternate conformation and the Trace column contains the number of residues modelled with at most 2 atoms.

- Molecule 1 is a protein called Envelope glycoprotein BG505 SOSIP.664 - gp120.

Mol	Chain	Residues	Atoms					AltConf	Trace
			Total	C	N	O	S		
1	A	429	3217	2041	559	592	25	0	0
1	B	422	3224	2039	566	595	24	0	0
1	C	410	3188	2019	555	587	27	0	0

There are 18 discrepancies between the modelled and reference sequences:

Chain	Residue	Modelled	Actual	Comment	Reference
A	64	LYS	GLU	conflict	UNP A0A6H1VH54
A	375	SER	TYR	conflict	UNP A0A6H1VH54
A	501	CYS	ALA	conflict	UNP A0A6H1VH54
A	509	ARG	GLU	conflict	UNP A0A6H1VH54
A	512	ARG	-	expression tag	UNP A0A6H1VH54
A	513	ARG	-	expression tag	UNP A0A6H1VH54
B	64	LYS	GLU	conflict	UNP A0A6H1VH54
B	375	SER	TYR	conflict	UNP A0A6H1VH54
B	501	CYS	ALA	conflict	UNP A0A6H1VH54
B	509	ARG	GLU	conflict	UNP A0A6H1VH54
B	512	ARG	-	expression tag	UNP A0A6H1VH54
B	513	ARG	-	expression tag	UNP A0A6H1VH54
C	64	LYS	GLU	conflict	UNP A0A6H1VH54
C	375	SER	TYR	conflict	UNP A0A6H1VH54
C	501	CYS	ALA	conflict	UNP A0A6H1VH54
C	509	ARG	GLU	conflict	UNP A0A6H1VH54
C	512	ARG	-	expression tag	UNP A0A6H1VH54
C	513	ARG	-	expression tag	UNP A0A6H1VH54

- Molecule 2 is a protein called Anti-HIV-1 CD4bs antibody Fab Ab1303 - Heavy chain.

Mol	Chain	Residues	Atoms					AltConf	Trace
2	H	123	Total	C	N	O	S	0	0
			954	605	160	187	2		
2	I	123	Total	C	N	O	S	0	0
			954	605	160	187	2		
2	P	123	Total	C	N	O	S	0	0
			950	603	159	186	2		

- Molecule 3 is a protein called CD4 binding site antibody Fab Ab1303 - light chain.

Mol	Chain	Residues	Atoms					AltConf	Trace
3	J	111	Total	C	N	O	S	0	0
			837	523	145	167	2		
3	L	112	Total	C	N	O	S	0	0
			843	526	144	171	2		
3	Q	111	Total	C	N	O	S	0	0
			830	520	142	166	2		

- Molecule 4 is a protein called Envelope glycoprotein BG505 SOSIP.664 - gp41.

Mol	Chain	Residues	Atoms					AltConf	Trace
4	X	132	Total	C	N	O	S	0	0
			995	632	172	185	6		
4	Y	123	Total	C	N	O	S	0	0
			960	603	170	182	5		
4	Z	125	Total	C	N	O	S	0	0
			982	620	172	185	5		

There are 6 discrepancies between the modelled and reference sequences:

Chain	Residue	Modelled	Actual	Comment	Reference
X	559	PRO	ILE	conflict	UNP Q2N0S6
X	605	CYS	THR	conflict	UNP Q2N0S6
Y	559	PRO	ILE	conflict	UNP Q2N0S6
Y	605	CYS	THR	conflict	UNP Q2N0S6
Z	559	PRO	ILE	conflict	UNP Q2N0S6
Z	605	CYS	THR	conflict	UNP Q2N0S6

- Molecule 5 is an oligosaccharide called alpha-D-mannopyranose-(1-3)-[alpha-D-mannopyranose-(1-6)]beta-D-mannopyranose-(1-4)-2-acetamido-2-deoxy-beta-D-glucopyranose-(1-4)-2-acetamido-2-deoxy-beta-D-glucopyranose.

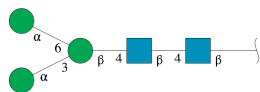

Mol	Chain	Residues	Atoms				AltConf	Trace
			Total	C	N	O		
5	D	5	61	34	2	25	0	0

- Molecule 6 is an oligosaccharide called beta-D-mannopyranose-(1-4)-2-acetamido-2-deoxy-beta-D-glucopyranose-(1-4)-2-acetamido-2-deoxy-beta-D-glucopyranose.

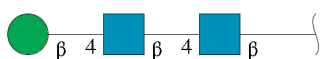

Mol	Chain	Residues	Atoms				AltConf	Trace
			Total	C	N	O		
6	E	3	39	22	2	15	0	0
6	O	3	39	22	2	15	0	0
6	b	3	39	22	2	15	0	0
6	c	3	39	22	2	15	0	0

- Molecule 7 is an oligosaccharide called 2-acetamido-2-deoxy-beta-D-glucopyranose-(1-4)-2-acetamido-2-deoxy-beta-D-glucopyranose.



Mol	Chain	Residues	Atoms				AltConf	Trace
			Total	C	N	O		
7	F	2	28	16	2	10	0	0
7	N	2	28	16	2	10	0	0
7	R	2	28	16	2	10	0	0
7	T	2	28	16	2	10	0	0
7	V	2	28	16	2	10	0	0

Continued on next page...

Continued from previous page...

Mol	Chain	Residues	Atoms			AltConf	Trace	
			Total	C	N			O
7	a	2	28	16	2	10	0	0

- Molecule 8 is an oligosaccharide called alpha-D-mannopyranose-(1-6)-beta-D-mannopyranose-(1-4)-2-acetamido-2-deoxy-beta-D-glucopyranose-(1-4)-2-acetamido-2-deoxy-beta-D-glucopyranose.



Mol	Chain	Residues	Atoms			AltConf	Trace	
			Total	C	N			O
8	G	4	50	28	2	20	0	0

- Molecule 9 is an oligosaccharide called alpha-D-mannopyranose-(1-3)-beta-D-mannopyranose-(1-4)-2-acetamido-2-deoxy-beta-D-glucopyranose-(1-4)-2-acetamido-2-deoxy-beta-D-glucopyranose.



Mol	Chain	Residues	Atoms			AltConf	Trace	
			Total	C	N			O
9	M	4	50	28	2	20	0	0
9	S	4	50	28	2	20	0	0
9	U	4	50	28	2	20	0	0
9	W	4	50	28	2	20	0	0

- Molecule 10 is 2-acetamido-2-deoxy-beta-D-glucopyranose (three-letter code: NAG) (formula: C₈H₁₅NO₆).



Mol	Chain	Residues	Atoms				AltConf
			Total	C	N	O	
10	A	1	Total 14	C 8	N 1	O 5	0
10	A	1	Total 14	C 8	N 1	O 5	0
10	A	1	Total 14	C 8	N 1	O 5	0
10	A	1	Total 14	C 8	N 1	O 5	0
10	B	1	Total 14	C 8	N 1	O 5	0
10	B	1	Total 14	C 8	N 1	O 5	0
10	C	1	Total 14	C 8	N 1	O 5	0
10	C	1	Total 14	C 8	N 1	O 5	0

- Molecule 11 is alpha-D-mannopyranose (three-letter code: MAN) (formula: C₆H₁₂O₆).

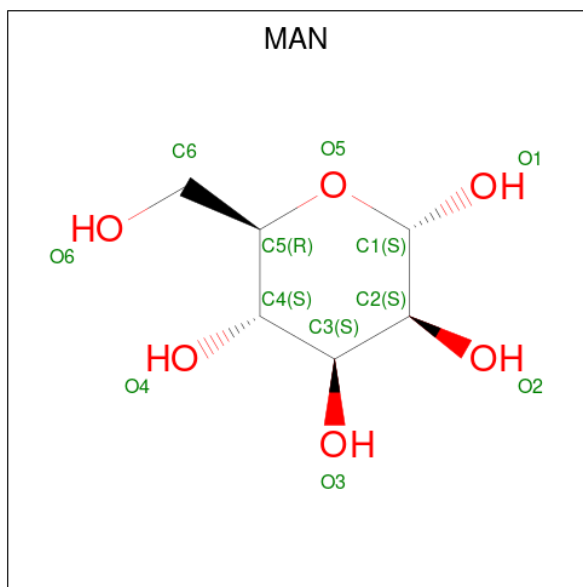

Mol	Chain	Residues	Atoms			AltConf
11	C	1	Total	C	O	0
			11	6	5	

3 Residue-property plots

These plots are drawn for all protein, RNA, DNA and oligosaccharide chains in the entry. The first graphic for a chain summarises the proportions of the various outlier classes displayed in the second graphic. The second graphic shows the sequence view annotated by issues in geometry and atom inclusion in map density. Residues are color-coded according to the number of geometric quality criteria for which they contain at least one outlier: green = 0, yellow = 1, orange = 2 and red = 3 or more. A red diamond above a residue indicates a poor fit to the EM map for this residue (all-atom inclusion < 40%). Stretches of 2 or more consecutive residues without any outlier are shown as a green connector. Residues present in the sample, but not in the model, are shown in grey.

- Molecule 1: Envelope glycoprotein BG505 SOSIP.664 - gp120

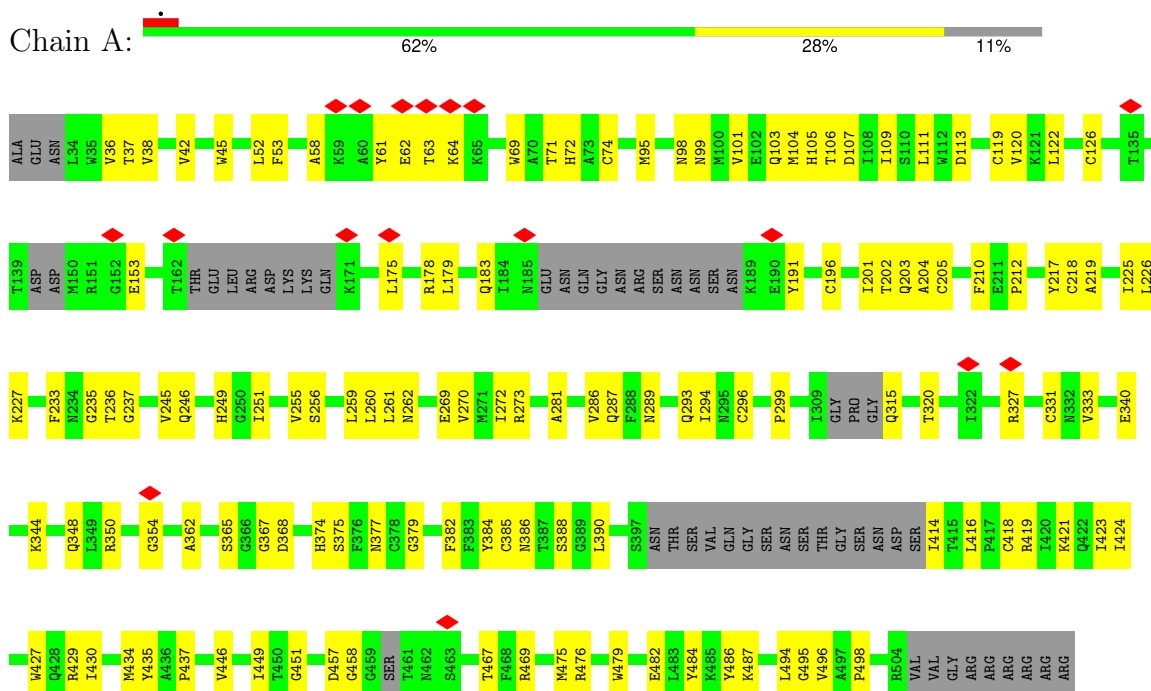

- Molecule 1: Envelope glycoprotein BG505 SOSIP.664 - gp120

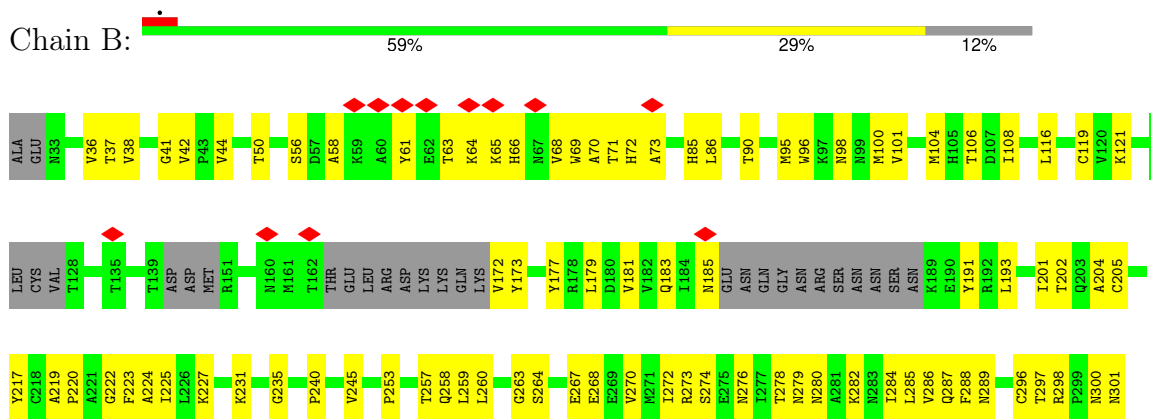

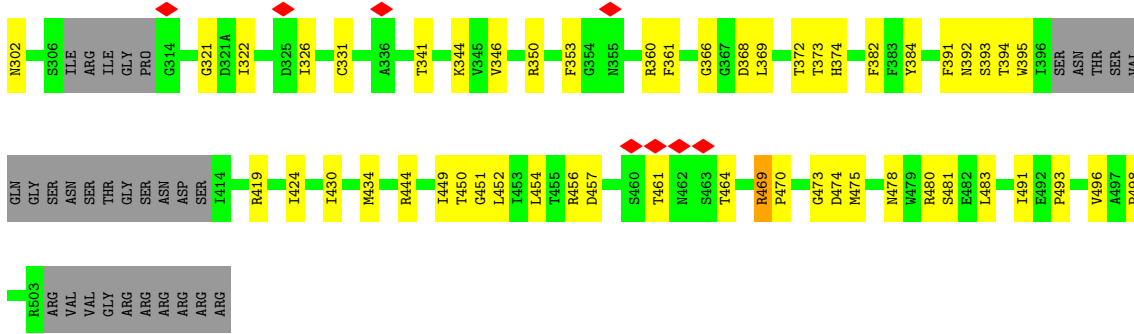

- Molecule 1: Envelope glycoprotein BG505 SOSIP.664 - gp120

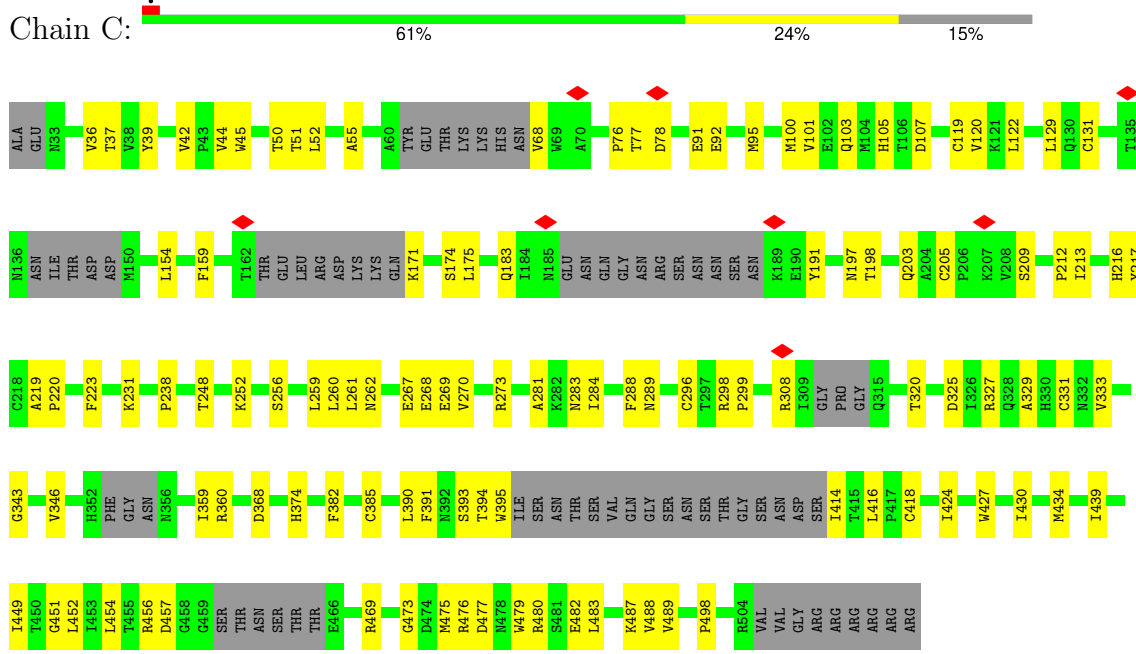

- Molecule 2: Anti-HIV-1 CD4bs antibody Fab Ab1303 - Heavy chain

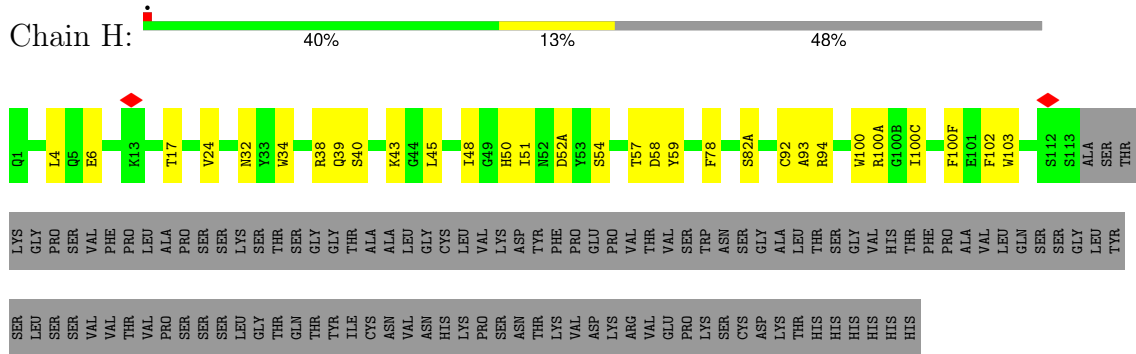

- Molecule 2: Anti-HIV-1 CD4bs antibody Fab Ab1303 - Heavy chain

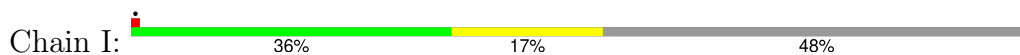

• Molecule 3: CD4 binding site antibody Fab Ab1303 - light chain

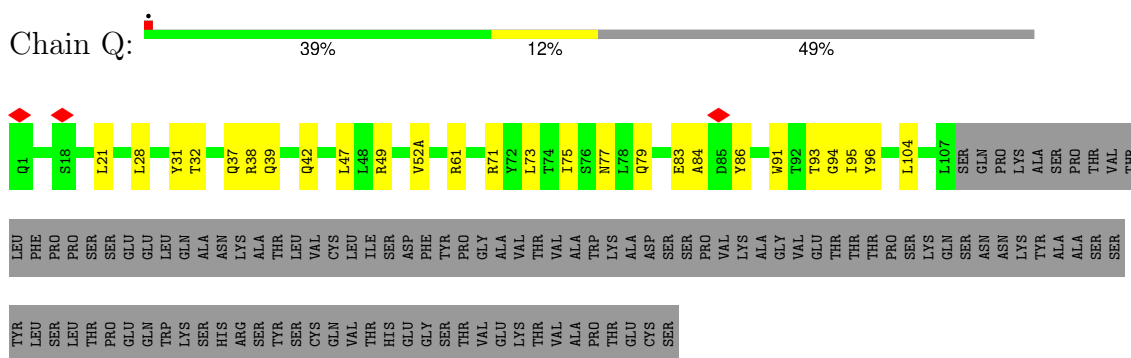

• Molecule 4: Envelope glycoprotein BG505 SOSIP.664 - gp41

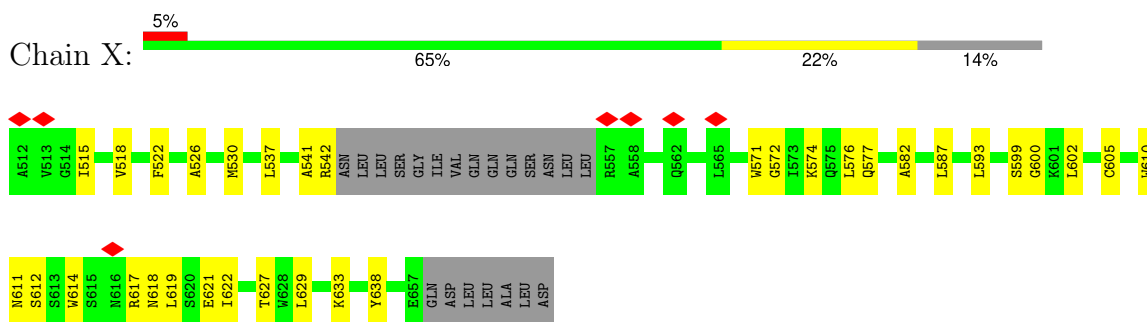

• Molecule 4: Envelope glycoprotein BG505 SOSIP.664 - gp41

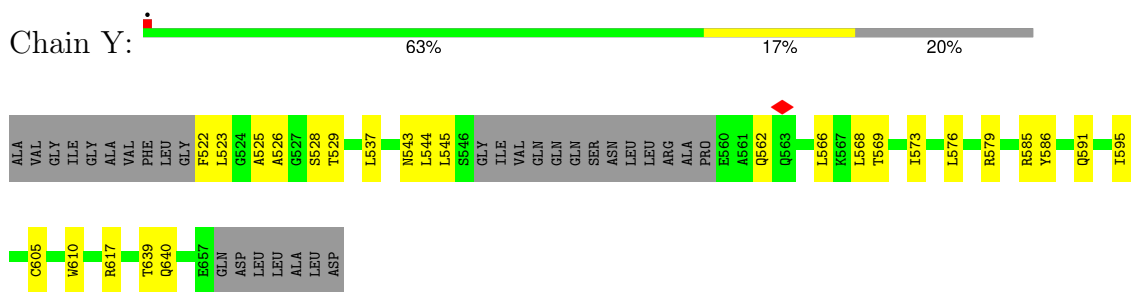

• Molecule 4: Envelope glycoprotein BG505 SOSIP.664 - gp41

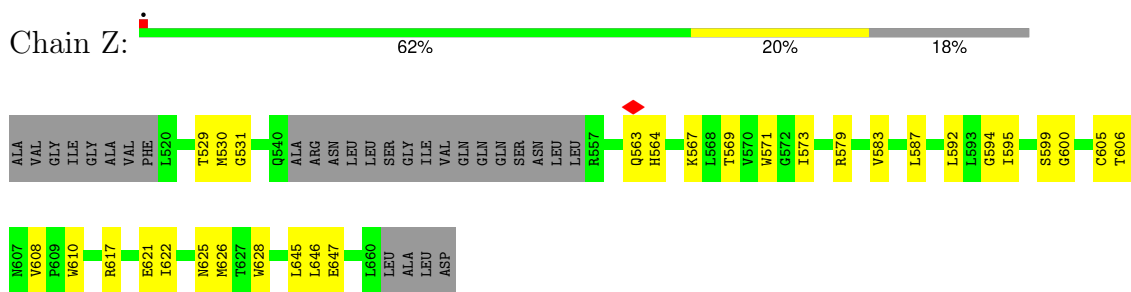

• Molecule 5: alpha-D-mannopyranose-(1-3)-[alpha-D-mannopyranose-(1-6)]beta-D-mannopyranose-(1-4)-2-acetamido-2-deoxy-beta-D-glucopyranose-(1-4)-2-acetamido-2-deoxy-beta-D-glucopyranose

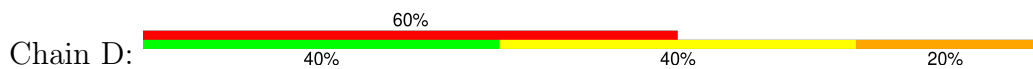

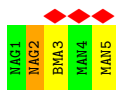

- Molecule 6: beta-D-mannopyranose-(1-4)-2-acetamido-2-deoxy-beta-D-glucopyranose-(1-4)-2-acetamido-2-deoxy-beta-D-glucopyranose



- Molecule 6: beta-D-mannopyranose-(1-4)-2-acetamido-2-deoxy-beta-D-glucopyranose-(1-4)-2-acetamido-2-deoxy-beta-D-glucopyranose



- Molecule 6: beta-D-mannopyranose-(1-4)-2-acetamido-2-deoxy-beta-D-glucopyranose-(1-4)-2-acetamido-2-deoxy-beta-D-glucopyranose



- Molecule 6: beta-D-mannopyranose-(1-4)-2-acetamido-2-deoxy-beta-D-glucopyranose-(1-4)-2-acetamido-2-deoxy-beta-D-glucopyranose



- Molecule 7: 2-acetamido-2-deoxy-beta-D-glucopyranose-(1-4)-2-acetamido-2-deoxy-beta-D-glucopyranose



- Molecule 7: 2-acetamido-2-deoxy-beta-D-glucopyranose-(1-4)-2-acetamido-2-deoxy-beta-D-glucopyranose





- Molecule 7: 2-acetamido-2-deoxy-beta-D-glucopyranose-(1-4)-2-acetamido-2-deoxy-beta-D-glucopyranose



- Molecule 7: 2-acetamido-2-deoxy-beta-D-glucopyranose-(1-4)-2-acetamido-2-deoxy-beta-D-glucopyranose



- Molecule 7: 2-acetamido-2-deoxy-beta-D-glucopyranose-(1-4)-2-acetamido-2-deoxy-beta-D-glucopyranose



- Molecule 7: 2-acetamido-2-deoxy-beta-D-glucopyranose-(1-4)-2-acetamido-2-deoxy-beta-D-glucopyranose



- Molecule 8: alpha-D-mannopyranose-(1-6)-beta-D-mannopyranose-(1-4)-2-acetamido-2-deoxy-beta-D-glucopyranose-(1-4)-2-acetamido-2-deoxy-beta-D-glucopyranose



- Molecule 9: alpha-D-mannopyranose-(1-3)-beta-D-mannopyranose-(1-4)-2-acetamido-2-deoxy-beta-D-glucopyranose-(1-4)-2-acetamido-2-deoxy-beta-D-glucopyranose

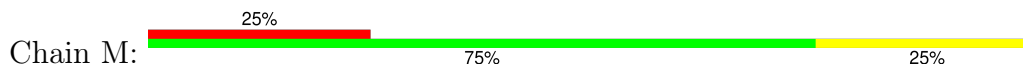



- Molecule 9: alpha-D-mannopyranose-(1-3)-beta-D-mannopyranose-(1-4)-2-acetamido-2-deoxy-beta-D-glucopyranose-(1-4)-2-acetamido-2-deoxy-beta-D-glucopyranose

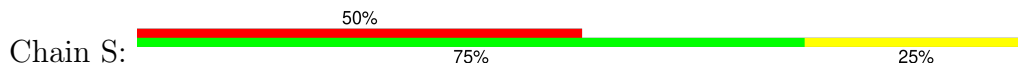

- Molecule 9: alpha-D-mannopyranose-(1-3)-beta-D-mannopyranose-(1-4)-2-acetamido-2-deoxy-beta-D-glucopyranose-(1-4)-2-acetamido-2-deoxy-beta-D-glucopyranose



- Molecule 9: alpha-D-mannopyranose-(1-3)-beta-D-mannopyranose-(1-4)-2-acetamido-2-deoxy-beta-D-glucopyranose-(1-4)-2-acetamido-2-deoxy-beta-D-glucopyranose



4 Experimental information

Property	Value	Source
EM reconstruction method	SINGLE PARTICLE	Depositor
Imposed symmetry	POINT, Not provided	
Number of particles used	386825	Depositor
Resolution determination method	FSC 0.143 CUT-OFF	Depositor
CTF correction method	PHASE FLIPPING AND AMPLITUDE CORRECTION	Depositor
Microscope	FEI TALOS ARCTICA	Depositor
Voltage (kV)	200	Depositor
Electron dose ($e^-/\text{\AA}^2$)	60	Depositor
Minimum defocus (nm)	1400	Depositor
Maximum defocus (nm)	3000	Depositor
Magnification	Not provided	
Image detector	GATAN K3 BIOQUANTUM (6k x 4k)	Depositor
Maximum map value	0.150	Depositor
Minimum map value	-0.074	Depositor
Average map value	0.000	Depositor
Map value standard deviation	0.003	Depositor
Recommended contour level	0.025	Depositor
Map size (Å)	347.6, 347.6, 347.6	wwPDB
Map dimensions	400, 400, 400	wwPDB
Map angles (°)	90.0, 90.0, 90.0	wwPDB
Pixel spacing (Å)	0.869, 0.869, 0.869	Depositor

5 Model quality [i](#)

5.1 Standard geometry [i](#)

Bond lengths and bond angles in the following residue types are not validated in this section: MAN, BMA, NAG

The Z score for a bond length (or angle) is the number of standard deviations the observed value is removed from the expected value. A bond length (or angle) with $|Z| > 5$ is considered an outlier worth inspection. RMSZ is the root-mean-square of all Z scores of the bond lengths (or angles).

Mol	Chain	Bond lengths		Bond angles	
		RMSZ	# Z >5	RMSZ	# Z >5
1	A	0.27	0/3286	0.50	0/4482
1	B	0.26	0/3293	0.51	0/4482
1	C	0.27	0/3252	0.50	0/4416
2	H	0.28	0/979	0.53	0/1335
2	I	0.27	0/979	0.52	0/1335
2	P	0.28	0/975	0.54	0/1330
3	J	0.27	0/853	0.55	0/1157
3	L	0.30	0/859	0.54	0/1166
3	Q	0.28	0/846	0.55	0/1149
4	X	0.25	0/1014	0.48	0/1380
4	Y	0.25	0/976	0.44	0/1324
4	Z	0.24	0/1001	0.45	0/1360
All	All	0.27	0/18313	0.51	0/24916

There are no bond length outliers.

There are no bond angle outliers.

There are no chirality outliers.

There are no planarity outliers.

5.2 Too-close contacts [i](#)

In the following table, the Non-H and H(model) columns list the number of non-hydrogen atoms and hydrogen atoms in the chain respectively. The H(added) column lists the number of hydrogen atoms added and optimized by MolProbity. The Clashes column lists the number of clashes within the asymmetric unit, whereas Symm-Clashes lists symmetry-related clashes.

Mol	Chain	Non-H	H(model)	H(added)	Clashes	Symm-Clashes
1	A	3217	0	3017	98	0

Continued on next page...

Continued from previous page...

Mol	Chain	Non-H	H(model)	H(added)	Clashes	Symm-Clashes
1	B	3224	0	3096	103	0
1	C	3188	0	3119	97	0
2	H	954	0	908	23	0
2	I	954	0	908	35	0
2	P	950	0	902	25	0
3	J	837	0	812	27	0
3	L	843	0	814	40	0
3	Q	830	0	801	21	0
4	X	995	0	937	28	0
4	Y	960	0	922	26	0
4	Z	982	0	946	39	0
5	D	61	0	52	3	0
6	E	39	0	34	2	0
6	O	39	0	34	3	0
6	b	39	0	34	0	0
6	c	39	0	34	0	0
7	F	28	0	25	7	0
7	N	28	0	25	1	0
7	R	28	0	25	1	0
7	T	28	0	25	0	0
7	V	28	0	25	1	0
7	a	28	0	25	0	0
8	G	50	0	43	5	0
9	M	50	0	43	0	0
9	S	50	0	43	0	0
9	U	50	0	43	1	0
9	W	50	0	43	1	0
10	A	56	0	52	3	0
10	B	28	0	26	0	0
10	C	28	0	26	1	0
11	C	11	0	10	0	0
All	All	18692	0	17849	499	0

The all-atom clashscore is defined as the number of clashes found per 1000 atoms (including hydrogen atoms). The all-atom clashscore for this structure is 14.

The worst 5 of 499 close contacts within the same asymmetric unit are listed below, sorted by their clash magnitude.

Atom-1	Atom-2	Interatomic distance (Å)	Clash overlap (Å)
1:A:430:ILE:HG21	3:L:94:GLY:O	1.26	1.29
1:A:430:ILE:CG2	3:L:94:GLY:O	1.97	1.11

Continued on next page...

Continued from previous page...

Atom-1	Atom-2	Interatomic distance (Å)	Clash overlap (Å)
1:C:76:PRO:HB2	4:Z:567:LYS:HG2	1.33	1.04
1:B:64:LYS:HE2	1:B:72:HIS:HA	1.39	1.02
1:A:237:GLY:HA3	7:F:2:NAG:C8	1.92	0.99

There are no symmetry-related clashes.

5.3 Torsion angles [i](#)

5.3.1 Protein backbone [i](#)

In the following table, the Percentiles column shows the percent Ramachandran outliers of the chain as a percentile score with respect to all PDB entries followed by that with respect to all EM entries.

The Analysed column shows the number of residues for which the backbone conformation was analysed, and the total number of residues.

Mol	Chain	Analysed	Favoured	Allowed	Outliers	Percentiles	
1	A	415/481 (86%)	395 (95%)	20 (5%)	0	100	100
1	B	408/481 (85%)	373 (91%)	35 (9%)	0	100	100
1	C	392/481 (82%)	362 (92%)	30 (8%)	0	100	100
2	H	121/235 (52%)	117 (97%)	4 (3%)	0	100	100
2	I	121/235 (52%)	118 (98%)	3 (2%)	0	100	100
2	P	121/235 (52%)	117 (97%)	4 (3%)	0	100	100
3	J	109/217 (50%)	100 (92%)	9 (8%)	0	100	100
3	L	110/217 (51%)	99 (90%)	8 (7%)	3 (3%)	4	29
3	Q	109/217 (50%)	100 (92%)	9 (8%)	0	100	100
4	X	128/153 (84%)	122 (95%)	6 (5%)	0	100	100
4	Y	119/153 (78%)	115 (97%)	3 (2%)	1 (1%)	16	53
4	Z	121/153 (79%)	117 (97%)	4 (3%)	0	100	100
All	All	2274/3258 (70%)	2135 (94%)	135 (6%)	4 (0%)	45	76

All (4) Ramachandran outliers are listed below:

Mol	Chain	Res	Type
3	L	92	THR

Continued on next page...

Continued from previous page...

Mol	Chain	Res	Type
3	L	94	GLY
4	Y	562	GLN
3	L	95	ILE

5.3.2 Protein sidechains [i](#)

In the following table, the Percentiles column shows the percent sidechain outliers of the chain as a percentile score with respect to all PDB entries followed by that with respect to all EM entries.

The Analysed column shows the number of residues for which the sidechain conformation was analysed, and the total number of residues.

Mol	Chain	Analysed	Rotameric	Outliers	Percentiles	
1	A	335/428 (78%)	334 (100%)	1 (0%)	91	92
1	B	348/428 (81%)	346 (99%)	2 (1%)	84	88
1	C	354/428 (83%)	353 (100%)	1 (0%)	91	92
2	H	105/204 (52%)	105 (100%)	0	100	100
2	I	105/204 (52%)	105 (100%)	0	100	100
2	P	104/204 (51%)	104 (100%)	0	100	100
3	J	92/187 (49%)	92 (100%)	0	100	100
3	L	93/187 (50%)	92 (99%)	1 (1%)	70	80
3	Q	90/187 (48%)	90 (100%)	0	100	100
4	X	97/129 (75%)	97 (100%)	0	100	100
4	Y	100/129 (78%)	99 (99%)	1 (1%)	73	81
4	Z	103/129 (80%)	103 (100%)	0	100	100
All	All	1926/2844 (68%)	1920 (100%)	6 (0%)	90	92

5 of 6 residues with a non-rotameric sidechain are listed below:

Mol	Chain	Res	Type
1	C	308	ARG
3	L	49	ARG
4	Y	617	ARG
1	B	65	LYS
1	A	365	SER

Sometimes sidechains can be flipped to improve hydrogen bonding and reduce clashes. All (5) such

sidechains are listed below:

Mol	Chain	Res	Type
1	A	66	HIS
1	B	302	ASN
1	C	203	GLN
4	X	591	GLN
4	Y	543	ASN

5.3.3 RNA [i](#)

There are no RNA molecules in this entry.

5.4 Non-standard residues in protein, DNA, RNA chains [i](#)

There are no non-standard protein/DNA/RNA residues in this entry.

5.5 Carbohydrates [i](#)

49 monosaccharides are modelled in this entry.

In the following table, the Counts columns list the number of bonds (or angles) for which Mogul statistics could be retrieved, the number of bonds (or angles) that are observed in the model and the number of bonds (or angles) that are defined in the Chemical Component Dictionary. The Link column lists molecule types, if any, to which the group is linked. The Z score for a bond length (or angle) is the number of standard deviations the observed value is removed from the expected value. A bond length (or angle) with $|Z| > 2$ is considered an outlier worth inspection. RMSZ is the root-mean-square of all Z scores of the bond lengths (or angles).

Mol	Type	Chain	Res	Link	Bond lengths			Bond angles		
					Counts	RMSZ	$\# Z > 2$	Counts	RMSZ	$\# Z > 2$
5	NAG	D	1	5,1	14,14,15	0.38	0	17,19,21	0.58	0
5	NAG	D	2	5	14,14,15	0.34	0	17,19,21	1.09	2 (11%)
5	BMA	D	3	5	11,11,12	0.23	0	15,15,17	0.69	0
5	MAN	D	4	5	11,11,12	0.19	0	15,15,17	0.61	0
5	MAN	D	5	5	11,11,12	0.19	0	15,15,17	0.61	0
6	NAG	E	1	1,6	14,14,15	0.33	0	17,19,21	0.82	1 (5%)
6	NAG	E	2	6	14,14,15	0.27	0	17,19,21	1.07	2 (11%)
6	BMA	E	3	6	11,11,12	0.26	0	15,15,17	0.78	0
7	NAG	F	1	7,1	14,14,15	0.39	0	17,19,21	0.78	0
7	NAG	F	2	7	14,14,15	0.30	0	17,19,21	0.80	1 (5%)
8	NAG	G	1	8,1	14,14,15	0.41	0	17,19,21	0.89	1 (5%)
8	NAG	G	2	8	14,14,15	0.31	0	17,19,21	0.94	2 (11%)

Mol	Type	Chain	Res	Link	Bond lengths			Bond angles		
					Counts	RMSZ	# Z > 2	Counts	RMSZ	# Z > 2
8	BMA	G	3	8	11,11,12	0.26	0	15,15,17	0.92	1 (6%)
8	MAN	G	4	8	11,11,12	0.21	0	15,15,17	0.57	0
9	NAG	M	1	9,1	14,14,15	0.17	0	17,19,21	0.53	0
9	NAG	M	2	9	14,14,15	0.22	0	17,19,21	0.42	0
9	BMA	M	3	9	11,11,12	0.47	0	15,15,17	0.68	0
9	MAN	M	4	9	11,11,12	0.71	0	15,15,17	1.05	2 (13%)
7	NAG	N	1	7,1	14,14,15	0.52	0	17,19,21	1.35	2 (11%)
7	NAG	N	2	7	14,14,15	0.24	0	17,19,21	0.48	0
6	NAG	O	1	1,6	14,14,15	0.48	0	17,19,21	0.51	0
6	NAG	O	2	6	14,14,15	0.69	1 (7%)	17,19,21	1.48	3 (17%)
6	BMA	O	3	6	11,11,12	0.54	0	15,15,17	0.76	0
7	NAG	R	1	7,1	14,14,15	0.51	0	17,19,21	0.83	1 (5%)
7	NAG	R	2	7	14,14,15	0.52	0	17,19,21	0.54	0
9	NAG	S	1	9,1	14,14,15	0.15	0	17,19,21	0.43	0
9	NAG	S	2	9	14,14,15	0.26	0	17,19,21	0.53	0
9	BMA	S	3	9	11,11,12	0.67	0	15,15,17	0.72	0
9	MAN	S	4	9	11,11,12	0.70	0	15,15,17	1.04	2 (13%)
7	NAG	T	1	7,1	14,14,15	0.33	0	17,19,21	0.63	1 (5%)
7	NAG	T	2	7	14,14,15	0.25	0	17,19,21	0.43	0
9	NAG	U	1	9,1	14,14,15	0.21	0	17,19,21	0.68	0
9	NAG	U	2	9	14,14,15	0.28	0	17,19,21	0.52	0
9	BMA	U	3	9	11,11,12	0.61	0	15,15,17	0.70	0
9	MAN	U	4	9	11,11,12	0.80	0	15,15,17	1.25	2 (13%)
7	NAG	V	1	7,1	14,14,15	0.58	0	17,19,21	0.96	1 (5%)
7	NAG	V	2	7	14,14,15	0.26	0	17,19,21	0.65	0
9	NAG	W	1	9,1	14,14,15	0.55	0	17,19,21	1.44	2 (11%)
9	NAG	W	2	9	14,14,15	0.28	0	17,19,21	0.59	0
9	BMA	W	3	9	11,11,12	0.66	0	15,15,17	0.78	0
9	MAN	W	4	9	11,11,12	0.65	0	15,15,17	0.93	2 (13%)
7	NAG	a	1	7,1	14,14,15	0.47	0	17,19,21	0.75	1 (5%)
7	NAG	a	2	7	14,14,15	0.32	0	17,19,21	0.37	0
6	NAG	b	1	1,6	14,14,15	0.33	0	17,19,21	0.46	0
6	NAG	b	2	6	14,14,15	0.23	0	17,19,21	0.51	0
6	BMA	b	3	6	11,11,12	0.60	0	15,15,17	0.78	0
6	NAG	c	1	1,6	14,14,15	0.73	1 (7%)	17,19,21	0.82	0
6	NAG	c	2	6	14,14,15	0.48	0	17,19,21	1.37	2 (11%)
6	BMA	c	3	6	11,11,12	0.60	0	15,15,17	0.70	0

In the following table, the Chirals column lists the number of chiral outliers, the number of chiral centers analysed, the number of these observed in the model and the number defined in the

Chemical Component Dictionary. Similar counts are reported in the Torsion and Rings columns.
'-' means no outliers of that kind were identified.

Mol	Type	Chain	Res	Link	Chirals	Torsions	Rings
5	NAG	D	1	5,1	-	3/6/23/26	0/1/1/1
5	NAG	D	2	5	-	0/6/23/26	0/1/1/1
5	BMA	D	3	5	-	0/2/19/22	0/1/1/1
5	MAN	D	4	5	-	0/2/19/22	0/1/1/1
5	MAN	D	5	5	-	0/2/19/22	0/1/1/1
6	NAG	E	1	1,6	-	3/6/23/26	0/1/1/1
6	NAG	E	2	6	-	1/6/23/26	0/1/1/1
6	BMA	E	3	6	-	0/2/19/22	0/1/1/1
7	NAG	F	1	7,1	-	3/6/23/26	0/1/1/1
7	NAG	F	2	7	-	3/6/23/26	0/1/1/1
8	NAG	G	1	8,1	-	3/6/23/26	0/1/1/1
8	NAG	G	2	8	-	2/6/23/26	0/1/1/1
8	BMA	G	3	8	-	2/2/19/22	0/1/1/1
8	MAN	G	4	8	-	0/2/19/22	0/1/1/1
9	NAG	M	1	9,1	-	3/6/23/26	0/1/1/1
9	NAG	M	2	9	-	2/6/23/26	0/1/1/1
9	BMA	M	3	9	-	0/2/19/22	0/1/1/1
9	MAN	M	4	9	-	2/2/19/22	1/1/1/1
7	NAG	N	1	7,1	-	5/6/23/26	0/1/1/1
7	NAG	N	2	7	-	2/6/23/26	0/1/1/1
6	NAG	O	1	1,6	-	3/6/23/26	0/1/1/1
6	NAG	O	2	6	-	6/6/23/26	0/1/1/1
6	BMA	O	3	6	-	2/2/19/22	0/1/1/1
7	NAG	R	1	7,1	-	2/6/23/26	0/1/1/1
7	NAG	R	2	7	-	2/6/23/26	0/1/1/1
9	NAG	S	1	9,1	-	1/6/23/26	0/1/1/1
9	NAG	S	2	9	-	2/6/23/26	0/1/1/1
9	BMA	S	3	9	-	1/2/19/22	0/1/1/1
9	MAN	S	4	9	-	0/2/19/22	1/1/1/1
7	NAG	T	1	7,1	-	2/6/23/26	0/1/1/1
7	NAG	T	2	7	-	2/6/23/26	0/1/1/1
9	NAG	U	1	9,1	-	3/6/23/26	0/1/1/1
9	NAG	U	2	9	-	0/6/23/26	0/1/1/1
9	BMA	U	3	9	-	2/2/19/22	0/1/1/1
9	MAN	U	4	9	-	2/2/19/22	0/1/1/1

Continued on next page...

Continued from previous page...

Mol	Type	Chain	Res	Link	Chirals	Torsions	Rings
7	NAG	V	1	7,1	-	2/6/23/26	0/1/1/1
7	NAG	V	2	7	-	4/6/23/26	0/1/1/1
9	NAG	W	1	9,1	-	6/6/23/26	0/1/1/1
9	NAG	W	2	9	-	0/6/23/26	0/1/1/1
9	BMA	W	3	9	-	1/2/19/22	0/1/1/1
9	MAN	W	4	9	-	0/2/19/22	0/1/1/1
7	NAG	a	1	7,1	-	2/6/23/26	0/1/1/1
7	NAG	a	2	7	-	2/6/23/26	0/1/1/1
6	NAG	b	1	1,6	-	1/6/23/26	0/1/1/1
6	NAG	b	2	6	-	0/6/23/26	0/1/1/1
6	BMA	b	3	6	-	2/2/19/22	0/1/1/1
6	NAG	c	1	1,6	-	2/6/23/26	0/1/1/1
6	NAG	c	2	6	-	6/6/23/26	0/1/1/1
6	BMA	c	3	6	-	0/2/19/22	0/1/1/1

All (2) bond length outliers are listed below:

Mol	Chain	Res	Type	Atoms	Z	Observed(Å)	Ideal(Å)
6	O	2	NAG	C1-C2	2.43	1.55	1.52
6	c	1	NAG	O5-C1	-2.32	1.39	1.43

The worst 5 of 31 bond angle outliers are listed below:

Mol	Chain	Res	Type	Atoms	Z	Observed(°)	Ideal(°)
9	W	1	NAG	C2-N2-C7	4.62	129.10	122.90
7	N	1	NAG	C2-N2-C7	4.56	129.02	122.90
6	c	2	NAG	C2-N2-C7	4.55	128.99	122.90
6	O	2	NAG	C2-N2-C7	4.53	128.97	122.90
9	U	4	MAN	C1-O5-C5	3.48	116.85	112.19

There are no chirality outliers.

5 of 92 torsion outliers are listed below:

Mol	Chain	Res	Type	Atoms
7	F	1	NAG	C8-C7-N2-C2
7	F	1	NAG	O7-C7-N2-C2
7	F	2	NAG	C8-C7-N2-C2
7	F	2	NAG	O7-C7-N2-C2
8	G	1	NAG	C8-C7-N2-C2

All (2) ring outliers are listed below:

Mol	Chain	Res	Type	Atoms
9	M	4	MAN	C1-C2-C3-C4-C5-O5
9	S	4	MAN	C1-C2-C3-C4-C5-O5

18 monomers are involved in 24 short contacts:

Mol	Chain	Res	Type	Clashes	Symm-Clashes
8	G	1	NAG	2	0
9	W	1	NAG	1	0
8	G	2	NAG	2	0
6	O	1	NAG	2	0
5	D	5	MAN	1	0
7	N	1	NAG	1	0
5	D	2	NAG	2	0
8	G	3	BMA	1	0
9	U	1	NAG	1	0
7	V	1	NAG	1	0
7	R	2	NAG	1	0
7	R	1	NAG	1	0
6	O	2	NAG	3	0
7	F	2	NAG	6	0
5	D	3	BMA	1	0
7	F	1	NAG	1	0
6	E	2	NAG	2	0
8	G	4	MAN	2	0

The following is a two-dimensional graphical depiction of Mogul quality analysis of bond lengths, bond angles, torsion angles, and ring geometry for oligosaccharide.

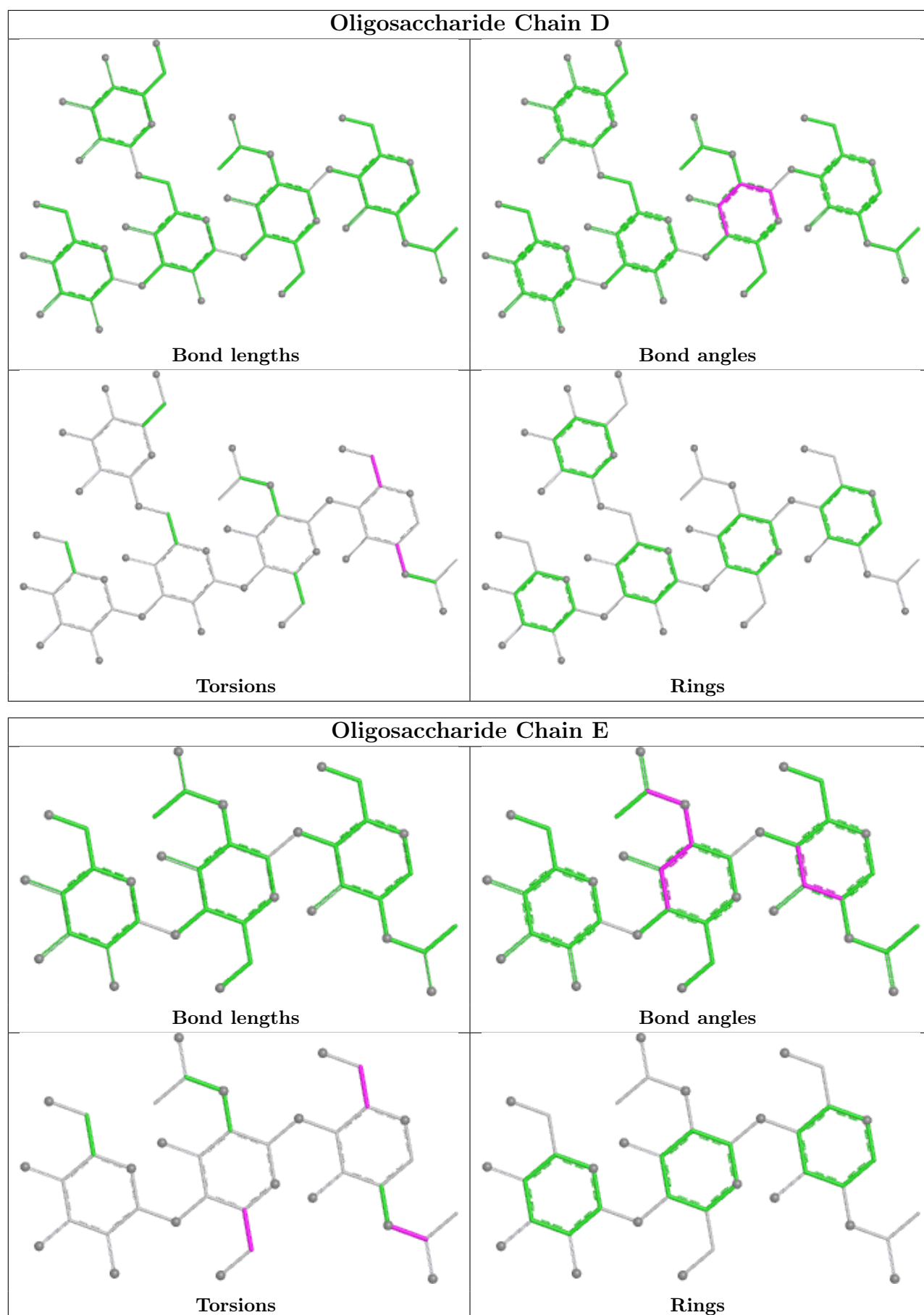

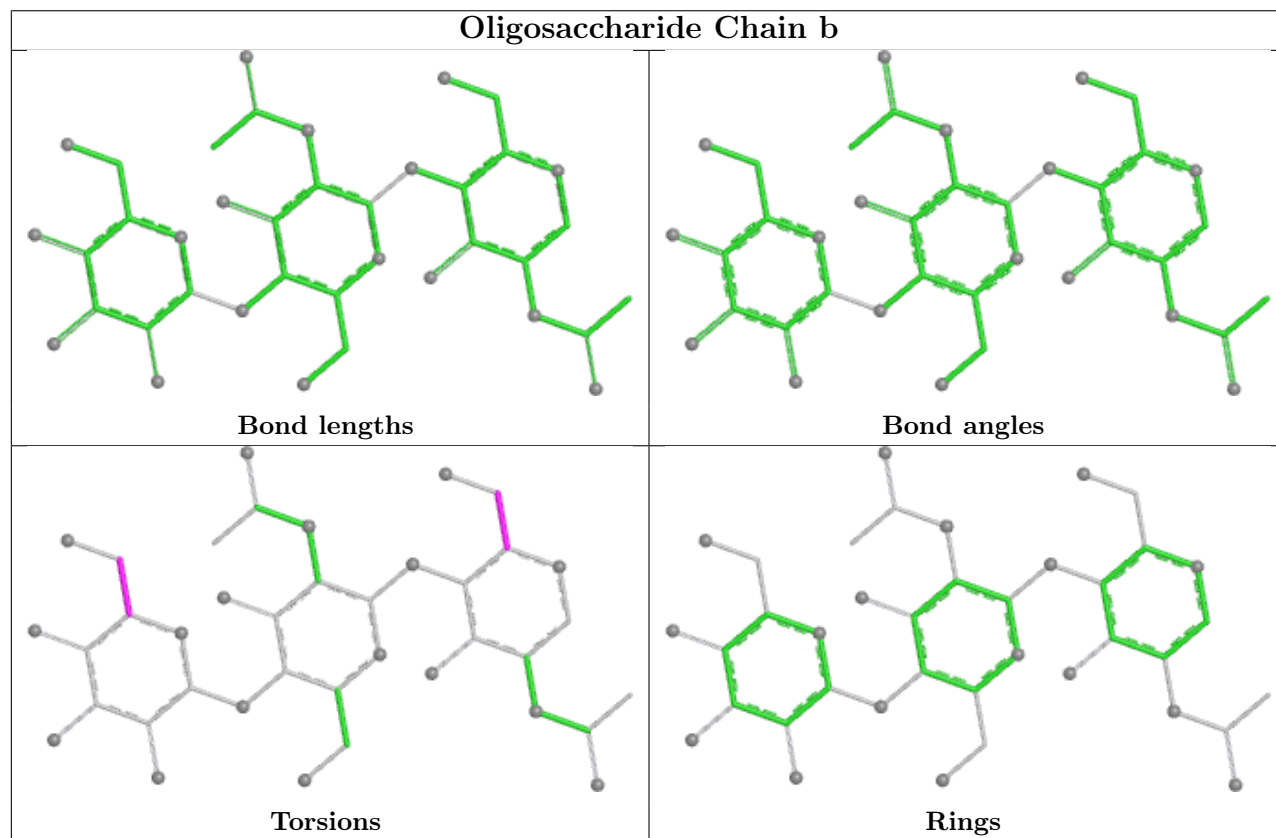
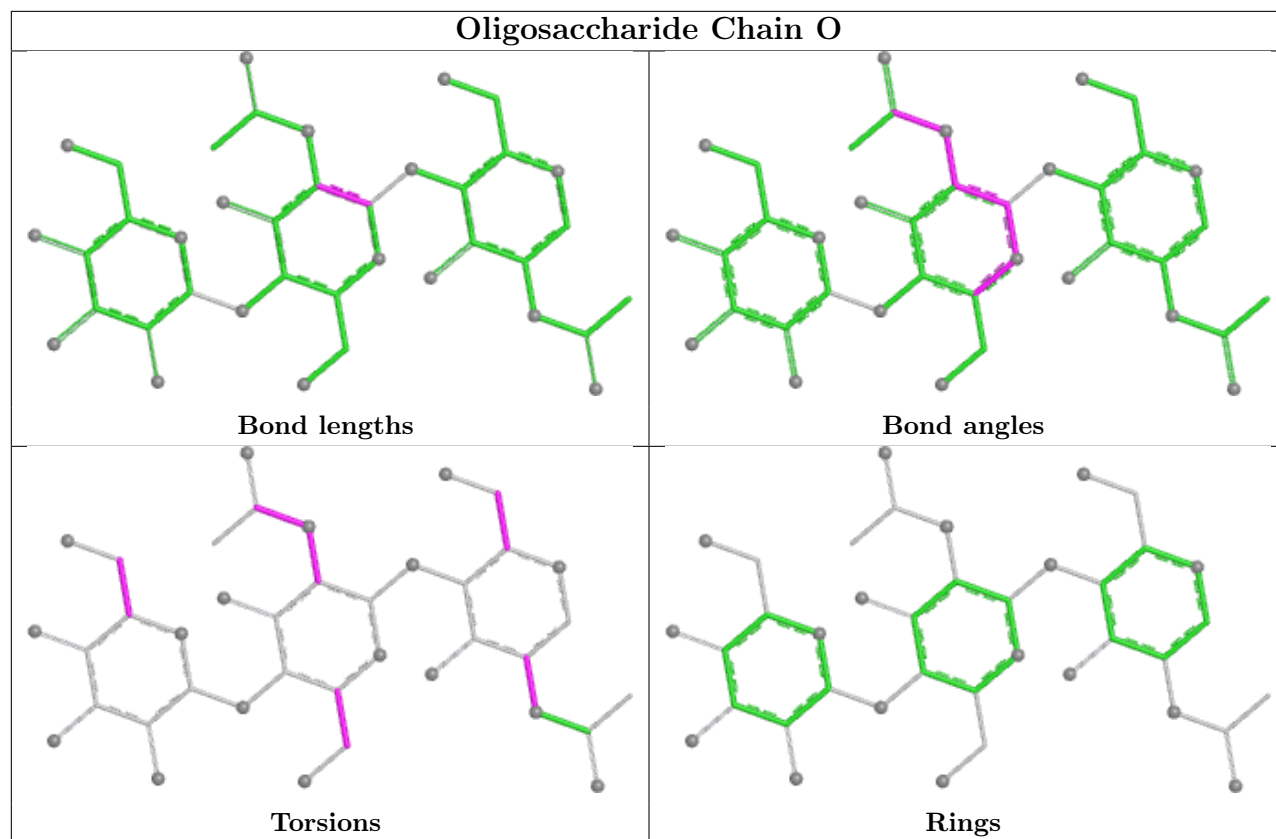

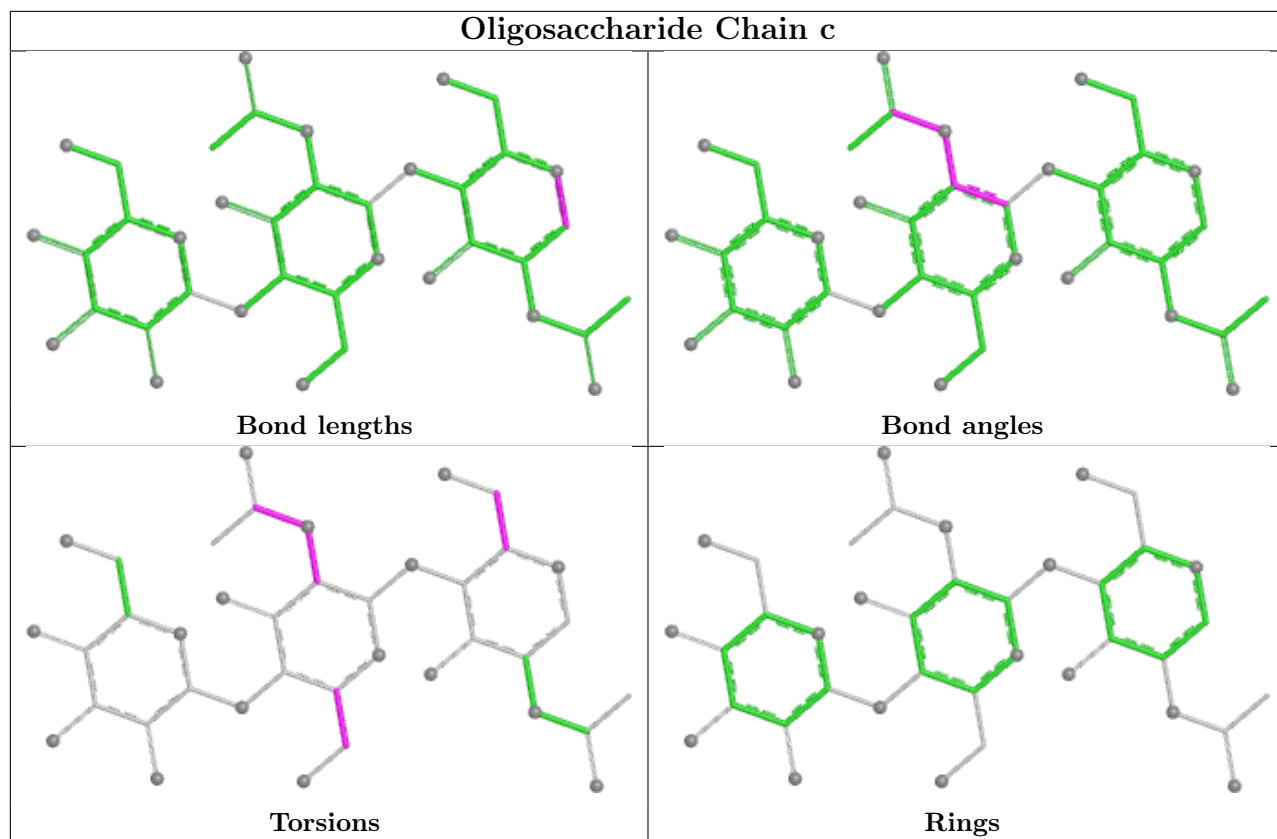

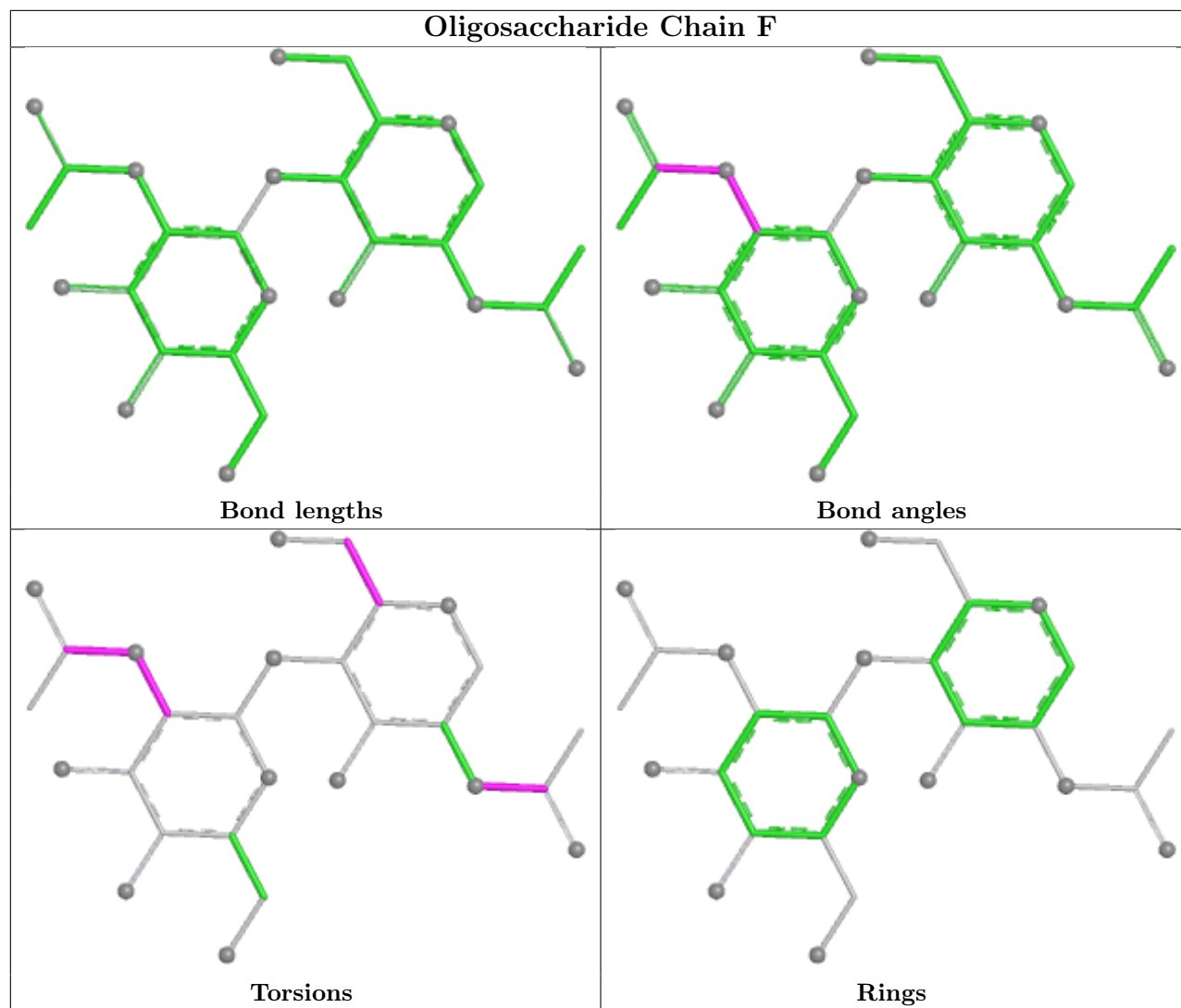

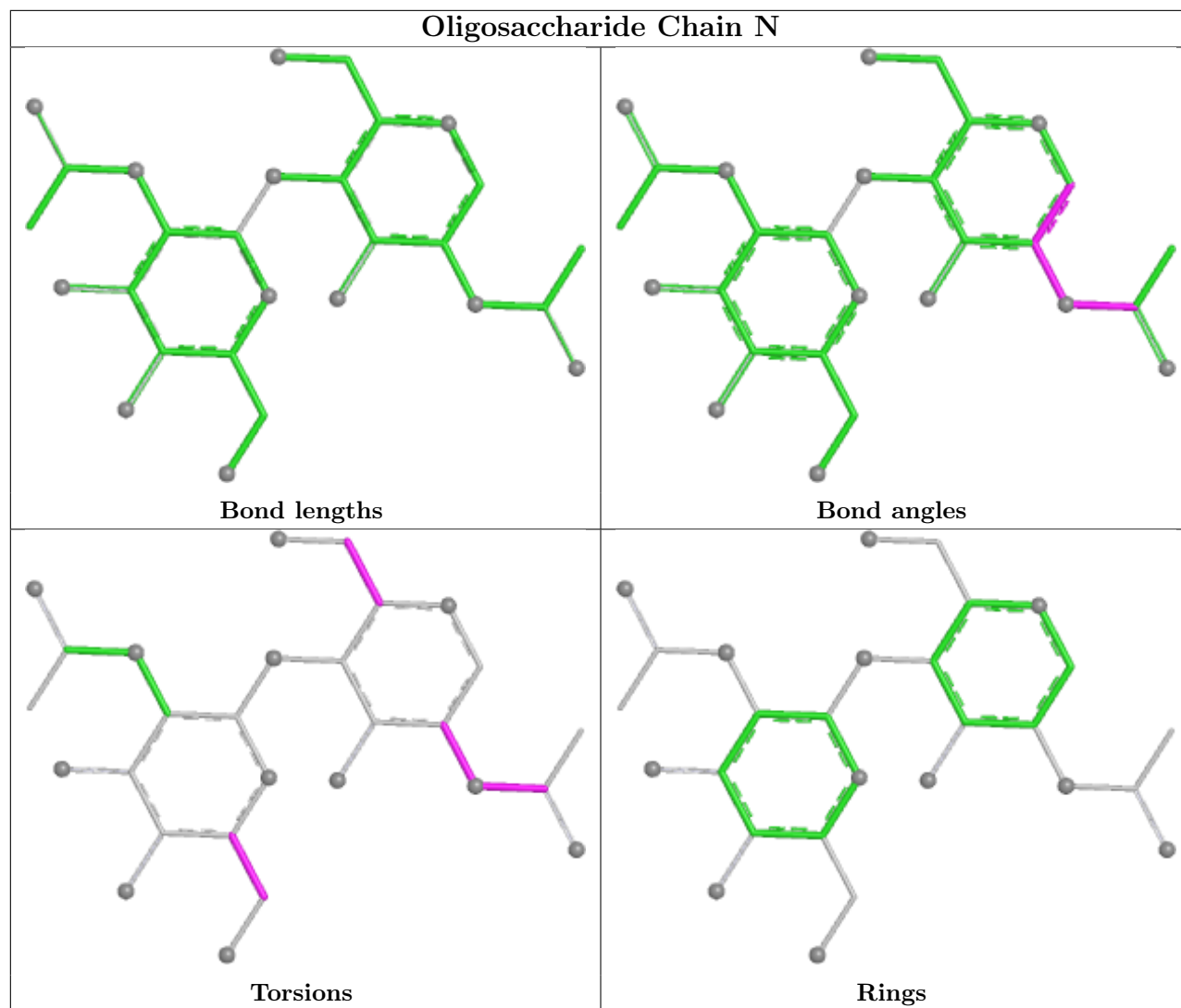

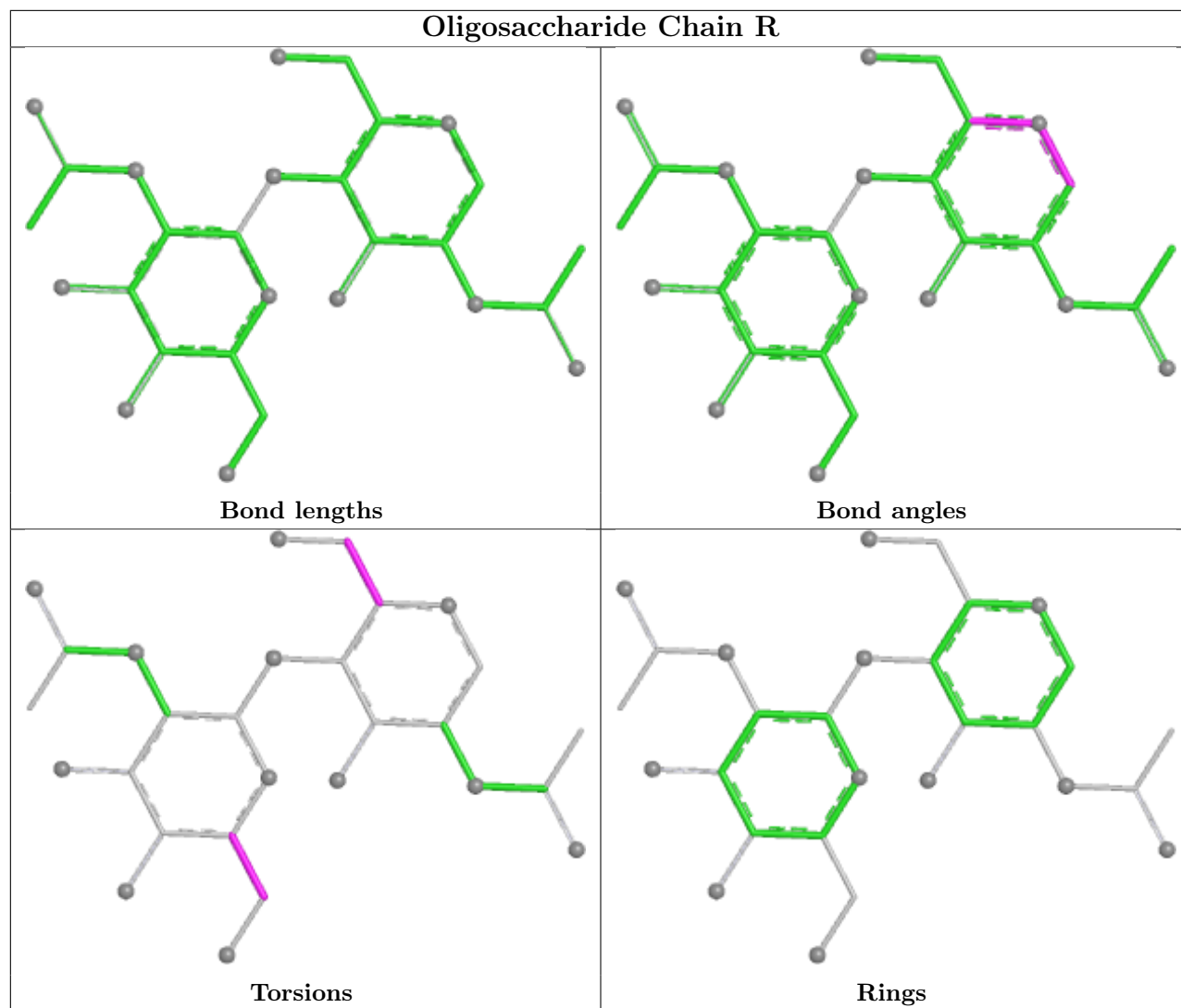

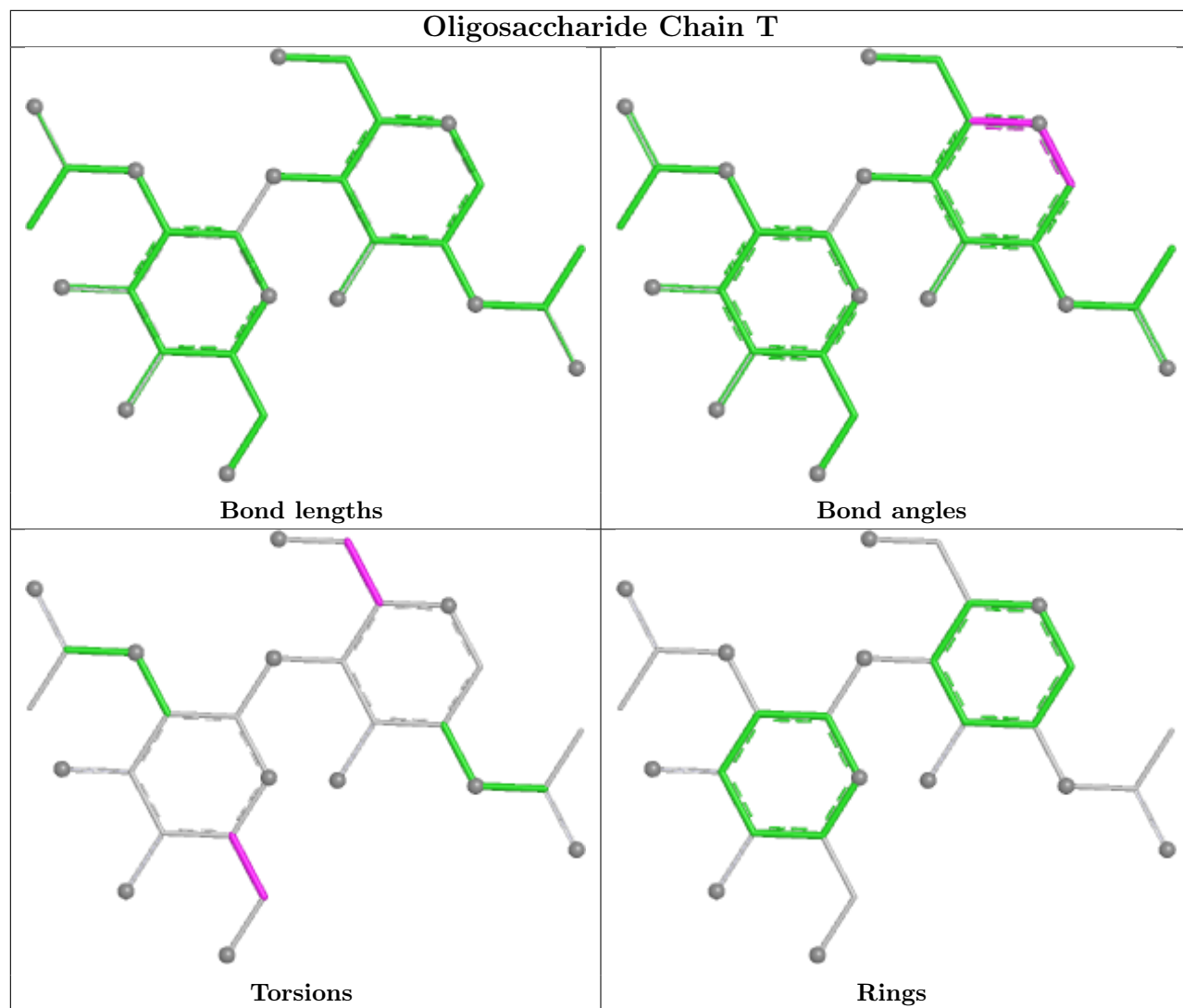

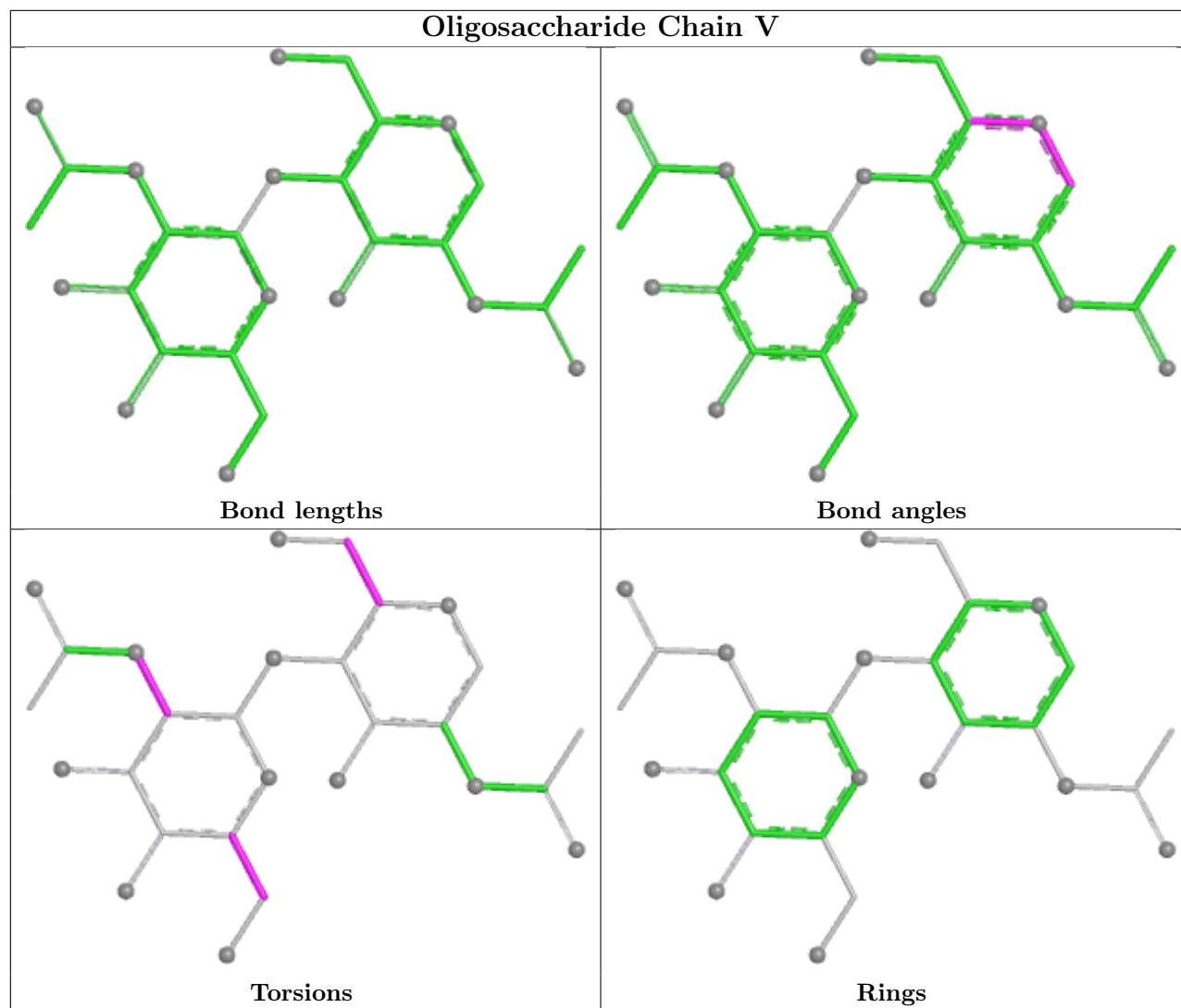

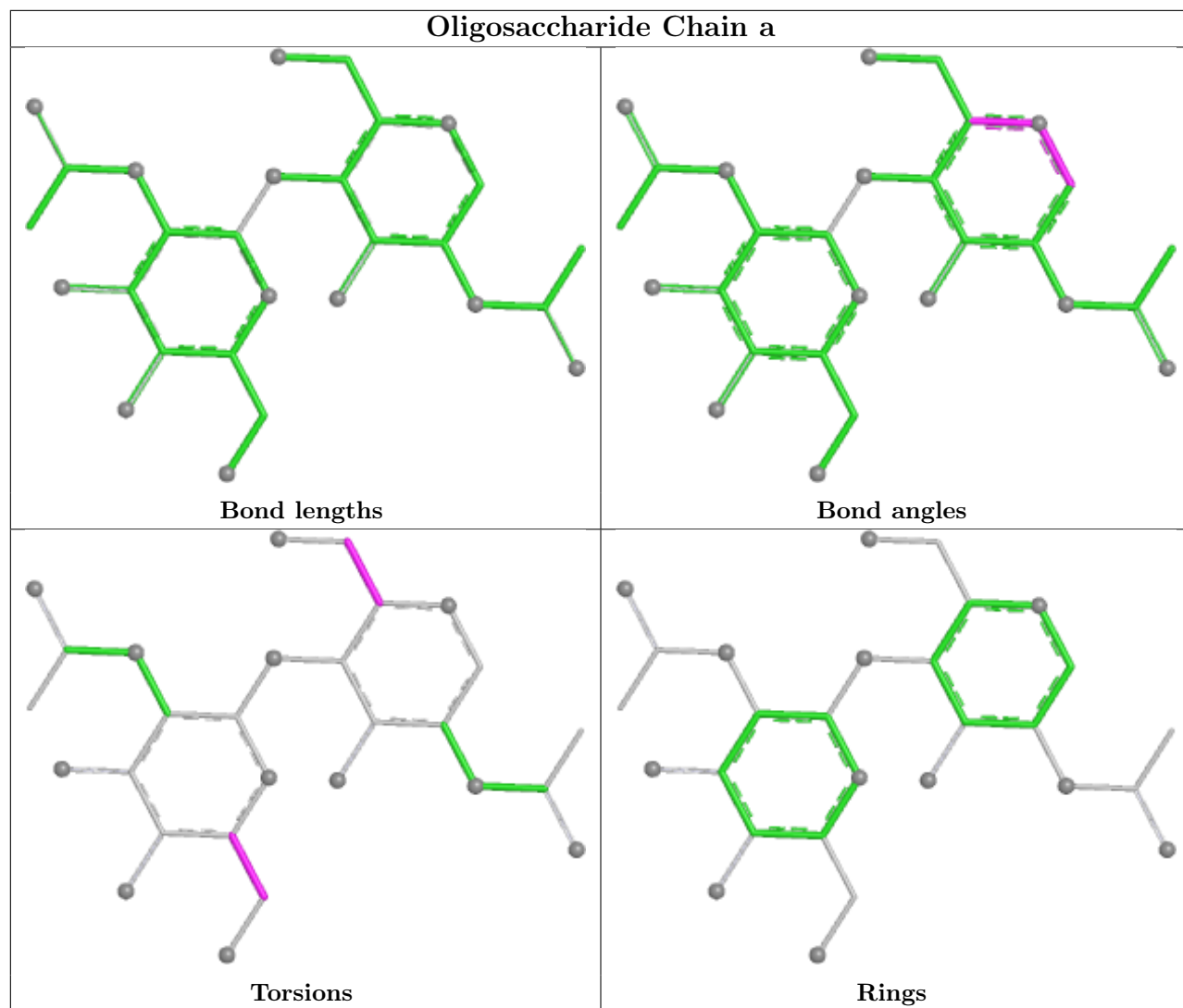

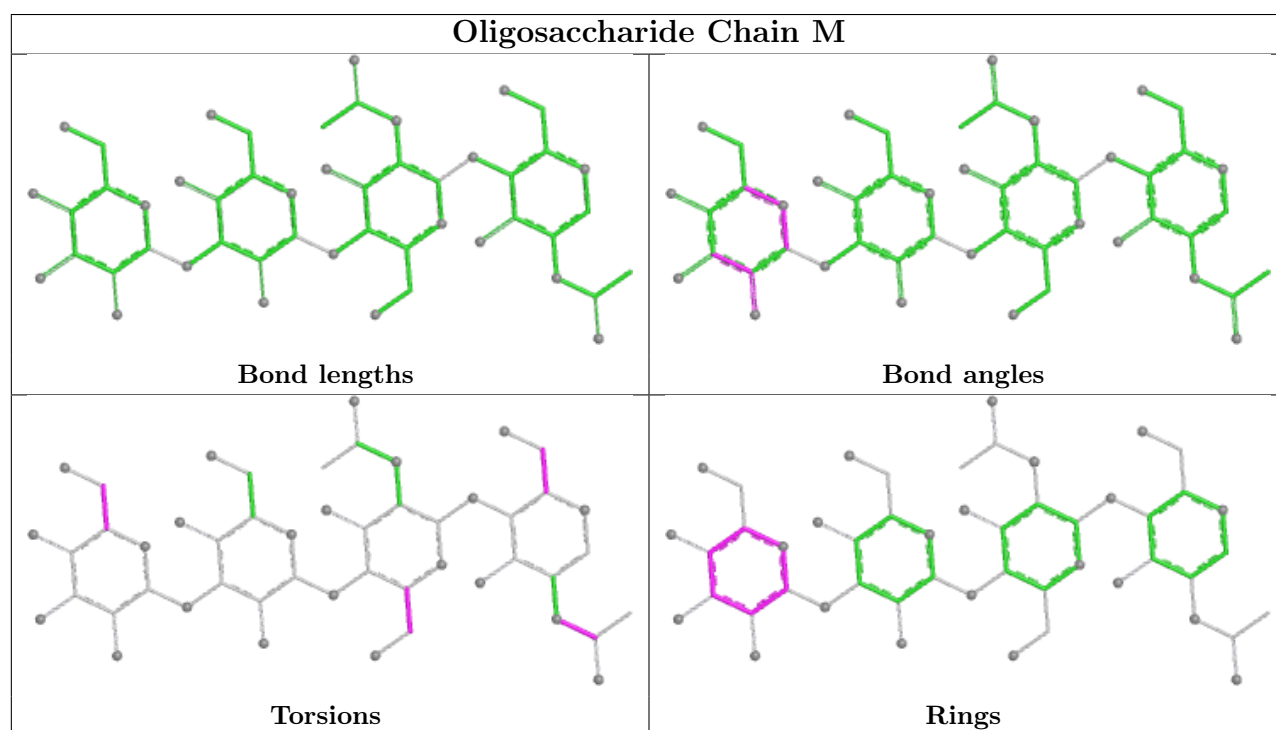
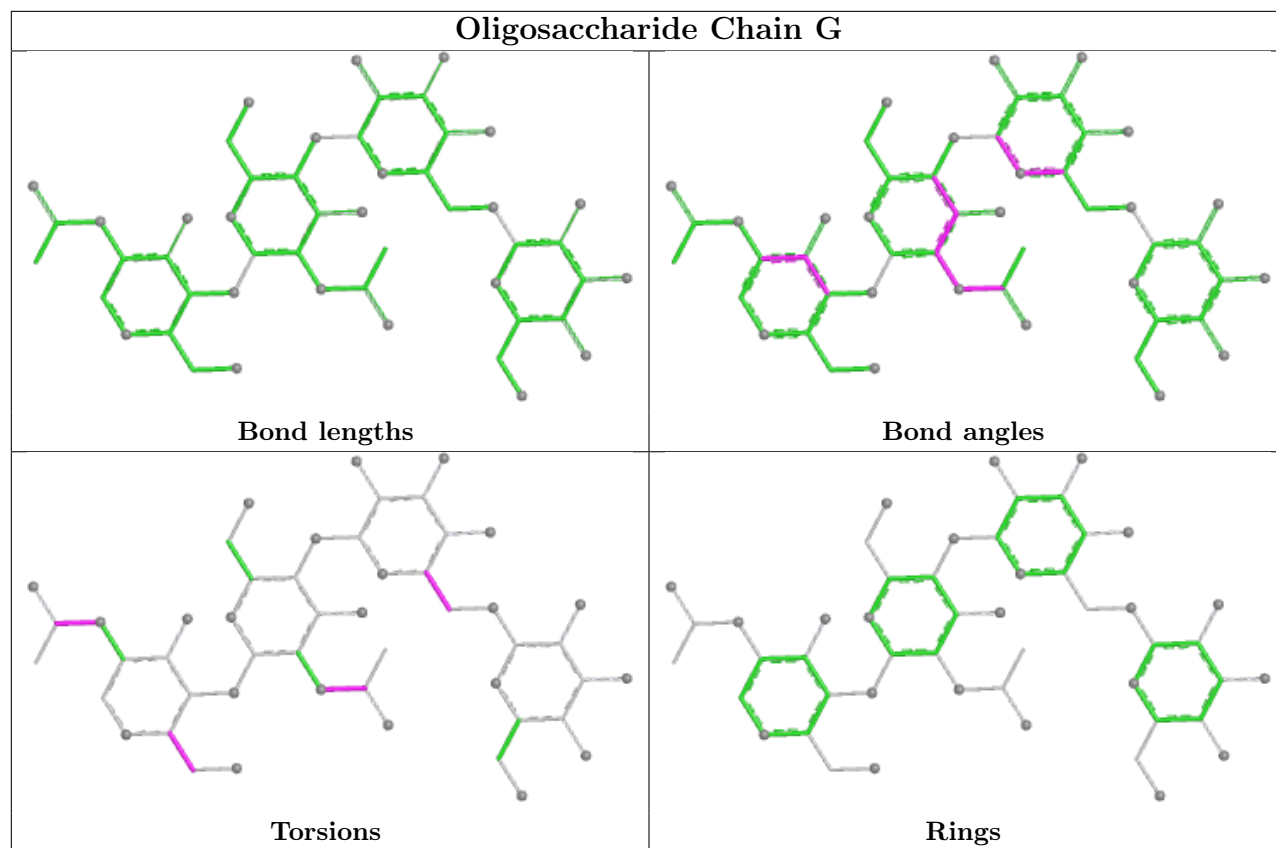

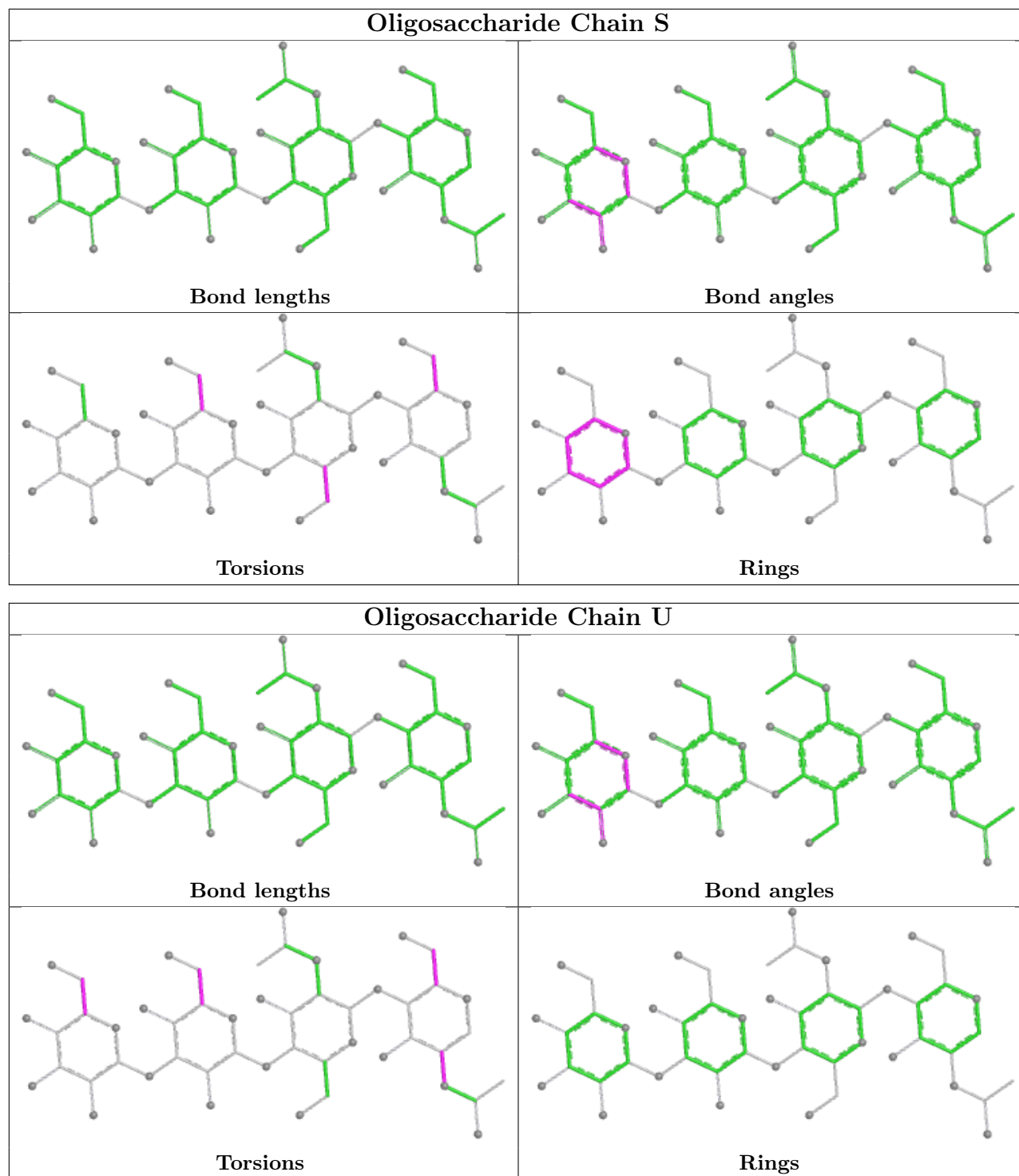

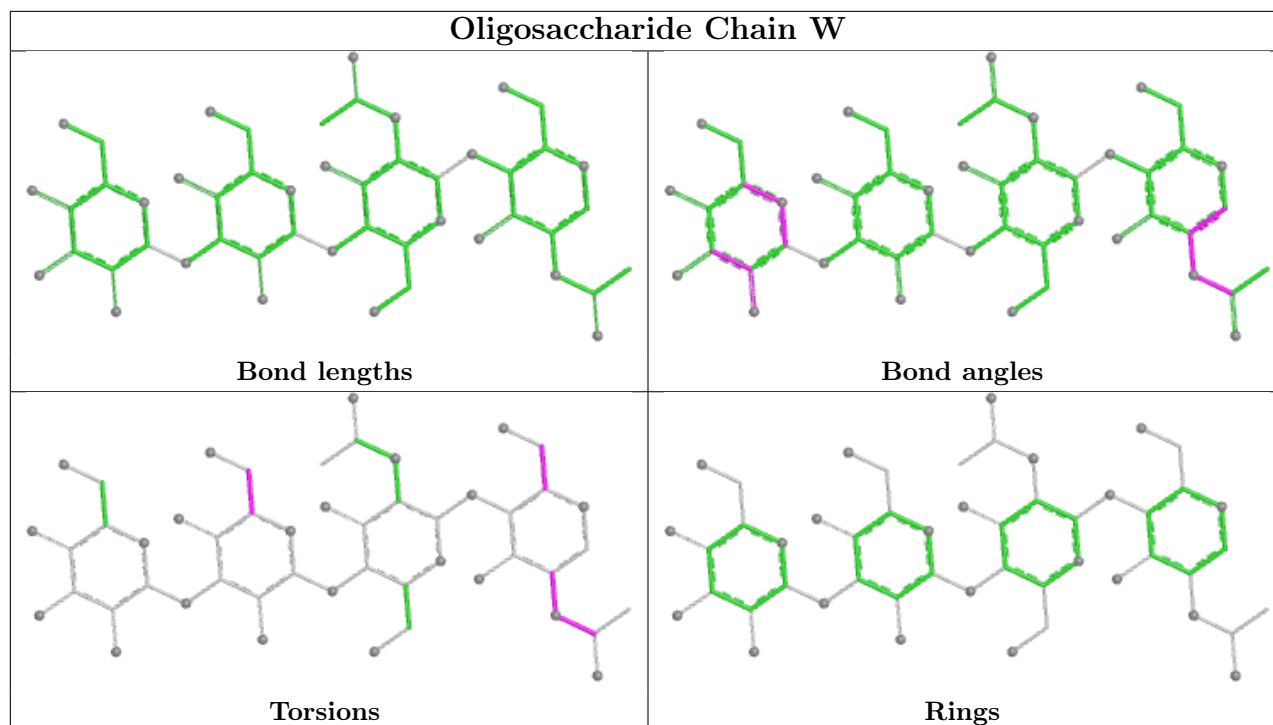

5.6 Ligand geometry [i](#)

9 ligands are modelled in this entry.

In the following table, the Counts columns list the number of bonds (or angles) for which Mogul statistics could be retrieved, the number of bonds (or angles) that are observed in the model and the number of bonds (or angles) that are defined in the Chemical Component Dictionary. The Link column lists molecule types, if any, to which the group is linked. The Z score for a bond length (or angle) is the number of standard deviations the observed value is removed from the expected value. A bond length (or angle) with $|Z| > 2$ is considered an outlier worth inspection. RMSZ is the root-mean-square of all Z scores of the bond lengths (or angles).

Mol	Type	Chain	Res	Link	Bond lengths			Bond angles		
					Counts	RMSZ	$\# Z > 2$	Counts	RMSZ	$\# Z > 2$
10	NAG	C	603	1	14,14,15	0.21	0	17,19,21	0.52	0
10	NAG	B	601	1	14,14,15	0.24	0	17,19,21	0.43	0
10	NAG	B	602	1	14,14,15	0.42	0	17,19,21	0.46	0
10	NAG	A	602	1	14,14,15	0.21	0	17,19,21	0.37	0
10	NAG	C	602	1	14,14,15	0.48	0	17,19,21	1.34	2 (11%)
10	NAG	A	601	-	14,14,15	0.32	0	17,19,21	0.84	1 (5%)
11	MAN	C	601	-	11,11,12	0.65	0	15,15,17	1.01	2 (13%)
10	NAG	A	603	1	14,14,15	0.29	0	17,19,21	0.80	1 (5%)
10	NAG	A	604	1	14,14,15	0.28	0	17,19,21	0.62	0

In the following table, the Chirals column lists the number of chiral outliers, the number of chiral

centers analysed, the number of these observed in the model and the number defined in the Chemical Component Dictionary. Similar counts are reported in the Torsion and Rings columns. '2' means no outliers of that kind were identified.

Mol	Type	Chain	Res	Link	Chirals	Torsions	Rings
10	NAG	C	603	1	-	2/6/23/26	0/1/1/1
10	NAG	B	601	1	-	2/6/23/26	0/1/1/1
10	NAG	B	602	1	-	1/6/23/26	0/1/1/1
10	NAG	A	602	1	-	0/6/23/26	0/1/1/1
10	NAG	C	602	1	-	6/6/23/26	0/1/1/1
10	NAG	A	601	-	-	3/6/23/26	0/1/1/1
11	MAN	C	601	-	-	0/2/19/22	0/1/1/1
10	NAG	A	603	1	-	4/6/23/26	0/1/1/1
10	NAG	A	604	1	-	2/6/23/26	0/1/1/1

There are no bond length outliers.

The worst 5 of 6 bond angle outliers are listed below:

Mol	Chain	Res	Type	Atoms	Z	Observed(°)	Ideal(°)
10	C	602	NAG	C2-N2-C7	4.57	129.02	122.90
10	A	601	NAG	C2-N2-C7	-2.50	119.55	122.90
11	C	601	MAN	C1-O5-C5	2.38	115.38	112.19
10	A	603	NAG	C1-O5-C5	2.17	115.10	112.19
11	C	601	MAN	O2-C2-C3	-2.17	105.66	110.15

There are no chirality outliers.

5 of 20 torsion outliers are listed below:

Mol	Chain	Res	Type	Atoms
10	A	603	NAG	O7-C7-N2-C2
10	A	603	NAG	C8-C7-N2-C2
10	C	603	NAG	O5-C5-C6-O6
10	C	603	NAG	C4-C5-C6-O6
10	C	602	NAG	C8-C7-N2-C2

There are no ring outliers.

3 monomers are involved in 4 short contacts:

Mol	Chain	Res	Type	Clashes	Symm-Clashes
10	C	602	NAG	1	0
10	A	601	NAG	2	0
10	A	603	NAG	1	0

5.7 Other polymers [i](#)

There are no such residues in this entry.

5.8 Polymer linkage issues [i](#)

There are no chain breaks in this entry.

6 Map visualisation [i](#)

This section contains visualisations of the EMDB entry EMD-25877. These allow visual inspection of the internal detail of the map and identification of artifacts.

No raw map or half-maps were deposited for this entry and therefore no images, graphs, etc. pertaining to the raw map can be shown.

6.1 Orthogonal projections [i](#)

6.1.1 Primary map

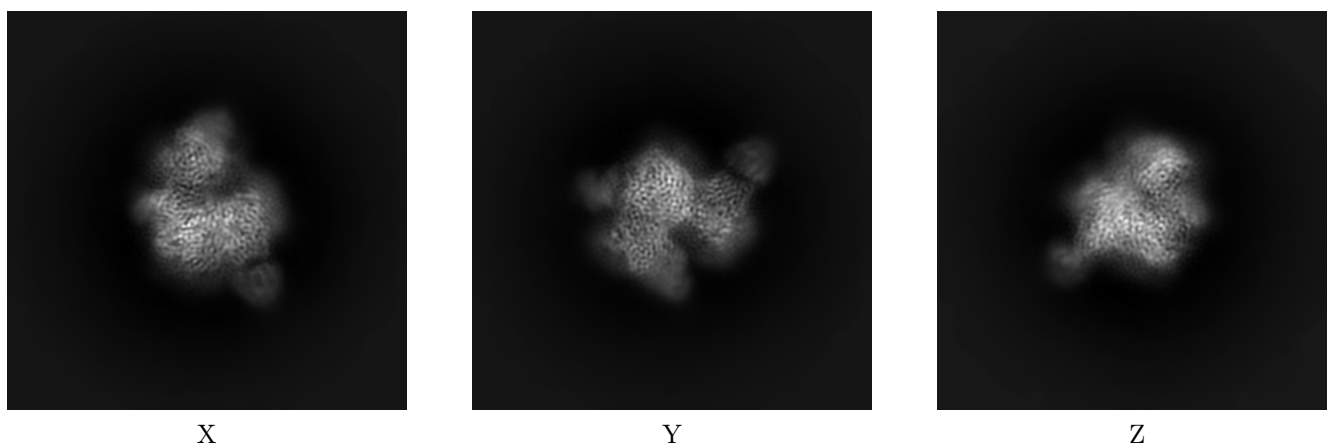

The images above show the map projected in three orthogonal directions.

6.2 Central slices [i](#)

6.2.1 Primary map

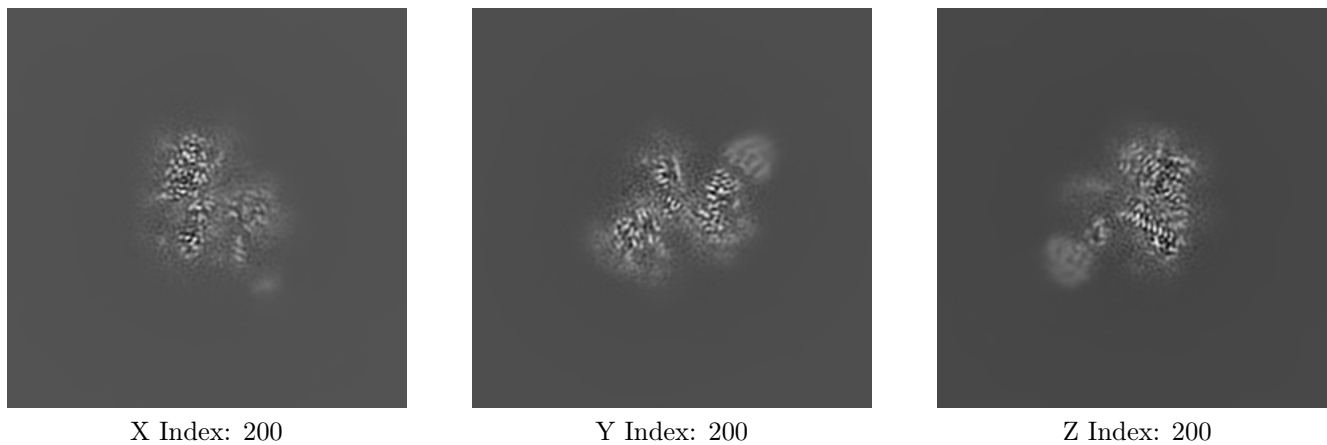

The images above show central slices of the map in three orthogonal directions.

6.3 Largest variance slices [i](#)

6.3.1 Primary map

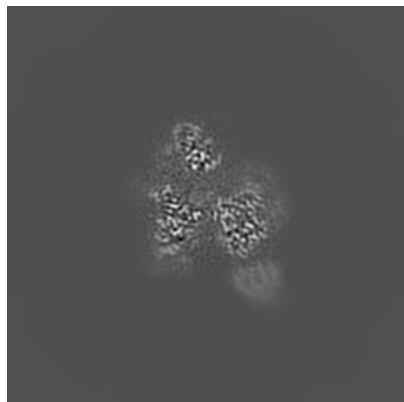

X Index: 219

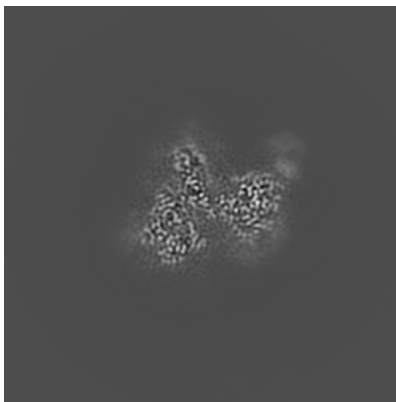

Y Index: 186

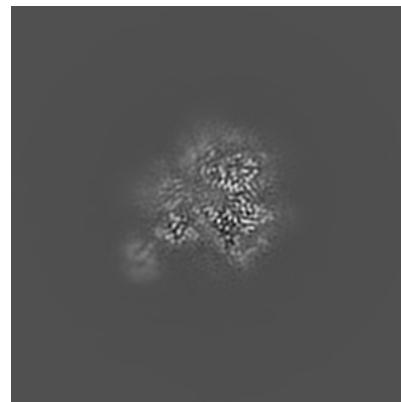

Z Index: 190

The images above show the largest variance slices of the map in three orthogonal directions.

6.4 Orthogonal standard-deviation projections (False-color) [i](#)

6.4.1 Primary map

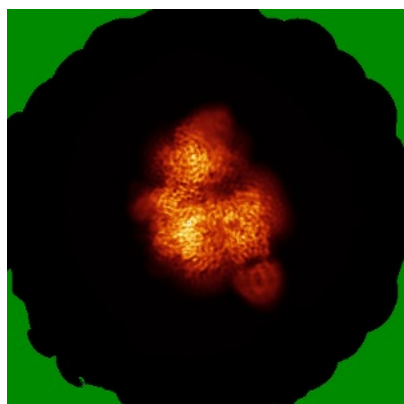

X

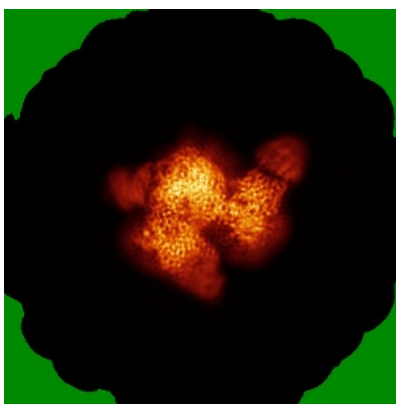

Y

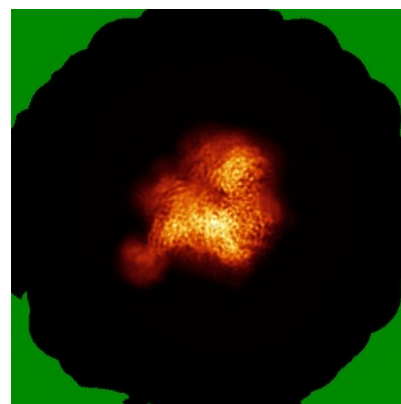

Z

The images above show the map standard deviation projections with false color in three orthogonal directions. Minimum values are shown in green, max in blue, and dark to light orange shades represent small to large values respectively.

6.5 Orthogonal surface views [i](#)

6.5.1 Primary map



The images above show the 3D surface view of the map at the recommended contour level 0.025. These images, in conjunction with the slice images, may facilitate assessment of whether an appropriate contour level has been provided.

6.6 Mask visualisation [i](#)

This section was not generated. No masks/segmentation were deposited.

7 Map analysis [i](#)

This section contains the results of statistical analysis of the map.

7.1 Map-value distribution [i](#)

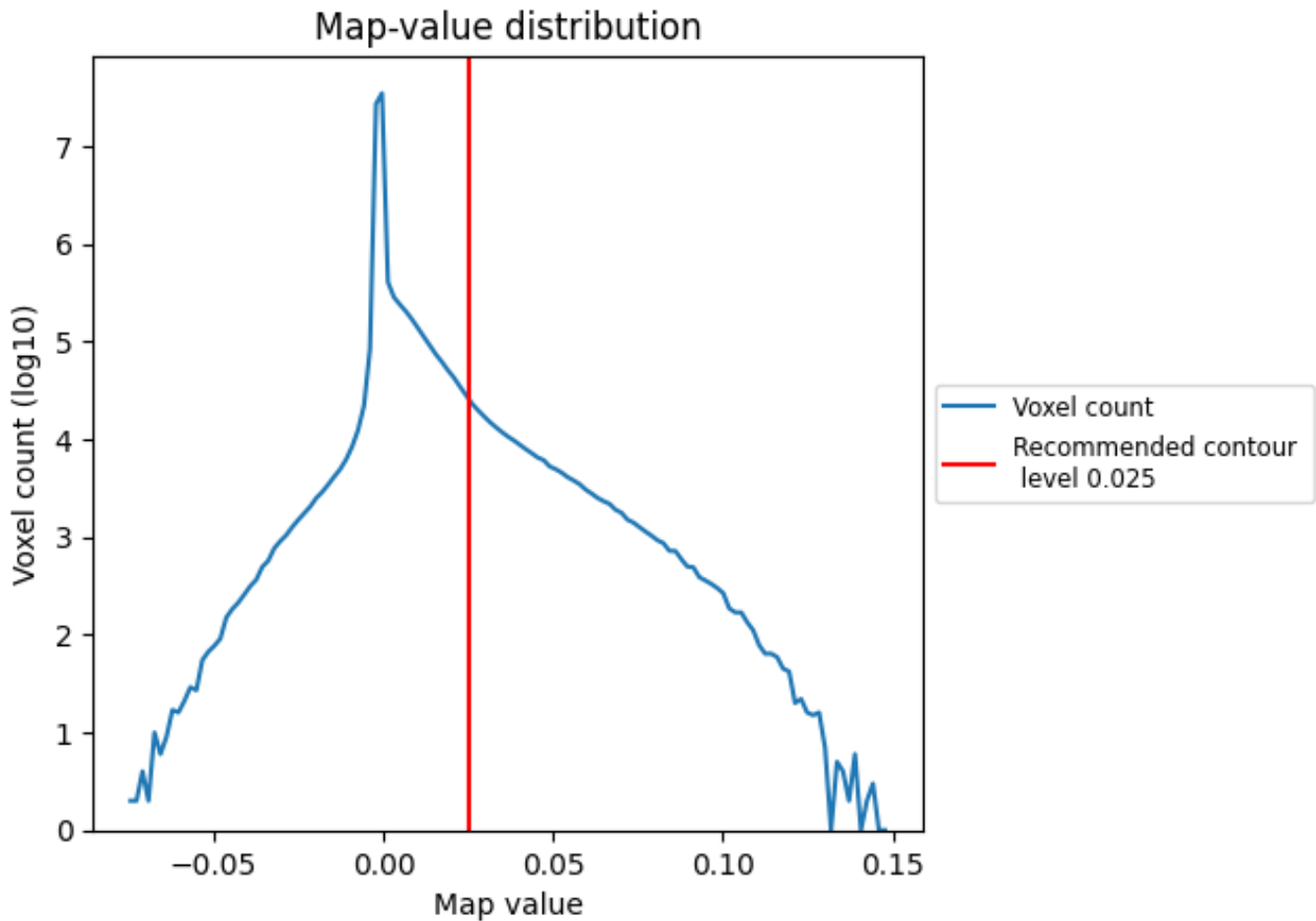

The map-value distribution is plotted in 128 intervals along the x-axis. The y-axis is logarithmic. A spike in this graph at zero usually indicates that the volume has been masked.

7.2 Volume estimate [\(i\)](#)

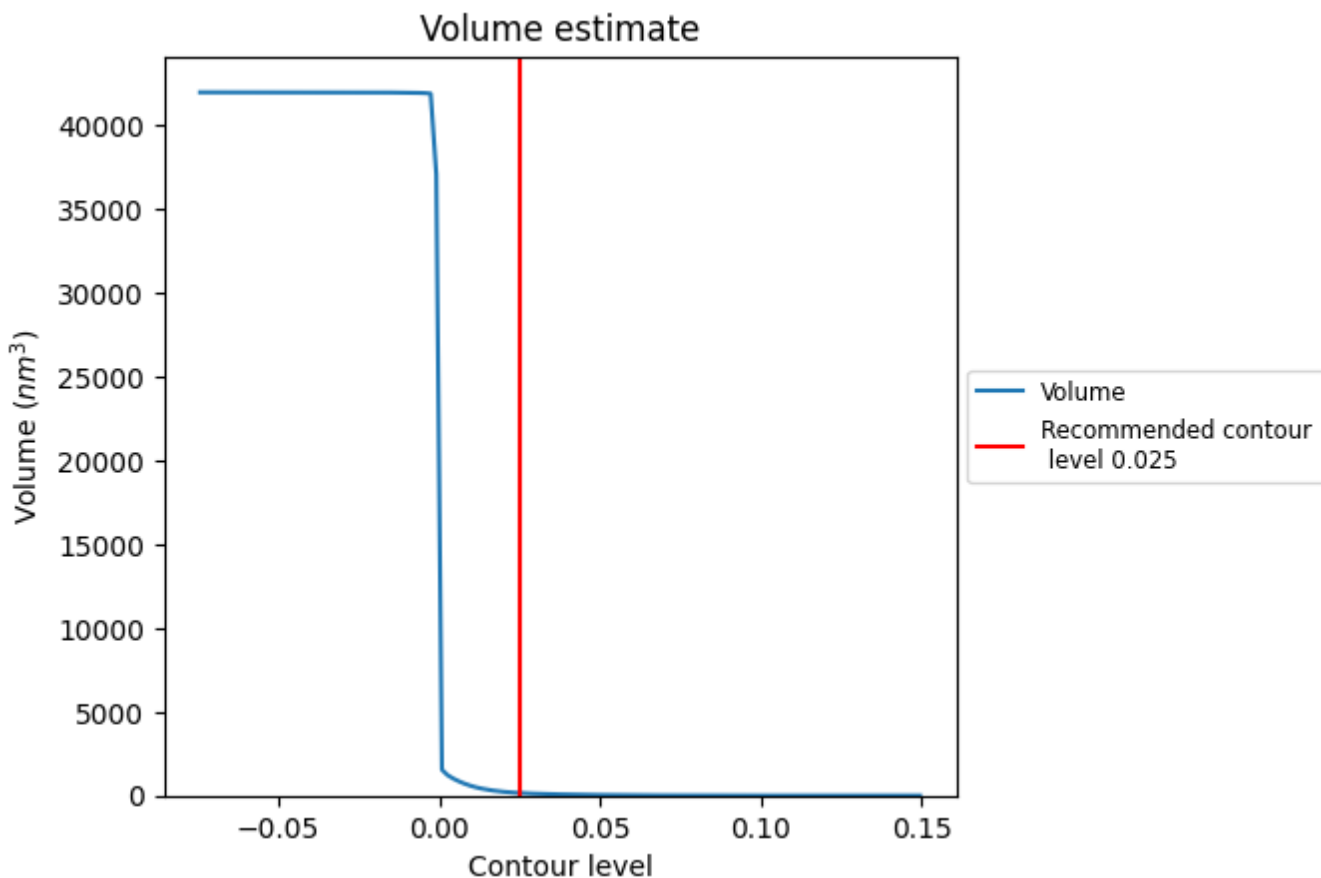

The volume at the recommended contour level is 152 nm³; this corresponds to an approximate mass of 138 kDa.

The volume estimate graph shows how the enclosed volume varies with the contour level. The recommended contour level is shown as a vertical line and the intersection between the line and the curve gives the volume of the enclosed surface at the given level.

7.3 Rotationally averaged power spectrum [i](#)

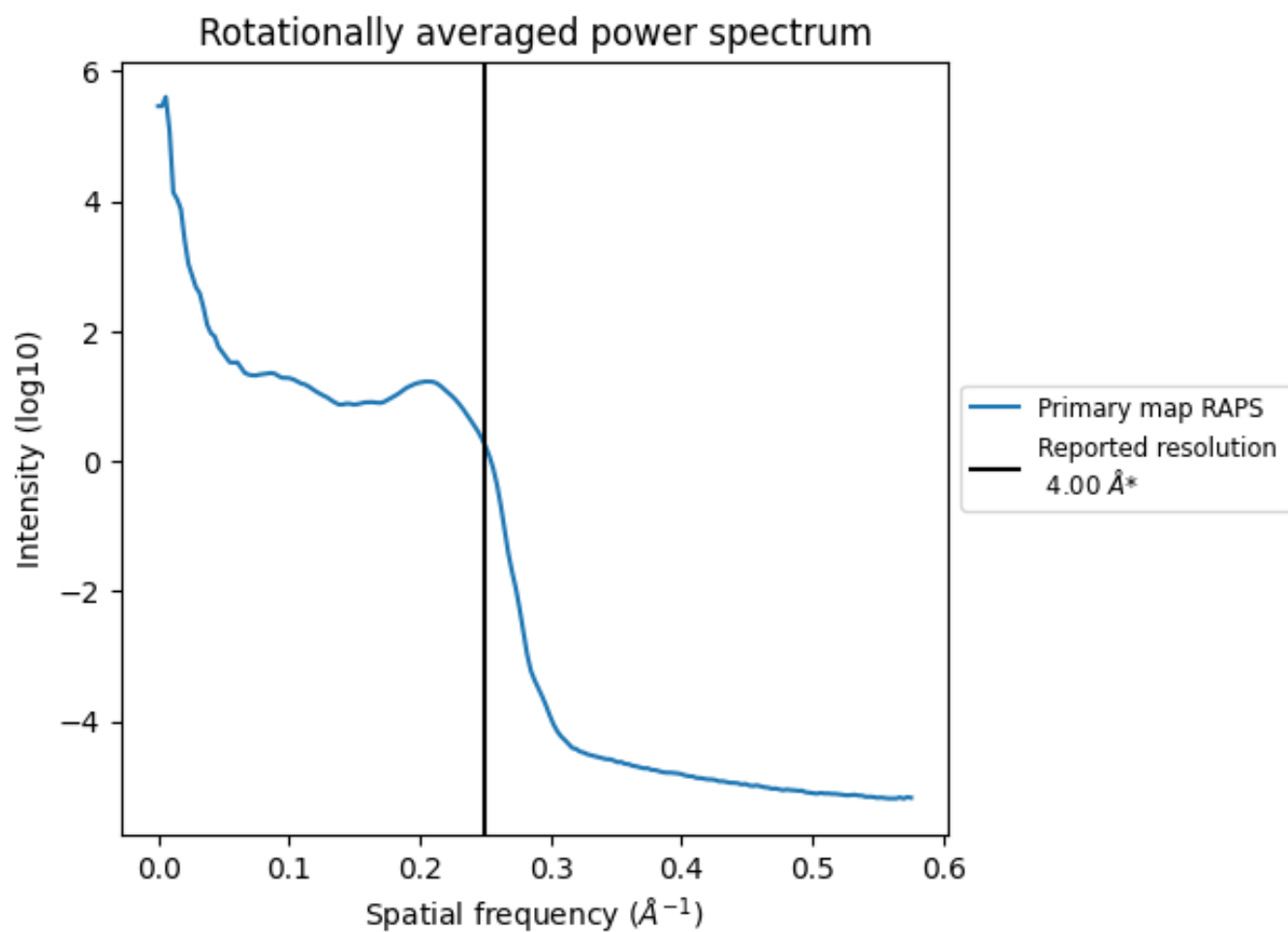

*Reported resolution corresponds to spatial frequency of 0.250\AA^{-1}

8 Fourier-Shell correlation

This section was not generated. No FSC curve or half-maps provided.

9 Map-model fit [i](#)

This section contains information regarding the fit between EMDB map EMD-25877 and PDB model 7TFN. Per-residue inclusion information can be found in section 3 on page 10.

9.1 Map-model overlay [i](#)

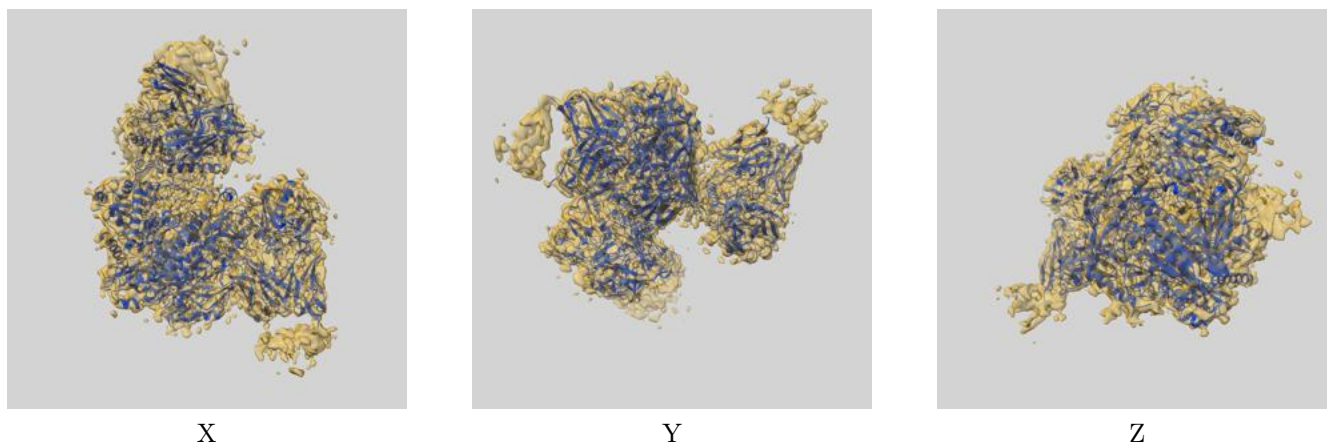

The images above show the 3D surface view of the map at the recommended contour level 0.025 at 50% transparency in yellow overlaid with a ribbon representation of the model coloured in blue. These images allow for the visual assessment of the quality of fit between the atomic model and the map.

9.2 Q-score mapped to coordinate model [\(i\)](#)

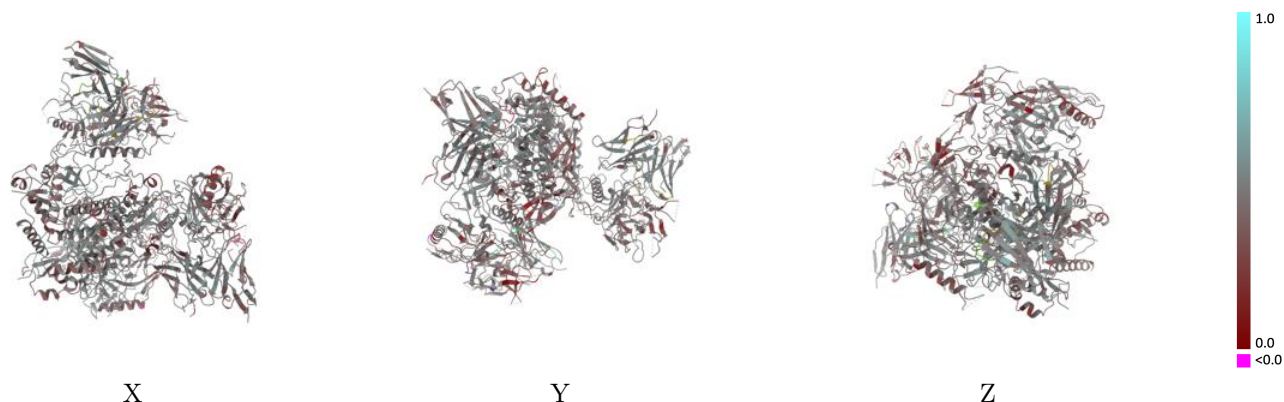

The images above show the model with each residue coloured according to its Q-score. This shows their resolvability in the map with higher Q-score values reflecting better resolvability. Please note: Q-score is calculating the resolvability of atoms, and thus high values are only expected at resolutions at which atoms can be resolved. Low Q-score values may therefore be expected for many entries.

9.3 Atom inclusion mapped to coordinate model [\(i\)](#)

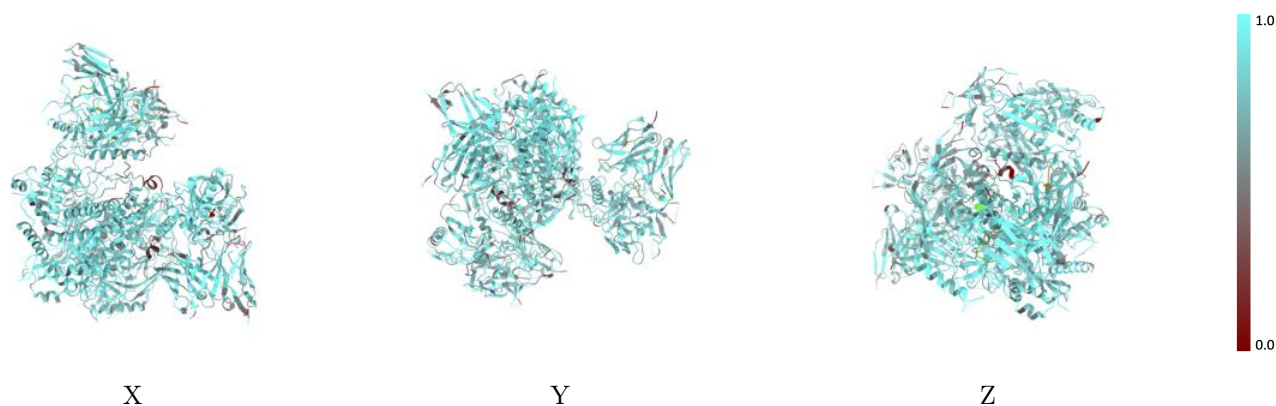

The images above show the model with each residue coloured according to its atom inclusion. This shows to what extent they are inside the map at the recommended contour level (0.025).



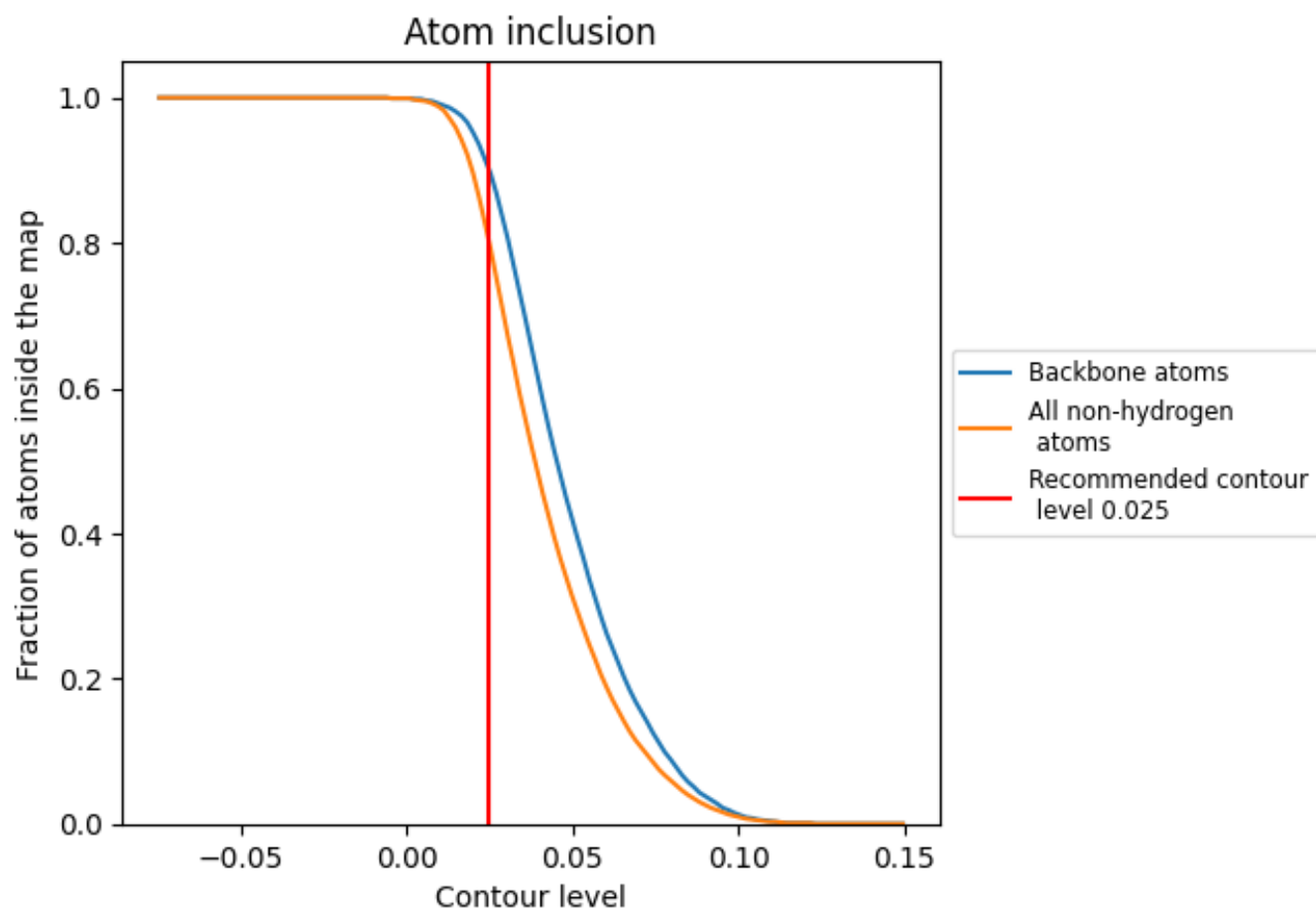























































9.4 Atom inclusion [i](#)



At the recommended contour level, 90% of all backbone atoms, 80% of all non-hydrogen atoms, are inside the map.

9.5 Map-model fit summary

The table lists the average atom inclusion at the recommended contour level (0.025) and Q-score for the entire model and for each chain.

Chain	Atom inclusion	Q-score
All	 0.7990	 0.4370
A	 0.8060	 0.4340
B	 0.7810	 0.4260
C	 0.8070	 0.4440
D	 0.4260	 0.3050
E	 0.5130	 0.3580
F	 0.6430	 0.2860
G	 0.4200	 0.1380
H	 0.8360	 0.4610
I	 0.8280	 0.4580
J	 0.8140	 0.4490
L	 0.7900	 0.4520
M	 0.6800	 0.4570
N	 0.2500	 0.1930
O	 0.5640	 0.3120
P	 0.8330	 0.4650
Q	 0.8180	 0.4670
R	 0.5000	 0.2380
S	 0.5400	 0.3840
T	 0.6430	 0.4230
U	 0.7000	 0.4260
V	 0.4640	 0.4040
W	 0.6000	 0.3500
X	 0.8020	 0.4150
Y	 0.8260	 0.4350
Z	 0.8310	 0.4330
a	 0.7500	 0.4690
b	 0.4620	 0.3520
c	 0.6410	 0.4020

