



Full wwPDB EM Validation Report ⓘ

Dec 4, 2024 – 05:15 am GMT

PDB ID : 8RXD
EMDB ID : EMD-19574
Title : ComM helicase from Legionella pneumophila, coordinating dsDNA and AMP-PNP
Authors : Talachia Rosa, L.; Fronzes, R.
Deposited on : 2024-02-06
Resolution : 3.13 Å(reported)

This is a Full wwPDB EM Validation Report for a publicly released PDB entry.

We welcome your comments at validation@mail.wwpdb.org

A user guide is available at

<https://www.wwpdb.org/validation/2017/EMValidationReportHelp>

with specific help available everywhere you see the ⓘ symbol.

The types of validation reports are described at

<http://www.wwpdb.org/validation/2017/FAQs#types>.

The following versions of software and data (see [references ⓘ](#)) were used in the production of this report:

EMDB validation analysis : 0.0.1.dev113
Mogul : 1.8.4, CSD as541be (2020)
MolProbity : 4.02b-467
buster-report : 1.1.7 (2018)
Percentile statistics : 20231227.v01 (using entries in the PDB archive December 27th 2023)
MapQ : 1.9.13
Ideal geometry (proteins) : Engh & Huber (2001)
Ideal geometry (DNA, RNA) : Parkinson et al. (1996)
Validation Pipeline (wwPDB-VP) : 2.40

1 Overall quality at a glance i

The following experimental techniques were used to determine the structure:

ELECTRON MICROSCOPY

The reported resolution of this entry is 3.13 Å.

Percentile scores (ranging between 0-100) for global validation metrics of the entry are shown in the following graphic. The table shows the number of entries on which the scores are based.

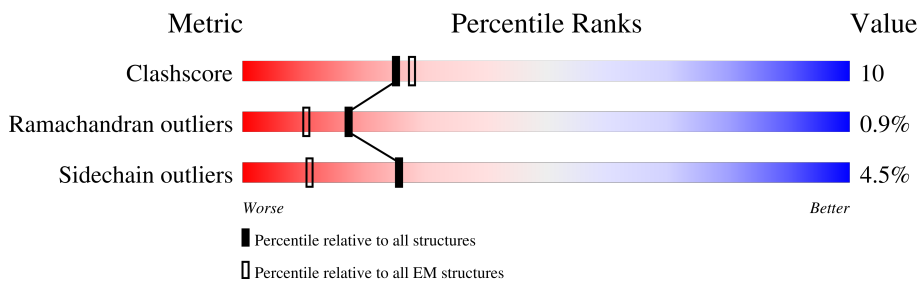

Metric	Whole archive (#Entries)	EM structures (#Entries)
Clashscore	210492	15764
Ramachandran outliers	207382	16835
Sidechain outliers	206894	16415

The table below summarises the geometric issues observed across the polymeric chains and their fit to the map. The red, orange, yellow and green segments of the bar indicate the fraction of residues that contain outliers for ≥ 3 , 2, 1 and 0 types of geometric quality criteria respectively. A grey segment represents the fraction of residues that are not modelled. The numeric value for each fraction is indicated below the corresponding segment, with a dot representing fractions $\leq 5\%$. The upper red bar (where present) indicates the fraction of residues that have poor fit to the EM map (all-atom inclusion $< 40\%$). The numeric value is given above the bar.

Mol	Chain	Length	Quality of chain
1	A	509	20% (Upper red bar) 71% (Green) 23% (Yellow) 5% (Orange) 5% (Grey)
1	B	509	10% (Upper red bar) 75% (Green) 19% (Yellow) 5% (Orange) 5% (Grey)
1	C	509	10% (Upper red bar) 72% (Green) 21% (Yellow) 5% (Orange) 5% (Grey)
1	D	509	12% (Upper red bar) 65% (Green) 27% (Yellow) 6% (Orange) 6% (Grey)
1	E	509	21% (Upper red bar) 67% (Green) 26% (Yellow) 6% (Orange) 6% (Grey)
1	F	509	40% (Upper red bar) 71% (Green) 22% (Yellow) 6% (Orange) 6% (Grey)
2	Y	60	25% (Upper red bar) 32% (Green) 8% (Yellow) 60% (Grey)
3	Z	120	9% (Upper red bar) 12% (Green) 8% (Yellow) 80% (Grey)

2 Entry composition i

There are 4 unique types of molecules in this entry. The entry contains 23172 atoms, of which 0 are hydrogens and 0 are deuteriums.

In the tables below, the AltConf column contains the number of residues with at least one atom in alternate conformation and the Trace column contains the number of residues modelled with at most 2 atoms.

- Molecule 1 is a protein called Competence related protein ComM.

Mol	Chain	Residues	Atoms					AltConf	Trace
			Total	C	N	O	S		
1	F	480	3583	2251	642	669	21	0	0
1	A	486	3723	2346	666	690	21	0	0
1	B	486	3723	2346	666	690	21	0	0
1	C	486	3719	2343	665	690	21	0	0
1	D	480	3675	2316	658	680	21	0	0
1	E	480	3641	2293	654	673	21	0	0

There are 120 discrepancies between the modelled and reference sequences:

Chain	Residue	Modelled	Actual	Comment	Reference
F	2	SER	ASN	variant	UNP Q5ZXZ0
F	31	SER	GLY	variant	UNP Q5ZXZ0
F	152	GLN	PRO	variant	UNP Q5ZXZ0
F	175	SER	ASN	variant	UNP Q5ZXZ0
F	187	TYR	HIS	variant	UNP Q5ZXZ0
F	198	GLN	HIS	variant	UNP Q5ZXZ0
F	361	MET	LEU	variant	UNP Q5ZXZ0
F	408	LEU	PRO	variant	UNP Q5ZXZ0
F	479	ASN	SER	variant	UNP Q5ZXZ0
F	480	SER	GLU	variant	UNP Q5ZXZ0
F	481	SER	CYS	variant	UNP Q5ZXZ0
F	482	LYS	ASN	variant	UNP Q5ZXZ0
F	485	LEU	MET	variant	UNP Q5ZXZ0
F	498	ASN	ILE	variant	UNP Q5ZXZ0
F	504	HIS	-	expression tag	UNP Q5ZXZ0
F	505	HIS	-	expression tag	UNP Q5ZXZ0
F	506	HIS	-	expression tag	UNP Q5ZXZ0
F	507	HIS	-	expression tag	UNP Q5ZXZ0

Continued on next page...

Continued from previous page...

Chain	Residue	Modelled	Actual	Comment	Reference
F	508	HIS	-	expression tag	UNP Q5ZXZ0
F	509	HIS	-	expression tag	UNP Q5ZXZ0
A	2	SER	ASN	variant	UNP Q5ZXZ0
A	31	SER	GLY	variant	UNP Q5ZXZ0
A	152	GLN	PRO	variant	UNP Q5ZXZ0
A	175	SER	ASN	variant	UNP Q5ZXZ0
A	187	TYR	HIS	variant	UNP Q5ZXZ0
A	198	GLN	HIS	variant	UNP Q5ZXZ0
A	361	MET	LEU	variant	UNP Q5ZXZ0
A	408	LEU	PRO	variant	UNP Q5ZXZ0
A	479	ASN	SER	variant	UNP Q5ZXZ0
A	480	SER	GLU	variant	UNP Q5ZXZ0
A	481	SER	CYS	variant	UNP Q5ZXZ0
A	482	LYS	ASN	variant	UNP Q5ZXZ0
A	485	LEU	MET	variant	UNP Q5ZXZ0
A	498	ASN	ILE	variant	UNP Q5ZXZ0
A	504	HIS	-	expression tag	UNP Q5ZXZ0
A	505	HIS	-	expression tag	UNP Q5ZXZ0
A	506	HIS	-	expression tag	UNP Q5ZXZ0
A	507	HIS	-	expression tag	UNP Q5ZXZ0
A	508	HIS	-	expression tag	UNP Q5ZXZ0
A	509	HIS	-	expression tag	UNP Q5ZXZ0
B	2	SER	ASN	variant	UNP Q5ZXZ0
B	31	SER	GLY	variant	UNP Q5ZXZ0
B	152	GLN	PRO	variant	UNP Q5ZXZ0
B	175	SER	ASN	variant	UNP Q5ZXZ0
B	187	TYR	HIS	variant	UNP Q5ZXZ0
B	198	GLN	HIS	variant	UNP Q5ZXZ0
B	361	MET	LEU	variant	UNP Q5ZXZ0
B	408	LEU	PRO	variant	UNP Q5ZXZ0
B	479	ASN	SER	variant	UNP Q5ZXZ0
B	480	SER	GLU	variant	UNP Q5ZXZ0
B	481	SER	CYS	variant	UNP Q5ZXZ0
B	482	LYS	ASN	variant	UNP Q5ZXZ0
B	485	LEU	MET	variant	UNP Q5ZXZ0
B	498	ASN	ILE	variant	UNP Q5ZXZ0
B	504	HIS	-	expression tag	UNP Q5ZXZ0
B	505	HIS	-	expression tag	UNP Q5ZXZ0
B	506	HIS	-	expression tag	UNP Q5ZXZ0
B	507	HIS	-	expression tag	UNP Q5ZXZ0
B	508	HIS	-	expression tag	UNP Q5ZXZ0
B	509	HIS	-	expression tag	UNP Q5ZXZ0

Continued on next page...

Continued from previous page...

Chain	Residue	Modelled	Actual	Comment	Reference
C	2	SER	ASN	variant	UNP Q5ZXZ0
C	31	SER	GLY	variant	UNP Q5ZXZ0
C	152	GLN	PRO	variant	UNP Q5ZXZ0
C	175	SER	ASN	variant	UNP Q5ZXZ0
C	187	TYR	HIS	variant	UNP Q5ZXZ0
C	198	GLN	HIS	variant	UNP Q5ZXZ0
C	361	MET	LEU	variant	UNP Q5ZXZ0
C	408	LEU	PRO	variant	UNP Q5ZXZ0
C	479	ASN	SER	variant	UNP Q5ZXZ0
C	480	SER	GLU	variant	UNP Q5ZXZ0
C	481	SER	CYS	variant	UNP Q5ZXZ0
C	482	LYS	ASN	variant	UNP Q5ZXZ0
C	485	LEU	MET	variant	UNP Q5ZXZ0
C	498	ASN	ILE	variant	UNP Q5ZXZ0
C	504	HIS	-	expression tag	UNP Q5ZXZ0
C	505	HIS	-	expression tag	UNP Q5ZXZ0
C	506	HIS	-	expression tag	UNP Q5ZXZ0
C	507	HIS	-	expression tag	UNP Q5ZXZ0
C	508	HIS	-	expression tag	UNP Q5ZXZ0
C	509	HIS	-	expression tag	UNP Q5ZXZ0
D	2	SER	ASN	variant	UNP Q5ZXZ0
D	31	SER	GLY	variant	UNP Q5ZXZ0
D	152	GLN	PRO	variant	UNP Q5ZXZ0
D	175	SER	ASN	variant	UNP Q5ZXZ0
D	187	TYR	HIS	variant	UNP Q5ZXZ0
D	198	GLN	HIS	variant	UNP Q5ZXZ0
D	361	MET	LEU	variant	UNP Q5ZXZ0
D	408	LEU	PRO	variant	UNP Q5ZXZ0
D	479	ASN	SER	variant	UNP Q5ZXZ0
D	480	SER	GLU	variant	UNP Q5ZXZ0
D	481	SER	CYS	variant	UNP Q5ZXZ0
D	482	LYS	ASN	variant	UNP Q5ZXZ0
D	485	LEU	MET	variant	UNP Q5ZXZ0
D	498	ASN	ILE	variant	UNP Q5ZXZ0
D	504	HIS	-	expression tag	UNP Q5ZXZ0
D	505	HIS	-	expression tag	UNP Q5ZXZ0
D	506	HIS	-	expression tag	UNP Q5ZXZ0
D	507	HIS	-	expression tag	UNP Q5ZXZ0
D	508	HIS	-	expression tag	UNP Q5ZXZ0
D	509	HIS	-	expression tag	UNP Q5ZXZ0
E	2	SER	ASN	variant	UNP Q5ZXZ0
E	31	SER	GLY	variant	UNP Q5ZXZ0

Continued on next page...

Continued from previous page...

Chain	Residue	Modelled	Actual	Comment	Reference
E	152	GLN	PRO	variant	UNP Q5ZXZ0
E	175	SER	ASN	variant	UNP Q5ZXZ0
E	187	TYR	HIS	variant	UNP Q5ZXZ0
E	198	GLN	HIS	variant	UNP Q5ZXZ0
E	361	MET	LEU	variant	UNP Q5ZXZ0
E	408	LEU	PRO	variant	UNP Q5ZXZ0
E	479	ASN	SER	variant	UNP Q5ZXZ0
E	480	SER	GLU	variant	UNP Q5ZXZ0
E	481	SER	CYS	variant	UNP Q5ZXZ0
E	482	LYS	ASN	variant	UNP Q5ZXZ0
E	485	LEU	MET	variant	UNP Q5ZXZ0
E	498	ASN	ILE	variant	UNP Q5ZXZ0
E	504	HIS	-	expression tag	UNP Q5ZXZ0
E	505	HIS	-	expression tag	UNP Q5ZXZ0
E	506	HIS	-	expression tag	UNP Q5ZXZ0
E	507	HIS	-	expression tag	UNP Q5ZXZ0
E	508	HIS	-	expression tag	UNP Q5ZXZ0
E	509	HIS	-	expression tag	UNP Q5ZXZ0

- Molecule 2 is a DNA chain called Poly-dT.

Mol	Chain	Residues	Atoms					AltConf	Trace
			Total	C	N	O	P		
2	Y	24	480	240	48	168	24	0	0

- Molecule 3 is a DNA chain called Poly-dA Poly-dC.

Mol	Chain	Residues	Atoms					AltConf	Trace
			Total	C	N	O	P		
3	Z	24	504	240	120	120	24	0	0

- Molecule 4 is PHOSPHOAMINOPHOSPHONIC ACID-ADENYLATE ESTER (three-letter code: ANP) (formula: C₁₀H₁₇N₆O₁₂P₃) (labeled as "Ligand of Interest" by depositor).

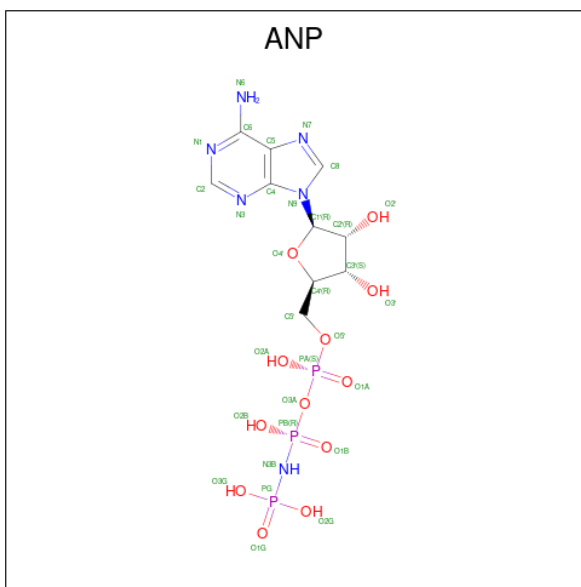

Mol	Chain	Residues	Atoms					AltConf
			Total	C	N	O	P	
4	A	1	Total	C	N	O	P	0
			31	10	6	12	3	
4	B	1	Total	C	N	O	P	0
			31	10	6	12	3	
4	C	1	Total	C	N	O	P	0
			31	10	6	12	3	
4	D	1	Total	C	N	O	P	0
			31	10	6	12	3	

3 Residue-property plots i

These plots are drawn for all protein, RNA, DNA and oligosaccharide chains in the entry. The first graphic for a chain summarises the proportions of the various outlier classes displayed in the second graphic. The second graphic shows the sequence view annotated by issues in geometry and atom inclusion in map density. Residues are color-coded according to the number of geometric quality criteria for which they contain at least one outlier: green = 0, yellow = 1, orange = 2 and red = 3 or more. A red diamond above a residue indicates a poor fit to the EM map for this residue (all-atom inclusion < 40%). Stretches of 2 or more consecutive residues without any outlier are shown as a green connector. Residues present in the sample, but not in the model, are shown in grey.

- Molecule 1: Competence related protein ComM

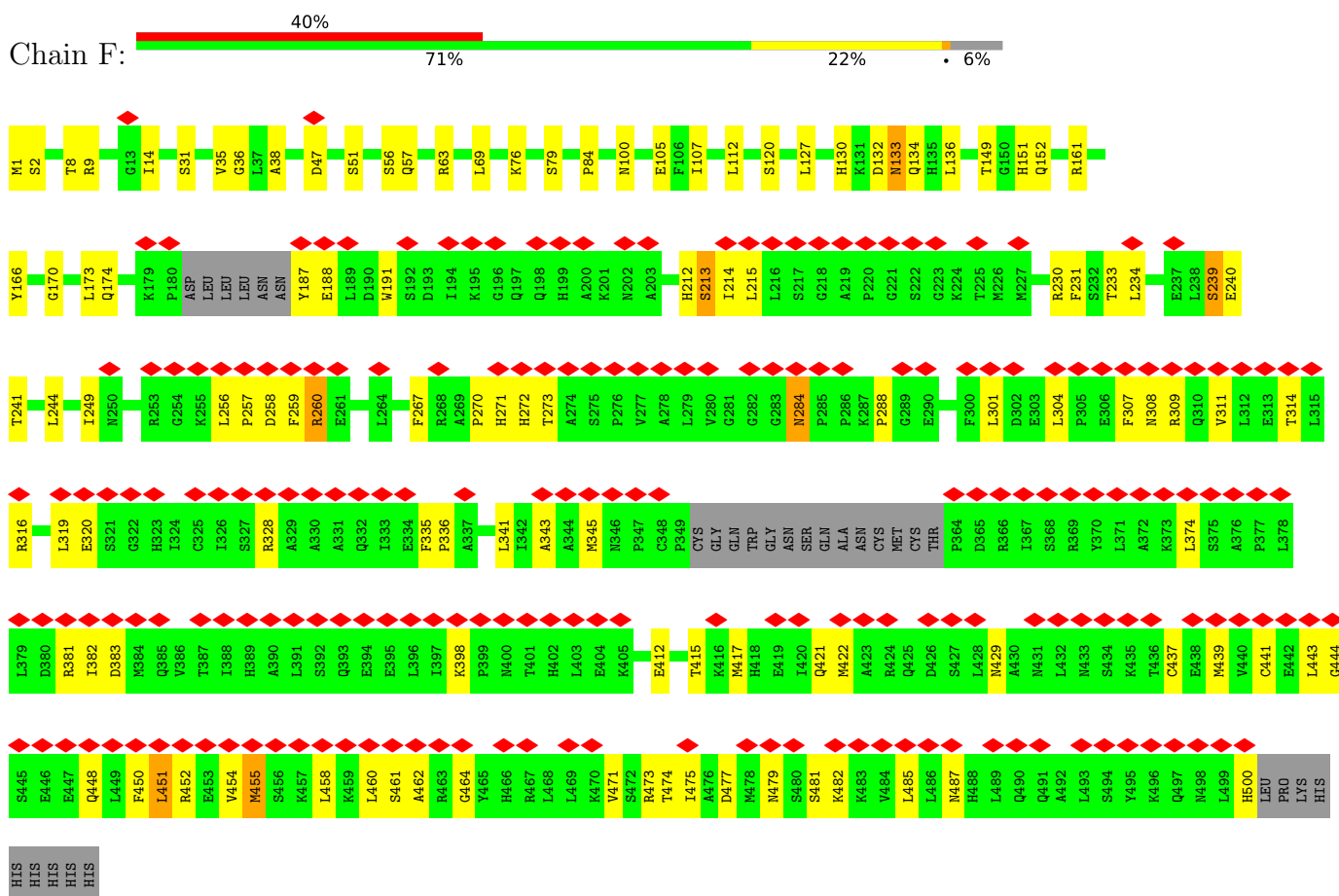

- Molecule 1: Competence related protein ComM

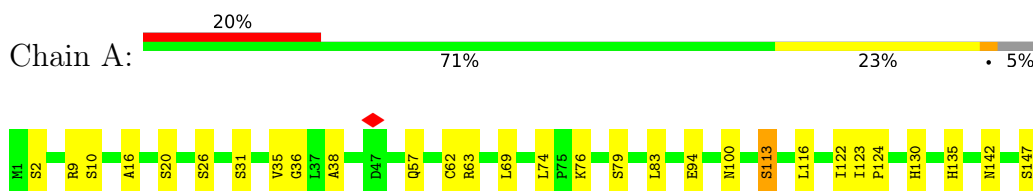

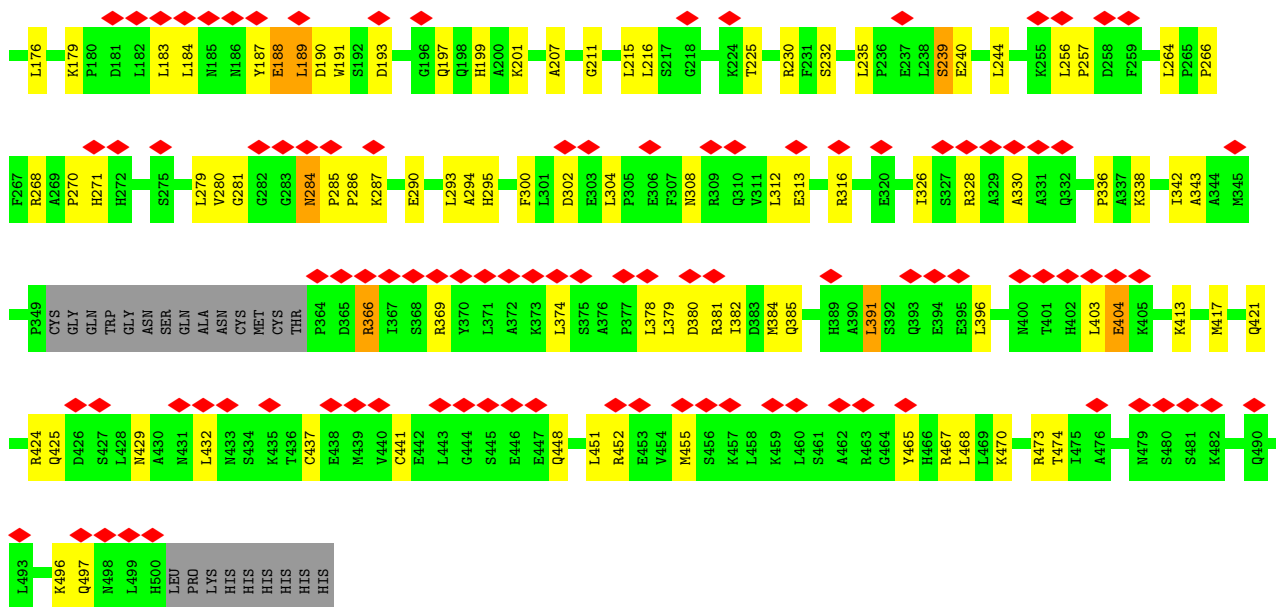

• Molecule 1: Competence related protein ComM

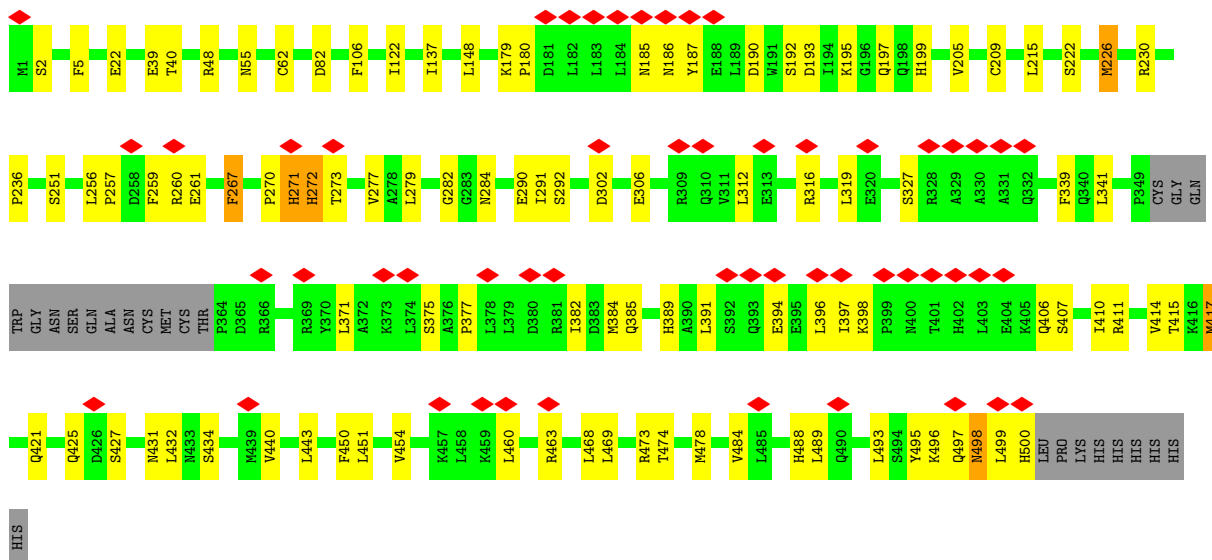
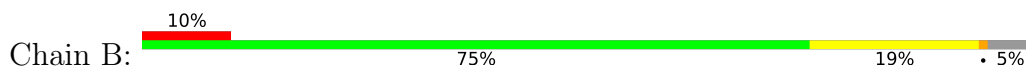

• Molecule 1: Competence related protein ComM

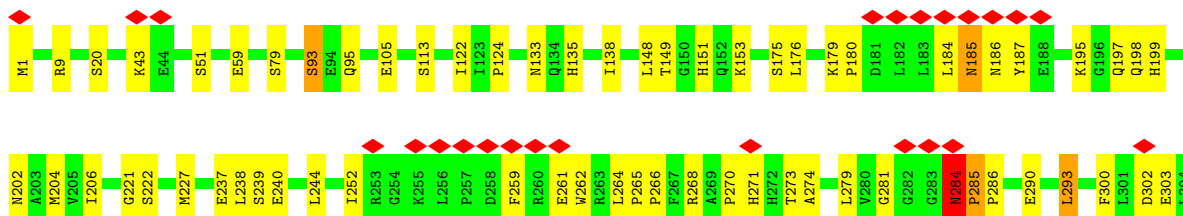
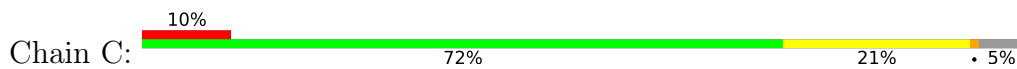

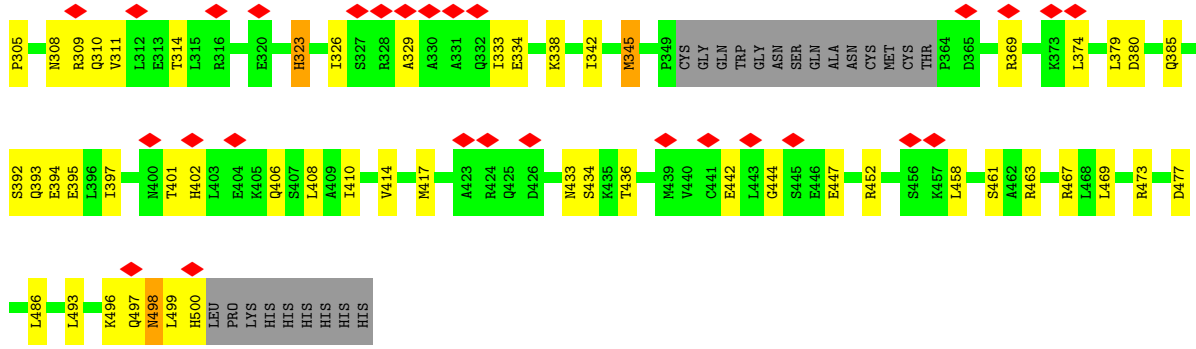

• Molecule 1: Competence related protein ComM

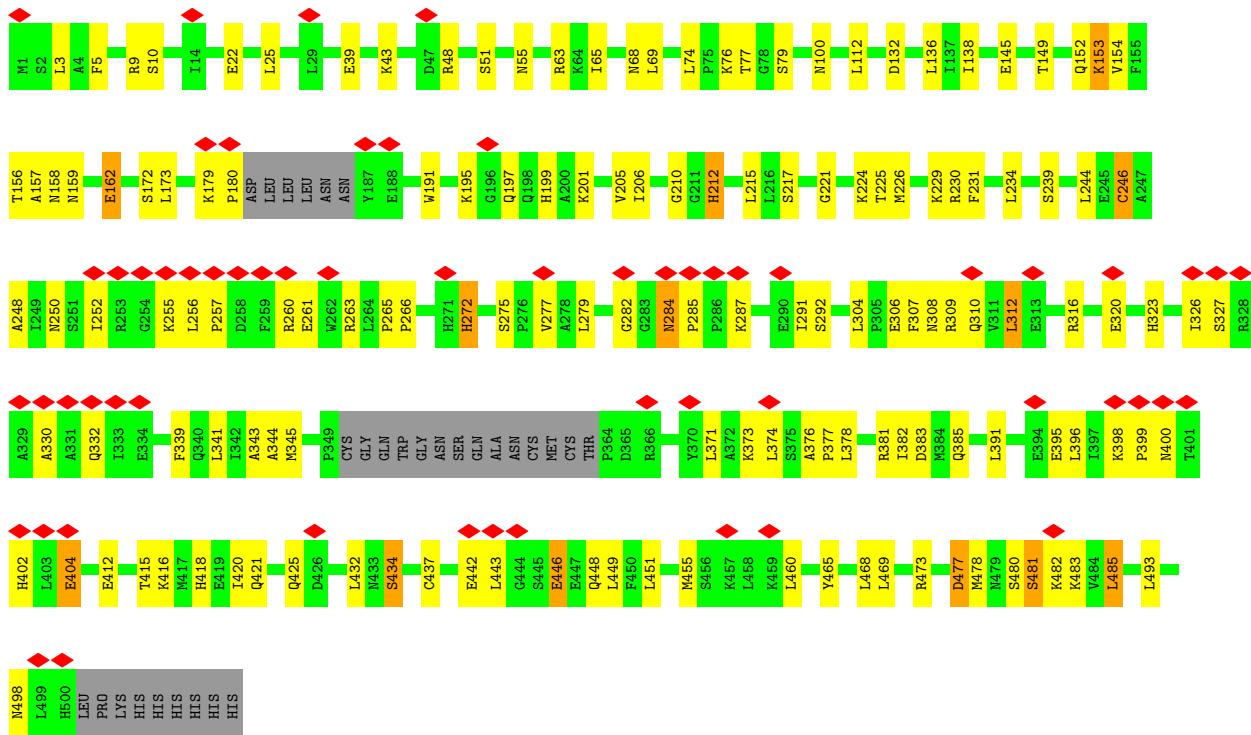

• Molecule 1: Competence related protein ComM

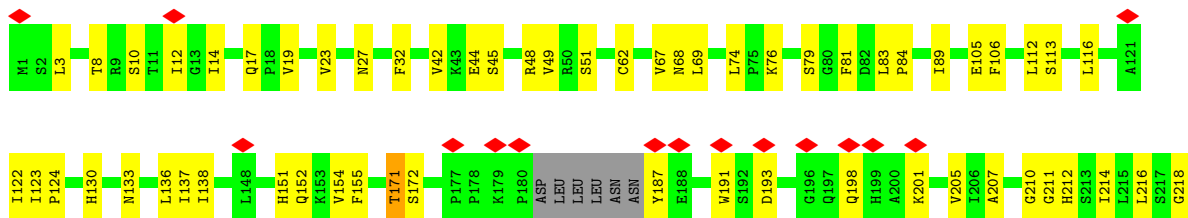

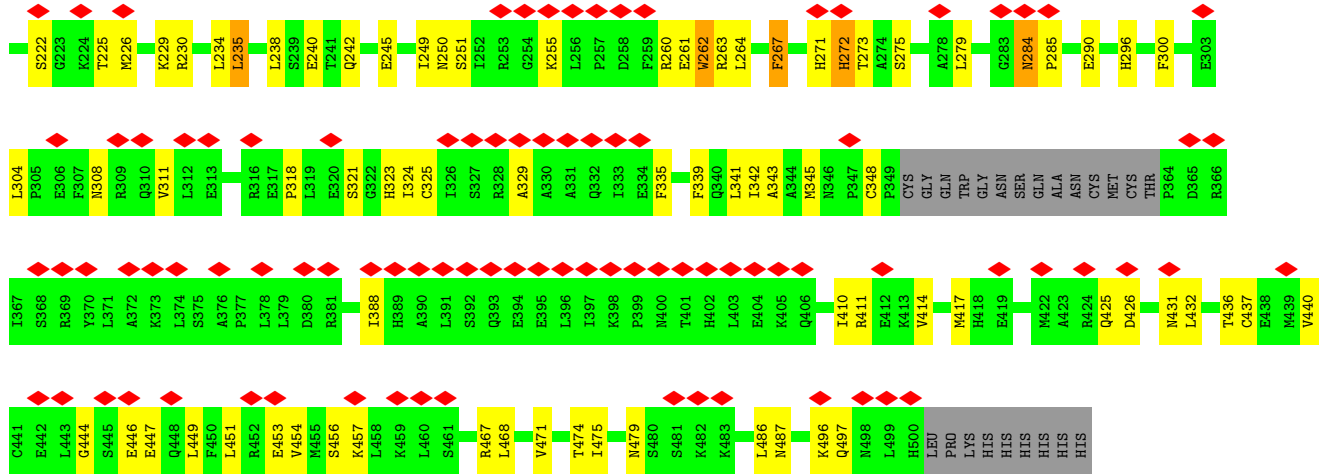

• Molecule 2: Poly-dT



• Molecule 3: Poly-dA Poly-dC

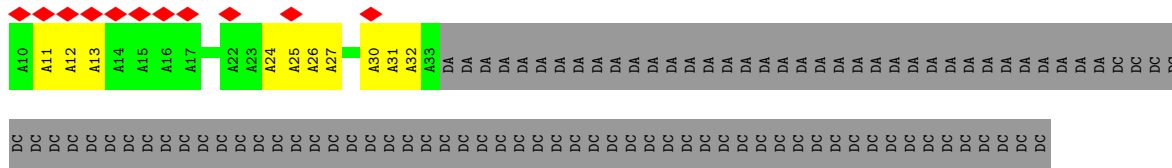

4 Experimental information

Property	Value	Source
EM reconstruction method	SINGLE PARTICLE	Depositor
Imposed symmetry	POINT, Not provided	
Number of particles used	207233	Depositor
Resolution determination method	FSC 0.143 CUT-OFF	Depositor
CTF correction method	PHASE FLIPPING AND AMPLITUDE CORRECTION	Depositor
Microscope	FEI TITAN KRIOS	Depositor
Voltage (kV)	300	Depositor
Electron dose ($e^-/\text{\AA}^2$)	54.61	Depositor
Minimum defocus (nm)	600	Depositor
Maximum defocus (nm)	1800	Depositor
Magnification	Not provided	
Image detector	GATAN K3 BIOQUANTUM (6k x 4k)	Depositor
Maximum map value	0.869	Depositor
Minimum map value	-0.364	Depositor
Average map value	0.001	Depositor
Map value standard deviation	0.023	Depositor
Recommended contour level	0.2	Depositor
Map size (\AA)	322.5, 322.5, 322.5	wwPDB
Map dimensions	500, 500, 500	wwPDB
Map angles ($^\circ$)	90.0, 90.0, 90.0	wwPDB
Pixel spacing (\AA)	0.645, 0.645, 0.645	Depositor

5 Model quality [i](#)

5.1 Standard geometry [i](#)

Bond lengths and bond angles in the following residue types are not validated in this section: ANP

The Z score for a bond length (or angle) is the number of standard deviations the observed value is removed from the expected value. A bond length (or angle) with $|Z| > 5$ is considered an outlier worth inspection. RMSZ is the root-mean-square of all Z scores of the bond lengths (or angles).

Mol	Chain	Bond lengths		Bond angles	
		RMSZ	# Z >5	RMSZ	# Z >5
1	A	0.28	0/3792	0.53	0/5135
1	B	0.29	0/3792	0.53	0/5135
1	C	0.28	0/3788	0.52	0/5131
1	D	0.29	0/3743	0.55	1/5066 (0.0%)
1	E	0.28	0/3709	0.52	0/5024
1	F	0.27	0/3650	0.53	0/4956
2	Y	0.54	0/527	1.28	0/812
3	Z	0.53	0/575	0.73	0/884
All	All	0.30	0/23576	0.57	1/32143 (0.0%)

Chiral center outliers are detected by calculating the chiral volume of a chiral center and verifying if the center is modelled as a planar moiety or with the opposite hand. A planarity outlier is detected by checking planarity of atoms in a peptide group, atoms in a mainchain group or atoms of a sidechain that are expected to be planar.

Mol	Chain	#Chirality outliers	#Planarity outliers
1	C	0	1

There are no bond length outliers.

All (1) bond angle outliers are listed below:

Mol	Chain	Res	Type	Atoms	Z	Observed(°)	Ideal(°)
1	D	312	LEU	CA-CB-CG	5.33	127.55	115.30

There are no chirality outliers.

All (1) planarity outliers are listed below:

Mol	Chain	Res	Type	Group
1	C	285	PRO	Peptide

5.2 Too-close contacts [i](#)

In the following table, the Non-H and H(model) columns list the number of non-hydrogen atoms and hydrogen atoms in the chain respectively. The H(added) column lists the number of hydrogen atoms added and optimized by MolProbity. The Clashes column lists the number of clashes within the asymmetric unit, whereas Symm-Clashes lists symmetry-related clashes.

Mol	Chain	Non-H	H(model)	H(added)	Clashes	Symm-Clashes
1	A	3723	0	3806	76	0
1	B	3723	0	3806	72	0
1	C	3719	0	3795	83	0
1	D	3675	0	3756	99	0
1	E	3641	0	3684	81	0
1	F	3583	0	3559	69	0
2	Y	480	0	289	3	0
3	Z	504	0	265	8	0
4	A	31	0	13	2	0
4	B	31	0	12	3	0
4	C	31	0	13	5	0
4	D	31	0	13	5	0
All	All	23172	0	23011	473	0

The all-atom clashscore is defined as the number of clashes found per 1000 atoms (including hydrogen atoms). The all-atom clashscore for this structure is 10.

All (473) close contacts within the same asymmetric unit are listed below, sorted by their clash magnitude.

Atom-1	Atom-2	Interatomic distance (Å)	Clash overlap (Å)
1:E:122:ILE:HD11	1:E:138:ILE:HD11	1.50	0.91
1:A:69:LEU:O	1:A:76:LYS:NZ	2.14	0.79
1:F:69:LEU:O	1:F:76:LYS:NZ	2.15	0.79
1:E:261:GLU:HG3	1:E:264:LEU:HB2	1.65	0.79
1:B:425:GLN:HE21	1:B:432:LEU:HD11	1.49	0.78
1:E:238:LEU:HB3	1:E:242:GLN:HG2	1.66	0.78
1:F:421:GLN:NE2	1:F:429:ASN:OD1	2.20	0.75
1:C:179:LYS:HD2	1:C:180:PRO:HD2	1.67	0.74
1:D:195:LYS:H	4:D:601:ANP:HN62	1.35	0.74
1:A:280:VAL:HG12	1:A:326:ILE:HD11	1.69	0.73
1:D:246:CYS:O	1:D:250:ASN:ND2	2.21	0.73
1:C:311:VAL:O	1:C:314:THR:OG1	2.07	0.73
1:E:171:THR:OG1	1:E:172:SER:N	2.22	0.73
1:A:284:ASN:HB2	1:A:285:PRO:HD2	1.70	0.72
1:D:473:ARG:NH1	1:D:477:ASP:OD1	2.22	0.72

Continued on next page...

Continued from previous page...

Atom-1	Atom-2	Interatomic distance (Å)	Clash overlap (Å)
1:D:395:GLU:HG2	1:D:396:LEU:HD23	1.72	0.71
1:A:467:ARG:NH1	1:A:497:GLN:OE1	2.16	0.71
1:E:191:TRP:HE1	1:E:234:LEU:HD22	1.55	0.71
1:D:255:LYS:NZ	1:D:256:LEU:O	2.24	0.70
1:A:183:LEU:HG	1:A:184:LEU:H	1.56	0.70
1:E:42:VAL:O	1:E:45:SER:OG	2.08	0.70
1:A:279:LEU:HD23	1:A:280:VAL:HG23	1.74	0.70
1:F:231:PHE:HA	1:F:234:LEU:HD12	1.74	0.69
1:E:74:LEU:O	1:E:76:LYS:NZ	2.25	0.69
1:F:316:ARG:HH22	1:E:271:HIS:HB3	1.57	0.69
1:E:304:LEU:HD11	1:E:343:ALA:HB1	1.76	0.68
1:C:149:THR:HA	1:C:244:LEU:HD11	1.76	0.68
1:E:444:GLY:N	1:E:447:GLU:OE1	2.27	0.67
1:B:48:ARG:NH1	1:B:82:ASP:OD2	2.28	0.67
1:B:440:VAL:O	1:B:473:ARG:NH2	2.28	0.67
1:D:201:LYS:O	1:D:205:VAL:HG23	1.95	0.67
1:D:320:GLU:OE1	1:D:381:ARG:NH1	2.25	0.67
1:F:451:LEU:O	1:F:455:MET:HG2	1.96	0.66
1:E:238:LEU:O	1:E:263:ARG:NH2	2.28	0.66
1:A:215:LEU:HG	1:A:382:ILE:HG21	1.77	0.66
1:D:74:LEU:O	1:D:76:LYS:NZ	2.28	0.66
1:C:380:ASP:O	1:C:467:ARG:NH1	2.29	0.65
1:C:133:ASN:OD1	1:C:153:LYS:NZ	2.29	0.65
1:E:226:MET:SD	1:E:230:ARG:NH2	2.69	0.65
1:B:39:GLU:OE2	1:B:40:THR:N	2.29	0.65
1:D:261:GLU:O	1:D:263:ARG:NH1	2.31	0.64
1:B:55:ASN:ND2	1:C:1:MET:SD	2.71	0.64
1:D:206:ILE:HG22	1:D:478:MET:SD	2.38	0.64
1:D:231:PHE:HA	1:D:234:LEU:HD23	1.80	0.64
1:F:174:GLN:N	1:F:174:GLN:OE1	2.30	0.63
1:A:403:LEU:O	1:A:404:GLU:HG2	1.99	0.63
1:B:256:LEU:HD12	1:B:257:PRO:HD2	1.81	0.63
1:B:260:ARG:NH2	1:B:261:GLU:OE2	2.30	0.63
1:A:385:GLN:NE2	1:A:496:LYS:O	2.32	0.63
1:F:475:ILE:O	1:F:479:ASN:ND2	2.32	0.62
1:F:471:VAL:O	1:F:475:ILE:HG12	1.99	0.62
1:B:180:PRO:HG3	1:B:259:PHE:CD2	2.34	0.62
1:B:339:PHE:HE1	1:B:341:LEU:HD13	1.63	0.62
1:B:406:GLN:N	1:B:406:GLN:OE1	2.33	0.61
1:E:318:PRO:HG3	1:E:324:ILE:HG22	1.82	0.61
1:D:25:LEU:HD22	1:D:65:ILE:HD13	1.82	0.61

Continued on next page...

Continued from previous page...

Atom-1	Atom-2	Interatomic distance (Å)	Clash overlap (Å)
1:E:261:GLU:O	1:E:263:ARG:N	2.33	0.61
1:B:319:LEU:HD21	1:B:341:LEU:HD22	1.82	0.61
1:C:467:ARG:HB2	1:C:496:LYS:NZ	2.15	0.61
1:E:242:GLN:HE21	1:E:296:HIS:CG	2.19	0.61
1:B:270:PRO:HB3	1:B:290:GLU:HG2	1.82	0.61
1:D:112:LEU:HD11	1:E:68:ASN:CG	2.21	0.61
1:C:270:PRO:HB3	1:C:290:GLU:HG2	1.81	0.61
1:D:284:ASN:ND2	1:E:329:ALA:O	2.34	0.61
1:D:396:LEU:HD13	1:E:451:LEU:HB3	1.82	0.60
1:A:425:GLN:N	1:A:425:GLN:OE1	2.35	0.60
1:C:410:ILE:O	1:C:414:VAL:HG23	2.02	0.60
1:C:467:ARG:HE	1:C:496:LYS:HZ2	1.50	0.60
1:D:22:GLU:OE1	1:D:68:ASN:ND2	2.31	0.60
1:A:193:ASP:HB2	1:A:230:ARG:HH12	1.66	0.59
1:C:281:GLY:HA3	1:C:326:ILE:HD13	1.83	0.59
1:D:442:GLU:HB2	1:D:483:LYS:HD2	1.84	0.59
1:A:424:ARG:HG3	1:A:425:GLN:OE1	2.02	0.59
1:D:145:GLU:OE1	1:D:145:GLU:N	2.34	0.59
1:F:417:MET:SD	1:F:417:MET:N	2.76	0.59
1:D:149:THR:HB	1:D:244:LEU:HD21	1.84	0.59
1:A:425:GLN:HE21	1:A:432:LEU:HD21	1.68	0.59
1:D:252:ILE:O	1:D:287:LYS:NZ	2.36	0.58
1:E:152:GLN:N	1:E:152:GLN:OE1	2.36	0.58
1:B:190:ASP:OD1	1:B:192:SER:OG	2.21	0.58
1:C:338:LYS:O	1:C:338:LYS:HG3	2.04	0.58
1:E:238:LEU:HD12	1:E:238:LEU:H	1.69	0.58
1:C:467:ARG:HE	1:C:496:LYS:NZ	2.02	0.58
1:E:8:THR:HG21	1:E:84:PRO:HG3	1.85	0.58
1:B:484:VAL:HA	1:B:488:HIS:HD1	1.69	0.58
1:A:429:ASN:HD22	1:A:474:THR:HG22	1.69	0.57
1:A:83:LEU:HD22	1:A:116:LEU:HD21	1.85	0.57
1:A:391:LEU:HD13	1:A:396:LEU:HD21	1.86	0.57
1:B:197:GLN:NE2	1:B:389:HIS:O	2.37	0.57
1:C:401:THR:OG1	1:C:402:HIS:N	2.38	0.57
1:F:444:GLY:HA2	1:F:448:GLN:HG3	1.86	0.57
2:Y:19:DT:H2'	2:Y:20:DT:H71	1.86	0.57
1:A:270:PRO:HB3	1:A:290:GLU:HG2	1.85	0.57
1:D:224:LYS:HE3	1:D:344:ALA:HB1	1.86	0.56
1:E:151:HIS:CE1	1:E:240:GLU:HB3	2.40	0.56
1:F:249:ILE:HD11	1:F:336:PRO:HG2	1.85	0.56
1:B:279:LEU:O	1:B:291:ILE:HG22	2.05	0.56

Continued on next page...

Continued from previous page...

Atom-1	Atom-2	Interatomic distance (Å)	Clash overlap (Å)
1:C:238:LEU:H	1:C:238:LEU:HD12	1.70	0.56
1:C:463:ARG:O	1:C:467:ARG:HG3	2.05	0.56
1:D:327:SER:HB3	1:D:332:GLN:HA	1.86	0.56
1:C:202:ASN:O	1:C:206:ILE:HG23	2.04	0.56
1:C:473:ARG:NH2	1:C:477:ASP:OD2	2.39	0.56
1:F:56:SER:O	1:F:161:ARG:NH2	2.40	0.55
1:F:311:VAL:O	1:F:314:THR:OG1	2.19	0.55
1:B:474:THR:O	1:B:478:MET:HG2	2.07	0.55
1:A:437:CYS:SG	1:A:473:ARG:NH2	2.79	0.55
1:B:179:LYS:HD3	1:B:180:PRO:HD2	1.88	0.55
1:A:191:TRP:HE1	1:A:201:LYS:HD3	1.72	0.54
1:A:271:HIS:CE1	1:B:316:ARG:HG3	2.42	0.54
1:C:43:LYS:NZ	3:Z:13:DA:OP1	2.29	0.54
1:F:485:LEU:HG	1:F:487:ASN:H	1.72	0.54
1:C:493:LEU:H	1:C:493:LEU:HD12	1.71	0.54
1:A:391:LEU:HD12	1:A:391:LEU:H	1.72	0.54
1:B:394:GLU:O	1:B:398:LYS:N	2.29	0.54
1:D:416:LYS:O	1:D:420:ILE:HG23	2.07	0.54
1:D:446:GLU:O	1:D:449:LEU:N	2.41	0.54
1:B:302:ASP:N	1:B:302:ASP:OD1	2.38	0.54
1:B:489:LEU:O	1:B:493:LEU:HD23	2.08	0.54
4:A:601:ANP:O2'	1:B:434:SER:OG	2.25	0.53
1:B:391:LEU:HD13	1:B:396:LEU:HD22	1.89	0.53
1:D:482:LYS:HB3	1:D:483:LYS:HZ3	1.73	0.53
1:D:55:ASN:ND2	1:D:112:LEU:O	2.37	0.53
1:A:190:ASP:O	1:A:230:ARG:NH1	2.41	0.53
1:D:158:ASN:N	1:D:162:GLU:OE1	2.31	0.53
1:F:475:ILE:HG22	1:F:479:ASN:HD21	1.72	0.53
1:B:306:GLU:OE2	1:C:309:ARG:NH2	2.41	0.53
1:D:312:LEU:HD23	1:D:378:LEU:HD13	1.90	0.53
1:E:154:VAL:HG12	1:E:154:VAL:O	2.07	0.53
1:B:394:GLU:HA	1:B:397:ILE:HB	1.91	0.53
1:C:186:ASN:OD1	1:C:187:TYR:N	2.42	0.53
1:E:471:VAL:O	1:E:475:ILE:HG12	2.08	0.53
1:E:271:HIS:O	1:E:273:THR:N	2.41	0.53
1:E:496:LYS:NZ	1:E:497:GLN:O	2.42	0.53
1:A:147:SER:HA	1:A:176:LEU:HD13	1.90	0.53
1:E:51:SER:OG	1:E:112:LEU:HD22	2.09	0.53
3:Z:30:DA:H1'	3:Z:31:DA:H5'	1.90	0.53
1:E:410:ILE:O	1:E:414:VAL:HG23	2.09	0.52
1:E:388:ILE:HD12	1:E:388:ILE:O	2.09	0.52

Continued on next page...

Continued from previous page...

Atom-1	Atom-2	Interatomic distance (Å)	Clash overlap (Å)
1:A:380:ASP:OD1	1:A:381:ARG:N	2.42	0.52
1:B:273:THR:HG22	1:C:310:GLN:HG2	1.91	0.52
1:B:468:LEU:HD21	1:B:493:LEU:HD22	1.91	0.52
1:C:268:ARG:HE	1:C:293:LEU:HD13	1.73	0.52
1:C:279:LEU:HD12	1:C:290:GLU:HB3	1.91	0.52
1:C:286:PRO:HG2	1:C:333:ILE:HD12	1.90	0.52
1:D:272:HIS:HD2	1:D:306:GLU:HB3	1.74	0.52
1:B:209:CYS:O	1:B:421:GLN:NE2	2.43	0.52
1:D:5:PHE:CE1	1:D:22:GLU:HG2	2.45	0.52
1:B:391:LEU:HD22	1:B:396:LEU:HB2	1.92	0.52
1:B:316:ARG:NH1	1:B:377:PRO:HG2	2.25	0.52
1:D:399:PRO:HB2	1:D:402:HIS:CD2	2.44	0.52
1:F:35:VAL:HG13	1:E:44:GLU:HB3	1.93	0.51
1:E:187:TYR:OH	1:E:411:ARG:NH2	2.43	0.51
1:F:272:HIS:CD2	1:F:273:THR:HG23	2.45	0.51
1:A:271:HIS:HE1	1:B:316:ARG:HG3	1.74	0.51
1:C:195:LYS:HB3	4:C:601:ANP:HN61	1.75	0.51
1:E:207:ALA:HB2	1:E:214:ILE:HD11	1.92	0.51
1:C:279:LEU:HD23	1:C:311:VAL:HG11	1.91	0.51
1:C:467:ARG:HB2	1:C:496:LYS:HZ3	1.75	0.51
1:A:374:LEU:HD22	1:A:379:LEU:HD12	1.93	0.51
1:C:221:GLY:N	4:C:601:ANP:O2B	2.40	0.51
1:D:385:GLN:NE2	1:D:498:ASN:H	2.09	0.51
1:D:442:GLU:HG3	1:D:483:LYS:HE3	1.92	0.51
1:F:239:SER:OG	1:F:240:GLU:N	2.42	0.51
1:B:226:MET:O	1:B:230:ARG:HG2	2.11	0.50
1:D:443:LEU:O	1:D:448:GLN:NE2	2.44	0.50
1:F:149:THR:OG1	1:F:151:HIS:HB2	2.12	0.50
1:B:411:ARG:O	1:B:415:THR:HG23	2.11	0.50
1:C:148:LEU:HD11	1:C:262:TRP:CD2	2.46	0.50
1:E:83:LEU:HD22	1:E:116:LEU:HD21	1.94	0.50
1:D:48:ARG:HG2	1:E:68:ASN:HD21	1.75	0.50
2:Y:18:DT:H2'	2:Y:19:DT:H71	1.93	0.50
1:D:437:CYS:SG	1:D:469:LEU:HD22	2.52	0.50
1:F:213:SER:OG	1:F:214:ILE:N	2.44	0.49
1:C:273:THR:OG1	1:C:274:ALA:N	2.44	0.49
3:Z:12:DA:H5'	3:Z:12:DA:C8	2.46	0.49
1:A:189:LEU:HB3	1:A:230:ARG:HD2	1.94	0.49
1:B:271:HIS:NE2	1:C:314:THR:HA	2.27	0.49
1:B:316:ARG:HH12	1:B:375:SER:HB2	1.77	0.49
1:C:369:ARG:NH2	3:Z:32:DA:OP1	2.38	0.49

Continued on next page...

Continued from previous page...

Atom-1	Atom-2	Interatomic distance (Å)	Clash overlap (Å)
1:D:327:SER:HB2	1:D:330:ALA:HB3	1.94	0.49
1:F:14:ILE:HD11	1:F:335:PHE:HD1	1.77	0.49
1:A:497:GLN:O	1:A:497:GLN:NE2	2.46	0.49
1:A:216:LEU:N	1:A:343:ALA:O	2.40	0.49
1:A:225:THR:OG1	4:A:601:ANP:O1B	2.15	0.49
1:B:271:HIS:HD1	1:B:272:HIS:H	1.58	0.49
1:B:443:LEU:HD11	1:B:469:LEU:HD11	1.94	0.49
1:E:284:ASN:HB3	1:E:285:PRO:HD2	1.94	0.49
1:F:270:PRO:HG2	1:F:301:LEU:HG	1.94	0.49
1:D:48:ARG:HG2	1:E:68:ASN:ND2	2.28	0.49
1:E:235:LEU:HD12	1:E:235:LEU:H	1.78	0.49
1:A:295:HIS:CE1	1:A:336:PRO:HB2	2.48	0.49
1:A:451:LEU:O	1:A:455:MET:HG2	2.13	0.49
1:E:324:ILE:O	1:E:324:ILE:HG13	2.13	0.49
1:F:437:CYS:O	1:F:473:ARG:NH1	2.46	0.49
1:A:256:LEU:HD12	1:A:257:PRO:HD2	1.94	0.48
1:C:393:GLN:O	1:C:397:ILE:HG12	2.12	0.48
1:F:450:PHE:O	1:F:454:VAL:HG23	2.13	0.48
1:D:481:SER:OG	1:D:483:LYS:O	2.30	0.48
1:D:284:ASN:HB3	1:D:285:PRO:HD2	1.96	0.48
1:A:413:LYS:O	1:A:417:MET:HG3	2.13	0.48
1:E:245:GLU:O	1:E:249:ILE:HD12	2.13	0.48
1:F:212:HIS:HB3	1:F:383:ASP:HB2	1.95	0.48
1:B:222:SER:HA	4:B:601:ANP:H2	1.95	0.48
1:B:414:VAL:HA	1:B:417:MET:HB2	1.95	0.48
1:A:225:THR:HG22	1:A:300:PHE:CE1	2.49	0.48
1:C:447:GLU:OE2	1:C:486:LEU:N	2.46	0.48
1:A:266:PRO:HG2	1:A:294:ALA:HA	1.96	0.48
1:A:268:ARG:NH1	1:A:293:LEU:HD13	2.29	0.48
1:B:425:GLN:NE2	1:B:432:LEU:HD11	2.23	0.48
1:C:323:HIS:HD2	1:C:334:GLU:HG3	1.79	0.48
1:D:418:HIS:HA	1:D:421:GLN:HE21	1.78	0.48
1:E:155:PHE:N	1:E:155:PHE:CD1	2.81	0.48
1:B:205:VAL:HG13	1:B:410:ILE:HD11	1.96	0.48
1:D:217:SER:HA	1:D:345:MET:O	2.13	0.48
1:A:207:ALA:O	1:A:211:GLY:N	2.46	0.47
1:D:248:ALA:O	1:D:252:ILE:HG22	2.13	0.47
1:E:69:LEU:O	1:E:76:LYS:HE2	2.14	0.47
1:E:193:ASP:O	1:E:230:ARG:NH1	2.45	0.47
1:B:397:ILE:HD13	1:C:452:ARG:HA	1.96	0.47
1:B:427:SER:HB3	1:B:431:ASN:HB2	1.96	0.47

Continued on next page...

Continued from previous page...

Atom-1	Atom-2	Interatomic distance (Å)	Clash overlap (Å)
1:E:456:SER:O	1:E:457:LYS:HG2	2.13	0.47
1:E:14:ILE:HD11	1:E:335:PHE:CD1	2.49	0.47
1:A:135:HIS:CE1	1:A:153:LYS:HG2	2.48	0.47
1:B:450:PHE:O	1:B:454:VAL:HG22	2.14	0.47
1:D:304:LEU:HG	1:D:374:LEU:HD11	1.96	0.47
1:E:487:ASN:OD1	1:E:487:ASN:N	2.42	0.47
1:E:451:LEU:HA	1:E:454:VAL:HG12	1.97	0.47
1:F:271:HIS:CG	1:A:316:ARG:HH12	2.32	0.47
1:F:454:VAL:O	1:F:458:LEU:N	2.45	0.47
1:F:461:SER:OG	1:F:462:ALA:N	2.46	0.47
1:F:47:ASP:HB2	1:A:35:VAL:HG21	1.97	0.47
1:A:188:GLU:O	1:A:190:ASP:N	2.47	0.47
4:C:601:ANP:H8	4:C:601:ANP:H2'	1.42	0.47
1:D:425:GLN:NE2	1:D:432:LEU:HD21	2.29	0.47
1:A:421:GLN:OE1	1:A:429:ASN:ND2	2.48	0.47
1:C:392:SER:OG	1:C:395:GLU:OE1	2.32	0.47
1:C:402:HIS:O	1:C:402:HIS:ND1	2.48	0.47
1:D:226:MET:HE1	4:D:601:ANP:C8	2.45	0.47
1:E:218:GLY:HA3	1:E:388:ILE:HD12	1.97	0.47
1:B:410:ILE:O	1:B:414:VAL:HG12	2.14	0.47
1:D:316:ARG:NH1	1:D:381:ARG:HH21	2.12	0.47
1:E:133:ASN:O	1:E:133:ASN:ND2	2.45	0.47
1:A:281:GLY:HA3	1:A:326:ILE:HD12	1.97	0.47
1:C:309:ARG:HG3	1:C:309:ARG:HH11	1.80	0.47
1:C:122:ILE:HD11	1:C:138:ILE:HG21	1.97	0.46
1:C:197:GLN:O	1:C:199:HIS:N	2.47	0.46
1:A:304:LEU:HD12	1:A:343:ALA:HB1	1.97	0.46
1:B:496:LYS:CG	1:B:497:GLN:H	2.28	0.46
1:F:230:ARG:O	1:F:233:THR:OG1	2.32	0.46
1:F:451:LEU:HD23	1:F:452:ARG:N	2.30	0.46
1:A:9:ARG:HB3	1:A:16:ALA:HB1	1.95	0.46
1:C:124:PRO:HG2	1:C:252:ILE:HD11	1.96	0.46
1:C:148:LEU:HA	1:C:180:PRO:HG2	1.96	0.46
1:C:285:PRO:HA	1:C:286:PRO:HD3	1.85	0.46
1:D:39:GLU:OE1	1:D:77:THR:HG22	2.15	0.46
1:E:249:ILE:HD12	1:E:249:ILE:H	1.81	0.46
1:F:259:PHE:C	1:F:260:ARG:HD3	2.36	0.46
4:C:601:ANP:O1G	1:D:381:ARG:NH2	2.49	0.46
1:E:425:GLN:OE1	1:E:426:ASP:N	2.48	0.46
1:B:277:VAL:HG22	1:B:282:GLY:HA2	1.96	0.46
1:D:412:GLU:O	1:D:415:THR:OG1	2.29	0.46

Continued on next page...

Continued from previous page...

Atom-1	Atom-2	Interatomic distance (Å)	Clash overlap (Å)
1:F:191:TRP:CD1	1:F:234:LEU:HD21	2.51	0.46
1:D:212:HIS:HB3	1:D:383:ASP:HB2	1.97	0.46
1:B:39:GLU:OE2	1:B:40:THR:HG22	2.15	0.46
1:C:9:ARG:NH1	1:C:105:GLU:OE2	2.49	0.46
1:E:446:GLU:HG2	1:E:447:GLU:OE2	2.16	0.46
1:F:134:GLN:HA	1:F:134:GLN:OE1	2.15	0.46
1:F:166:TYR:HB2	1:F:173:LEU:HD11	1.97	0.46
1:C:496:LYS:CG	1:C:497:GLN:N	2.79	0.46
1:A:441:CYS:SG	1:A:473:ARG:NE	2.86	0.46
1:D:152:GLN:O	1:D:153:LYS:HB2	2.15	0.46
1:D:304:LEU:HD22	1:D:343:ALA:HB1	1.96	0.46
1:F:441:CYS:H	1:F:473:ARG:NH2	2.14	0.46
1:B:497:GLN:O	1:B:499:LEU:N	2.49	0.46
1:D:306:GLU:O	1:D:307:PHE:HB2	2.15	0.46
1:D:145:GLU:HG3	1:D:257:PRO:HG2	1.98	0.45
1:D:418:HIS:HA	1:D:421:GLN:NE2	2.31	0.45
1:A:300:PHE:CE1	1:A:302:ASP:HB3	2.51	0.45
1:C:93:SER:O	1:C:93:SER:OG	2.34	0.45
1:C:179:LYS:CD	1:C:180:PRO:HD2	2.42	0.45
1:C:417:MET:HE2	1:C:417:MET:HB3	1.77	0.45
1:D:221:GLY:HA2	4:D:601:ANP:PB	2.56	0.45
3:Z:26:DA:H1'	3:Z:27:DA:H5'	1.98	0.45
1:D:112:LEU:HD12	1:D:112:LEU:N	2.31	0.45
1:F:166:TYR:HD1	1:F:170:GLY:HA2	1.81	0.45
1:C:394:GLU:HG3	1:C:395:GLU:OE1	2.17	0.45
1:B:106:PHE:CE1	1:B:137:ILE:HD12	2.51	0.45
1:D:391:LEU:HD11	1:D:395:GLU:HB3	1.97	0.45
1:E:225:THR:O	1:E:229:LYS:HG3	2.17	0.45
3:Z:11:DA:H2''	3:Z:12:DA:OP2	2.15	0.45
1:F:14:ILE:HD11	1:F:335:PHE:CD1	2.52	0.45
1:A:187:TYR:HE1	1:A:264:LEU:HD22	1.81	0.45
1:A:286:PRO:O	1:A:287:LYS:HD3	2.17	0.45
1:C:184:LEU:HD12	1:C:237:GLU:OE2	2.16	0.45
1:C:197:GLN:OE1	1:C:197:GLN:HA	2.15	0.45
1:C:261:GLU:OE1	1:C:261:GLU:N	2.48	0.45
1:D:443:LEU:HG	1:D:448:GLN:NE2	2.31	0.45
1:D:455:MET:SD	1:D:460:LEU:HB2	2.57	0.45
1:A:455:MET:SD	1:A:465:TYR:HE1	2.39	0.45
1:F:304:LEU:HD12	1:F:343:ALA:HB1	1.99	0.45
1:A:130:HIS:CG	1:A:151:HIS:CE1	3.05	0.45
1:D:272:HIS:CD2	1:D:306:GLU:HB3	2.51	0.45

Continued on next page...

Continued from previous page...

Atom-1	Atom-2	Interatomic distance (Å)	Clash overlap (Å)
1:E:260:ARG:HB3	1:E:261:GLU:H	1.63	0.45
1:F:256:LEU:HD23	1:F:257:PRO:HD2	1.99	0.45
1:C:204:MET:SD	1:C:227:MET:HB3	2.57	0.45
1:E:279:LEU:HD23	1:E:290:GLU:HB3	1.98	0.45
1:A:312:LEU:HD22	1:A:378:LEU:HD12	2.00	0.44
1:A:295:HIS:NE2	1:A:336:PRO:HB2	2.32	0.44
1:C:239:SER:OG	1:C:240:GLU:N	2.50	0.44
1:B:195:LYS:H	4:B:601:ANP:HN61	1.64	0.44
1:C:308:ASN:ND2	1:C:310:GLN:OE1	2.47	0.44
1:C:374:LEU:HD22	1:C:379:LEU:HD12	1.99	0.44
1:E:323:HIS:HD2	1:E:325:CYS:SG	2.40	0.44
1:E:436:THR:O	1:E:440:VAL:HG22	2.17	0.44
1:B:451:LEU:HD13	1:B:489:LEU:HD13	1.98	0.44
1:D:308:ASN:OD1	1:D:310:GLN:N	2.45	0.44
1:E:19:VAL:HG11	1:E:81:PHE:HE1	1.83	0.44
1:F:481:SER:OG	1:F:482:LYS:N	2.50	0.44
1:A:150:GLY:HA3	1:A:179:LYS:HE3	1.98	0.44
1:B:385:GLN:OE1	1:B:498:ASN:ND2	2.49	0.44
1:C:271:HIS:NE2	1:C:273:THR:HG23	2.32	0.44
1:F:460:LEU:HD12	1:F:464:GLY:HA3	1.99	0.44
1:D:225:THR:OG1	4:D:601:ANP:O2A	2.30	0.44
1:D:451:LEU:HD21	1:D:465:TYR:CE1	2.53	0.44
1:D:173:LEU:HD23	1:D:173:LEU:O	2.18	0.44
1:D:398:LYS:HB2	1:D:400:ASN:OD1	2.18	0.44
1:F:308:ASN:HB2	1:F:311:VAL:HB	1.98	0.44
1:B:199:HIS:HE1	1:B:495:TYR:HE1	1.66	0.44
1:C:498:ASN:HB3	1:C:499:LEU:H	1.58	0.44
1:D:191:TRP:CE3	1:D:234:LEU:HD21	2.53	0.44
1:D:434:SER:HA	1:D:437:CYS:HB3	1.99	0.44
1:E:250:ASN:HD22	1:E:262:TRP:HH2	1.66	0.44
1:F:191:TRP:HE1	1:F:234:LEU:HD11	1.82	0.43
1:A:338:LYS:HE3	1:A:338:LYS:HB2	1.74	0.43
1:D:226:MET:CG	1:D:230:ARG:HE	2.31	0.43
1:C:300:PHE:HD1	1:C:342:ILE:HG22	1.82	0.43
1:D:309:ARG:HH21	1:D:373:LYS:HA	1.83	0.43
1:F:212:HIS:H	1:F:212:HIS:CD2	2.35	0.43
1:F:320:GLU:OE2	1:F:381:ARG:NE	2.51	0.43
1:C:305:PRO:HD3	1:C:345:MET:HB2	2.00	0.43
1:C:442:GLU:OE1	1:C:444:GLY:N	2.51	0.43
1:D:404:GLU:N	1:D:404:GLU:OE1	2.52	0.43
1:F:309:ARG:NH2	1:F:374:LEU:O	2.51	0.43

Continued on next page...

Continued from previous page...

Atom-1	Atom-2	Interatomic distance (Å)	Clash overlap (Å)
1:A:284:ASN:HB2	1:A:285:PRO:CD	2.45	0.43
1:A:429:ASN:ND2	1:A:474:THR:HG22	2.33	0.43
1:E:106:PHE:HE1	1:E:137:ILE:HD12	1.83	0.43
1:B:226:MET:HE1	4:B:601:ANP:C5	2.48	0.43
1:B:425:GLN:N	1:B:425:GLN:OE1	2.52	0.43
1:D:468:LEU:HD11	1:D:493:LEU:HD22	2.01	0.43
1:D:265:PRO:HA	1:D:266:PRO:HD3	1.92	0.43
3:Z:24:DA:H2''	3:Z:25:DA:C8	2.54	0.43
1:F:1:MET:HG3	1:F:2:SER:H	1.84	0.43
1:C:308:ASN:ND2	1:C:310:GLN:HB3	2.34	0.43
1:C:326:ILE:HG22	1:C:333:ILE:H	1.83	0.43
1:E:216:LEU:O	1:E:345:MET:N	2.45	0.43
1:E:229:LYS:HA	1:E:267:PHE:CE2	2.54	0.43
1:F:215:LEU:HG	1:F:382:ILE:HG21	2.01	0.43
1:B:185:ASN:HB3	1:B:187:TYR:CZ	2.54	0.43
1:D:339:PHE:HE2	1:D:341:LEU:HB2	1.84	0.43
1:E:272:HIS:CD2	1:E:273:THR:H	2.37	0.43
1:B:236:PRO:HB3	1:B:415:THR:HG22	2.01	0.42
1:C:176:LEU:HD12	1:C:176:LEU:HA	1.87	0.42
1:C:265:PRO:HA	1:C:266:PRO:HD3	1.92	0.42
1:D:277:VAL:O	1:D:282:GLY:N	2.52	0.42
1:F:1:MET:CG	1:F:2:SER:H	2.32	0.42
1:D:159:ASN:OD1	1:D:159:ASN:N	2.49	0.42
1:D:260:ARG:H	1:D:260:ARG:HG3	1.65	0.42
2:Y:8:DT:H2''	2:Y:9:DT:H71	2.01	0.42
1:F:8:THR:HG21	1:F:84:PRO:HG3	2.00	0.42
1:F:133:ASN:OD1	1:F:133:ASN:O	2.38	0.42
4:D:601:ANP:O2B	4:D:601:ANP:H5'2	2.19	0.42
1:E:300:PHE:HD1	1:E:342:ILE:HG22	1.84	0.42
1:A:113:SER:HB3	1:B:5:PHE:CZ	2.54	0.42
1:A:235:LEU:HD23	1:A:235:LEU:HA	1.86	0.42
1:C:284:ASN:CG	1:C:285:PRO:HD2	2.40	0.42
1:D:191:TRP:CZ2	1:D:201:LYS:HG2	2.54	0.42
1:D:483:LYS:HA	1:D:483:LYS:HD3	1.74	0.42
1:F:1:MET:HA	1:F:1:MET:CE	2.50	0.42
1:F:51:SER:OG	1:F:112:LEU:HD22	2.20	0.42
1:D:136:LEU:HB3	1:D:154:VAL:HG22	2.00	0.42
1:D:210:GLY:HA3	1:D:212:HIS:CE1	2.55	0.42
1:D:304:LEU:HD12	1:D:304:LEU:HA	1.87	0.42
1:E:123:ILE:N	1:E:124:PRO:HD2	2.35	0.42
1:E:212:HIS:HE1	1:E:474:THR:HG21	1.84	0.42

Continued on next page...

Continued from previous page...

Atom-1	Atom-2	Interatomic distance (Å)	Clash overlap (Å)
1:E:449:LEU:O	1:E:453:GLU:HG3	2.20	0.42
1:E:468:LEU:HD23	1:E:468:LEU:HA	1.85	0.42
1:B:267:PHE:CD1	1:B:267:PHE:C	2.93	0.42
1:B:312:LEU:C	1:B:316:ARG:HH21	2.23	0.42
1:B:341:LEU:HD12	1:B:341:LEU:HA	1.81	0.42
1:D:485:LEU:HD23	1:D:485:LEU:HA	1.82	0.42
1:E:17:GLN:CD	1:E:74:LEU:HD11	2.40	0.42
1:E:23:VAL:HG22	1:E:67:VAL:HG22	2.02	0.42
1:B:371:LEU:HD21	1:B:500:HIS:HB2	2.02	0.42
1:C:333:ILE:HG22	1:C:334:GLU:H	1.85	0.42
1:D:326:ILE:HD12	1:D:326:ILE:HA	1.97	0.42
1:A:74:LEU:O	1:A:76:LYS:HE3	2.20	0.42
1:F:57:GLN:HB2	1:F:161:ARG:HH22	1.84	0.41
1:B:199:HIS:CE1	1:B:495:TYR:HE1	2.38	0.41
1:F:9:ARG:HB2	1:F:107:ILE:HD11	2.02	0.41
1:B:148:LEU:HA	1:B:148:LEU:HD23	1.76	0.41
1:E:339:PHE:HE1	1:E:341:LEU:HG	1.85	0.41
1:A:470:LYS:HA	1:A:473:ARG:NH1	2.35	0.41
1:B:106:PHE:HE1	1:B:137:ILE:HD12	1.85	0.41
1:C:59:GLU:H	1:C:95:GLN:HE22	1.69	0.41
1:C:180:PRO:HB3	1:C:259:PHE:HD1	1.86	0.41
1:C:185:ASN:O	1:C:186:ASN:HB3	2.20	0.41
1:C:406:GLN:H	1:C:406:GLN:HG2	1.56	0.41
1:D:399:PRO:HB2	1:D:402:HIS:CG	2.54	0.41
1:B:496:LYS:HG3	1:B:497:GLN:H	1.86	0.41
1:E:210:GLY:HA3	1:E:212:HIS:CE1	2.56	0.41
1:F:471:VAL:O	1:F:474:THR:OG1	2.31	0.41
1:A:26:SER:O	1:A:63:ARG:HB3	2.20	0.41
1:A:122:ILE:HD13	1:A:142:ASN:HB3	2.02	0.41
1:A:366:ARG:HG3	1:A:369:ARG:HH21	1.86	0.41
1:A:425:GLN:HG3	1:A:432:LEU:HD21	2.02	0.41
1:B:215:LEU:HB2	1:B:382:ILE:HG21	2.03	0.41
1:C:433:ASN:ND2	1:C:436:THR:OG1	2.54	0.41
1:D:157:ALA:HB2	1:D:173:LEU:HD11	2.03	0.41
1:D:376:ALA:N	1:D:377:PRO:HD2	2.34	0.41
1:D:420:ILE:HG13	1:D:421:GLN:N	2.35	0.41
1:F:36:GLY:O	1:F:38:ALA:N	2.51	0.41
1:F:136:LEU:HD23	1:F:136:LEU:HA	1.87	0.41
1:A:36:GLY:O	1:A:38:ALA:N	2.52	0.41
1:A:468:LEU:HD23	1:A:468:LEU:HA	1.93	0.41
1:D:197:GLN:O	1:D:199:HIS:N	2.52	0.41

Continued on next page...

Continued from previous page...

Atom-1	Atom-2	Interatomic distance (Å)	Clash overlap (Å)
1:E:49:VAL:HG11	1:E:89:ILE:HD12	2.02	0.41
1:E:432:LEU:HD23	1:E:432:LEU:HA	1.88	0.41
3:Z:25:DA:H2"	3:Z:26:DA:C8	2.56	0.41
1:F:127:LEU:CD2	1:F:244:LEU:HB3	2.50	0.41
1:C:326:ILE:HD12	1:C:326:ILE:HA	1.97	0.41
1:D:9:ARG:NH2	1:D:132:ASP:OD2	2.38	0.41
1:D:43:LYS:HE2	1:D:43:LYS:HB2	1.72	0.41
1:E:201:LYS:O	1:E:205:VAL:HG23	2.21	0.41
1:F:130:HIS:HD2	1:F:241:THR:HG22	1.86	0.41
1:F:284:ASN:O	1:F:328:ARG:NH2	2.53	0.41
1:A:328:ARG:O	1:A:330:ALA:N	2.49	0.41
1:B:5:PHE:CZ	1:B:22:GLU:HG2	2.56	0.41
1:C:113:SER:HB3	1:D:3:LEU:HD21	2.03	0.41
1:C:302:ASP:OD1	1:C:303:GLU:HG2	2.21	0.41
1:D:69:LEU:O	1:D:76:LYS:HE2	2.21	0.41
1:D:215:LEU:HB2	1:D:382:ILE:HG21	2.02	0.41
1:D:425:GLN:HE21	1:D:432:LEU:HD21	1.85	0.41
1:F:309:ARG:HD3	1:F:309:ARG:HA	1.93	0.41
1:D:138:ILE:HG13	1:D:156:THR:HG22	2.03	0.41
1:E:255:LYS:HE2	1:E:255:LYS:HB2	1.88	0.41
1:F:105:GLU:HB2	1:F:136:LEU:HD23	2.03	0.40
1:F:451:LEU:HD23	1:F:452:ARG:H	1.86	0.40
1:B:122:ILE:O	1:B:122:ILE:HG13	2.21	0.40
1:C:385:GLN:HE22	1:C:500:HIS:HA	1.85	0.40
1:A:187:TYR:CE1	1:A:264:LEU:HD22	2.56	0.40
1:A:448:GLN:HB3	1:A:452:ARG:NH2	2.36	0.40
1:C:244:LEU:HD13	1:C:244:LEU:HA	1.86	0.40
1:D:179:LYS:HB3	1:D:180:PRO:HD3	2.03	0.40
1:E:12:ILE:HD12	1:E:12:ILE:HA	1.80	0.40
1:E:130:HIS:CD2	1:E:151:HIS:CD2	3.09	0.40
1:F:319:LEU:HD11	1:F:341:LEU:HD11	2.03	0.40
1:A:197:GLN:O	1:A:199:HIS:N	2.55	0.40
1:A:244:LEU:HD23	1:A:244:LEU:HA	1.84	0.40
1:C:261:GLU:HB2	1:C:264:LEU:HD12	2.03	0.40
1:F:412:GLU:O	1:F:415:THR:OG1	2.35	0.40
1:A:239:SER:OG	1:A:240:GLU:N	2.54	0.40
1:A:342:ILE:HD13	1:A:342:ILE:HA	1.83	0.40
1:B:460:LEU:HD11	1:B:497:GLN:OE1	2.22	0.40
1:D:279:LEU:O	1:D:291:ILE:HG22	2.22	0.40
1:E:279:LEU:HD12	1:E:311:VAL:HG11	2.03	0.40
1:F:151:HIS:ND1	1:F:152:GLN:O	2.51	0.40

Continued on next page...

Continued from previous page...

Atom-1	Atom-2	Interatomic distance (Å)	Clash overlap (Å)
1:F:187:TYR:HB3	1:F:188:GLU:H	1.62	0.40
1:A:123:ILE:N	1:A:124:PRO:HD2	2.36	0.40
1:C:222:SER:O	4:C:601:ANP:H2	2.22	0.40
1:C:308:ASN:HD22	1:C:310:GLN:HB3	1.85	0.40
1:E:105:GLU:HB2	1:E:136:LEU:HD23	2.03	0.40
1:E:207:ALA:O	1:E:211:GLY:N	2.52	0.40
1:E:467:ARG:HD2	1:E:496:LYS:HD3	2.04	0.40

There are no symmetry-related clashes.

5.3 Torsion angles [i](#)

5.3.1 Protein backbone [i](#)

In the following table, the Percentiles column shows the percent Ramachandran outliers of the chain as a percentile score with respect to all PDB entries followed by that with respect to all EM entries.

The Analysed column shows the number of residues for which the backbone conformation was analysed, and the total number of residues.

Mol	Chain	Analysed	Favoured	Allowed	Outliers	Percentiles	
1	A	482/509 (95%)	439 (91%)	39 (8%)	4 (1%)	16	45
1	B	482/509 (95%)	449 (93%)	30 (6%)	3 (1%)	22	51
1	C	482/509 (95%)	438 (91%)	39 (8%)	5 (1%)	13	40
1	D	474/509 (93%)	418 (88%)	53 (11%)	3 (1%)	22	51
1	E	474/509 (93%)	427 (90%)	40 (8%)	7 (2%)	8	30
1	F	474/509 (93%)	435 (92%)	36 (8%)	3 (1%)	22	51
All	All	2868/3054 (94%)	2606 (91%)	237 (8%)	25 (1%)	17	43

All (25) Ramachandran outliers are listed below:

Mol	Chain	Res	Type
1	F	307	PHE
1	A	189	LEU
1	A	284	ASN
1	A	404	GLU
1	E	171	THR

Continued on next page...

Continued from previous page...

Mol	Chain	Res	Type
1	E	272	HIS
1	F	284	ASN
1	F	443	LEU
1	B	284	ASN
1	C	198	GLN
1	C	329	ALA
1	D	153	LYS
1	D	284	ASN
1	E	198	GLN
1	E	222	SER
1	E	284	ASN
1	A	188	GLU
1	E	262	TRP
1	C	185	ASN
1	C	498	ASN
1	B	186	ASN
1	B	407	SER
1	D	446	GLU
1	C	284	ASN
1	E	348	CYS

5.3.2 Protein sidechains [i](#)

In the following table, the Percentiles column shows the percent sidechain outliers of the chain as a percentile score with respect to all PDB entries followed by that with respect to all EM entries.

The Analysed column shows the number of residues for which the sidechain conformation was analysed, and the total number of residues.

Mol	Chain	Analysed	Rotameric	Outliers	Percentiles	
1	A	409/430 (95%)	392 (96%)	17 (4%)	25	52
1	B	409/430 (95%)	395 (97%)	14 (3%)	32	59
1	C	408/430 (95%)	392 (96%)	16 (4%)	27	54
1	D	403/430 (94%)	381 (94%)	22 (6%)	18	43
1	E	393/430 (91%)	374 (95%)	19 (5%)	21	48
1	F	380/430 (88%)	359 (94%)	21 (6%)	18	43
All	All	2402/2580 (93%)	2293 (96%)	109 (4%)	26	50

All (109) residues with a non-rotameric sidechain are listed below:

Mol	Chain	Res	Type
1	F	31	SER
1	F	63	ARG
1	F	79	SER
1	F	100	ASN
1	F	120	SER
1	F	132	ASP
1	F	133	ASN
1	F	213	SER
1	F	239	SER
1	F	258	ASP
1	F	260	ARG
1	F	267	PHE
1	F	288	PRO
1	F	345	MET
1	F	398	LYS
1	F	422	MET
1	F	439	MET
1	F	451	LEU
1	F	455	MET
1	F	477	ASP
1	F	500	HIS
1	A	2	SER
1	A	10	SER
1	A	20	SER
1	A	31	SER
1	A	57	GLN
1	A	62	CYS
1	A	79	SER
1	A	94	GLU
1	A	100	ASN
1	A	113	SER
1	A	232	SER
1	A	239	SER
1	A	308	ASN
1	A	313	GLU
1	A	366	ARG
1	A	384	MET
1	A	391	LEU
1	B	2	SER
1	B	62	CYS
1	B	193	ASP
1	B	226	MET
1	B	251	SER

Continued on next page...

Continued from previous page...

Mol	Chain	Res	Type
1	B	267	PHE
1	B	271	HIS
1	B	272	HIS
1	B	292	SER
1	B	327	SER
1	B	384	MET
1	B	417	MET
1	B	463	ARG
1	B	498	ASN
1	C	20	SER
1	C	51	SER
1	C	79	SER
1	C	93	SER
1	C	135	HIS
1	C	151	HIS
1	C	175	SER
1	C	284	ASN
1	C	293	LEU
1	C	323	HIS
1	C	345	MET
1	C	408	LEU
1	C	434	SER
1	C	458	LEU
1	C	461	SER
1	C	469	LEU
1	D	10	SER
1	D	51	SER
1	D	63	ARG
1	D	79	SER
1	D	100	ASN
1	D	162	GLU
1	D	172	SER
1	D	212	HIS
1	D	229	LYS
1	D	239	SER
1	D	246	CYS
1	D	272	HIS
1	D	275	SER
1	D	292	SER
1	D	323	HIS
1	D	371	LEU
1	D	404	GLU

Continued on next page...

Continued from previous page...

Mol	Chain	Res	Type
1	D	434	SER
1	D	477	ASP
1	D	480	SER
1	D	481	SER
1	D	485	LEU
1	E	3	LEU
1	E	10	SER
1	E	27	ASN
1	E	32	PHE
1	E	48	ARG
1	E	62	CYS
1	E	79	SER
1	E	113	SER
1	E	235	LEU
1	E	251	SER
1	E	267	PHE
1	E	275	SER
1	E	308	ASN
1	E	321	SER
1	E	417	MET
1	E	431	ASN
1	E	437	CYS
1	E	479	ASN
1	E	486	LEU

Sometimes sidechains can be flipped to improve hydrogen bonding and reduce clashes. All (18) such sidechains are listed below:

Mol	Chain	Res	Type
1	F	272	HIS
1	F	421	GLN
1	F	429	ASN
1	F	479	ASN
1	A	151	HIS
1	A	295	HIS
1	A	429	ASN
1	C	323	HIS
1	C	346	ASN
1	C	487	ASN
1	C	488	HIS
1	D	250	ASN
1	D	385	GLN
1	D	402	HIS

Continued on next page...

Continued from previous page...

Mol	Chain	Res	Type
1	D	418	HIS
1	D	421	GLN
1	E	212	HIS
1	E	242	GLN

5.3.3 RNA [i](#)

There are no RNA molecules in this entry.

5.4 Non-standard residues in protein, DNA, RNA chains [i](#)

There are no non-standard protein/DNA/RNA residues in this entry.

5.5 Carbohydrates [i](#)

There are no oligosaccharides in this entry.

5.6 Ligand geometry [i](#)

4 ligands are modelled in this entry.

In the following table, the Counts columns list the number of bonds (or angles) for which Mogul statistics could be retrieved, the number of bonds (or angles) that are observed in the model and the number of bonds (or angles) that are defined in the Chemical Component Dictionary. The Link column lists molecule types, if any, to which the group is linked. The Z score for a bond length (or angle) is the number of standard deviations the observed value is removed from the expected value. A bond length (or angle) with $|Z| > 2$ is considered an outlier worth inspection. RMSZ is the root-mean-square of all Z scores of the bond lengths (or angles).

Mol	Type	Chain	Res	Link	Bond lengths			Bond angles		
					Counts	RMSZ	# Z > 2	Counts	RMSZ	# Z > 2
4	ANP	A	601	-	29,33,33	3.79	15 (51%)	31,52,52	3.29	6 (19%)
4	ANP	D	601	-	29,33,33	3.80	18 (62%)	31,52,52	3.14	6 (19%)
4	ANP	C	601	-	29,33,33	3.77	17 (58%)	31,52,52	3.34	6 (19%)
4	ANP	B	601	-	29,33,33	3.88	17 (58%)	31,52,52	3.23	6 (19%)

In the following table, the Chirals column lists the number of chiral outliers, the number of chiral centers analysed, the number of these observed in the model and the number defined in the Chemical Component Dictionary. Similar counts are reported in the Torsion and Rings columns. '-' means no outliers of that kind were identified.

Mol	Type	Chain	Res	Link	Chirals	Torsions	Rings
4	ANP	A	601	-	-	5/14/38/38	0/3/3/3
4	ANP	D	601	-	-	4/14/38/38	0/3/3/3
4	ANP	C	601	-	-	7/14/38/38	0/3/3/3
4	ANP	B	601	-	-	7/14/38/38	0/3/3/3

All (67) bond length outliers are listed below:

Mol	Chain	Res	Type	Atoms	Z	Observed(Å)	Ideal(Å)
4	A	601	ANP	C2'-C3'	-10.96	1.23	1.53
4	D	601	ANP	C2'-C3'	-10.95	1.23	1.53
4	C	601	ANP	C2'-C3'	-10.85	1.23	1.53
4	B	601	ANP	C2'-C3'	-10.83	1.23	1.53
4	B	601	ANP	C2'-C1'	9.34	1.67	1.53
4	C	601	ANP	C2'-C1'	9.03	1.67	1.53
4	D	601	ANP	C2'-C1'	8.58	1.66	1.53
4	A	601	ANP	C2'-C1'	8.31	1.66	1.53
4	B	601	ANP	O4'-C1'	-7.84	1.30	1.41
4	A	601	ANP	O4'-C1'	-7.55	1.30	1.41
4	D	601	ANP	O4'-C1'	-7.45	1.30	1.41
4	C	601	ANP	O4'-C1'	-7.15	1.31	1.41
4	B	601	ANP	PB-O3A	5.52	1.66	1.59
4	A	601	ANP	PB-O3A	5.47	1.66	1.59
4	D	601	ANP	PB-O3A	5.30	1.65	1.59
4	C	601	ANP	PB-O3A	5.23	1.65	1.59
4	B	601	ANP	C5'-C4'	-4.17	1.38	1.51
4	D	601	ANP	C5'-C4'	-4.13	1.38	1.51
4	A	601	ANP	C5'-C4'	-4.11	1.38	1.51
4	C	601	ANP	C5'-C4'	-3.93	1.39	1.51
4	B	601	ANP	O3'-C3'	3.65	1.51	1.43
4	D	601	ANP	O3'-C3'	3.55	1.51	1.43
4	A	601	ANP	O3'-C3'	3.46	1.51	1.43
4	D	601	ANP	PB-O1B	3.44	1.51	1.46
4	C	601	ANP	O3'-C3'	3.40	1.51	1.43
4	B	601	ANP	PB-O1B	3.39	1.51	1.46
4	B	601	ANP	PB-N3B	3.36	1.72	1.63
4	A	601	ANP	PB-N3B	3.32	1.72	1.63
4	A	601	ANP	PG-N3B	3.30	1.72	1.63
4	A	601	ANP	PG-O1G	3.30	1.51	1.46
4	C	601	ANP	PG-O1G	3.29	1.51	1.46
4	D	601	ANP	PG-O1G	3.29	1.51	1.46
4	D	601	ANP	PB-N3B	3.28	1.71	1.63
4	B	601	ANP	PG-N3B	3.28	1.71	1.63

Continued on next page...

Continued from previous page...

Mol	Chain	Res	Type	Atoms	Z	Observed(Å)	Ideal(Å)
4	A	601	ANP	C6-N6	3.27	1.46	1.34
4	C	601	ANP	PB-O1B	3.27	1.51	1.46
4	B	601	ANP	C6-N6	3.21	1.45	1.34
4	C	601	ANP	PB-N3B	3.21	1.71	1.63
4	D	601	ANP	PG-N3B	3.21	1.71	1.63
4	A	601	ANP	PB-O1B	3.21	1.51	1.46
4	B	601	ANP	PG-O1G	3.20	1.51	1.46
4	C	601	ANP	PG-N3B	3.19	1.71	1.63
4	D	601	ANP	C6-N6	3.14	1.45	1.34
4	C	601	ANP	C6-N6	3.12	1.45	1.34
4	A	601	ANP	C3'-C4'	3.09	1.60	1.53
4	A	601	ANP	O4'-C4'	2.97	1.51	1.45
4	B	601	ANP	C3'-C4'	2.83	1.60	1.53
4	D	601	ANP	C3'-C4'	2.83	1.60	1.53
4	B	601	ANP	C5-C4	-2.82	1.33	1.40
4	D	601	ANP	O4'-C4'	2.82	1.51	1.45
4	D	601	ANP	C5-C4	-2.80	1.33	1.40
4	B	601	ANP	O4'-C4'	2.78	1.51	1.45
4	A	601	ANP	C5-C4	-2.76	1.33	1.40
4	C	601	ANP	C5-C4	-2.76	1.33	1.40
4	C	601	ANP	C3'-C4'	2.76	1.60	1.53
4	C	601	ANP	O4'-C4'	2.74	1.51	1.45
4	D	601	ANP	O2'-C2'	2.37	1.48	1.43
4	A	601	ANP	O2'-C2'	2.34	1.48	1.43
4	C	601	ANP	O2'-C2'	2.30	1.48	1.43
4	B	601	ANP	O2'-C2'	2.28	1.48	1.43
4	D	601	ANP	C2-N3	2.21	1.35	1.32
4	C	601	ANP	C2-N3	2.16	1.35	1.32
4	B	601	ANP	C2-N3	2.15	1.35	1.32
4	C	601	ANP	PG-O2G	-2.04	1.51	1.56
4	B	601	ANP	PG-O2G	-2.04	1.51	1.56
4	D	601	ANP	PG-O3G	-2.03	1.51	1.56
4	D	601	ANP	PG-O2G	-2.01	1.51	1.56

All (24) bond angle outliers are listed below:

Mol	Chain	Res	Type	Atoms	Z	Observed(°)	Ideal(°)
4	A	601	ANP	C5-C6-N6	11.78	138.25	120.35
4	C	601	ANP	C5-C6-N6	11.69	138.11	120.35
4	B	601	ANP	C5-C6-N6	11.38	137.65	120.35
4	D	601	ANP	C5-C6-N6	10.96	137.01	120.35
4	C	601	ANP	N6-C6-N1	-8.39	101.17	118.57

Continued on next page...

Continued from previous page...

Mol	Chain	Res	Type	Atoms	Z	Observed(°)	Ideal(°)
4	A	601	ANP	N6-C6-N1	-8.37	101.20	118.57
4	B	601	ANP	N6-C6-N1	-8.14	101.67	118.57
4	D	601	ANP	N6-C6-N1	-7.80	102.38	118.57
4	C	601	ANP	C1'-N9-C4	7.75	140.26	126.64
4	B	601	ANP	C1'-N9-C4	7.61	140.01	126.64
4	D	601	ANP	C1'-N9-C4	7.61	140.01	126.64
4	A	601	ANP	C1'-N9-C4	7.43	139.70	126.64
4	A	601	ANP	N3-C2-N1	-5.63	119.89	128.68
4	C	601	ANP	N3-C2-N1	-5.45	120.16	128.68
4	D	601	ANP	N3-C2-N1	-5.29	120.41	128.68
4	B	601	ANP	N3-C2-N1	-5.27	120.44	128.68
4	C	601	ANP	C3'-C2'-C1'	3.99	106.98	100.98
4	B	601	ANP	C3'-C2'-C1'	3.83	106.75	100.98
4	D	601	ANP	C3'-C2'-C1'	3.64	106.45	100.98
4	C	601	ANP	PB-O3A-PA	-3.52	120.21	132.62
4	D	601	ANP	PB-O3A-PA	-2.89	122.43	132.62
4	A	601	ANP	PB-O3A-PA	-2.88	122.47	132.62
4	B	601	ANP	PB-O3A-PA	-2.80	122.76	132.62
4	A	601	ANP	O4'-C1'-C2'	-2.23	103.67	106.93

There are no chirality outliers.

All (23) torsion outliers are listed below:

Mol	Chain	Res	Type	Atoms
4	A	601	ANP	PB-N3B-PG-O1G
4	A	601	ANP	PG-N3B-PB-O3A
4	A	601	ANP	O4'-C4'-C5'-O5'
4	B	601	ANP	PB-N3B-PG-O1G
4	B	601	ANP	PG-N3B-PB-O1B
4	B	601	ANP	PA-O3A-PB-O1B
4	B	601	ANP	C5'-O5'-PA-O1A
4	B	601	ANP	C5'-O5'-PA-O2A
4	C	601	ANP	PG-N3B-PB-O1B
4	C	601	ANP	C5'-O5'-PA-O2A
4	C	601	ANP	C5'-O5'-PA-O3A
4	C	601	ANP	C4'-C5'-O5'-PA
4	C	601	ANP	C3'-C4'-C5'-O5'
4	D	601	ANP	PB-N3B-PG-O1G
4	D	601	ANP	PG-N3B-PB-O1B
4	D	601	ANP	O4'-C4'-C5'-O5'
4	A	601	ANP	C3'-C4'-C5'-O5'
4	C	601	ANP	O4'-C4'-C5'-O5'

Continued on next page...

Continued from previous page...

Mol	Chain	Res	Type	Atoms
4	A	601	ANP	C4'-C5'-O5'-PA
4	D	601	ANP	C4'-C5'-O5'-PA
4	B	601	ANP	O4'-C4'-C5'-O5'
4	B	601	ANP	C5'-O5'-PA-O3A
4	C	601	ANP	C5'-O5'-PA-O1A

There are no ring outliers.

4 monomers are involved in 15 short contacts:

Mol	Chain	Res	Type	Clashes	Symm-Clashes
4	A	601	ANP	2	0
4	D	601	ANP	5	0
4	C	601	ANP	5	0
4	B	601	ANP	3	0

The following is a two-dimensional graphical depiction of Mogul quality analysis of bond lengths, bond angles, torsion angles, and ring geometry for all instances of the Ligand of Interest. In addition, ligands with molecular weight > 250 and outliers as shown on the validation Tables will also be included. For torsion angles, if less than 5% of the Mogul distribution of torsion angles is within 10 degrees of the torsion angle in question, then that torsion angle is considered an outlier. Any bond that is central to one or more torsion angles identified as an outlier by Mogul will be highlighted in the graph. For rings, the root-mean-square deviation (RMSD) between the ring in question and similar rings identified by Mogul is calculated over all ring torsion angles. If the average RMSD is greater than 60 degrees and the minimal RMSD between the ring in question and any Mogul-identified rings is also greater than 60 degrees, then that ring is considered an outlier. The outliers are highlighted in purple. The color gray indicates Mogul did not find sufficient equivalents in the CSD to analyse the geometry.

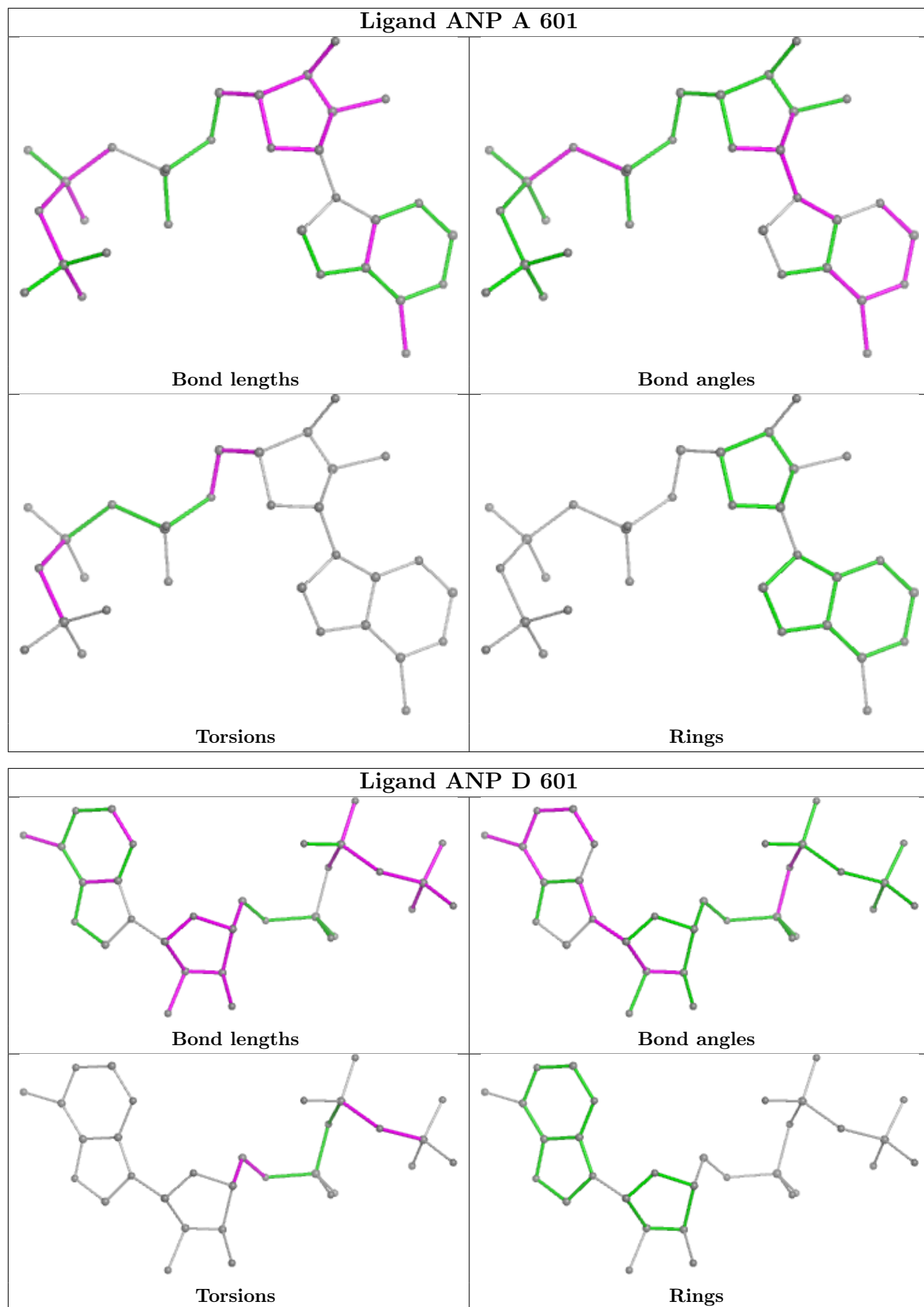

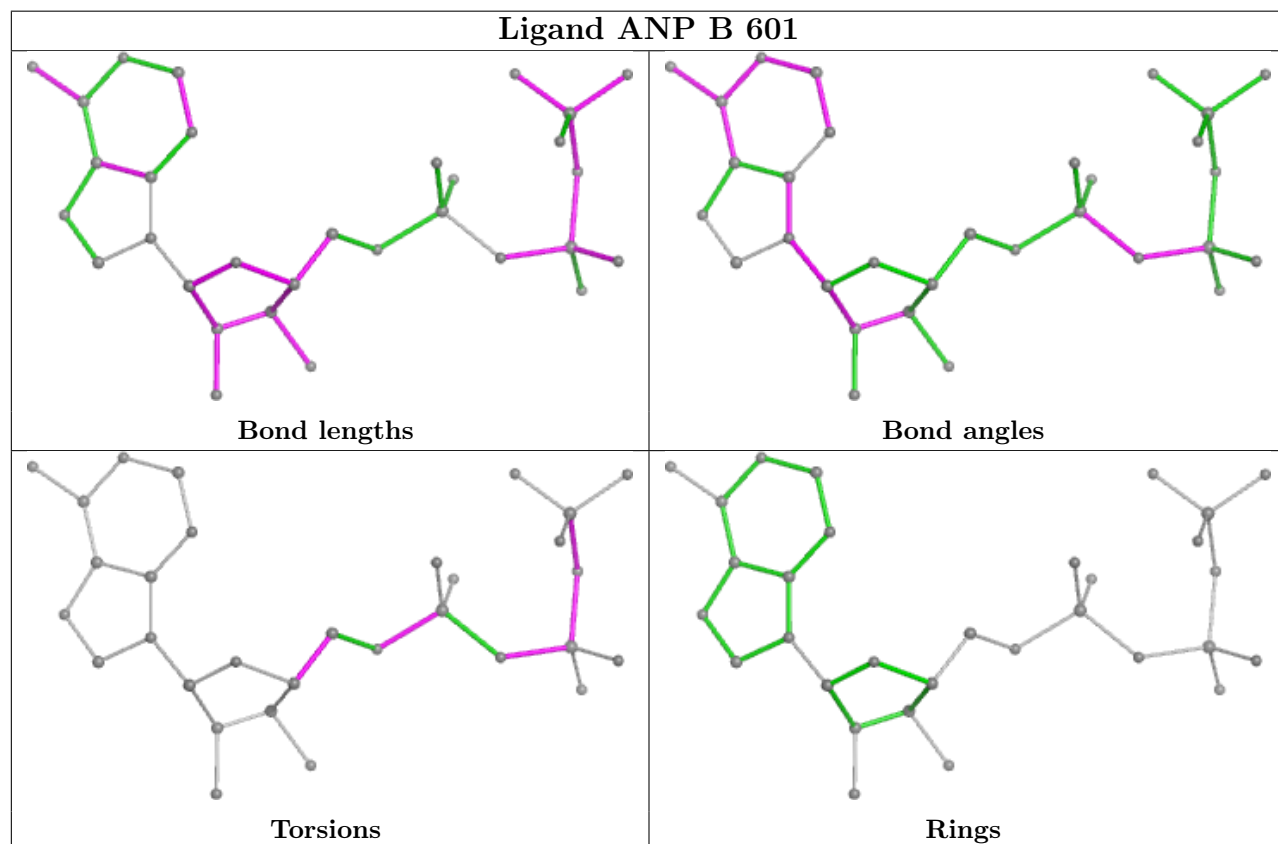
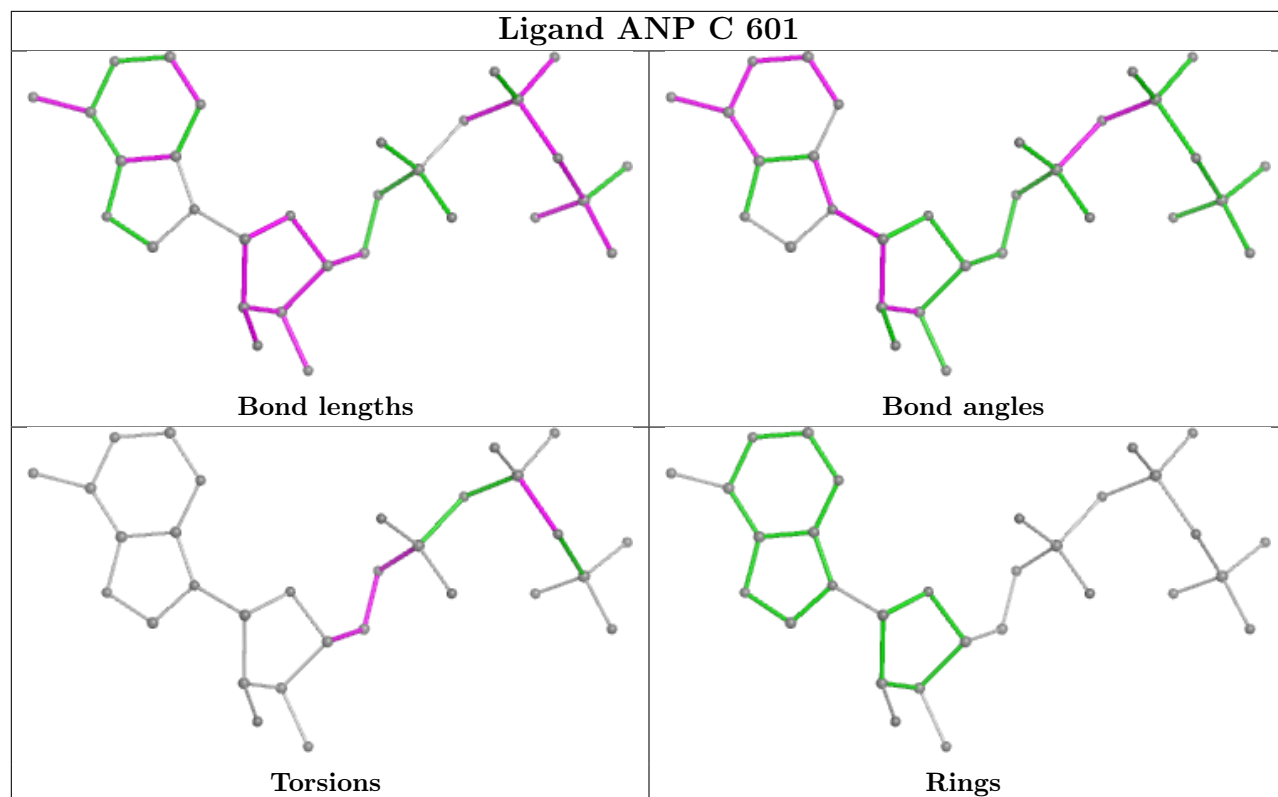

5.7 Other polymers [i](#)

There are no such residues in this entry.

5.8 Polymer linkage issues [i](#)

There are no chain breaks in this entry.

6 Map visualisation [i](#)

This section contains visualisations of the EMDB entry EMD-19574. These allow visual inspection of the internal detail of the map and identification of artifacts.

Images derived from a raw map, generated by summing the deposited half-maps, are presented below the corresponding image components of the primary map to allow further visual inspection and comparison with those of the primary map.

6.1 Orthogonal projections [i](#)

6.1.1 Primary map

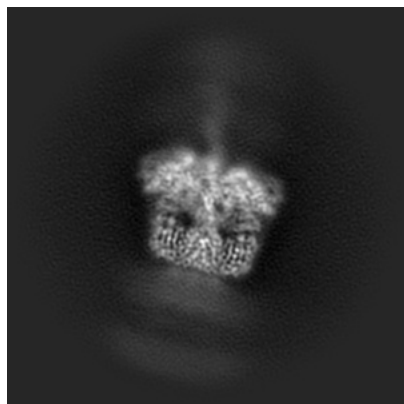

X

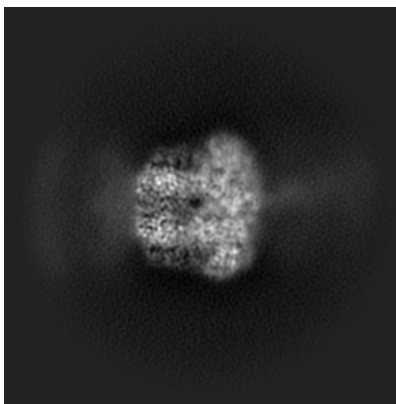

Y

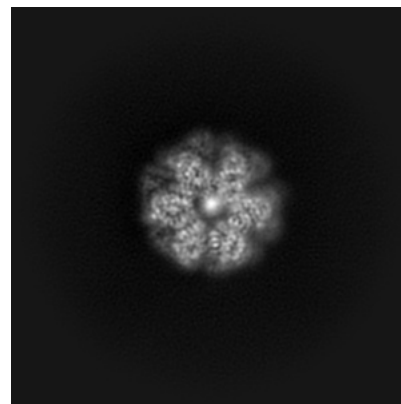

Z

6.1.2 Raw map

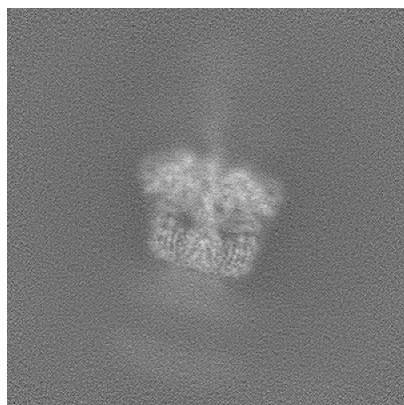

X

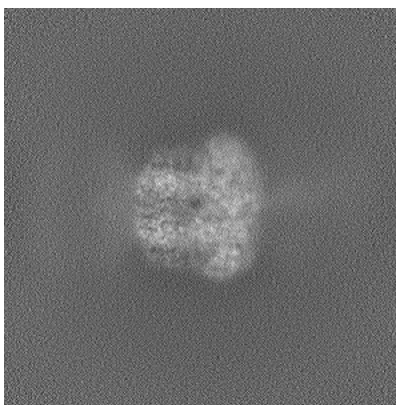

Y

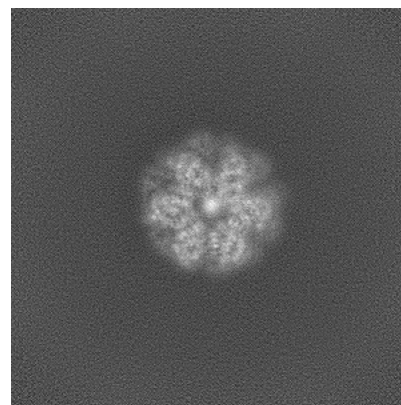

Z

The images above show the map projected in three orthogonal directions.

6.2 Central slices [i](#)

6.2.1 Primary map

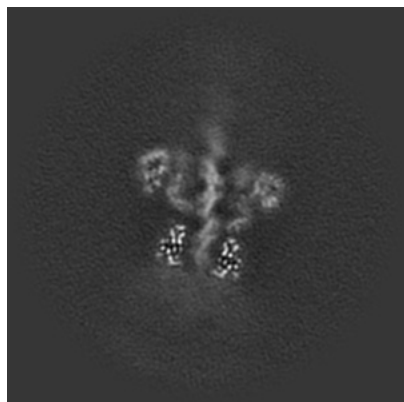

X Index: 250

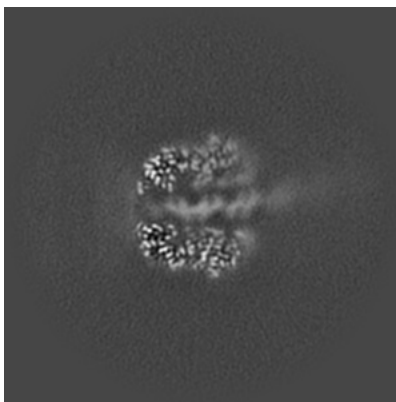

Y Index: 250

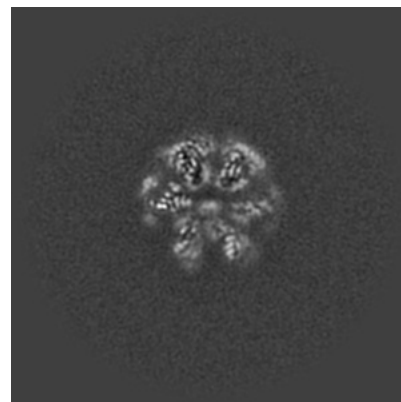

Z Index: 250

6.2.2 Raw map

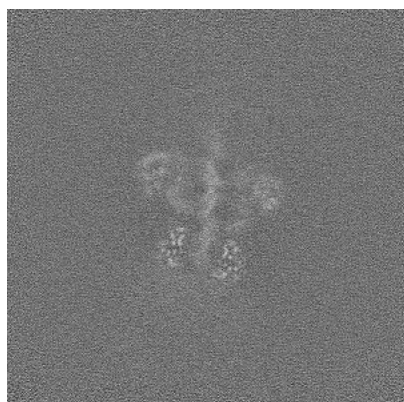

X Index: 250

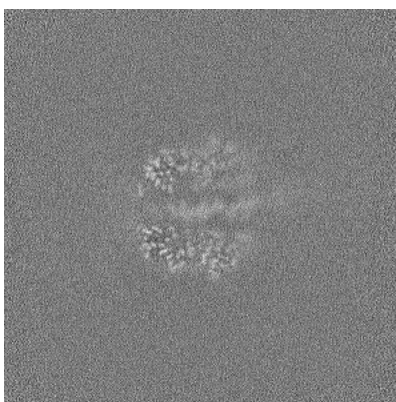

Y Index: 250

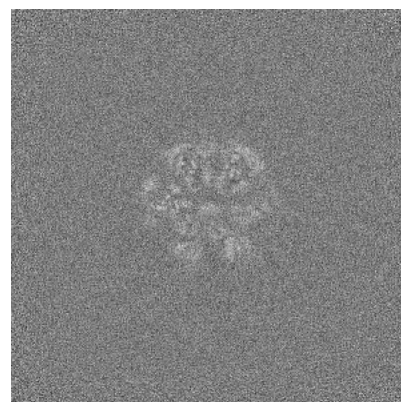

Z Index: 250

The images above show central slices of the map in three orthogonal directions.

6.3 Largest variance slices [i](#)

6.3.1 Primary map

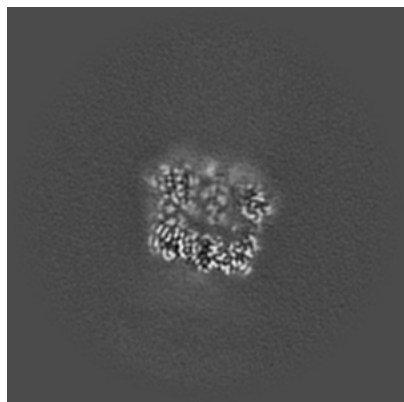

X Index: 216

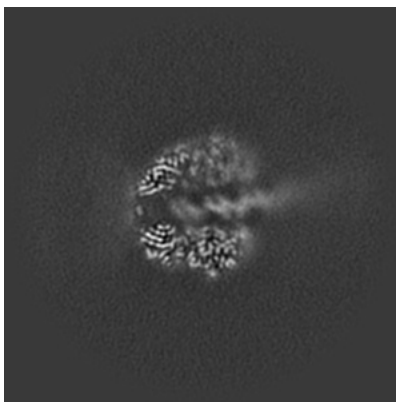

Y Index: 257

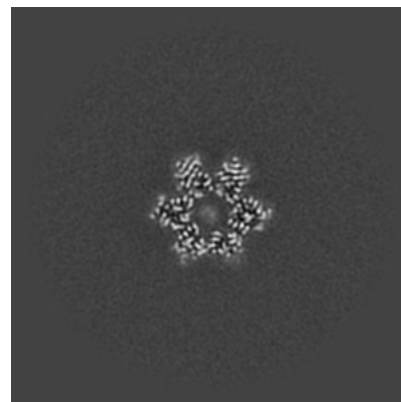

Z Index: 194

6.3.2 Raw map

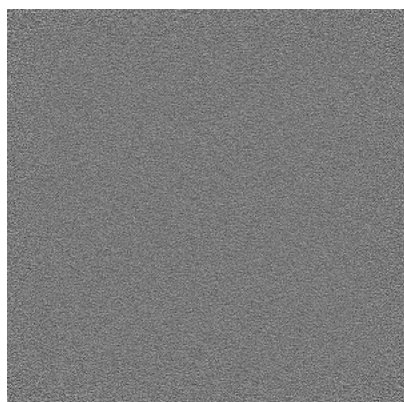

X Index: 0

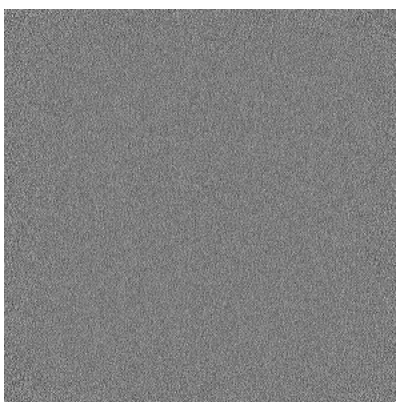

Y Index: 0

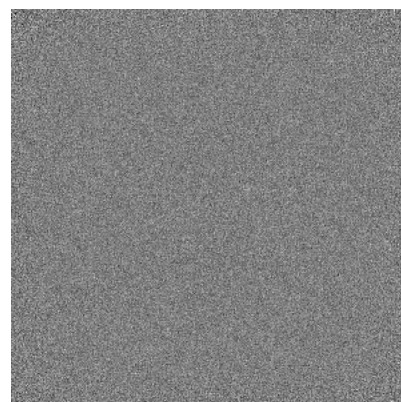

Z Index: 0

The images above show the largest variance slices of the map in three orthogonal directions.

6.4 Orthogonal standard-deviation projections (False-color) [i](#)

6.4.1 Primary map

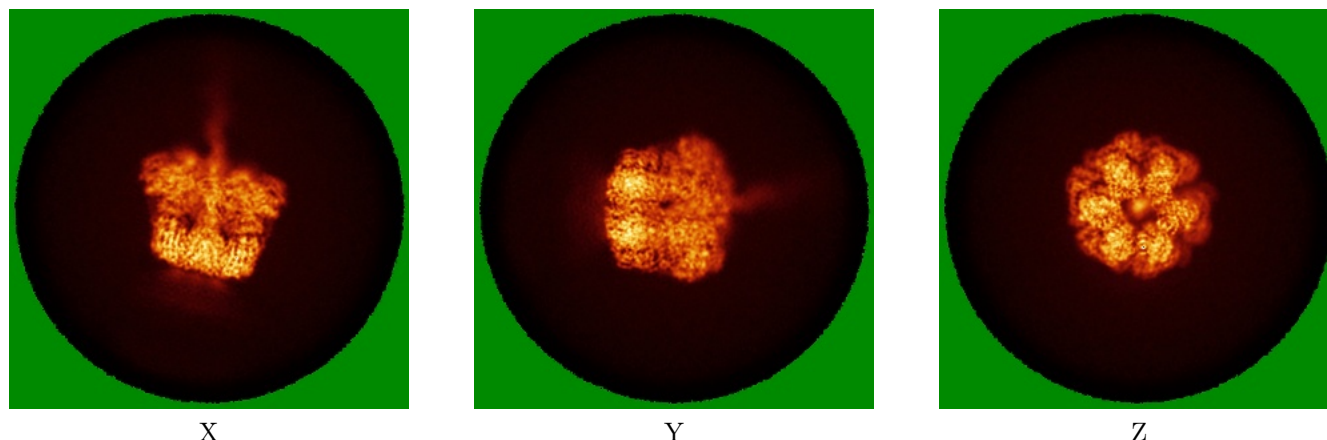

X

Y

Z

6.4.2 Raw map

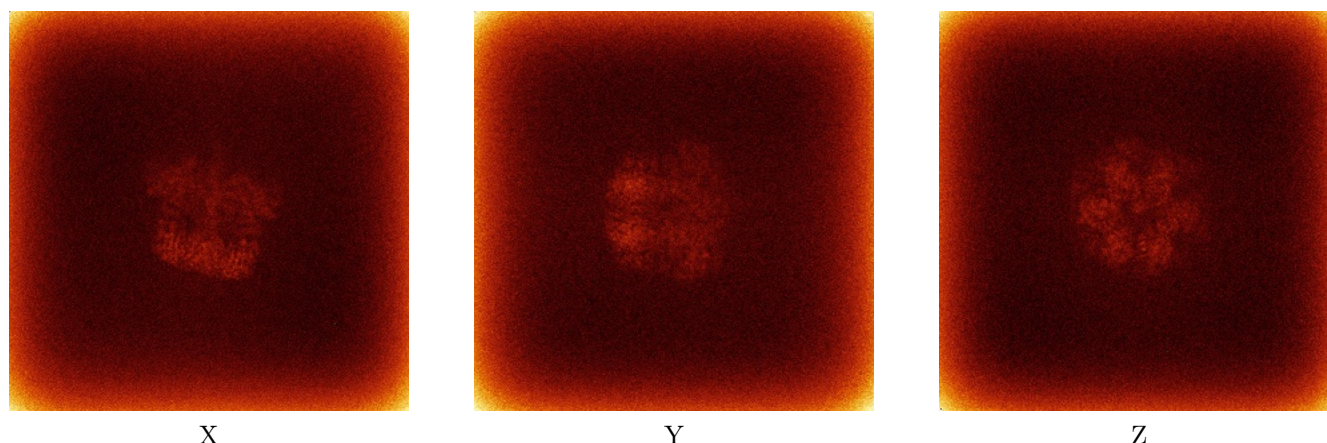

X

Y

Z

The images above show the map standard deviation projections with false color in three orthogonal directions. Minimum values are shown in green, max in blue, and dark to light orange shades represent small to large values respectively.

6.5 Orthogonal surface views [i](#)

6.5.1 Primary map



The images above show the 3D surface view of the map at the recommended contour level 0.2. These images, in conjunction with the slice images, may facilitate assessment of whether an appropriate contour level has been provided.

6.5.2 Raw map

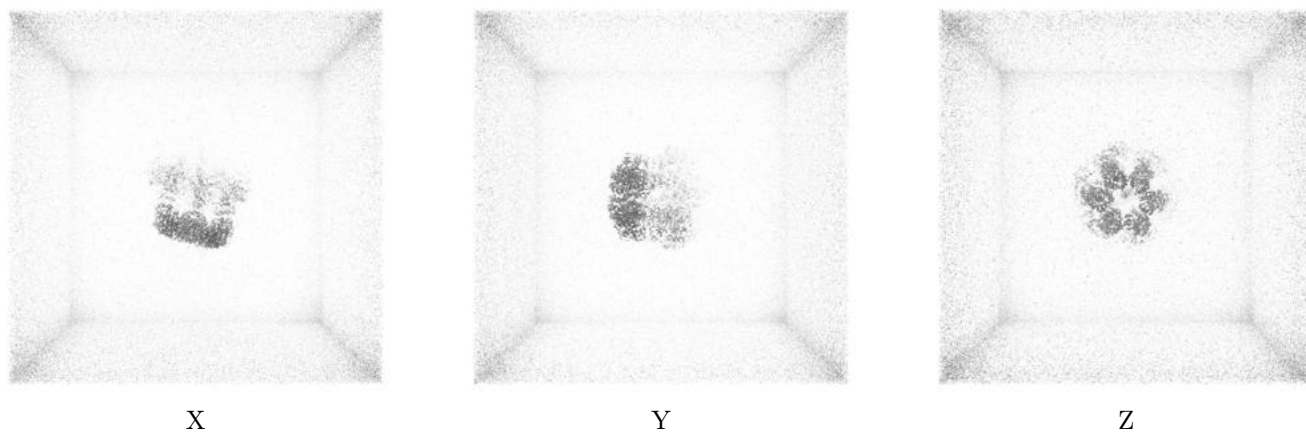

These images show the 3D surface of the raw map. The raw map's contour level was selected so that its surface encloses the same volume as the primary map does at its recommended contour level.

6.6 Mask visualisation [i](#)

This section shows the 3D surface view of the primary map at 50% transparency overlaid with the specified mask at 0% transparency

A mask typically either:

- Encompasses the whole structure
- Separates out a domain, a functional unit, a monomer or an area of interest from a larger structure

6.6.1 emd_19574_msk_1.map [i](#)

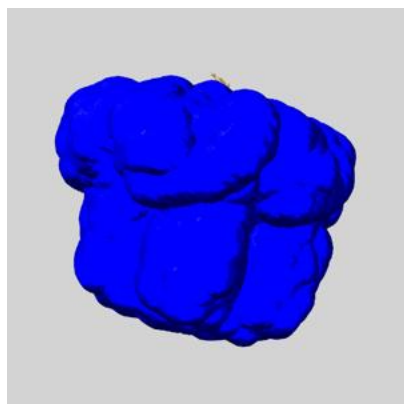

X

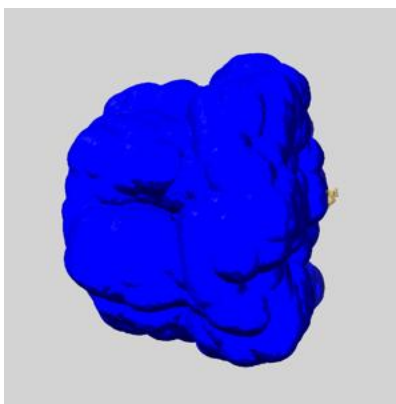

Y

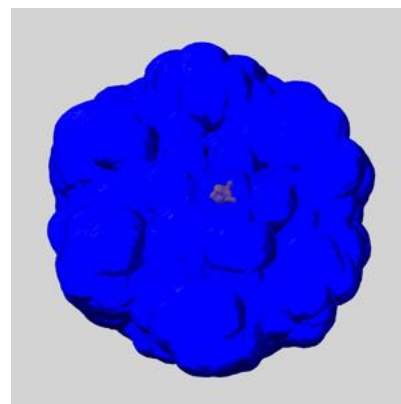

Z

7 Map analysis [i](#)

This section contains the results of statistical analysis of the map.

7.1 Map-value distribution [i](#)

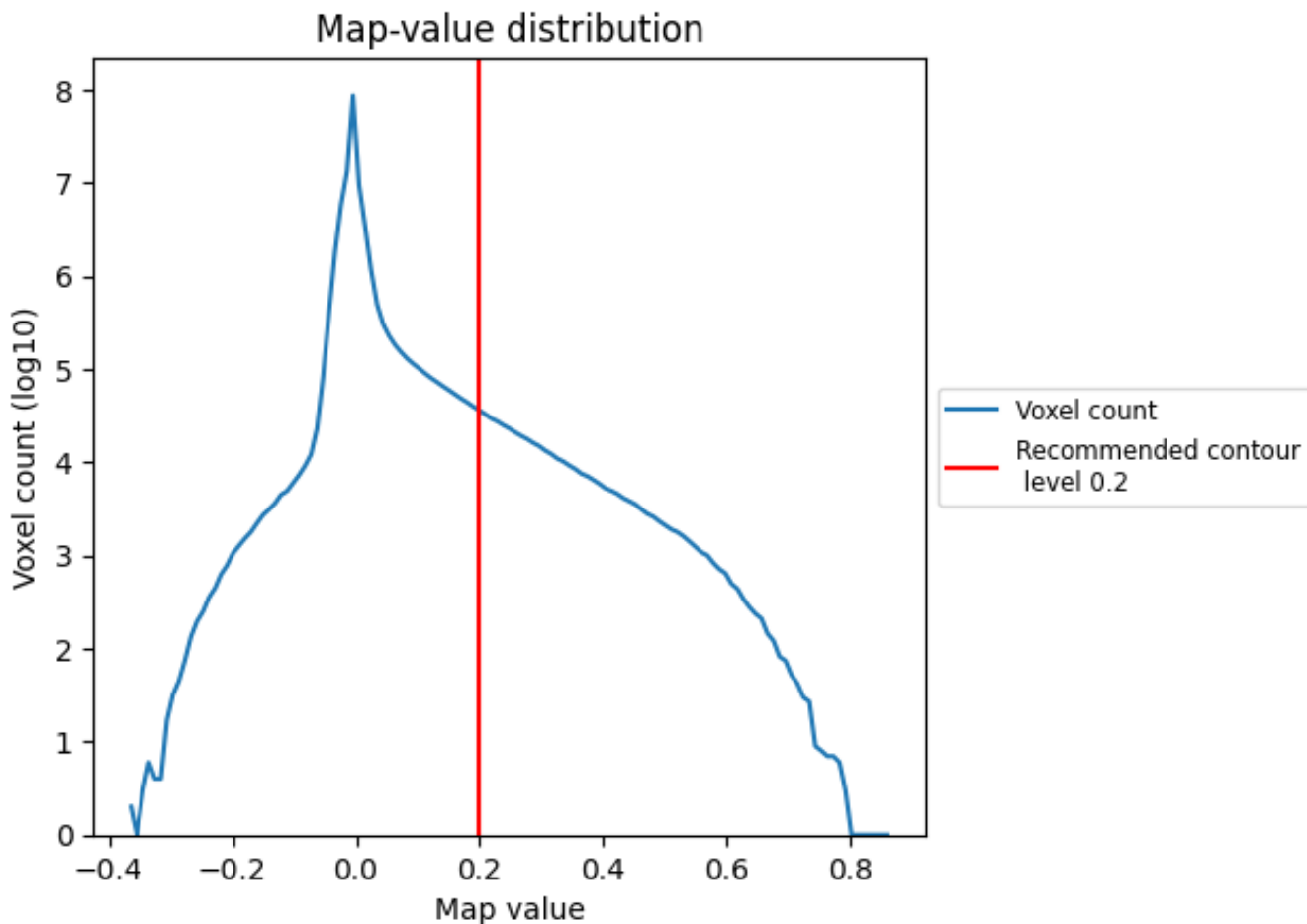

The map-value distribution is plotted in 128 intervals along the x-axis. The y-axis is logarithmic. A spike in this graph at zero usually indicates that the volume has been masked.

7.2 Volume estimate [i](#)

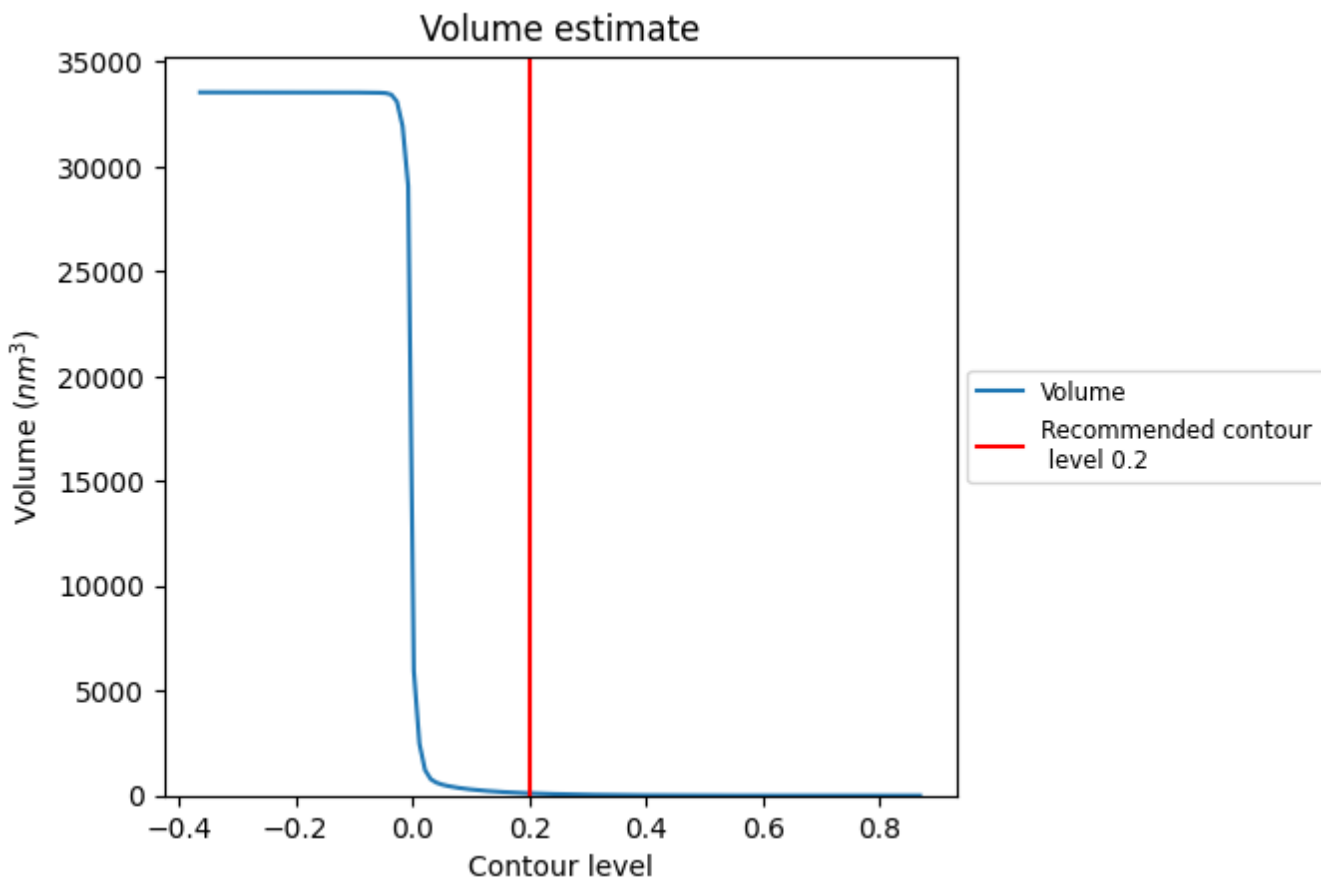

The volume at the recommended contour level is 109 nm³; this corresponds to an approximate mass of 98 kDa.

The volume estimate graph shows how the enclosed volume varies with the contour level. The recommended contour level is shown as a vertical line and the intersection between the line and the curve gives the volume of the enclosed surface at the given level.

7.3 Rotationally averaged power spectrum i

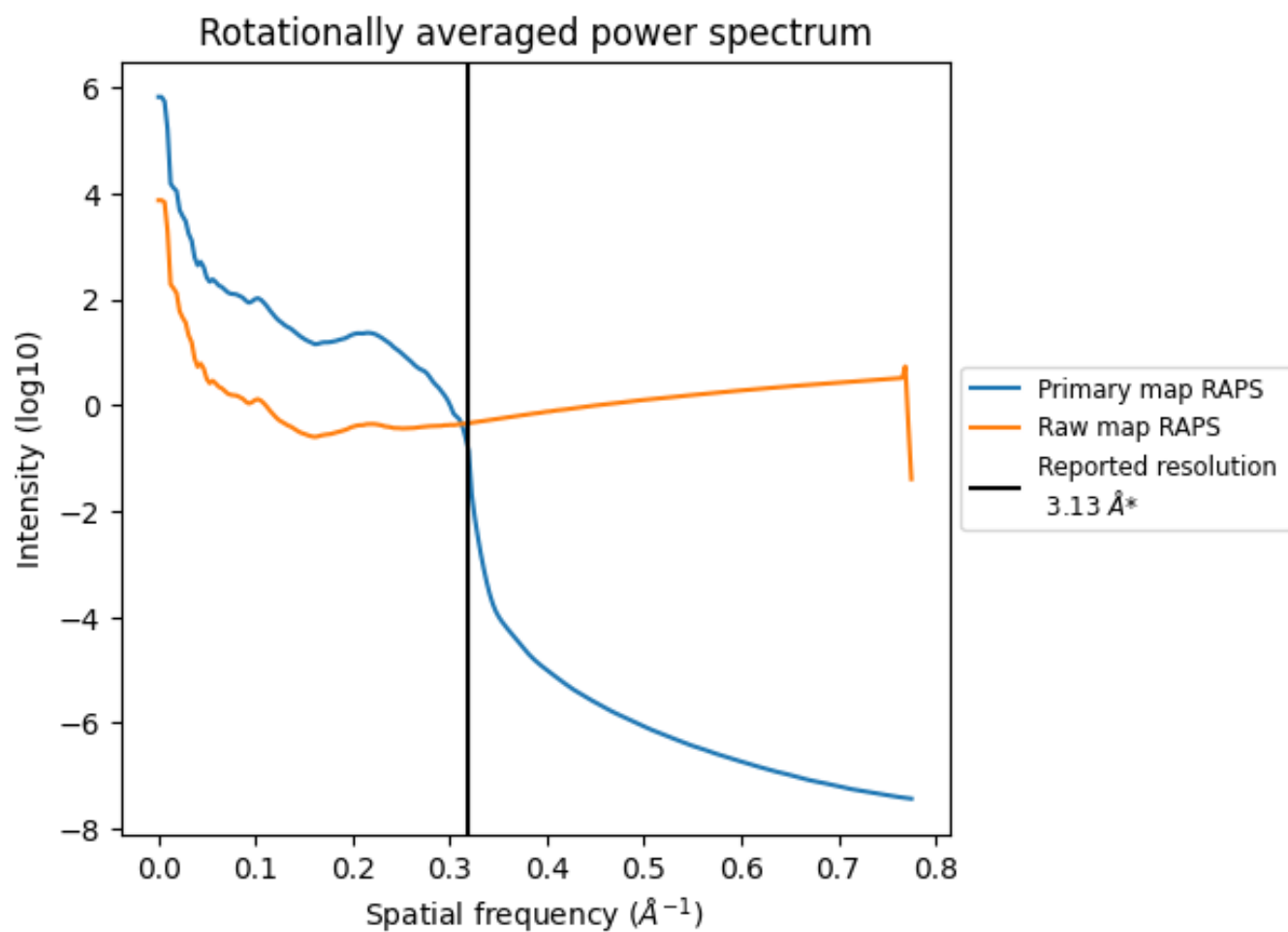

*Reported resolution corresponds to spatial frequency of 0.319 Å⁻¹

8 Fourier-Shell correlation [i](#)

Fourier-Shell Correlation (FSC) is the most commonly used method to estimate the resolution of single-particle and subtomogram-averaged maps. The shape of the curve depends on the imposed symmetry, mask and whether or not the two 3D reconstructions used were processed from a common reference. The reported resolution is shown as a black line. A curve is displayed for the half-bit criterion in addition to lines showing the 0.143 gold standard cut-off and 0.5 cut-off.

8.1 FSC [i](#)

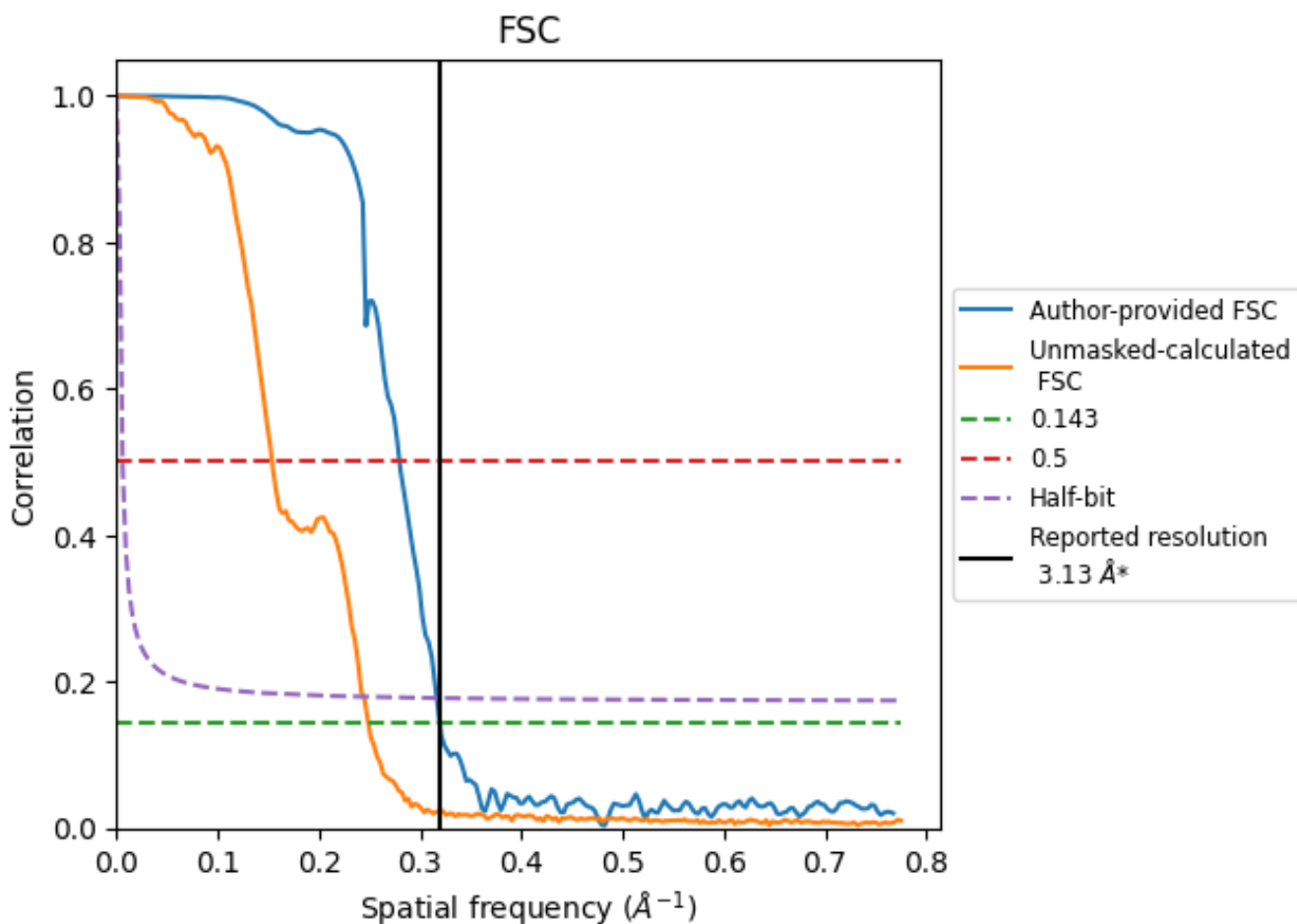

*Reported resolution corresponds to spatial frequency of 0.319\AA^{-1}

8.2 Resolution estimates [i](#)

Resolution estimate (Å)	Estimation criterion (FSC cut-off)		
	0.143	0.5	Half-bit
Reported by author	3.13	-	-
Author-provided FSC curve	3.13	3.58	3.16
Unmasked-calculated*	4.02	6.50	4.10

*Resolution estimate based on FSC curve calculated by comparison of deposited half-maps. The value from deposited half-maps intersecting FSC 0.143 CUT-OFF 4.02 differs from the reported value 3.13 by more than 10 %

9 Map-model fit [i](#)

This section contains information regarding the fit between EMDB map EMD-19574 and PDB model 8RXD. Per-residue inclusion information can be found in section [3](#) on page [8](#).

9.1 Map-model overlay [i](#)

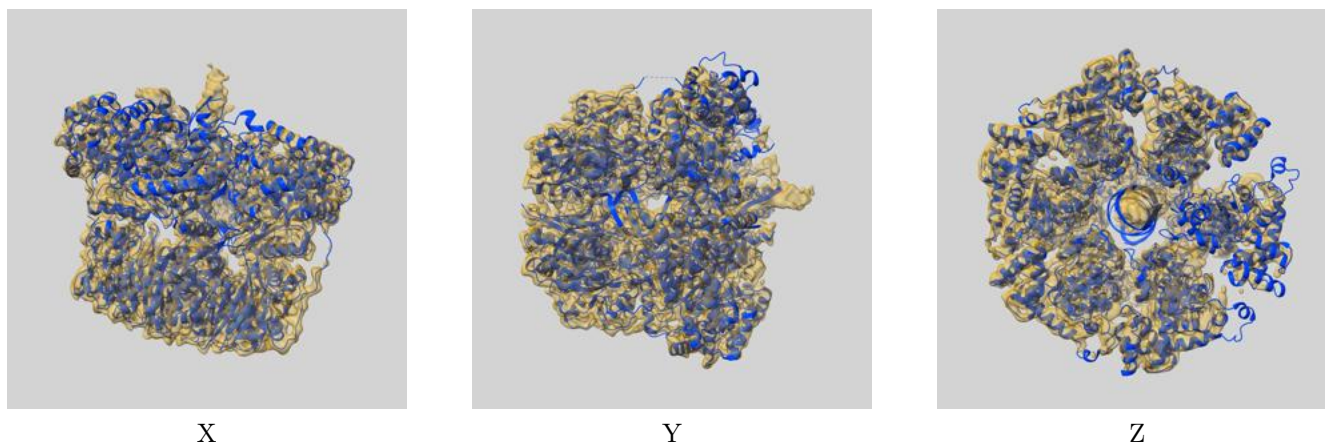

The images above show the 3D surface view of the map at the recommended contour level 0.2 at 50% transparency in yellow overlaid with a ribbon representation of the model coloured in blue. These images allow for the visual assessment of the quality of fit between the atomic model and the map.

9.2 Q-score mapped to coordinate model [\(i\)](#)

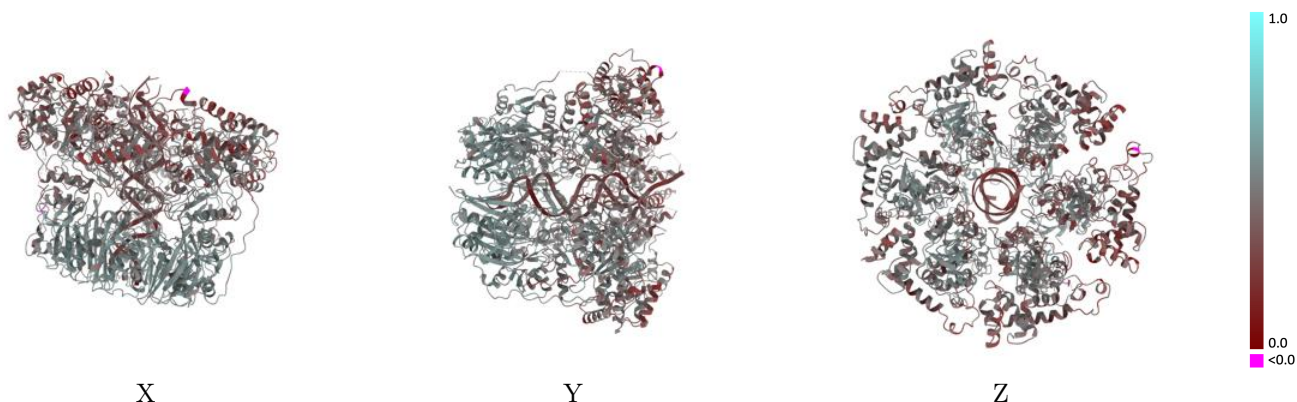

The images above show the model with each residue coloured according to its Q-score. This shows their resolvability in the map with higher Q-score values reflecting better resolvability. Please note: Q-score is calculating the resolvability of atoms, and thus high values are only expected at resolutions at which atoms can be resolved. Low Q-score values may therefore be expected for many entries.

9.3 Atom inclusion mapped to coordinate model [\(i\)](#)

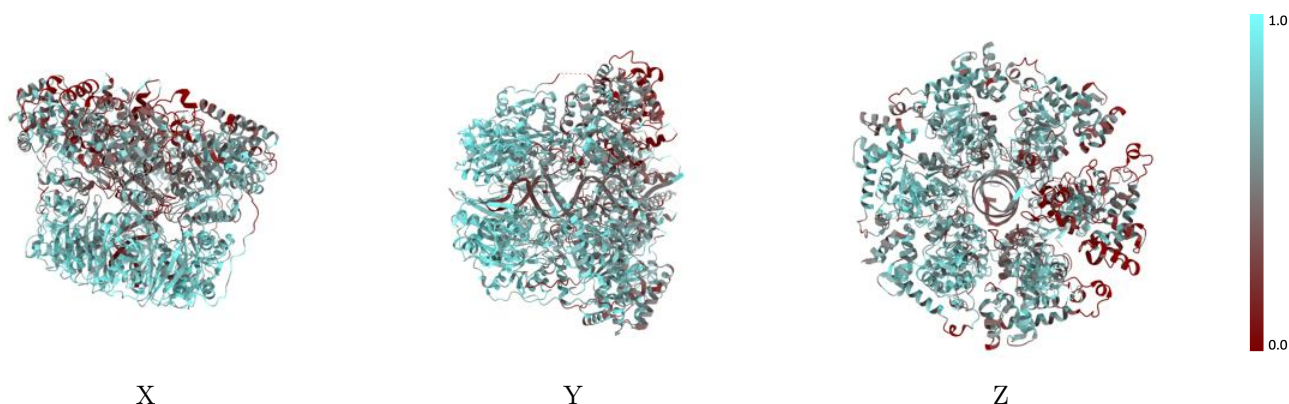

The images above show the model with each residue coloured according to its atom inclusion. This shows to what extent they are inside the map at the recommended contour level (0.2).



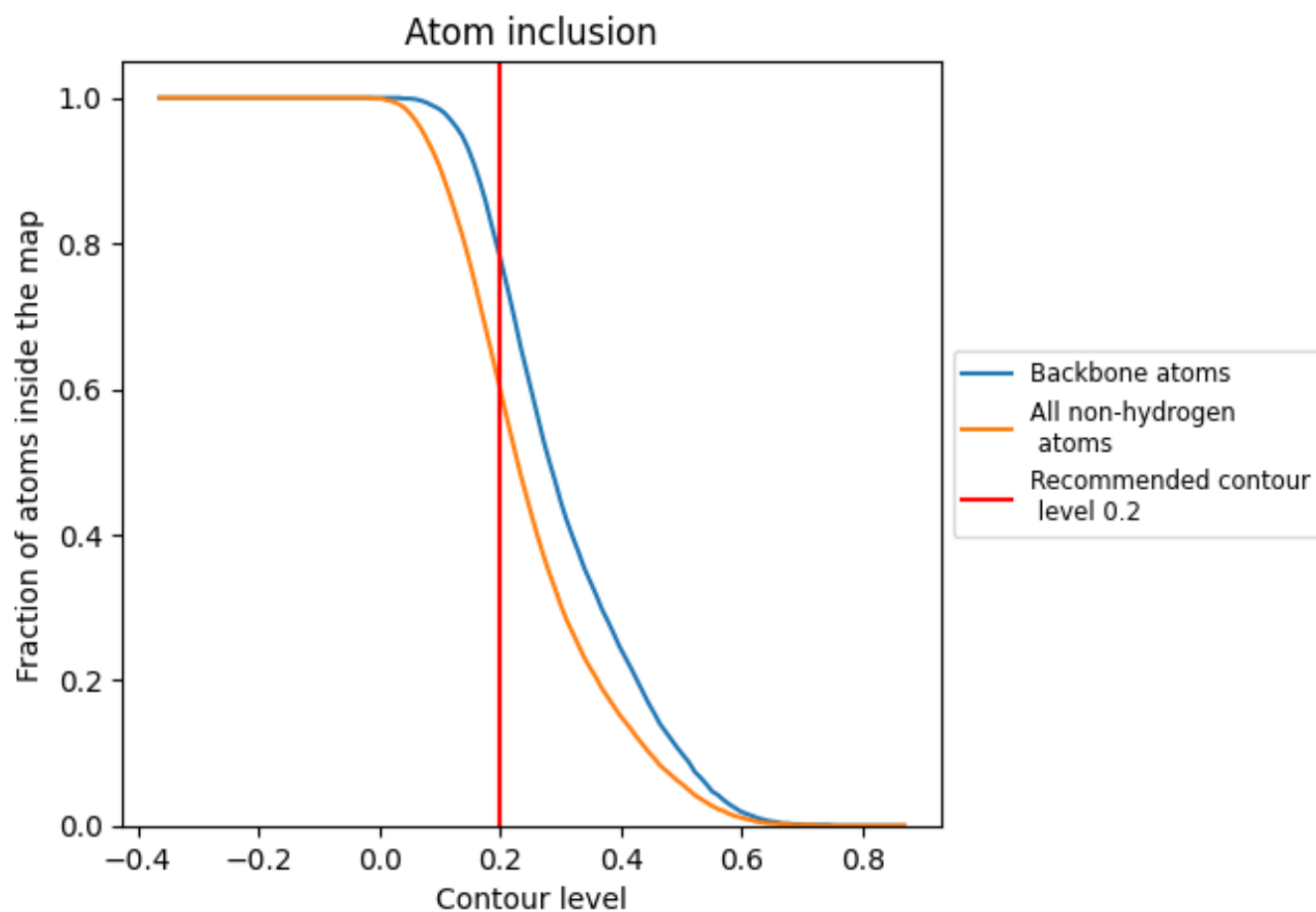















9.4 Atom inclusion [i](#)



At the recommended contour level, 78% of all backbone atoms, 60% of all non-hydrogen atoms, are inside the map.

9.5 Map-model fit summary [i](#)

The table lists the average atom inclusion at the recommended contour level (0.2) and Q-score for the entire model and for each chain.

Chain	Atom inclusion	Q-score
All	 0.5990	 0.4400
A	 0.6000	 0.4430
B	 0.6690	 0.4680
C	 0.6800	 0.4670
D	 0.6540	 0.4560
E	 0.5900	 0.4380
F	 0.4570	 0.4180
Y	 0.3540	 0.2530
Z	 0.3610	 0.2560

