



wwPDB EM Validation Summary Report ⓘ

May 26, 2024 – 12:31 AM EDT

PDB ID : 7RMO
EMDB ID : EMD-24576
Title : Yeast CTP Synthase (Ura7) Bundle bound to Products at low pH
Authors : Hansen, J.M.; Lynch, E.M.; Farrell, D.P.; DiMaio, F.; Quispe, J.; Kollman, J.M.
Deposited on : 2021-07-27
Resolution : 7.00 Å(reported)

This is a wwPDB EM Validation Summary Report for a publicly released PDB entry.

We welcome your comments at validation@mail.wwpdb.org

A user guide is available at

<https://www.wwpdb.org/validation/2017/EMValidationReportHelp>

with specific help available everywhere you see the ⓘ symbol.

The types of validation reports are described at

<http://www.wwpdb.org/validation/2017/FAQs#types>.

The following versions of software and data (see [references ⓘ](#)) were used in the production of this report:

EMDB validation analysis : 0.0.1.dev92
Mogul : 1.8.5 (274361), CSD as541be (2020)
MolProbity : 4.02b-467
buster-report : 1.1.7 (2018)
Percentile statistics : 20191225.v01 (using entries in the PDB archive December 25th 2019)
MapQ : 1.9.13
Ideal geometry (proteins) : Engh & Huber (2001)
Ideal geometry (DNA, RNA) : Parkinson et al. (1996)
Validation Pipeline (wwPDB-VP) : 2.36.2

1 Overall quality at a glance i

The following experimental techniques were used to determine the structure:
ELECTRON MICROSCOPY

The reported resolution of this entry is 7.00 Å.

Percentile scores (ranging between 0-100) for global validation metrics of the entry are shown in the following graphic. The table shows the number of entries on which the scores are based.

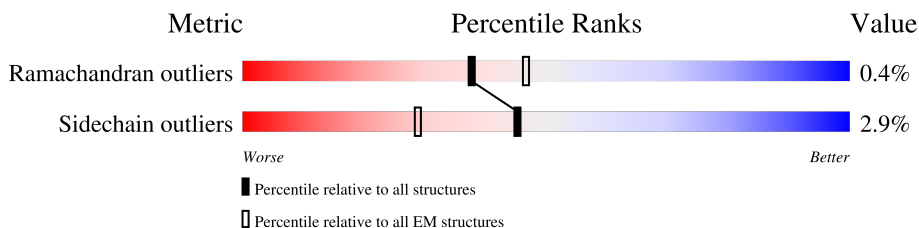

Metric	Whole archive (#Entries)	EM structures (#Entries)
Ramachandran outliers	154571	4023
Sidechain outliers	154315	3826

The table below summarises the geometric issues observed across the polymeric chains and their fit to the map. The red, orange, yellow and green segments of the bar indicate the fraction of residues that contain outliers for ≥ 3 , 2, 1 and 0 types of geometric quality criteria respectively. A grey segment represents the fraction of residues that are not modelled. The numeric value for each fraction is indicated below the corresponding segment, with a dot representing fractions $\leq 5\%$. The upper red bar (where present) indicates the fraction of residues that have poor fit to the EM map (all-atom inclusion $< 40\%$). The numeric value is given above the bar.

Mol	Chain	Length	Quality of chain
1	A	557	
1	B	557	
1	C	557	
1	D	557	
1	E	557	
1	F	557	
1	G	557	
1	H	557	
1	I	557	

Continued on next page...

Continued from previous page...

Mol	Chain	Length	Quality of chain
1	J	557	69% 95% 5% •
1	K	557	63% 95% 5% •
1	L	557	• 95% 5% •
1	M	557	16% 95% 5% •
1	N	557	68% 95% 5% •
1	O	557	75% 95% 5% •
1	P	557	9% 95% 5% •
1	Q	557	13% 95% 5% •
1	R	557	66% 95% 5% •
1	S	557	74% 95% 5% •
1	T	557	• 95% 5% •
1	U	557	12% 95% 5% •
1	V	557	60% 95% 5% •
1	W	557	66% 95% 5% •
1	X	557	9% 95% 5% •
1	Y	557	67% 95% 5% •
1	Z	557	60% 95% 5% •
1	a	557	69% 95% 5% •
1	b	557	67% 95% 5% •

2 Entry composition [i](#)

There are 2 unique types of molecules in this entry. The entry contains 247632 atoms, of which 123396 are hydrogens and 0 are deuteriums.

In the tables below, the AltConf column contains the number of residues with at least one atom in alternate conformation and the Trace column contains the number of residues modelled with at most 2 atoms.

- Molecule 1 is a protein called CTP synthase.

Mol	Chain	Residues	Atoms					AltConf	Trace	
			Total	C	H	N	O			S
1	D	557	8786	2787	4407	742	827	23	0	0
1	A	557	8786	2787	4407	742	827	23	0	0
1	B	557	8786	2787	4407	742	827	23	0	0
1	C	557	8786	2787	4407	742	827	23	0	0
1	U	557	8786	2787	4407	742	827	23	0	0
1	I	557	8786	2787	4407	742	827	23	0	0
1	M	557	8786	2787	4407	742	827	23	0	0
1	Q	557	8786	2787	4407	742	827	23	0	0
1	V	557	8786	2787	4407	742	827	23	0	0
1	J	557	8786	2787	4407	742	827	23	0	0
1	N	557	8786	2787	4407	742	827	23	0	0
1	R	557	8786	2787	4407	742	827	23	0	0
1	H	557	8786	2787	4407	742	827	23	0	0
1	E	557	8786	2787	4407	742	827	23	0	0
1	F	557	8786	2787	4407	742	827	23	0	0
1	G	557	8786	2787	4407	742	827	23	0	0
1	W	557	8786	2787	4407	742	827	23	0	0

Continued on next page...

Continued from previous page...

Mol	Chain	Residues	Atoms					AltConf	Trace	
			Total	C	H	N	O			S
1	K	557	8786	2787	4407	742	827	23	0	0
1	O	557	8786	2787	4407	742	827	23	0	0
1	S	557	8786	2787	4407	742	827	23	0	0
1	b	557	8786	2787	4407	742	827	23	0	0
1	Y	557	8786	2787	4407	742	827	23	0	0
1	Z	557	8786	2787	4407	742	827	23	0	0
1	a	557	8786	2787	4407	742	827	23	0	0
1	X	557	8786	2787	4407	742	827	23	0	0
1	L	557	8786	2787	4407	742	827	23	0	0
1	P	557	8786	2787	4407	742	827	23	0	0
1	T	557	8786	2787	4407	742	827	23	0	0

There are 420 discrepancies between the modelled and reference sequences:

Chain	Residue	Modelled	Actual	Comment	Reference
D	?	-	SER	deletion	UNP A0A7I9CFN1
D	?	-	LEU	deletion	UNP A0A7I9CFN1
D	?	-	SER	deletion	UNP A0A7I9CFN1
D	?	-	MET	deletion	UNP A0A7I9CFN1
D	?	-	PRO	deletion	UNP A0A7I9CFN1
D	?	-	GLU	deletion	UNP A0A7I9CFN1
D	?	-	ILE	deletion	UNP A0A7I9CFN1
D	?	-	ASP	deletion	UNP A0A7I9CFN1
D	?	-	LYS	deletion	UNP A0A7I9CFN1
D	?	-	GLU	deletion	UNP A0A7I9CFN1
D	?	-	THR	deletion	UNP A0A7I9CFN1
D	?	-	MET	deletion	UNP A0A7I9CFN1
D	?	-	GLY	deletion	UNP A0A7I9CFN1
D	?	-	GLY	deletion	UNP A0A7I9CFN1
D	?	-	SER	deletion	UNP A0A7I9CFN1
A	?	-	SER	deletion	UNP A0A7I9CFN1
A	?	-	LEU	deletion	UNP A0A7I9CFN1

Continued on next page...

Continued from previous page...

Chain	Residue	Modelled	Actual	Comment	Reference
A	?	-	SER	deletion	UNP A0A7I9CFN1
A	?	-	MET	deletion	UNP A0A7I9CFN1
A	?	-	PRO	deletion	UNP A0A7I9CFN1
A	?	-	GLU	deletion	UNP A0A7I9CFN1
A	?	-	ILE	deletion	UNP A0A7I9CFN1
A	?	-	ASP	deletion	UNP A0A7I9CFN1
A	?	-	LYS	deletion	UNP A0A7I9CFN1
A	?	-	GLU	deletion	UNP A0A7I9CFN1
A	?	-	THR	deletion	UNP A0A7I9CFN1
A	?	-	MET	deletion	UNP A0A7I9CFN1
A	?	-	GLY	deletion	UNP A0A7I9CFN1
A	?	-	GLY	deletion	UNP A0A7I9CFN1
A	?	-	SER	deletion	UNP A0A7I9CFN1
B	?	-	SER	deletion	UNP A0A7I9CFN1
B	?	-	LEU	deletion	UNP A0A7I9CFN1
B	?	-	SER	deletion	UNP A0A7I9CFN1
B	?	-	MET	deletion	UNP A0A7I9CFN1
B	?	-	PRO	deletion	UNP A0A7I9CFN1
B	?	-	GLU	deletion	UNP A0A7I9CFN1
B	?	-	ILE	deletion	UNP A0A7I9CFN1
B	?	-	ASP	deletion	UNP A0A7I9CFN1
B	?	-	LYS	deletion	UNP A0A7I9CFN1
B	?	-	GLU	deletion	UNP A0A7I9CFN1
B	?	-	THR	deletion	UNP A0A7I9CFN1
B	?	-	MET	deletion	UNP A0A7I9CFN1
B	?	-	GLY	deletion	UNP A0A7I9CFN1
B	?	-	GLY	deletion	UNP A0A7I9CFN1
B	?	-	SER	deletion	UNP A0A7I9CFN1
C	?	-	SER	deletion	UNP A0A7I9CFN1
C	?	-	LEU	deletion	UNP A0A7I9CFN1
C	?	-	SER	deletion	UNP A0A7I9CFN1
C	?	-	MET	deletion	UNP A0A7I9CFN1
C	?	-	PRO	deletion	UNP A0A7I9CFN1
C	?	-	GLU	deletion	UNP A0A7I9CFN1
C	?	-	ILE	deletion	UNP A0A7I9CFN1
C	?	-	ASP	deletion	UNP A0A7I9CFN1
C	?	-	LYS	deletion	UNP A0A7I9CFN1
C	?	-	GLU	deletion	UNP A0A7I9CFN1
C	?	-	THR	deletion	UNP A0A7I9CFN1
C	?	-	MET	deletion	UNP A0A7I9CFN1
C	?	-	GLY	deletion	UNP A0A7I9CFN1
C	?	-	GLY	deletion	UNP A0A7I9CFN1

Continued on next page...

Continued from previous page...

Chain	Residue	Modelled	Actual	Comment	Reference
C	?	-	SER	deletion	UNP A0A7I9CFN1
U	?	-	SER	deletion	UNP A0A7I9CFN1
U	?	-	LEU	deletion	UNP A0A7I9CFN1
U	?	-	SER	deletion	UNP A0A7I9CFN1
U	?	-	MET	deletion	UNP A0A7I9CFN1
U	?	-	PRO	deletion	UNP A0A7I9CFN1
U	?	-	GLU	deletion	UNP A0A7I9CFN1
U	?	-	ILE	deletion	UNP A0A7I9CFN1
U	?	-	ASP	deletion	UNP A0A7I9CFN1
U	?	-	LYS	deletion	UNP A0A7I9CFN1
U	?	-	GLU	deletion	UNP A0A7I9CFN1
U	?	-	THR	deletion	UNP A0A7I9CFN1
U	?	-	MET	deletion	UNP A0A7I9CFN1
U	?	-	GLY	deletion	UNP A0A7I9CFN1
U	?	-	GLY	deletion	UNP A0A7I9CFN1
U	?	-	SER	deletion	UNP A0A7I9CFN1
I	?	-	SER	deletion	UNP A0A7I9CFN1
I	?	-	LEU	deletion	UNP A0A7I9CFN1
I	?	-	SER	deletion	UNP A0A7I9CFN1
I	?	-	MET	deletion	UNP A0A7I9CFN1
I	?	-	PRO	deletion	UNP A0A7I9CFN1
I	?	-	GLU	deletion	UNP A0A7I9CFN1
I	?	-	ILE	deletion	UNP A0A7I9CFN1
I	?	-	ASP	deletion	UNP A0A7I9CFN1
I	?	-	LYS	deletion	UNP A0A7I9CFN1
I	?	-	GLU	deletion	UNP A0A7I9CFN1
I	?	-	THR	deletion	UNP A0A7I9CFN1
I	?	-	MET	deletion	UNP A0A7I9CFN1
I	?	-	GLY	deletion	UNP A0A7I9CFN1
I	?	-	GLY	deletion	UNP A0A7I9CFN1
I	?	-	SER	deletion	UNP A0A7I9CFN1
M	?	-	SER	deletion	UNP A0A7I9CFN1
M	?	-	LEU	deletion	UNP A0A7I9CFN1
M	?	-	SER	deletion	UNP A0A7I9CFN1
M	?	-	MET	deletion	UNP A0A7I9CFN1
M	?	-	PRO	deletion	UNP A0A7I9CFN1
M	?	-	GLU	deletion	UNP A0A7I9CFN1
M	?	-	ILE	deletion	UNP A0A7I9CFN1
M	?	-	ASP	deletion	UNP A0A7I9CFN1
M	?	-	LYS	deletion	UNP A0A7I9CFN1
M	?	-	GLU	deletion	UNP A0A7I9CFN1
M	?	-	THR	deletion	UNP A0A7I9CFN1

Continued on next page...

Continued from previous page...

Chain	Residue	Modelled	Actual	Comment	Reference
M	?	-	MET	deletion	UNP A0A7I9CFN1
M	?	-	GLY	deletion	UNP A0A7I9CFN1
M	?	-	GLY	deletion	UNP A0A7I9CFN1
M	?	-	SER	deletion	UNP A0A7I9CFN1
Q	?	-	SER	deletion	UNP A0A7I9CFN1
Q	?	-	LEU	deletion	UNP A0A7I9CFN1
Q	?	-	SER	deletion	UNP A0A7I9CFN1
Q	?	-	MET	deletion	UNP A0A7I9CFN1
Q	?	-	PRO	deletion	UNP A0A7I9CFN1
Q	?	-	GLU	deletion	UNP A0A7I9CFN1
Q	?	-	ILE	deletion	UNP A0A7I9CFN1
Q	?	-	ASP	deletion	UNP A0A7I9CFN1
Q	?	-	LYS	deletion	UNP A0A7I9CFN1
Q	?	-	GLU	deletion	UNP A0A7I9CFN1
Q	?	-	THR	deletion	UNP A0A7I9CFN1
Q	?	-	MET	deletion	UNP A0A7I9CFN1
Q	?	-	GLY	deletion	UNP A0A7I9CFN1
Q	?	-	GLY	deletion	UNP A0A7I9CFN1
Q	?	-	SER	deletion	UNP A0A7I9CFN1
V	?	-	SER	deletion	UNP A0A7I9CFN1
V	?	-	LEU	deletion	UNP A0A7I9CFN1
V	?	-	SER	deletion	UNP A0A7I9CFN1
V	?	-	MET	deletion	UNP A0A7I9CFN1
V	?	-	PRO	deletion	UNP A0A7I9CFN1
V	?	-	GLU	deletion	UNP A0A7I9CFN1
V	?	-	ILE	deletion	UNP A0A7I9CFN1
V	?	-	ASP	deletion	UNP A0A7I9CFN1
V	?	-	LYS	deletion	UNP A0A7I9CFN1
V	?	-	GLU	deletion	UNP A0A7I9CFN1
V	?	-	THR	deletion	UNP A0A7I9CFN1
V	?	-	MET	deletion	UNP A0A7I9CFN1
V	?	-	GLY	deletion	UNP A0A7I9CFN1
V	?	-	GLY	deletion	UNP A0A7I9CFN1
V	?	-	SER	deletion	UNP A0A7I9CFN1
J	?	-	SER	deletion	UNP A0A7I9CFN1
J	?	-	LEU	deletion	UNP A0A7I9CFN1
J	?	-	SER	deletion	UNP A0A7I9CFN1
J	?	-	MET	deletion	UNP A0A7I9CFN1
J	?	-	PRO	deletion	UNP A0A7I9CFN1
J	?	-	GLU	deletion	UNP A0A7I9CFN1
J	?	-	ILE	deletion	UNP A0A7I9CFN1
J	?	-	ASP	deletion	UNP A0A7I9CFN1

Continued on next page...

Continued from previous page...

Chain	Residue	Modelled	Actual	Comment	Reference
J	?	-	LYS	deletion	UNP A0A7I9CFN1
J	?	-	GLU	deletion	UNP A0A7I9CFN1
J	?	-	THR	deletion	UNP A0A7I9CFN1
J	?	-	MET	deletion	UNP A0A7I9CFN1
J	?	-	GLY	deletion	UNP A0A7I9CFN1
J	?	-	GLY	deletion	UNP A0A7I9CFN1
J	?	-	SER	deletion	UNP A0A7I9CFN1
N	?	-	SER	deletion	UNP A0A7I9CFN1
N	?	-	LEU	deletion	UNP A0A7I9CFN1
N	?	-	SER	deletion	UNP A0A7I9CFN1
N	?	-	MET	deletion	UNP A0A7I9CFN1
N	?	-	PRO	deletion	UNP A0A7I9CFN1
N	?	-	GLU	deletion	UNP A0A7I9CFN1
N	?	-	ILE	deletion	UNP A0A7I9CFN1
N	?	-	ASP	deletion	UNP A0A7I9CFN1
N	?	-	LYS	deletion	UNP A0A7I9CFN1
N	?	-	GLU	deletion	UNP A0A7I9CFN1
N	?	-	THR	deletion	UNP A0A7I9CFN1
N	?	-	MET	deletion	UNP A0A7I9CFN1
N	?	-	GLY	deletion	UNP A0A7I9CFN1
N	?	-	GLY	deletion	UNP A0A7I9CFN1
N	?	-	SER	deletion	UNP A0A7I9CFN1
R	?	-	SER	deletion	UNP A0A7I9CFN1
R	?	-	LEU	deletion	UNP A0A7I9CFN1
R	?	-	SER	deletion	UNP A0A7I9CFN1
R	?	-	MET	deletion	UNP A0A7I9CFN1
R	?	-	PRO	deletion	UNP A0A7I9CFN1
R	?	-	GLU	deletion	UNP A0A7I9CFN1
R	?	-	ILE	deletion	UNP A0A7I9CFN1
R	?	-	ASP	deletion	UNP A0A7I9CFN1
R	?	-	LYS	deletion	UNP A0A7I9CFN1
R	?	-	GLU	deletion	UNP A0A7I9CFN1
R	?	-	THR	deletion	UNP A0A7I9CFN1
R	?	-	MET	deletion	UNP A0A7I9CFN1
R	?	-	GLY	deletion	UNP A0A7I9CFN1
R	?	-	GLY	deletion	UNP A0A7I9CFN1
R	?	-	SER	deletion	UNP A0A7I9CFN1
H	?	-	SER	deletion	UNP A0A7I9CFN1
H	?	-	LEU	deletion	UNP A0A7I9CFN1
H	?	-	SER	deletion	UNP A0A7I9CFN1
H	?	-	MET	deletion	UNP A0A7I9CFN1
H	?	-	PRO	deletion	UNP A0A7I9CFN1

Continued on next page...

Continued from previous page...

Chain	Residue	Modelled	Actual	Comment	Reference
H	?	-	GLU	deletion	UNP A0A7I9CFN1
H	?	-	ILE	deletion	UNP A0A7I9CFN1
H	?	-	ASP	deletion	UNP A0A7I9CFN1
H	?	-	LYS	deletion	UNP A0A7I9CFN1
H	?	-	GLU	deletion	UNP A0A7I9CFN1
H	?	-	THR	deletion	UNP A0A7I9CFN1
H	?	-	MET	deletion	UNP A0A7I9CFN1
H	?	-	GLY	deletion	UNP A0A7I9CFN1
H	?	-	GLY	deletion	UNP A0A7I9CFN1
H	?	-	SER	deletion	UNP A0A7I9CFN1
E	?	-	SER	deletion	UNP A0A7I9CFN1
E	?	-	LEU	deletion	UNP A0A7I9CFN1
E	?	-	SER	deletion	UNP A0A7I9CFN1
E	?	-	MET	deletion	UNP A0A7I9CFN1
E	?	-	PRO	deletion	UNP A0A7I9CFN1
E	?	-	GLU	deletion	UNP A0A7I9CFN1
E	?	-	ILE	deletion	UNP A0A7I9CFN1
E	?	-	ASP	deletion	UNP A0A7I9CFN1
E	?	-	LYS	deletion	UNP A0A7I9CFN1
E	?	-	GLU	deletion	UNP A0A7I9CFN1
E	?	-	THR	deletion	UNP A0A7I9CFN1
E	?	-	MET	deletion	UNP A0A7I9CFN1
E	?	-	GLY	deletion	UNP A0A7I9CFN1
E	?	-	GLY	deletion	UNP A0A7I9CFN1
E	?	-	SER	deletion	UNP A0A7I9CFN1
F	?	-	SER	deletion	UNP A0A7I9CFN1
F	?	-	LEU	deletion	UNP A0A7I9CFN1
F	?	-	SER	deletion	UNP A0A7I9CFN1
F	?	-	MET	deletion	UNP A0A7I9CFN1
F	?	-	PRO	deletion	UNP A0A7I9CFN1
F	?	-	GLU	deletion	UNP A0A7I9CFN1
F	?	-	ILE	deletion	UNP A0A7I9CFN1
F	?	-	ASP	deletion	UNP A0A7I9CFN1
F	?	-	LYS	deletion	UNP A0A7I9CFN1
F	?	-	GLU	deletion	UNP A0A7I9CFN1
F	?	-	THR	deletion	UNP A0A7I9CFN1
F	?	-	MET	deletion	UNP A0A7I9CFN1
F	?	-	GLY	deletion	UNP A0A7I9CFN1
F	?	-	GLY	deletion	UNP A0A7I9CFN1
F	?	-	SER	deletion	UNP A0A7I9CFN1
G	?	-	SER	deletion	UNP A0A7I9CFN1
G	?	-	LEU	deletion	UNP A0A7I9CFN1

Continued on next page...

Continued from previous page...

Chain	Residue	Modelled	Actual	Comment	Reference
G	?	-	SER	deletion	UNP A0A7I9CFN1
G	?	-	MET	deletion	UNP A0A7I9CFN1
G	?	-	PRO	deletion	UNP A0A7I9CFN1
G	?	-	GLU	deletion	UNP A0A7I9CFN1
G	?	-	ILE	deletion	UNP A0A7I9CFN1
G	?	-	ASP	deletion	UNP A0A7I9CFN1
G	?	-	LYS	deletion	UNP A0A7I9CFN1
G	?	-	GLU	deletion	UNP A0A7I9CFN1
G	?	-	THR	deletion	UNP A0A7I9CFN1
G	?	-	MET	deletion	UNP A0A7I9CFN1
G	?	-	GLY	deletion	UNP A0A7I9CFN1
G	?	-	GLY	deletion	UNP A0A7I9CFN1
G	?	-	SER	deletion	UNP A0A7I9CFN1
W	?	-	SER	deletion	UNP A0A7I9CFN1
W	?	-	LEU	deletion	UNP A0A7I9CFN1
W	?	-	SER	deletion	UNP A0A7I9CFN1
W	?	-	MET	deletion	UNP A0A7I9CFN1
W	?	-	PRO	deletion	UNP A0A7I9CFN1
W	?	-	GLU	deletion	UNP A0A7I9CFN1
W	?	-	ILE	deletion	UNP A0A7I9CFN1
W	?	-	ASP	deletion	UNP A0A7I9CFN1
W	?	-	LYS	deletion	UNP A0A7I9CFN1
W	?	-	GLU	deletion	UNP A0A7I9CFN1
W	?	-	THR	deletion	UNP A0A7I9CFN1
W	?	-	MET	deletion	UNP A0A7I9CFN1
W	?	-	GLY	deletion	UNP A0A7I9CFN1
W	?	-	GLY	deletion	UNP A0A7I9CFN1
W	?	-	SER	deletion	UNP A0A7I9CFN1
K	?	-	SER	deletion	UNP A0A7I9CFN1
K	?	-	LEU	deletion	UNP A0A7I9CFN1
K	?	-	SER	deletion	UNP A0A7I9CFN1
K	?	-	MET	deletion	UNP A0A7I9CFN1
K	?	-	PRO	deletion	UNP A0A7I9CFN1
K	?	-	GLU	deletion	UNP A0A7I9CFN1
K	?	-	ILE	deletion	UNP A0A7I9CFN1
K	?	-	ASP	deletion	UNP A0A7I9CFN1
K	?	-	LYS	deletion	UNP A0A7I9CFN1
K	?	-	GLU	deletion	UNP A0A7I9CFN1
K	?	-	THR	deletion	UNP A0A7I9CFN1
K	?	-	MET	deletion	UNP A0A7I9CFN1
K	?	-	GLY	deletion	UNP A0A7I9CFN1
K	?	-	GLY	deletion	UNP A0A7I9CFN1

Continued on next page...

Continued from previous page...

Chain	Residue	Modelled	Actual	Comment	Reference
K	?	-	SER	deletion	UNP A0A7I9CFN1
O	?	-	SER	deletion	UNP A0A7I9CFN1
O	?	-	LEU	deletion	UNP A0A7I9CFN1
O	?	-	SER	deletion	UNP A0A7I9CFN1
O	?	-	MET	deletion	UNP A0A7I9CFN1
O	?	-	PRO	deletion	UNP A0A7I9CFN1
O	?	-	GLU	deletion	UNP A0A7I9CFN1
O	?	-	ILE	deletion	UNP A0A7I9CFN1
O	?	-	ASP	deletion	UNP A0A7I9CFN1
O	?	-	LYS	deletion	UNP A0A7I9CFN1
O	?	-	GLU	deletion	UNP A0A7I9CFN1
O	?	-	THR	deletion	UNP A0A7I9CFN1
O	?	-	MET	deletion	UNP A0A7I9CFN1
O	?	-	GLY	deletion	UNP A0A7I9CFN1
O	?	-	GLY	deletion	UNP A0A7I9CFN1
O	?	-	SER	deletion	UNP A0A7I9CFN1
S	?	-	SER	deletion	UNP A0A7I9CFN1
S	?	-	LEU	deletion	UNP A0A7I9CFN1
S	?	-	SER	deletion	UNP A0A7I9CFN1
S	?	-	MET	deletion	UNP A0A7I9CFN1
S	?	-	PRO	deletion	UNP A0A7I9CFN1
S	?	-	GLU	deletion	UNP A0A7I9CFN1
S	?	-	ILE	deletion	UNP A0A7I9CFN1
S	?	-	ASP	deletion	UNP A0A7I9CFN1
S	?	-	LYS	deletion	UNP A0A7I9CFN1
S	?	-	GLU	deletion	UNP A0A7I9CFN1
S	?	-	THR	deletion	UNP A0A7I9CFN1
S	?	-	MET	deletion	UNP A0A7I9CFN1
S	?	-	GLY	deletion	UNP A0A7I9CFN1
S	?	-	GLY	deletion	UNP A0A7I9CFN1
S	?	-	SER	deletion	UNP A0A7I9CFN1
b	?	-	SER	deletion	UNP A0A7I9CFN1
b	?	-	LEU	deletion	UNP A0A7I9CFN1
b	?	-	SER	deletion	UNP A0A7I9CFN1
b	?	-	MET	deletion	UNP A0A7I9CFN1
b	?	-	PRO	deletion	UNP A0A7I9CFN1
b	?	-	GLU	deletion	UNP A0A7I9CFN1
b	?	-	ILE	deletion	UNP A0A7I9CFN1
b	?	-	ASP	deletion	UNP A0A7I9CFN1
b	?	-	LYS	deletion	UNP A0A7I9CFN1
b	?	-	GLU	deletion	UNP A0A7I9CFN1
b	?	-	THR	deletion	UNP A0A7I9CFN1

Continued on next page...

Continued from previous page...

Chain	Residue	Modelled	Actual	Comment	Reference
b	?	-	MET	deletion	UNP A0A7I9CFN1
b	?	-	GLY	deletion	UNP A0A7I9CFN1
b	?	-	GLY	deletion	UNP A0A7I9CFN1
b	?	-	SER	deletion	UNP A0A7I9CFN1
Y	?	-	SER	deletion	UNP A0A7I9CFN1
Y	?	-	LEU	deletion	UNP A0A7I9CFN1
Y	?	-	SER	deletion	UNP A0A7I9CFN1
Y	?	-	MET	deletion	UNP A0A7I9CFN1
Y	?	-	PRO	deletion	UNP A0A7I9CFN1
Y	?	-	GLU	deletion	UNP A0A7I9CFN1
Y	?	-	ILE	deletion	UNP A0A7I9CFN1
Y	?	-	ASP	deletion	UNP A0A7I9CFN1
Y	?	-	LYS	deletion	UNP A0A7I9CFN1
Y	?	-	GLU	deletion	UNP A0A7I9CFN1
Y	?	-	THR	deletion	UNP A0A7I9CFN1
Y	?	-	MET	deletion	UNP A0A7I9CFN1
Y	?	-	GLY	deletion	UNP A0A7I9CFN1
Y	?	-	GLY	deletion	UNP A0A7I9CFN1
Y	?	-	SER	deletion	UNP A0A7I9CFN1
Z	?	-	SER	deletion	UNP A0A7I9CFN1
Z	?	-	LEU	deletion	UNP A0A7I9CFN1
Z	?	-	SER	deletion	UNP A0A7I9CFN1
Z	?	-	MET	deletion	UNP A0A7I9CFN1
Z	?	-	PRO	deletion	UNP A0A7I9CFN1
Z	?	-	GLU	deletion	UNP A0A7I9CFN1
Z	?	-	ILE	deletion	UNP A0A7I9CFN1
Z	?	-	ASP	deletion	UNP A0A7I9CFN1
Z	?	-	LYS	deletion	UNP A0A7I9CFN1
Z	?	-	GLU	deletion	UNP A0A7I9CFN1
Z	?	-	THR	deletion	UNP A0A7I9CFN1
Z	?	-	MET	deletion	UNP A0A7I9CFN1
Z	?	-	GLY	deletion	UNP A0A7I9CFN1
Z	?	-	GLY	deletion	UNP A0A7I9CFN1
Z	?	-	SER	deletion	UNP A0A7I9CFN1
a	?	-	SER	deletion	UNP A0A7I9CFN1
a	?	-	LEU	deletion	UNP A0A7I9CFN1
a	?	-	SER	deletion	UNP A0A7I9CFN1
a	?	-	MET	deletion	UNP A0A7I9CFN1
a	?	-	PRO	deletion	UNP A0A7I9CFN1
a	?	-	GLU	deletion	UNP A0A7I9CFN1
a	?	-	ILE	deletion	UNP A0A7I9CFN1
a	?	-	ASP	deletion	UNP A0A7I9CFN1

Continued on next page...

Continued from previous page...

Chain	Residue	Modelled	Actual	Comment	Reference
a	?	-	LYS	deletion	UNP A0A7I9CFN1
a	?	-	GLU	deletion	UNP A0A7I9CFN1
a	?	-	THR	deletion	UNP A0A7I9CFN1
a	?	-	MET	deletion	UNP A0A7I9CFN1
a	?	-	GLY	deletion	UNP A0A7I9CFN1
a	?	-	GLY	deletion	UNP A0A7I9CFN1
a	?	-	SER	deletion	UNP A0A7I9CFN1
X	?	-	SER	deletion	UNP A0A7I9CFN1
X	?	-	LEU	deletion	UNP A0A7I9CFN1
X	?	-	SER	deletion	UNP A0A7I9CFN1
X	?	-	MET	deletion	UNP A0A7I9CFN1
X	?	-	PRO	deletion	UNP A0A7I9CFN1
X	?	-	GLU	deletion	UNP A0A7I9CFN1
X	?	-	ILE	deletion	UNP A0A7I9CFN1
X	?	-	ASP	deletion	UNP A0A7I9CFN1
X	?	-	LYS	deletion	UNP A0A7I9CFN1
X	?	-	GLU	deletion	UNP A0A7I9CFN1
X	?	-	THR	deletion	UNP A0A7I9CFN1
X	?	-	MET	deletion	UNP A0A7I9CFN1
X	?	-	GLY	deletion	UNP A0A7I9CFN1
X	?	-	GLY	deletion	UNP A0A7I9CFN1
X	?	-	SER	deletion	UNP A0A7I9CFN1
L	?	-	SER	deletion	UNP A0A7I9CFN1
L	?	-	LEU	deletion	UNP A0A7I9CFN1
L	?	-	SER	deletion	UNP A0A7I9CFN1
L	?	-	MET	deletion	UNP A0A7I9CFN1
L	?	-	PRO	deletion	UNP A0A7I9CFN1
L	?	-	GLU	deletion	UNP A0A7I9CFN1
L	?	-	ILE	deletion	UNP A0A7I9CFN1
L	?	-	ASP	deletion	UNP A0A7I9CFN1
L	?	-	LYS	deletion	UNP A0A7I9CFN1
L	?	-	GLU	deletion	UNP A0A7I9CFN1
L	?	-	THR	deletion	UNP A0A7I9CFN1
L	?	-	MET	deletion	UNP A0A7I9CFN1
L	?	-	GLY	deletion	UNP A0A7I9CFN1
L	?	-	GLY	deletion	UNP A0A7I9CFN1
L	?	-	SER	deletion	UNP A0A7I9CFN1
P	?	-	SER	deletion	UNP A0A7I9CFN1
P	?	-	LEU	deletion	UNP A0A7I9CFN1
P	?	-	SER	deletion	UNP A0A7I9CFN1
P	?	-	MET	deletion	UNP A0A7I9CFN1
P	?	-	PRO	deletion	UNP A0A7I9CFN1

Continued on next page...

Continued from previous page...

Chain	Residue	Modelled	Actual	Comment	Reference
P	?	-	GLU	deletion	UNP A0A7I9CFN1
P	?	-	ILE	deletion	UNP A0A7I9CFN1
P	?	-	ASP	deletion	UNP A0A7I9CFN1
P	?	-	LYS	deletion	UNP A0A7I9CFN1
P	?	-	GLU	deletion	UNP A0A7I9CFN1
P	?	-	THR	deletion	UNP A0A7I9CFN1
P	?	-	MET	deletion	UNP A0A7I9CFN1
P	?	-	GLY	deletion	UNP A0A7I9CFN1
P	?	-	GLY	deletion	UNP A0A7I9CFN1
P	?	-	SER	deletion	UNP A0A7I9CFN1
T	?	-	SER	deletion	UNP A0A7I9CFN1
T	?	-	LEU	deletion	UNP A0A7I9CFN1
T	?	-	SER	deletion	UNP A0A7I9CFN1
T	?	-	MET	deletion	UNP A0A7I9CFN1
T	?	-	PRO	deletion	UNP A0A7I9CFN1
T	?	-	GLU	deletion	UNP A0A7I9CFN1
T	?	-	ILE	deletion	UNP A0A7I9CFN1
T	?	-	ASP	deletion	UNP A0A7I9CFN1
T	?	-	LYS	deletion	UNP A0A7I9CFN1
T	?	-	GLU	deletion	UNP A0A7I9CFN1
T	?	-	THR	deletion	UNP A0A7I9CFN1
T	?	-	MET	deletion	UNP A0A7I9CFN1
T	?	-	GLY	deletion	UNP A0A7I9CFN1
T	?	-	GLY	deletion	UNP A0A7I9CFN1
T	?	-	SER	deletion	UNP A0A7I9CFN1

- Molecule 2 is CYTIDINE-5'-TRIPHOSPHATE (three-letter code: CTP) (formula: $C_9H_{16}N_3O_{14}P_3$).

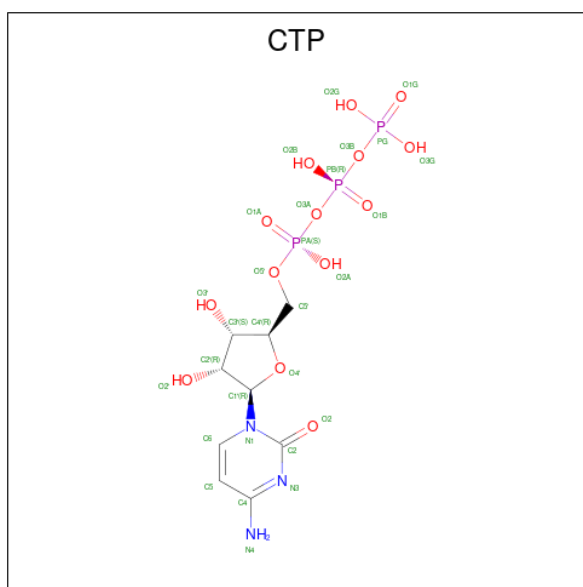

Mol	Chain	Residues	Atoms					AltConf
			Total	C	N	O	P	
2	D	1	Total	C	N	O	P	0
			29	9	3	14	3	
2	D	1	Total	C	N	O	P	0
			29	9	3	14	3	
2	A	1	Total	C	N	O	P	0
			29	9	3	14	3	
2	A	1	Total	C	N	O	P	0
			29	9	3	14	3	
2	B	1	Total	C	N	O	P	0
			29	9	3	14	3	
2	B	1	Total	C	N	O	P	0
			29	9	3	14	3	
2	C	1	Total	C	N	O	P	0
			29	9	3	14	3	
2	C	1	Total	C	N	O	P	0
			29	9	3	14	3	
2	U	1	Total	C	N	O	P	0
			29	9	3	14	3	
2	U	1	Total	C	N	O	P	0
			29	9	3	14	3	
2	I	1	Total	C	N	O	P	0
			29	9	3	14	3	
2	I	1	Total	C	N	O	P	0
			29	9	3	14	3	
2	M	1	Total	C	N	O	P	0
			29	9	3	14	3	
2	M	1	Total	C	N	O	P	0
			29	9	3	14	3	

Continued on next page...

Continued from previous page...

Mol	Chain	Residues	Atoms					AltConf
			Total	C	N	O	P	
2	Q	1	29	9	3	14	3	0
2	Q	1	29	9	3	14	3	0
2	V	1	29	9	3	14	3	0
2	V	1	29	9	3	14	3	0
2	J	1	29	9	3	14	3	0
2	J	1	29	9	3	14	3	0
2	N	1	29	9	3	14	3	0
2	N	1	29	9	3	14	3	0
2	R	1	29	9	3	14	3	0
2	R	1	29	9	3	14	3	0
2	H	1	29	9	3	14	3	0
2	H	1	29	9	3	14	3	0
2	E	1	29	9	3	14	3	0
2	E	1	29	9	3	14	3	0
2	F	1	29	9	3	14	3	0
2	F	1	29	9	3	14	3	0
2	G	1	29	9	3	14	3	0
2	G	1	29	9	3	14	3	0
2	W	1	29	9	3	14	3	0
2	W	1	29	9	3	14	3	0
2	K	1	29	9	3	14	3	0

Continued on next page...

Continued from previous page...

Mol	Chain	Residues	Atoms					AltConf
			Total	C	N	O	P	
2	K	1	29	9	3	14	3	0
2	O	1	29	9	3	14	3	0
2	O	1	29	9	3	14	3	0
2	S	1	29	9	3	14	3	0
2	S	1	29	9	3	14	3	0
2	b	1	29	9	3	14	3	0
2	b	1	29	9	3	14	3	0
2	Y	1	29	9	3	14	3	0
2	Y	1	29	9	3	14	3	0
2	Z	1	29	9	3	14	3	0
2	Z	1	29	9	3	14	3	0
2	a	1	29	9	3	14	3	0
2	a	1	29	9	3	14	3	0
2	X	1	29	9	3	14	3	0
2	X	1	29	9	3	14	3	0
2	L	1	29	9	3	14	3	0
2	L	1	29	9	3	14	3	0
2	P	1	29	9	3	14	3	0
2	P	1	29	9	3	14	3	0
2	T	1	29	9	3	14	3	0
2	T	1	29	9	3	14	3	0

3 Residue-property plots

These plots are drawn for all protein, RNA, DNA and oligosaccharide chains in the entry. The first graphic for a chain summarises the proportions of the various outlier classes displayed in the second graphic. The second graphic shows the sequence view annotated by issues in geometry and atom inclusion in map density. Residues are color-coded according to the number of geometric quality criteria for which they contain at least one outlier: green = 0, yellow = 1, orange = 2 and red = 3 or more. A red diamond above a residue indicates a poor fit to the EM map for this residue (all-atom inclusion < 40%). Stretches of 2 or more consecutive residues without any outlier are shown as a green connector. Residues present in the sample, but not in the model, are shown in grey.

- Molecule 1: CTP synthase

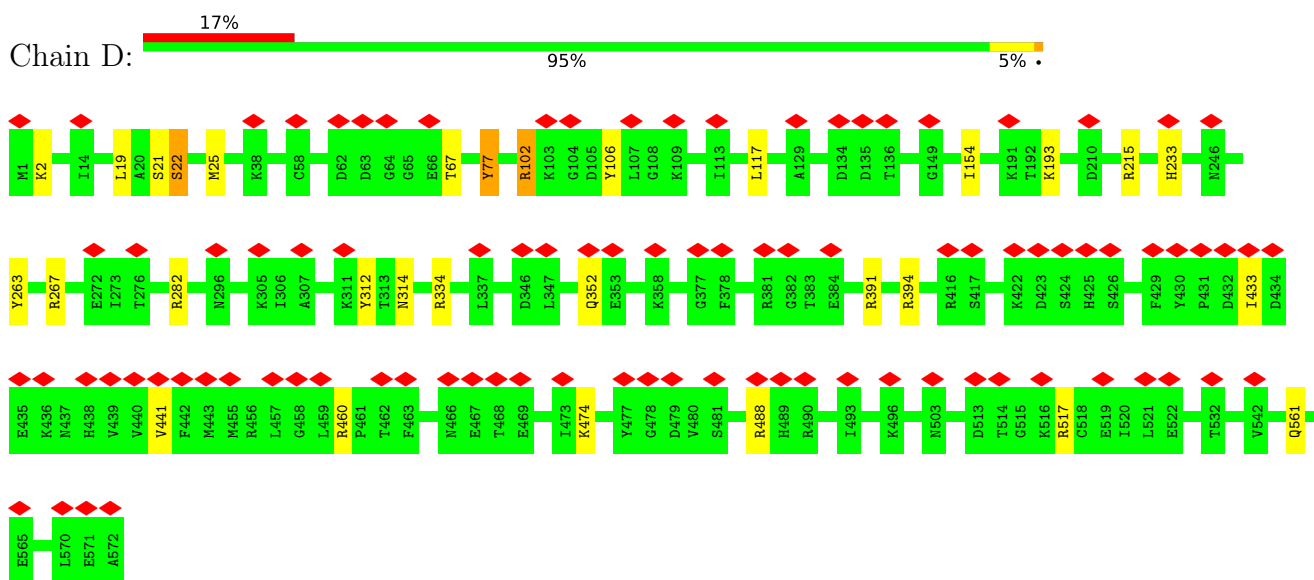

- Molecule 1: CTP synthase

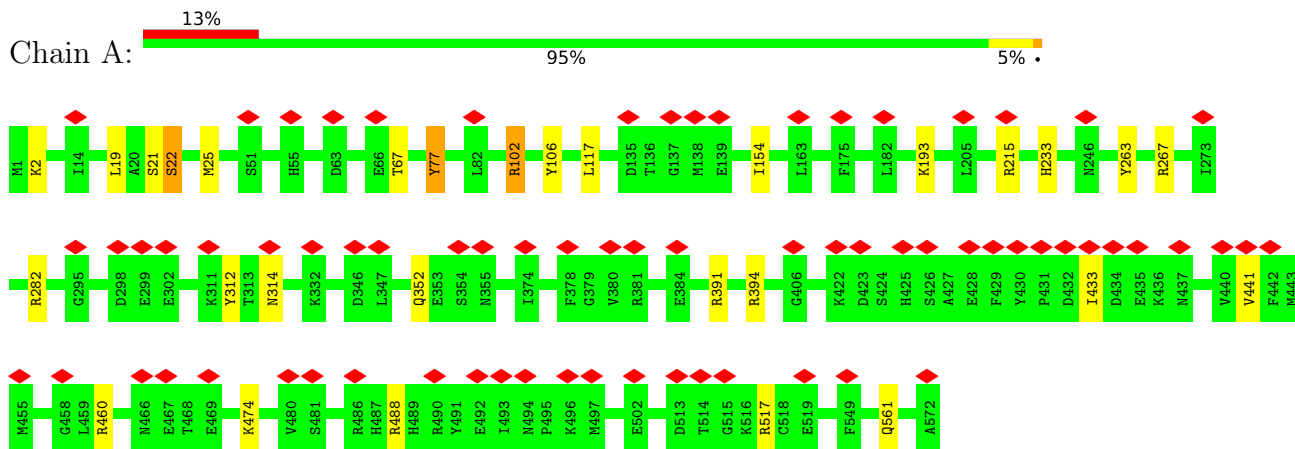

- Molecule 1: CTP synthase

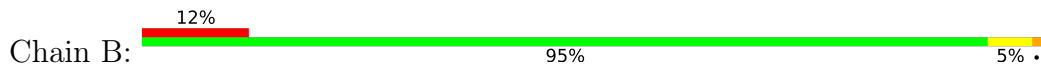

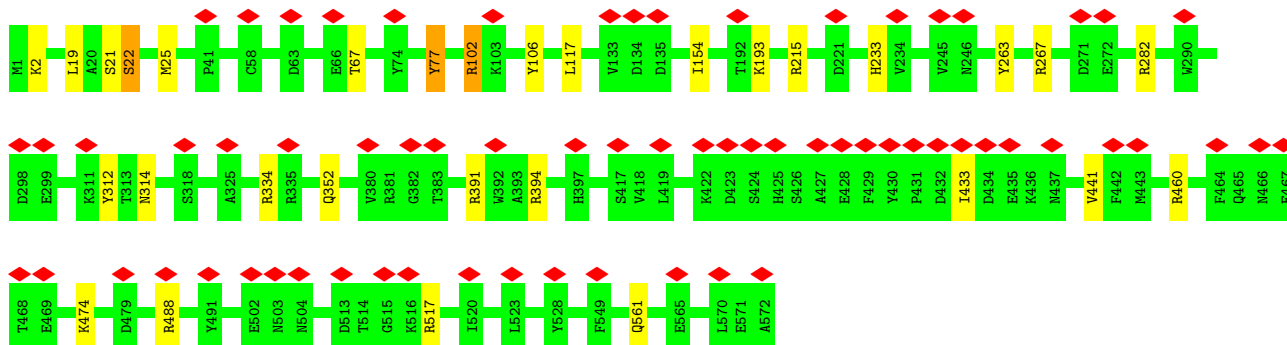

• Molecule 1: CTP synthase

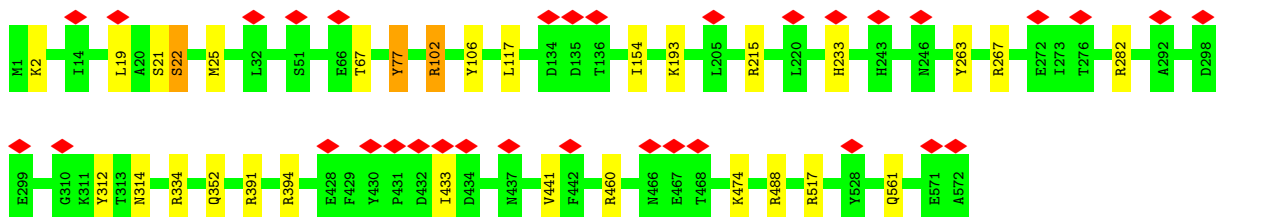

• Molecule 1: CTP synthase

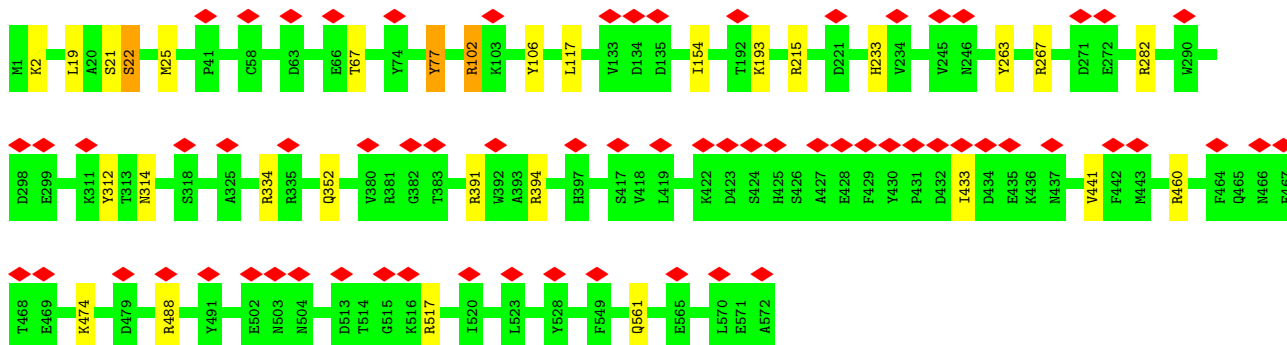

• Molecule 1: CTP synthase

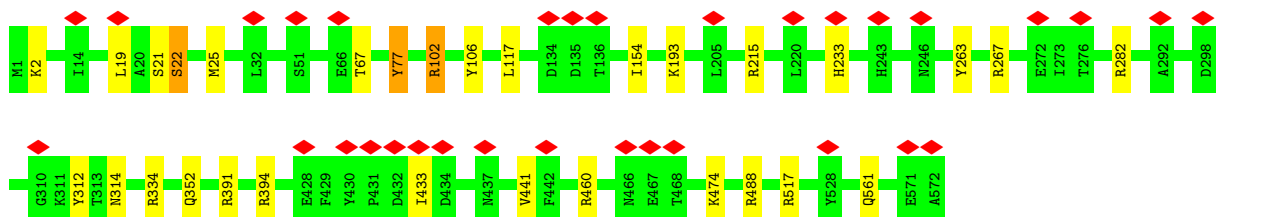

• Molecule 1: CTP synthase

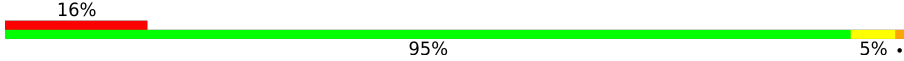
Chain M: 

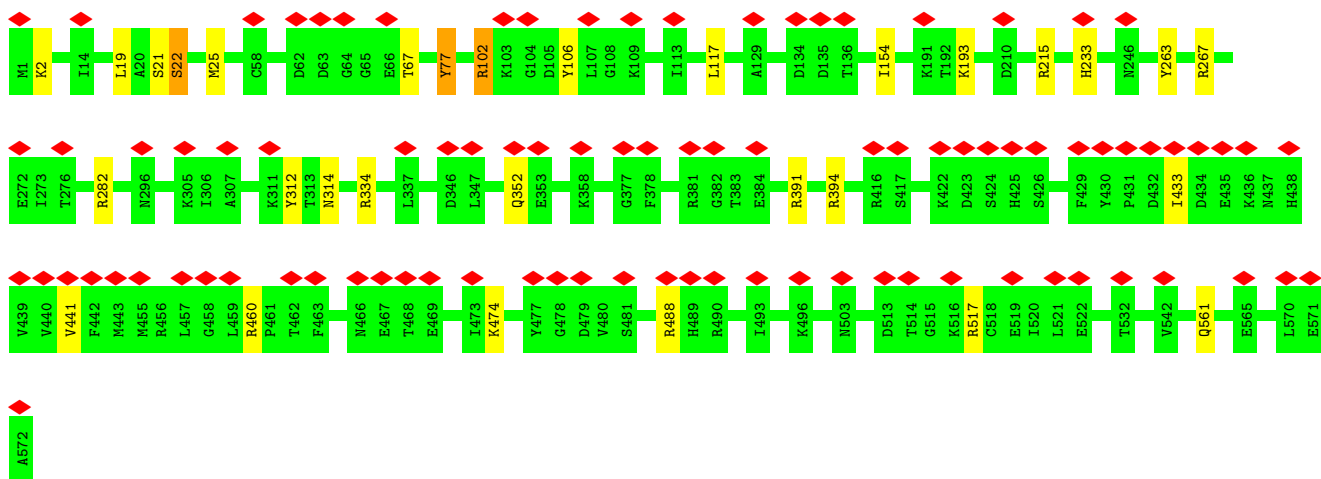

• Molecule 1: CTP synthase

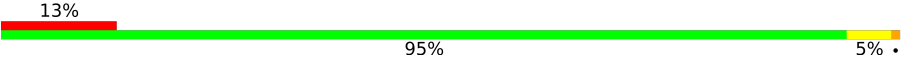
Chain Q: 

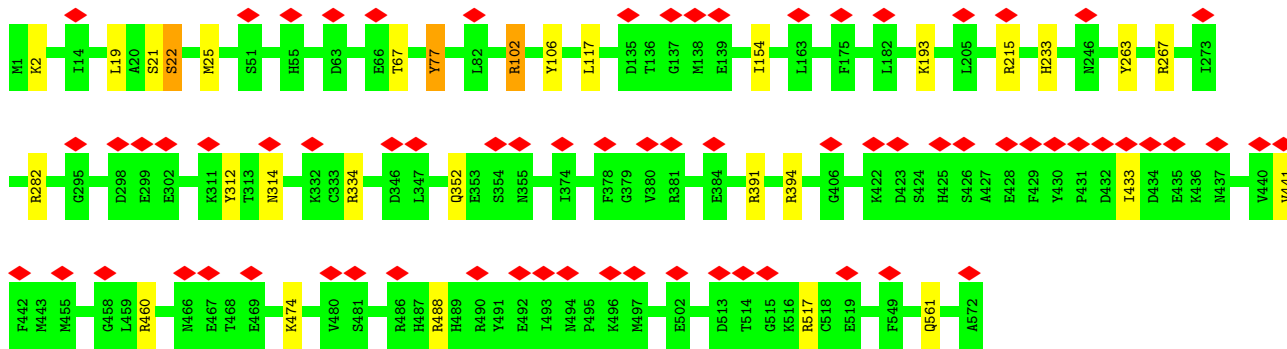

• Molecule 1: CTP synthase

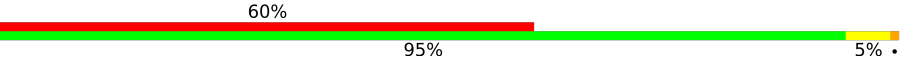
Chain V: 

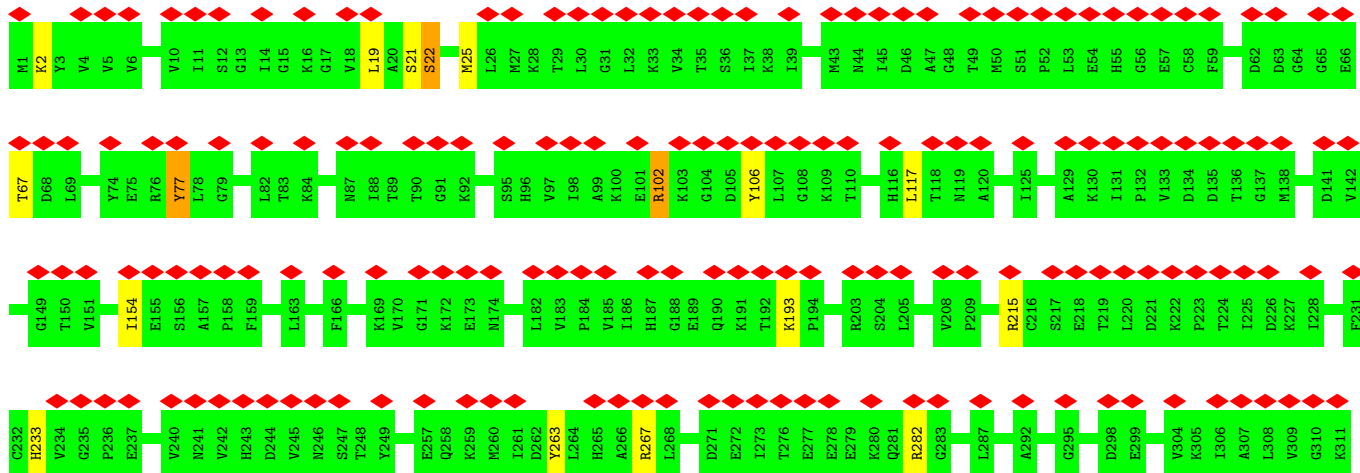

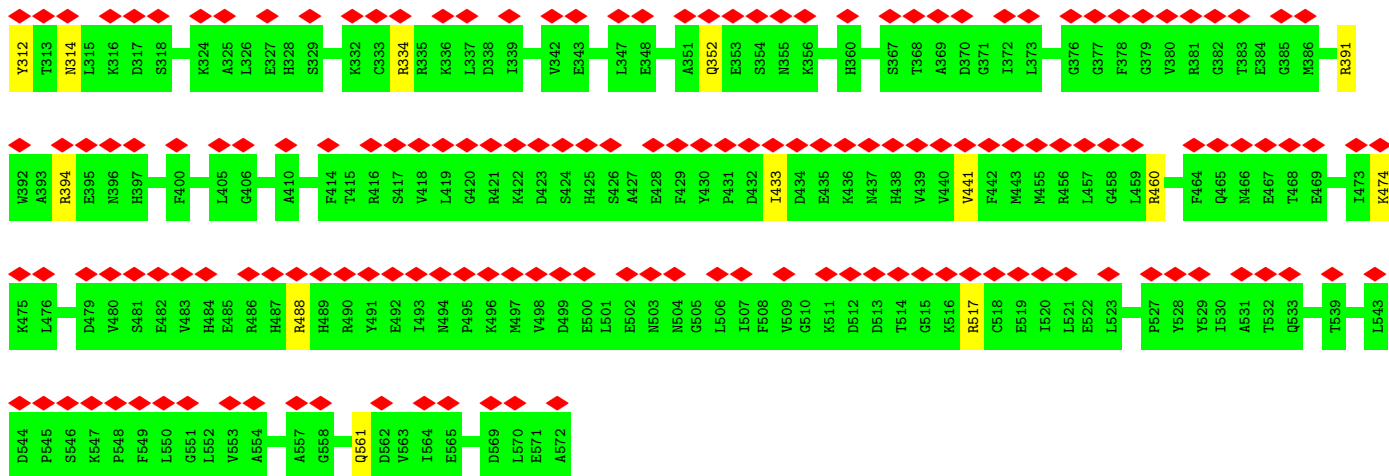

• Molecule 1: CTP synthase

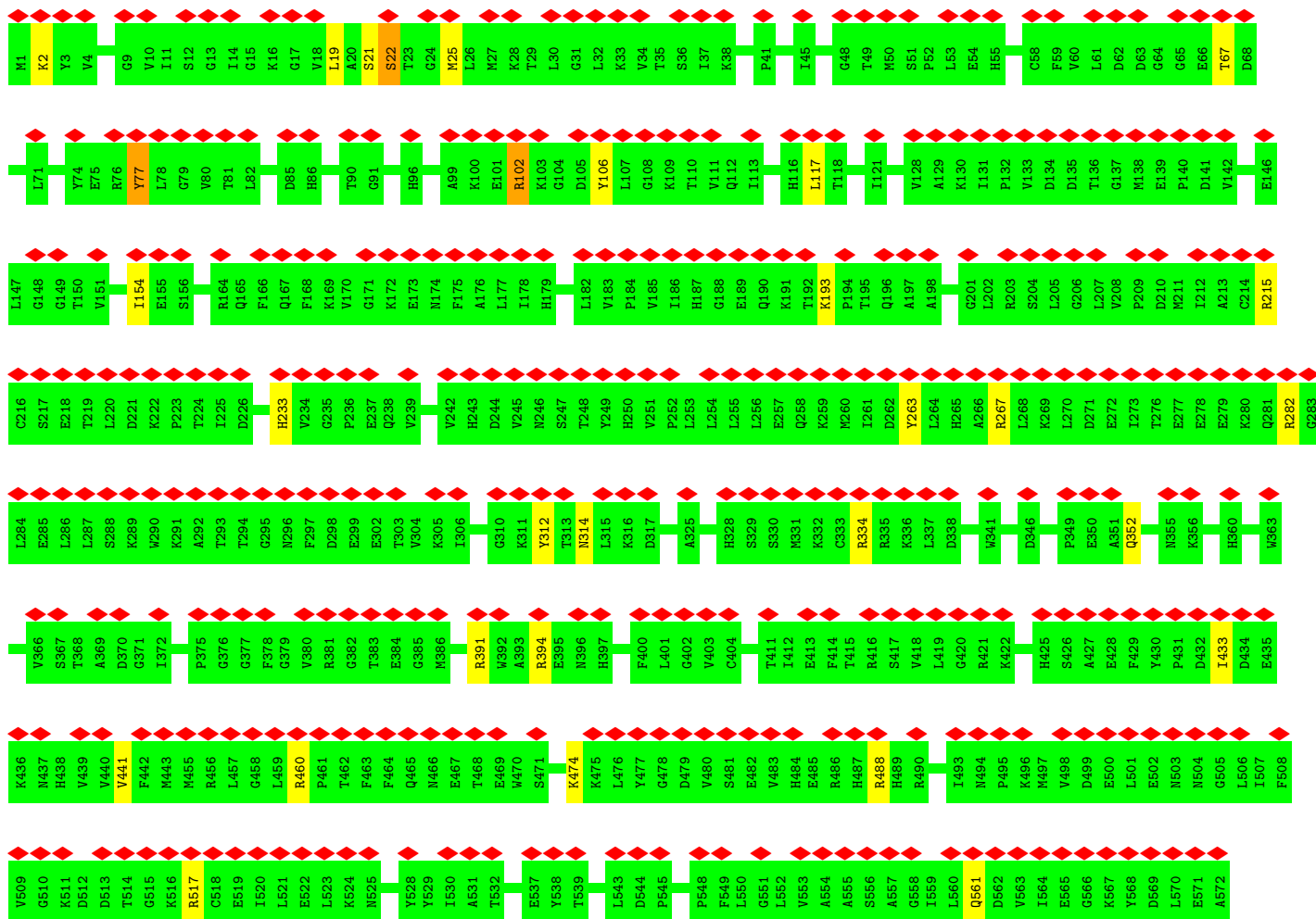
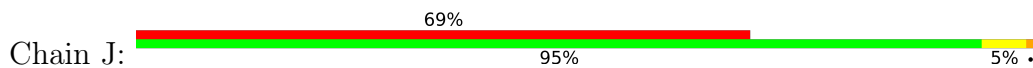

• Molecule 1: CTP synthase

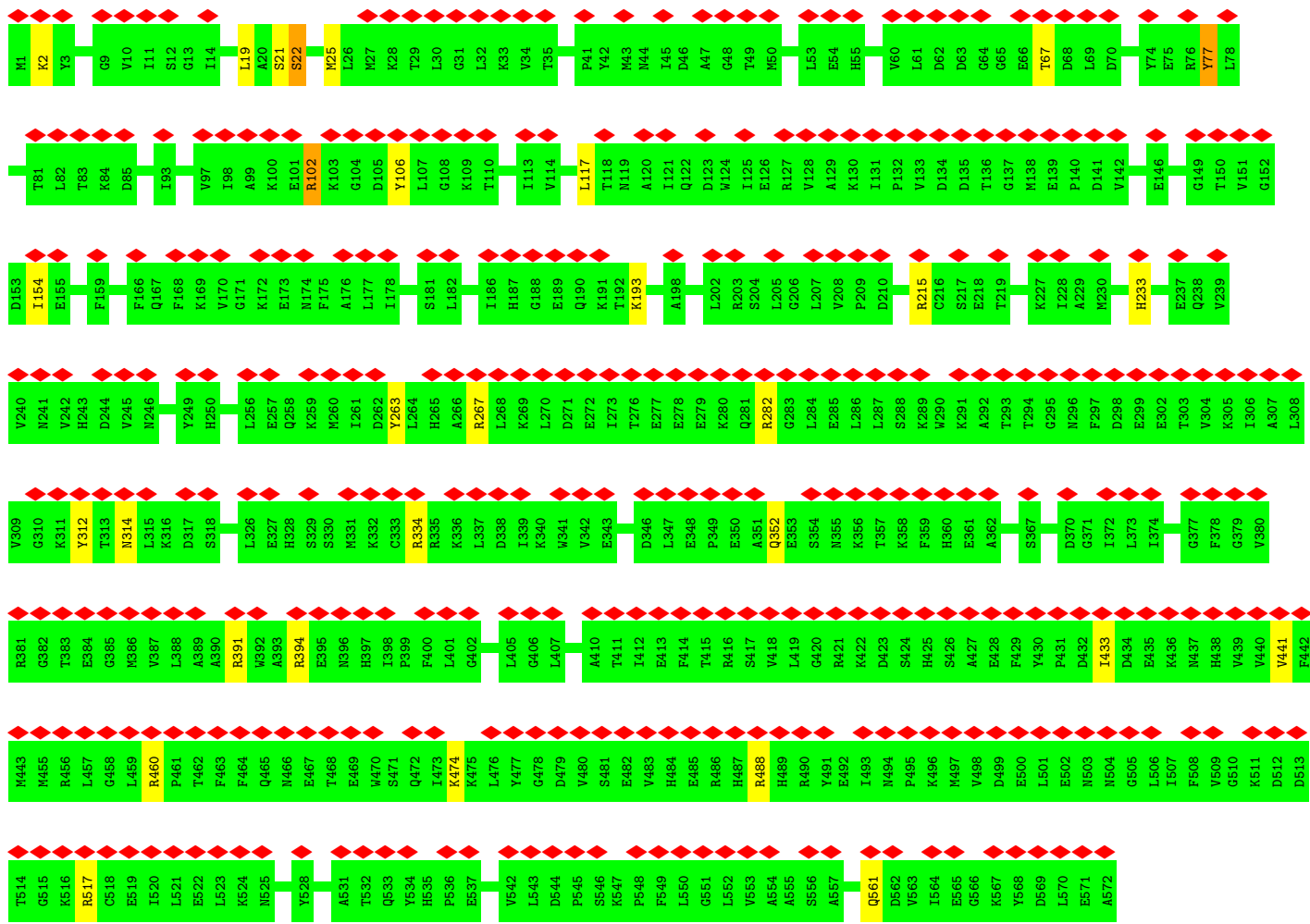
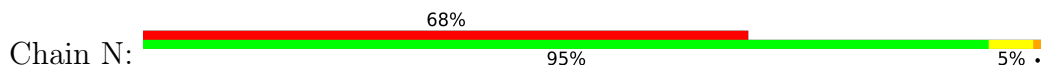

• Molecule 1: CTP synthase

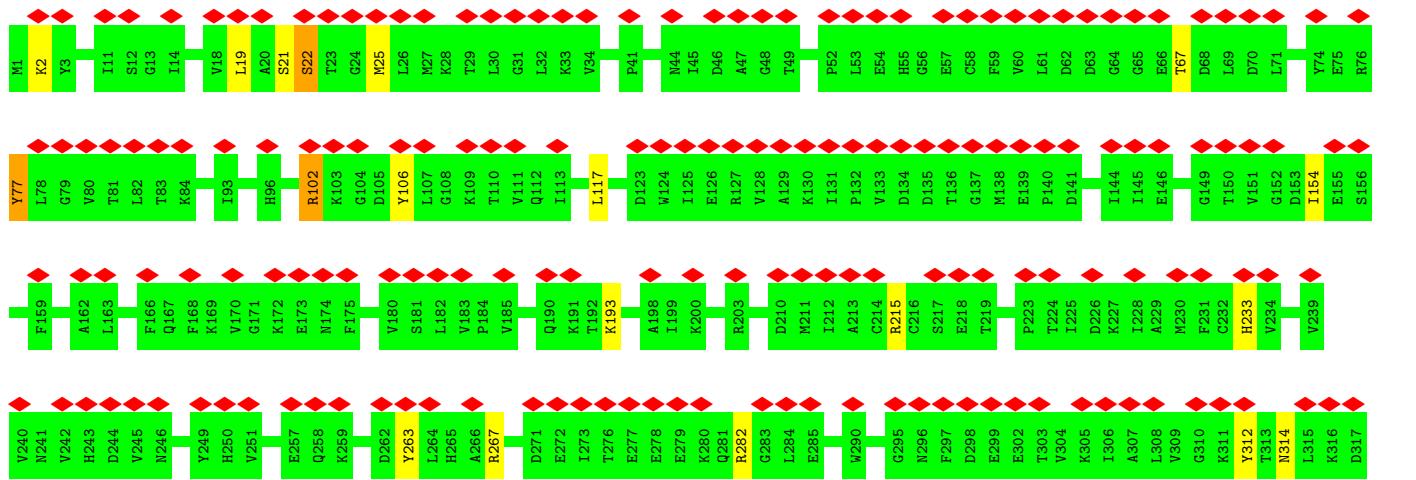
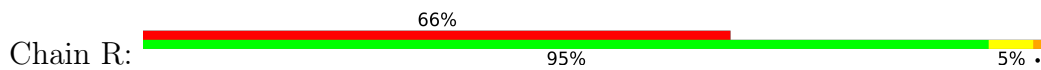

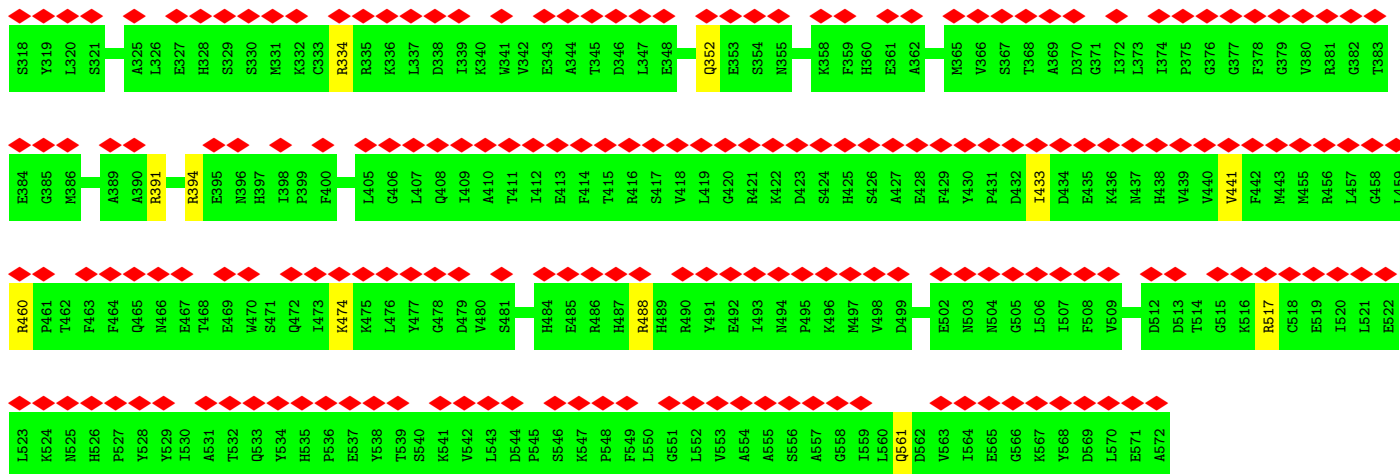

• Molecule 1: CTP synthase

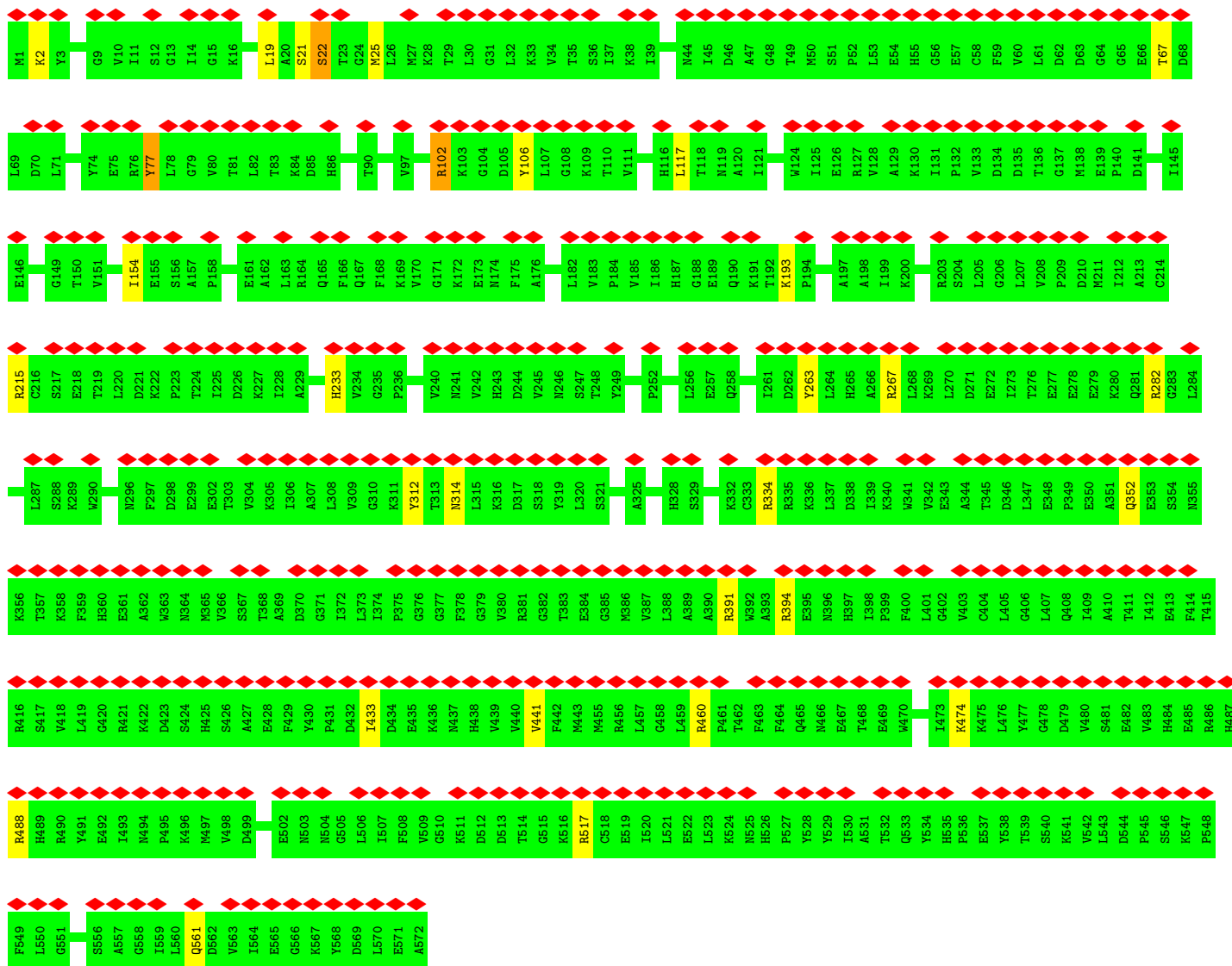
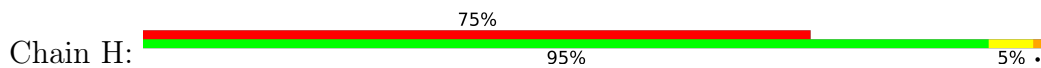

• Molecule 1: CTP synthase

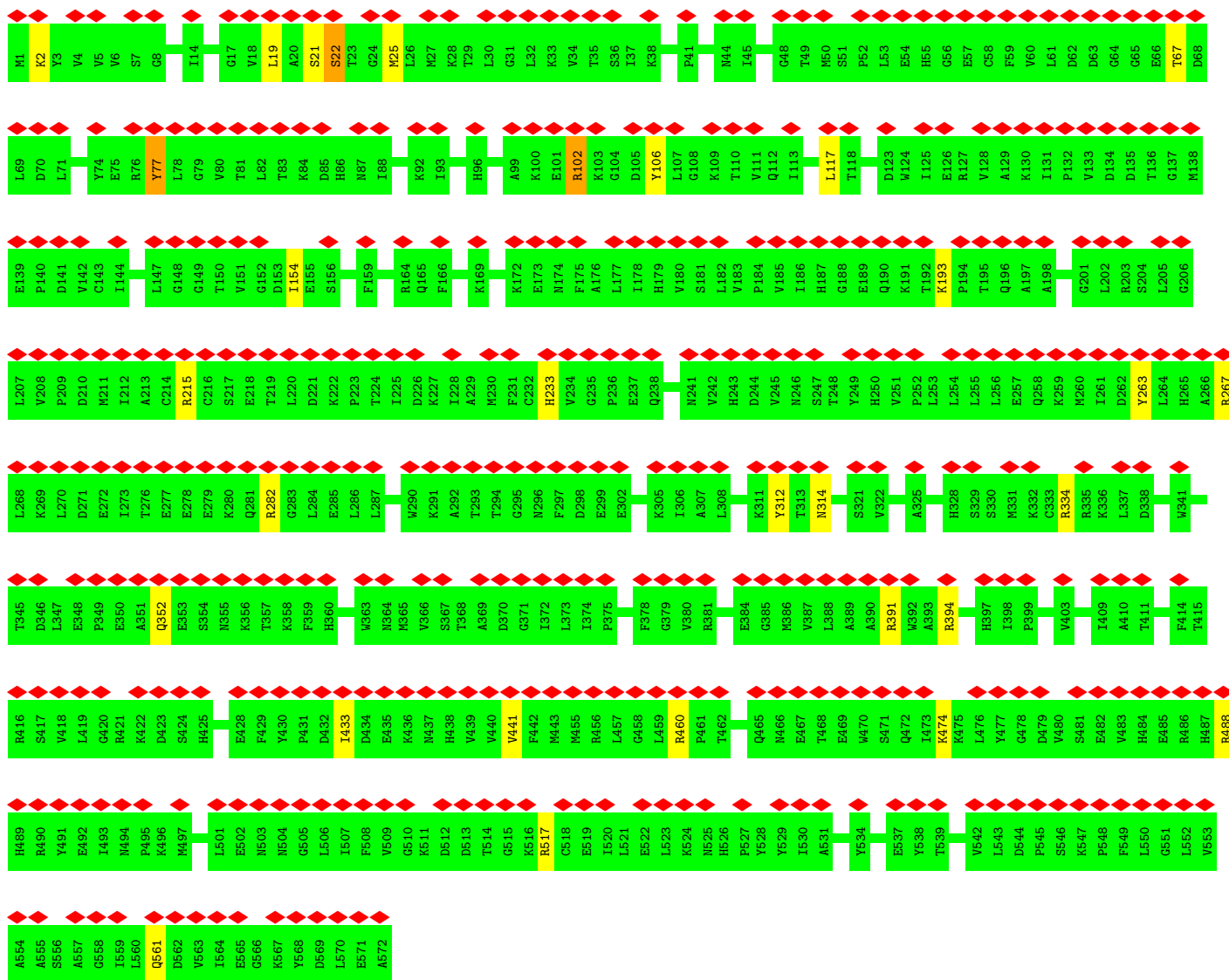
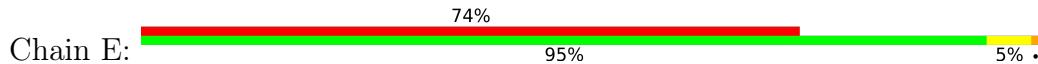

• Molecule 1: CTP synthase

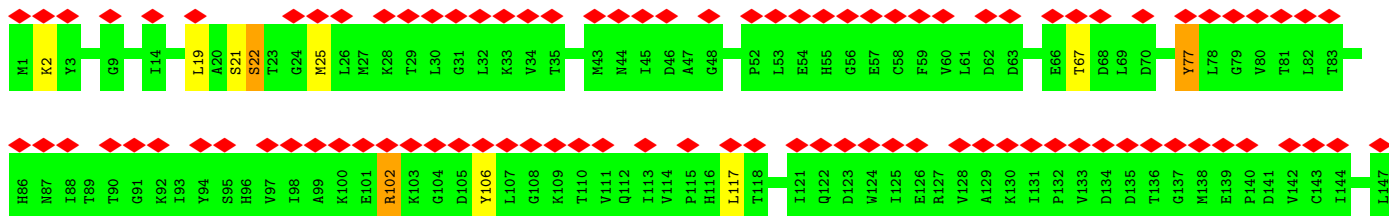
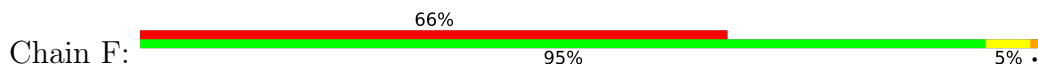

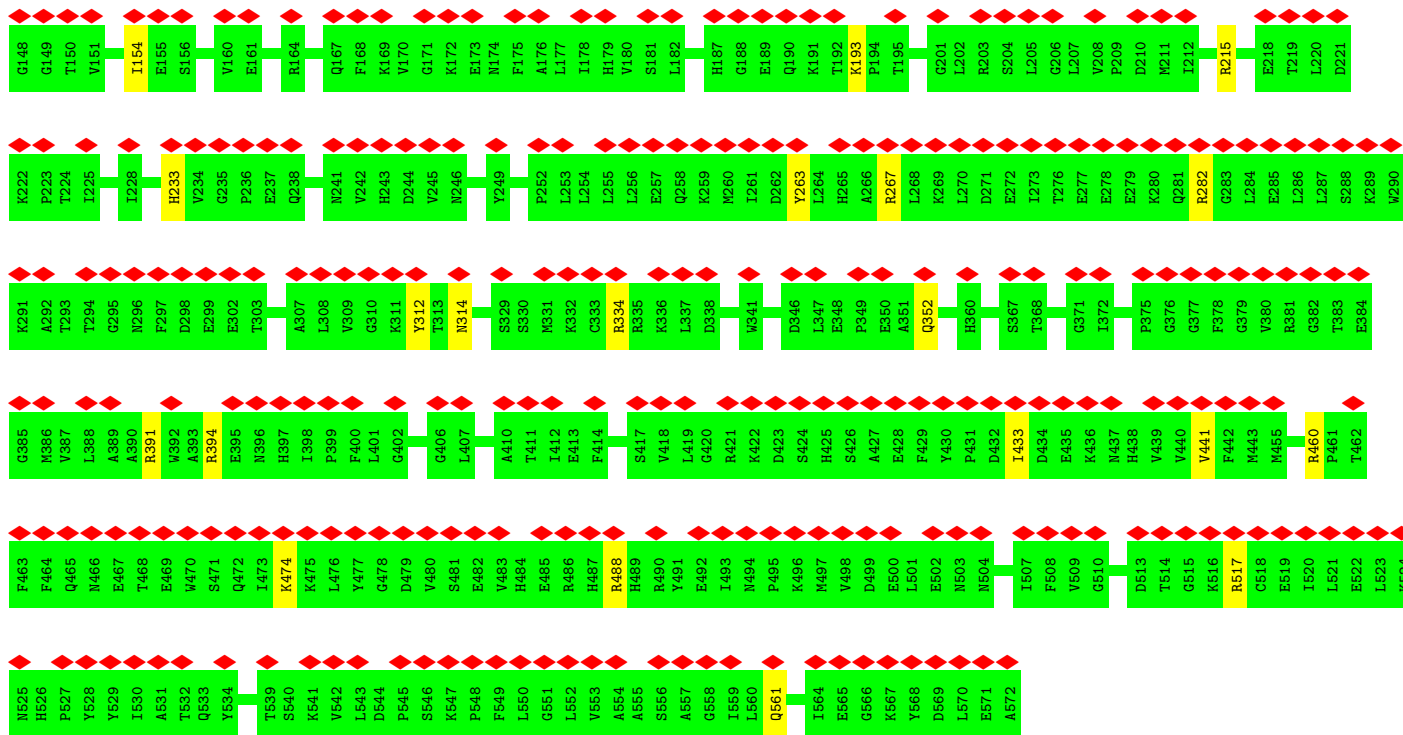

• Molecule 1: CTP synthase

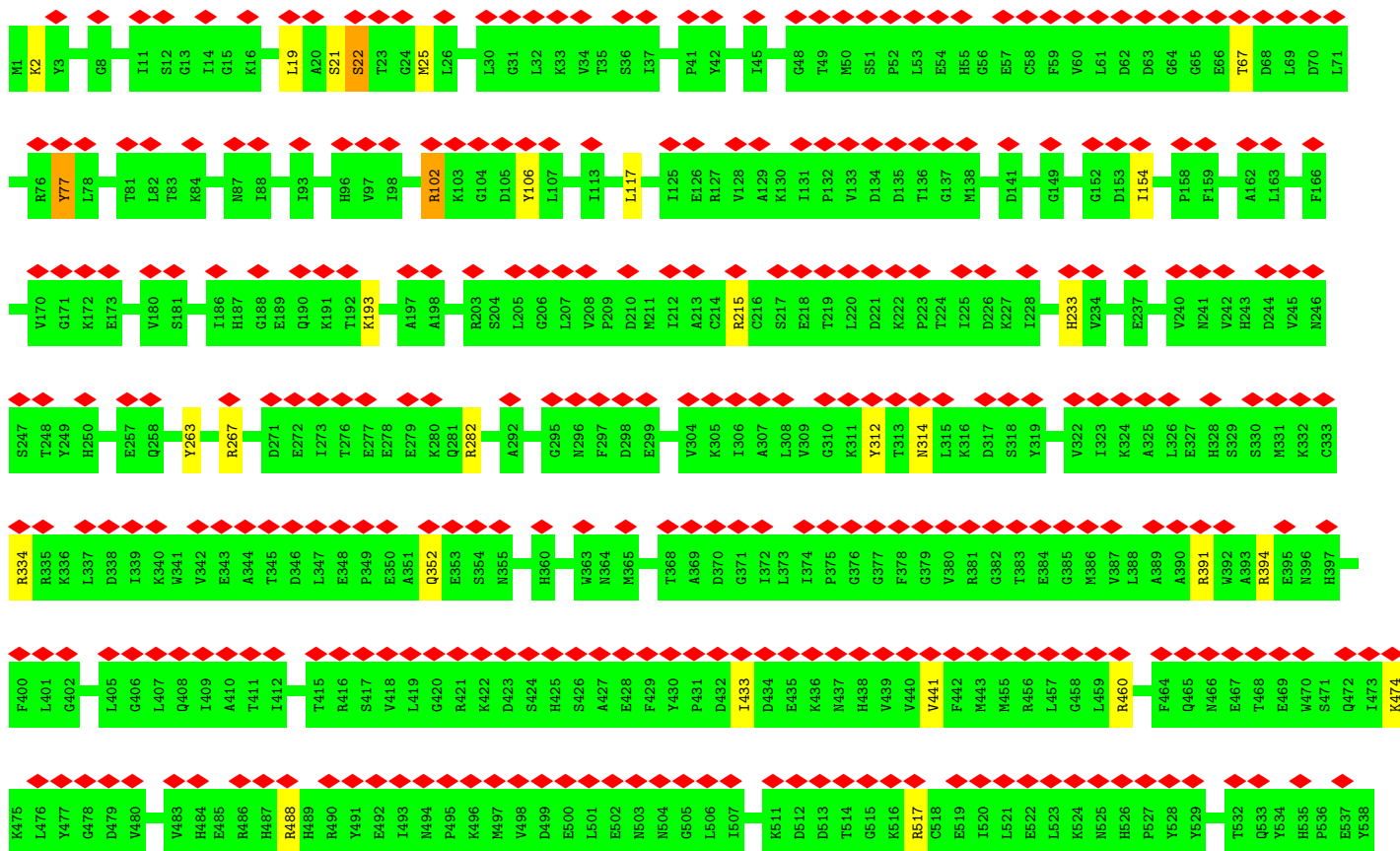
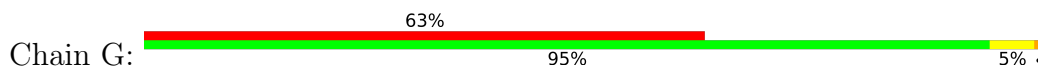

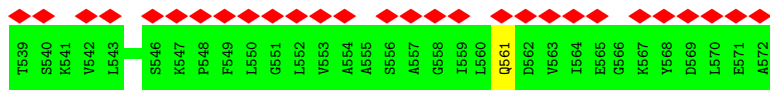

• Molecule 1: CTP synthase

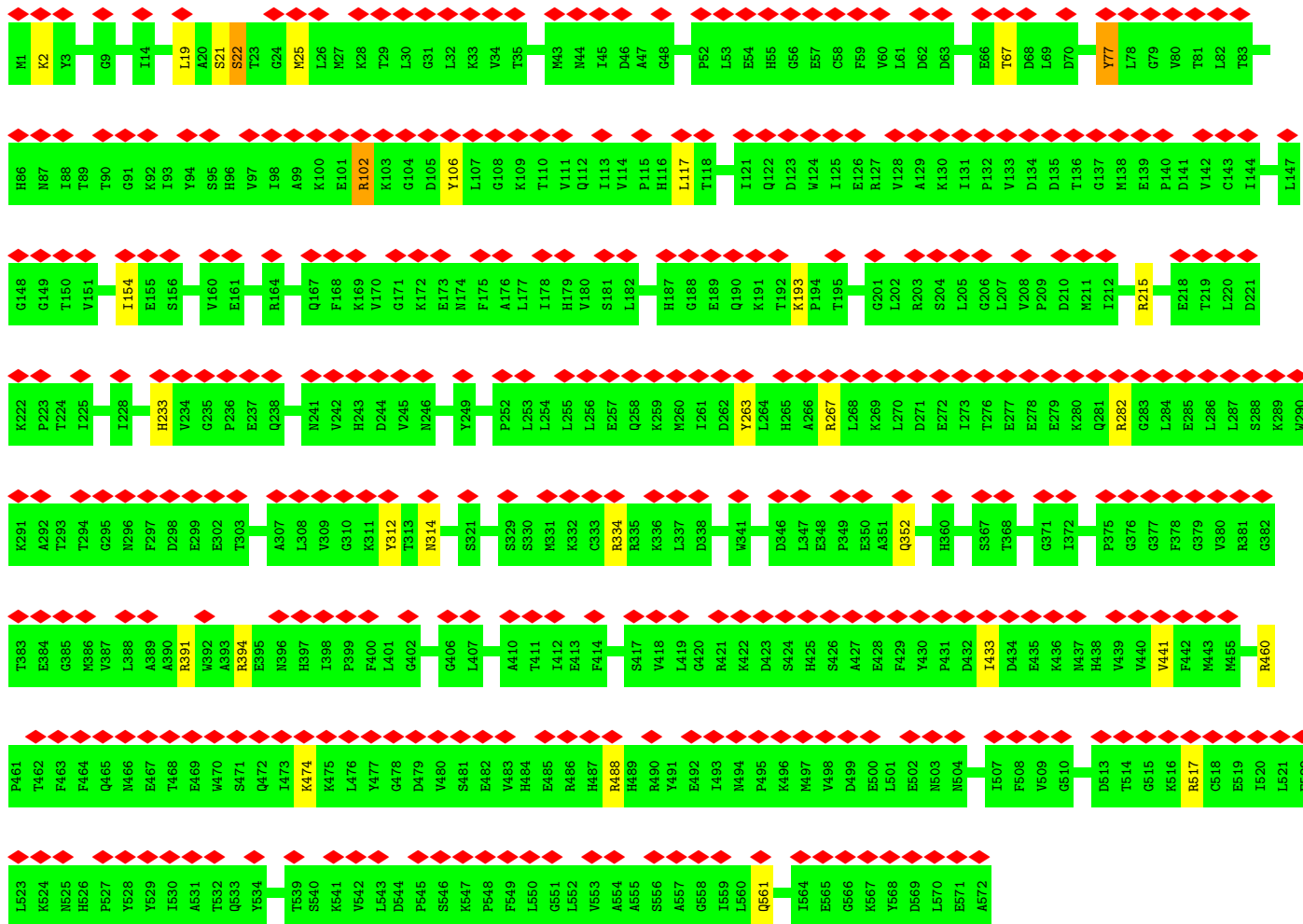
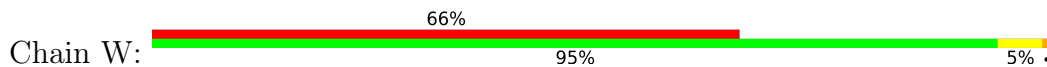

• Molecule 1: CTP synthase

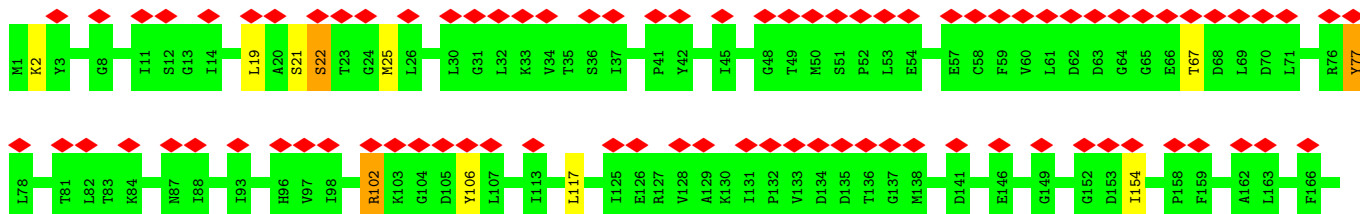
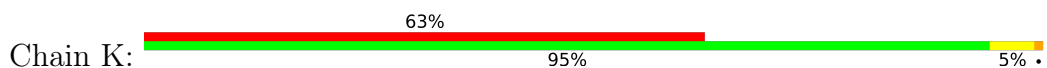

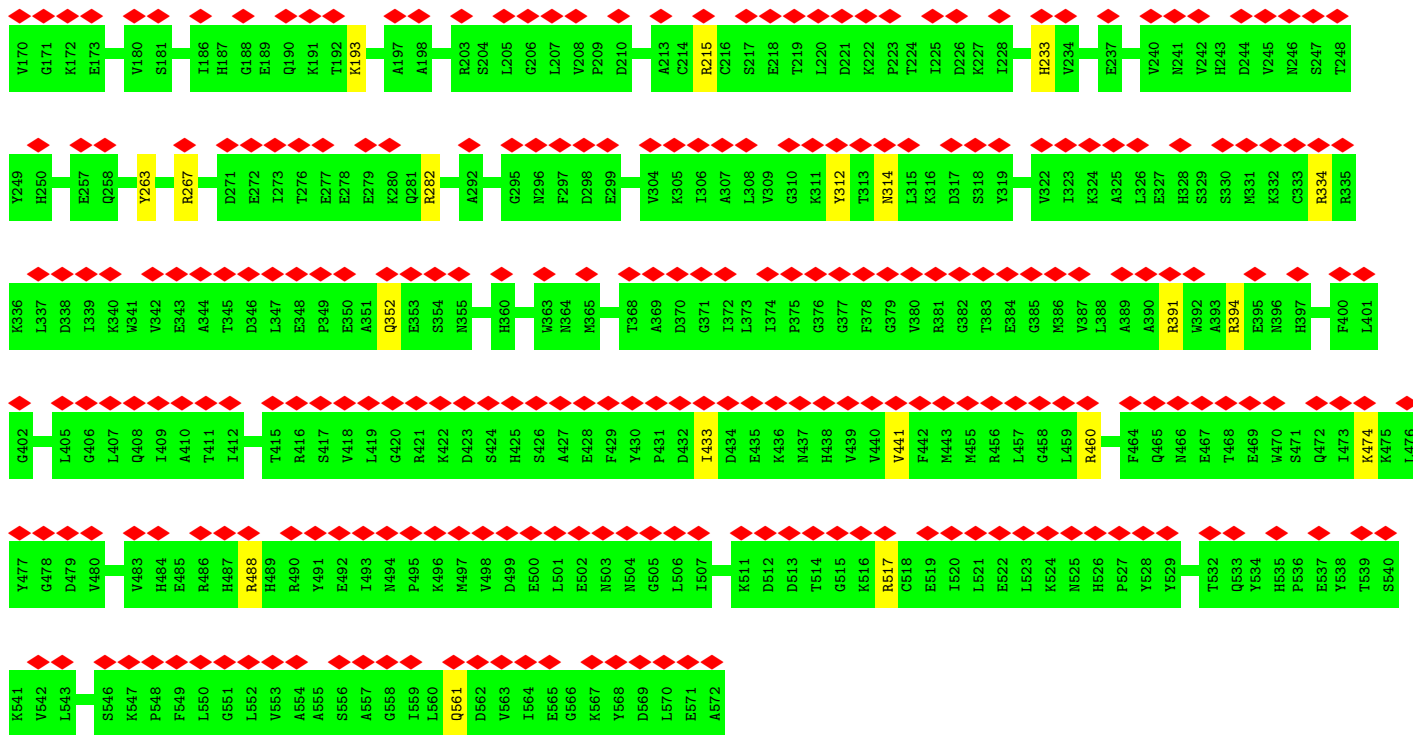

• Molecule 1: CTP synthase

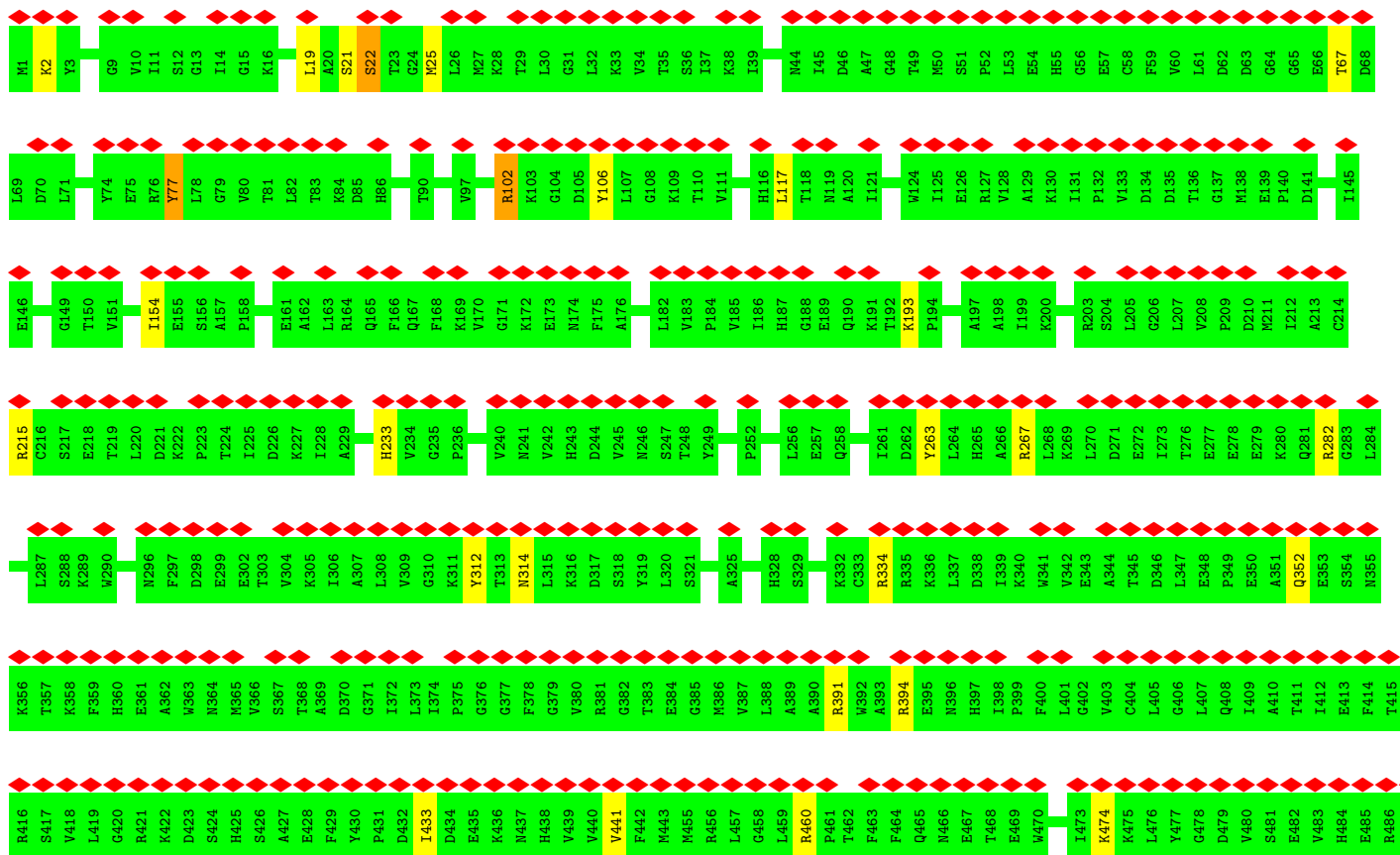
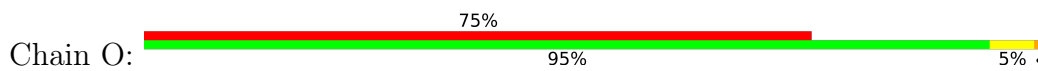

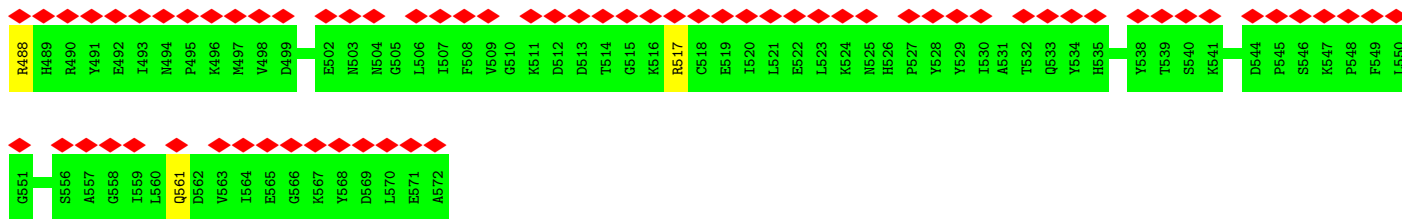

• Molecule 1: CTP synthase

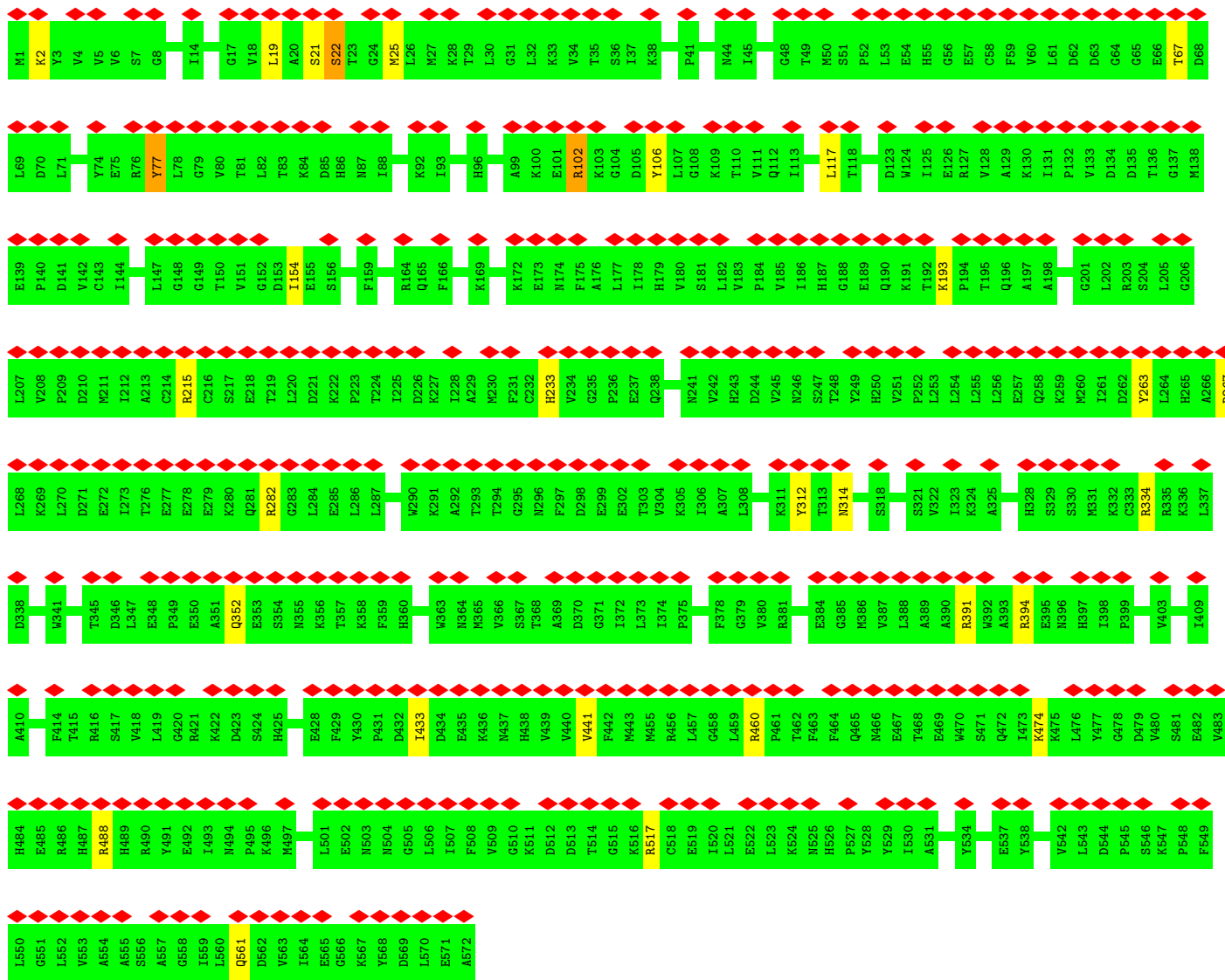
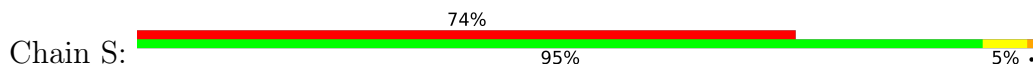

• Molecule 1: CTP synthase

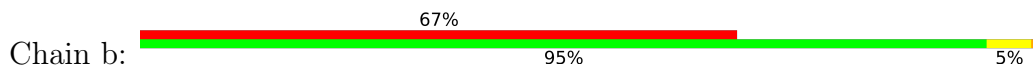

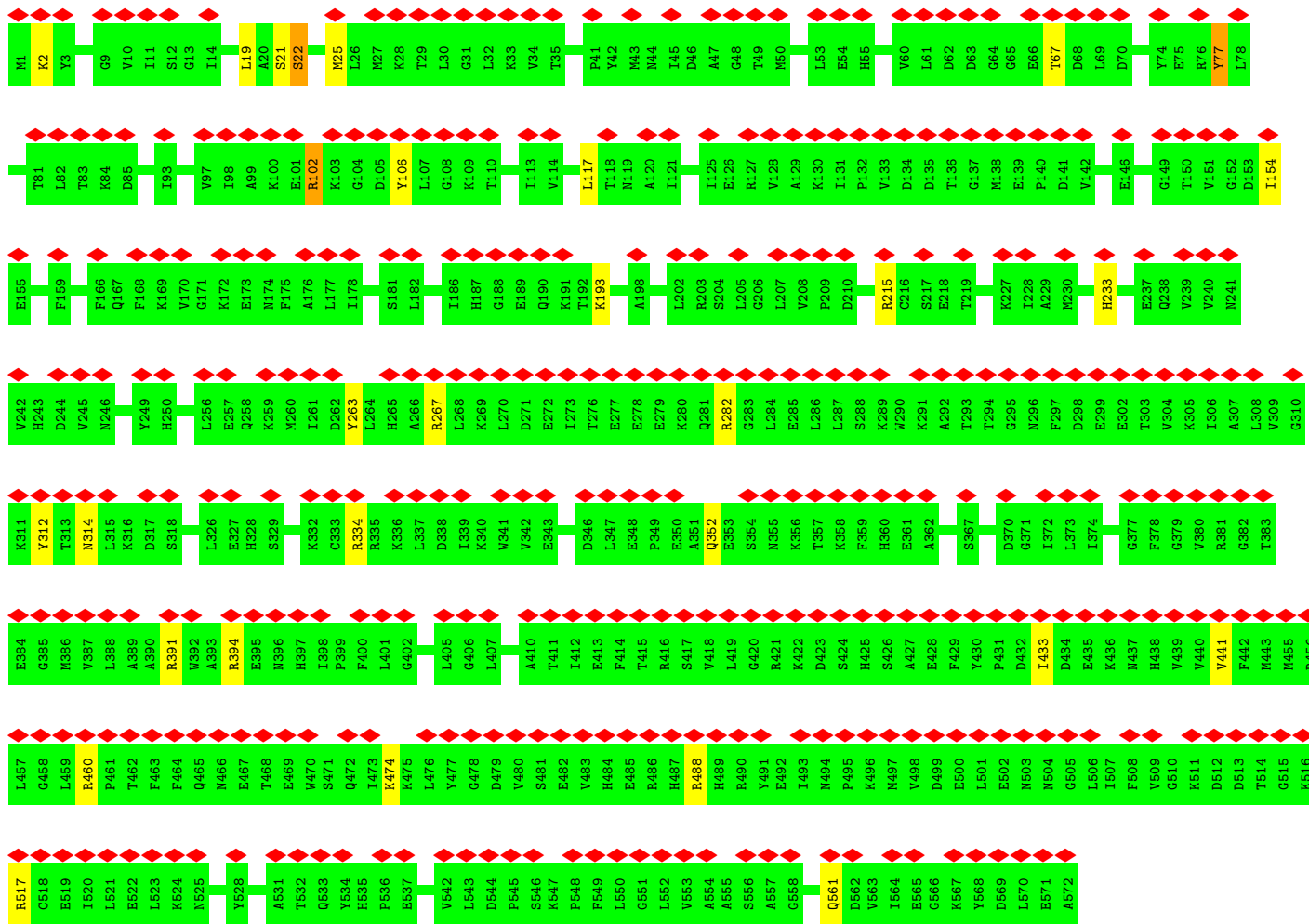

● Molecule 1: CTP synthase

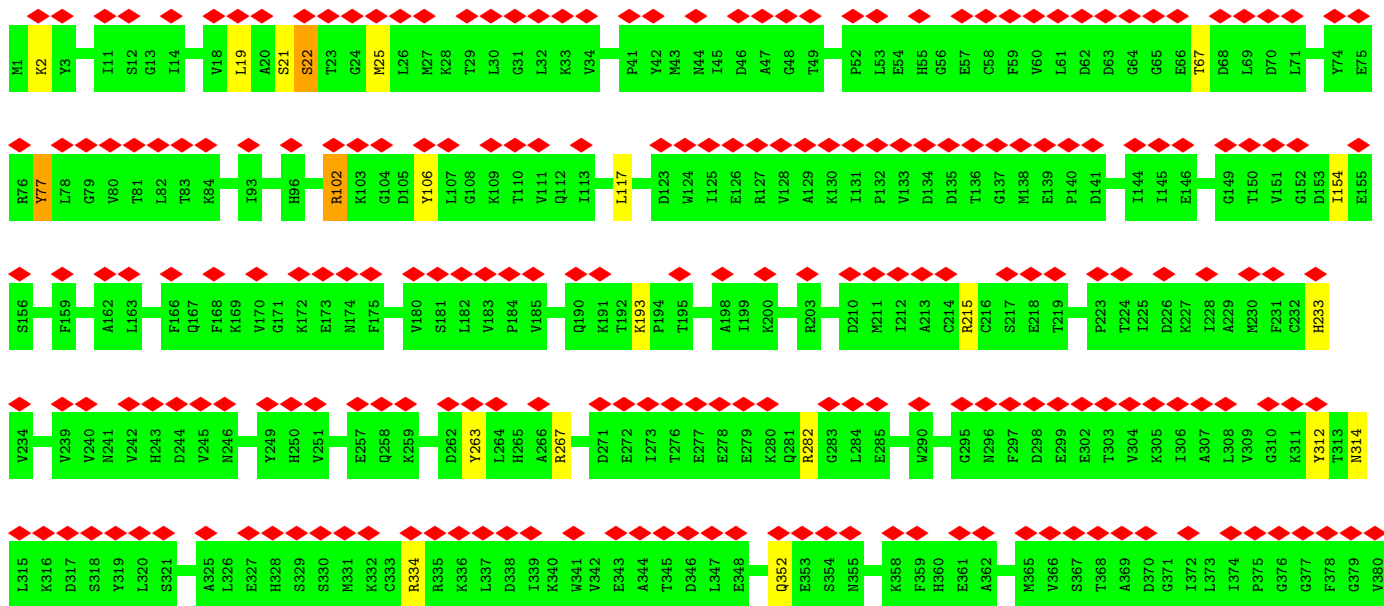
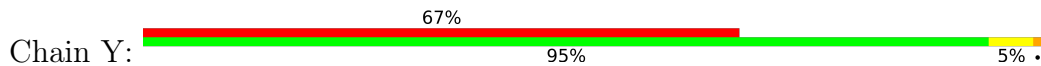

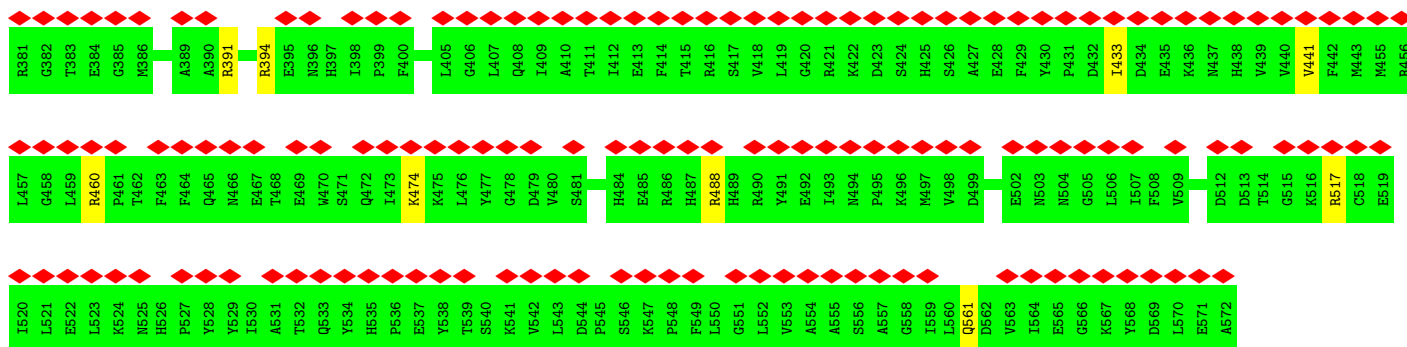

- Molecule 1: CTP synthase

Chain Z: 60% 95% 5%

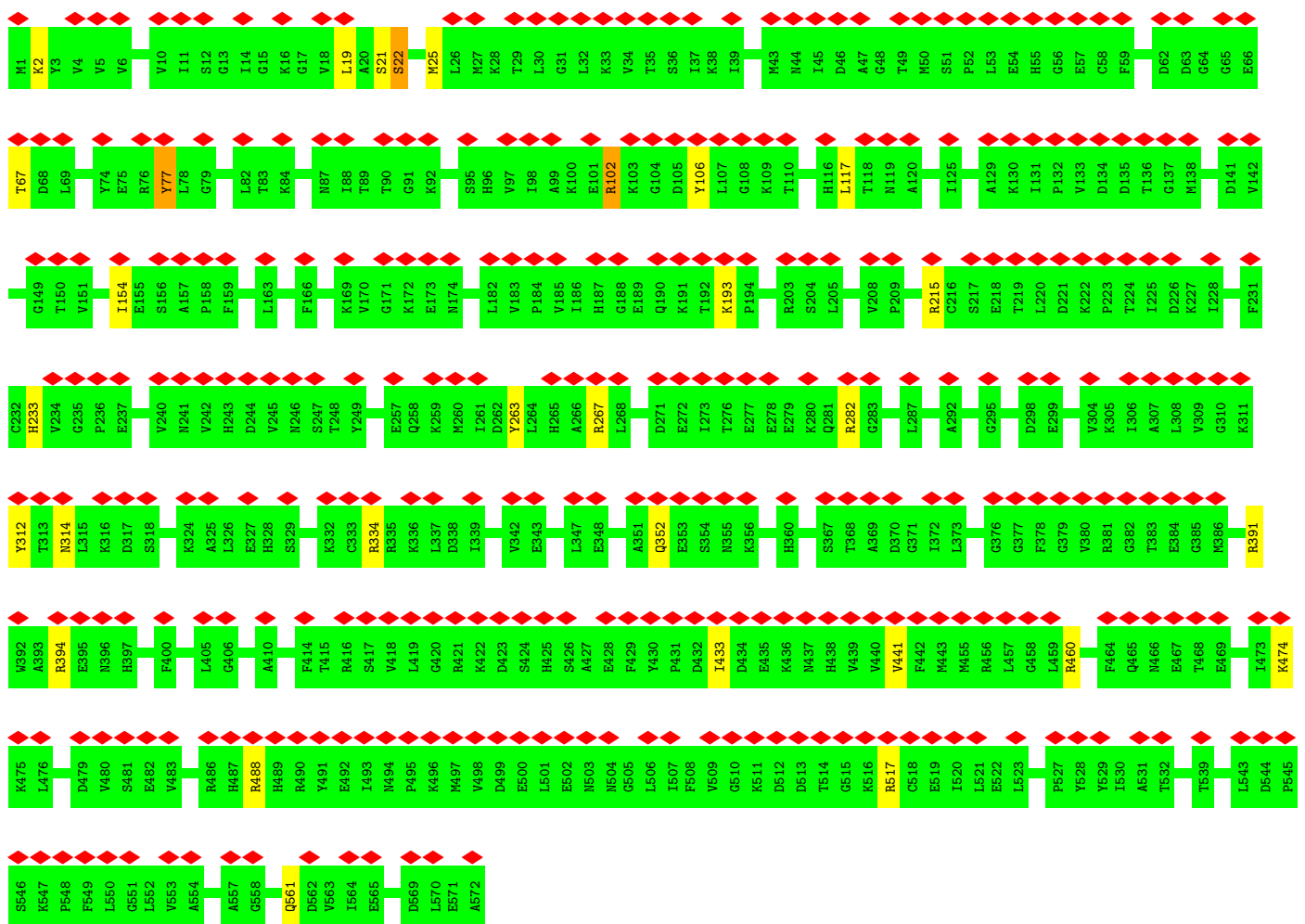

- Molecule 1: CTP synthase

Chain a: 69% 95% 5%

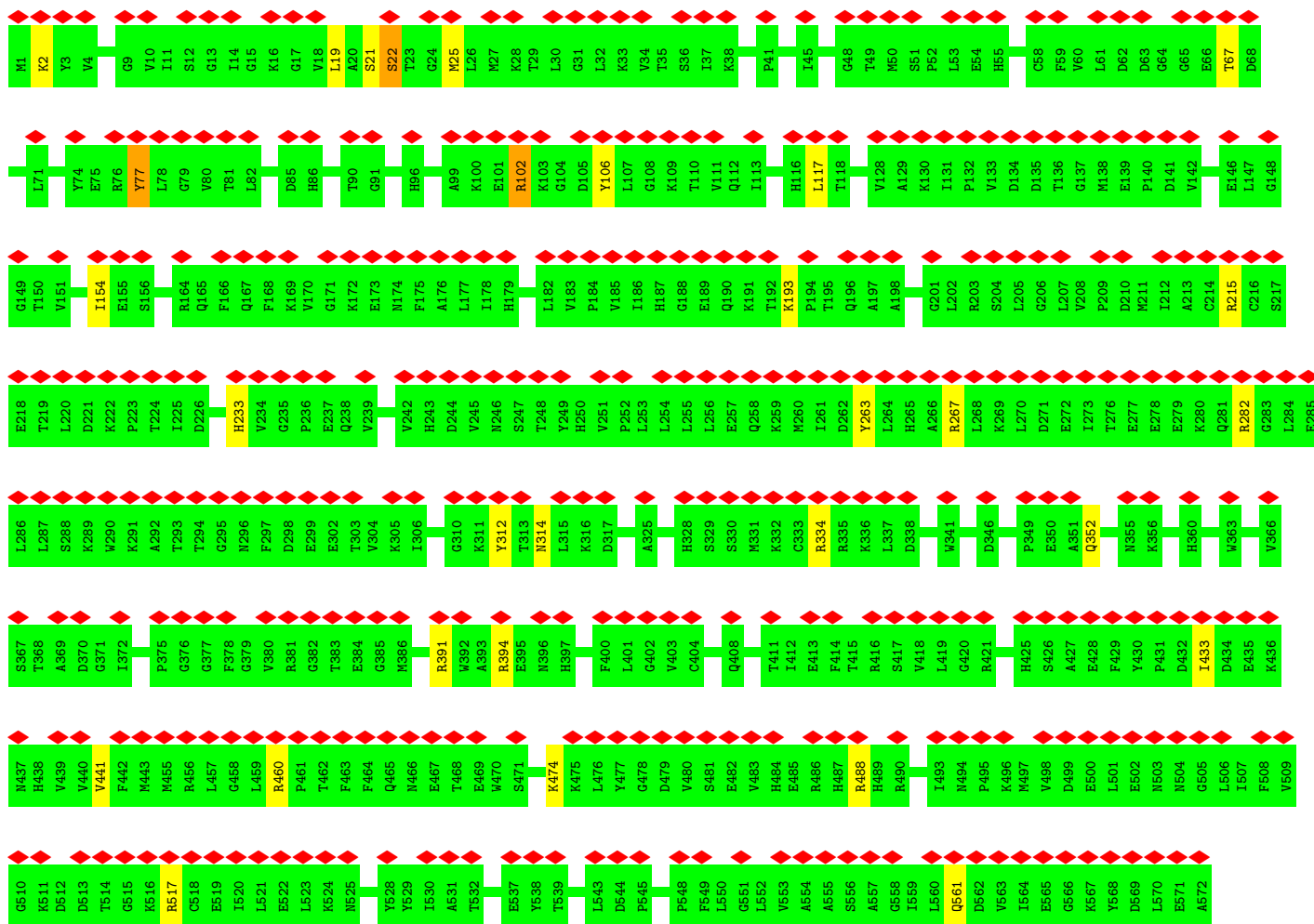

• Molecule 1: CTP synthase

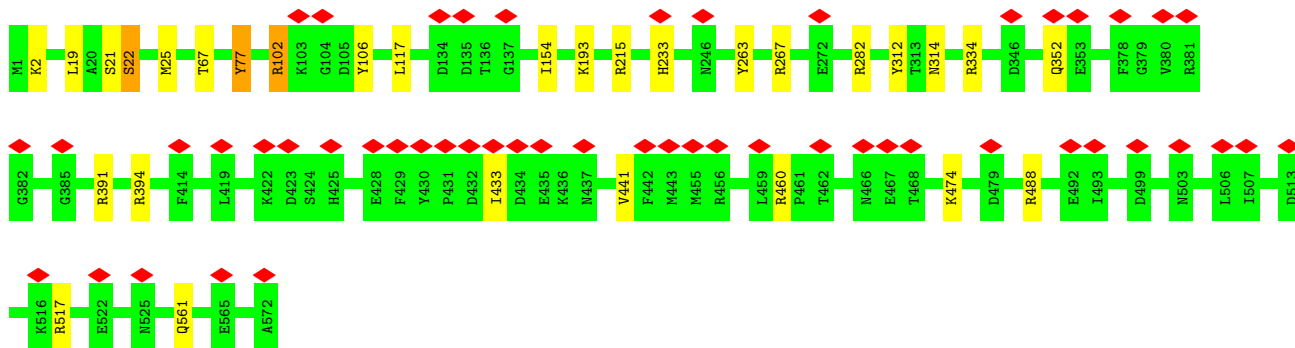
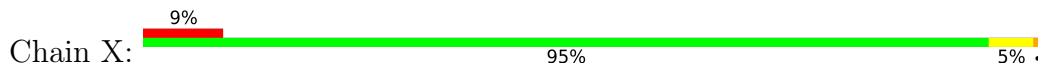

• Molecule 1: CTP synthase



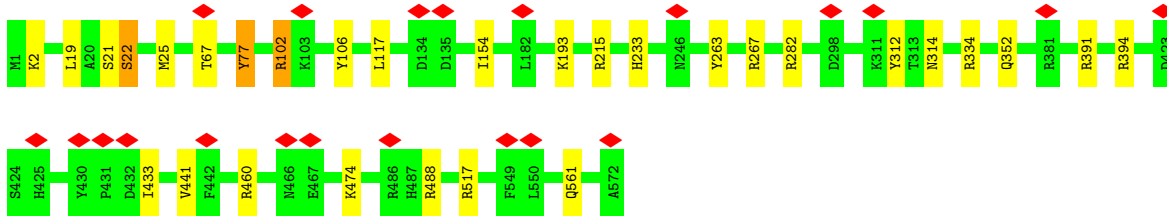

• Molecule 1: CTP synthase

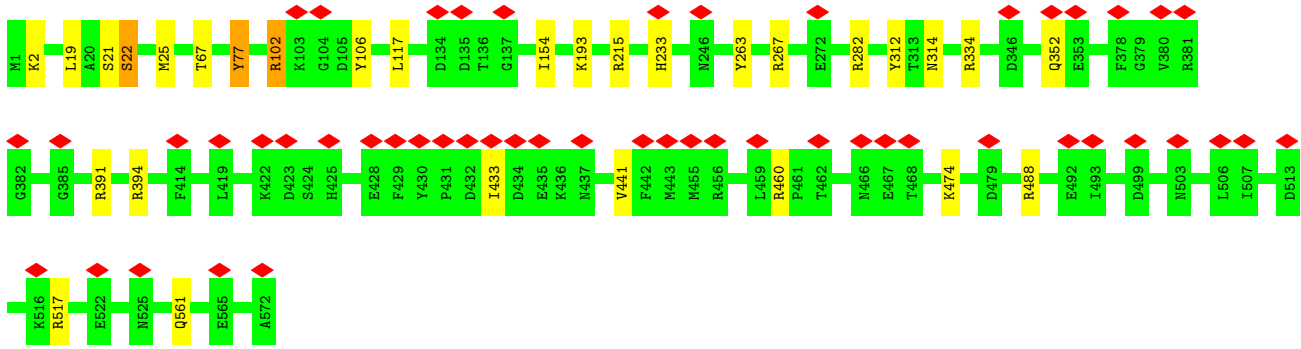

• Molecule 1: CTP synthase

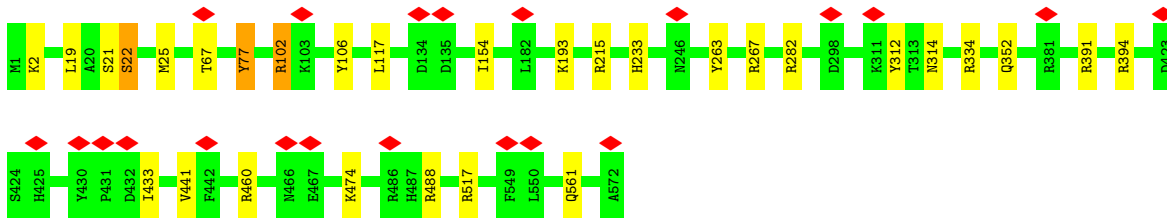

4 Experimental information

Property	Value	Source
EM reconstruction method	SINGLE PARTICLE	Depositor
Imposed symmetry	POINT, C2	Depositor
Number of particles used	28214	Depositor
Resolution determination method	FSC 0.143 CUT-OFF	Depositor
CTF correction method	PHASE FLIPPING AND AMPLITUDE CORRECTION	Depositor
Microscope	FEI TITAN KRIOS	Depositor
Voltage (kV)	300	Depositor
Electron dose ($e^-/\text{\AA}^2$)	90	Depositor
Minimum defocus (nm)	Not provided	
Maximum defocus (nm)	Not provided	
Magnification	Not provided	
Image detector	GATAN K2 SUMMIT (4k x 4k)	Depositor
Maximum map value	0.985	Depositor
Minimum map value	-0.395	Depositor
Average map value	0.008	Depositor
Map value standard deviation	0.048	Depositor
Recommended contour level	0.3	Depositor
Map size (Å)	537.6, 537.6, 537.6	wwPDB
Map dimensions	512, 512, 512	wwPDB
Map angles (°)	90.0, 90.0, 90.0	wwPDB
Pixel spacing (Å)	1.05, 1.05, 1.05	Depositor

5 Model quality i

5.1 Standard geometry i

Bond lengths and bond angles in the following residue types are not validated in this section: CTP

The Z score for a bond length (or angle) is the number of standard deviations the observed value is removed from the expected value. A bond length (or angle) with $|Z| > 5$ is considered an outlier worth inspection. RMSZ is the root-mean-square of all Z scores of the bond lengths (or angles).

Mol	Chain	Bond lengths		Bond angles	
		RMSZ	# Z >5	RMSZ	# Z >5
1	A	0.63	0/4464	1.03	15/6033 (0.2%)
1	B	0.63	0/4464	1.03	16/6033 (0.3%)
1	C	0.63	0/4464	1.03	15/6033 (0.2%)
1	D	0.63	0/4464	1.03	15/6033 (0.2%)
1	E	0.63	0/4464	1.03	16/6033 (0.3%)
1	F	0.63	0/4464	1.03	16/6033 (0.3%)
1	G	0.63	0/4464	1.03	15/6033 (0.2%)
1	H	0.63	0/4464	1.03	15/6033 (0.2%)
1	I	0.63	0/4464	1.03	15/6033 (0.2%)
1	J	0.63	0/4464	1.03	15/6033 (0.2%)
1	K	0.63	0/4464	1.03	16/6033 (0.3%)
1	L	0.63	0/4464	1.03	15/6033 (0.2%)
1	M	0.63	0/4464	1.03	16/6033 (0.3%)
1	N	0.63	0/4464	1.03	15/6033 (0.2%)
1	O	0.63	0/4464	1.03	16/6033 (0.3%)
1	P	0.63	0/4464	1.03	16/6033 (0.3%)
1	Q	0.63	0/4464	1.03	15/6033 (0.2%)
1	R	0.63	0/4464	1.03	15/6033 (0.2%)
1	S	0.63	0/4464	1.03	15/6033 (0.2%)
1	T	0.63	0/4464	1.03	16/6033 (0.3%)
1	U	0.63	0/4464	1.03	15/6033 (0.2%)
1	V	0.63	0/4464	1.03	16/6033 (0.3%)
1	W	0.63	0/4464	1.03	16/6033 (0.3%)
1	X	0.63	0/4464	1.03	15/6033 (0.2%)
1	Y	0.63	0/4464	1.03	16/6033 (0.3%)
1	Z	0.63	0/4464	1.03	16/6033 (0.3%)
1	a	0.63	0/4464	1.03	16/6033 (0.3%)
1	b	0.63	0/4464	1.03	15/6033 (0.2%)
All	All	0.63	0/124992	1.03	433/168924 (0.3%)

Chiral center outliers are detected by calculating the chiral volume of a chiral center and verifying if

the center is modelled as a planar moiety or with the opposite hand. A planarity outlier is detected by checking planarity of atoms in a peptide group, atoms in a mainchain group or atoms of a sidechain that are expected to be planar.

Mol	Chain	#Chirality outliers	#Planarity outliers
1	A	2	4
1	B	2	4
1	C	2	4
1	D	2	4
1	E	2	4
1	F	2	4
1	G	2	4
1	H	2	4
1	I	2	4
1	J	2	4
1	K	2	4
1	L	2	4
1	M	2	4
1	N	2	4
1	O	2	4
1	P	2	4
1	Q	2	4
1	R	2	4
1	S	2	4
1	T	2	4
1	U	2	4
1	V	2	4
1	W	2	4
1	X	2	4
1	Y	2	4
1	Z	2	4
1	a	2	4
1	b	2	4
All	All	56	112

There are no bond length outliers.

The worst 5 of 433 bond angle outliers are listed below:

Mol	Chain	Res	Type	Atoms	Z	Observed(°)	Ideal(°)
1	F	67	THR	CA-CB-OG1	9.32	128.58	109.00
1	Q	67	THR	CA-CB-OG1	9.32	128.58	109.00
1	G	67	THR	CA-CB-OG1	9.32	128.57	109.00
1	Z	67	THR	CA-CB-OG1	9.31	128.56	109.00
1	B	67	THR	CA-CB-OG1	9.31	128.55	109.00

5 of 56 chirality outliers are listed below:

Mol	Chain	Res	Type	Atom
1	D	22	SER	CA
1	D	77	TYR	CA
1	A	22	SER	CA
1	A	77	TYR	CA
1	B	22	SER	CA

5 of 112 planarity outliers are listed below:

Mol	Chain	Res	Type	Group
1	A	102	ARG	Sidechain
1	D	102	ARG	Sidechain
1	D	106	TYR	Sidechain
1	D	263	TYR	Sidechain
1	D	391	ARG	Sidechain

5.2 Too-close contacts [i](#)

Due to software issues we are unable to calculate clashes - this section is therefore empty.

5.3 Torsion angles [i](#)

5.3.1 Protein backbone [i](#)

In the following table, the Percentiles column shows the percent Ramachandran outliers of the chain as a percentile score with respect to all PDB entries followed by that with respect to all EM entries.

The Analysed column shows the number of residues for which the backbone conformation was analysed, and the total number of residues.

Mol	Chain	Analysed	Favoured	Allowed	Outliers	Percentiles	
1	A	549/557 (99%)	524 (95%)	23 (4%)	2 (0%)	34	72
1	B	549/557 (99%)	524 (95%)	23 (4%)	2 (0%)	34	72
1	C	549/557 (99%)	524 (95%)	23 (4%)	2 (0%)	34	72
1	D	549/557 (99%)	523 (95%)	24 (4%)	2 (0%)	34	72
1	E	549/557 (99%)	524 (95%)	23 (4%)	2 (0%)	34	72
1	F	549/557 (99%)	522 (95%)	25 (5%)	2 (0%)	34	72
1	G	549/557 (99%)	523 (95%)	24 (4%)	2 (0%)	34	72

Continued on next page...

Continued from previous page...

Mol	Chain	Analysed	Favoured	Allowed	Outliers	Percentiles	
1	H	549/557 (99%)	523 (95%)	24 (4%)	2 (0%)	34	72
1	I	549/557 (99%)	524 (95%)	23 (4%)	2 (0%)	34	72
1	J	549/557 (99%)	522 (95%)	25 (5%)	2 (0%)	34	72
1	K	549/557 (99%)	524 (95%)	23 (4%)	2 (0%)	34	72
1	L	549/557 (99%)	524 (95%)	23 (4%)	2 (0%)	34	72
1	M	549/557 (99%)	523 (95%)	24 (4%)	2 (0%)	34	72
1	N	549/557 (99%)	523 (95%)	24 (4%)	2 (0%)	34	72
1	O	549/557 (99%)	524 (95%)	23 (4%)	2 (0%)	34	72
1	P	549/557 (99%)	522 (95%)	25 (5%)	2 (0%)	34	72
1	Q	549/557 (99%)	524 (95%)	23 (4%)	2 (0%)	34	72
1	R	549/557 (99%)	523 (95%)	24 (4%)	2 (0%)	34	72
1	S	549/557 (99%)	524 (95%)	23 (4%)	2 (0%)	34	72
1	T	549/557 (99%)	524 (95%)	23 (4%)	2 (0%)	34	72
1	U	549/557 (99%)	524 (95%)	23 (4%)	2 (0%)	34	72
1	V	549/557 (99%)	523 (95%)	24 (4%)	2 (0%)	34	72
1	W	549/557 (99%)	522 (95%)	25 (5%)	2 (0%)	34	72
1	X	549/557 (99%)	523 (95%)	24 (4%)	2 (0%)	34	72
1	Y	549/557 (99%)	523 (95%)	24 (4%)	2 (0%)	34	72
1	Z	549/557 (99%)	523 (95%)	24 (4%)	2 (0%)	34	72
1	a	549/557 (99%)	524 (95%)	23 (4%)	2 (0%)	34	72
1	b	549/557 (99%)	524 (95%)	23 (4%)	2 (0%)	34	72
All	All	15372/15596 (99%)	14654 (95%)	662 (4%)	56 (0%)	38	72

5 of 56 Ramachandran outliers are listed below:

Mol	Chain	Res	Type
1	D	433	ILE
1	A	433	ILE
1	B	433	ILE
1	C	433	ILE
1	U	433	ILE

5.3.2 Protein sidechains [i](#)

In the following table, the Percentiles column shows the percent sidechain outliers of the chain as a percentile score with respect to all PDB entries followed by that with respect to all EM entries.

The Analysed column shows the number of residues for which the sidechain conformation was analysed, and the total number of residues.

Mol	Chain	Analysed	Rotameric	Outliers	Percentiles
1	A	482/482 (100%)	468 (97%)	14 (3%)	42 64
1	B	482/482 (100%)	468 (97%)	14 (3%)	42 64
1	C	482/482 (100%)	468 (97%)	14 (3%)	42 64
1	D	482/482 (100%)	468 (97%)	14 (3%)	42 64
1	E	482/482 (100%)	468 (97%)	14 (3%)	42 64
1	F	482/482 (100%)	468 (97%)	14 (3%)	42 64
1	G	482/482 (100%)	468 (97%)	14 (3%)	42 64
1	H	482/482 (100%)	468 (97%)	14 (3%)	42 64
1	I	482/482 (100%)	468 (97%)	14 (3%)	42 64
1	J	482/482 (100%)	468 (97%)	14 (3%)	42 64
1	K	482/482 (100%)	468 (97%)	14 (3%)	42 64
1	L	482/482 (100%)	468 (97%)	14 (3%)	42 64
1	M	482/482 (100%)	468 (97%)	14 (3%)	42 64
1	N	482/482 (100%)	468 (97%)	14 (3%)	42 64
1	O	482/482 (100%)	468 (97%)	14 (3%)	42 64
1	P	482/482 (100%)	468 (97%)	14 (3%)	42 64
1	Q	482/482 (100%)	468 (97%)	14 (3%)	42 64
1	R	482/482 (100%)	468 (97%)	14 (3%)	42 64
1	S	482/482 (100%)	468 (97%)	14 (3%)	42 64
1	T	482/482 (100%)	468 (97%)	14 (3%)	42 64
1	U	482/482 (100%)	468 (97%)	14 (3%)	42 64
1	V	482/482 (100%)	468 (97%)	14 (3%)	42 64
1	W	482/482 (100%)	468 (97%)	14 (3%)	42 64
1	X	482/482 (100%)	468 (97%)	14 (3%)	42 64
1	Y	482/482 (100%)	468 (97%)	14 (3%)	42 64
1	Z	482/482 (100%)	468 (97%)	14 (3%)	42 64

Continued on next page...

Continued from previous page...

Mol	Chain	Analysed	Rotameric	Outliers	Percentiles
1	a	482/482 (100%)	468 (97%)	14 (3%)	42 64
1	b	482/482 (100%)	468 (97%)	14 (3%)	42 64
All	All	13496/13496 (100%)	13104 (97%)	392 (3%)	45 64

5 of 392 residues with a non-rotameric sidechain are listed below:

Mol	Chain	Res	Type
1	W	154	ILE
1	b	117	LEU
1	K	2	LYS
1	O	193	LYS
1	Y	117	LEU

Sometimes sidechains can be flipped to improve hydrogen bonding and reduce clashes. 5 of 17 such sidechains are listed below:

Mol	Chain	Res	Type
1	L	352	GLN
1	T	352	GLN
1	G	352	GLN
1	K	352	GLN
1	O	352	GLN

5.3.3 RNA [i](#)

There are no RNA molecules in this entry.

5.4 Non-standard residues in protein, DNA, RNA chains [i](#)

There are no non-standard protein/DNA/RNA residues in this entry.

5.5 Carbohydrates [i](#)

There are no monosaccharides in this entry.

5.6 Ligand geometry [i](#)

56 ligands are modelled in this entry.

In the following table, the Counts columns list the number of bonds (or angles) for which Mogul statistics could be retrieved, the number of bonds (or angles) that are observed in the model and the number of bonds (or angles) that are defined in the Chemical Component Dictionary. The Link column lists molecule types, if any, to which the group is linked. The Z score for a bond length (or angle) is the number of standard deviations the observed value is removed from the expected value. A bond length (or angle) with $|Z| > 2$ is considered an outlier worth inspection. RMSZ is the root-mean-square of all Z scores of the bond lengths (or angles).

Mol	Type	Chain	Res	Link	Bond lengths			Bond angles		
					Counts	RMSZ	# Z > 2	Counts	RMSZ	# Z > 2
2	CTP	S	602	-	26,30,30	1.36	4 (15%)	39,47,47	1.41	6 (15%)
2	CTP	a	601	-	26,30,30	1.46	4 (15%)	39,47,47	1.80	6 (15%)
2	CTP	N	601	-	26,30,30	1.44	3 (11%)	39,47,47	1.82	7 (17%)
2	CTP	B	602	-	26,30,30	1.32	4 (15%)	39,47,47	1.42	6 (15%)
2	CTP	F	601	-	26,30,30	1.46	3 (11%)	39,47,47	1.82	7 (17%)
2	CTP	X	601	-	26,30,30	1.45	3 (11%)	39,47,47	1.82	7 (17%)
2	CTP	F	602	-	26,30,30	1.33	4 (15%)	39,47,47	1.42	6 (15%)
2	CTP	G	602	-	26,30,30	1.35	4 (15%)	39,47,47	1.41	6 (15%)
2	CTP	b	602	-	26,30,30	1.32	4 (15%)	39,47,47	1.42	6 (15%)
2	CTP	M	601	-	26,30,30	1.45	3 (11%)	39,47,47	1.81	7 (17%)
2	CTP	W	601	-	26,30,30	1.45	3 (11%)	39,47,47	1.82	7 (17%)
2	CTP	Z	602	-	26,30,30	1.32	3 (11%)	39,47,47	1.42	6 (15%)
2	CTP	Q	602	-	26,30,30	1.35	5 (19%)	39,47,47	1.41	6 (15%)
2	CTP	T	601	-	26,30,30	1.46	4 (15%)	39,47,47	1.80	6 (15%)
2	CTP	G	601	-	26,30,30	1.46	4 (15%)	39,47,47	1.80	6 (15%)
2	CTP	W	602	-	26,30,30	1.33	4 (15%)	39,47,47	1.42	6 (15%)
2	CTP	A	602	-	26,30,30	1.35	5 (19%)	39,47,47	1.41	6 (15%)
2	CTP	Y	601	-	26,30,30	1.46	4 (15%)	39,47,47	1.80	6 (15%)
2	CTP	Z	601	-	26,30,30	1.45	3 (11%)	39,47,47	1.82	7 (17%)
2	CTP	L	602	-	26,30,30	1.36	5 (19%)	39,47,47	1.40	6 (15%)
2	CTP	I	601	-	26,30,30	1.46	4 (15%)	39,47,47	1.81	6 (15%)
2	CTP	V	601	-	26,30,30	1.45	3 (11%)	39,47,47	1.82	7 (17%)
2	CTP	K	601	-	26,30,30	1.46	4 (15%)	39,47,47	1.81	6 (15%)
2	CTP	A	601	-	26,30,30	1.46	4 (15%)	39,47,47	1.80	6 (15%)
2	CTP	X	602	-	26,30,30	1.32	3 (11%)	39,47,47	1.43	6 (15%)
2	CTP	R	601	-	26,30,30	1.46	4 (15%)	39,47,47	1.80	6 (15%)
2	CTP	E	602	-	26,30,30	1.36	4 (15%)	39,47,47	1.41	6 (15%)
2	CTP	U	601	-	26,30,30	1.45	3 (11%)	39,47,47	1.82	7 (17%)
2	CTP	T	602	-	26,30,30	1.36	5 (19%)	39,47,47	1.41	6 (15%)

Mol	Type	Chain	Res	Link	Bond lengths			Bond angles		
					Counts	RMSZ	# Z > 2	Counts	RMSZ	# Z > 2
2	CTP	H	601	-	26,30,30	1.45	3 (11%)	39,47,47	1.81	7 (17%)
2	CTP	J	601	-	26,30,30	1.46	4 (15%)	39,47,47	1.80	6 (15%)
2	CTP	O	602	-	26,30,30	1.32	3 (11%)	39,47,47	1.42	6 (15%)
2	CTP	C	601	-	26,30,30	1.46	4 (15%)	39,47,47	1.80	6 (15%)
2	CTP	S	601	-	26,30,30	1.46	4 (15%)	39,47,47	1.80	6 (15%)
2	CTP	M	602	-	26,30,30	1.33	4 (15%)	39,47,47	1.42	6 (15%)
2	CTP	a	602	-	26,30,30	1.36	5 (19%)	39,47,47	1.40	6 (15%)
2	CTP	I	602	-	26,30,30	1.35	4 (15%)	39,47,47	1.41	6 (15%)
2	CTP	Y	602	-	26,30,30	1.35	4 (15%)	39,47,47	1.41	6 (15%)
2	CTP	B	601	-	26,30,30	1.45	3 (11%)	39,47,47	1.82	7 (17%)
2	CTP	P	602	-	26,30,30	1.33	3 (11%)	39,47,47	1.42	6 (15%)
2	CTP	O	601	-	26,30,30	1.44	3 (11%)	39,47,47	1.81	7 (17%)
2	CTP	C	602	-	26,30,30	1.36	4 (15%)	39,47,47	1.41	6 (15%)
2	CTP	D	602	-	26,30,30	1.33	3 (11%)	39,47,47	1.42	6 (15%)
2	CTP	P	601	-	26,30,30	1.45	3 (11%)	39,47,47	1.82	7 (17%)
2	CTP	E	601	-	26,30,30	1.46	4 (15%)	39,47,47	1.80	6 (15%)
2	CTP	D	601	-	26,30,30	1.44	3 (11%)	39,47,47	1.81	7 (17%)
2	CTP	Q	601	-	26,30,30	1.46	4 (15%)	39,47,47	1.81	6 (15%)
2	CTP	R	602	-	26,30,30	1.36	5 (19%)	39,47,47	1.41	6 (15%)
2	CTP	b	601	-	26,30,30	1.44	3 (11%)	39,47,47	1.81	7 (17%)
2	CTP	J	602	-	26,30,30	1.35	4 (15%)	39,47,47	1.41	6 (15%)
2	CTP	U	602	-	26,30,30	1.32	3 (11%)	39,47,47	1.42	6 (15%)
2	CTP	L	601	-	26,30,30	1.46	4 (15%)	39,47,47	1.81	6 (15%)
2	CTP	H	602	-	26,30,30	1.33	3 (11%)	39,47,47	1.42	6 (15%)
2	CTP	V	602	-	26,30,30	1.32	4 (15%)	39,47,47	1.42	6 (15%)
2	CTP	N	602	-	26,30,30	1.32	3 (11%)	39,47,47	1.42	6 (15%)
2	CTP	K	602	-	26,30,30	1.36	5 (19%)	39,47,47	1.41	6 (15%)

In the following table, the Chirals column lists the number of chiral outliers, the number of chiral centers analysed, the number of these observed in the model and the number defined in the Chemical Component Dictionary. Similar counts are reported in the Torsion and Rings columns. '-' means no outliers of that kind were identified.

Mol	Type	Chain	Res	Link	Chirals	Torsions	Rings
2	CTP	S	602	-	-	9/22/38/38	0/2/2/2
2	CTP	a	601	-	-	8/22/38/38	0/2/2/2

Continued on next page...

Continued from previous page...

Mol	Type	Chain	Res	Link	Chirals	Torsions	Rings
2	CTP	N	601	-	-	8/22/38/38	0/2/2/2
2	CTP	B	602	-	-	7/22/38/38	0/2/2/2
2	CTP	F	601	-	-	8/22/38/38	0/2/2/2
2	CTP	X	601	-	-	8/22/38/38	0/2/2/2
2	CTP	F	602	-	-	7/22/38/38	0/2/2/2
2	CTP	G	602	-	-	8/22/38/38	0/2/2/2
2	CTP	b	602	-	-	7/22/38/38	0/2/2/2
2	CTP	M	601	-	-	8/22/38/38	0/2/2/2
2	CTP	W	601	-	-	8/22/38/38	0/2/2/2
2	CTP	Z	602	-	-	7/22/38/38	0/2/2/2
2	CTP	Q	602	-	-	8/22/38/38	0/2/2/2
2	CTP	T	601	-	-	8/22/38/38	0/2/2/2
2	CTP	G	601	-	-	8/22/38/38	0/2/2/2
2	CTP	W	602	-	-	7/22/38/38	0/2/2/2
2	CTP	A	602	-	-	8/22/38/38	0/2/2/2
2	CTP	Y	601	-	-	8/22/38/38	0/2/2/2
2	CTP	Z	601	-	-	8/22/38/38	0/2/2/2
2	CTP	L	602	-	-	8/22/38/38	0/2/2/2
2	CTP	I	601	-	-	8/22/38/38	0/2/2/2
2	CTP	V	601	-	-	8/22/38/38	0/2/2/2
2	CTP	K	601	-	-	8/22/38/38	0/2/2/2
2	CTP	A	601	-	-	8/22/38/38	0/2/2/2
2	CTP	X	602	-	-	7/22/38/38	0/2/2/2
2	CTP	R	601	-	-	8/22/38/38	0/2/2/2
2	CTP	E	602	-	-	8/22/38/38	0/2/2/2
2	CTP	U	601	-	-	8/22/38/38	0/2/2/2
2	CTP	T	602	-	-	8/22/38/38	0/2/2/2
2	CTP	H	601	-	-	8/22/38/38	0/2/2/2
2	CTP	J	601	-	-	8/22/38/38	0/2/2/2
2	CTP	O	602	-	-	7/22/38/38	0/2/2/2
2	CTP	C	601	-	-	8/22/38/38	0/2/2/2
2	CTP	S	601	-	-	8/22/38/38	0/2/2/2
2	CTP	M	602	-	-	7/22/38/38	0/2/2/2
2	CTP	a	602	-	-	9/22/38/38	0/2/2/2

Continued on next page...

Continued from previous page...

Mol	Type	Chain	Res	Link	Chirals	Torsions	Rings
2	CTP	I	602	-	-	8/22/38/38	0/2/2/2
2	CTP	Y	602	-	-	8/22/38/38	0/2/2/2
2	CTP	B	601	-	-	8/22/38/38	0/2/2/2
2	CTP	P	602	-	-	7/22/38/38	0/2/2/2
2	CTP	O	601	-	-	8/22/38/38	0/2/2/2
2	CTP	C	602	-	-	8/22/38/38	0/2/2/2
2	CTP	D	602	-	-	7/22/38/38	0/2/2/2
2	CTP	P	601	-	-	8/22/38/38	0/2/2/2
2	CTP	E	601	-	-	8/22/38/38	0/2/2/2
2	CTP	D	601	-	-	8/22/38/38	0/2/2/2
2	CTP	Q	601	-	-	8/22/38/38	0/2/2/2
2	CTP	R	602	-	-	8/22/38/38	0/2/2/2
2	CTP	b	601	-	-	8/22/38/38	0/2/2/2
2	CTP	J	602	-	-	8/22/38/38	0/2/2/2
2	CTP	U	602	-	-	7/22/38/38	0/2/2/2
2	CTP	L	601	-	-	8/22/38/38	0/2/2/2
2	CTP	H	602	-	-	7/22/38/38	0/2/2/2
2	CTP	V	602	-	-	7/22/38/38	0/2/2/2
2	CTP	N	602	-	-	7/22/38/38	0/2/2/2
2	CTP	K	602	-	-	8/22/38/38	0/2/2/2

The worst 5 of 209 bond length outliers are listed below:

Mol	Chain	Res	Type	Atoms	Z	Observed(Å)	Ideal(Å)
2	C	601	CTP	C6-N1	-3.12	1.30	1.38
2	T	601	CTP	C6-N1	-3.12	1.30	1.38
2	U	601	CTP	C6-N1	-3.11	1.30	1.38
2	F	601	CTP	C6-N1	-3.11	1.30	1.38
2	Z	601	CTP	C6-N1	-3.11	1.30	1.38

The worst 5 of 350 bond angle outliers are listed below:

Mol	Chain	Res	Type	Atoms	Z	Observed(°)	Ideal(°)
2	a	601	CTP	PB-O3B-PG	-6.81	109.44	132.83
2	N	601	CTP	PB-O3B-PG	-6.81	109.45	132.83
2	I	601	CTP	PB-O3B-PG	-6.81	109.45	132.83
2	V	601	CTP	PB-O3B-PG	-6.81	109.45	132.83
2	C	601	CTP	PB-O3B-PG	-6.81	109.46	132.83

There are no chirality outliers.

5 of 436 torsion outliers are listed below:

Mol	Chain	Res	Type	Atoms
2	D	601	CTP	C2'-C1'-N1-C6
2	D	601	CTP	C5'-O5'-PA-O1A
2	D	601	CTP	C5'-O5'-PA-O2A
2	D	602	CTP	C3'-C4'-C5'-O5'
2	D	602	CTP	C5'-O5'-PA-O2A

There are no ring outliers.

No monomer is involved in short contacts.

The following is a two-dimensional graphical depiction of Mogul quality analysis of bond lengths, bond angles, torsion angles, and ring geometry for all instances of the Ligand of Interest. In addition, ligands with molecular weight > 250 and outliers as shown on the validation Tables will also be included. For torsion angles, if less than 5% of the Mogul distribution of torsion angles is within 10 degrees of the torsion angle in question, then that torsion angle is considered an outlier. Any bond that is central to one or more torsion angles identified as an outlier by Mogul will be highlighted in the graph. For rings, the root-mean-square deviation (RMSD) between the ring in question and similar rings identified by Mogul is calculated over all ring torsion angles. If the average RMSD is greater than 60 degrees and the minimal RMSD between the ring in question and any Mogul-identified rings is also greater than 60 degrees, then that ring is considered an outlier. The outliers are highlighted in purple. The color gray indicates Mogul did not find sufficient equivalents in the CSD to analyse the geometry.

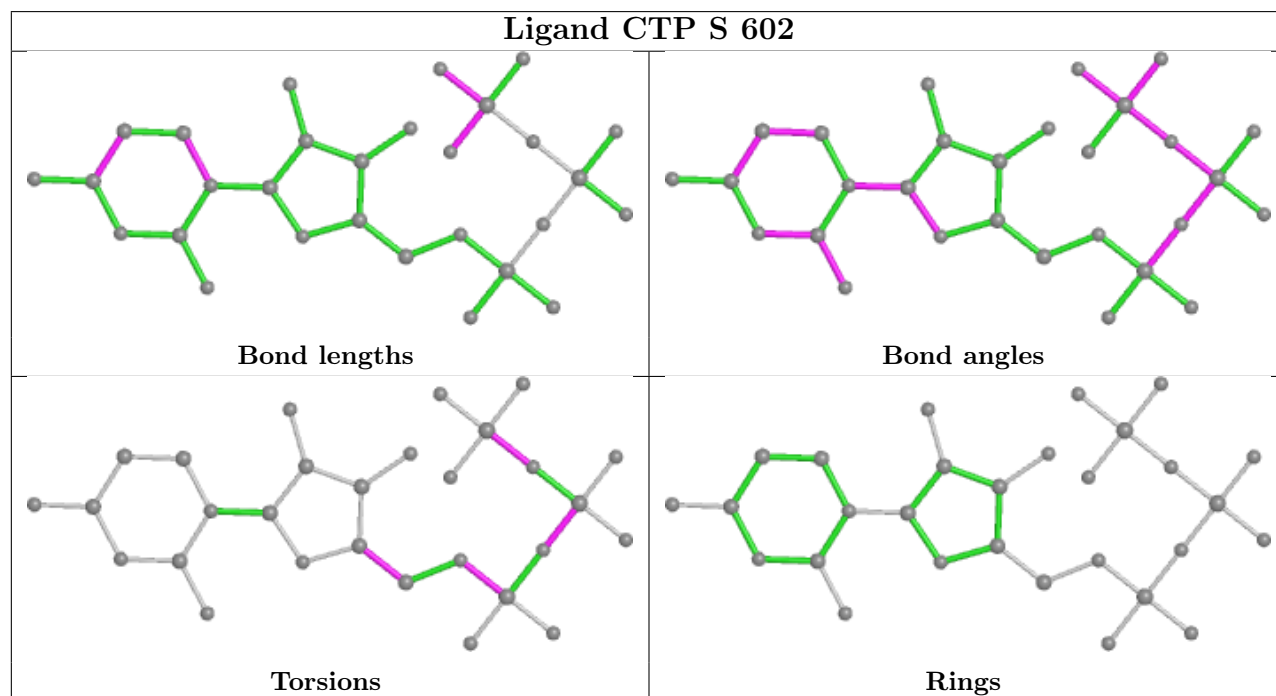

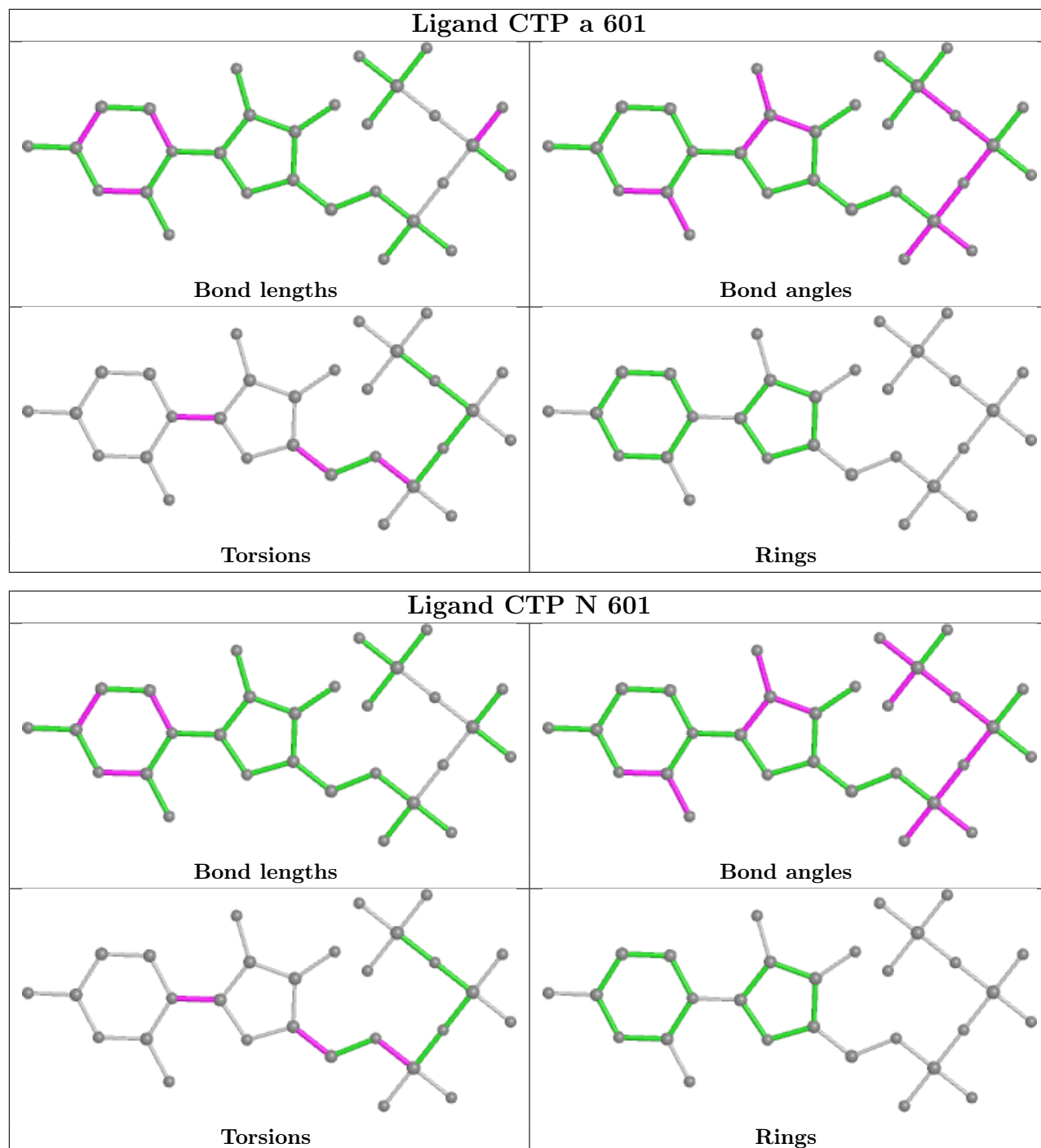

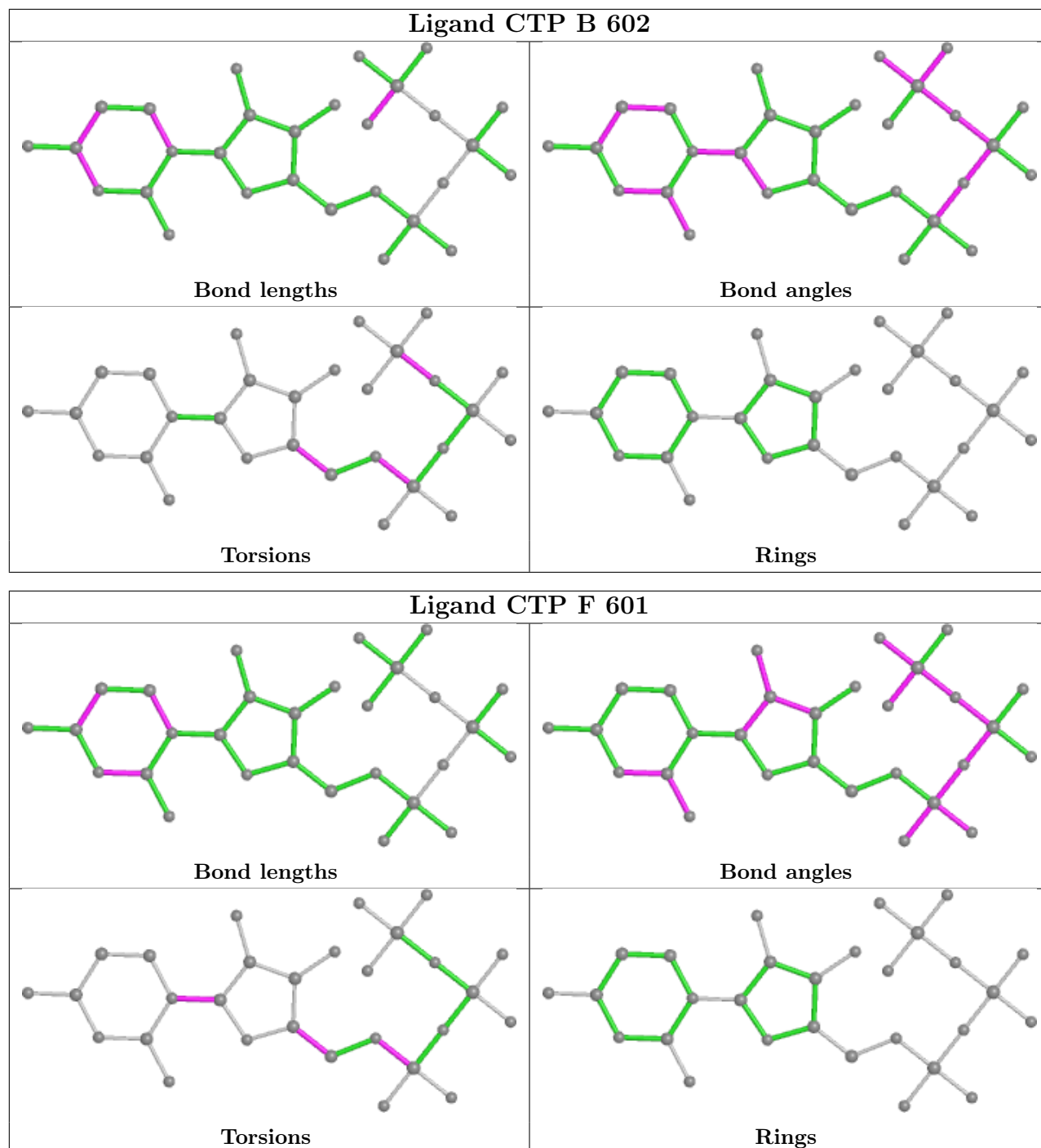

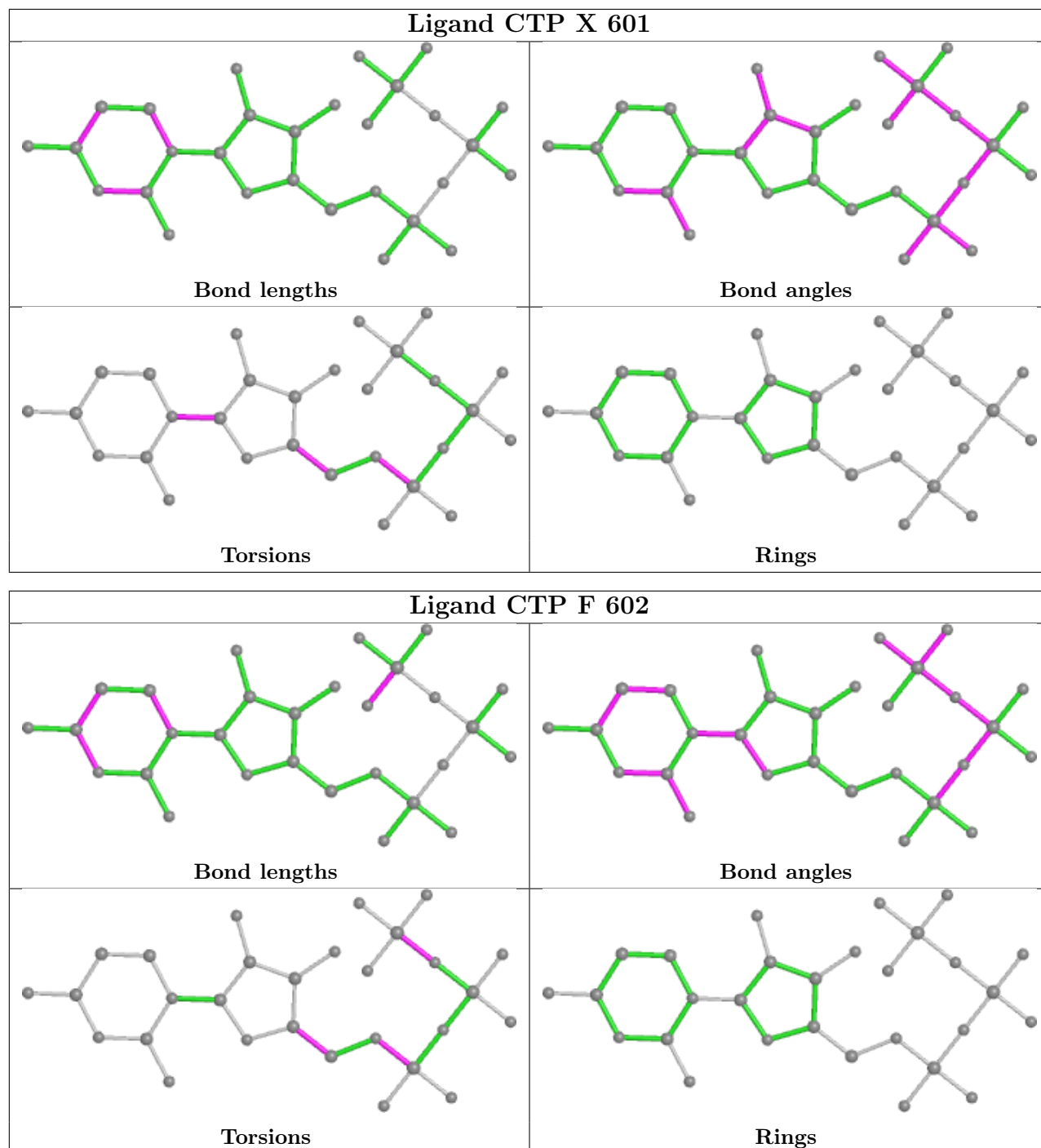

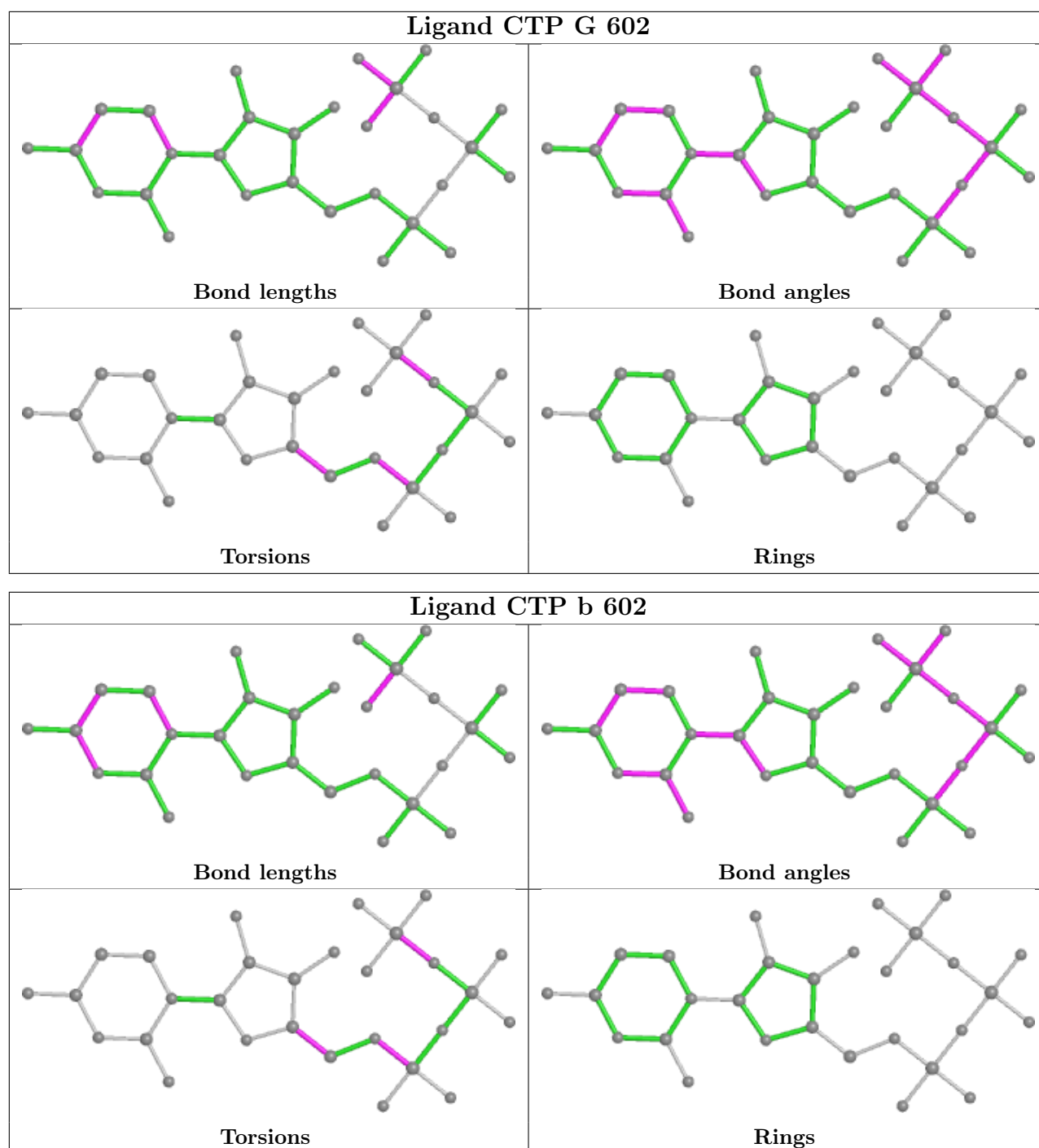

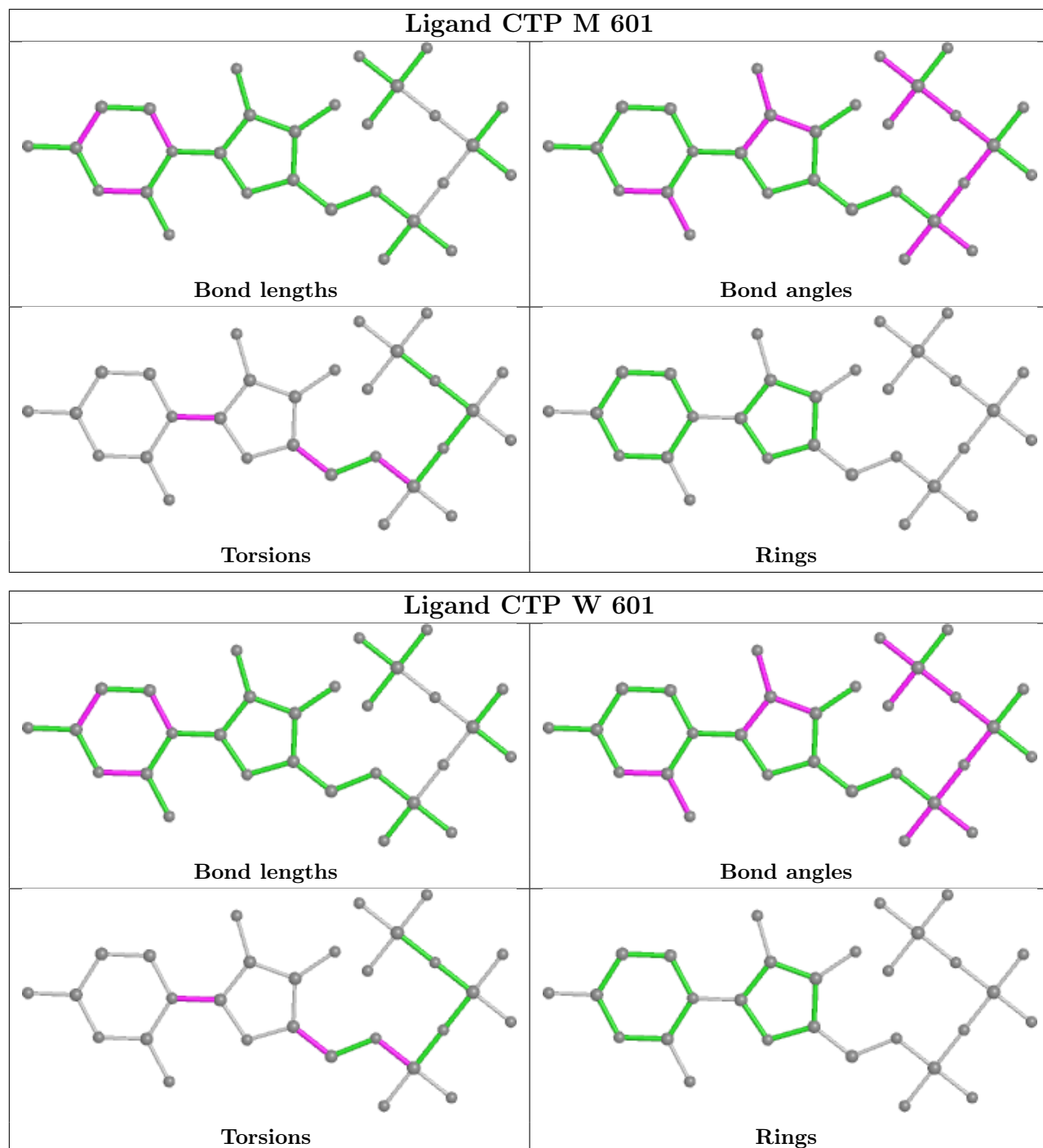

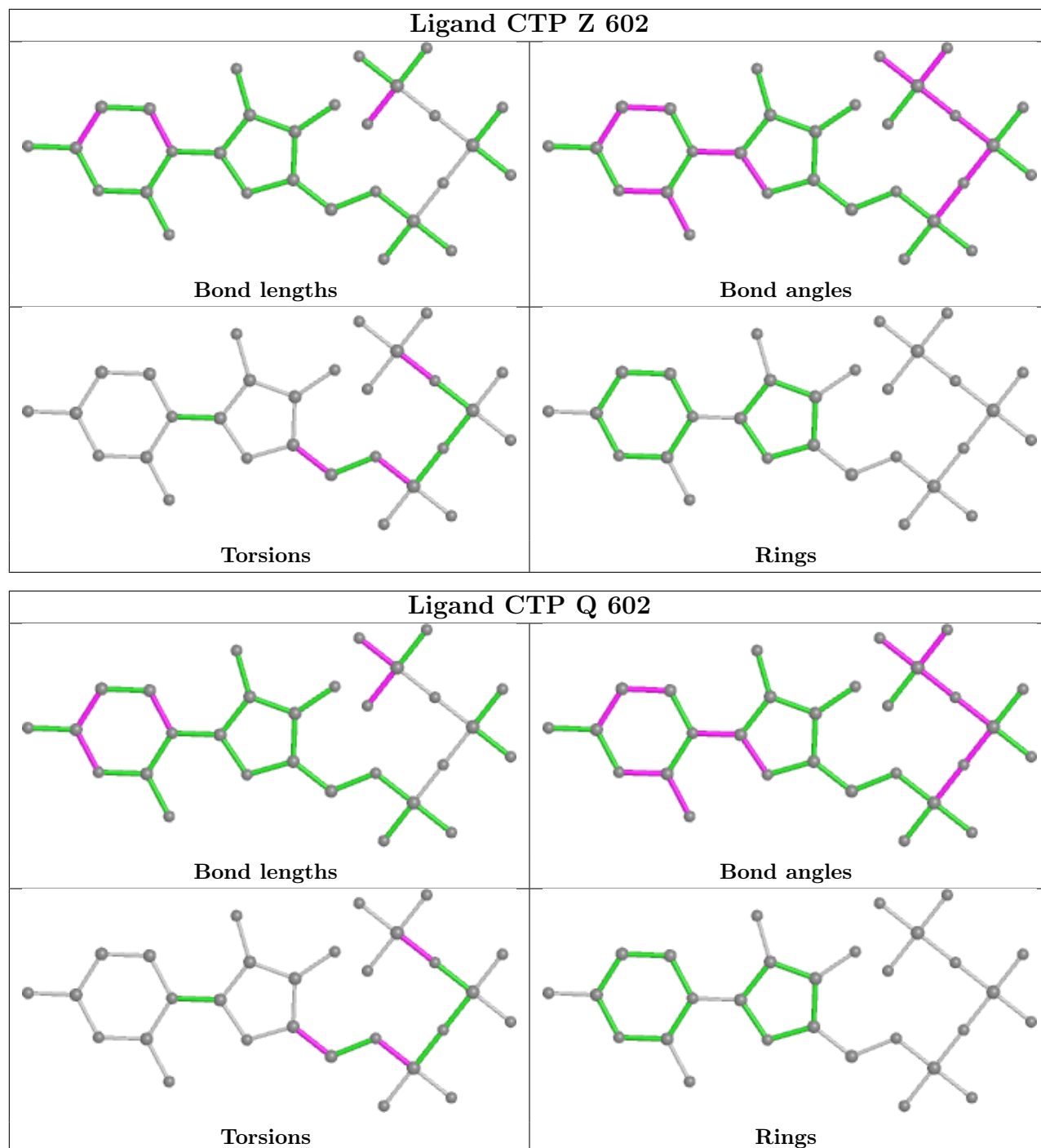

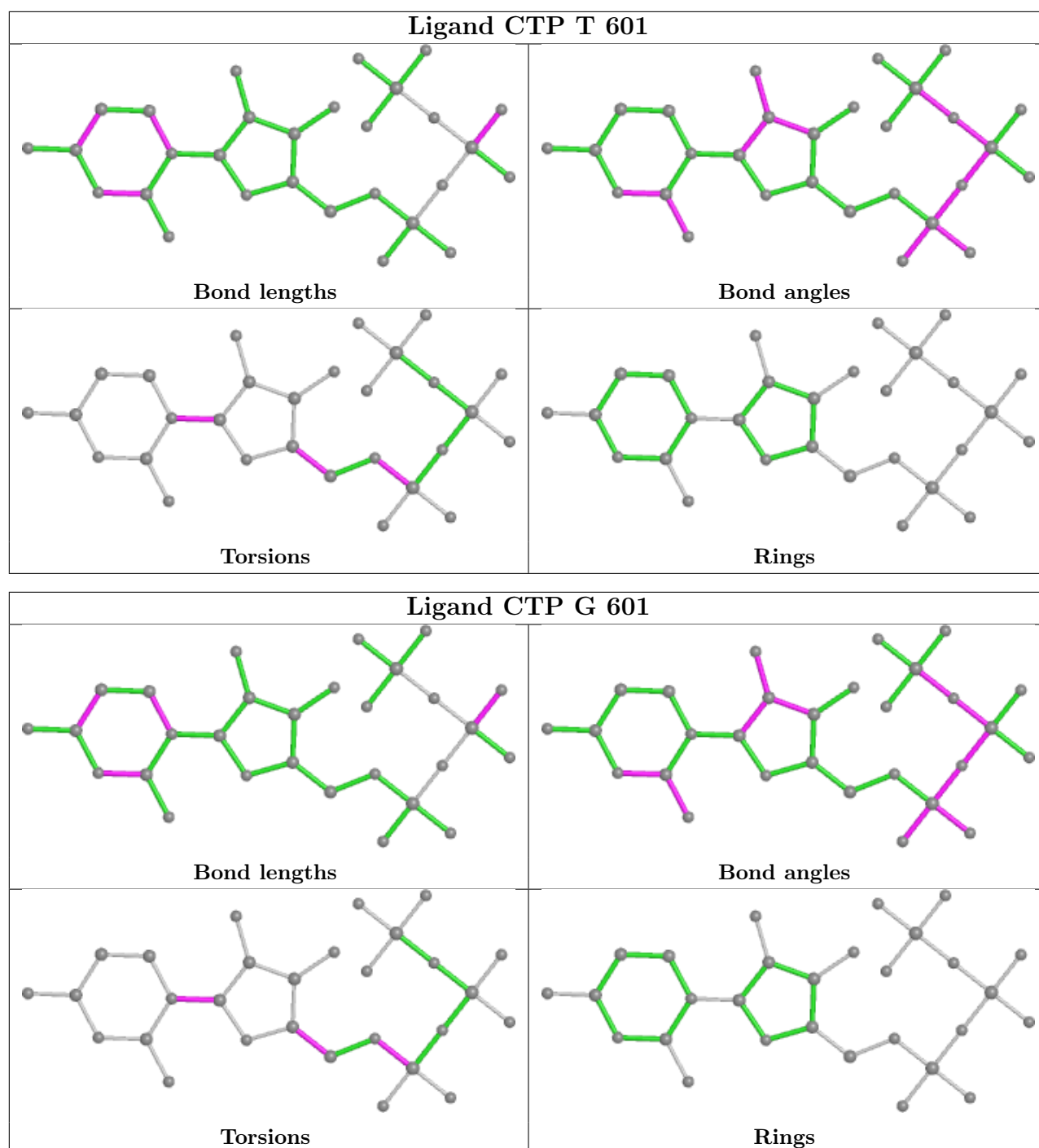

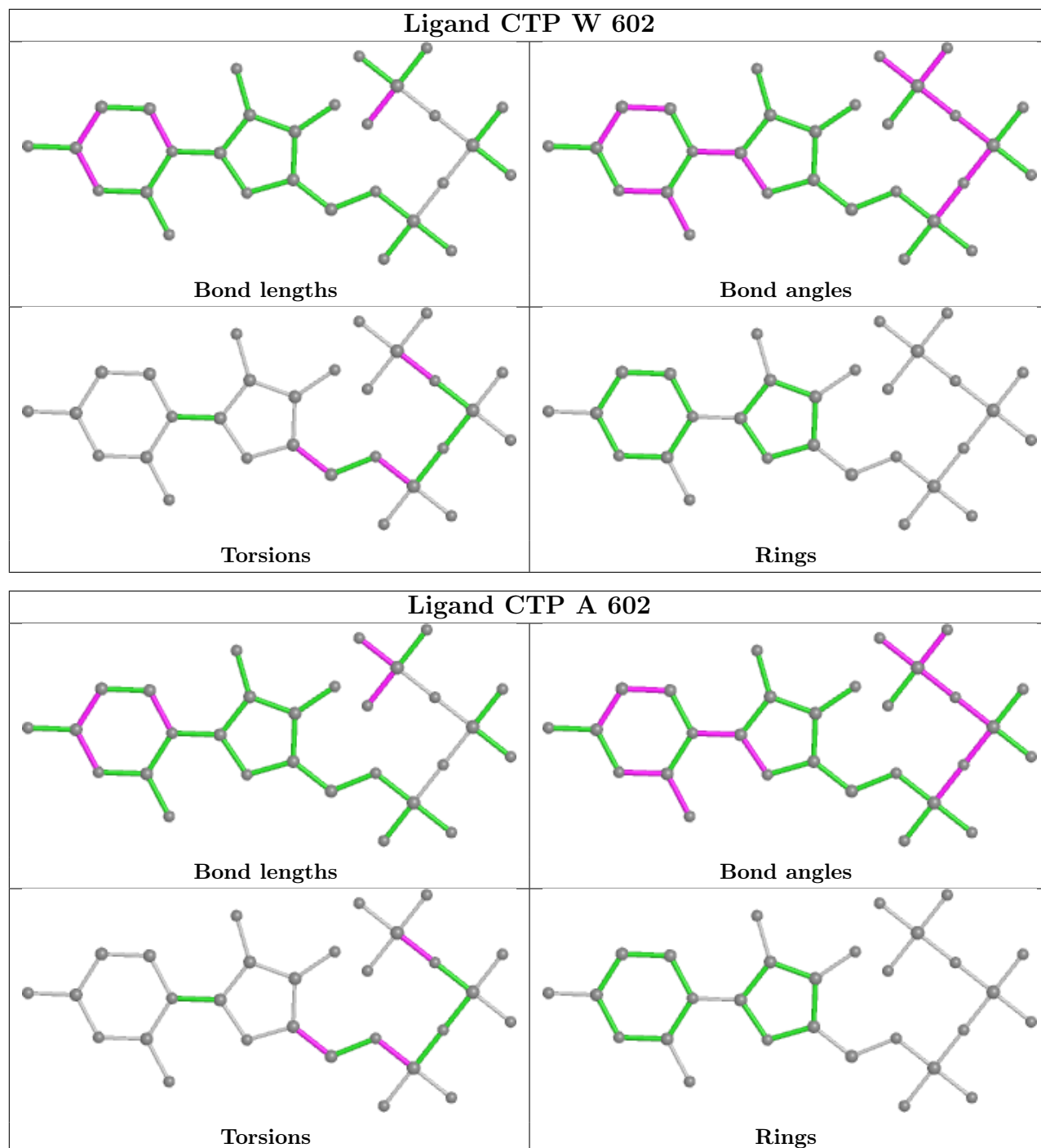

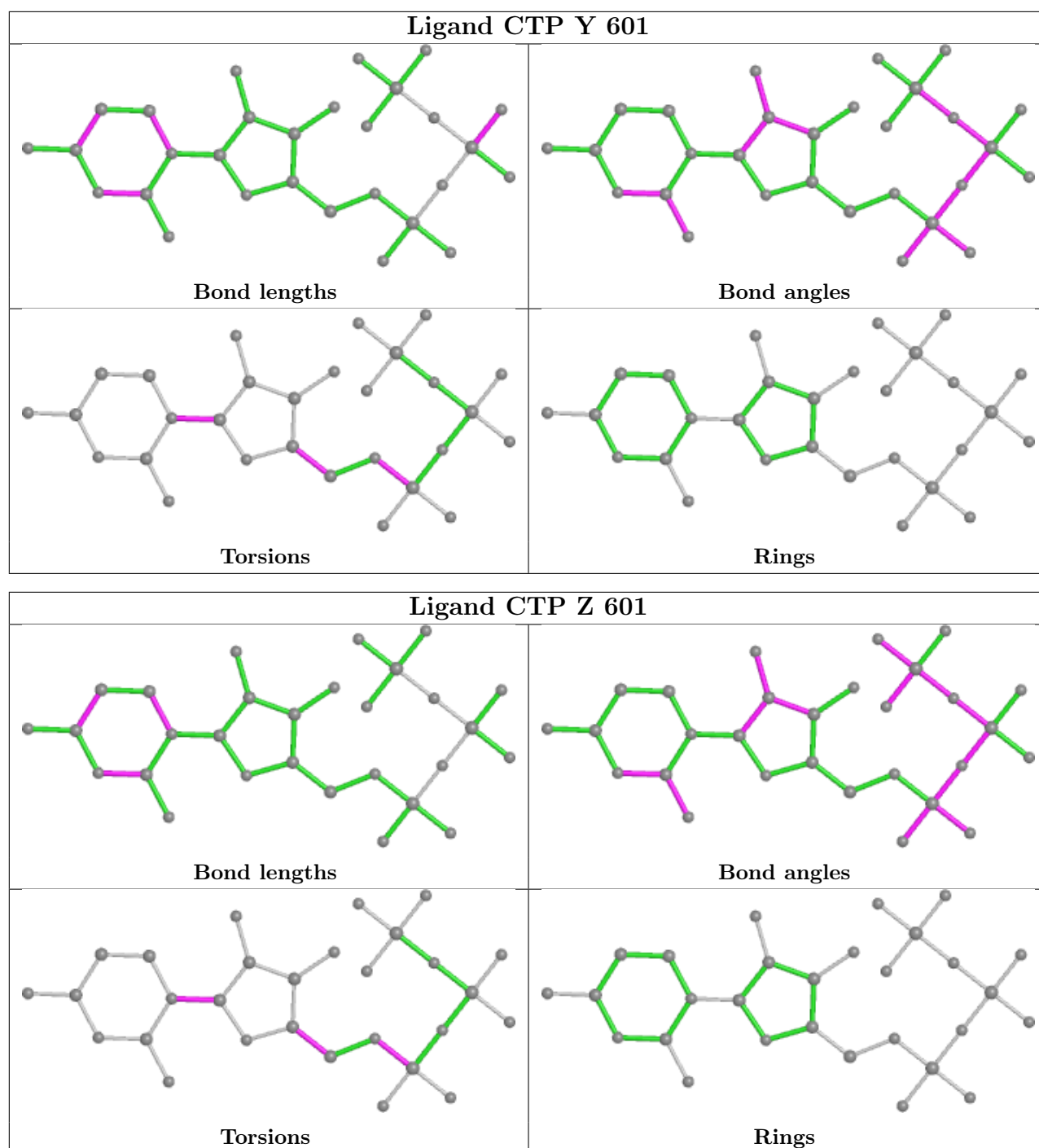

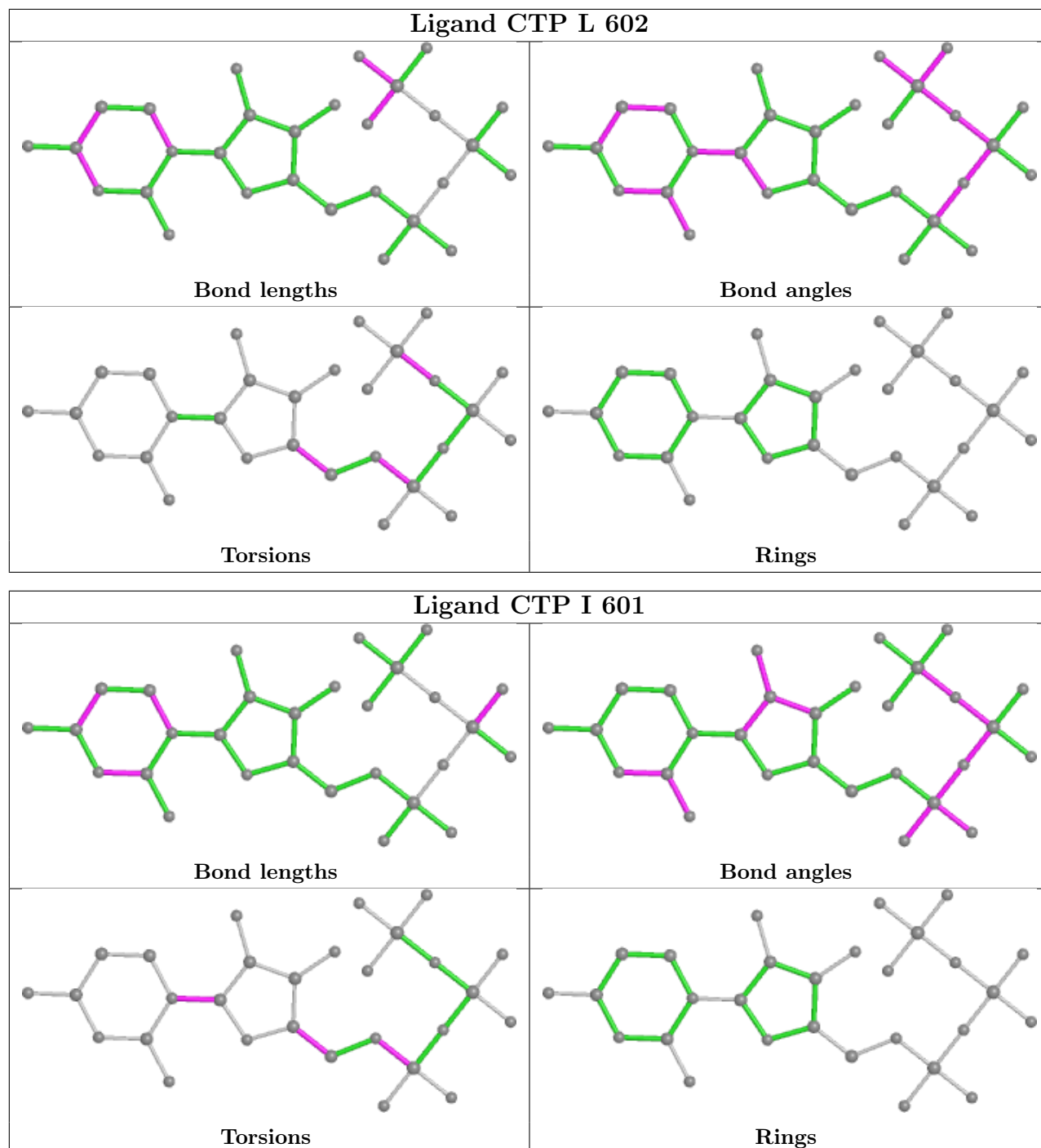

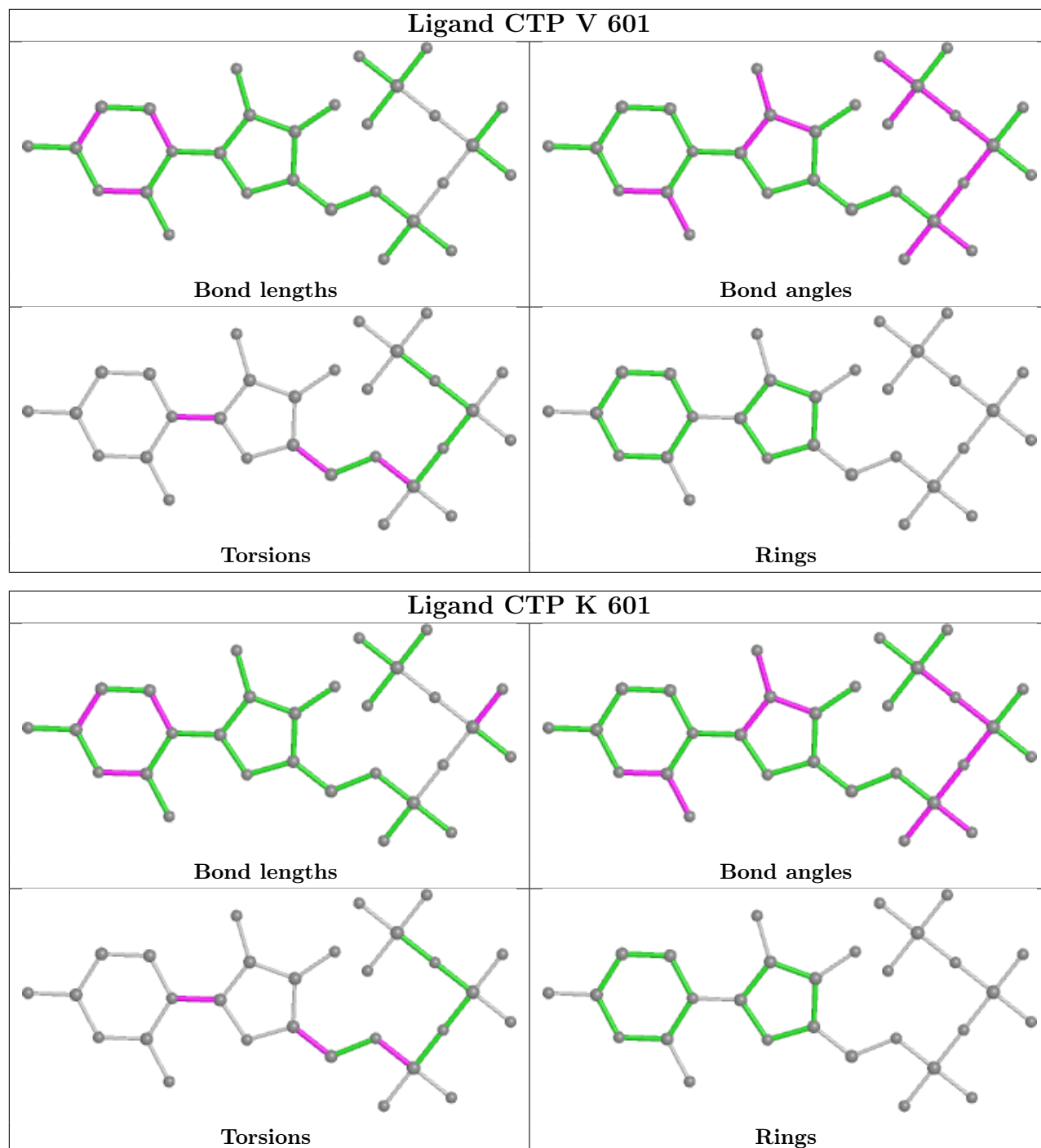

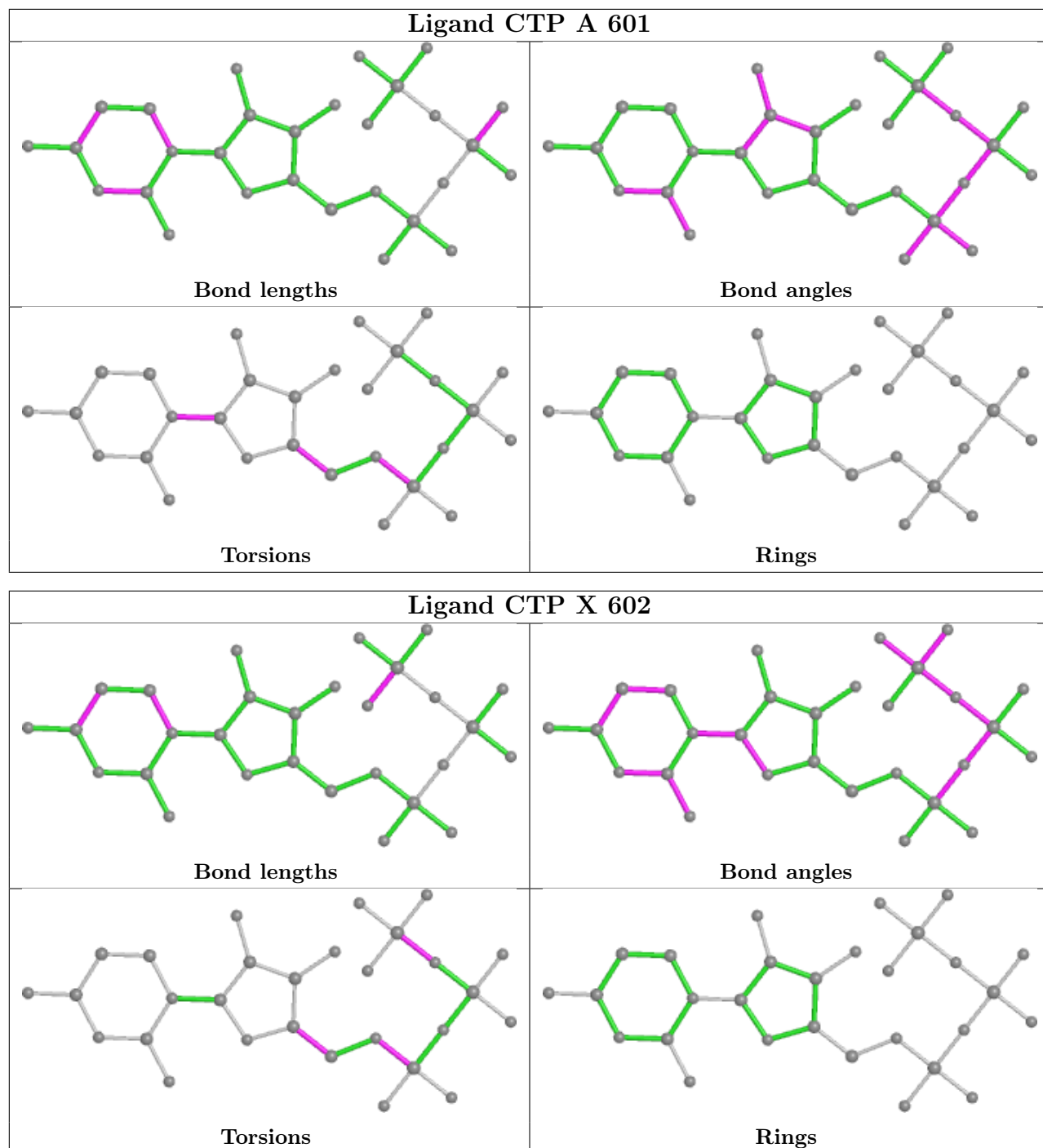

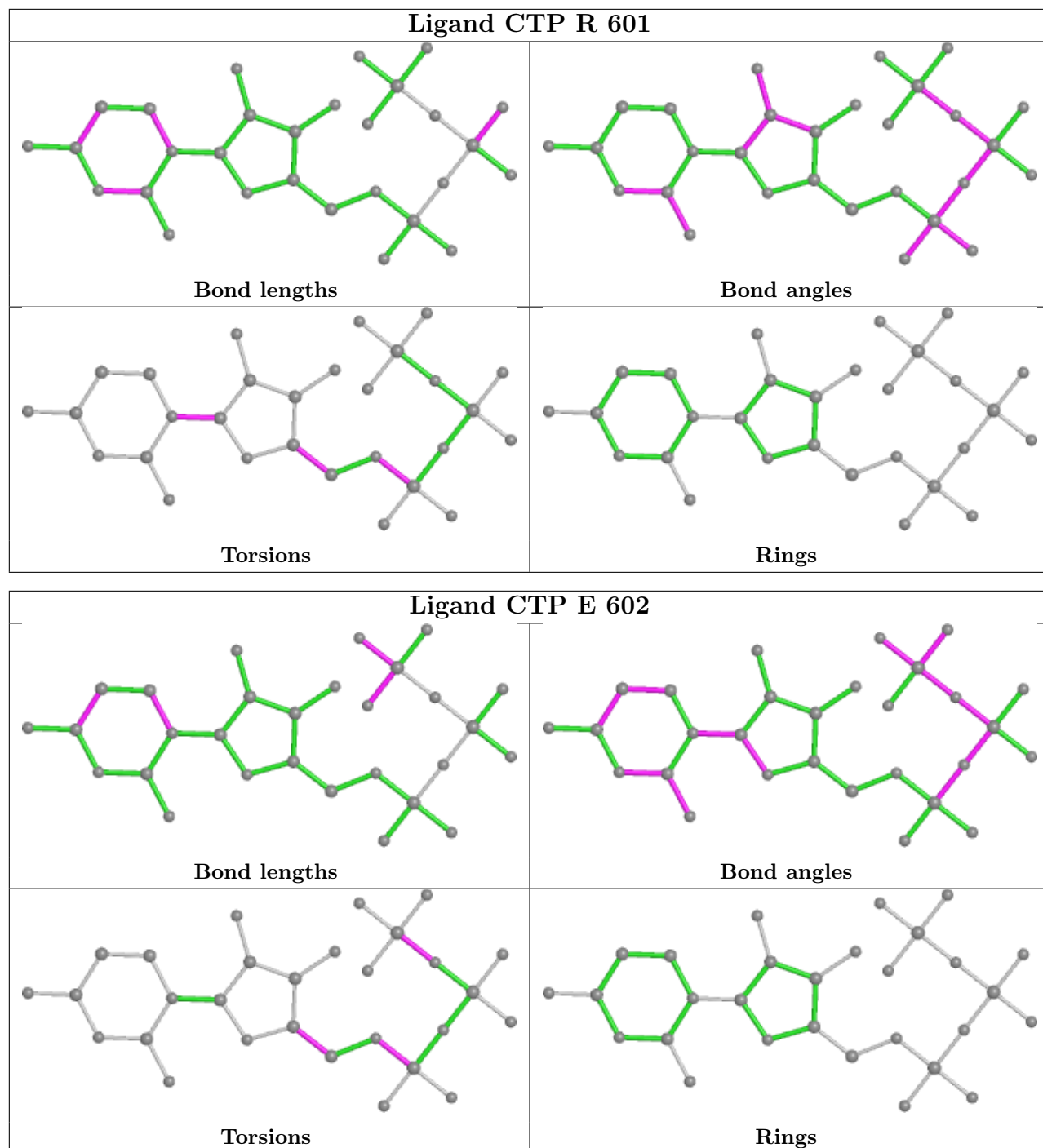

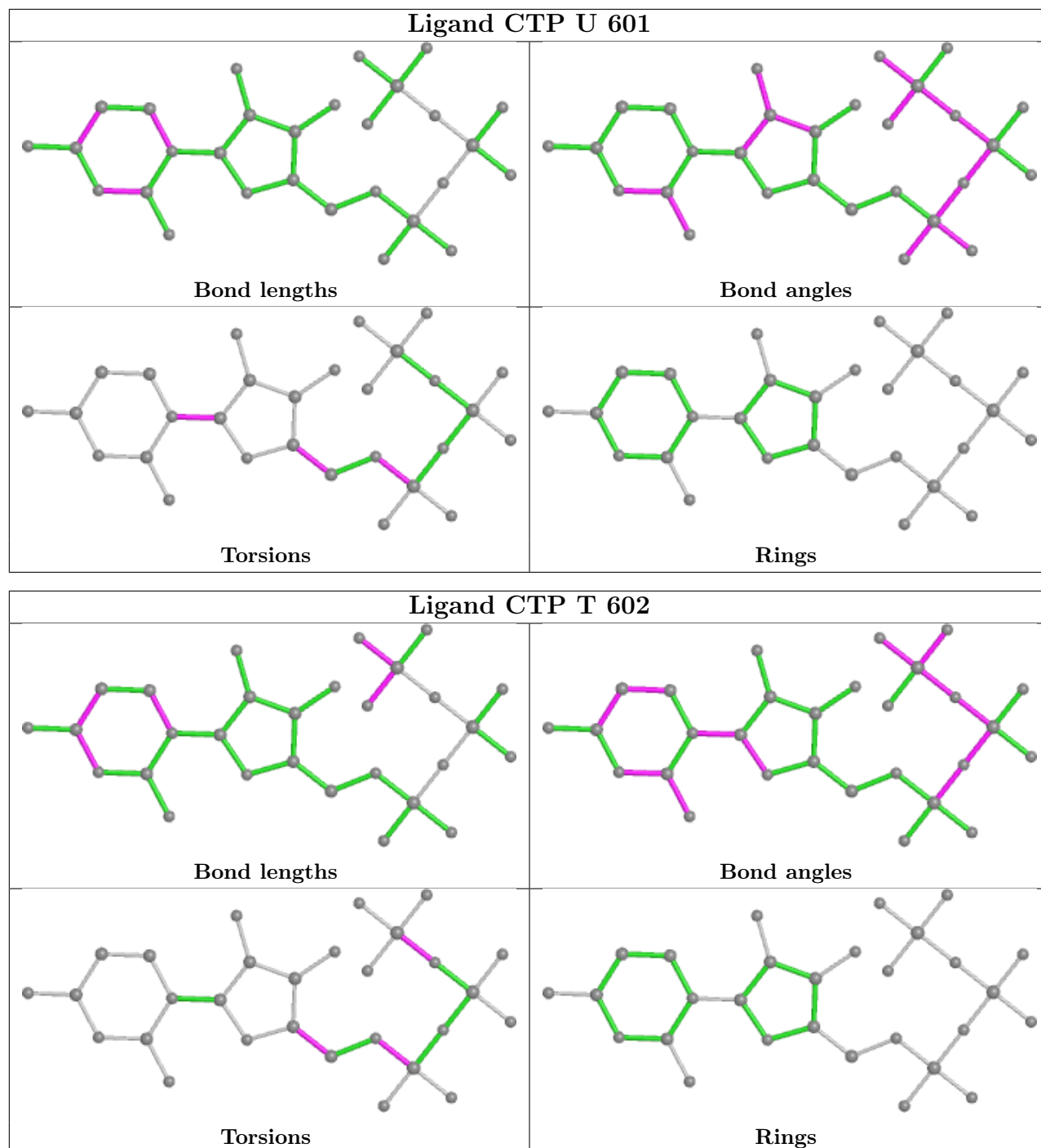

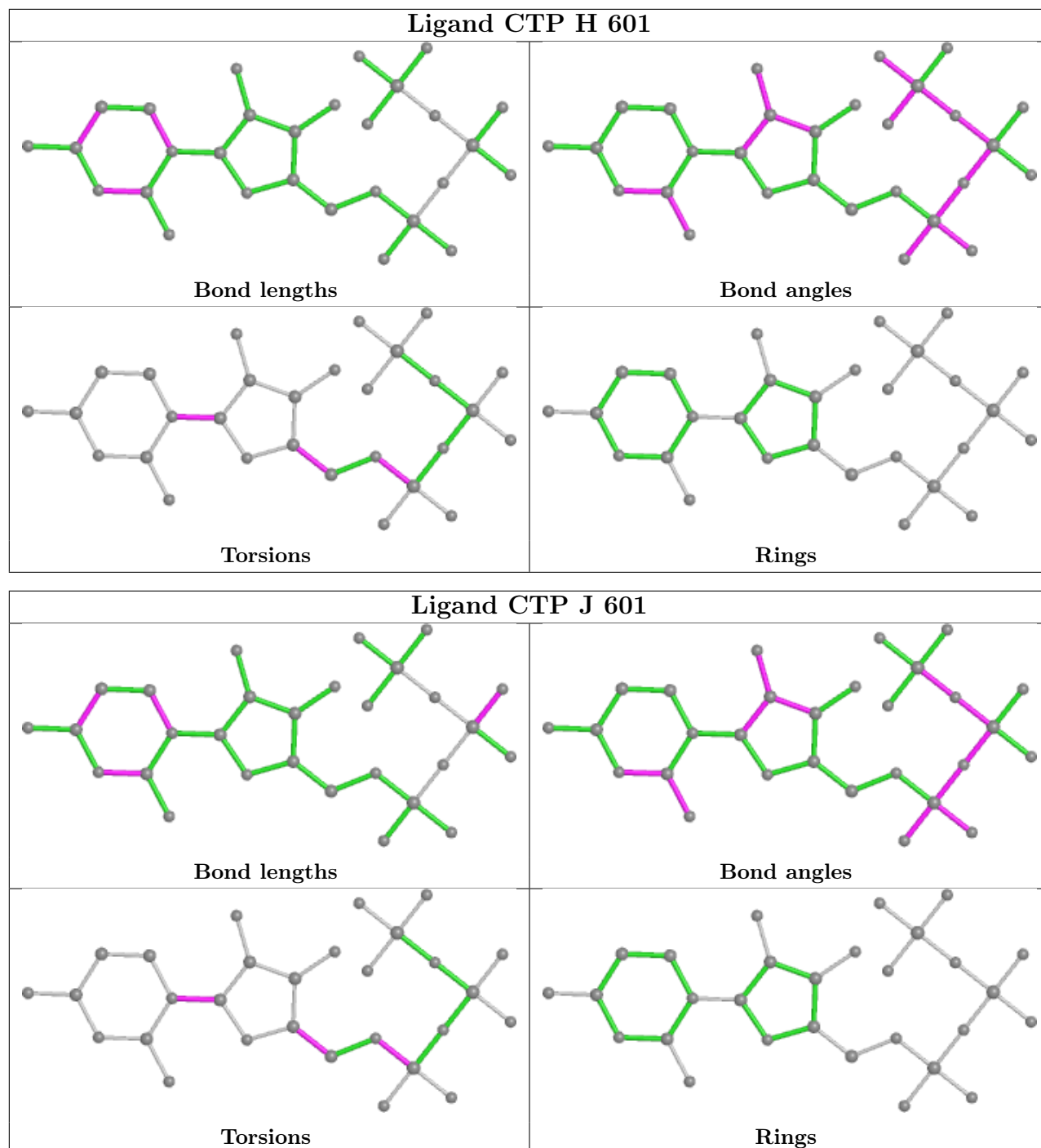

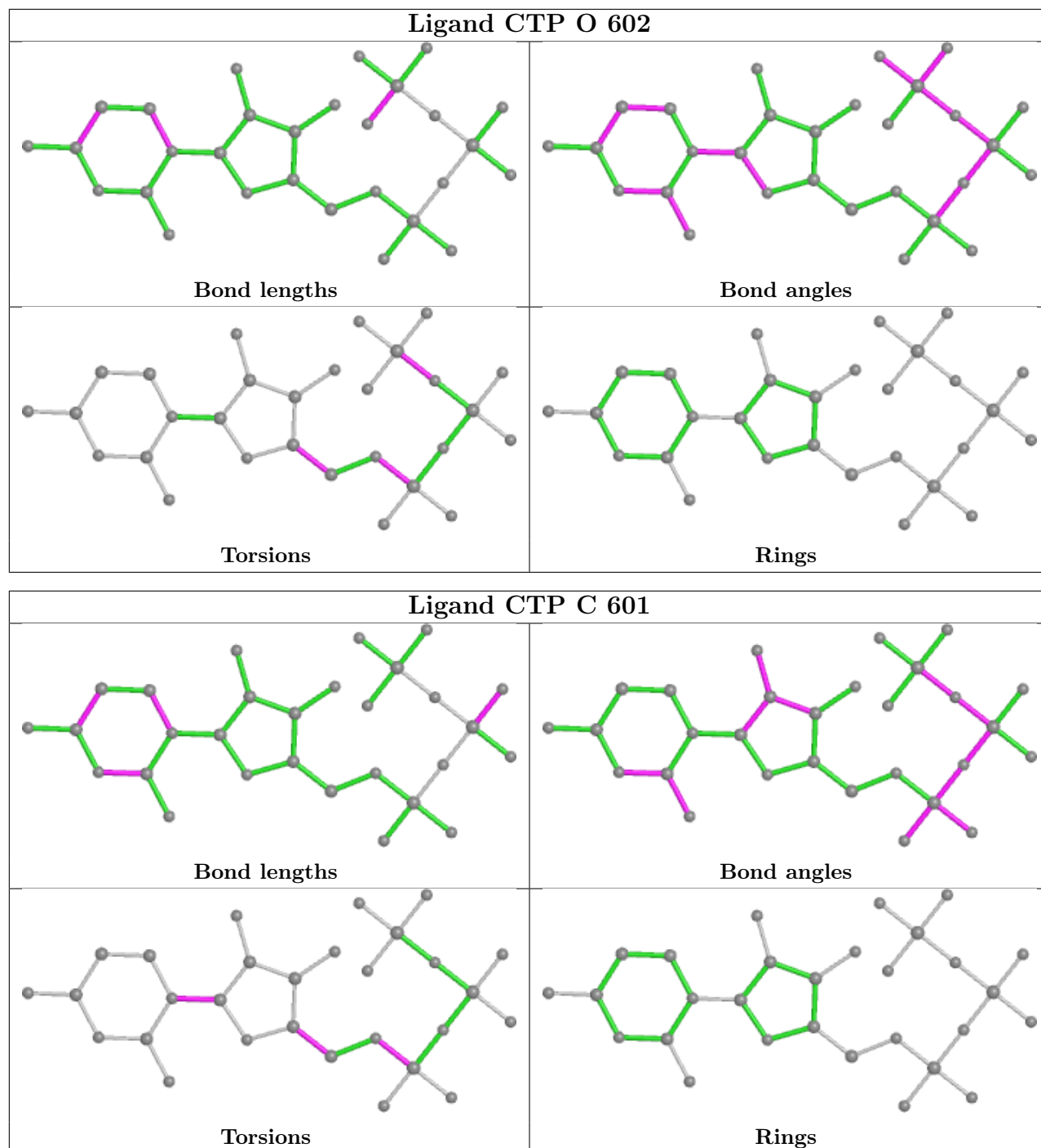

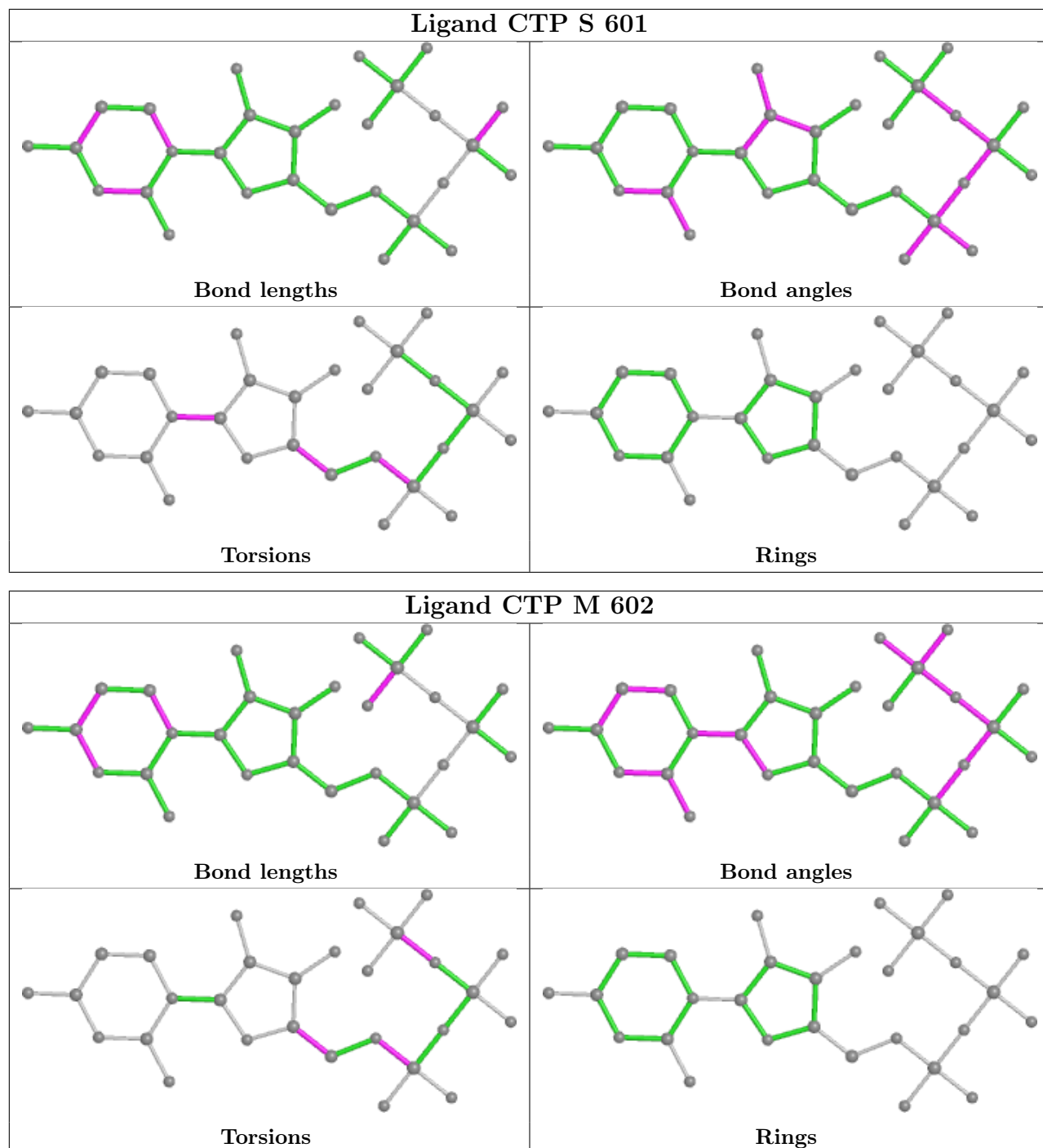

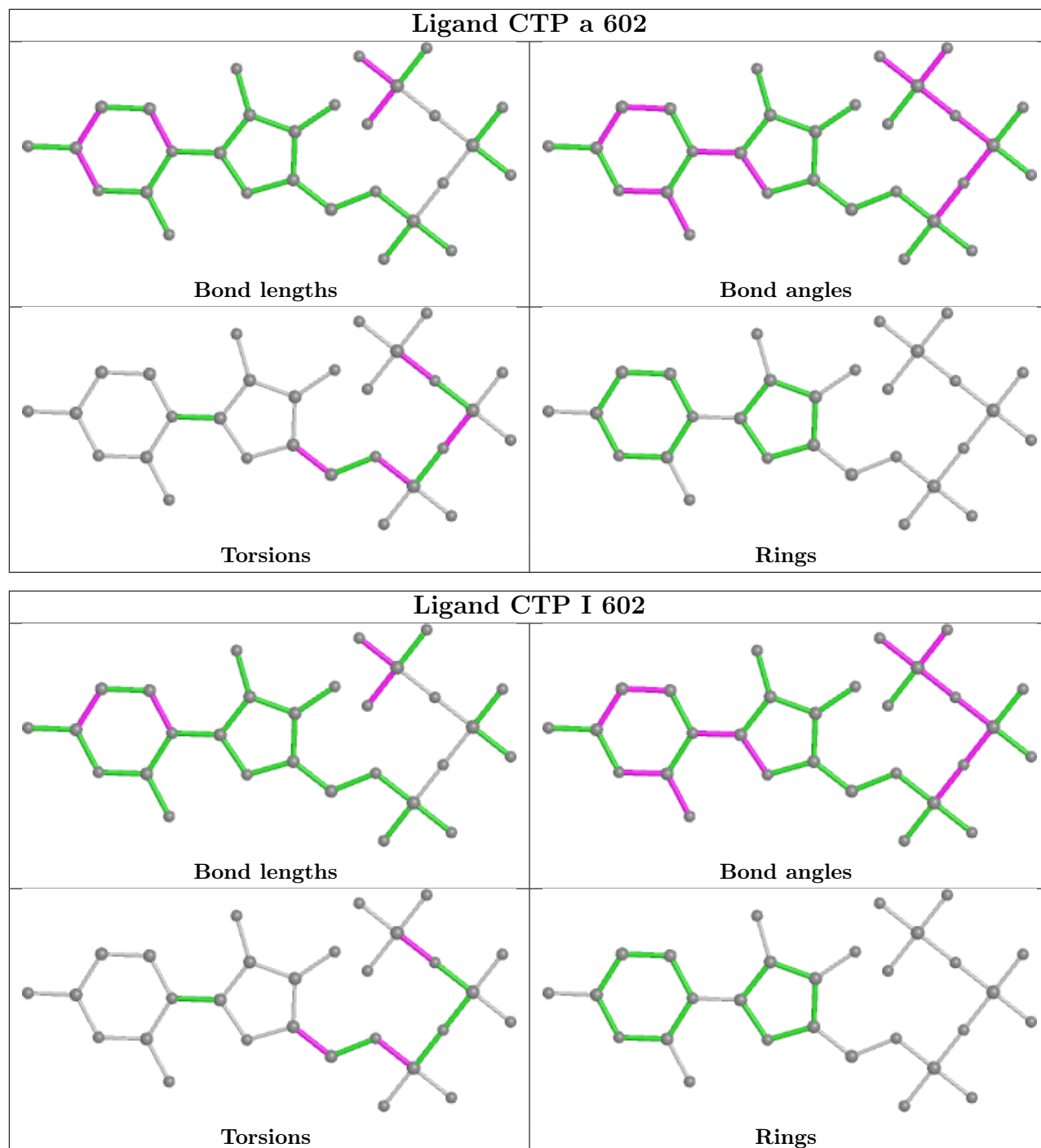

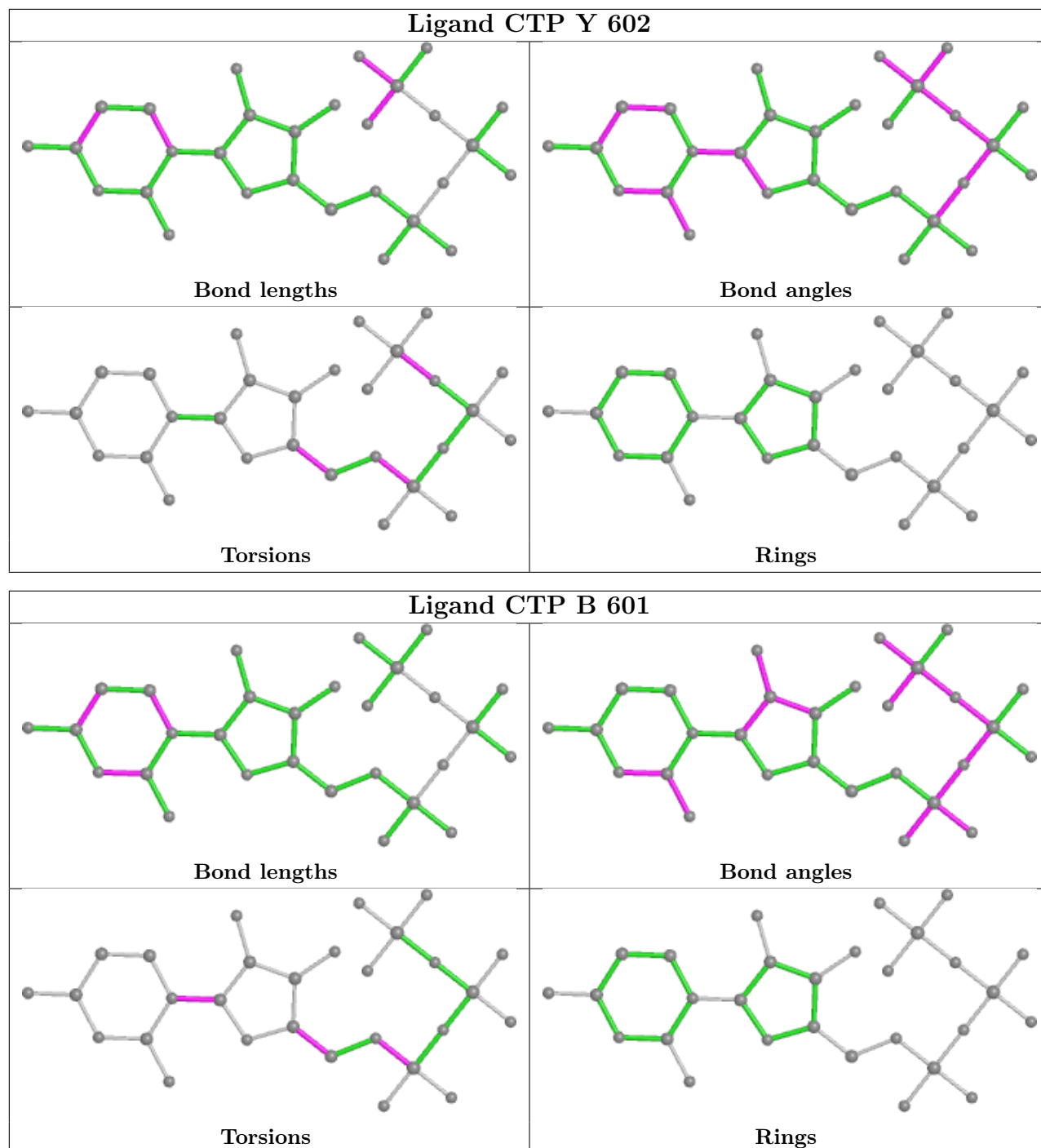

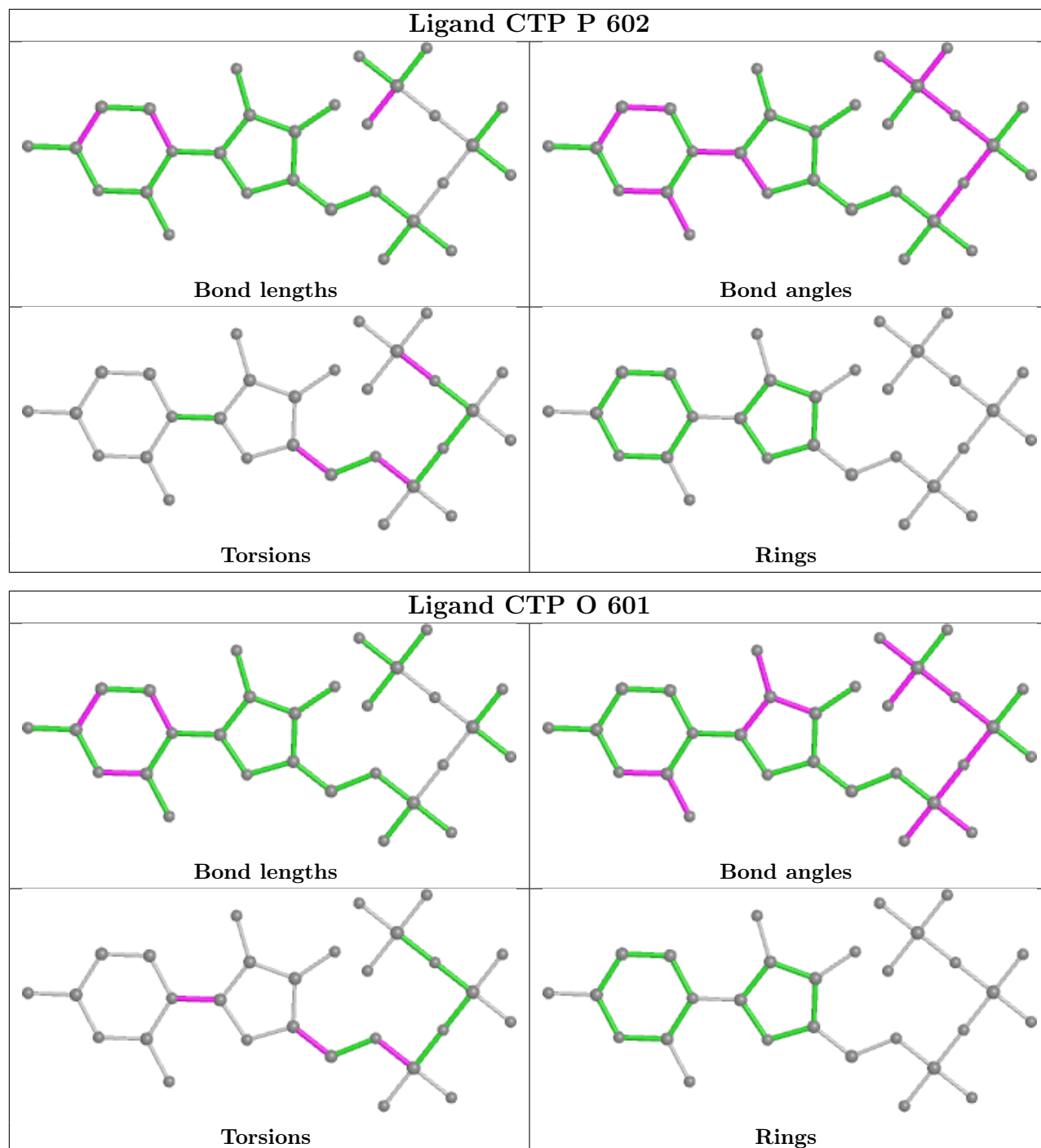

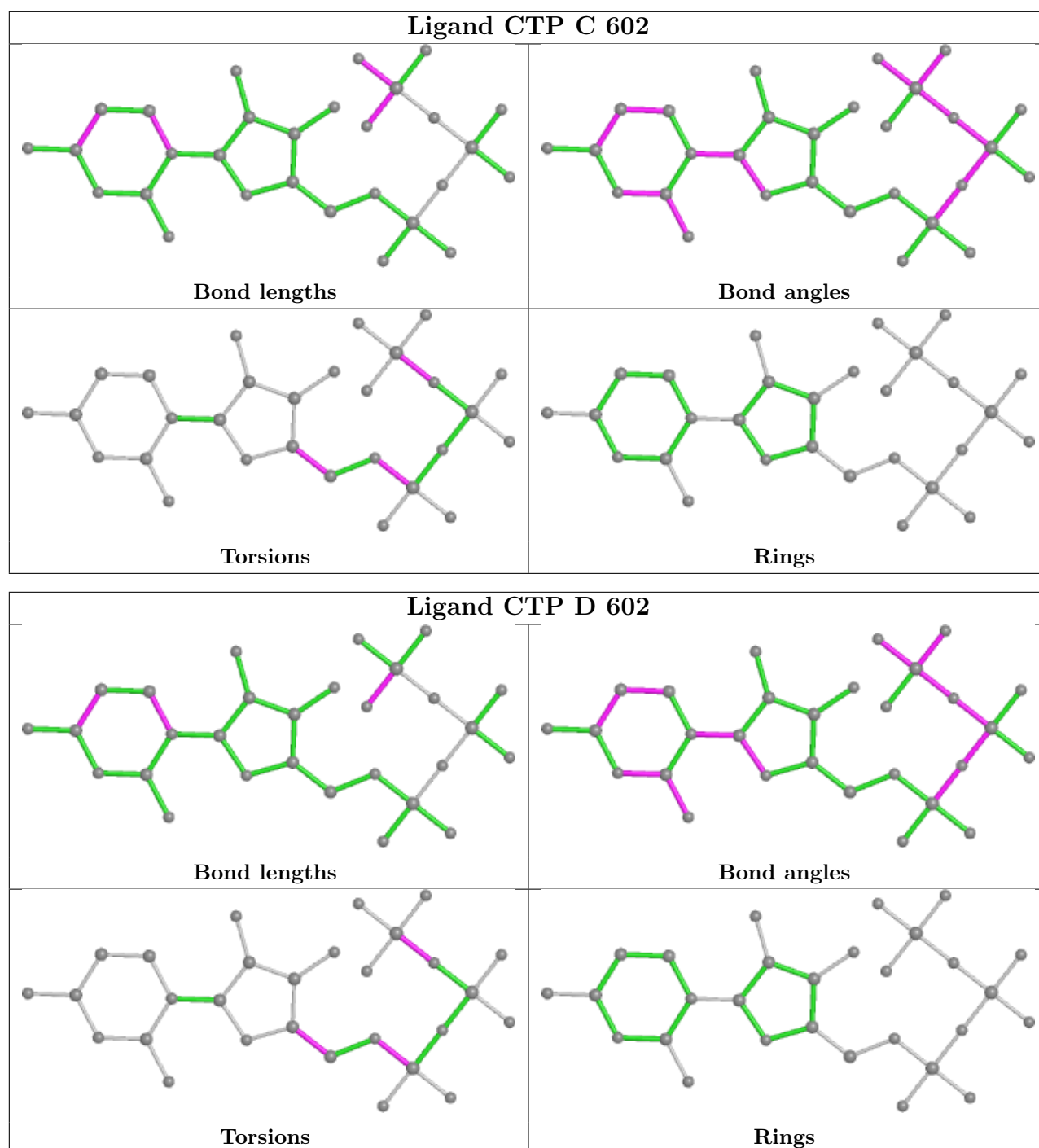

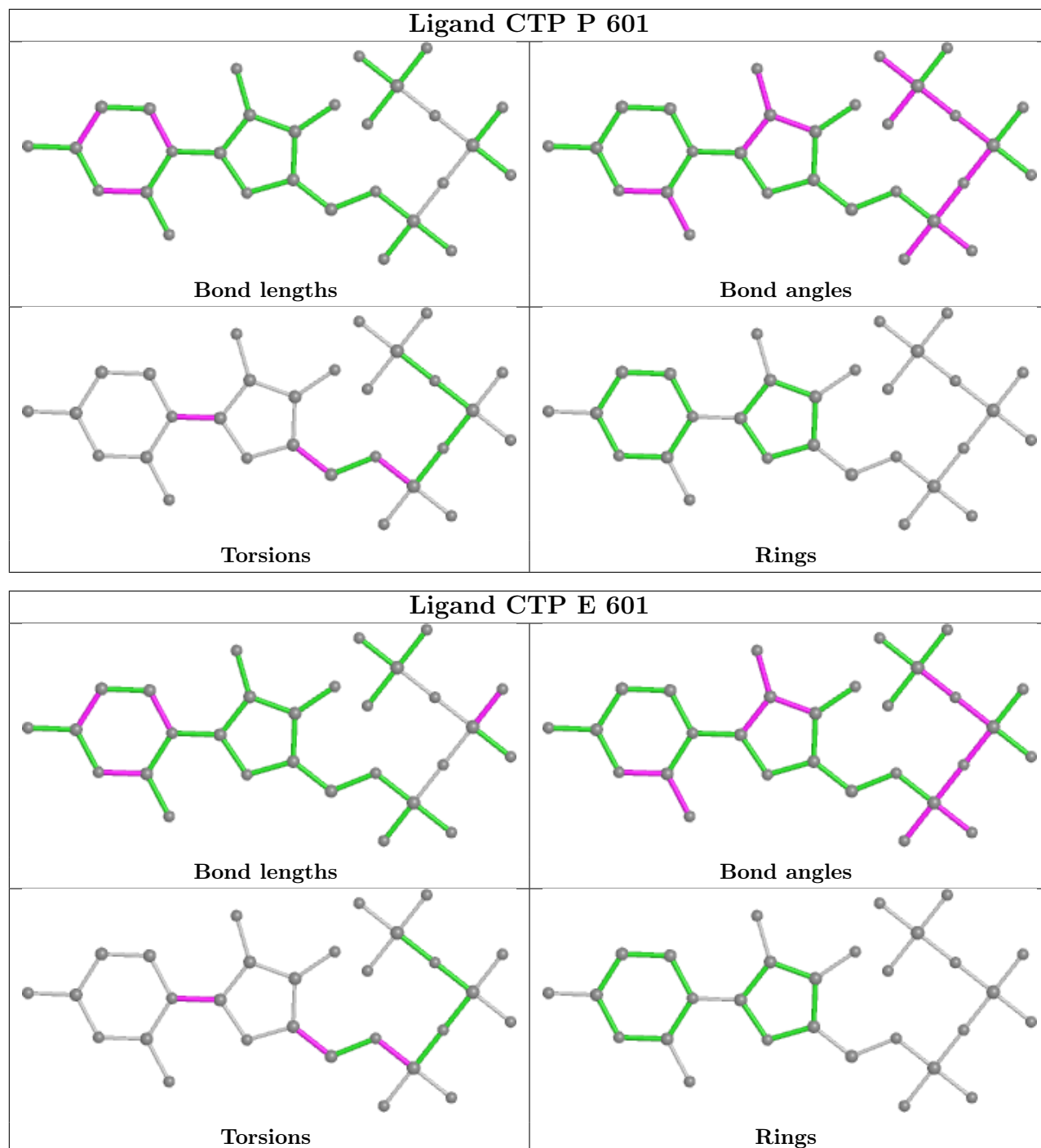

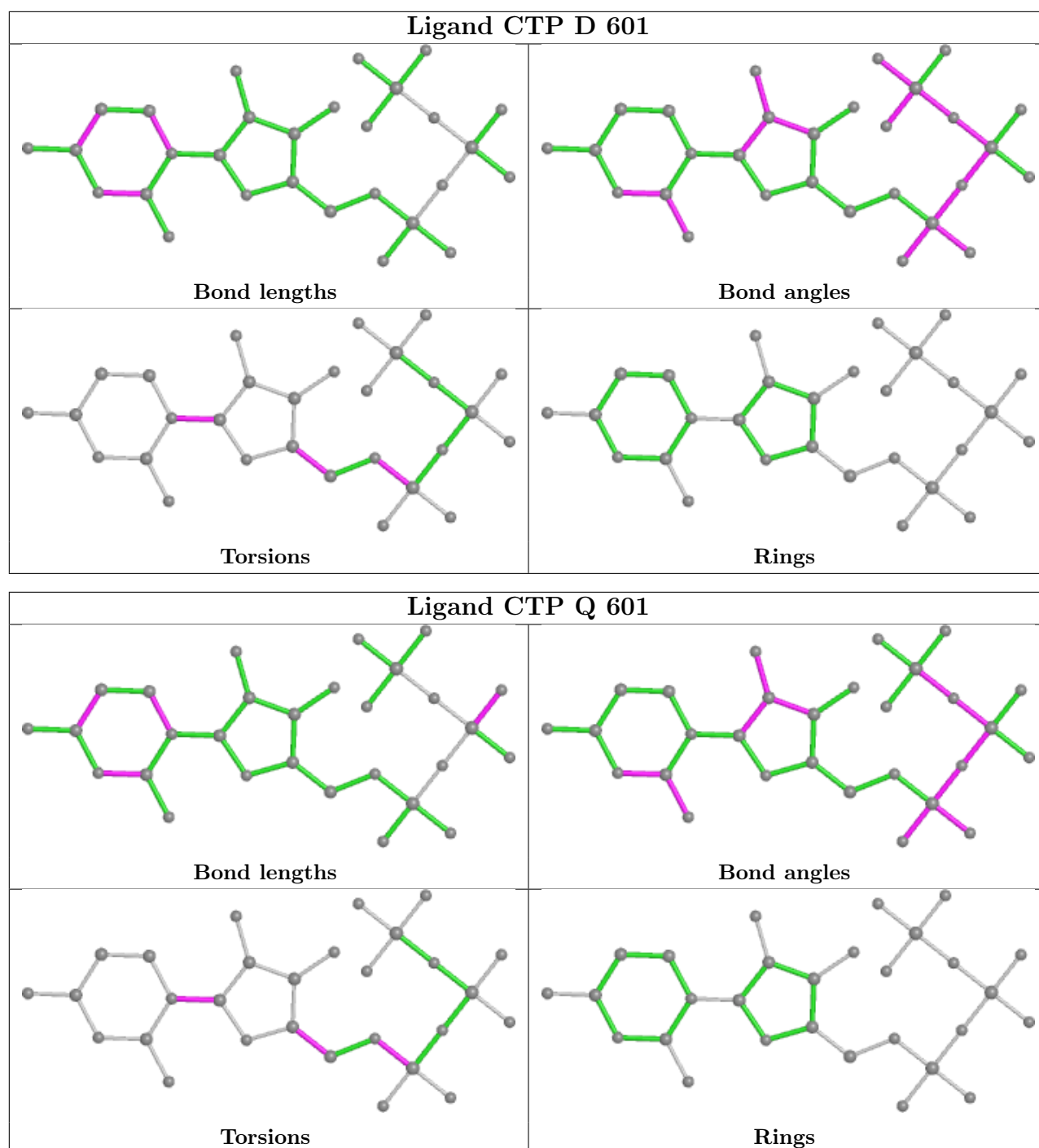

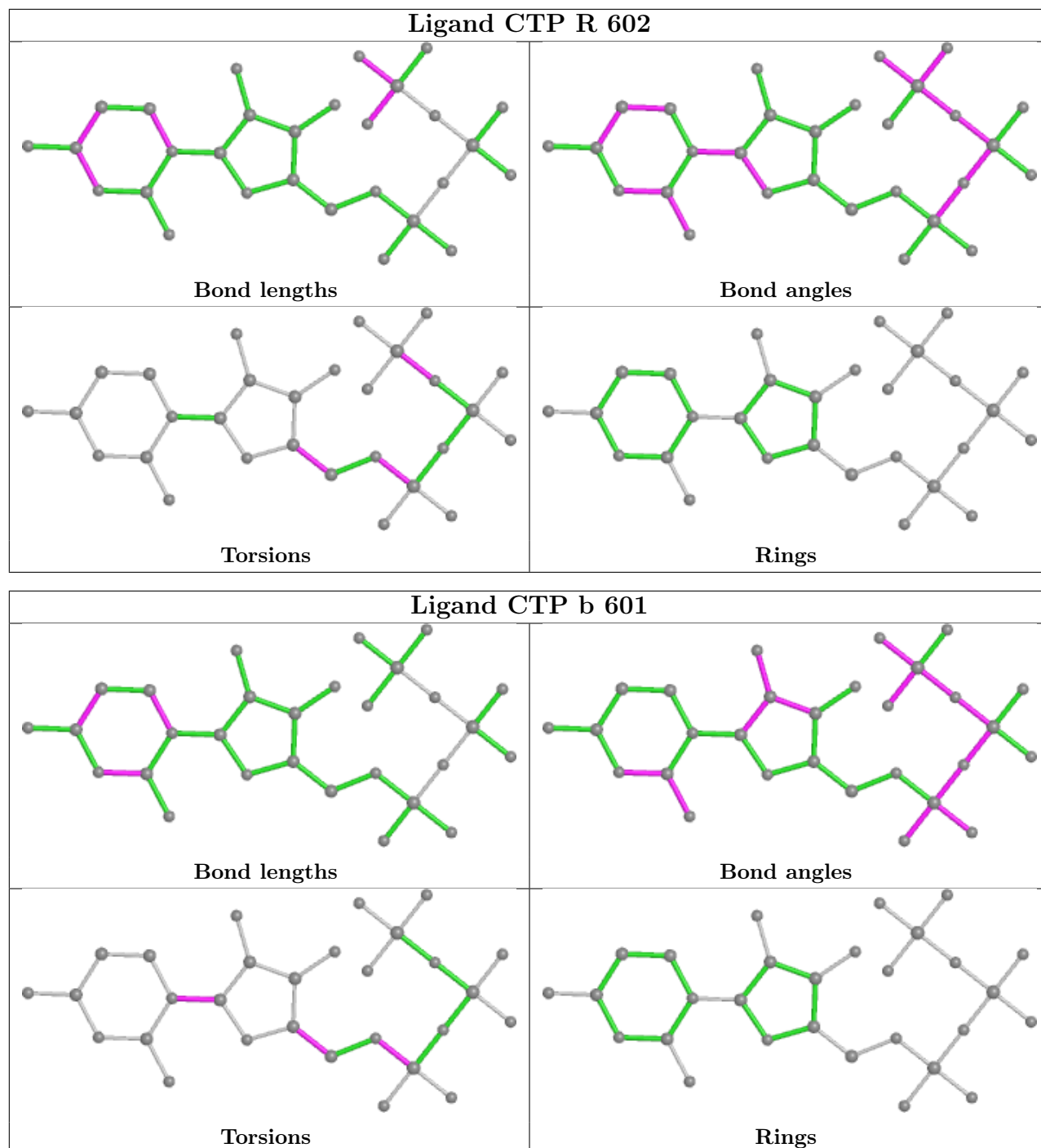

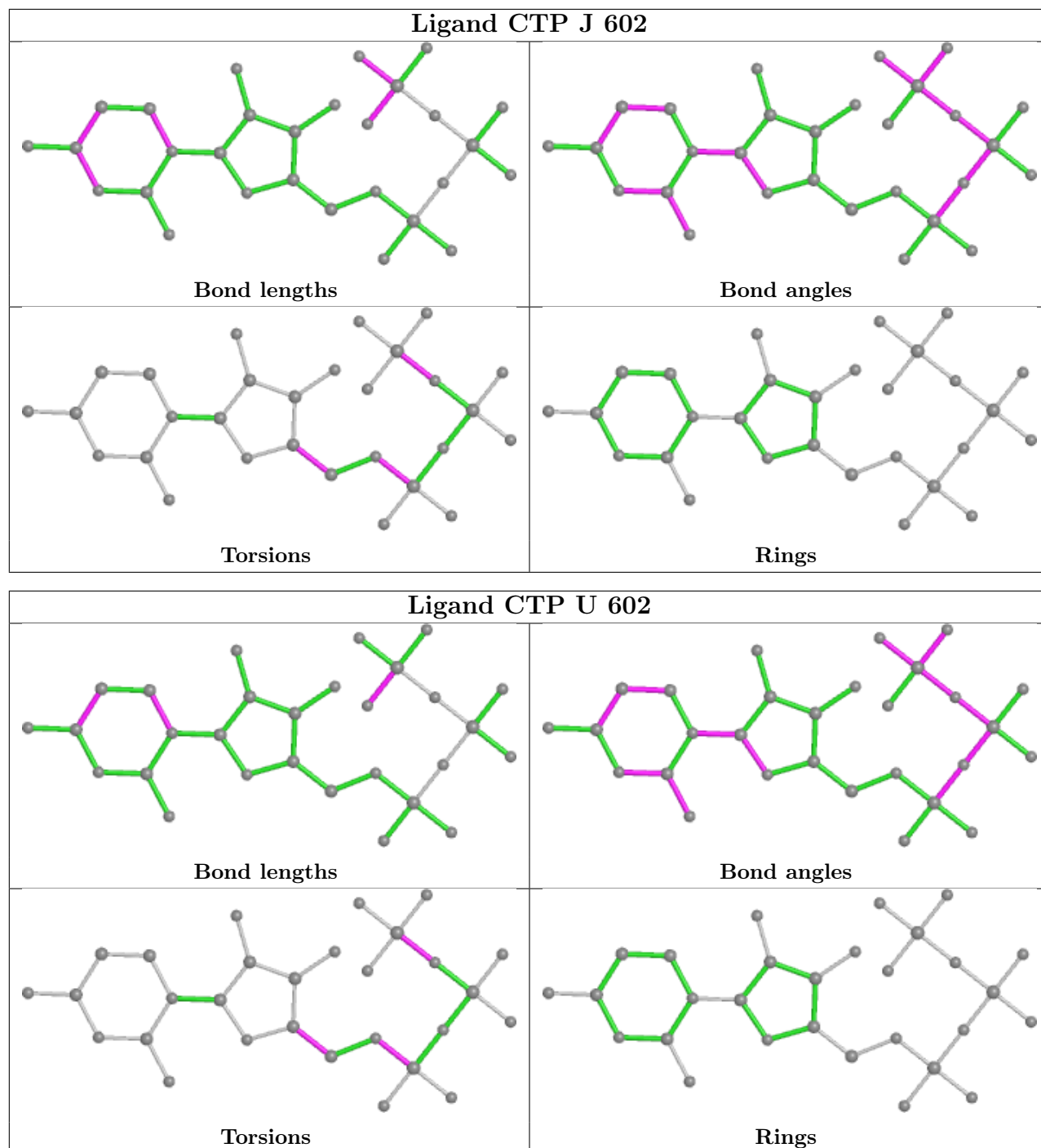

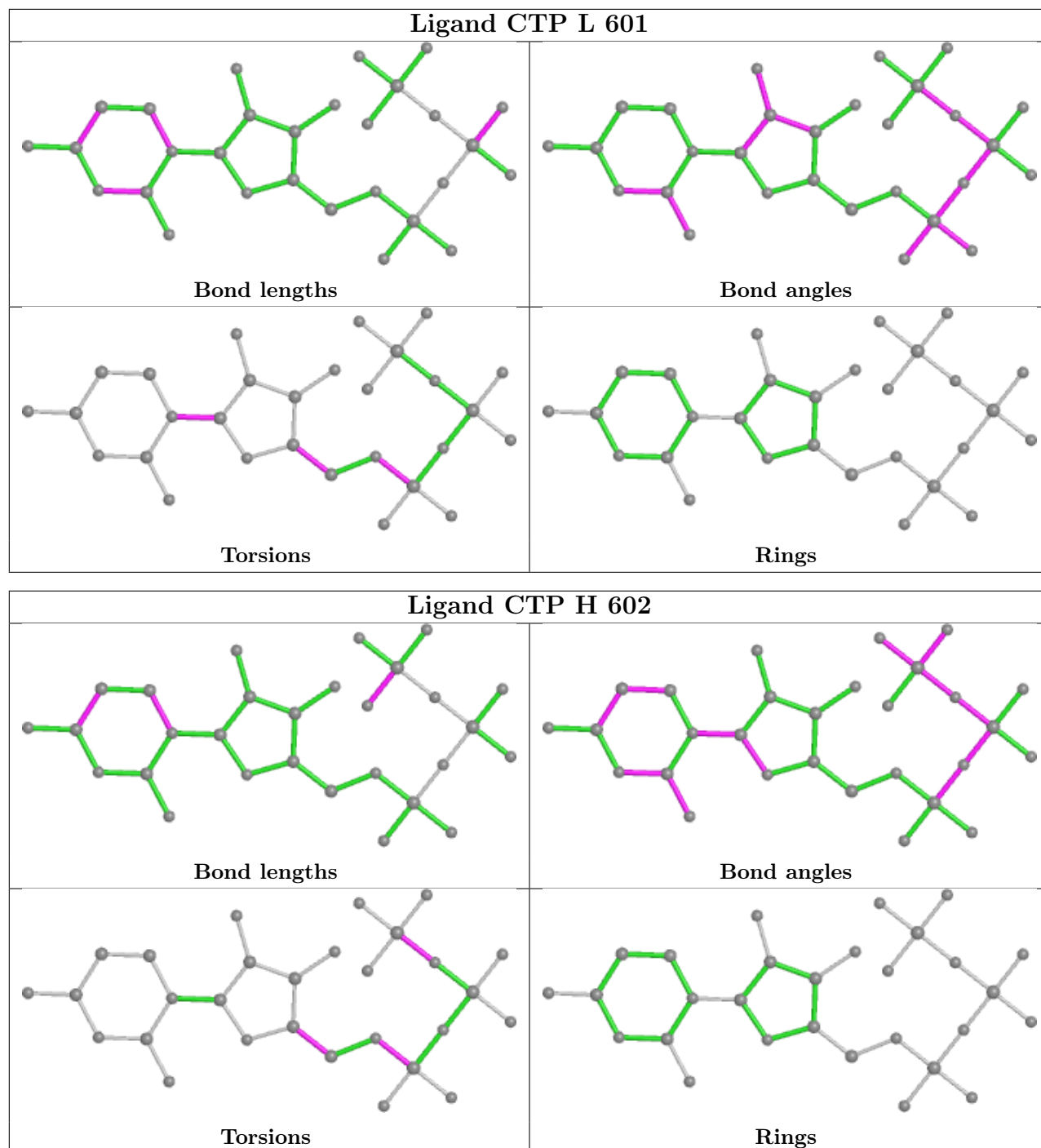

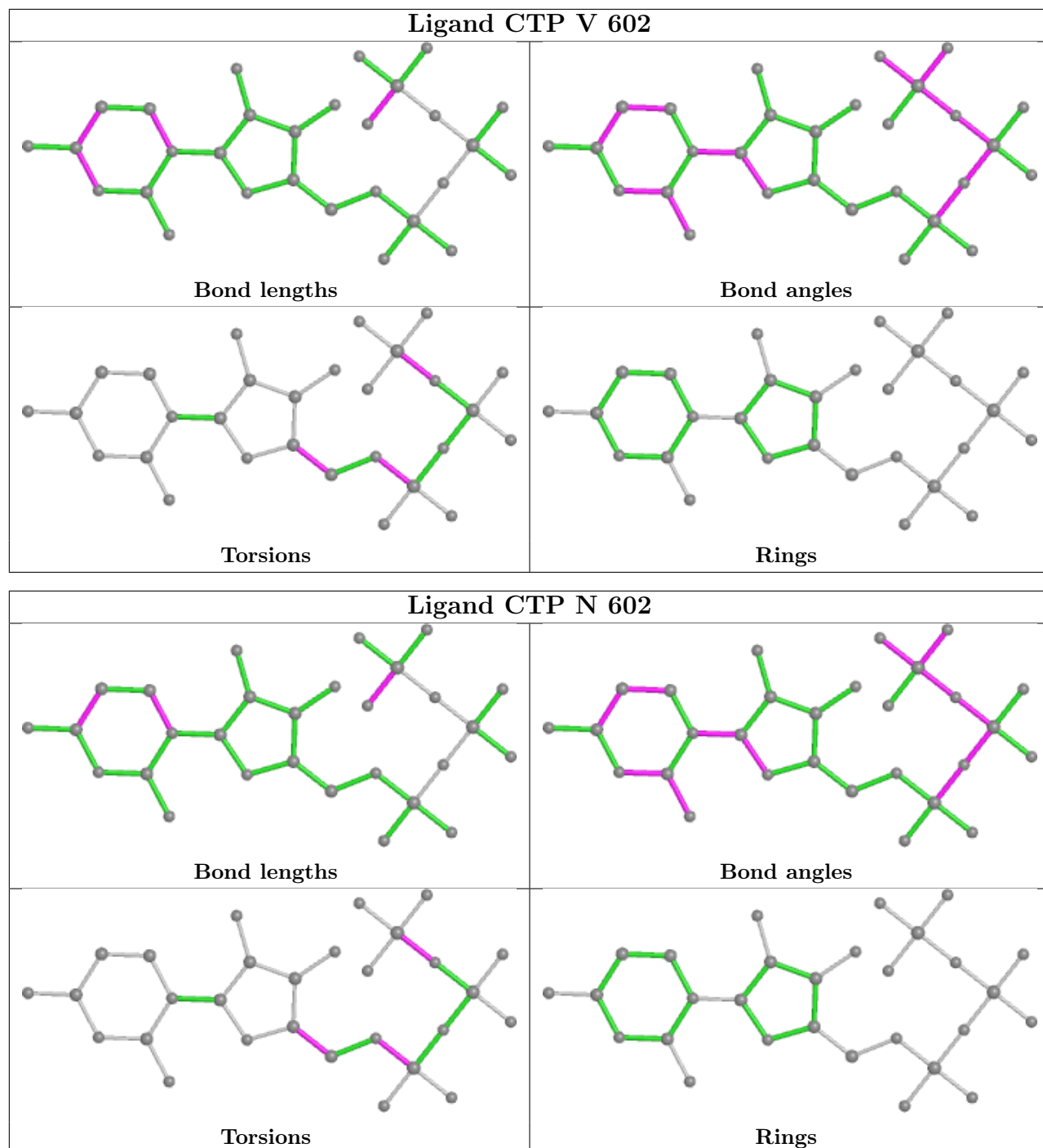

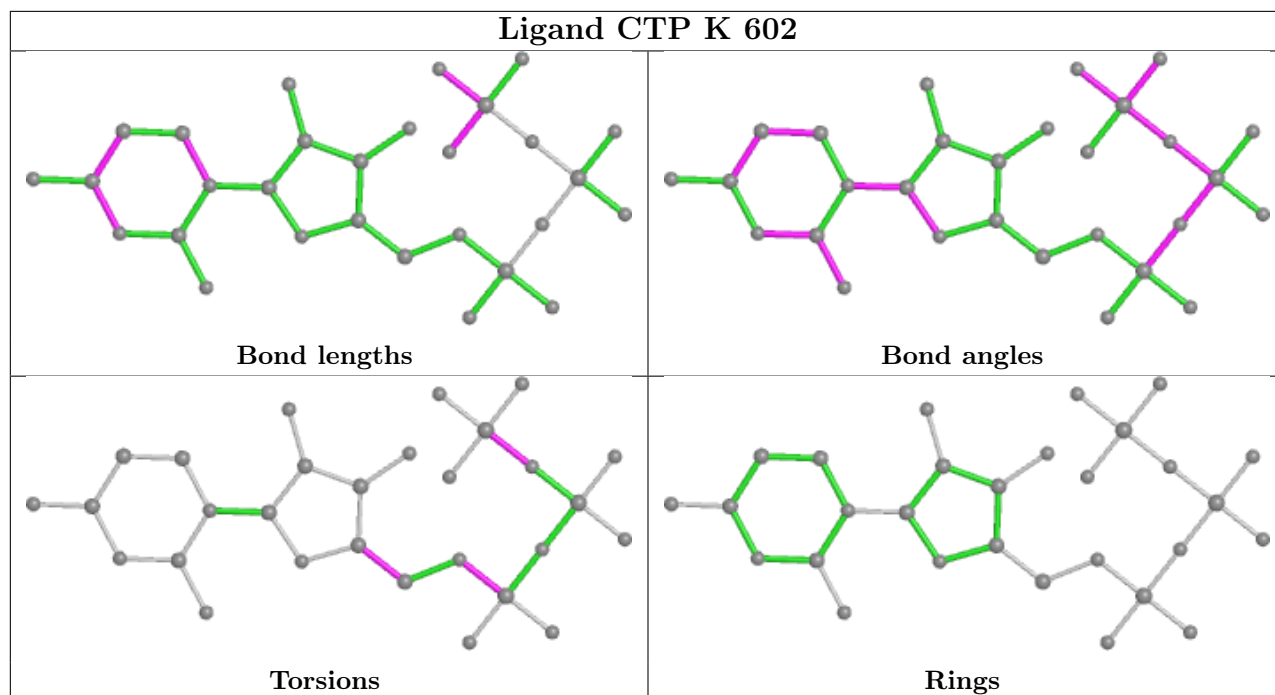

5.7 Other polymers [\(i\)](#)

There are no such residues in this entry.

5.8 Polymer linkage issues [\(i\)](#)

The following chains have linkage breaks:

Mol	Chain	Number of breaks
1	D	3
1	A	3
1	B	3
1	C	3
1	U	3
1	I	3
1	M	3
1	Q	3
1	V	3
1	J	3
1	N	3
1	R	3
1	H	3
1	E	3
1	F	3
1	G	3

Continued on next page...

Continued from previous page...

Mol	Chain	Number of breaks
1	W	3
1	K	3
1	O	3
1	S	3
1	b	3
1	Y	3
1	Z	3
1	a	3
1	X	3
1	L	3
1	P	3
1	T	3

The worst 5 of 84 chain breaks are listed below:

Model	Chain	Residue-1	Atom-1	Residue-2	Atom-2	Distance (Å)
1	D	299:GLU	C	302:GLU	N	6.39
1	A	299:GLU	C	302:GLU	N	6.39
1	B	299:GLU	C	302:GLU	N	6.39
1	C	299:GLU	C	302:GLU	N	6.39
1	U	299:GLU	C	302:GLU	N	6.39

6 Map visualisation [i](#)

This section contains visualisations of the EMDB entry EMD-24576. These allow visual inspection of the internal detail of the map and identification of artifacts.

No raw map or half-maps were deposited for this entry and therefore no images, graphs, etc. pertaining to the raw map can be shown.

6.1 Orthogonal projections [i](#)

6.1.1 Primary map

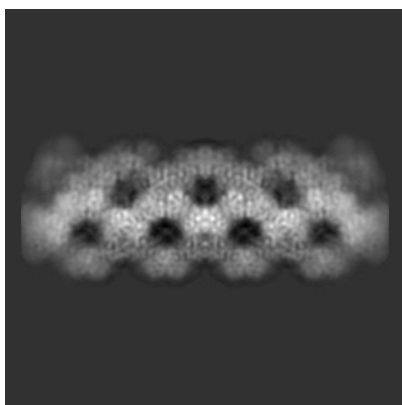

X

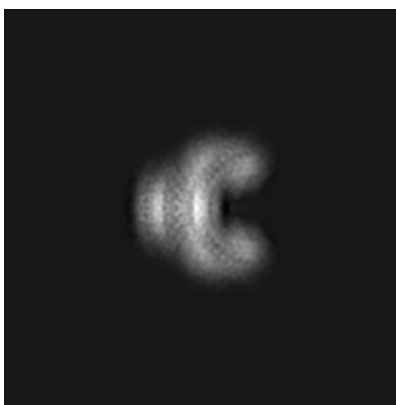

Y

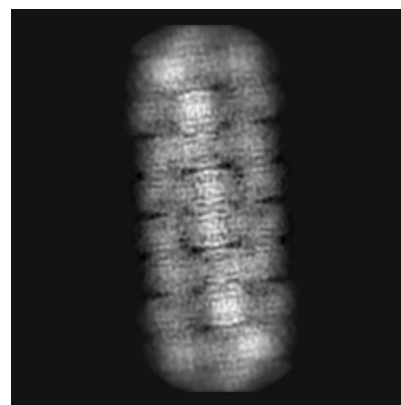

Z

The images above show the map projected in three orthogonal directions.

6.2 Central slices [i](#)

6.2.1 Primary map

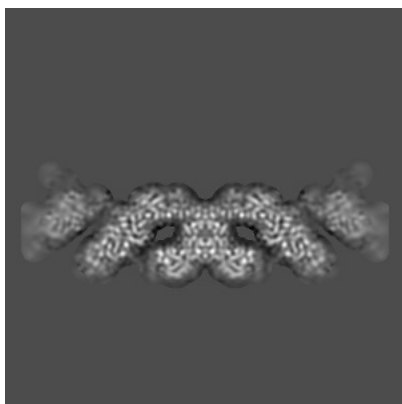

X Index: 256

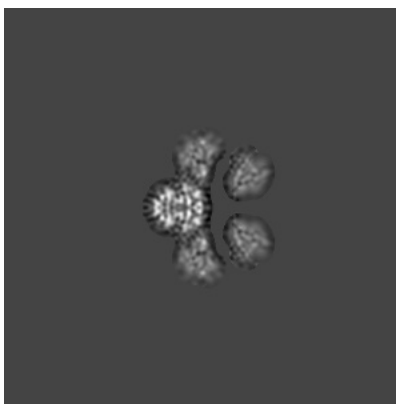

Y Index: 256

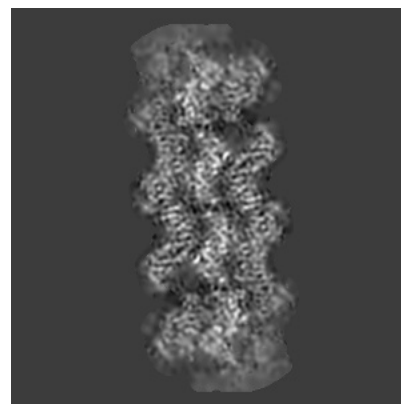

Z Index: 256

The images above show central slices of the map in three orthogonal directions.

6.3 Largest variance slices [\(i\)](#)

6.3.1 Primary map

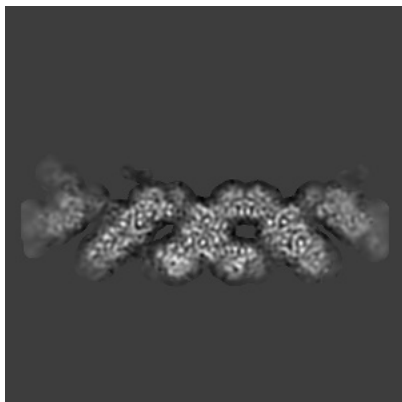

X Index: 252

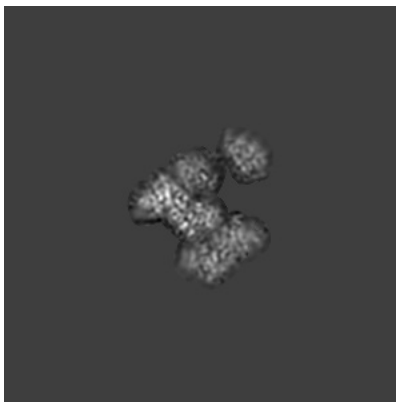

Y Index: 278

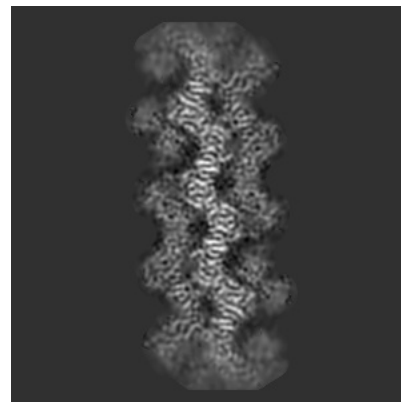

Z Index: 247

The images above show the largest variance slices of the map in three orthogonal directions.

6.4 Orthogonal standard-deviation projections (False-color) [\(i\)](#)

6.4.1 Primary map

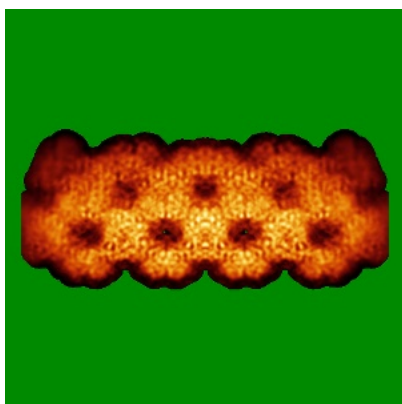

X

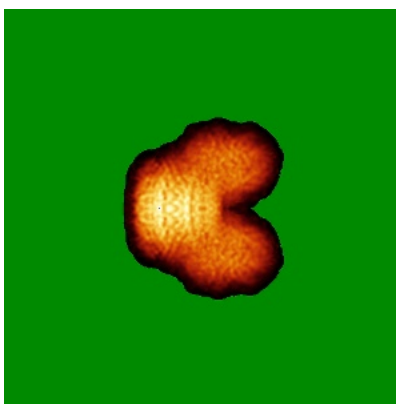

Y

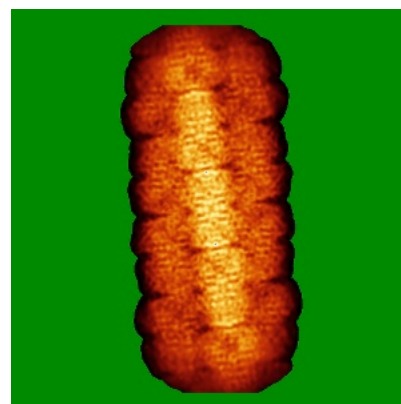

Z

The images above show the map standard deviation projections with false color in three orthogonal directions. Minimum values are shown in green, max in blue, and dark to light orange shades represent small to large values respectively.

6.5 Orthogonal surface views [i](#)

6.5.1 Primary map



The images above show the 3D surface view of the map at the recommended contour level 0.3. These images, in conjunction with the slice images, may facilitate assessment of whether an appropriate contour level has been provided.

6.6 Mask visualisation [i](#)

This section was not generated. No masks/segmentation were deposited.

7 Map analysis [i](#)

This section contains the results of statistical analysis of the map.

7.1 Map-value distribution [i](#)

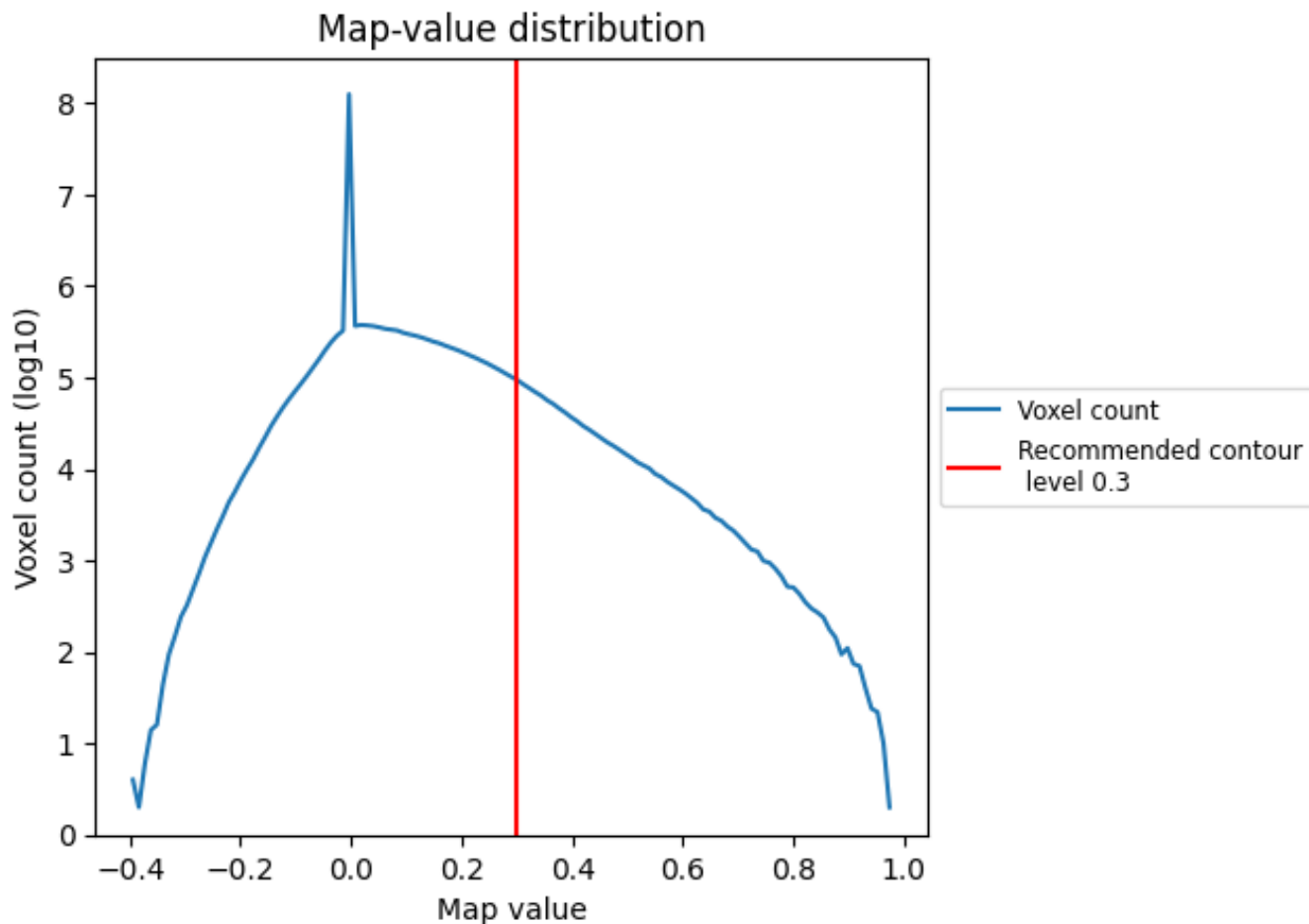

The map-value distribution is plotted in 128 intervals along the x-axis. The y-axis is logarithmic. A spike in this graph at zero usually indicates that the volume has been masked.

7.2 Volume estimate [\(i\)](#)

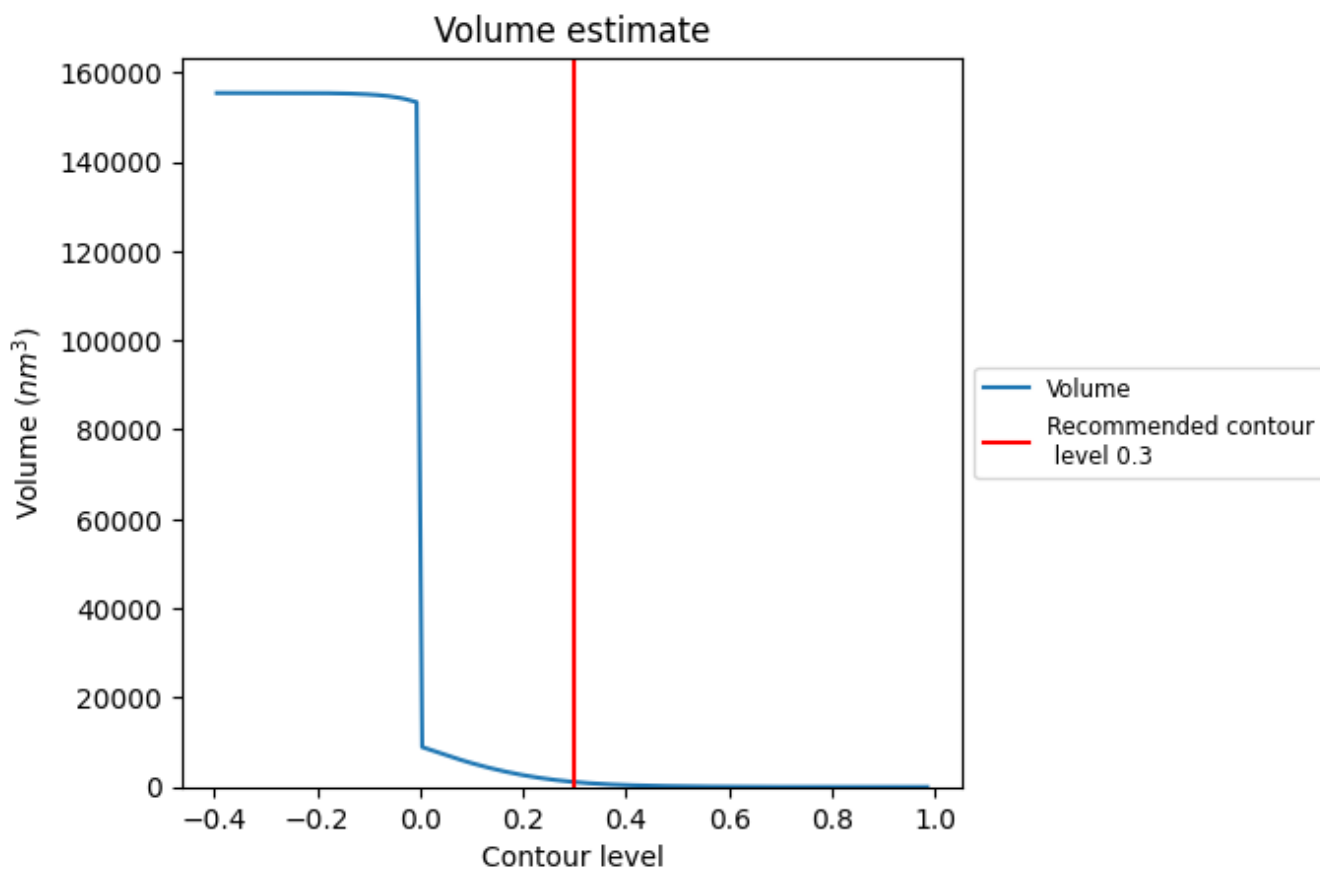

The volume at the recommended contour level is 1107 nm³; this corresponds to an approximate mass of 1000 kDa.

The volume estimate graph shows how the enclosed volume varies with the contour level. The recommended contour level is shown as a vertical line and the intersection between the line and the curve gives the volume of the enclosed surface at the given level.

7.3 Rotationally averaged power spectrum [i](#)

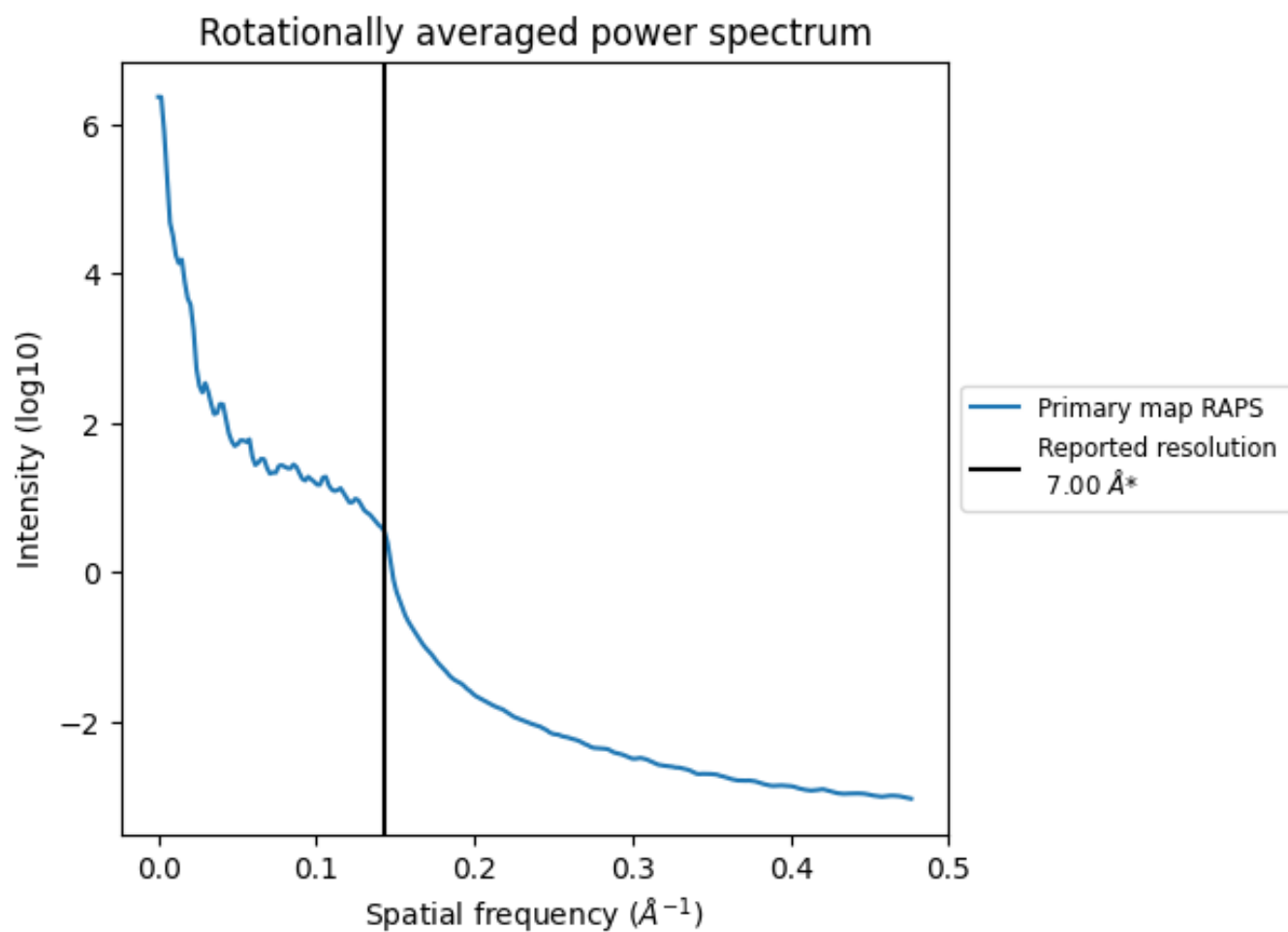

*Reported resolution corresponds to spatial frequency of 0.143\AA^{-1}

8 Fourier-Shell correlation

This section was not generated. No FSC curve or half-maps provided.

9 Map-model fit [i](#)

This section contains information regarding the fit between EMDB map EMD-24576 and PDB model 7RMO. Per-residue inclusion information can be found in section [3](#) on page [19](#).

9.1 Map-model overlay [i](#)

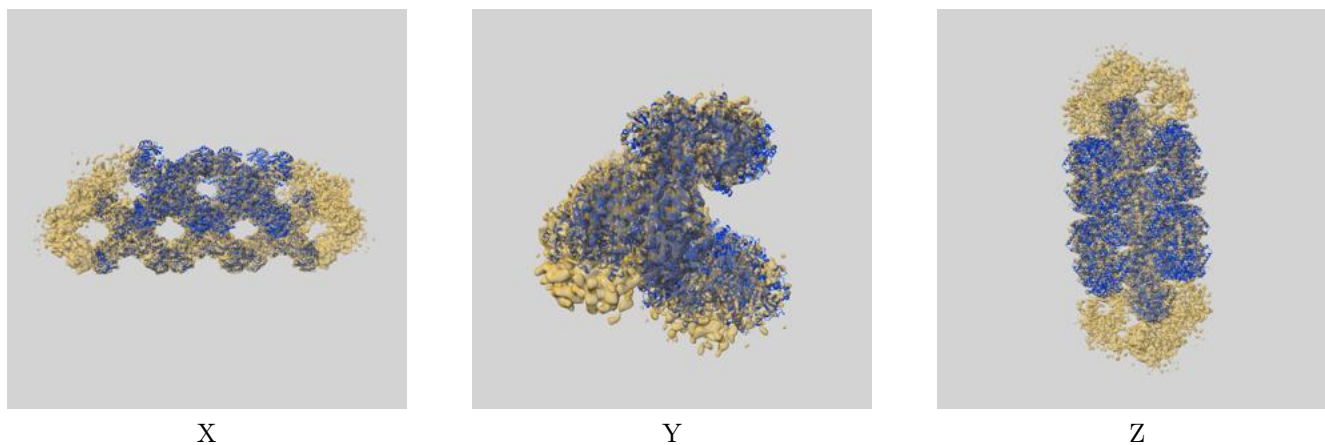

The images above show the 3D surface view of the map at the recommended contour level 0.3 at 50% transparency in yellow overlaid with a ribbon representation of the model coloured in blue. These images allow for the visual assessment of the quality of fit between the atomic model and the map.

9.2 Q-score mapped to coordinate model [i](#)

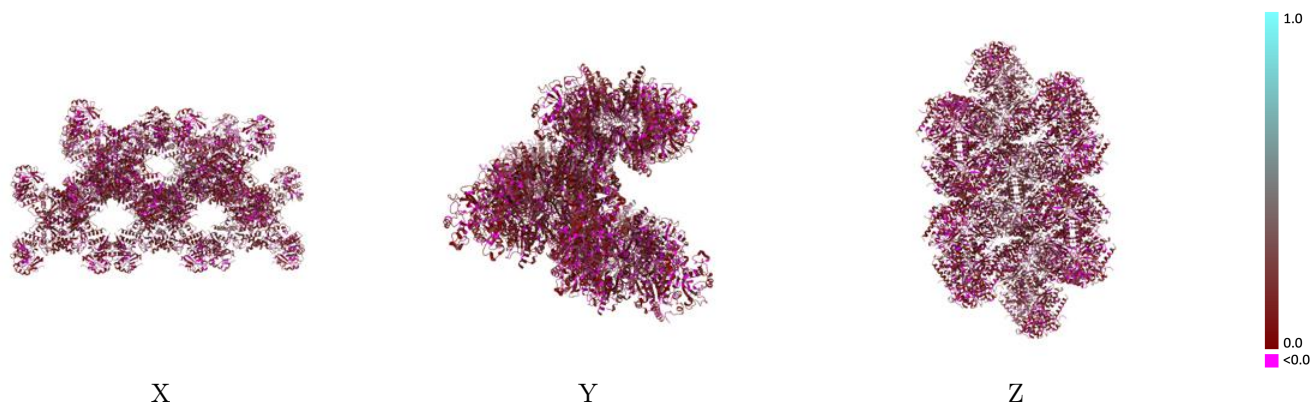

The images above show the model with each residue coloured according to its Q-score. This shows their resolvability in the map with higher Q-score values reflecting better resolvability. Please note: Q-score is calculating the resolvability of atoms, and thus high values are only expected at resolutions at which atoms can be resolved. Low Q-score values may therefore be expected for many entries.

9.3 Atom inclusion mapped to coordinate model [i](#)

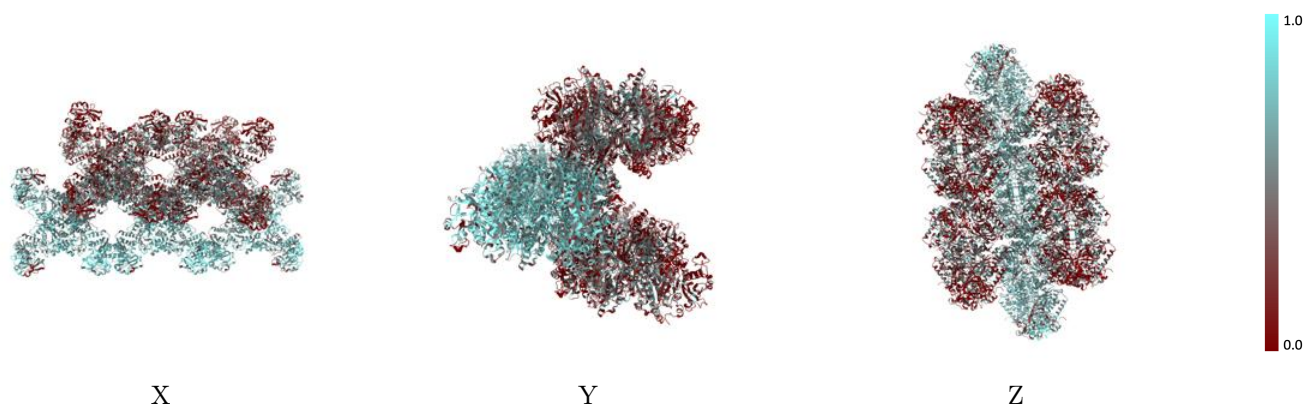

The images above show the model with each residue coloured according to its atom inclusion. This shows to what extent they are inside the map at the recommended contour level (0.3).



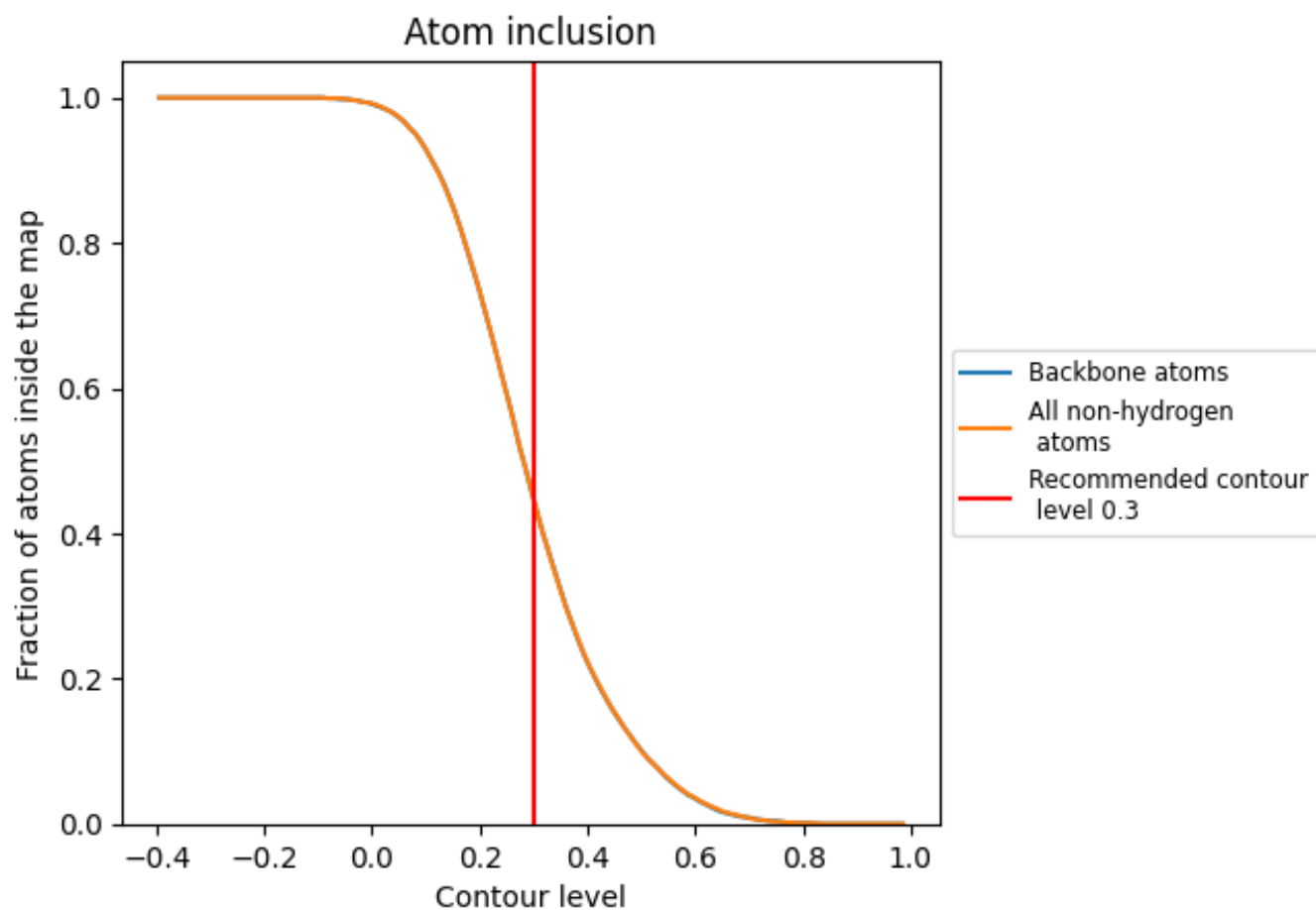























































9.4 Atom inclusion [i](#)



At the recommended contour level, 45% of all backbone atoms, 45% of all non-hydrogen atoms, are inside the map.

9.5 Map-model fit summary

The table lists the average atom inclusion at the recommended contour level (0.3) and Q-score for the entire model and for each chain.

Chain	Atom inclusion	Q-score
All	 0.4460	 0.1210
A	 0.6650	 0.1270
B	 0.6360	 0.1360
C	 0.7310	 0.1320
D	 0.6170	 0.1280
E	 0.2510	 0.1130
F	 0.2760	 0.1110
G	 0.3040	 0.1150
H	 0.2290	 0.1000
I	 0.7310	 0.1300
J	 0.2780	 0.1170
K	 0.3030	 0.1150
L	 0.7490	 0.1350
M	 0.6170	 0.1290
N	 0.2710	 0.1140
O	 0.2300	 0.1000
P	 0.6730	 0.1420
Q	 0.6650	 0.1270
R	 0.2770	 0.1230
S	 0.2500	 0.1150
T	 0.7490	 0.1350
U	 0.6370	 0.1360
V	 0.3310	 0.1040
W	 0.2750	 0.1110
X	 0.6730	 0.1430
Y	 0.2760	 0.1220
Z	 0.3320	 0.1040
a	 0.2800	 0.1180
b	 0.2730	 0.1150

