



wwPDB X-ray Structure Validation Summary Report ⓘ

Jan 3, 2024 – 04:38 PM EST

PDB ID : 4R4N
Title : Crystal structure of the anti-hiv-1 antibody 2.2c in complex with hiv-1 93ug037 gp120
Authors : Acharya, P.; Louder, R.; Kwong, P.D.
Deposited on : 2014-08-19
Resolution : 3.56 Å (reported)

This is a wwPDB X-ray Structure Validation Summary Report for a publicly released PDB entry.

We welcome your comments at validation@mail.wwpdb.org

A user guide is available at

<https://www.wwpdb.org/validation/2017/XrayValidationReportHelp>

with specific help available everywhere you see the ⓘ symbol.

The types of validation reports are described at

<http://www.wwpdb.org/validation/2017/FAQs#types>.

The following versions of software and data (see [references ⓘ](#)) were used in the production of this report:

MolProbity : 4.02b-467
Mogul : 1.8.5 (274361), CSD as541be (2020)
Xtriage (Phenix) : 1.13
EDS : 2.36
Percentile statistics : 20191225.v01 (using entries in the PDB archive December 25th 2019)
Refmac : 5.8.0158
CCP4 : 7.0.044 (Gargrove)
Ideal geometry (proteins) : Engh & Huber (2001)
Ideal geometry (DNA, RNA) : Parkinson et al. (1996)
Validation Pipeline (wwPDB-VP) : 2.36

1 Overall quality at a glance

The following experimental techniques were used to determine the structure:

X-RAY DIFFRACTION

The reported resolution of this entry is 3.56 Å.

Percentile scores (ranging between 0-100) for global validation metrics of the entry are shown in the following graphic. The table shows the number of entries on which the scores are based.

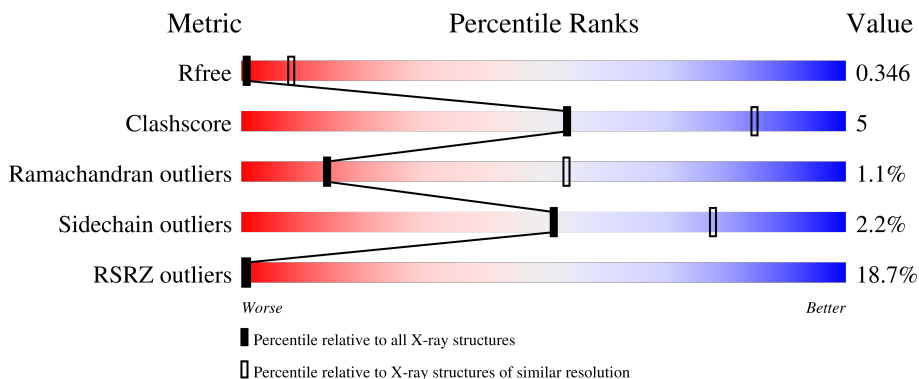

Metric	Whole archive (#Entries)	Similar resolution (#Entries, resolution range(Å))
R_{free}	130704	1020 (3.62-3.50)
Clashscore	141614	1100 (3.62-3.50)
Ramachandran outliers	138981	1065 (3.62-3.50)
Sidechain outliers	138945	1066 (3.62-3.50)
RSRZ outliers	127900	1009 (3.64-3.48)

The table below summarises the geometric issues observed across the polymeric chains and their fit to the electron density. The red, orange, yellow and green segments of the lower bar indicate the fraction of residues that contain outliers for ≥ 3 , 2, 1 and 0 types of geometric quality criteria respectively. A grey segment represents the fraction of residues that are not modelled. The numeric value for each fraction is indicated below the corresponding segment, with a dot representing fractions $\leq 5\%$. The upper red bar (where present) indicates the fraction of residues that have poor fit to the electron density. The numeric value is given above the bar.

Mol	Chain	Length	Quality of chain
1	A	352	
1	B	352	
1	E	352	
1	I	352	
1	M	352	

Continued on next page...

Continued from previous page...

Mol	Chain	Length	Quality of chain
1	P	352	10% 88% 7% . .
1	S	352	8% 86% 10% . .
1	V	352	9% 88% 8% .
2	a	28	7% 93% 7%
2	b	28	4% 96% .
2	e	28	4% 89% 11%
2	i	28	4% 96% .
2	m	28	7% 96% .
2	p	28	4% 96% .
2	s	28	7% 93% 7%
2	v	28	14% 96% .
3	D	210	25% 86% 14%
3	G	210	25% 93% 6%
3	K	210	40% 90% 9%
3	L	210	13% 97% .
3	O	210	27% 94% 6%
3	R	210	26% 98% .
3	U	210	16% 94% 6%
3	X	210	34% 96% .
4	C	220	24% 83% 13% .
4	F	220	24% 86% 11% .
4	H	220	20% 95% .
4	J	220	36% 83% 15% .
4	N	220	27% 86% 13% .
4	Q	220	22% 94% 5% .

Continued on next page...

Continued from previous page...

Mol	Chain	Length	Quality of chain
4	T	220	<p>21% 86% 11%</p>
4	W	220	<p>28% 94% 5%</p>

The following table lists non-polymeric compounds, carbohydrate monomers and non-standard residues in protein, DNA, RNA chains that are outliers for geometric or electron-density-fit criteria:

Mol	Type	Chain	Res	Chirality	Geometry	Clashes	Electron density
2	U2X	e	23	-	-	-	X
5	NAG	B	502	-	-	X	-
5	NAG	I	502	-	-	-	X
5	NAG	S	502	-	-	X	-

2 Entry composition [i](#)

There are 5 unique types of molecules in this entry. The entry contains 94738 atoms, of which 45586 are hydrogens and 0 are deuteriums.

In the tables below, the ZeroOcc column contains the number of atoms modelled with zero occupancy, the AltConf column contains the number of residues with at least one atom in alternate conformation and the Trace column contains the number of residues modelled with at most 2 atoms.

- Molecule 1 is a protein called HIV-1 gp120.

Mol	Chain	Residues	Atoms					ZeroOcc	AltConf	Trace	
			Total	C	H	N	O				S
1	A	333	5094	1611	2506	458	498	21	0	0	0
1	B	342	5189	1655	2532	469	512	21	0	0	0
1	I	341	5172	1641	2532	466	512	21	0	0	0
1	E	329	5042	1595	2481	453	492	21	0	0	0
1	M	339	5169	1633	2544	463	508	21	0	0	0
1	P	338	5157	1631	2537	462	506	21	0	0	0
1	S	339	5168	1634	2542	463	508	21	0	0	0
1	V	338	5160	1631	2539	463	506	21	0	0	0

- Molecule 2 is a protein called M48U1 peptide.

Mol	Chain	Residues	Atoms					ZeroOcc	AltConf	Trace
			Total	C	N	O	S			
2	a	28	209	133	38	32	6	0	0	1
2	b	28	209	133	38	32	6	0	0	1
2	e	28	209	133	38	32	6	0	0	1
2	i	28	209	133	38	32	6	0	0	1
2	m	28	209	133	38	32	6	0	0	1
2	p	28	209	133	38	32	6	0	0	1

Continued on next page...

Continued from previous page...

Mol	Chain	Residues	Atoms					ZeroOcc	AltConf	Trace
2	s	28	Total	C	N	O	S	0	0	1
			209	133	38	32	6			
2	v	28	Total	C	N	O	S	0	0	1
			209	133	38	32	6			

- Molecule 3 is a protein called Antibody 2.2c LIGHT CHAIN.

Mol	Chain	Residues	Atoms					ZeroOcc	AltConf	Trace	
3	L	210	Total	C	H	N	O	S	0	0	0
			3197	1012	1585	272	323	5			
3	D	210	Total	C	H	N	O	S	0	0	0
			3196	1012	1584	272	323	5			
3	G	210	Total	C	H	N	O	S	0	0	0
			3194	1012	1582	272	323	5			
3	K	210	Total	C	H	N	O	S	0	0	0
			3195	1012	1583	272	323	5			
3	O	210	Total	C	H	N	O	S	0	0	0
			3198	1012	1586	272	323	5			
3	R	210	Total	C	H	N	O	S	0	0	0
			3195	1012	1583	272	323	5			
3	U	210	Total	C	H	N	O	S	0	0	0
			3193	1012	1581	272	323	5			
3	X	210	Total	C	H	N	O	S	0	0	0
			3198	1012	1586	272	323	5			

- Molecule 4 is a protein called Antibody 2.2c heavy CHAIN.

Mol	Chain	Residues	Atoms					ZeroOcc	AltConf	Trace	
4	H	220	Total	C	H	N	O	S	0	0	0
			3322	1066	1648	283	320	5			
4	C	220	Total	C	H	N	O	S	0	0	0
			3245	1066	1571	283	320	5			
4	F	220	Total	C	H	N	O	S	0	0	0
			3186	1064	1515	283	319	5			
4	J	220	Total	C	H	N	O	S	0	0	0
			3186	1064	1515	283	319	5			
4	N	220	Total	C	H	N	O	S	0	0	0
			3322	1064	1651	283	319	5			
4	Q	220	Total	C	H	N	O	S	0	0	0
			3322	1064	1651	283	319	5			
4	T	220	Total	C	H	N	O	S	0	0	0
			3179	1066	1505	283	320	5			

Continued on next page...

Continued from previous page...

Mol	Chain	Residues	Atoms					ZeroOcc	AltConf	Trace	
			Total	C	H	N	O				S
4	W	220	3321	1066	1647	283	320	5	0	0	0

- Molecule 5 is 2-acetamido-2-deoxy-beta-D-glucopyranose (three-letter code: NAG) (formula: $C_8H_{15}NO_6$).

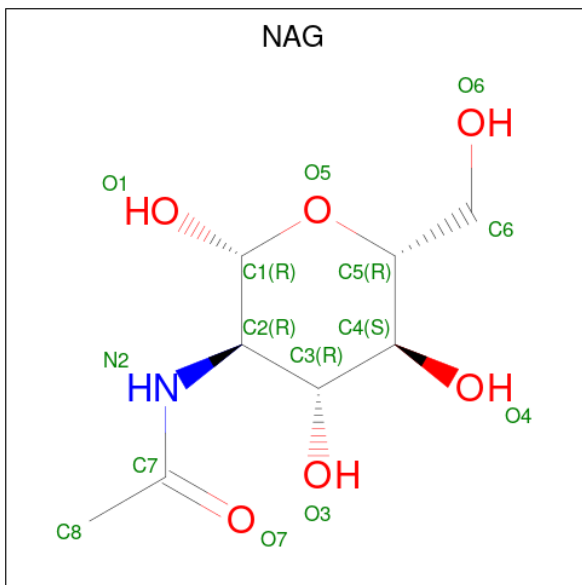

Mol	Chain	Residues	Atoms				ZeroOcc	AltConf
			Total	C	N	O		
5	A	1	14	8	1	5	0	0
5	A	1	14	8	1	5	0	0
5	A	1	14	8	1	5	0	0
5	A	1	14	8	1	5	0	0
5	B	1	14	8	1	5	0	0
5	B	1	14	8	1	5	0	0
5	I	1	14	8	1	5	0	0
5	I	1	14	8	1	5	0	0
5	I	1	14	8	1	5	0	0
5	I	1	14	8	1	5	0	0

Continued on next page...

Continued from previous page...

Mol	Chain	Residues	Atoms				ZeroOcc	AltConf
5	E	1	Total 14	C 8	N 1	O 5	0	0
5	E	1	Total 14	C 8	N 1	O 5	0	0
5	M	1	Total 14	C 8	N 1	O 5	0	0
5	P	1	Total 14	C 8	N 1	O 5	0	0
5	P	1	Total 14	C 8	N 1	O 5	0	0
5	S	1	Total 14	C 8	N 1	O 5	0	0
5	S	1	Total 14	C 8	N 1	O 5	0	0
5	S	1	Total 14	C 8	N 1	O 5	0	0
5	V	1	Total 14	C 8	N 1	O 5	0	0

3 Residue-property plots [i](#)

These plots are drawn for all protein, RNA, DNA and oligosaccharide chains in the entry. The first graphic for a chain summarises the proportions of the various outlier classes displayed in the second graphic. The second graphic shows the sequence view annotated by issues in geometry and electron density. Residues are color-coded according to the number of geometric quality criteria for which they contain at least one outlier: green = 0, yellow = 1, orange = 2 and red = 3 or more. A red dot above a residue indicates a poor fit to the electron density ($RSRZ > 2$). Stretches of 2 or more consecutive residues without any outlier are shown as a green connector. Residues present in the sample, but not in the model, are shown in grey.

- Molecule 1: HIV-1 gp120

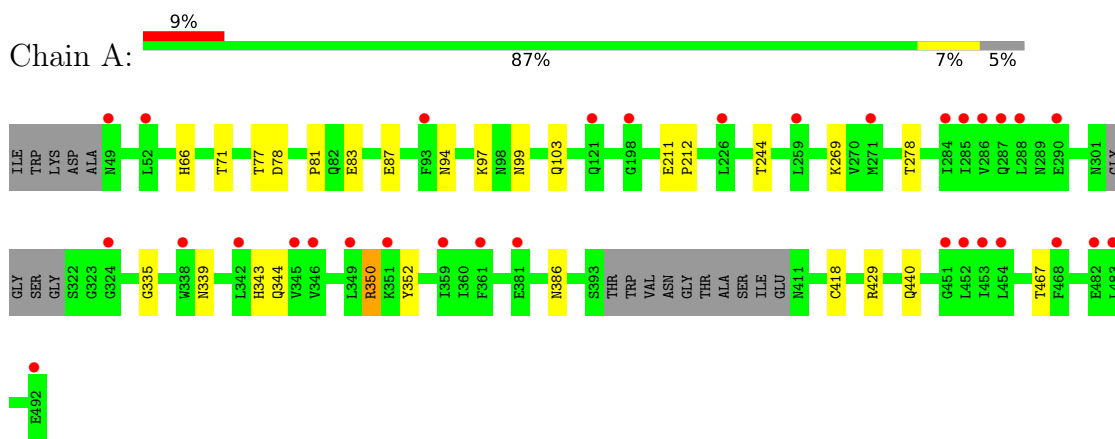

- Molecule 1: HIV-1 gp120

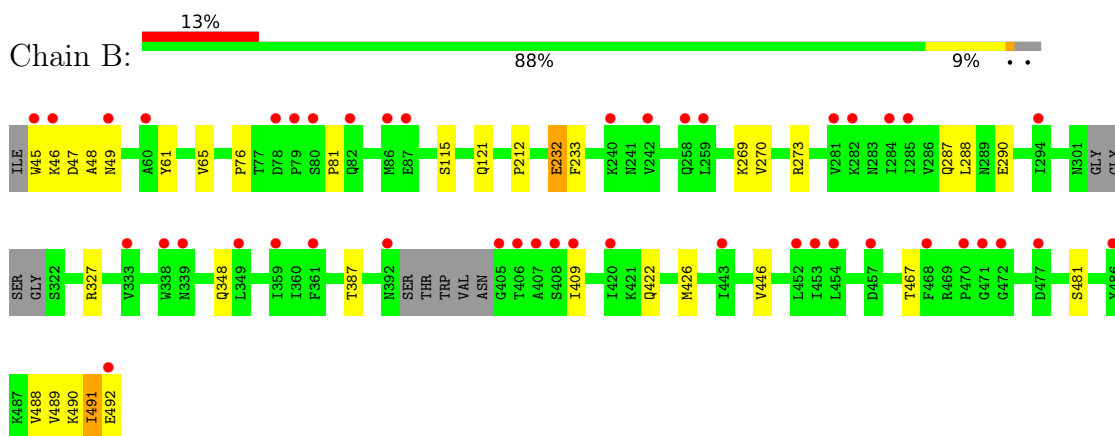

- Molecule 1: HIV-1 gp120

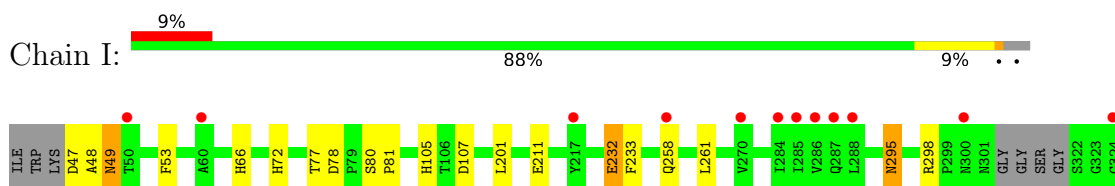

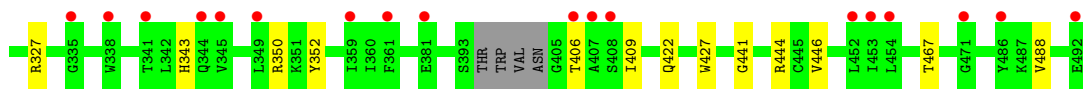

• Molecule 1: HIV-1 gp120

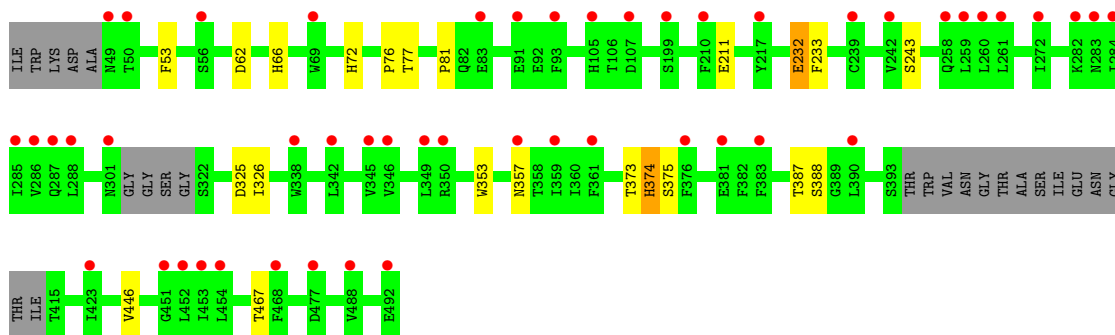
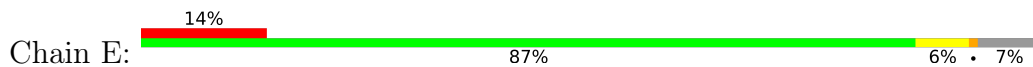

• Molecule 1: HIV-1 gp120

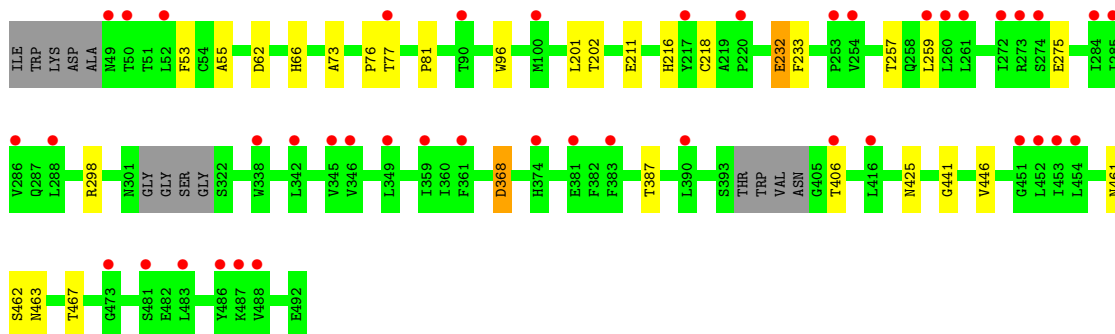
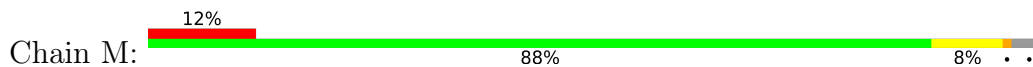

• Molecule 1: HIV-1 gp120

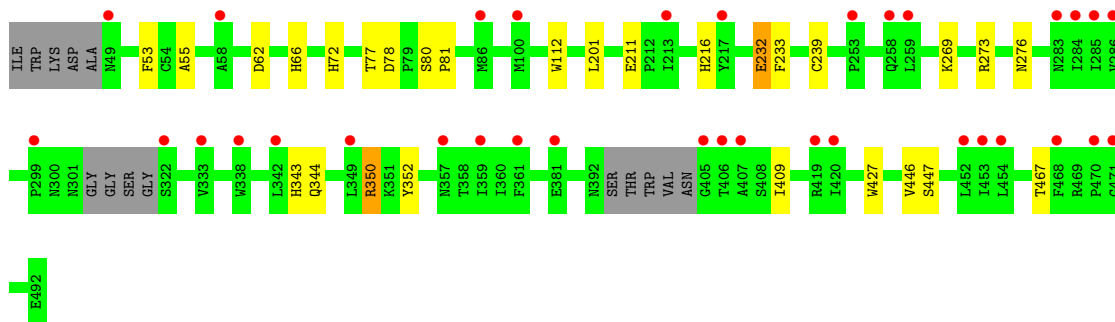
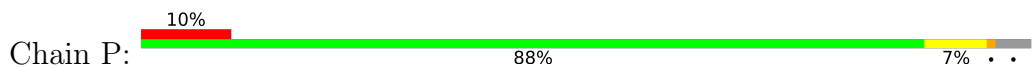

• Molecule 1: HIV-1 gp120

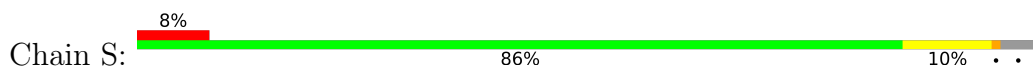

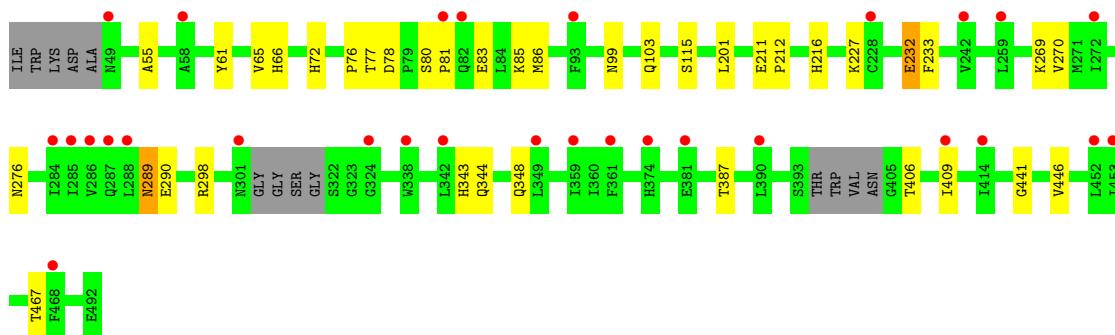

- Molecule 1: HIV-1 gp120

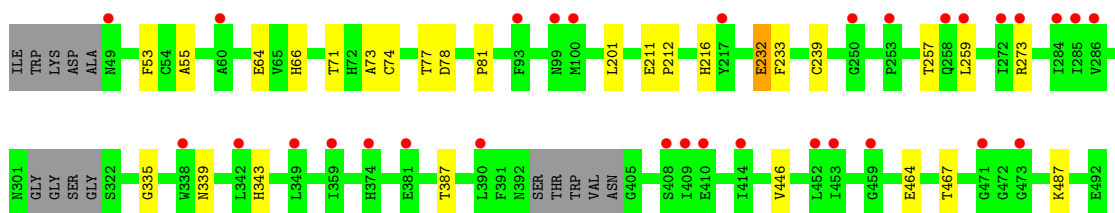
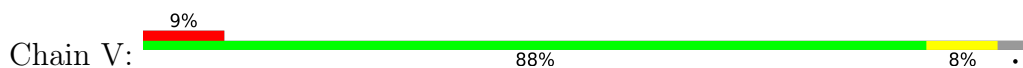

- Molecule 2: M48U1 peptide

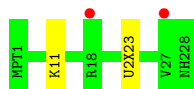

- Molecule 2: M48U1 peptide



- Molecule 2: M48U1 peptide

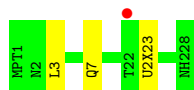
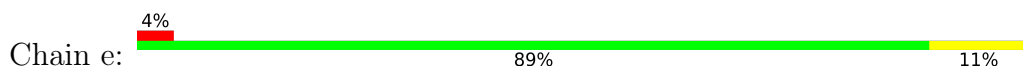

- Molecule 2: M48U1 peptide

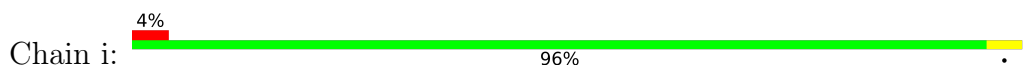

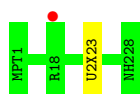

- Molecule 2: M48U1 peptide

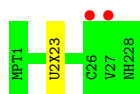

- Molecule 2: M48U1 peptide

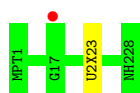
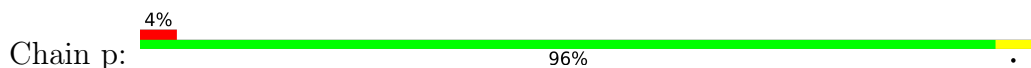

- Molecule 2: M48U1 peptide

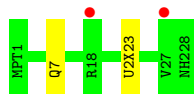
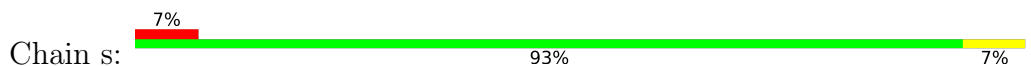

- Molecule 2: M48U1 peptide

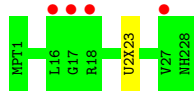
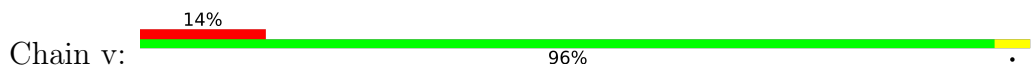

- Molecule 3: Antibody 2.2c LIGHT CHAIN

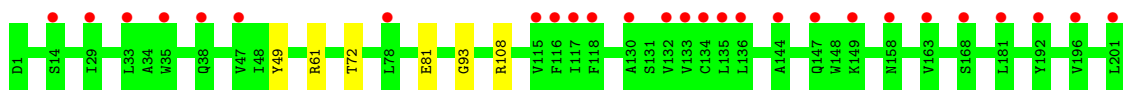

- Molecule 3: Antibody 2.2c LIGHT CHAIN

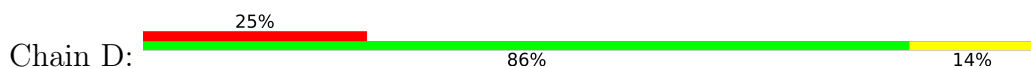

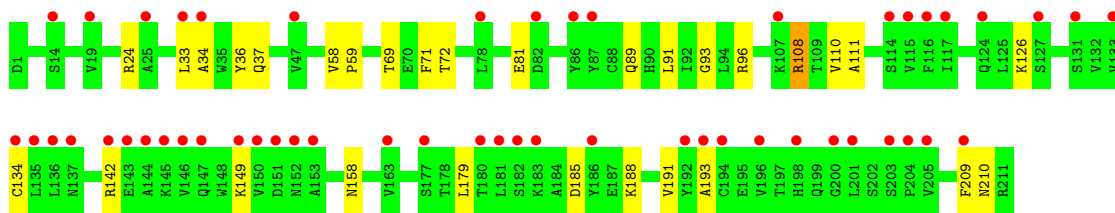

- Molecule 3: Antibody 2.2c LIGHT CHAIN

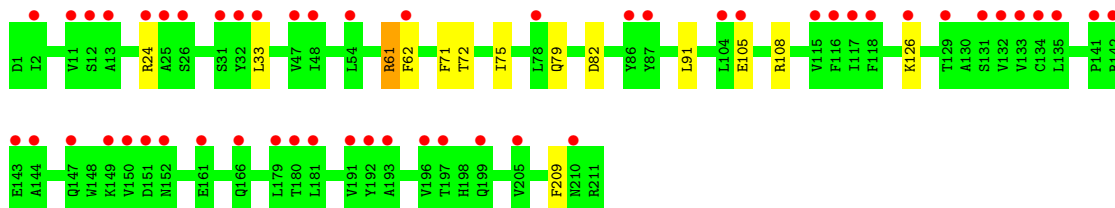

- Molecule 3: Antibody 2.2c LIGHT CHAIN

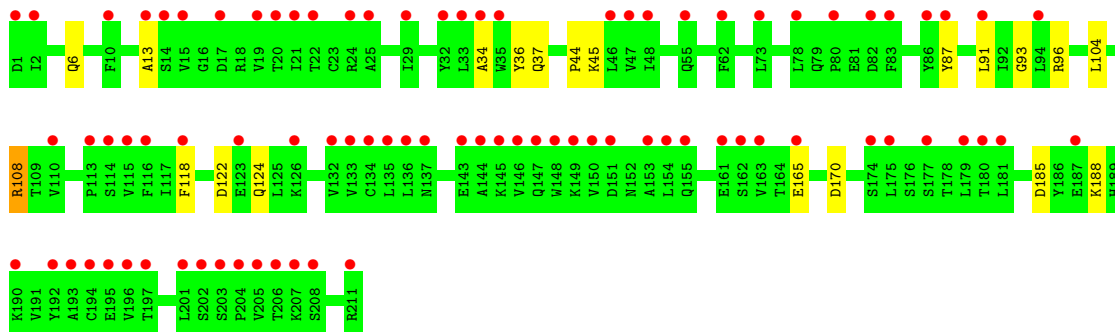
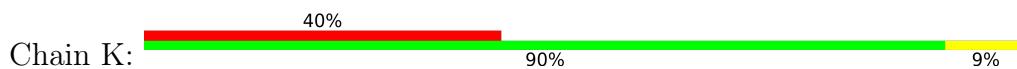

- Molecule 3: Antibody 2.2c LIGHT CHAIN

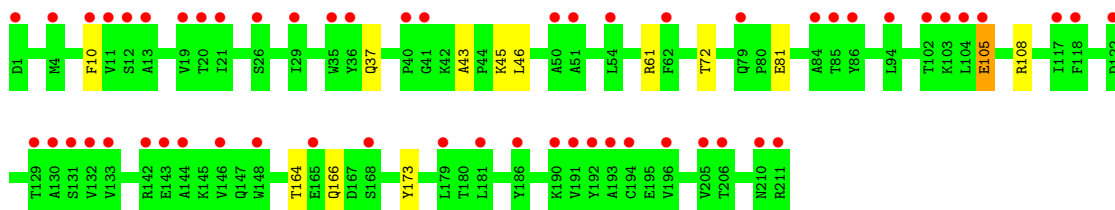

- Molecule 3: Antibody 2.2c LIGHT CHAIN



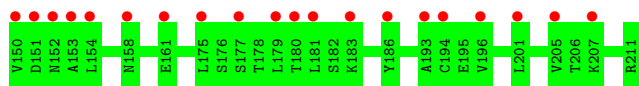

- Molecule 3: Antibody 2.2c LIGHT CHAIN

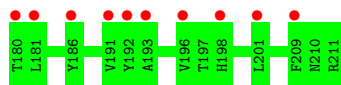

- Molecule 3: Antibody 2.2c LIGHT CHAIN

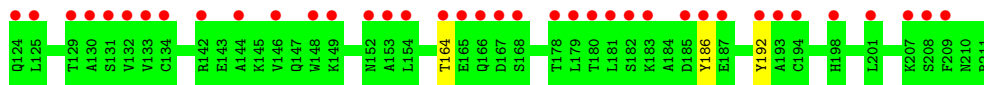
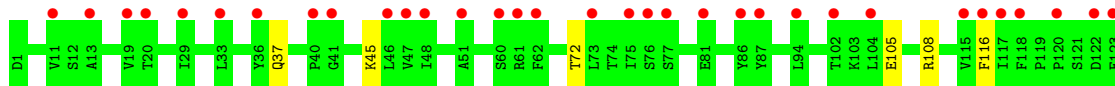

- Molecule 4: Antibody 2.2c heavy CHAIN

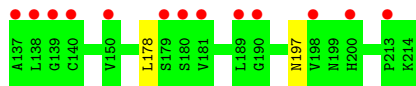
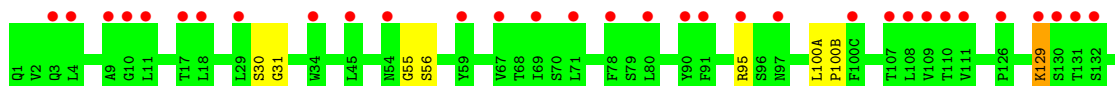

- Molecule 4: Antibody 2.2c heavy CHAIN

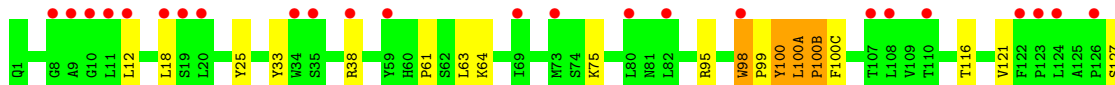
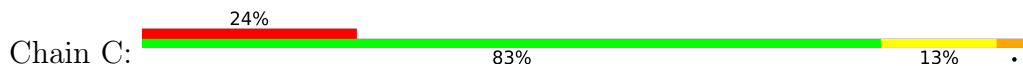

- Molecule 4: Antibody 2.2c heavy CHAIN

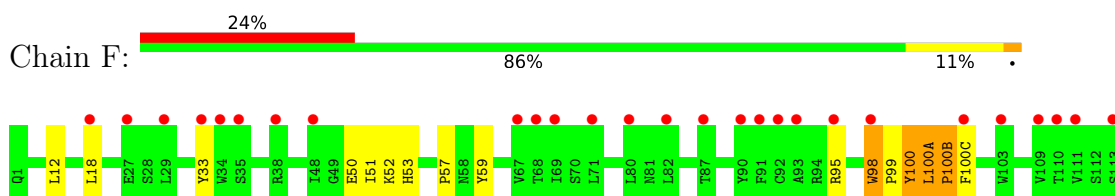

- Molecule 4: Antibody 2.2c heavy CHAIN

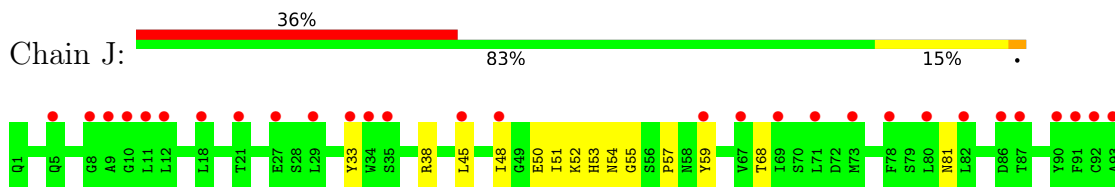

- Molecule 4: Antibody 2.2c heavy CHAIN

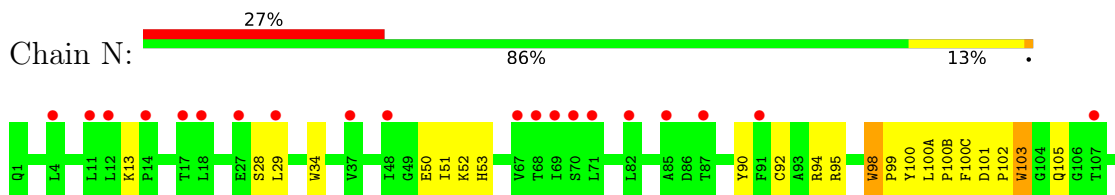

- Molecule 4: Antibody 2.2c heavy CHAIN

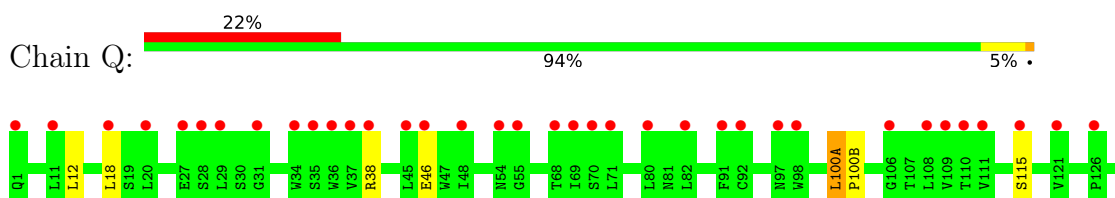

- Molecule 4: Antibody 2.2c heavy CHAIN

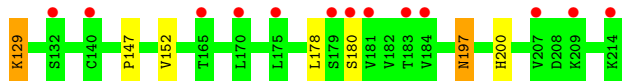

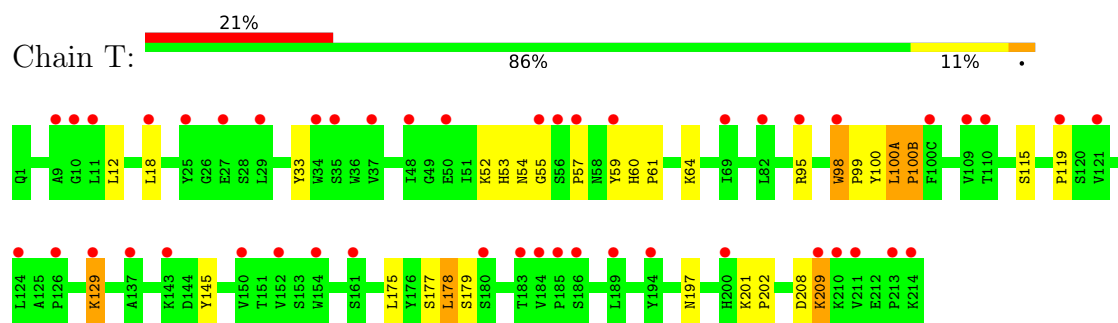

• Molecule 4: Antibody 2.2c heavy CHAIN

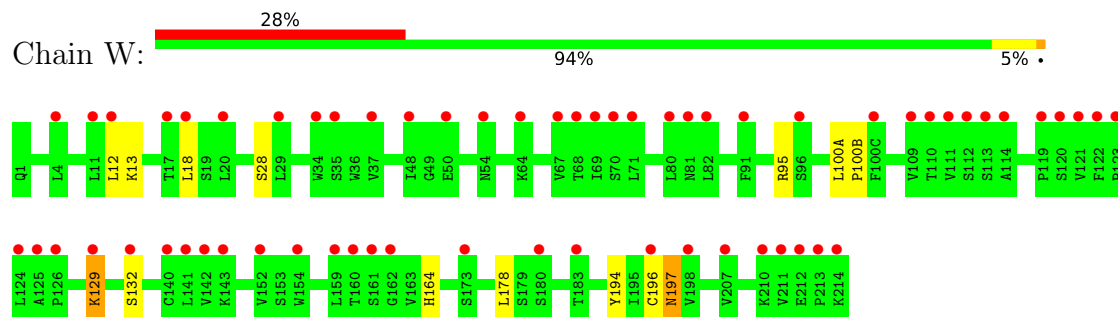

4 Data and refinement statistics

Property	Value	Source
Space group	P 1	Depositor
Cell constants a, b, c, α , β , γ	112.97Å 144.18Å 158.35Å 110.58° 92.30° 99.19°	Depositor
Resolution (Å)	49.15 – 3.56 49.15 – 2.85	Depositor EDS
% Data completeness (in resolution range)	62.7 (49.15-3.56) 33.3 (49.15-2.85)	Depositor EDS
R_{merge}	(Not available)	Depositor
R_{sym}	(Not available)	Depositor
$\langle I/\sigma(I) \rangle$ ¹	2.79 (at 2.86Å)	Xtrriage
Refinement program	PHENIX (phenix.refine: 1.9_1692)	Depositor
R, R_{free}	0.296 , 0.328 0.317 , 0.346	Depositor DCC
R_{free} test set	3686 reflections (5.14%)	wwPDB-VP
Wilson B-factor (Å ²)	99.3	Xtrriage
Anisotropy	0.410	Xtrriage
Bulk solvent k_{sol} (e/Å ³), B_{sol} (Å ²)	0.33 , 159.8	EDS
L-test for twinning ²	$\langle L \rangle = 0.47$, $\langle L^2 \rangle = 0.29$	Xtrriage
Estimated twinning fraction	No twinning to report.	Xtrriage
F_o, F_c correlation	0.85	EDS
Total number of atoms	94738	wwPDB-VP
Average B, all atoms (Å ²)	217.0	wwPDB-VP

Xtrriage's analysis on translational NCS is as follows: *The largest off-origin peak in the Patterson function is 3.15% of the height of the origin peak. No significant pseudotranslation is detected.*

¹Intensities estimated from amplitudes.

²Theoretical values of $\langle |L| \rangle$, $\langle L^2 \rangle$ for acentric reflections are 0.5, 0.333 respectively for untwinned datasets, and 0.375, 0.2 for perfectly twinned datasets.

5 Model quality

5.1 Standard geometry

Bond lengths and bond angles in the following residue types are not validated in this section: NAG, MPT, NH2, DPR, U2X, OAS

The Z score for a bond length (or angle) is the number of standard deviations the observed value is removed from the expected value. A bond length (or angle) with $|Z| > 5$ is considered an outlier worth inspection. RMSZ is the root-mean-square of all Z scores of the bond lengths (or angles).

Mol	Chain	Bond lengths		Bond angles	
		RMSZ	# Z >5	RMSZ	# Z >5
1	A	0.25	0/2639	0.42	0/3583
1	B	0.24	0/2710	0.43	0/3680
1	E	0.24	0/2612	0.41	0/3546
1	I	0.24	0/2691	0.41	0/3654
1	M	0.24	0/2675	0.42	0/3630
1	P	0.23	0/2671	0.42	0/3626
1	S	0.25	0/2677	0.43	0/3634
1	V	0.24	0/2672	0.42	0/3628
2	a	0.32	0/176	0.62	0/231
2	b	0.32	0/176	0.62	0/231
2	e	0.32	0/176	0.62	0/231
2	i	0.32	0/176	0.62	0/231
2	m	0.32	0/176	0.62	0/231
2	p	0.32	0/176	0.62	0/231
2	s	0.32	0/176	0.63	0/231
2	v	0.32	0/176	0.62	0/231
3	D	0.34	0/1646	0.65	0/2231
3	G	0.25	0/1646	0.46	0/2231
3	K	0.30	0/1646	0.57	0/2231
3	L	0.24	0/1646	0.44	0/2231
3	O	0.24	0/1646	0.44	0/2231
3	R	0.25	0/1646	0.45	0/2231
3	U	0.25	0/1646	0.46	0/2231
3	X	0.25	0/1646	0.44	0/2231
4	C	0.35	0/1713	0.71	0/2341
4	F	0.25	0/1713	0.48	0/2341
4	H	0.25	0/1713	0.46	0/2341
4	J	0.30	0/1713	0.57	0/2341
4	N	0.26	0/1713	0.59	0/2341
4	Q	0.25	0/1713	0.47	0/2341
4	T	0.27	0/1713	0.53	0/2341
4	W	0.25	0/1713	0.57	0/2341

Mol	Chain	Bond lengths		Bond angles	
		RMSZ	# Z >5	RMSZ	# Z >5
All	All	0.26	0/49627	0.49	0/67405

Chiral center outliers are detected by calculating the chiral volume of a chiral center and verifying if the center is modelled as a planar moiety or with the opposite hand. A planarity outlier is detected by checking planarity of atoms in a peptide group, atoms in a mainchain group or atoms of a sidechain that are expected to be planar.

Mol	Chain	#Chirality outliers	#Planarity outliers
3	K	0	1
4	C	0	1
All	All	0	2

There are no bond length outliers.

There are no bond angle outliers.

There are no chirality outliers.

All (2) planarity outliers are listed below:

Mol	Chain	Res	Type	Group
4	C	159	LEU	Mainchain
3	K	165	GLU	Sidechain

5.2 Too-close contacts [i](#)

In the following table, the Non-H and H(model) columns list the number of non-hydrogen atoms and hydrogen atoms in the chain respectively. The H(added) column lists the number of hydrogen atoms added and optimized by MolProbity. The Clashes column lists the number of clashes within the asymmetric unit, whereas Symm-Clashes lists symmetry-related clashes.

Mol	Chain	Non-H	H(model)	H(added)	Clashes	Symm-Clashes
1	A	2588	2506	2508	17	0
1	B	2657	2532	2574	30	0
1	E	2561	2481	2482	13	0
1	I	2640	2532	2554	19	0
1	M	2625	2544	2543	15	0
1	P	2620	2537	2541	16	0
1	S	2626	2542	2545	31	0
1	V	2621	2539	2543	15	0
2	a	209	0	211	0	0
2	b	209	0	211	0	0
2	e	209	0	210	0	6

Continued on next page...

Continued from previous page...

Mol	Chain	Non-H	H(model)	H(added)	Clashes	Symm-Clashes
2	i	209	0	211	0	0
2	m	209	0	211	0	0
2	p	209	0	211	0	0
2	s	209	0	211	0	2
2	v	209	0	211	0	0
3	D	1612	1584	1583	16	1
3	G	1612	1582	1583	21	2
3	K	1612	1583	1583	14	0
3	L	1612	1585	1583	3	0
3	O	1612	1586	1583	7	0
3	R	1612	1583	1583	1	0
3	U	1612	1581	1583	10	6
3	X	1612	1586	1583	4	0
4	C	1674	1571	1650	42	0
4	F	1671	1515	1647	45	0
4	H	1674	1648	1650	6	0
4	J	1671	1515	1647	39	0
4	N	1671	1651	1647	18	0
4	Q	1671	1651	1647	7	1
4	T	1674	1505	1650	37	0
4	W	1674	1647	1650	7	0
5	A	56	0	52	8	0
5	B	28	0	26	10	0
5	E	28	0	26	2	0
5	I	56	0	52	7	0
5	M	14	0	13	1	0
5	P	28	0	26	5	0
5	S	42	0	39	13	0
5	V	14	0	13	3	0
All	All	49152	45586	48076	393	9

The all-atom clashscore is defined as the number of clashes found per 1000 atoms (including hydrogen atoms). The all-atom clashscore for this structure is 5.

The worst 5 of 393 close contacts within the same asymmetric unit are listed below, sorted by their clash magnitude.

Atom-1	Atom-2	Interatomic distance (Å)	Clash overlap (Å)
4:T:100(A):LEU:HB3	4:T:100(B):PRO:HA	1.33	1.10
1:I:48:ALA:HA	1:I:49:ASN:HB2	1.28	1.09
3:G:61:ARG:HH21	3:G:79:GLN:HG3	1.14	1.08
4:J:100(A):LEU:HB3	4:J:100(B):PRO:HA	1.36	1.07

Continued on next page...

Continued from previous page...

Atom-1	Atom-2	Interatomic distance (Å)	Clash overlap (Å)
4:F:98:TRP:HB3	4:F:100:TYR:H	1.20	1.06

The worst 5 of 9 symmetry-related close contacts are listed below. The label for Atom-2 includes the symmetry operator and encoded unit-cell translations to be applied.

Atom-1	Atom-2	Interatomic distance (Å)	Clash overlap (Å)
2:e:3:LEU:CD1	3:U:24:ARG:CZ[1_545]	1.75	0.45
2:e:3:LEU:CD1	3:U:24:ARG:NH1[1_545]	1.75	0.45
2:e:7:GLN:NE2	3:U:24:ARG:NH2[1_545]	1.84	0.36
2:e:7:GLN:CD	3:U:24:ARG:NH2[1_545]	2.01	0.19
3:G:24:ARG:NH2	2:s:7:GLN:NE2[1_545]	2.05	0.15

5.3 Torsion angles [i](#)

5.3.1 Protein backbone [i](#)

In the following table, the Percentiles column shows the percent Ramachandran outliers of the chain as a percentile score with respect to all X-ray entries followed by that with respect to entries of similar resolution.

The Analysed column shows the number of residues for which the backbone conformation was analysed, and the total number of residues.

Mol	Chain	Analysed	Favoured	Allowed	Outliers	Percentiles	
1	A	327/352 (93%)	298 (91%)	26 (8%)	3 (1%)	17	57
1	B	336/352 (96%)	301 (90%)	29 (9%)	6 (2%)	8	43
1	E	323/352 (92%)	290 (90%)	26 (8%)	7 (2%)	6	39
1	I	335/352 (95%)	285 (85%)	42 (12%)	8 (2%)	6	37
1	M	333/352 (95%)	298 (90%)	28 (8%)	7 (2%)	7	40
1	P	332/352 (94%)	295 (89%)	30 (9%)	7 (2%)	7	40
1	S	333/352 (95%)	293 (88%)	34 (10%)	6 (2%)	8	43
1	V	332/352 (94%)	299 (90%)	29 (9%)	4 (1%)	13	52
2	a	24/28 (86%)	24 (100%)	0	0	100	100
2	b	24/28 (86%)	24 (100%)	0	0	100	100
2	e	24/28 (86%)	24 (100%)	0	0	100	100
2	i	24/28 (86%)	24 (100%)	0	0	100	100

Continued on next page...

Continued from previous page...

Mol	Chain	Analysed	Favoured	Allowed	Outliers	Percentiles	
2	m	24/28 (86%)	24 (100%)	0	0	100	100
2	p	24/28 (86%)	24 (100%)	0	0	100	100
2	s	24/28 (86%)	24 (100%)	0	0	100	100
2	v	24/28 (86%)	24 (100%)	0	0	100	100
3	D	208/210 (99%)	194 (93%)	13 (6%)	1 (0%)	29	67
3	G	208/210 (99%)	197 (95%)	11 (5%)	0	100	100
3	K	208/210 (99%)	198 (95%)	10 (5%)	0	100	100
3	L	208/210 (99%)	198 (95%)	10 (5%)	0	100	100
3	O	208/210 (99%)	198 (95%)	10 (5%)	0	100	100
3	R	208/210 (99%)	197 (95%)	11 (5%)	0	100	100
3	U	208/210 (99%)	199 (96%)	9 (4%)	0	100	100
3	X	208/210 (99%)	198 (95%)	10 (5%)	0	100	100
4	C	217/220 (99%)	203 (94%)	11 (5%)	3 (1%)	11	48
4	F	217/220 (99%)	202 (93%)	11 (5%)	4 (2%)	8	43
4	H	217/220 (99%)	204 (94%)	13 (6%)	0	100	100
4	J	217/220 (99%)	202 (93%)	11 (5%)	4 (2%)	8	43
4	N	217/220 (99%)	203 (94%)	11 (5%)	3 (1%)	11	48
4	Q	217/220 (99%)	203 (94%)	13 (6%)	1 (0%)	29	67
4	T	217/220 (99%)	203 (94%)	11 (5%)	3 (1%)	11	48
4	W	217/220 (99%)	198 (91%)	18 (8%)	1 (0%)	29	67
All	All	6243/6480 (96%)	5748 (92%)	427 (7%)	68 (1%)	14	54

5 of 68 Ramachandran outliers are listed below:

Mol	Chain	Res	Type
1	A	81	PRO
1	B	81	PRO
1	I	81	PRO
4	C	98	TRP
4	C	100(A)	LEU

5.3.2 Protein sidechains [i](#)

In the following table, the Percentiles column shows the percent sidechain outliers of the chain as a percentile score with respect to all X-ray entries followed by that with respect to entries of similar

resolution.

The Analysed column shows the number of residues for which the sidechain conformation was analysed, and the total number of residues.

Mol	Chain	Analysed	Rotameric	Outliers	Percentiles	
1	A	293/306 (96%)	287 (98%)	6 (2%)	55	79
1	B	299/306 (98%)	297 (99%)	2 (1%)	84	93
1	E	290/306 (95%)	288 (99%)	2 (1%)	84	93
1	I	298/306 (97%)	291 (98%)	7 (2%)	50	77
1	M	296/306 (97%)	293 (99%)	3 (1%)	76	89
1	P	295/306 (96%)	289 (98%)	6 (2%)	55	79
1	S	296/306 (97%)	290 (98%)	6 (2%)	55	79
1	V	296/306 (97%)	286 (97%)	10 (3%)	37	69
2	a	20/20 (100%)	19 (95%)	1 (5%)	24	59
2	b	20/20 (100%)	20 (100%)	0	100	100
2	e	20/20 (100%)	20 (100%)	0	100	100
2	i	20/20 (100%)	20 (100%)	0	100	100
2	m	20/20 (100%)	20 (100%)	0	100	100
2	p	20/20 (100%)	20 (100%)	0	100	100
2	s	20/20 (100%)	20 (100%)	0	100	100
2	v	20/20 (100%)	20 (100%)	0	100	100
3	D	183/183 (100%)	176 (96%)	7 (4%)	33	66
3	G	183/183 (100%)	179 (98%)	4 (2%)	52	78
3	K	183/183 (100%)	182 (100%)	1 (0%)	88	95
3	L	183/183 (100%)	181 (99%)	2 (1%)	73	88
3	O	183/183 (100%)	180 (98%)	3 (2%)	62	83
3	R	183/183 (100%)	180 (98%)	3 (2%)	62	83
3	U	183/183 (100%)	178 (97%)	5 (3%)	44	74
3	X	183/183 (100%)	180 (98%)	3 (2%)	62	83
4	C	190/190 (100%)	180 (95%)	10 (5%)	22	58
4	F	190/190 (100%)	184 (97%)	6 (3%)	39	70
4	H	190/190 (100%)	186 (98%)	4 (2%)	53	79
4	J	190/190 (100%)	185 (97%)	5 (3%)	46	74
4	N	190/190 (100%)	179 (94%)	11 (6%)	20	55

Continued on next page...

Continued from previous page...

Mol	Chain	Analysed	Rotameric	Outliers	Percentiles	
4	Q	190/190 (100%)	187 (98%)	3 (2%)	62	83
4	T	190/190 (100%)	184 (97%)	6 (3%)	39	70
4	W	190/190 (100%)	183 (96%)	7 (4%)	34	67
All	All	5507/5592 (98%)	5384 (98%)	123 (2%)	52	78

5 of 123 residues with a non-rotameric sidechain are listed below:

Mol	Chain	Res	Type
1	M	53	PHE
1	V	387	THR
4	N	129	LYS
1	V	343	HIS
4	W	129	LYS

Sometimes sidechains can be flipped to improve hydrogen bonding and reduce clashes. 5 of 7 such sidechains are listed below:

Mol	Chain	Res	Type
2	m	7	GLN
1	P	374	HIS
2	v	7	GLN
3	U	89	GLN
1	E	357	ASN

5.3.3 RNA [i](#)

There are no RNA molecules in this entry.

5.4 Non-standard residues in protein, DNA, RNA chains [i](#)

24 non-standard protein/DNA/RNA residues are modelled in this entry.

In the following table, the Counts columns list the number of bonds (or angles) for which Mogul statistics could be retrieved, the number of bonds (or angles) that are observed in the model and the number of bonds (or angles) that are defined in the Chemical Component Dictionary. The Link column lists molecule types, if any, to which the group is linked. The Z score for a bond length (or angle) is the number of standard deviations the observed value is removed from the expected value. A bond length (or angle) with $|Z| > 2$ is considered an outlier worth inspection. RMSZ is the root-mean-square of all Z scores of the bond lengths (or angles).

Mol	Type	Chain	Res	Link	Bond lengths			Bond angles		
					Counts	RMSZ	# Z > 2	Counts	RMSZ	# Z > 2
4	OAS	J	30	4	4,5,9	0.85	0	0,5,11	-	-
4	OAS	F	30	4	4,5,9	0.85	0	0,5,11	-	-
2	U2X	b	23	2	19,20,21	2.27	5 (26%)	22,25,27	1.79	7 (31%)
2	U2X	p	23	2	19,20,21	2.27	5 (26%)	22,25,27	1.79	7 (31%)
2	U2X	m	23	2	19,20,21	2.27	5 (26%)	22,25,27	1.79	7 (31%)
4	OAS	W	30	4	7,8,9	0.81	0	5,9,11	0.68	0
2	U2X	i	23	2	19,20,21	2.27	5 (26%)	22,25,27	1.79	7 (31%)
4	OAS	N	30	4	4,5,9	0.80	0	0,5,11	-	-
4	OAS	H	30	4	7,8,9	0.78	0	5,9,11	0.84	0
2	U2X	s	23	2	19,20,21	2.27	5 (26%)	22,25,27	1.79	7 (31%)
4	OAS	Q	30	4	4,5,9	0.86	0	0,5,11	-	-
4	OAS	C	30	4	7,8,9	0.82	0	5,9,11	0.73	0
2	U2X	e	23	2	19,20,21	2.26	5 (26%)	22,25,27	1.79	7 (31%)
2	U2X	v	23	2	19,20,21	2.27	5 (26%)	22,25,27	1.79	7 (31%)
4	OAS	T	30	4	7,8,9	0.81	0	5,9,11	0.76	0
2	U2X	a	23	2	19,20,21	2.27	5 (26%)	22,25,27	1.79	7 (31%)

In the following table, the Chirals column lists the number of chiral outliers, the number of chiral centers analysed, the number of these observed in the model and the number defined in the Chemical Component Dictionary. Similar counts are reported in the Torsion and Rings columns. '-' means no outliers of that kind were identified.

Mol	Type	Chain	Res	Link	Chirals	Torsions	Rings
4	OAS	J	30	4	-	0/2/4/9	-
4	OAS	F	30	4	-	0/2/4/9	-
2	U2X	b	23	2	-	5/10/19/21	0/2/2/2
2	U2X	p	23	2	-	5/10/19/21	0/2/2/2
2	U2X	m	23	2	-	5/10/19/21	0/2/2/2
4	OAS	W	30	4	-	2/5/7/9	-
2	U2X	i	23	2	-	5/10/19/21	0/2/2/2
4	OAS	N	30	4	-	0/2/4/9	-
4	OAS	H	30	4	-	5/5/7/9	-
2	U2X	s	23	2	-	5/10/19/21	0/2/2/2
4	OAS	Q	30	4	-	0/2/4/9	-
4	OAS	C	30	4	-	4/5/7/9	-
2	U2X	e	23	2	-	5/10/19/21	0/2/2/2
2	U2X	v	23	2	-	5/10/19/21	0/2/2/2
4	OAS	T	30	4	-	4/5/7/9	-

Continued on next page...

Continued from previous page...

Mol	Type	Chain	Res	Link	Chirals	Torsions	Rings
2	U2X	a	23	2	-	5/10/19/21	0/2/2/2

The worst 5 of 40 bond length outliers are listed below:

Mol	Chain	Res	Type	Atoms	Z	Observed(Å)	Ideal(Å)
2	b	23	U2X	CE2-CD2	7.21	1.51	1.38
2	v	23	U2X	CE2-CD2	7.19	1.51	1.38
2	s	23	U2X	CE2-CD2	7.18	1.51	1.38
2	i	23	U2X	CE2-CD2	7.18	1.51	1.38
2	a	23	U2X	CE2-CD2	7.16	1.51	1.38

The worst 5 of 56 bond angle outliers are listed below:

Mol	Chain	Res	Type	Atoms	Z	Observed(°)	Ideal(°)
2	m	23	U2X	C2-C3-C7	4.13	121.66	111.28
2	e	23	U2X	C2-C3-C7	4.13	121.66	111.28
2	p	23	U2X	C2-C3-C7	4.13	121.65	111.28
2	i	23	U2X	C2-C3-C7	4.12	121.64	111.28
2	a	23	U2X	C2-C3-C7	4.12	121.63	111.28

There are no chirality outliers.

5 of 55 torsion outliers are listed below:

Mol	Chain	Res	Type	Atoms
2	a	23	U2X	C2-C3-C7-OH
4	H	30	OAS	N-CA-CB-OG
4	H	30	OAS	C-CA-CB-OG
4	H	30	OAS	CA-CB-OG-C1A
2	b	23	U2X	C2-C3-C7-OH

There are no ring outliers.

1 monomer is involved in 1 short contact:

Mol	Chain	Res	Type	Clashes	Symm-Clashes
4	H	30	OAS	1	0

5.5 Carbohydrates [\(i\)](#)

There are no monosaccharides in this entry.

5.6 Ligand geometry

19 ligands are modelled in this entry.

In the following table, the Counts columns list the number of bonds (or angles) for which Mogul statistics could be retrieved, the number of bonds (or angles) that are observed in the model and the number of bonds (or angles) that are defined in the Chemical Component Dictionary. The Link column lists molecule types, if any, to which the group is linked. The Z score for a bond length (or angle) is the number of standard deviations the observed value is removed from the expected value. A bond length (or angle) with $|Z| > 2$ is considered an outlier worth inspection. RMSZ is the root-mean-square of all Z scores of the bond lengths (or angles).

Mol	Type	Chain	Res	Link	Bond lengths			Bond angles		
					Counts	RMSZ	# Z > 2	Counts	RMSZ	# Z > 2
5	NAG	M	501	1	14,14,15	0.27	0	17,19,21	0.45	0
5	NAG	A	503	1	14,14,15	0.21	0	17,19,21	0.43	0
5	NAG	B	502	1	14,14,15	0.35	0	17,19,21	1.27	1 (5%)
5	NAG	A	501	1	14,14,15	0.45	0	17,19,21	0.39	0
5	NAG	A	504	1	14,14,15	0.19	0	17,19,21	0.39	0
5	NAG	I	504	1	14,14,15	0.52	0	17,19,21	0.35	0
5	NAG	I	502	1	14,14,15	0.35	0	17,19,21	0.45	0
5	NAG	S	502	1	14,14,15	0.48	0	17,19,21	0.79	1 (5%)
5	NAG	P	502	1	14,14,15	0.32	0	17,19,21	0.50	0
5	NAG	E	502	1	14,14,15	0.25	0	17,19,21	0.43	0
5	NAG	E	501	1	14,14,15	0.28	0	17,19,21	0.39	0
5	NAG	B	501	1	14,14,15	0.23	0	17,19,21	0.41	0
5	NAG	V	501	1	14,14,15	0.34	0	17,19,21	0.39	0
5	NAG	S	501	1	14,14,15	0.24	0	17,19,21	0.39	0
5	NAG	P	501	1	14,14,15	0.23	0	17,19,21	0.35	0
5	NAG	I	503	1	14,14,15	0.22	0	17,19,21	0.41	0
5	NAG	S	503	1	14,14,15	0.28	0	17,19,21	0.37	0
5	NAG	I	501	1	14,14,15	0.28	0	17,19,21	0.49	0
5	NAG	A	502	1	14,14,15	0.27	0	17,19,21	0.41	0

In the following table, the Chirals column lists the number of chiral outliers, the number of chiral centers analysed, the number of these observed in the model and the number defined in the Chemical Component Dictionary. Similar counts are reported in the Torsion and Rings columns. '-' means no outliers of that kind were identified.

Mol	Type	Chain	Res	Link	Chirals	Torsions	Rings
5	NAG	M	501	1	-	2/6/23/26	0/1/1/1
5	NAG	A	503	1	-	4/6/23/26	0/1/1/1
5	NAG	B	502	1	-	4/6/23/26	0/1/1/1
5	NAG	A	501	1	-	2/6/23/26	0/1/1/1

Continued on next page...

Continued from previous page...

Mol	Type	Chain	Res	Link	Chirals	Torsions	Rings
5	NAG	A	504	1	-	2/6/23/26	0/1/1/1
5	NAG	I	504	1	-	4/6/23/26	0/1/1/1
5	NAG	I	502	1	-	4/6/23/26	0/1/1/1
5	NAG	S	502	1	-	0/6/23/26	0/1/1/1
5	NAG	P	502	1	-	1/6/23/26	0/1/1/1
5	NAG	E	502	1	-	0/6/23/26	0/1/1/1
5	NAG	E	501	1	-	2/6/23/26	0/1/1/1
5	NAG	B	501	1	-	2/6/23/26	0/1/1/1
5	NAG	V	501	1	-	4/6/23/26	0/1/1/1
5	NAG	S	501	1	-	2/6/23/26	0/1/1/1
5	NAG	P	501	1	-	2/6/23/26	0/1/1/1
5	NAG	I	503	1	-	4/6/23/26	0/1/1/1
5	NAG	S	503	1	-	4/6/23/26	0/1/1/1
5	NAG	I	501	1	-	2/6/23/26	0/1/1/1
5	NAG	A	502	1	-	2/6/23/26	0/1/1/1

There are no bond length outliers.

All (2) bond angle outliers are listed below:

Mol	Chain	Res	Type	Atoms	Z	Observed(°)	Ideal(°)
5	B	502	NAG	C1-O5-C5	4.30	118.01	112.19
5	S	502	NAG	C1-C2-N2	2.17	114.20	110.49

There are no chirality outliers.

5 of 47 torsion outliers are listed below:

Mol	Chain	Res	Type	Atoms
5	P	501	NAG	O5-C5-C6-O6
5	S	501	NAG	O5-C5-C6-O6
5	A	503	NAG	C4-C5-C6-O6
5	I	504	NAG	O5-C5-C6-O6
5	B	501	NAG	O5-C5-C6-O6

There are no ring outliers.

16 monomers are involved in 49 short contacts:

Mol	Chain	Res	Type	Clashes	Symm-Clashes
5	M	501	NAG	1	0

Continued on next page...

Continued from previous page...

Mol	Chain	Res	Type	Clashes	Symm-Clashes
5	A	503	NAG	1	0
5	B	502	NAG	7	0
5	A	501	NAG	2	0
5	A	504	NAG	2	0
5	I	504	NAG	3	0
5	S	502	NAG	11	0
5	P	502	NAG	3	0
5	E	502	NAG	1	0
5	E	501	NAG	1	0
5	B	501	NAG	3	0
5	V	501	NAG	3	0
5	S	501	NAG	2	0
5	P	501	NAG	2	0
5	I	501	NAG	6	0
5	A	502	NAG	3	0

5.7 Other polymers [i](#)

There are no such residues in this entry.

5.8 Polymer linkage issues [i](#)

There are no chain breaks in this entry.

6 Fit of model and data [i](#)

6.1 Protein, DNA and RNA chains [i](#)

In the following table, the column labelled '#RSRZ > 2' contains the number (and percentage) of RSRZ outliers, followed by percent RSRZ outliers for the chain as percentile scores relative to all X-ray entries and entries of similar resolution. The OWAB column contains the minimum, median, 95th percentile and maximum values of the occupancy-weighted average B-factor per residue. The column labelled 'Q < 0.9' lists the number of (and percentage) of residues with an average occupancy less than 0.9.

Mol	Chain	Analysed	<RSRZ>	#RSRZ>2	OWAB(Å ²)	Q<0.9
1	A	333/352 (94%)	0.56	32 (9%) 8 5	119, 153, 203, 222	0
1	B	342/352 (97%)	0.61	44 (12%) 3 3	105, 174, 268, 299	0
1	E	329/352 (93%)	0.71	49 (14%) 2 2	141, 205, 256, 283	0
1	I	341/352 (96%)	0.41	30 (8%) 10 6	120, 166, 210, 232	0
1	M	339/352 (96%)	0.60	43 (12%) 3 3	122, 188, 245, 262	0
1	P	338/352 (96%)	0.56	34 (10%) 7 4	104, 170, 241, 263	0
1	S	339/352 (96%)	0.56	29 (8%) 10 7	123, 177, 252, 283	0
1	V	338/352 (96%)	0.59	31 (9%) 9 5	122, 180, 263, 301	0
2	a	24/28 (85%)	0.38	2 (8%) 11 8	141, 188, 204, 208	0
2	b	24/28 (85%)	0.30	1 (4%) 36 23	161, 195, 225, 229	0
2	e	24/28 (85%)	0.16	1 (4%) 36 23	171, 198, 220, 223	0
2	i	24/28 (85%)	0.13	1 (4%) 36 23	140, 189, 200, 204	0
2	m	24/28 (85%)	0.38	2 (8%) 11 8	171, 209, 228, 233	0
2	p	24/28 (85%)	0.36	1 (4%) 36 23	118, 160, 181, 188	0
2	s	24/28 (85%)	0.37	2 (8%) 11 8	149, 202, 226, 231	0
2	v	24/28 (85%)	0.36	4 (16%) 1 1	170, 213, 220, 221	0
3	D	210/210 (100%)	1.35	52 (24%) 0 0	106, 227, 332, 347	0
3	G	210/210 (100%)	1.39	52 (24%) 0 0	172, 252, 328, 358	0
3	K	210/210 (100%)	2.85	85 (40%) 0 0	210, 340, 366, 371	0
3	L	210/210 (100%)	0.61	28 (13%) 3 3	146, 230, 276, 302	0
3	O	210/210 (100%)	1.26	56 (26%) 0 0	193, 256, 292, 314	0
3	R	210/210 (100%)	1.35	54 (25%) 0 0	181, 250, 340, 377	0
3	U	210/210 (100%)	0.75	34 (16%) 1 1	117, 227, 317, 334	0
3	X	210/210 (100%)	1.49	71 (33%) 0 0	185, 248, 303, 317	0

Continued on next page...

Continued from previous page...

Mol	Chain	Analysed	<RSRZ>	#RSRZ>2	OWAB(Å ²)	Q<0.9
4	C	219/220 (99%)	1.08	52 (23%) 0 0	102, 188, 337, 353	0
4	F	219/220 (99%)	1.02	52 (23%) 0 0	189, 240, 283, 314	0
4	H	219/220 (99%)	0.70	45 (20%) 1 0	144, 198, 268, 280	0
4	J	219/220 (99%)	1.89	79 (36%) 0 0	205, 303, 380, 398	0
4	N	219/220 (99%)	1.39	59 (26%) 0 0	189, 240, 282, 300	0
4	Q	219/220 (99%)	0.92	49 (22%) 0 0	179, 241, 285, 310	0
4	T	219/220 (99%)	1.12	47 (21%) 0 0	125, 212, 311, 338	0
4	W	219/220 (99%)	1.19	62 (28%) 0 0	170, 232, 271, 292	0
All	All	6323/6480 (97%)	0.95	1183 (18%) 1 0	102, 208, 323, 398	0

The worst 5 of 1183 RSRZ outliers are listed below:

Mol	Chain	Res	Type	RSRZ
3	K	197	THR	29.6
3	K	136	LEU	28.1
4	J	179	SER	24.5
3	K	144	ALA	24.5
3	K	115	VAL	23.1

6.2 Non-standard residues in protein, DNA, RNA chains [i](#)

In the following table, the Atoms column lists the number of modelled atoms in the group and the number defined in the chemical component dictionary. The B-factors column lists the minimum, median, 95th percentile and maximum values of B factors of atoms in the group. The column labelled 'Q< 0.9' lists the number of atoms with occupancy less than 0.9.

Mol	Type	Chain	Res	Atoms	RSCC	RSR	B-factors(Å ²)	Q<0.9
4	OAS	Q	30	6/10	0.68	0.32	246,262,273,274	0
4	OAS	W	30	9/10	0.69	0.38	201,211,216,219	0
2	U2X	e	23	19/20	0.77	0.40	175,179,184,185	0
2	U2X	p	23	19/20	0.77	0.39	106,113,127,130	0
2	U2X	b	23	19/20	0.79	0.39	131,154,176,177	0
4	OAS	J	30	6/10	0.81	0.12	164,236,245,246	0
4	OAS	N	30	6/10	0.82	0.18	179,233,246,251	0
4	OAS	F	30	6/10	0.82	0.13	248,273,281,281	0
2	U2X	i	23	19/20	0.84	0.42	133,139,150,152	0
2	U2X	s	23	19/20	0.84	0.36	146,152,160,160	0
2	U2X	a	23	19/20	0.84	0.44	130,136,145,145	0

Continued on next page...

Continued from previous page...

Mol	Type	Chain	Res	Atoms	RSCC	RSR	B-factors(Å ²)	Q<0.9
4	OAS	T	30	9/10	0.85	0.23	156,170,195,200	0
4	OAS	H	30	9/10	0.87	0.14	172,176,180,182	0
2	U2X	m	23	19/20	0.91	0.34	155,164,181,184	0
2	U2X	v	23	19/20	0.92	0.34	146,156,181,182	0
4	OAS	C	30	9/10	0.92	0.29	155,165,179,180	0
2	DPR	p	21	7/8	0.93	0.25	123,126,133,136	0
2	DPR	i	21	7/8	0.94	0.27	136,137,141,144	0
2	DPR	b	21	7/8	0.94	0.18	165,166,170,173	0
2	DPR	s	21	7/8	0.94	0.19	151,152,155,158	0
2	DPR	a	21	7/8	0.95	0.16	146,147,150,151	0
2	DPR	v	21	7/8	0.95	0.40	170,171,176,180	0
2	DPR	m	21	7/8	0.97	0.27	173,175,182,187	0
2	DPR	e	21	7/8	0.98	0.34	176,177,180,182	0

6.3 Carbohydrates [i](#)

There are no monosaccharides in this entry.

6.4 Ligands [i](#)

In the following table, the Atoms column lists the number of modelled atoms in the group and the number defined in the chemical component dictionary. The B-factors column lists the minimum, median, 95th percentile and maximum values of B factors of atoms in the group. The column labelled 'Q< 0.9' lists the number of atoms with occupancy less than 0.9.

Mol	Type	Chain	Res	Atoms	RSCC	RSR	B-factors(Å ²)	Q<0.9
5	NAG	I	502	14/15	0.57	0.43	183,189,198,199	0
5	NAG	E	502	14/15	0.74	0.28	190,201,211,212	0
5	NAG	P	502	14/15	0.75	0.26	208,216,230,231	0
5	NAG	B	501	14/15	0.80	0.27	152,161,168,170	0
5	NAG	I	504	14/15	0.81	0.27	176,180,185,186	0
5	NAG	A	504	14/15	0.84	0.14	184,188,192,195	0
5	NAG	E	501	14/15	0.84	0.38	204,207,209,209	0
5	NAG	S	501	14/15	0.84	0.36	154,162,168,171	0
5	NAG	I	503	14/15	0.86	0.21	194,202,208,209	0
5	NAG	M	501	14/15	0.86	0.42	178,180,182,185	0
5	NAG	B	502	14/15	0.86	0.13	219,232,245,249	0
5	NAG	A	501	14/15	0.86	0.36	127,136,143,144	0
5	NAG	S	502	14/15	0.86	0.18	230,238,252,259	0
5	NAG	A	502	14/15	0.88	0.20	184,189,200,200	0
5	NAG	S	503	14/15	0.88	0.29	202,210,214,216	0

Continued on next page...

Continued from previous page...

Mol	Type	Chain	Res	Atoms	RSCC	RSR	B-factors(\AA^2)	Q<0.9
5	NAG	A	503	14/15	0.89	0.35	152,167,177,182	0
5	NAG	I	501	14/15	0.92	0.23	161,165,172,173	0
5	NAG	P	501	14/15	0.92	0.22	153,165,177,177	0
5	NAG	V	501	14/15	0.94	0.38	153,158,163,165	0

6.5 Other polymers [i](#)

There are no such residues in this entry.